



INSTALLATION/OPERATION MANUAL

CRYSTAL
S E R I E S L

CX-47HD
CX-OPAL47
CX-65HD

1080p High-Definition LCD Flat Panel Displays
with Widevision™



THE WORLD'S FINEST HOME THEATER PRODUCTS™

RuncoCare™ Standard Two Year Limited Warranty

Congratulations on your purchase of a Runco® product! With proper installation, setup and care, you should enjoy many years of unparalleled video performance.

This RuncoCare Standard Limited Warranty is provided free of charge by Runco International with the purchase of a covered Runco product. The following sets forth Runco's Standard Limited Warranty applicable to all Runco projectors, processors, LCD and plasma display products, with the exception of the following models: XP-103DHD, SC-1, SC-1a and VW-100HD¹.

The following terms and conditions of the RuncoCare Standard Limited Warranty represent a contract between us, Runco International and you, the customer who has purchased a Runco product. This contract applies to purchases of covered Runco products occurring on or after September 1, 2008. Runco reserves the right to change the terms of this contract, and such changes shall apply to purchases of covered Runco products that occur on or after any future effective date.

RuncoCare Standard Features

- Two-year protection from defects in material and workmanship
- Access to 24x7 phone support
- Complimentary, second-day one-way shipping

Warranty Coverage

Runco warrants its products to be free from defects in material and workmanship during the warranty period provided below. If, in Runco's determination, a product proves to be defective in material or workmanship during the warranty period, Runco will repair the product, replace the product with a similar new or like new product, or refund a prorata share of the purchase price (calculated based on the remainder of the warranty period and the then-current MSRP² of a similar product), if repair or replacement of the product is determined by Runco to not be feasible.

Length of Warranty

Runco products are warranted for two (2) years from the date of shipment from Runco. Lamps are warranted six (6) months from the date of shipment or 1000 hours, whichever comes first. All other accessories, which includes, but is not limited to, cables, remotes, carrying cases, lens cap and other peripherals sold with the Runco product, are warranted for ninety (90) days from the date of shipment. Repaired product or replacement lamp is subsequently warranted for the remaining portion (if any) of the original warranty term or 90 days from the date the product was shipped to you, whichever is longer.

Eligibility

This RuncoCare Standard Limited Warranty is valid only for the first customer who purchases the covered product from an authorized Runco dealer or distributor. This warranty is not transferable. You may be required to provide proof of purchase in order to receive warranty services.

-
1. Runco may update this list of products excluded from this warranty from time to time at Runco's sole discretion, but updates to the list of covered products will not apply on a retroactive basis.
 2. MSRP is defined as the most recent product price listed on Runco's price list.

RuncoCare Claim Procedure

In the event of a product defect, please follow the warranty claim procedure provided below:

1. The Customer is required to contact a Runco dealer or Runco Technical Support via email at support@runco.com or via phone at (toll free) 800-23RUNCO (800-237-8626). If the customer is located outside North America, call +3589 4200 554 in Europe for product service.
2. Be prepared to provide the date of purchase, the place of purchase, serial number, product model number, description of the problem and troubleshooting steps already attempted.
3. Runco Technical Support staff will attempt to correct any minor issues that may be causing the problem. If Runco is unable to fix the problem to the customer's satisfaction, Runco will issue a Return Material Authorization (RMA) if it is determined that the claim was made within the coverage period of the Standard Limited Warranty.
4. The customer will need to return the defective product to the Runco repair depot location specified by the Runco technical support representative. The customer will need to properly package the defective product, consisting of the product only, and not include any accessories (e.g., cables, remotes, carrying cases, lens, lens cap and other peripherals) and return it to the Runco repair depot specified by the technical support representative. It is the customer's responsibility to properly package the hardware, include all appropriate materials, and return it to the location specified by the Runco technical support department. The customer will need to address and resolve any shipping damage claims directly with the shipping company.
5. The customer is responsible for providing a suitable box to ship the defective product to an authorized Runco repair depot. Boxes may be purchased from a Runco technical support representative.
6. The customer is responsible for paying freight charges to ship the defective product to an authorized Runco repair depot.
7. Runco will pay freight charges to return the repaired/replacement product to the customer from the Runco repair depot.
8. Once an RMA has been created, the customer may contact serviceorders@runco.com for followup questions or confirmation status of the claim process.

Warranty Exclusions

This RuncoCare Standard Limited Warranty does not include or is limited by the following:

1. Products not purchased from an authorized Runco dealer
2. Rental costs incurred by the customer in the event of product defect or failure
3. Any product with a defaced, modified, or removed serial number
4. Damage, deterioration, or malfunction resulting from:
 - a Accident, abuse, misuse, neglect, improper ventilation, fire, water, disaster, lightning, or other acts of nature, smoke exposure (cigarette or otherwise), unauthorized product modification (including use of an unauthorized mount), or failure to follow instructions supplied with the product
 - b Repair or attempted repair by anyone not authorized by Runco
 - c Any damage to the product due to shipment
 - d Removal or installation of the product
 - e Causes external to the product, such as electric power fluctuations or failure
 - f Use of supplies or parts not meeting Runco's specifications
 - g Normal wear and tear
 - h Expected lamp degradation and normal decrease in lamp output over a period of time or as the lamp is consumed
 - i Customer caused defects, including but not limited to, scratched/defaced/altered plastics

-
- j Failure to follow maintenance procedures as outlined in the product's user guide where a schedule is specified for regular cleaning of the product
 - k Opening the product and/or tampering with internal circuitry
 - l Products lost, stolen or discarded
 - m Any damage or dissatisfaction associated with latent images, "burnin," or any other damage determined by Runco to be the result of customer use patterns
 - n Any other cause, which does not relate to a product defect in material or workmanship
5. Removal, installation, and setup service charges are excluded from this Standard Limited warranty
 6. Runco's warranty does not cover black uniformity issues or other LCD issues associated with usage outside the Runco recommended guidelines and specifications for the product
 7. Second day shipment delivery time and availability may vary based on origin and destination and Runco is unable to deliver to PO Box and FPO Box addresses

Extended Service Options

Runco offers extended and expanded service plans. For information on additional product protection, please email serviceorders@runco.com or call (toll free) 800-23RUNCO (800-237-8626).

Online Product Registration

Please visit <http://www.runco.com/info.html> to register product.

Limitation of Implied Warranties

RUNCO PROVIDES NO WARRANTIES, EXPRESS OR IMPLIED, EXCEPT THOSE EXPRESSLY PROVIDED HEREIN. RUNCO EXPRESSLY DISCLAIMS ALL OTHER WARRANTIES, INCLUDING THE IMPLIED WARRANTIES OF MERCHANTABILITY AND FITNESS FOR A PARTICULAR PURPOSE.

Exclusion of Damages

RUNCO'S MAXIMUM AGGREGATE LIABILITY HEREUNDER IS LIMITED TO THE COST OF REPAIR OR REPLACEMENT OF THE PRODUCT.

1. RUNCO SHALL NOT BE LIABLE FOR DAMAGE TO OTHER PROPERTY CAUSED BY ANY DEFECT IN THE PRODUCT, DAMAGES BASED UPON INCONVENIENCE, LOSS OF USE OF THE PRODUCT, LOSS OF TIME, LOSS OF PROFITS, LOSS OF BUSINESS OPPORTUNITY, LOSS OF GOODWILL, INTERFERENCE WITH BUSINESS RELATIONSHIPS, OR OTHER COMMERCIAL LOSS, EVEN IF THE CUSTOMER HAS BEEN ADVISED OF THE POSSIBILITY OF SUCH DAMAGES.
2. RUNCO SHALL NOT BE LIABLE FOR ANY CONSEQUENTIAL, INCIDENTAL, INDIRECT, SPECIAL, OR PUNITIVE DAMAGES ANY OTHER DAMAGES, WHETHER INCIDENTAL, INDIRECT, CONSEQUENTIAL OR OTHERWISE.
3. RUNCO SHALL NOT BE LIABLE FOR ANY CLAIM AGAINST THE CUSTOMER BY ANY OTHER PARTY.

Effect of Local Law

This warranty gives you specific legal rights, and you may have other rights, which vary from locality to locality. Some localities do not allow limitations on implied warranties and/or do not allow the exclusion of incidental or consequential damages, so the above limitations and exclusions may not apply to you.

COPYRIGHT AND TRADEMARKS:

© Copyright 2008 Runco International, LLC ("Runco"). This document contains proprietary information protected by copyright, trademark and other intellectual property laws. All rights are reserved. No part of this manual may be reproduced by any mechanical, electronic or other means, in any form, without prior written permission of Runco.

The trademarks reproduced in this Runco Owner's Manual and used on the Runco Products are either owned by Runco or are licensed by Runco. You may not reproduce or use the trademarks without the prior written consent of Runco.

Runco Products are manufactured under one or more of the following patents: US. Patent 6755540 and Other Patents Pending.

Important Safety Instructions

Thank you for your purchase of this quality Runco product! For best performance, please read this manual carefully as it is your guide through the menus and operation.

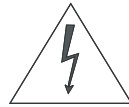
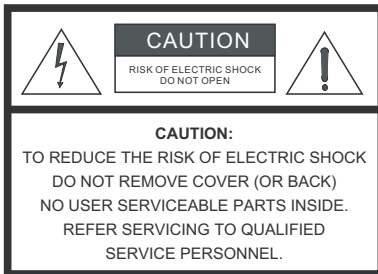

WARNING

This symbol is intended to alert the user to the presence of uninsulated “dangerous voltage” within the product’s enclosure that may be of sufficient magnitude to constitute a risk of electric shock.



This symbol is intended to alert the user to the presence of important operating and maintenance (servicing) instructions in the literature accompanying the appliance.

1. Read these instructions.
2. Keep these instructions.
3. Heed all warnings.
4. Follow all instructions.
5. Do not use this apparatus near water.
6. Clean only with a dry cloth.
7. Do not block any of the ventilation openings. Install in accordance with the manufacturer’s instructions.
8. Do not install near any heat sources such as radiators, heat registers, stoves, or other apparatus (including amplifiers) that produce heat.
9. Do not defeat the safety purpose of the polarized or grounding type plug. A polarized plug has two blades with one wider than the other. A grounding type plug has two blades and a third grounding prong. The wide blade or the third prong is provided for your safety. When the provided plug does not fit into your outlet, consult an electrician for the replacement of the obsolete outlet.
10. Protect the power cord from being walked on or pinched particularly at plugs, convenience receptacles and the point where they exit from the apparatus.
11. Only use the attachments/accessories specified by Runco.
12. Use only with a cart, stand, tripod, bracket or table specified by the manufacturer or sold with the apparatus. When a cart is used, use caution when moving the cart/apparatus to avoid injury from tip-over.
13. Unplug this apparatus during lightning storms or when unused for long periods of time.
14. Refer all servicing to qualified service personnel. Servicing is required when the apparatus has been damaged in any way, such as power supply cord or plug is damaged, liquid has been spilled or objects have fallen into the apparatus, the apparatus has been exposed to rain or moisture, does not operate normally, or has been dropped.



Compliance Information

DECLARATION OF CONFORMITY:

Manufacturer's Name: Runco International, LLC

Manufacturer's Address: 1195 NW Compton Drive, Beaverton, OR 97006-1992

hereby declares that the products Model Numbers:

CX-47HD, CX-OPAL47 and CX-65HD

conform with the provisions of:

Council Directive 2004/108/EC on Electromagnetic Compatibility;

EN 55022 "Limits and methods of measurements of radio interference characteristics of information technology equipment" 1998;

EN 55024 "Limits and methods of measurements of immunity characteristics of information technology equipment" 1998;

Including:

- EN 61000-4-2 "Electromagnetic compatibility (EMC) Part 4: Testing and measurement techniques Section 2: Electrostatic discharge immunity test"
- EN 61000-4-3 "Electromagnetic compatibility (EMC) Part 4: Testing and measurement techniques Section 3: Radiated, Radio-Frequency, Electromagnetic Field Immunity Test"
- EN 61000-4-4 "Electromagnetic compatibility (EMC) Part 4: Testing and measurement techniques Section 4: Electrical fast transient/burst immunity test"
- EN 61000-4-5 "Electromagnetic compatibility (EMC) Part 4: Testing and measurement techniques Section 5: Surge immunity test"
- EN 61000-4-6 "Electromagnetic compatibility (EMC) Part 4: Testing and measurement techniques Section 6: Conducted disturbances induced by radio-frequency fields immunity test"
- EN 61000-4-8 "Electromagnetic compatibility (EMC) Part 4: Testing and measurement techniques Section 8: Conducted disturbances induced by power frequency magnetic fields immunity test"
- EN 61000-4-11 "Electromagnetic compatibility (EMC) Part 4: Testing and measurement techniques Section 11: Voltage dips, short interruptions and voltage variations immunity tests"

And:

- EN 61000-3-2 "Electromagnetic compatibility (EMC) Part 3, Section 2: Limits for harmonic current emissions (equipment input current up to and including 16 A per phase)" 2000;
- EN 61000-3-3 "Electromagnetic compatibility (EMC) Part 3, Section 3: Limitations of voltage changes, voltage fluctuations and flicker in public low-voltage supply systems, for equipment with rated current up to and including 16 A and not subject to conditional connection" 1995;

Council Directive 2006/95/EC and amended by M1 and C1 on Low Voltage Equipment Safety;

EN 60950 "Safety of information technology equipment, including electrical business equipment"

The Technical Construction file required by this Directive is maintained at the corporate headquarters of Planar Systems, Inc., 1195 NW Compton Drive, Beaverton, OR 97006.

Date of Declaration: January 2009

FCC PART 15:

NOTE: This equipment has been tested and found to comply with the limits for a Class B digital device, pursuant to Part 15 of the FCC Rules. These limits are designed to provide reasonable protection against harmful interference in a residential installation.

This equipment generates, uses and can radiate radio frequency energy and, if not installed and used in accordance with the instructions, may cause harmful interference to radio communications. However, there is no guarantee that interference will not occur in a particular installation. If this equipment does cause harmful interference to radio or television reception, which can be determined by turning the equipment off and on, the user is encouraged to try to correct the interference by one or more of the following measures:

- Reorient or relocate the receiving antenna.
- Increase the separation between the equipment and receiver.
- Connect the equipment into an outlet on a circuit different from that to which the receiver is connected.
- Consult the dealer or an experienced radio/TV technician for help.

INDUSTRY CANADA (ICES-003):

This Class B digital apparatus complies with Canadian ICES-003.

Cet appareil numérique de la classe B est conforme à la norme NMB-003 du Canada.

IMPORTANT RECYCLE INSTRUCTIONS



Lamp(s) inside this product contain mercury. This product may contain other electronic waste that can be hazardous if not disposed of properly. Recycle or dispose in accordance with local, state, or federal Laws.

For more information, contact the Electronic Industries Alliance at WWW.EIAE.ORG.

For lamp specific disposal information check WWW.LAMPRECYCLE.ORG.

DISPOSAL OF OLD ELECTRICAL AND ELECTRONIC EQUIPMENT (Applicable throughout the European Union and other European countries with separate collection programs)



This symbol found on your product or on its packaging, indicates that this product should not be treated as household waste when you wish to dispose of it. Instead, it should be handed over to an applicable collection point for the recycling of electrical and electronic equipment. By ensuring this product is disposed of correctly, you will help prevent potential negative consequences to the environment and human health, which could otherwise be caused by inappropriate disposal of this product. The recycling of materials will help to conserve natural resources. This symbol is only valid in the European Union. If you wish to discard this product, please contact your local authorities or dealer and ask for the correct method of disposal.

Notes:

Table of Contents

RuncoCare™ Standard Two Year Limited Warranty	iii
Important Safety Instructions	vii
Compliance Information	viii
1. Introduction	1
About This Manual	1
Target Audience	1
If You Have Comments About This Manual.....	1
Textual and Graphic Conventions	1
Using This Manual	2
Description, Features and Benefits	3
Key Features and Benefits	3
Parts List	3
2. Controls and Functions	5
Crystal Series LCD at a Glance	5
Controls and Indicators.....	5
Crystal Series LCD Inputs and Outputs.....	7
Crystal Series LCD Remote Control	10
3. Installation	13
Remote Control	13
Battery Installation	13
Notes on Remote Control Operation.....	13
Quick Setup	14
Installation Considerations	15
Wall-Mounting the Crystal Series LCD	15
Ambient Light	15
Other Considerations	15
Connections to the Crystal Series LCD	15
Connecting the Crystal Series LCD to Source Components.....	16
Connecting External Speakers (Optional)	19
Connecting to a Dolby Digital Amplifier.....	20
Connecting an External IR Receiver	21
RS-232 Controller Connection	21

4. Operation	23
Turning on the Power	23
Changing the OSD Language	23
Setting the PC Display Properties	24
Using the On-Screen Menus	25
Main Menu	27
Source	27
Aspect Ratio	27
Picture Adjust	29
Audio	34
Timer	34
Setup.....	35
ISF Calibration	38
Using Picture-In-Picture (PIP)	41
Changing the PIP Position	42
Changing the PIP Size	43
Swapping the Main and PIP Images	43
5. Maintenance and Troubleshooting	45
Cleaning	45
Cleaning the Display Panel Body and Remote Control	45
Cleaning the Screen.....	45
Cleaning the Vents.....	45
Troubleshooting Tips	45
6. Serial Communications	47
RS-232 Connection and Port Configuration	47
Serial Command Syntax	47
Personalizing the Splash Screen Using Serial Commands.....	51
7. Specifications	53
Crystal Series LCD Specifications	53
Crystal Series LCD Dimensions	55
Supported Timings	59

List of Figures

2-1. Crystal Series LCD Controls and Indicators	5
2-2. Model CX-47HD and CX-OPAL47 Inputs and Outputs	7
2-3. Model CX-65HD Inputs and Outputs	8
2-4. Crystal Series LCD Remote Control.....	10
3-1. HDMI Connections	16
3-2. Analog RGB Connections.....	17
3-3. Component Video Connections.....	18
3-4. Composite and S-Video Connections.....	18
3-5. SCART RGB Connections	19
3-6. External Speaker Connection	19
3-7. Digital Audio Connection	20
3-8. External IR Receiver Connection.....	21
3-9. RS-232 Control System Connection.....	21
4-1. Crystal Series LCD OSD Menu Structure.....	26
4-2. Typical PLUGE Pattern for Adjusting Brightness	30
4-3. Typical Gray Bar Pattern for Adjusting Contrast	30
4-4. Typical Color Bar Pattern for Adjusting Color Saturation and Tint.....	31
4-5. Typical Test Pattern for Adjusting Sharpness	32
4-6. Crystal Series LCD Splash Screen.....	40
7-1. CX-47HD/CX-OPAL47 Dimensions (Top/Front)	55
7-2. CX-47HD/CX-OPAL47 Dimensions (Rear/Side)	56
7-3. CX-65HD Overall Dimensions (Top/Front).....	57
7-4. CX-65HD Overall Dimensions (Rear/Side).....	58

Notes:

1. Introduction

This Owner's Manual describes how to install, set up and operate the Runco Crystal Series Model CX-47HD, CX-OPAL47 and CX-65HD Flat-Panel LCDs. Throughout this manual, the Runco CX-47HD, CX-OPAL47 and CX-65HD Flat-Panel LCDs are referred to collectively as the "Crystal Series LCD." The information in this manual applies to all three products, except where otherwise indicated.

Runco has prepared this manual to help home theater installers and end users get the most out of the Crystal Series LCD.

Runco has made every effort to ensure that this manual is accurate as of the date it was printed. However, because of ongoing product improvements and customer feedback, it may require updating from time to time. You can always find the latest version of this and other Runco product manuals on-line, at www.Runco.com.

Runco welcomes your comments about this manual. Send them to techpub@runco.com.

Text Conventions: The following conventions are used in this manual, in order to clarify the information and instructions provided:

- Remote control button identifiers are set in upper-case bold type; for example, "Press **EXIT** to return to the previous menu."
- Computer input (commands you type) and output (responses that appear on-screen) is shown in monospace (fixed-width) type; for example: "To change the aspect ratio to Letterbox, type [S4E0002.]"
- All keys with functional names are initial-capped, set in bold type and enclosed in angle brackets. These keys are the following: **<Enter>**, **<Spacebar>**, **<Control>**, **<Esc>** and **<Tab>**.
- **<Enter>** indicates that you may press either the RETURN or ENTER key on your computer keyboard if it has both keys.

In addition to these conventions, underlining, boldface and/or italics are occasionally used to highlight important information, as in this example:



*A carriage return **must** be used after each command or string.*

1.1 About This Manual

◀ Target Audience

◀ If You Have Comments About This Manual...

◀ Textual and Graphic Conventions

Graphic Conventions: These symbols appear in numerous places throughout the manual, to emphasize points that you must keep in mind to avoid problems with your equipment or injury:



Tip

TIPS highlight time-saving short cuts and helpful guidelines for using certain features.



Note

NOTES emphasize text with unusual importance or special significance. They also provide supplemental information.



Caution

CAUTIONS alert users that a given action or omitted action can degrade performance or cause a malfunction.



WARNING

WARNINGS appear when a given action or omitted action can result in damage to the equipment, or possible non-fatal injury to the user.



DANGER!

DANGER appears when a given action can cause severe injury or death.

1.2 Using This Manual

Use the following table to locate the specific information you need in this manual.

If you need...	... Turn to page:
Information about obtaining service	iv
General information about the CX-47HD, CX-OPAL47 and CX-65HD Flat-Panel LCDs	3
Installation instructions	13
First-time configuration instructions	23
Advanced configuration instructions	38
Troubleshooting tips	45
Specifications for the CX-47HD, CX-OPAL47 and CX-65HD Flat-Panel LCDs	53

Runco presents the Crystal Series CX-47HD, CX-OPAL47 and CX-65HD Flat-Panel LCDs, perfect for those who demand our award-winning flat-panel performance along with advanced LCD technology and lightweight design.

The Crystal Series LCD incorporates the superb Vivix™ digital video processing that produces outstanding picture quality with a wide range of both standard and high definition source material. In addition, the handsome, anodized black-finish television is engineered with ISF™ calibration standards for the purest video performance.

The Crystal Series LCD offers Picture-In-Picture (PIP), Picture-By-Picture (PBP) and multi-language support. The display includes an integrated stereo audio system with generous power amplification.

The advanced, TFT active-matrix liquid crystal display panel offers 1920 x 1080 resolution and includes Runco's discrete aspect ratio control with VirtualWide™ mode to fill the 16:9 screen with standard 4:3 images without loss of picture quality. Also included are discrete source, aspect ratio and power selection and an RS-232 interface for whole-house or automated control system integration.

The Crystal Series LCD is multimedia ready, with simple computer connections making gaming, Internet browsing and other computing activities quick and easy.

The Crystal Series LCD offers these key features and benefits:

- Native Resolution: 1920 x 1080 (16:9 Native Aspect Ratio)
- Real-Time Refresh (RTR) technology supports 120-Hz frame rates
- Model CX-OPAL47 features Runco-exclusive Optical Path Alignment (OPAL) technology, which delivers extreme glare reduction and enhanced contrast for high ambient light environments
- Multiple aspect ratios with VirtualWide™ Mode
- Less than 6-3/4 inches deep
- Four (4) HDMI 1.3a Inputs with High-bandwidth Digital Content Protection (HDCP)
- Exceptional detail and artifact-free video enhancement
- Runco video processing with 3:2 film detection circuitry

Your Crystal Series LCD is shipped with the following items. If any items are missing or damaged, please contact your Runco dealer or Runco Customer Service at (800) 23-RUNCO.

- Crystal Series LCD Panel with Table Stand: Model CX-47HD (part number 997-5581-00), CX-OPAL47 (part number 997-5599-00) or CX-65HD (part number 997-5582-00)
- Remote Control Unit and two (2), AAA-size batteries
- AC Power Cord
- CX-47HD/CX-OPAL47/CX-65HD Installation/Operation Manual (this document)

Optional Accessories:

- Wall Mount Kit – part number 956-0093-00 (CX-47HD/CX-OPAL47) or 956-0285-00 (CX-65HD)

1.3 Description, Features and Benefits

◀ Key Features and Benefits

◀ Parts List

Notes:

2. Controls and Functions

2.1 Crystal Series LCD at a Glance

◀ Controls and Indicators

Figure 2-1 shows the locations of the Crystal Series LCD controls and indicators.

CX-47HD / CX-OPAL47



CX-65HD

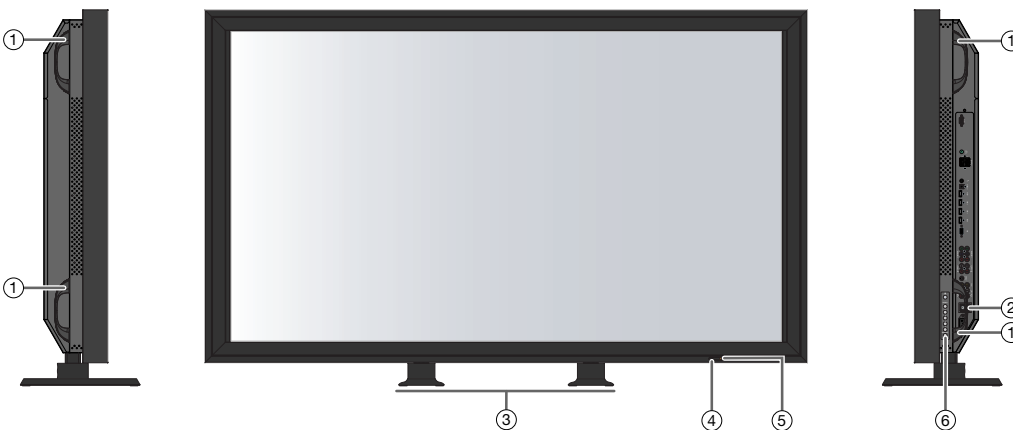

Figure 2-1. Crystal Series LCD Controls and Indicators

1. **HANDLES**

Always use the handles when carrying the display. DO NOT touch or hold the screen face.

2. **MAIN POWER SWITCH**

Connects or disconnects the display panel from the AC power source.

3. **DISPLAY STAND**

Included with the Crystal Series LCD for table-top installations.

4. **FRONT REMOTE CONTROL SENSOR**

REAR REMOTE CONTROL SENSOR (not shown)

The Crystal Series LCD is equipped with two infrared (IR) sensors that receive signals from the remote control unit. The rear sensor is directly opposite the front sensor, on the back of the unit. It allows an IR “bug” to be attached to the rear of the panel (eliminating the need to wrap the wire around the frame) for a cleaner look.

5. **STATUS LED**

Lights orange to indicate that the Crystal Series LCD is in standby mode; Off during normal operation or if the main power switch is set to off.

6. **KEYPAD**

You can use the keypad instead of the remote control unit to operate the on-screen display (OSD) controls. The keypad operates as follows:

On/Standby ()

Press once to toggle from standby mode to on mode. Press it again to return to standby mode. For a discrete on or off command, you can use the direct access buttons on the remote control unit (refer to **Crystal Series LCD Remote Control** on page 10).

SOURCE

To select a source, press the **SOURCE** button repeatedly (with no menus visible on-screen).

▶ (Volume +)

Use this button to increase the sound volume. When a menu is visible on-screen, this button operates identically to the right-arrow (or **ENTER**) button on the Crystal Series LCD remote control unit.

◀ (Volume -)

Use this button to decrease the sound volume. When a menu is visible on-screen, this button operates identically to the left-arrow button on the Crystal Series LCD remote control unit.

▲ / ▼

When a menu is visible on-screen, these buttons operate identically to the up- and down-arrow buttons on the Crystal Series LCD remote control unit.

MENU/EXIT

Press this button to access the on-screen display (OSD) controls, or to exit the current menu and return to the previous one.

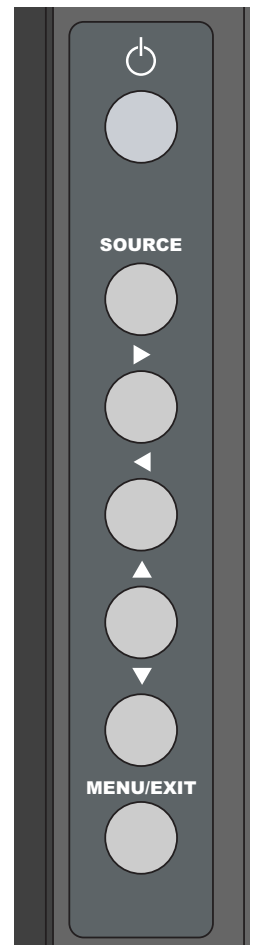

Figure 2-2 and Figure 2-2 show the locations of the Crystal Series LCD inputs and outputs.

◀ **Crystal Series LCD Inputs and Outputs**

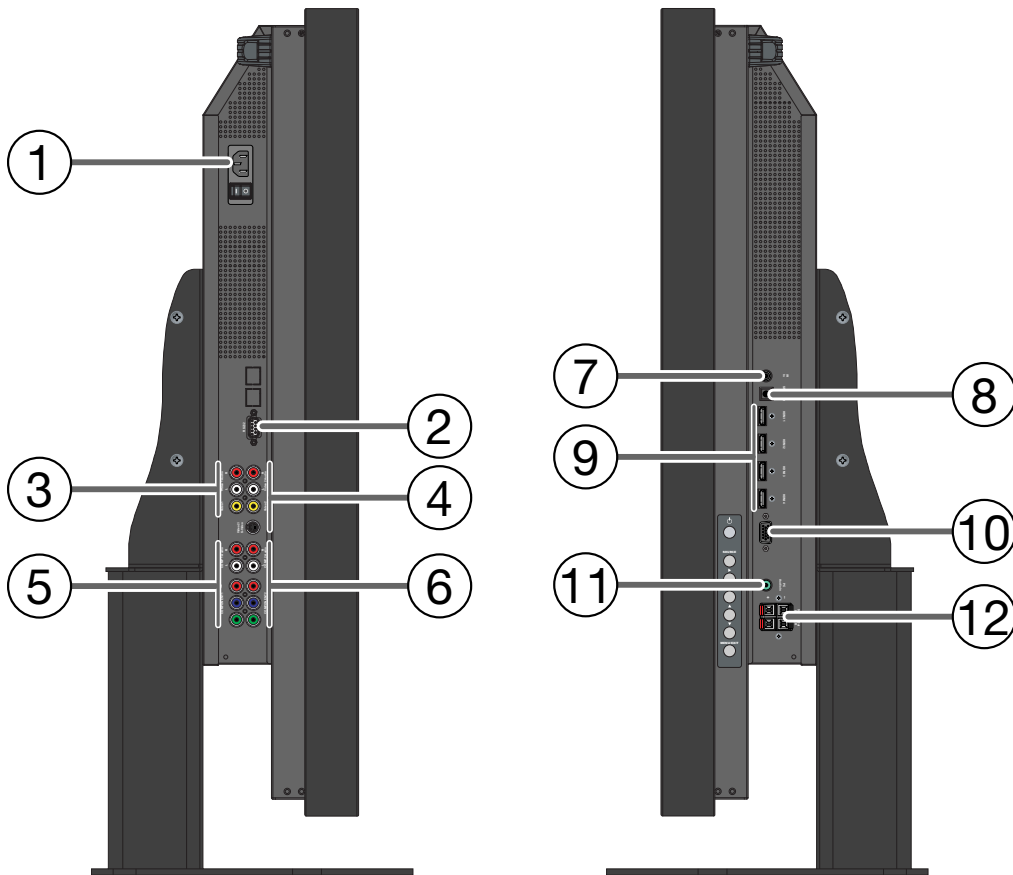

Figure 2-2. Model CX-47HD and CX-OPAL47 Inputs and Outputs

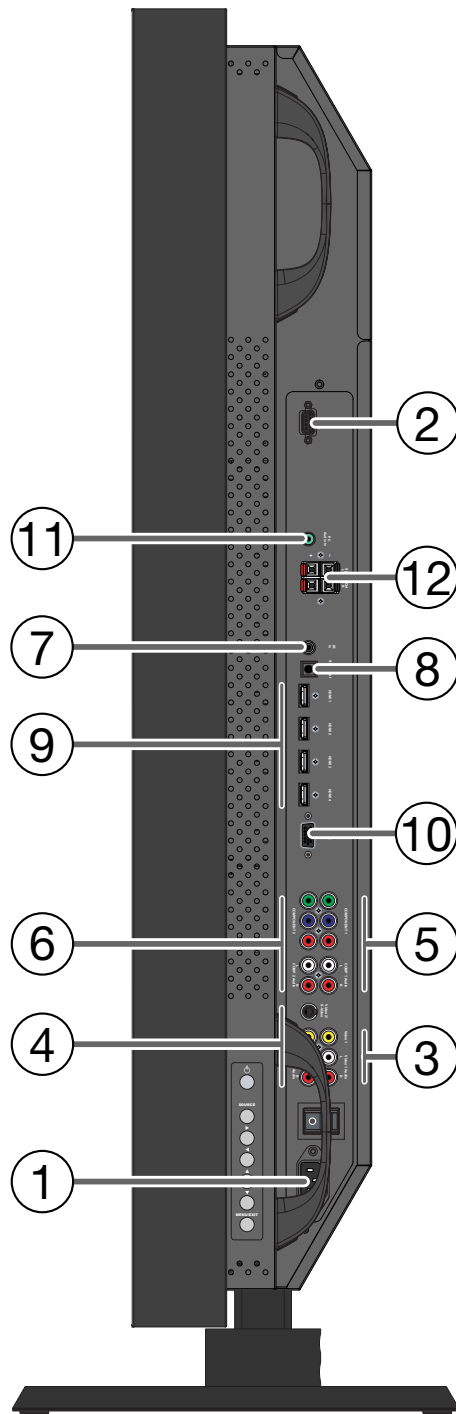

Figure 2-3. Model CX-65HD Inputs and Outputs

1. AC Power Input (100 to 240 VAC)

Connect the Crystal Series LCD to power here.

2. RS-232 CONTROL PORT

A female, 9-pin D-sub connector for interfacing with a PC or home theater automation/control system.

3. VIDEO 1/SCART Sync Input (Composite Video + Stereo Audio)

Standard, composite video input and stereo audio input for connecting a VCR, camcorder, laser disc player or other composite video source. The Composite video input also provides composite sync input for SCART RGBS sources.

4. VIDEO 2 Input (Composite or S-Video + Stereo Audio)

Standard, composite or S-video input and stereo audio input for connecting a VCR, camcorder, laser disc player, Super VHS (S-VHS) VCR or other composite or S-video source.

**Note**

If both the Composite and S-Video inputs on Video 2 are connected to sources, the S-Video input takes precedence.

5. COMPONENT 1/SCART RGB (Component or SCART RGB Video + Stereo Audio)

Standard- or high-definition (up to 1080p), YPrPb component video and stereo audio input. Also provides RGB input for RGBS sources.

6. COMPONENT 2 (Component Video + Stereo Audio)

Standard- or high-definition (up to 1080p), YPrPb component video and stereo audio input.

7. IR IN

Wired input from a Niles- or Xantech-compatible, infrared (IR) repeater system.

8. DIGITAL AUDIO OUT (S/PDIF Optical)

Connect this output to the digital audio input of an A/V amplifier with a Dolby Digital® decoder.

9. HDMI1 / HDMI2 / HDMI 3 / HDMI 4

Four, HDCP-compliant digital video inputs for connecting a DVD player, personal computer or HD tuner with a DVI or HDMI output.

10. RGB

A 15-pin VGA connection to a personal computer. The Crystal Series LCD automatically detects the signal resolution.

11. PC Audio Input

Connect the audio output from a personal computer here.

12. SPEAKER OUTPUT (LEFT + RIGHT)

For connecting external speakers with an impedance of 4 ohms.

2.2 Crystal Series LCD Remote Control

Figure 2-4 shows the Crystal Series LCD remote control, and the paragraphs that follow describe its functionality.

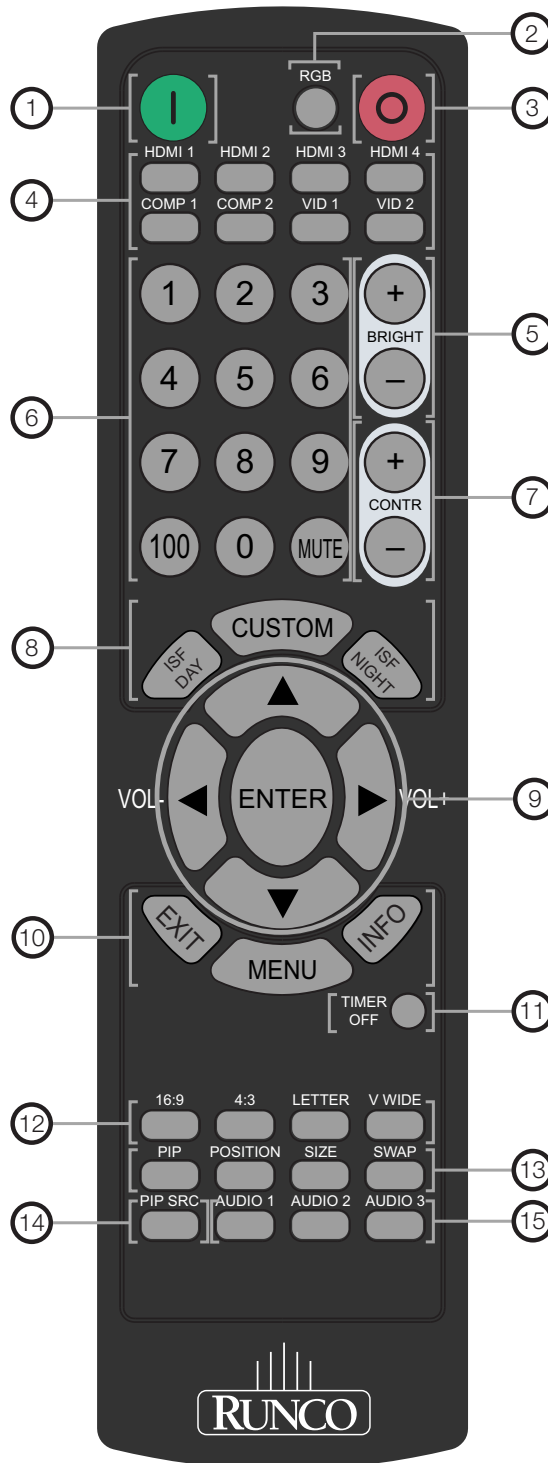

Figure 2-4. Crystal Series LCD Remote Control

-
1. **ON**
Use this button to turn the Crystal Series LCD on.
 2. **RGB HD**
Press this button to switch to the RGB HD input.
 3. **STANDBY**
Use this button to put the Crystal Series LCD into standby mode.
 4. **Source Selection Buttons**

HDMI 1 / HDMI 2 / HDMI 3 / HDMI 4
Use these buttons to select a Digital Video input (HDMI 1, HDMI 2, HDMI 3 or HDMI 4).

COMP 1 / COMP 2
Press this button to select a Component Video input.

VIDEO 1 (Composite) / VIDEO 2 (Composite or S-Video)
Press this button to select a Composite or S-Video input.
 5. **BRIGHT + / BRIGHT -**
Use these buttons to adjust the brightness.
 6. **Numeric Buttons / MUTE Button**
Use the numeric buttons to enter menu pass codes. Press the **MUTE** button to mute the audio output to the speakers.
 7. **CONTR + / CONTR -**
Use these buttons to adjust the contrast.
 8. **Memory Preset Buttons**

ISF DAY
Press to recall settings for the current input from the "ISF Day" memory preset.

CUSTOM
Press to recall settings for the current input from the "Custom" memory preset.

ISF NIGHT
Press to recall settings for the current input from the "ISF Night" memory preset.
 9. **Arrow Buttons (▲, ◀, ▼, ▶)**
Use these buttons to select items or settings, adjust settings or adjust sound volume.

ENTER
Press to select a highlighted menu item or confirm a changed setting.

10. **EXIT**

Press this button to hide the OSD controls.

MENU

Press this button to access the on-screen display (OSD) controls, or to exit the current menu and return to the previous one.

INFO

Press this button to view input signal information (source and resolution), audio format (mono or stereo) and current time.

11. **TIMER OFF Button**

Press this button to set the sleep timer.

12. **Aspect Ratio Selection Buttons**

16:9

For 16:9 DVDs or HDTV program material.

4:3

The input signal is scaled to fit 4:3 display mode in the center of the screen.

LETTER (Letterbox/Cinema Fill)

Image in letterbox format is enlarged to fit 16:9, full-screen display and the upper/lower portions are “blanked off.”

V WIDE (VirtualWide)

4:3 image is enlarged NON-linearly in horizontal direction to fit 16:9 full screen display.

13. **Picture-In-Picture (PIP) Function Buttons**

PIP

Press to change the PIP mode (picture-in-picture, picture-by-picture or off).

POSITION

Press to choose the PIP window position (top left, top right, bottom left or bottom right corner).

SIZE

Press to choose from three PIP window sizes.

SWAP

Press to swap the main and PIP windows.

14. **PIP SRC**

Press to switch to a different PIP video source.

15. **AUDIO 1 / AUDIO 2 / AUDIO 3**

Use these buttons to select an audio “mode” (volume and equalizer preset). For more information about audio modes, refer to **Equalizer** on page 34.

3. Installation

3.1 Remote Control

◀ Battery Installation

To install batteries in the remote control:

1. Slide the battery cover in the direction of the arrow and remove it.
2. Insert the included batteries. Ensure that the polarities correctly match the ⊕ and ⊖ markings inside the battery compartment.
3. Slide the battery cover back on until it snaps into place.



Note

1. Do not mix an old battery with a new one or different types of batteries.

2. If you will not use the remote control for a long time, remove the batteries to avoid damage from battery leakage.

- Do not drop the remote control or expose it to moisture or high temperature.
- The remote control may malfunction under a fluorescent lamp. If that occurs, move the LCD display away from the fluorescent lamp.
- Make sure that there is nothing obstructing the infrared beam between the remote control and the IR receiver on the LCD display.

◀ Notes on Remote Control Operation



Note

The signal from the remote control can be reflected by walls or other surfaces.

- If the effective range of the remote control decreases, or it stops working, replace the batteries with new ones.
- Ambient conditions may possibly impede the operation of the remote control. If this happens, point the remote control at the LCD display and repeat the operation.

3.2 Quick Setup

Table 3-1 gives a quick overview of the Crystal Series LCD installation process. The sections following this one provide detailed instructions.



Note

Installation should be performed by a qualified custom video installation specialist.

Table 3-1. Installation Overview

Step	Procedure	For Details, refer to page...
1	Mount the Crystal Series LCD on a wall (optional)	15
2	Connect signal sources to the Crystal Series LCD	15
3	Connect external controller to RS-232 port (optional)	21
4	Apply power to the Crystal Series LCD	23
5	Change the OSD language	23
6	If using the Crystal Series LCD with a PC, adjust PC display properties	24
7	Display calibration: adjust the following for each input ; save settings when finished: <ul style="list-style-type: none"> • Brightness • Contrast • Color level • Tint • Input position 	27 through 36

Proper installation of your Crystal Series LCD will ensure the highest possible picture quality. Whether you are installing the Crystal Series LCD temporarily or permanently, you should take the following into account to ensure that it performs optimally.

You can either place the Crystal Series LCD on a table or in an entertainment center, or mount it on a wall.

If you do decide to wall-mount the Crystal Series LCD, ensure that the wall-mount bracket is installed according to the instructions included with it. The wall must be capable of supporting a redundant weight factor three (3) times the weight of the display, or be reinforced.

Runco recommends that this be done by a custom installation specialist.



Note

Use only the Runco-approved wall-mount kit designed for your display.

In general, minimize or eliminate light sources directed at the display. Contrast ratio in your images will be noticeably reduced if light directly strikes the display, such as when a shaft of light from a window or floodlight falls on the image. Images may then appear washed out and less vibrant.

Other considerations and tips that can help improve your installation:

- Keep the ambient temperature constant and below 35°C (95°F). Keep the display away from heating and/or air conditioning vents. Changes in temperature may cause drifts in the display circuitry, which may affect performance.
- Keep the Crystal Series LCD away from devices that radiate electromagnetic energy such as motors and transformers. Common sources of these include slide projectors, speakers, power amplifiers and elevators.

Proceed as follows to connect the Crystal Series LCD to your video sources, external controller(s) – if present – and AC power.

When connecting your equipment:

- Turn off all equipment before making any connections.
- Use the correct signal cables for each source.
- Ensure that the cables are securely connected. Tighten the thumbscrews on connectors that have them.
- Use the left audio input when connecting mono audio sources.

3.3 Installation Considerations

◀ **Wall-Mounting the Crystal Series LCD**

◀ **Ambient Light**

◀ **Other Considerations**

3.4 Connections to the Crystal Series LCD

Connecting the Crystal Series LCD to Source Components

Connect your video sources to the Crystal Series LCD as shown and described in the sections that follow.

HDMI Connections: The Crystal Series LCD has four HDMI inputs for connecting a BD/HD-DVD/DVD player, DTV decoder, personal computer or any other device with an HDMI or DVI output. Connect such devices as shown in Figure 3-1.



Tip

Use the HDMI inputs whenever possible. This ensures the highest video quality because the signal is carried in the digital domain throughout the entire signal path, from source component output into the display.



Note

This Crystal Series LCD supports the VESA Display Data Channel (DDC) standard. This standard provides “Plug and Play” capability; the display and a VESA DDC-compatible computer communicate their setting requirements, allowing for quick and easy setup.

In order for Plug and Play to work correctly, you must turn on the display before you turn on the connected computer.

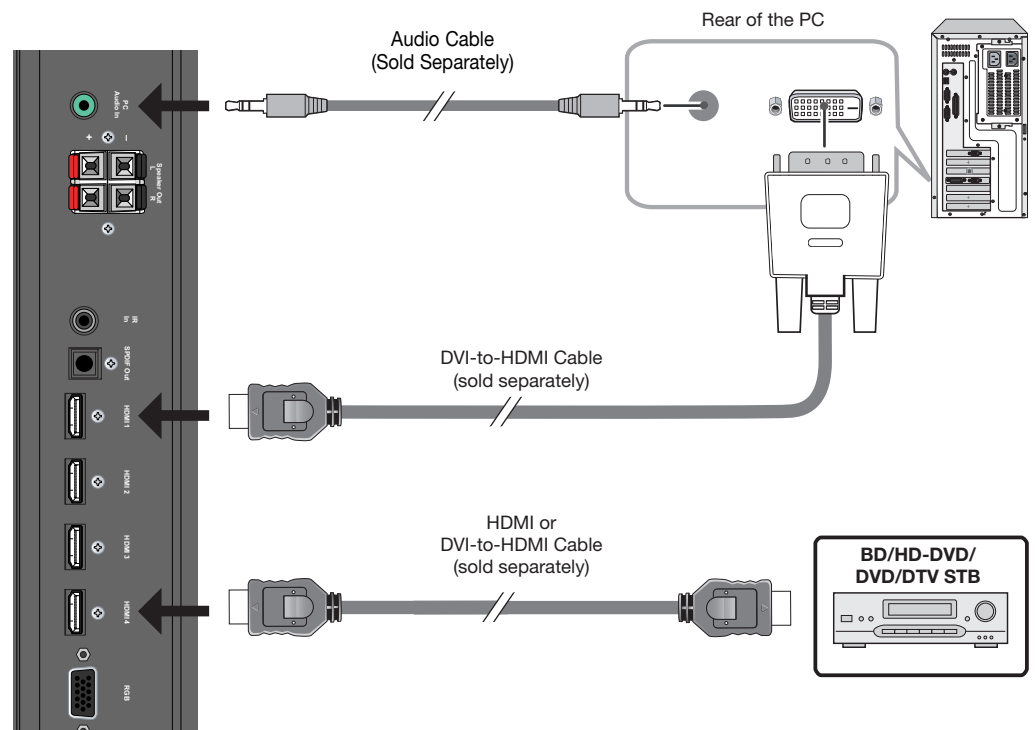

Figure 3-1. HDMI Connections

RGB Connections: The Crystal Series LCD has an RGB input and a stereo audio input for connecting a personal computer; see Figure 3-2.

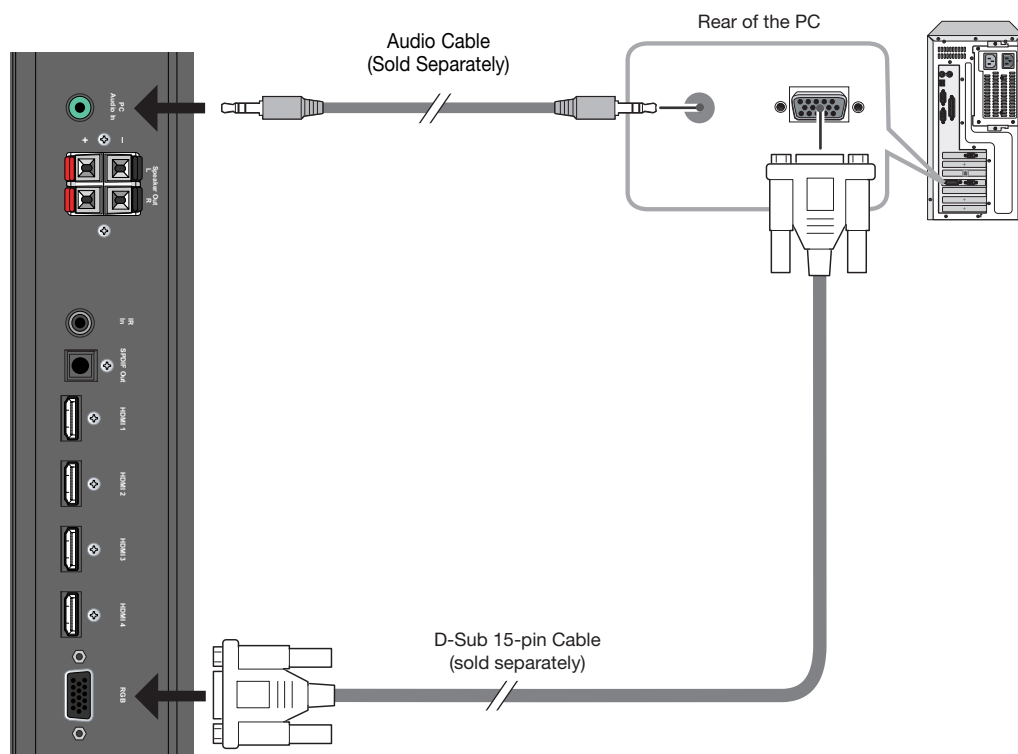

Figure 3-2. Analog RGB Connections



Note

1. Refer to **Supported Timings** on page 59 for a list of computer signals compatible with the Crystal Series LCD. Use with signals other than those listed may cause some functions not to work.
2. Some Macintosh computers may require a Macintosh video adapter. Contact your nearest authorized service center or dealer.
3. This Crystal Series LCD may not be able to display images from notebook computers in simultaneous (CRT/LCD) mode. Should this occur, switch the notebook computer to "CRT only" mode. If you are unsure how to do this, refer to your notebook computer's user manual.

Component Video Connections: If you have a DVD player, DTV decoder with a component (YPbPr) output or other component video source, connect it to the COMPONENT 1 or COMPONENT 2 input as shown in Figure 3-3.

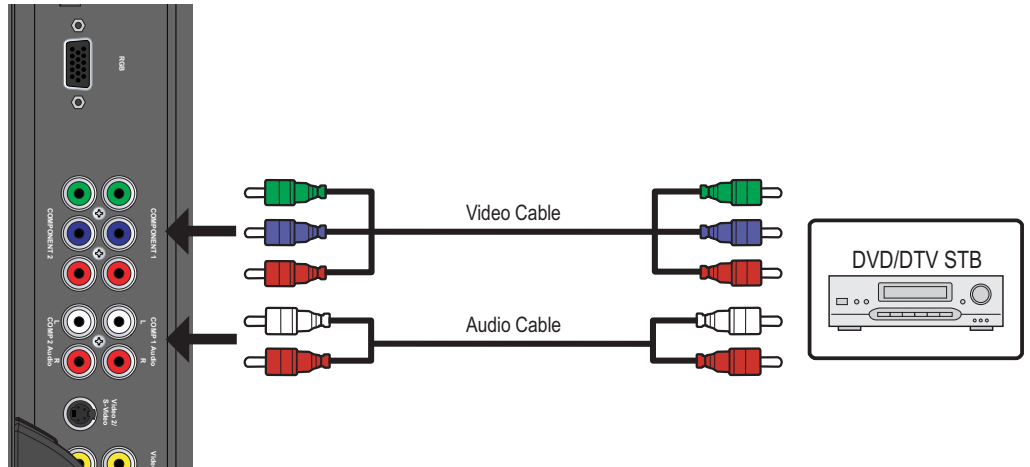

Figure 3-3. Component Video Connections

Composite/S-Video Connections: The Crystal Series LCD has two (2) Composite video inputs and an S-Video input for connecting a VCR, camcorder, laser disc player or DVD player; see Figure 3-4.



Note

If you connect an S-Video source to the Video 2 input, the Composite input on Video 2 is inactive.

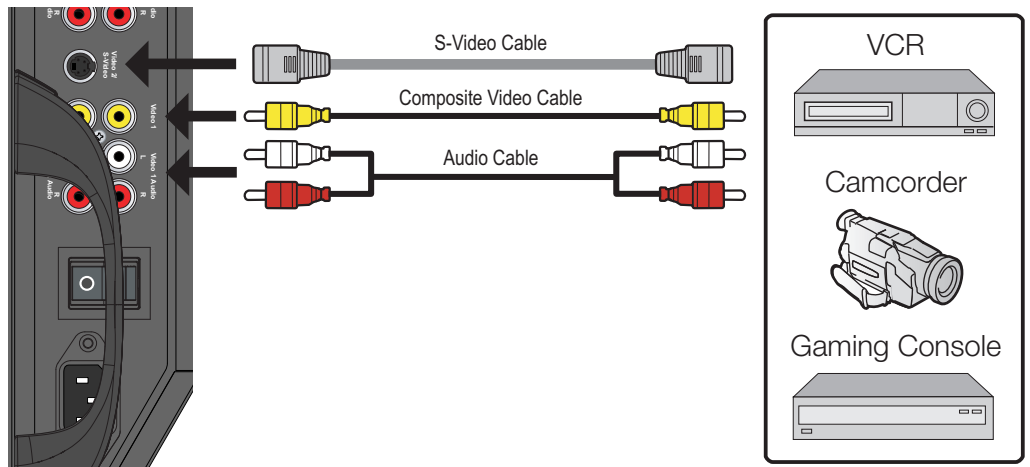

Figure 3-4. Composite and S-Video Connections

SCART Video Connections: Connect the green, blue and red outputs from your SCART source to the Component 1 input on the Crystal Series LCD. Connect the sync output from your SCART source to the Video 1 input on the Crystal Series LCD. See Figure 3-5.



Note

You must enable SCART connectivity in the Setup menu to use SCART sources; refer to **SCART** on page 37.

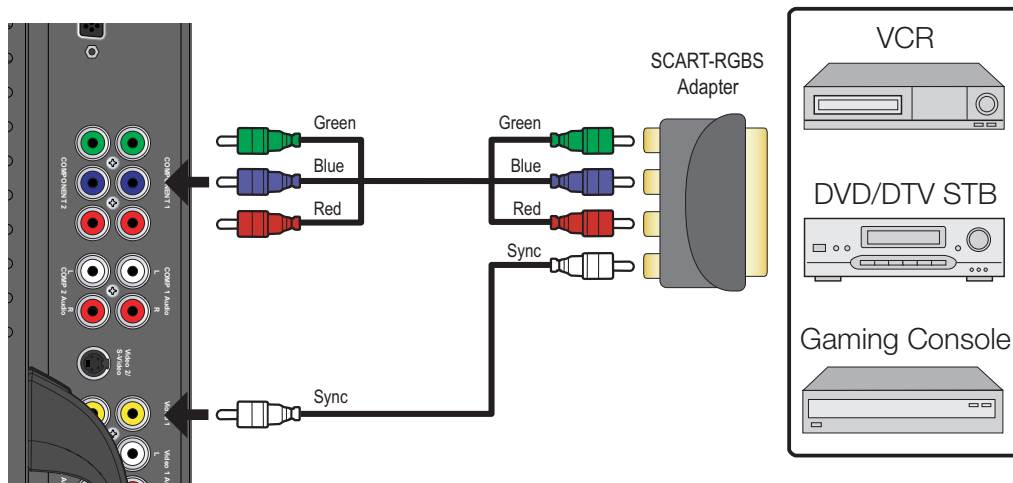

Figure 3-5. SCART RGB Connections

Connect the ⊕ (positive) and ⊖ (negative) speaker wires to the SPEAKER-R and SPEAKER-L terminals; see Figure 3-6. **Maintain the correct polarity.** For more information, refer to the owner's manual for your speakers.

◀ **Connecting External Speakers (Optional)**

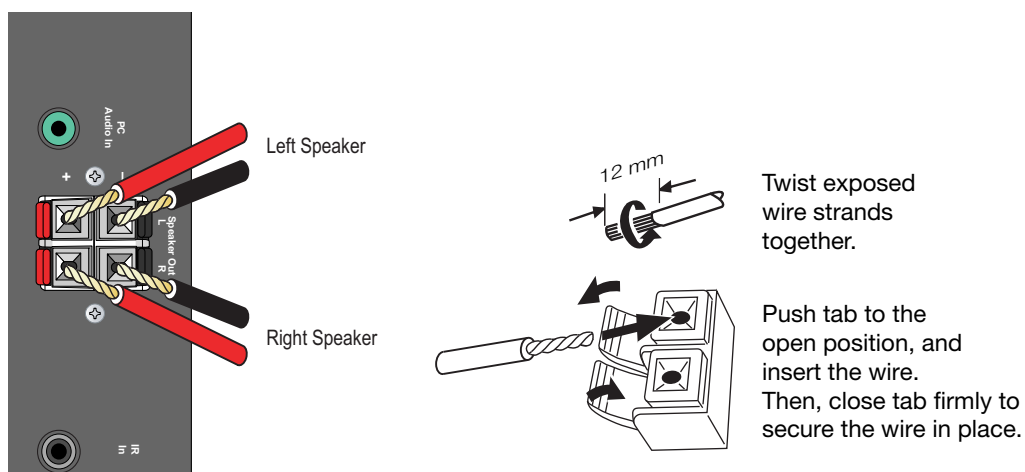

Figure 3-6. External Speaker Connection

Connecting to a Dolby Digital Amplifier ➤

If your home theater has a Dolby Digital amplifier or receiver, connect the SPDIF digital audio output from the Crystal Series LCD to the digital audio input of the amplifier/receiver as shown in Figure 3-7.



Note

The audio output level is fixed. (The volume and mute controls affect only the speaker outputs.)

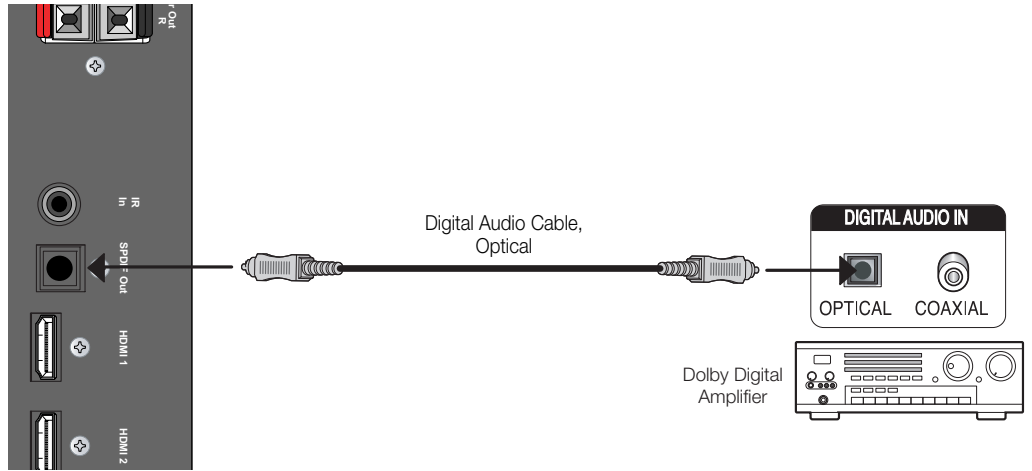

Figure 3-7. Digital Audio Connection

If infrared signals from the remote control cannot reach the display due to excessive distance or obstructions such as walls or cabinet doors, you can connect an external IR repeater system to the IR INPUT on the Crystal Series LCD to extend the range of the remote control. See Figure 3-8.

◀ **Connecting an External IR Receiver**

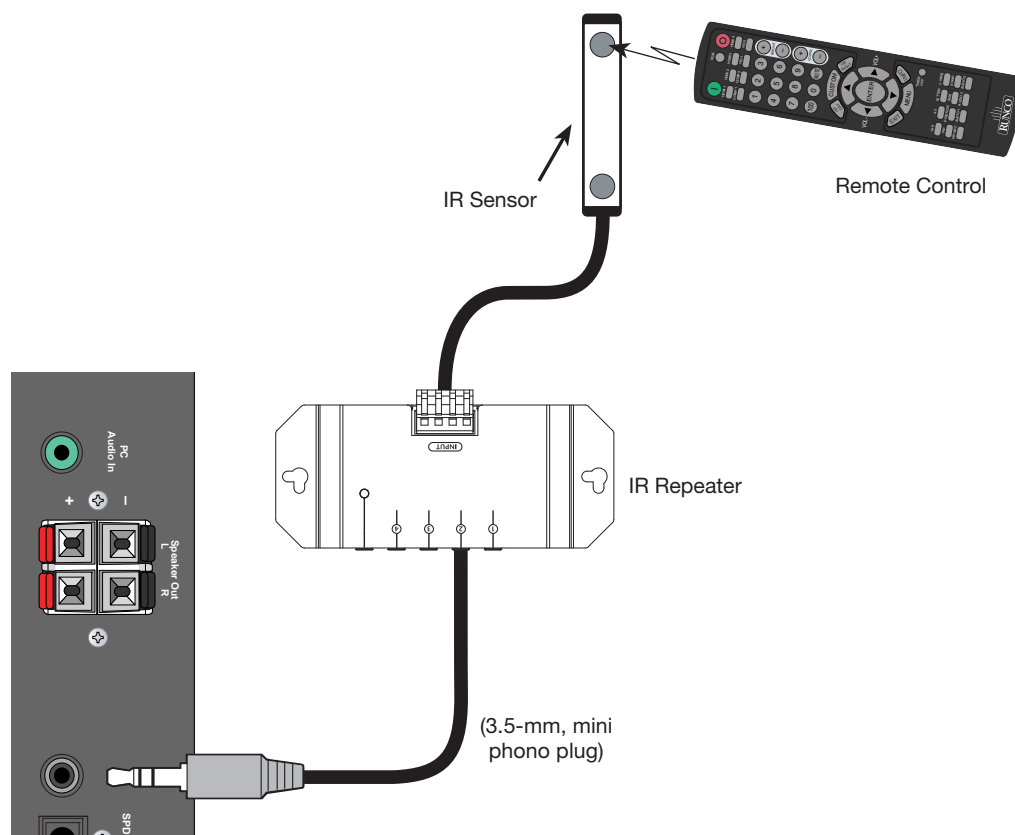
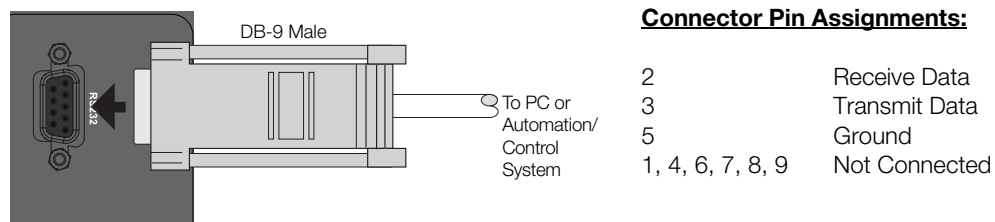

Figure 3-8. External IR Receiver Connection

Use a straight-through RS-232 cable with a 9-pin male connector to connect a PC or home theater control/automation system (if present) to the RS-232 port on the Crystal Series LCD; see Figure 3-9.

◀ **RS-232 Controller Connection**

For more information about using this connection, refer to **Serial Communications** on page 47.





Connector Pin Assignments:

2	Receive Data
3	Transmit Data
5	Ground
1, 4, 6, 7, 8, 9	Not Connected

Figure 3-9. RS-232 Control System Connection

Notes:

4. Operation

1. Turn on your source components.
2. Plug the female end of the supplied power cord into the AC receptacle on the side of the Crystal Series LCD (AC 100V ~ 240V). See Figure 2-2 (CX-47HD/CX-OPAL47) or Figure 2-3 (CX-65HD).
3. Connect the other end to your AC power source.
4. Turn on the main power switch at the side of the display. The power indicator lights orange to indicate that the Crystal Series LCD is in “standby” mode.
5. Press the **ON** button () on the remote control to turn on the display (or press the power button () on the side of the display). The power indicator turns off.
6. After a brief warm-up period (approximately 10 seconds), the Crystal Series LCD will display an image.



4.1 Turning on the Power

The Crystal Series LCD OSD language is initially set to English, but can also display the menus in French, Spanish, Portuguese or German. To change the OSD language:

1. Press **MENU**.
2. Select **Setup** from the Main Menu.
3. Select **OSD Language** from the Setup Menu.
4. Press **▲** or **▼** to highlight the desired language and press **ENTER**. The change takes effect immediately.

4.2 Changing the OSD Language

4.3 Setting the PC Display Properties

To maximize image quality when using the Crystal Series LCD with a personal computer, you may need to adjust the display properties of your PC video card. To do this:

1. Choose Settings from the Windows Start menu and click on "Control Panel."
2. Double click on the **Display** icon.
3. Click the **Settings** tab on the display dialog box.
4. Set the Screen area to 1400x1050 pixels.
5. Click the **Advanced** button and click the **Monitor** tab on the dialog box. Set the Refresh Frequency to 60Hz and click **OK**.

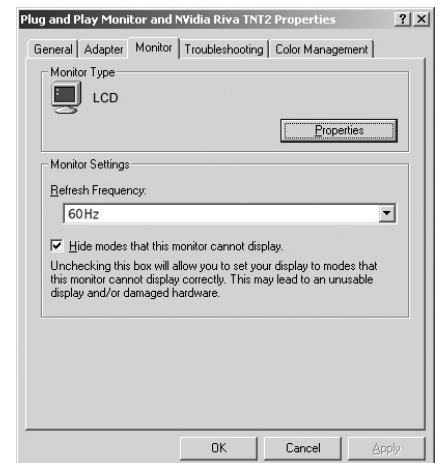
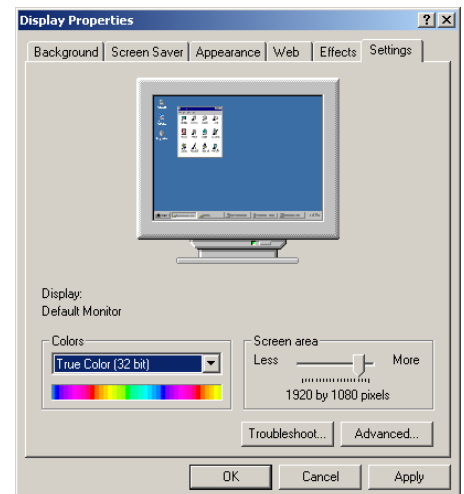
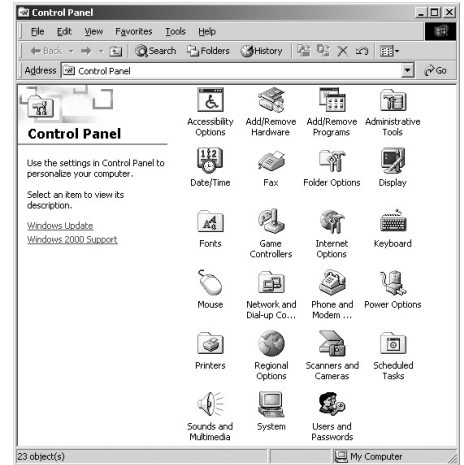

**Note**

1. The maximum available resolution and vertical frequency is 1920x1200/60Hz or the maximum supported by your video card, whichever is lower.
2. The Crystal Series LCD supports 30-bit color (1,073,741,824 possible colors).

To use the on-screen menus:

1. Press **MENU** to display the Main Menu.
2. To select a menu item, use the up- or down-arrow buttons (▲, ▼) on the remote control to highlight it.
3. Press **ENTER** or the right-arrow button (▶) to access that menu.
4. Use the up- or down-arrow buttons (▲, ▼) to select the setting you want to change. Then, press **ENTER** or the right-arrow button (▶).
5. Press the right- or left-arrow button (◀, ▶) to change that setting.
6. To return to the previous menu, press **MENU** or (◀).

The Crystal Series LCD OSD menus are arranged hierarchically, as shown in Figure 4-1. Depending on the selected input source and/or signal characteristics, some menu options may not be available.

4.4 Using the On-Screen Menus

Source	HDMI 1			
	HDMI 2			
	HDMI 3			
	HDMI 4			
	Component 1/SCART	Note: If SCART is enabled in the Setup menu, Component 1 and Video 1 are disabled.		
	Component 2			
	RGB			
	Video 1/SCART			
	Video 2			
Aspect Ratio	16:9			
	4:3			
	Letterbox/Cinema Fill			
	VirtualWide			
Picture Adjust	Brightness			
	Contrast	0, 1, 2, 3 ... 100		
	Color			
	Tint			
	Sharpness		0, 1, 2, 3 ... 24	
	DNR	0, 1, 2, 3 ... 5		
	MPEG NR	0, 1, 2, 3 ... 63		
	Backlight	0, 1, 2, 3 ... 100		
	Color Temp.	5400, 6500, 8500 or Custom		
	Gamma	2.0, 2.2 or 2.4		
	Save Settings	Custom		
	Restore Settings	Custom, ISF Day, ISF Night		
Audio	Balance	0 (L), 1, 2 ... 10 (C) ... 18, 19, 20 (R)		
	Equalizer	Custom 1, Custom 2 or Custom 3		
	Speaker	(On/Off)		
Timer	Time	12:00 AM - 11:59 PM		
	On Timer	Enable/Disable, Time, Input, Volume		
	Off Timer	Enable/Disable, Time		
	Sleep Timer	Off, 10, 30, 60, 120 or 180 minutes		
Setup	OSD Language	English, Français, Español, Português or Deutsch		
	OSD Timer	0, 10, 20 ... 60 sec.		
	PC Mode Adjust	Auto Adjust		
		Clock		
		Phase		
		H. Position		
		V. Position		
	Factory Reset			
	Overscan (not available with PC signals)	H. Overscan, H. Shift, V. Overscan, V. Shift	0, 1, 2, 3 ... 10	
	Letterbox Mode	Letterbox or Cinema Fill		
	HDMI Audio Input	HDMI 1 ... HDMI 4	HDMI or Stereo (PC Audio In)	
	Film Mode	Off, 2:3, 2:2 or Auto		
	Auto Backlight	Off / On		
	HDMI CSC	HDMI 1 ... HDMI 4	Automatic, RGB or Component	
	Baud Rate	115200, 19200, 9600 or 2400		
SCART	Off / On			
Source Enable	HDMI 1 ... HDMI 4 Component 1 Component 2 RGB Video 1 Video 2	Enable / Disable		
LED Option	Off / On			
System Info	Model Number/ Serial Number/ Firmware Version (read-only)			
ISF Calibration	Picture Adjust	Brightness		
		Contrast	0, 1, 2, 3 ... 100	
		Color		
		Tint		
		Sharpness		0, 1, 2, 3 ... 24
		ADC Phase Adj.	0, 1, 2, 3 ... 63	
		DNR	0, 1, 2, 3 ... 5	
		MPEG NR	0, 1, 2, 3 ... 63	
		Backlight	0, 1, 2, 3 ... 100	
	Color Temp.	5400, 6500, 8500 or Custom		
	Gamma	2.0, 2.2 or 2.4		
	Save Settings	Custom, ISF Day, ISF Night		
	Restore Settings	Custom, ISF Day, ISF Night		
	White Balance	R/G/B Gain	128, 129 ... 256 ... 383, 384	
		R/G/B Offset	-50, -49 ... 0 ... 49, 50	
Blue Enable	(Enable/Disable)			
Factory Reset	(No/Yes)			
Splash Duration	0, 5, 10, ... 60 secs.			

Figure 4-1. Crystal Series LCD OSD Menu Structure

The Main Menu is the starting point for accessing all Crystal Series LCD functions.
 (The ISF Calibration menu is not accessible until you enter a passcode.)

◀ **Main Menu**

Runco CX-65HD

- Source**
- Aspect Ratio
- Picture Adjust
- Audio
- Timer
- Setup
- ISF Calibration

From the Main Menu, select Source to choose a video signal source.

The active source is indicated by an arrow (>) to its left; in this example, HDMI 1 is the active source.

◀ **Source**

- > **HDMI 1**
- HDMI 2
- HDMI 3
- HDMI 4
- Component 1
- Component 2
- RGB
- Video 1
- Video 2

To change the aspect ratio (size and shape) of the projected image, select Aspect Ratio from the Main Menu and press **ENTER**. Select the appropriate aspect ratio for the type of program material being viewed; refer to Table 4-1.

The currently-selected aspect ratio is indicated by an arrow (>) to its left; in this example, 16:9 is selected.

◀ **Aspect Ratio**

- > **16:9**
- 4:3
- Letterbox
- VirtualWide



Note

The aspect ratio selection persists until you change it. (It is not saved independently for each input.)

Table 4-1. Aspect Ratio Settings

Aspect Ratio	Remote Control Key	Description	
16:9	16:9	 <p>16:9 Image on 16:9 Screen (Display)</p> <p>4:3 Image, stretched to fill 16:9 Screen (Display)</p>	<p>Select 16:9 to view 16:9 DVDs and HDTV programs in their native aspect ratio.</p> <p>4:3 images are stretched horizontally to fit a 16:9 display.</p>
4:3	4:3	 <p>4:3 Image on 16:9 Screen (Display)</p>	<p>4:3 scales the input signal to fit in the center of a 16:9 display. 4:3 is the aspect ratio used by computer monitors, standard television programming and most VHS video cassettes.</p>
Letterbox/ Cinema Fill	LETTER	<p>Letterbox Mode = Letterbox</p>  <p>4:3 Image on 16:9 Display (Letterbox aspect ratio)</p> <p>Letterbox Mode = Cinema Fill</p>  <p>4:3 Image on 16:9 Display (Letterbox aspect ratio)</p>	<p>Letterbox mode scales (zooms in on) a 4:3 image linearly (by the same amount on all sides) to fill a 16:9 display.</p> <p>The zoom factor is either 1.33 or 1.78, depending on the Letterbox Mode setting (refer to Letterbox Mode on page 36).</p> <p>Letterbox is best suited for viewing LaserDisc movies or non-anamorphic DVDs on a 16:9 screen.</p>

Table 4-1. Aspect Ratio Settings (continued)

Aspect Ratio	Remote Control Key	Description	
VirtualWide	V WIDE	 <p>4:3 Image on 16:9 Screen (Display)</p>  <p>4:3 Image on 16:9 Display with VirtualWide</p>	VirtualWide scales a 4:3 image NON-linearly (more on the sides than in the center) to fit a 16:9 screen.

Use the controls in the Picture Adjust menu to calibrate your Crystal Series LCD for optimum picture quality.

The Crystal Series LCD has been designed to incorporate setup and calibration standards established by the Imaging Science Foundation (ISF). The ISF has developed carefully crafted, industry-recognized standards for optimal video performance and has implemented a training program for technicians and installers to use these standards to obtain optimal picture quality from Runco video display devices. Accordingly, Runco recommends that setup and calibration be performed by an ISF-certified installation technician.

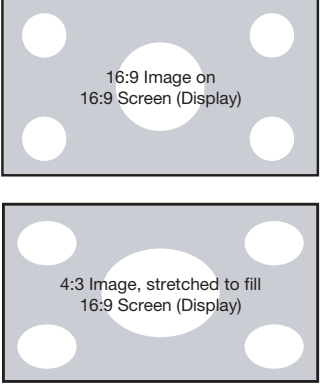
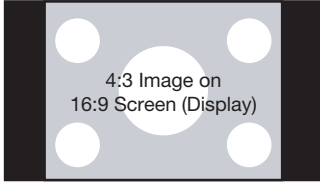
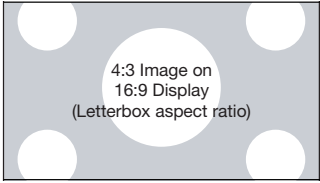
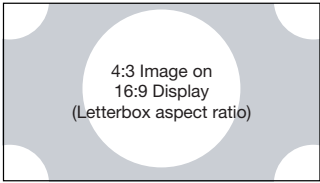
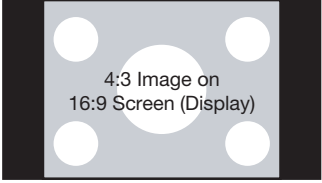
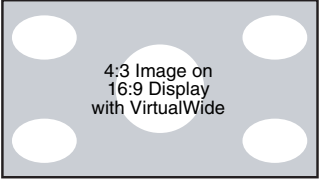
All signal types require separate processing. Therefore, you need to calibrate each input separately.



Note

*When you change a picture quality setting, save the change to a preset afterwards. Otherwise, the change will be lost when a different input is selected. (Picture quality settings are saved for each input and resolution separately.) For information about saving settings, refer to **Save Settings** on page 33.*

Although it may be possible to obtain satisfactory picture quality using the naked eye and regular program material, Runco recommends using the following calibration tools for best results:

- External test pattern source – Ovation Multimedia, Digital Video Essentials or AVIA test DVD or equivalent.
- A blue filter (provided with many test DVDs), for color level and tint adjustments.

Connect your test pattern source to the input that you are calibrating and proceed as follows. **Perform the adjustments in the order listed here.**

Brightness: On your external test pattern source, select a PLUGE pattern. (PLUGE is an acronym for “Picture Line-Up Generation Equipment.”) Figure 4-2 shows a typical PLUGE pattern.

◀ **Picture Adjust**

Picture Adjust
Brightness
Contrast
Color
Tint
Sharpness
DNR
MPEG NR
Backlight
Color Temp.
Gamma
Save Settings
Restore Settings

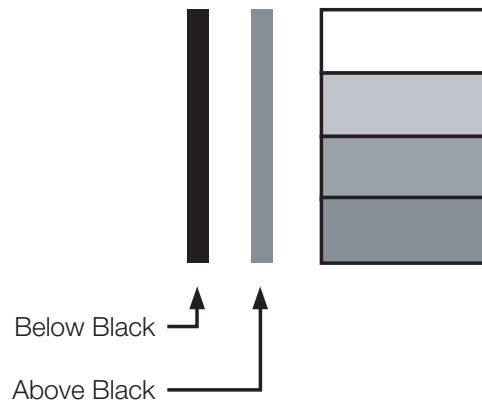

Figure 4-2. Typical PLUGE Pattern for Adjusting Brightness

PLUGE patterns vary but generally consist of some combination of black, white and gray areas against a black background. The example above includes two vertical bars and four shaded boxes.

Select Brightness from the Picture Adjust menu. Using the left- and right-arrow (◀ ▶) buttons, adjust the brightness so that:

- The darkest black bars disappear into the background.
- The dark gray areas are barely visible.
- The lighter gray areas are clearly visible.
- The white areas are a comfortable level of true white.
- The image contains only black, gray and white (no color).

Contrast: On your external test pattern source, select a stepped, gray-bar pattern like the one shown in Figure 4-3.



Figure 4-3. Typical Gray Bar Pattern for Adjusting Contrast

Select Contrast from the Picture Adjust menu. Using the left- and right-arrow (◀ ▶) buttons, adjust the contrast to a point just below which the white rectangle starts to increase in size.



Note

Brightness and contrast controls are interactive. A change to one may require a subtle change to the other in order to achieve the optimum setting.

Color Saturation: On your external test pattern source, select a color bar pattern like the one shown in Figure 4-4.

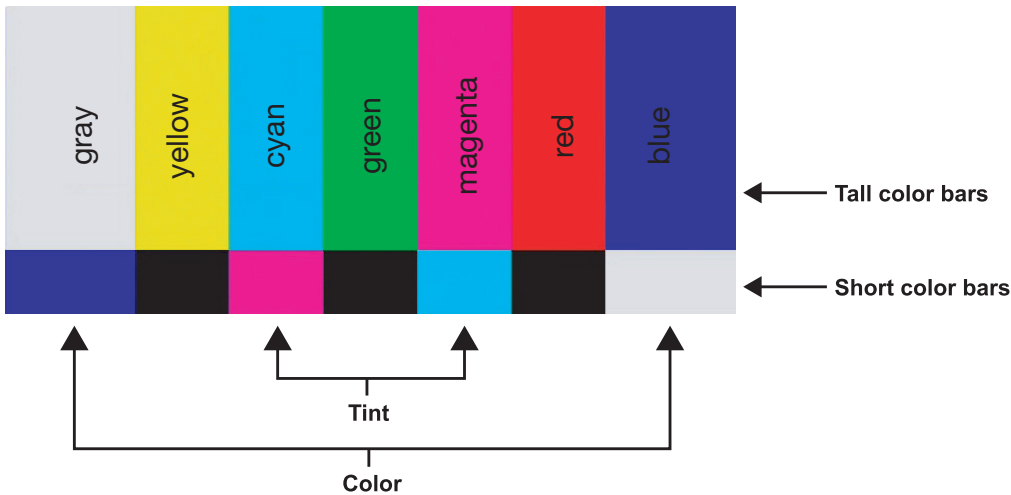
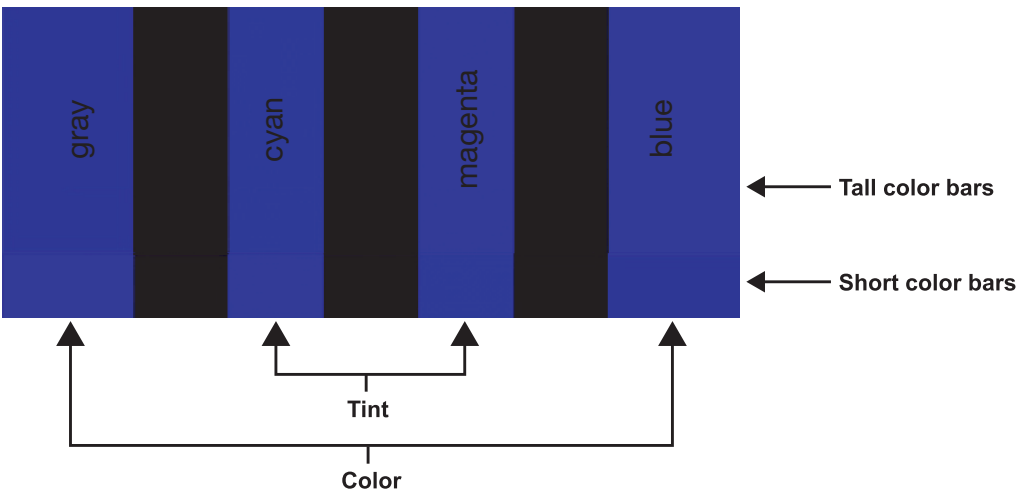

Figure 4-4. Typical Color Bar Pattern for Adjusting Color Saturation and Tint

Select Color from the Picture Adjust menu. While looking at the color bar pattern through a blue filter, adjust the color saturation level until the outermost (gray and blue) color bars appear to be a single shade of blue:



Tint: Tint or “hue” is essentially the ratio of red to green in the color portion of the image. When tint is decreased, the image appears redder; when it is increased the image appears greener. To set the tint, select Tint from the Picture Adjust menu. While looking at the color bar pattern through a blue filter, adjust the tint level until the cyan and magenta color bars (on either side of the green bar) appear to be a single shade of blue.

**Note**

Like the brightness and contrast controls, the color and tint controls are interactive. A change to one may require a subtle change to the other in order to achieve the optimum setting.

Sharpness: “Sharpness” is the amount of high-frequency detail in the image. To adjust sharpness, select Sharpness from the Picture Adjust menu and press **ENTER**. On your external test pattern source, select a pattern like the one shown in Figure 4-5. Adjust as needed, looking for white edges around the transitions from black to gray and different sized lines in the “sweep” patterns at the top and bottom. Lower the sharpness setting to eliminate them.

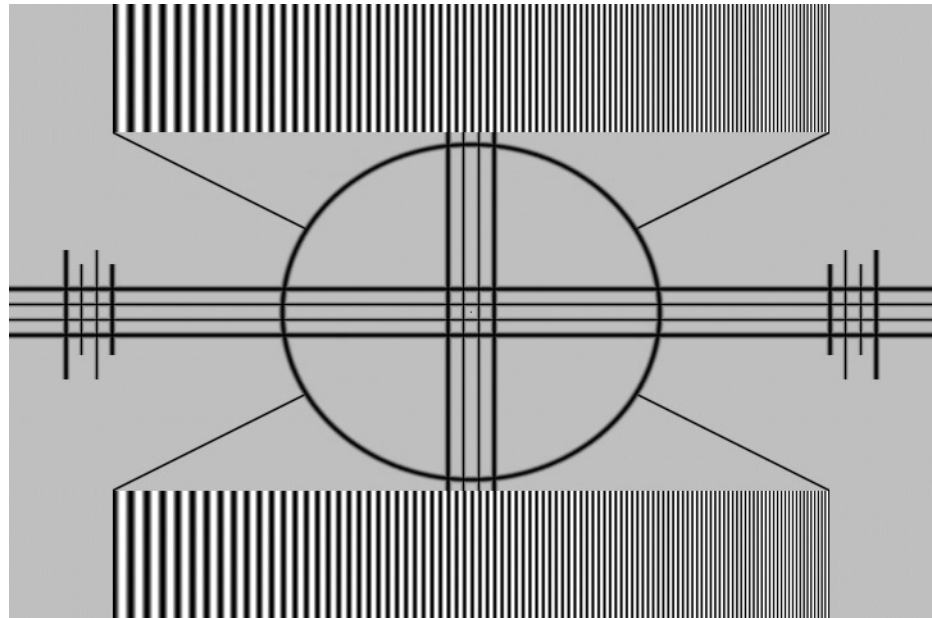

Figure 4-5. Typical Test Pattern for Adjusting Sharpness

DNR: To apply Digital Noise Reduction (DNR) to the input signal, select DNR from the Picture Adjust menu. Noise reduction is useful for clearing up noisy RGB images such as those from a PC. Adjust as desired using the left- or right-arrow buttons, keeping in mind that reducing noise (which reduces high frequencies) may also “soften” the image.

MPEG NR: Use the MPEG Filter to reduce or eliminate so-called “mosquito noise” in MPEG-compressed video signals (digital broadcasts or DVDs). Adjust as needed to minimize distortion around the edges of moving objects, moving artifacts around edges and/or blotchy noise patterns superimposed over the objects.

Backlight: The Backlight control changes the apparent brightness of the displayed image. Its effect is similar to that of a lamp intensity control on a projector.

**Note**

The Backlight control is disabled when Auto Backlight (described on page 36) is set to On.

Color Temperature: To choose a color temperature setting, select Color Temp. from the Picture Adjust menu and press **ENTER**. (Color temperature defines the “color of gray.”) The choices are 5400K, 6500K, 8500K and Custom. The default setting, 6500K, is appropriate for most situations. Higher settings produce a “bluer” picture; lower ones impart a reddish hue to the image.

Each color temperature setting has six (6) “white balance” parameters associated with it (two each for red, green and blue). These are described later in this section; refer to **White Balance** on page 39.

Gamma: The Gamma control determines how gray shades are displayed between minimum input (black) and maximum input (white) for all signals. A good gamma setting helps to optimize blacks and whites while ensuring smooth transitions for the “in-between” values utilized in other grays.

Unlike brightness and contrast controls, Gamma allows you to lighten or darken the overall tone of your images without changing the extremes. All images will be more vibrant while still showing good detail in dark areas.

The default Gamma setting of 2.2 is appropriate for most typical home theater environments.

Save Settings: The Crystal Series LCD lets you save image quality settings for each input and supported resolution to a preset. You can recall this preset at a later time by simply pressing a button on the remote control or using the Restore Settings menu command (see below).

You should save changes to any of the following settings to a preset; otherwise they will be lost when a new input source or resolution is selected:

- Brightness
- Contrast
- Color saturation
- Tint
- Sharpness
- Gamma
- Color temperature selection (5400, 6500, 8500 or Custom)

Restore Settings: To recall a preset, choose Restore Settings from the Picture Adjust menu and select “Custom,” “ISF Day” or “ISF Night.” Or, use the corresponding buttons on the remote control.

Audio ➤ To adjust the Crystal Series LCD audio settings, select Audio from the Main Menu and press **ENTER**.

- Audio
- Balance**
- Equalizer
- Speaker

Balance: To adjust the left/right speaker balance, select Balance from the Audio Menu and press **ENTER**. Use the left- and/or right-arrow buttons to make one channel louder than the other.

Equalizer: The Crystal Series LCD has a five-band graphic equalizer that you can use to boost or cut certain audio frequencies. To use it, select Equalizer from the Audio menu and press **ENTER** or ►.

From this menu, you can create and store audio “modes.” A mode is a combination of volume and equalizer settings. The viewer can then recall these settings using the AUDIO 1, AUDIO 2 and AUDIO 3 remote control buttons.



To select and customize an audio mode – Custom1 (AUDIO 1), Custom2 (AUDIO 2) or Custom3 (AUDIO 3):

1. Use the ▲ or ▼ button to highlight its name. Then, press **ENTER** or ►.
2. Press ◀ or ▶ to select the Volume slider or equalizer frequency band that you want to adjust. The five frequency bands are 100, 300, 1000, 3000 and 10,000 Hertz (Hz).
3. Use the ▲ or ▼ button to adjust according to taste.
4. Repeat Steps 2 and 3 for the other settings, as desired.
5. To edit another audio mode, press **ENTER** to store your settings and repeat Steps 1 through 4.
6. Press **MENU** or **EXIT** when you have finished configuring audio modes.

Speaker: To disable the speakers, select Speaker from the Audio menu, set it to Off and press **ENTER**. The effect is similar to using the **MUTE** button, except that the Crystal Series LCD “remembers” this setting if you turn off the display, then turn it back on.

Timer ➤ To set the Crystal Series LCD’s internal clock or configure the on/off timers, select Timer from the Main Menu and press **ENTER**.

- Timer
- Time**
- On Timer
- Off Timer
- Sleep Timer

Time: To set the Crystal Series LCD internal clock, select Time from the Timer menu and press **ENTER**. Then, use the left- or right-arrow button to select the hour of the day, AM/PM or the minute of the hour to set. Then, use the up- or down-arrow buttons to set that component of the time.

When finished, press **MENU** or **EXIT**.

On Timer: Use the On Timer to turn the Crystal Series LCD on at a specific time of day. You can also specify a source input and volume level.

Off Timer: Use the Off Timer to turn the Crystal Series LCD off at a specific time of day.

Sleep Timer: Use the Sleep Timer to turn off the Crystal Series LCD after a specified interval.

To set the Sleep Timer:

- Select Sleep Timer from the Timer menu and press **ENTER**.
- OR –
- Press the **TIMER OFF** button on the remote control.

Use the right- or left-arrow button to select 10, 30, 60, 120 or 180 minutes. Then, press **ENTER** or **MENU**.

Use the controls in the Setup menu to perform advanced image quality adjustments and access various other Crystal Series LCD features.

OSD Language: Select OSD Language from the Setup menu and press **ENTER**. Then, use the up- or down-arrow buttons to select the OSD language (English, French, Spanish, Portuguese or German). Press **ENTER** again to confirm your selection.

OSD Timer: Use the ◀ or ▶ button to set the OSD Timer. This timer controls how long the menus remain on-screen after selecting them. Select from 0 to 60 seconds, in 10-second increments. When you set the OSD to 0, the menus remain on-screen until you hide them by pressing **EXIT**.

PC Mode Adjust: To improve the quality of displayed images from a computer or other VESA-compliant, RGB (480p or higher) source, select PC Mode Adjust and press **ENTER**.

- **Auto Adjust:** Auto Adjust automatically adjusts settings to optimize computer images. To execute Auto Adjust on command, select Auto Adjust and press **ENTER**.



Note Auto Adjust may take some time to complete, depending on the characteristics of the incoming signal.

- **Clock:** Use the up- or down-arrow buttons (▲, ▼) to highlight Clock. Then, use the right-arrow button (▶) to increase the pixel clock rate; use the left-arrow button (◀) to decrease it.
- **Phase:** Adjust the phase if the image shows shimmer or “horizontal noise.” Pixel phase adjusts the phase of the pixel sampling clock relative to the incoming signal. The effect of this control is similar to that of a tracking control on a VCR.

For best results, use a good test pattern such as a smooth gray consisting of a clear pattern of black and white pixels, or a similar “half on, half off” graphic image. (You may notice that you can stabilize the image at more than one point. Use either setting in this case.)

- **H Position:** Use the up- or down-arrow buttons (▲, ▼) to highlight H Position. Then, use the right-arrow button (▶) to shift the image to the right; use the left-arrow button (◀) to shift the image to the left.
- **V Position:** Use the up- or down-arrow buttons (▲, ▼) to highlight V Position. Then, use the right-arrow button (▶) to shift the image up; use the left-arrow button (◀) to shift the image down.

To restore the factory-default Clock, Phase and Position settings, select Factory Reset and press **ENTER**.

◀ **Setup**

Setup
OSD Language
OSD Timer
PC Mode Adjust
Overscan
Letterbox Mode
HDMI Audio Input
Film Mode
Auto Backlight
HDMI CSC
Baud Rate
SCART
Source Enable
LED Option
System Info

Overscan (not available with PC signals): Overscan pushes the outside edge of the active picture area of the video signal out beyond the edge of the display area.

Some television programs are produced based on the assumption that older television sets may not display the outer edges of the broadcast picture area. Overscan effectively trims away these inactive, outer edges and enlarges the remaining portion of the image to fill the display area.

Use the on-screen slidebars to set the desired amount of horizontal and vertical overscan, as well as horizontal and vertical image shift.

These settings only affect 480i source material. For HDTV, DVDs and other video sources, Overscan is generally not necessary or desirable.

Letterbox Mode: Select Letterbox Mode from the Setup menu to change the zoom factor that takes effect when you select the Letterbox aspect ratio (refer to Table 4-1).

When you select Letterbox, the image is enlarged (zoomed in) by a factor of approximately 1.33.

When you select Cinema Fill, the zoom factor is approximately 1.77 (1.33 x 1.33).

Letterbox Mode = Letterbox

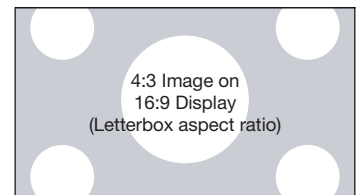

Letterbox Mode = Cinema Fill

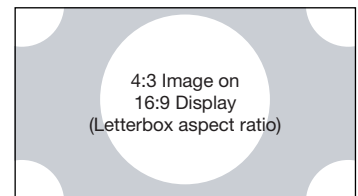

HDMI Audio Input: If you are using one of the HDMI inputs with a PC or other device that does not support audio output via HDMI, set HDMI Audio Input to Stereo for that input. (Also connect the audio output from your source as shown in Figure 3-1.) This setting associates the PC AUDIO IN input with that HDMI input.

If the source *does* support audio output via HDMI, set this option to HDMI to route the HDMI (digital) audio signal to the speakers and digital audio output when HDMI1, HDMI 2, HDMI 3 or HDMI 4 is selected.

Film Mode: To smooth out moving images from interlaced, standard-definition (SD) sources, select Film Mode and set it to Automatic.

In most cases, the Crystal Series LCD detects the proper “pull-down” rate and vertical frequency. However, if your source is jittery and/or tearing you may wish to specify the pull-down rate (2:2 or 3:2) to ensure stable processing for that source.

Auto Backlight: Select Auto Backlight from the Setup menu and set it to On to have the Crystal Series LCD adjust the Backlight setting automatically, according to the ambient light level in the viewing area.

HDMI CSC (Color Space Control): If the color space of the incoming signal on an HDMI input is known, select HDMI CSC from the Setup menu and set it to RGB or Component for that input.

In most situations, the **Auto** setting works well.

Baud Rate: Select Baud Rate from the Setup menu to set the data transfer rate of the Crystal Series LCD's RS-232 port. (This setting must match the data rate of the device connected to the RS-232 input.)

SCART: Set SCART to On if you are using the Component 1 and Video 1 inputs to connect a SCART source (see Figure 3-5). When you do, the Source menu appears as shown here (Component 1 and Video 1 are not available).



Source Enable: Select Source Enable from the Setup menu to disable inputs that you are not using. By default, all inputs are enabled.

Disabling unused inputs causes the main input select function (using the **SOURCE** button on the LCD keypad) to skip over them, saving time. The PIP input select function (using the **PIP SRC** button on the remote control unit) is similarly affected.

- HDMI 1/HDMI 2/HDMI 3/HDMI 4: Enables or disables an HDMI source.
- Component 1/Component 2: Enables or disables the Component 1 or Component 2 source.
- RGB: Enables or disables the RGB source.
- Video 1/Video 2: Enables or disables the a video source.



Note

If either Component 1 or Video is enabled, SCART must be disabled.

LED Option: Select LED Option from the Setup menu to change the behavior of the front-panel status indicator LED (see Figure 2-1) during standby mode.

When set to ON, the LED lights orange to indicate that the Crystal Series LCD is in standby mode. When set to OFF, the LED is always off, regardless of the operational state of the Crystal Series LCD.

System Info: Select System Info from the Setup menu to see information that uniquely identifies your display: its model number, serial number and installed firmware version.

Should you ever need to contact Runco Technical Support, this information will help them answer your questions or resolve product performance issues.

ISF Calibration ➤

Use the ISF Calibration menu to perform advanced picture quality adjustments. **This menu should be used by ISF-certified technicians only.**

ISF Calibration**Picture Adjust****White Balance****Blue Enable****Factory Reset****Splash Duration****Note**

You must enter a passcode to access the ISF Calibration menu.

Picture Adjust: The controls in this menu are identical to those in the main Picture Adjust menu, but are accessible only by entering the ISF Calibration menu passcode. This makes it possible to restore the picture quality settings to what they were when the Crystal Series LCD was installed, simply by recalling the “ISF Night” or “ISF Day” preset.

- **Brightness:** Refer to **Brightness** on page 29.
- **Contrast:** Refer to **Contrast** on page 30.
- **Color:** Refer to **Color Saturation** on page 31.
- **Tint:** Refer to **Tint** on page 31.
- **Sharpness:** Refer to **Sharpness** on page 32.
- **ADC Phase Adj.:** This control works similarly to the Phase adjustment for RGB signals (refer to **Phase** on page 35). Use it to improve the apparent sharpness of 720p and lower-resolution Component, S-Video or Composite sources. For best results, adjust ADC Phase while displaying a “Sharpness” pattern (Figure 4-5).
- **DNR:** Refer to **DNR** on page 32.
- **MPEG NR:** Refer to **MPEG NR** on page 32.
- **Backlight:** Refer to **Backlight** on page 32.
- **Color Temp.:** To choose a color temperature setting, select Color Temp. from the Picture Adjust menu and press **ENTER**. (Color temperature defines the “color of gray.”) The choices are 5400K, 6500K, 8500K and Custom. The default setting, 6500K, is appropriate for most situations. Higher settings produce a “bluer” picture; lower ones impart a reddish hue to the image.

Each color temperature setting has six (6) “white balance” parameters associated with it (two each for red, green and blue). (The White Balance settings for the 5400K, 6500K and 8500K color temperatures are factory-set and cannot be changed.)

**Tip**

*To create a “Custom” color temperature, select Custom from the Color Temp. menu and press **ENTER**. Then, press **ENTER** a second time to go directly to the White Balance menu. (This shortcut is available only from the ISF Calibration menu.)*

- **Gamma:** Refer to **Gamma** on page 33.
- **Save Settings:** For each input and supported resolution, the Crystal Series LCD lets you save image quality settings as presets that you can recall at a later time. You can create up to three presets – designated “Custom,” “ISF Day” and “ISF Night” – per input and resolution.

You should save changes to any of the following settings to a preset; otherwise they will be lost when a new input source or resolution is selected:

- Brightness
- Contrast
- Color saturation

- Tint
- Sharpness
- Gamma
- Color temperature selection (5400, 6500, 8500 or Custom)

To save image settings to a preset, select Save Settings from the Picture Adjust menu and select “Custom,” “ISF Day” or “ISF Night.”

Restore Settings: To recall a preset, choose Restore Settings from the Picture Adjust menu and select “Custom,” “ISF Day” or “ISF Night.” Or, use the corresponding buttons on the remote control.

White Balance: To remove any trace of color from the white areas of the displayed image, set the Color Temp. to Custom. Then, choose White Balance from the ISF Calibration menu and press **ENTER**.

- **Gain:** Use the Gain controls to correct color imbalances in the bright areas of the image. A good way to do this is to use a test pattern consisting mostly of solid white areas, such as an 80 IRE “window” pattern. If the white areas contain traces of red, green or blue, decrease the Gain for that color.
- **Offset:** Use the Offset controls in the White Balance sub-menu to correct color imbalances in the dark areas of the image. A good way to do this is to use a test pattern consisting mostly of dark gray areas, such as a 30 IRE “window” pattern. If the gray areas contain traces of red, green or blue, decrease the Offset for that color.

White Balance	
R Gain	256
G Gain	256
B Gain	256
R Offset	0
G Offset	0
B Offset	0



Note

*Any white balance adjustments you make here are automatically stored as a “Custom” color temperature. The White Balance settings for the 5400K, 6500K and 8500K color temperatures are factory-set and cannot be changed. **Always set the Color Temp. to Custom before making any white balance adjustments, so you can see how those adjustments affect the image.***

Blue Enable: Blue Enable removes all red and green color information from the image, simulating a blue filter. You can use it instead of a blue filter when performing color and tint adjustments.

Factory Reset: To reset all Crystal Series LCD settings to their factory defaults, select Factory Reset from the ISF Calibration menu and press **ENTER**. To confirm the reset, press ▲ or ▼ to highlight Yes and press **ENTER** again. **This command is not undoable. Use it with caution!**

Splash Duration: Use Splash Duration to control how long the Crystal Series LCD splash screen remains on-screen after power-up; see Figure 4-6. To prevent this screen from appearing, set the Splash Duration to 0.



Figure 4-6. Crystal Series LCD Splash Screen



Note

You can personalize the splash screen with the customer name, Runco dealer name or any other string. Refer to **Personalizing the Splash Screen Using Serial Commands** on page 51 for instructions.

To use PIP, press the **PIP** button.

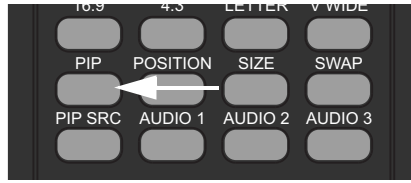

4.5 Using Picture-In-Picture (PIP)

The PIP window appears inside the main image window.

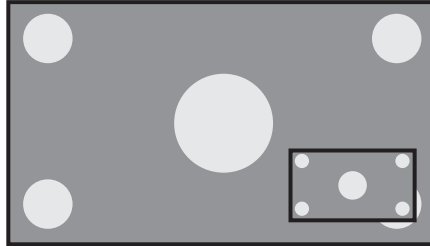

Press **PIP** again to switch to side-by-side PIP mode.

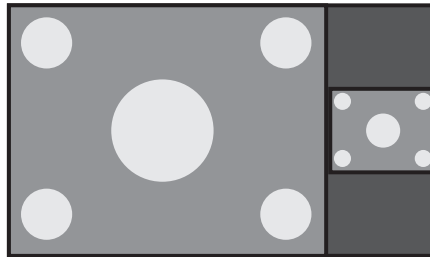

Press **PIP** again to turn PIP off.

Press the **PIP SRC** button to select a PIP signal source. For each source, Table 4-2 shows which of the other sources are available as a PIP source.

Table 4-2. Available Main and PIP Source Combinations

		PIP Input Source								
		VIDEO 1	VIDEO 2	COMP. 1/SCART	COMP. 2	RGB	HDMI 1	HDMI 2	HDMI 3	HDMI 4
Main Input Source	VIDEO 1	-	√	√	√	√	√	√	√	√
	VIDEO 2	√	-	√	√	√	√	√	√	√
	COMP. 1/SCART	√	√	-	√	√	√	√	√	√
	COMP. 2	√	√	√	-	√	√	√	√	√
	RGB	√	√	√	√	-	√	√	√	√
	HDMI 1	√	√	√	√	√	-	-	-	-
	HDMI 2	√	√	√	√	√	-	-	-	-
	HDMI 3	√	√	√	√	√	-	-	-	-
	HDMI 4	√	√	√	√	√	-	-	-	-

Notes:

1. "√" means that that source is available as a PIP source when that input is selected; "-" means that it is not.
2. The Crystal Series LCD cannot display the same source in both the main and PIP windows, nor can it display two HDMI (digital) signals simultaneously.
3. Disabled sources (refer to **Source Enable** on page 37) are not available as PIP sources.

Changing the PIP Position

➤ To change the PIP window position, press the **POSITION** button on the remote control repeatedly until the window is in the desired position.

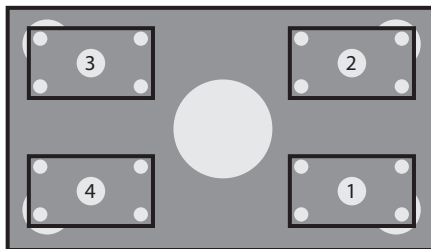
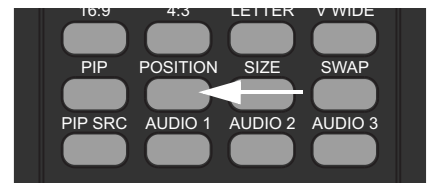

To change the PIP window size, press the **SIZE** button on the remote control repeatedly to achieve the desired window size.

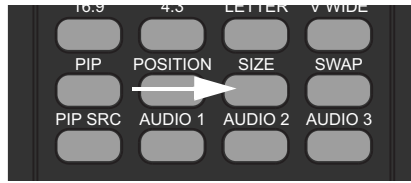
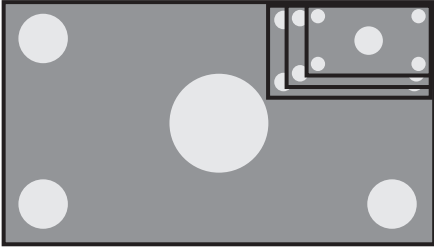

◀ **Changing the PIP Size**

To swap the main and PIP images, press the **SWAP** button on the remote control.

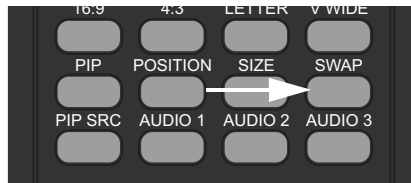
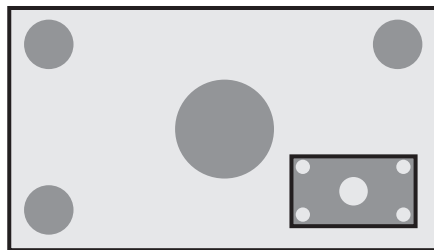
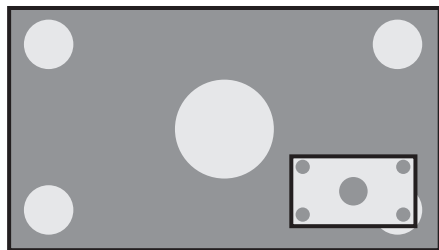

◀ **Swapping the Main and PIP Images**

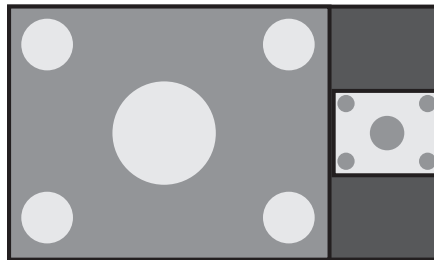
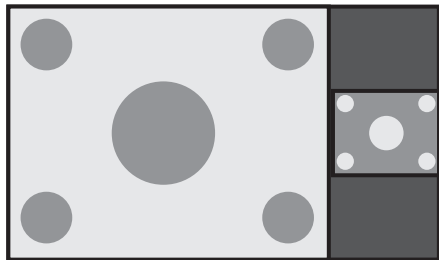

Notes:

5. Maintenance and Troubleshooting

Regular cleaning will extend the life and performance of the Crystal Series LCD. Before cleaning, be sure to unplug the power cord from the power outlet.

Do not under any circumstances use solvents such as benzene or thinner to clean the Crystal Series LCD. Doing so may cause deterioration or peeling of paint from the display or remote control unit.

Wipe the display and remote control gently with a soft cloth. In case of excessive dirt buildup, dampen a soft cloth with a diluted neutral cleaning detergent. Wring the cloth thoroughly, then wipe the component and dry it with a dry soft cloth.

After dusting, wipe the screen gently using a soft cloth (cotton, flannel etc.). Do not use tissue or coarse fabric. The screen surface is easily scratched; do not rub it or hit it with a hard object.

If you clean the surface of the screen with a wet cloth, do not allow water droplets on the surface to enter into the product; this may cause a malfunction.

As a general rule, use a vacuum cleaner about once a month to clean the vents on the rear panel of the display of dust buildup (set the vacuum cleaner to its weakest setting when doing this). If not removed, accumulated dust can cause the internal temperature to increase, resulting in possible breakdown or fire.

Table 5-1 provides some general guidelines for troubleshooting problems you may encounter with the Crystal Series LCD. If the suggested solutions fail to resolve the problem or if you encounter an issue not described here, please contact your Runco dealer or Runco Technical Support.

Table 5-1. Troubleshooting Chart

Symptom	Possible Cause(s)	Solution
The display does not turn on after initial installation.	<ul style="list-style-type: none">The Crystal Series LCD is not plugged in or the AC outlet is not active.The remote control batteries have run out.	<ul style="list-style-type: none">Ensure that the Crystal Series LCD is plugged in and that the AC outlet is active.Replace the batteries.
The display is on, but there is no picture.	<ul style="list-style-type: none">Incorrect source selection.Source component is not turned on.Source component is connected incorrectly or not at all.	<ul style="list-style-type: none">Select the correct source.Turn on the source component.Check video connections to source component.

5.1 Cleaning

◀ *Cleaning the Display Panel Body and Remote Control*

◀ *Cleaning the Screen*

◀ *Cleaning the Vents*

5.2 Troubleshooting Tips

Table 5-1. Troubleshooting Chart (continued)

Symptom	Possible Cause(s)	Solution
Picture is okay, but there is no sound.	<ul style="list-style-type: none"> • Audio output is muted. • Volume setting is too low. • Source component is connected incorrectly or not at all. • Speakers are connected incorrectly or not at all. • Audio settings are incorrect. 	<ul style="list-style-type: none"> • Press the MUTE button on the remote control. • Turn up the volume. • Check audio connections to source component. • Check speaker connections (Figure 3-6). • Check the following settings: Speaker (page 34) and HDMI Audio Input (page 36). For HDMI audio sources, ensure that the audio output format is "PCM" (refer to the manual for the source component).
Image is too bright and/or lacks definition in the bright areas of the image.	<ul style="list-style-type: none"> • Contrast is set too high. 	<ul style="list-style-type: none"> • Lower the contrast setting.
Image appears "washed out" and/or dark areas appear too bright.	<ul style="list-style-type: none"> • Brightness is set too high. 	<ul style="list-style-type: none"> • Lower the brightness setting.
Colors in the image are swapped; for example, reds appear blue or vice versa.	<ul style="list-style-type: none"> • The Red/Pr, Green/Y or Blue/Pb outputs from the source are connected to the wrong inputs on the Crystal Series LCD. 	<ul style="list-style-type: none"> • Ensure that the source outputs are connected to the correct Crystal Series LCD input.
RGB-HD images appear "noisy."	<ul style="list-style-type: none"> • Clock and Phase settings need adjustment. 	<ul style="list-style-type: none"> • Manually adjust Clock and Phase settings, or perform an Auto-Adjust (refer to PC Mode Adjust on page 35).
"Invalid mode" appears on-screen.	<ul style="list-style-type: none"> • The resolution and frequency of the video card in the computer are not compatible with the Crystal Series LCD. 	<ul style="list-style-type: none"> • Select a compatible resolution and vertical frequency (refer to Supported Timings on page 59).
The image is too large or too small.	<ul style="list-style-type: none"> • Image size needs adjusting. 	<ul style="list-style-type: none"> • Adjust the image size (refer to PC Mode Adjust on page 35).

6. Serial Communications

To interface the Crystal Series LCD with a home theater automation/control system or a PC running terminal emulation software (such as HyperTerminal, provided with Microsoft® Windows™), connect it to your control system or PC as shown in Figure 3-9. **Use a straight-through cable.**

Configure the RS-232 controller or PC serial port as follows: no parity, 8 data bits, 1 stop bit and no flow control. Set the baud rate to match that of the Crystal Series LCD RS-232 port. To check the baud rate setting, select Baud Rate from the Setup menu (refer to page 37).

- Commands are in ASCII format and are not case-sensitive.
- A carriage return is not required after a command.
- To send a command from a PC running terminal emulation software, create a text file containing that command. Then, use the file transfer function in your terminal emulation program to send the command. (If you are using HyperTerminal, choose “Send Text File...” from the Transfer menu.)
- When you send a valid command, the Crystal Series LCD executes it and acknowledges it with a right-bracket character (]) followed by the four-digit numeric code you sent; for example,] 0002.
- When you send an invalid command (one followed by values outside the valid range for that command), the Crystal Series LCD ignores it and returns >MAX or <MIN instead of the four-digit code.
- When you send an unrecognized/misspelled command, the Crystal Series LCD ignores it and returns -N/A instead of the four-digit code.

Table 6-1 lists the RS-232 command set.

Table 6-1. Serial Commands

Command			Description
[S3A	0###	Set audio volume to ### (= 000-100)
<i>Example:</i> [S3A0075 sets volume to 75			
[+3A		Audio volume up
[-3A		Audio volume down
[S3E	000#	Audio mute 0 = not muted, 1 = muted
<i>Example:</i> [S3E0001 mutes the audio output			

6.1 RS-232 Connection and Port Configuration

6.2 Serial Command Syntax

Table 6-1. Serial Commands (continued)

Command			Description
[S4A	000#	Main input selection 1 = Video 1 2 = Video 2 3 = Component 1/SCART 4 = Component 2 5 = HDMI 3 6 = RGB 7 = HDMI 4 8 = HDMI 1 9 = HDMI 2
<i>Example:</i> [S4A0006 selects RGB			
[+4A		Select "next" Main AV input
[S4E	000#	Aspect ratio selection 0 = 4:3 1 = VirtualWide 2 = Letterbox 3 = 16:9
<i>Example:</i> [S4E0002 selects Letterbox			
[S4G	000#	PIP Input selection 1 = Video 1 2 = Video 2 3 = Component 1/SCART 4 = Component 2 5 = HDMI 3 6 = RGB 7 = HDMI 4 8 = HDMI 1 9 = HDMI 2
<i>Example:</i> [S4G0003 selects PIP Component 1 or SCART			
[+4G		Select "next" PIP AV input
[SAB	000#	Power on/off control 0 = standby, 1 = on
<i>Example:</i> [SAB0001 turns unit on			
[SDA	000#	Set PIP mode 0 = OFF 1 = PIP 2 = PBP
<i>Example:</i> [SDA0002 selects PBP			
[SDB	000#	Set PIP size 0 = small 1 = medium 2 = large
<i>Example:</i> [SDB0001 selects medium PIP size			

Table 6-1. Serial Commands (continued)

Command			Description
[SDE	000#	Set PIP aspect ratio 0 = 4:3 1 = 16:9
<i>Example:</i> [SDE0001 selects 16:9 aspect ratio PIP window			
[SDF	000#	Set PIP window position 0 = Top/Left 1 = Top/Right 2 = Bottom/Left 3 = Bottom/Right
<i>Example:</i> [SDF0001 positions PIP window in upper-right corner of display area			
<p>The following serial commands are meant to emulate buttons on the remote control. Each button has its own serial command, so effectively it is as if you were using the IR remote only you'll be doing so via serial commands. These commands provide active OSD responses just like the IR remote.</p> <p>Each command begins with [key followed by the four-digit number of the button. No carriage return is necessary. The response you receive from the unit if the command is valid will be a right-bracket (]) followed by the four-digit numeric code you sent. (For example, the 'ON' command is [key0015; the response will be])0015). All commands are in ASCII.</p>			
[key	0002	OFF
		0015	ON
[key	0004	Number 1
		0005	Number 2
		0006	Number 3
		0008	Number 4
		0009	Number 5
		0010	Number 6
		0012	Number 7
		0013	Number 8
		0014	Number 9
		0035	Number 100
		0017	Number 0
[key	0102	HDMI 1
		0101	HDMI 2
		0093	HDMI 3
		0094	HDMI 4
		0028	Component 1/SCART

Table 6-1. Serial Commands (continued)

Command			Description
		0001	Component 2
		0019	RGB
		0105	Video 1
		0027	Video 2
[key	0003	CUSTOM
		0062	ISF NIGHT
		0031	ISF DAY
[key	0040	16:9
		0043	4:3
		0039	LETTERBOX
		0126	VIRTUALWIDE
[key	0007	Right-Arrow key
		0016	Down-Arrow key
		0018	Up-Arrow key
		0011	Left-Arrow key
		0046	ENTER
[key	0026	MENU
[key	0100	EXIT
[key	0036	PIP SRC
		0047	PIP SIZE
		0034	PIP POSITION
		0032	PIP
		0037	TIMER OFF
		0033	SWAP
[key	0091	MUTE
		0055	INFO
		0084	AUDIO 1
		0085	AUDIO 2
		0086	AUDIO 3
[key	0087	BRIGHT +

Table 6-1. Serial Commands (continued)

Command		Description
	0088	BRIGHT -
	0089	CONTR +
	0090	CONTR -

To personalize the start-up splash screen with the customer name, Runco dealer name or any other string (up to 28 characters long), send the following commands:

- [c#####] to program the customer name or other string (represented by #####)
- [d#####] to program the dealer name or other string (represented by #####)

To send a command from a PC running terminal emulation software, create a text file containing that command. Then, use the file transfer function in your terminal emulation program to send the command. (If you are using HyperTerminal, choose "Send Text File..." from the Transfer menu.)

When you do, the Crystal Series LCD echoes the string back to the control system or PC, enclosed in quotes (for example, "Runco Customer"). If it doesn't, verify that you sent the command correctly.

To see the changes take effect, cycle power to the Crystal Series LCD.

For example, sending the commands [cRunco Customer] and [dBy: Runco Dealer] causes the splash screen to look like this:



◀ Personalizing the Splash Screen Using Serial Commands

Notes:

7. Specifications

Table 7-1 lists the Crystal Series LCD specifications.

Table 7-1. Crystal Series LCD Specifications

Native Resolution:	1920 x 1080
Screen Size:	CX-47HD/CX-OPAL47 = 47 in. (diagonal) CX-65HD = 65 in. (diagonal)
Screen Aspect Ratio:	16:9
Available Aspect Ratios:	4:3, Letterbox, 16:9, VirtualWide™
DTV Compatibility:	480i/p, 576i/p, 720p, 1080i, 1080p
ISF Settings:	Yes
Contrast Ratio:	CX-47HD/CX-OPAL47 = 3000:1 CX-65HD = 2000:1
Data/Graphics Compatibility:	Refer to Table 7-2
Response Time (typical):	4 milliseconds
Vivix Processing:	3:2 or 2:2 pull down
Video/Audio Inputs:	Multiple input combinations with up to (2) Composite Video (1) S-Video (2) Component Video (4) HDMI 1.3a w/HDCP (1) RGB (15-pin D-sub) (5) Analog Audio (4 stereo RCA pairs + 3.5-mm stereo mini jack)
Control Inputs:	(1) RS-232 (9-pin D-sub) (1) Wired IR (3.5-mm mono mini jack)
Outputs:	(1) Digital Audio (S/PDIF optical) (1) Stereo Speakers
Audio System:	10W RMS x 2 Stereo Amplifier
Discrete IR Control:	Source, power and aspect ratios
Power Requirements:	100 to 240 VAC, 50/60Hz
Power Consumption (typical):	CX-47HD/CX-OPAL47 = 350 watts (1194.5 BTUs/hour); 5 watts in standby mode CX-65HD = 640 watts (2184.3 BTUs/hour); 8 watts in standby mode
Operating Environment:	40°F to 95°F (5°C to 35°C); 20% to 80% humidity (non-condensing); Altitude = 9,842 feet (3,000 meters)
Dimensions:	CX-47HD/CX-OPAL47 = see Figure 7-1 and Figure 7-2 CX-65HD = see Figure 7-3 and Figure 7-4

7.1 Crystal Series LCD Specifications

Table 7-1. Crystal Series LCD Specifications (continued)

Weight (including stand):	CX-47HD/CX-OPAL47 = 121.3 lbs. (55.00 kg) CX-65HD = 220.5 lbs. (100.00 kg)
Regulatory Approvals:	Complies with UL, FCC, CE, RoHS, C-Tick, NOM, GOST
Limited Warranty:	Two (2) years parts and labor from the date of delivery to the end user.
Specifications are subject to change without notice.	

Figure 7-1, Figure 7-2, Figure 7-3 and Figure 7-4 show the Crystal Series LCD dimensions (all dimensions are in millimeters).

7.2 Crystal Series LCD Dimensions

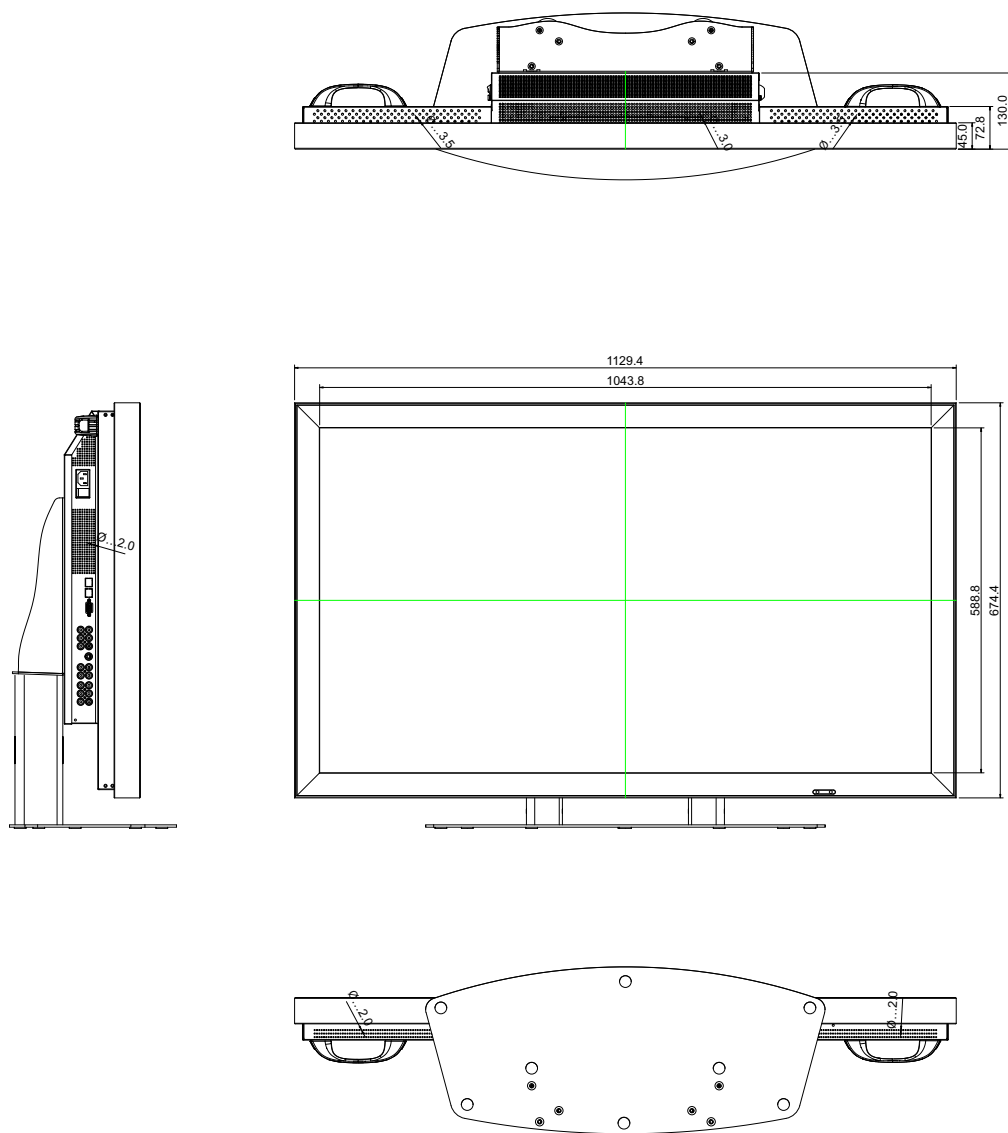

Figure 7-1. CX-47HD/CX-OPAL47 Dimensions (Top/Front)

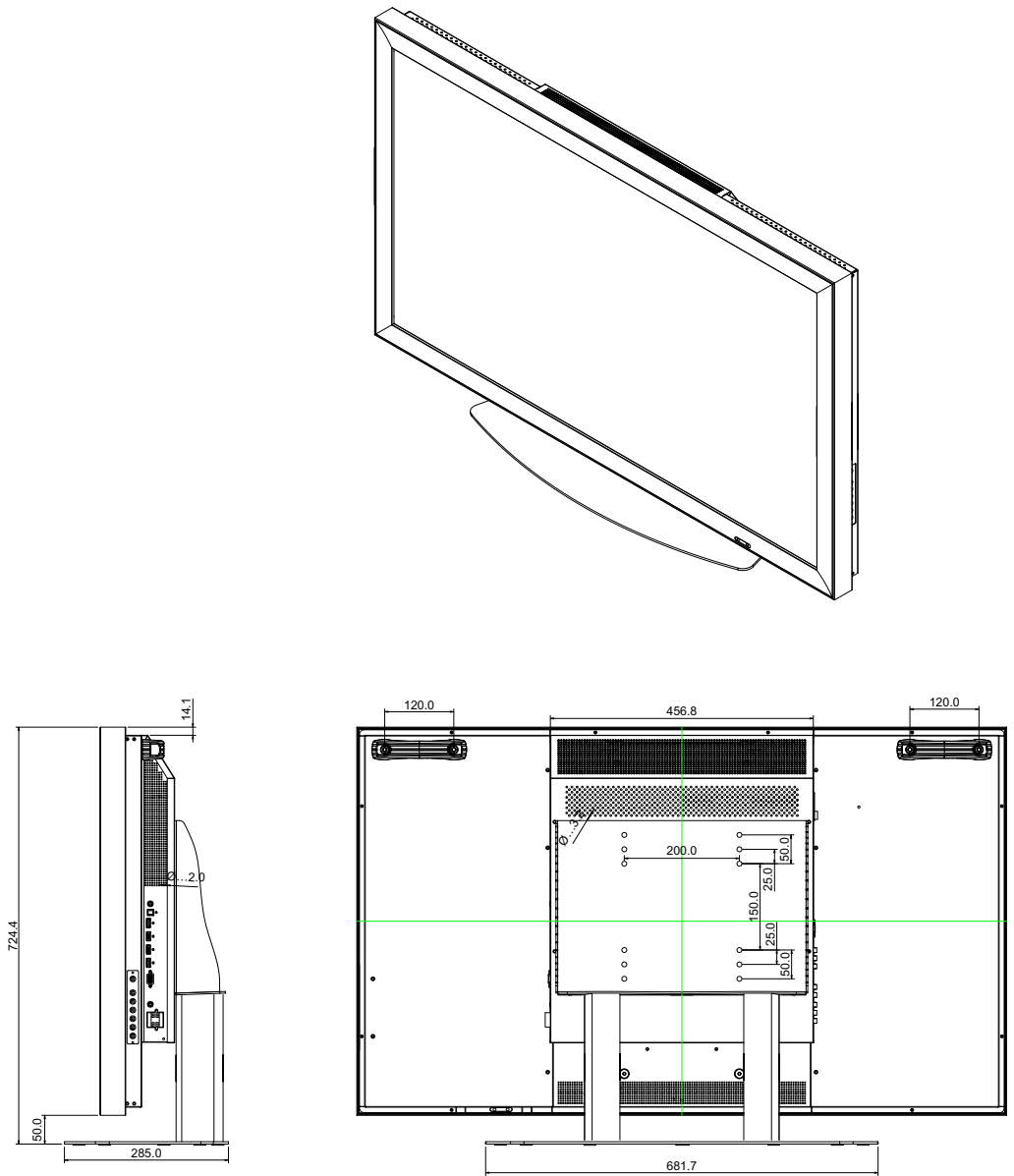

Figure 7-2. CX-47HD/CX-OPAL47 Dimensions (Rear/Side)

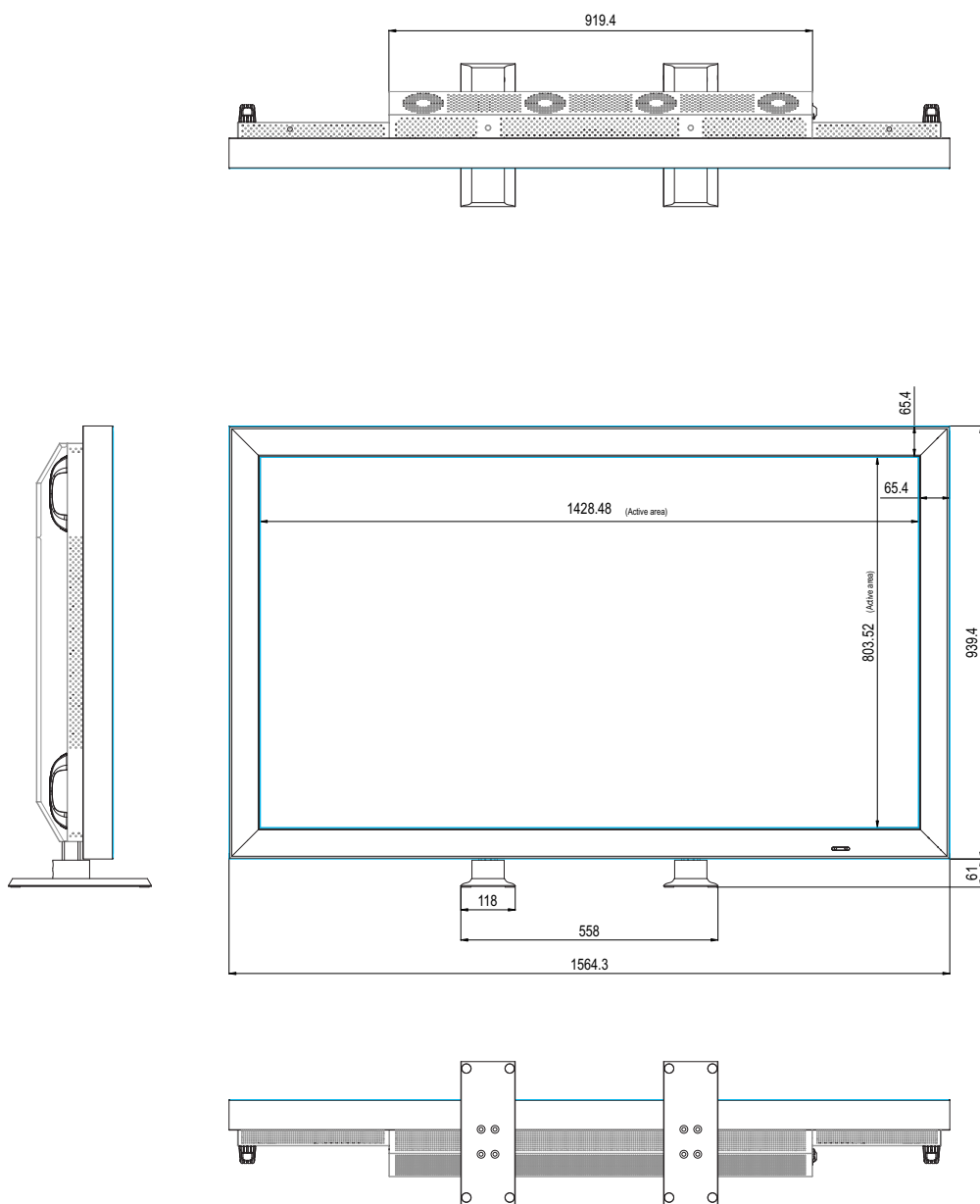

Figure 7-3. CX-65HD Overall Dimensions (Top/Front)

Table 7-2 lists the signal types supported by each input on the Crystal Series LCD.

7.3 Supported Timings

Table 7-2. Supported Signal Timings by Input

Format	Resolution	Refresh Rate (Hz)	Horizontal Frequency (kHz)	Pixel Frequency (MHz)	Supported? (√ = Yes, – = No)			
					RGB	Component 1 Component 2	HDMI 1 HDMI 2 HDMI 3 HDMI 4	Video 1 Video 2 S-Video SCART
640x480	640x480	60.00	31.469	25.175	√	–	√	–
		72.00	37.861	31.500	√	–	√	–
		75.00	37.500	31.500	√	–	√	–
		85.00	43.269	36.000	√	–	√	–
800x600	800x600	60.00	37.879	40.000	√	–	√	–
		72.00	48.077	50.000	√	–	√	–
		75.00	46.875	49.500	√	–	√	–
		85.00	53.674	56.250	√	–	√	–
1024x768	1024x768	60.00	48.363	65.000	√	–	√	–
		70.00	56.476	75.000	√	–	√	–
		75.00	60.023	78.750	√	–	√	–
		85.00	68.677	94.500	√	–	√	–
1152x864	1152x864	75.00	67.500	108.000	√	–	√	–
1280x768	1280x768	60.00	47.400	68.250	√	–	√	–
		60.00	47.776	79.500	√	–	√	–
		75.00	60.289	102.250	√	–	√	–
		85.00	68.633	117.500	√	–	√	–
1280x960	1280x960	60.00	60.000	108.000	√	–	√	–
		85.00	85.938	148.500	√	–	√	–
1280x1024	1280x1024	60.00	63.981	108.000	√	–	√	–
		75.00	79.976	135.000	√	–	√	–
		85.00	91.146	157.500	√	–	√	–
1360x768	1360x768	60.00	47.720	84.750	√	–	√	–
1400x1050	1400x1050	60.00	64.700	101.000	√	–	√	–
		60.00	65.317	121.750	√	–	√	–
		75.00	82.300	156.000	√	–	√	–
1600x1200	1600x1200	60.00	75.000	162.000	√	–	√	–

Table 7-2. Supported Signal Timings by Input (continued)

Format	Resolution	Refresh Rate (Hz)	Horizontal Frequency (kHz)	Pixel Frequency (MHz)	Supported? (√ = Yes, – = No)			
					RGB	Component 1 Component 2	HDMI 1 HDMI 2 HDMI 3 HDMI 4	Video 1 Video 2 S-Video SCART
1920x1200	1920x1200	60.00	74.000	154.000	√	–	√	–
480/60i	712x484	29.97	15.734	13.500	√	√	√	√
480/60p	720x483	59.94	31.469	27.000	√	√	√	–
576/50i	720x576	50.00	15.625	13.500	√	√	√	–
576/50p	720x576	50.00	31.250	27.000	√	√	√	–
720/50p	1280x720	50.00	37.500	74.250	√	√	√	–
720/60p	1280x720	59.94	44.964	74.250	√	√	√	–
1080/24i	1920x1080	24.00	26.997	74.250	√	√	√	–
1080/25i	1920x1080	25.00	28.125	74.250	√	√	√	–
1080/30i	1920x1080	30.00	33.749	74.250	√	√	√	–
1080/24p	1920x1080	24.00	26.990	74.250	–	–	√	–
1080/25p	1920x1080	25.00	28.200	74.250	√	√	√	–
1080/30p	1920x1080	30.00	33.750	74.250	√	√	√	–
NTSC 3.58	–	59.94	15.734	3.580	–	–	–	√
NTSC 4.43	–	59.94	15.734	4.430	–	–	–	√
PAL	702x574	50.00	15.625	13.500	√	√	√	√
SECAM	–	50.00	15.625	13.500	–	–	–	√



SERIAL NUMBER
020-0969-00 Rev. B
January 2009