



Dear VIZIO Customer,

Congratulations on your new VIZIO VP504 FHDTV10A High Definition PLASMA Television purchase. Thank you for your support. For maximum benefit of your set, please read these instructions before making any adjustments, and retain them for future reference. We hope you will experience many years of enjoyment from your new VIZIO VP504 FHDTV10A High Definition Television.

For assistance, please call **(877)-698-4946** or e-mail us at techsupport@vizio.com.

To purchase or inquire about accessories and installation services for your VIZIO PLASMA HDTV, please visit our website at www.vizio.com or call toll free at **(888)-849-4623**.

We recommend you register your VIZIO VP504 FHDTV10A either at our website www.VIZIO.com or fill in your registration card and mail it in. For peace of mind and to protect your investment beyond the standard warranty, VIZIO offers on-site extended warranty service plans. These plans give additional coverage during the standard warranty period. Visit our website or call us to purchase a plan.

Write down the serial number located on the back of your VP504 FHDTV10A.

Purchase Date _____

*VIZIO is a registered trademark of VIZIO, Inc. dba V, Inc.
HDMI logo and "High Definition Multimedia Interface" are registered trademarks of HDMI Licensing LLC.
Manufactured under license from Dolby Laboratories.
Dolby and the double-D symbol are trademarks of Dolby Laboratories.*



Important Safety Instructions

This product is designed and manufactured to operate within defined design limits, and misuse may result in electric shock or fire. To prevent the product from being damaged, the following rules should be observed for the installation, use and maintenance of the product. Read the following safety instructions before operating the display. Keep these instructions in a safe place for future reference.

- To reduce the risk of electric shock or component damage, switch off the power before connecting other components to the VP504 FHDTV10A.
- Unplug the power cord before cleaning the VP504 FHDTV10A LCD. A damp cloth is sufficient for cleaning the VP504 FHDTV10A. Do not use a liquid or a spray cleaner for cleaning the product. Do not use abrasive cleaners.
- Always use the accessories recommended by the manufacturer to insure compatibility.
- When moving the VP504 FHDTV10A from an area of low temperature to an area of high temperature, condensation may form on the housing. Do not turn on the VP504 FHDTV10A immediately after this to avoid causing fire, electric shock or component damage.
- Do not place the VP504 FHDTV10A on an unstable cart, stand, or table. If the VP504 FHDTV10A falls, it can injure a person and cause serious damage to the appliance. Use only a cart or stand recommended by the manufacturer or sold with the VP504 FHDTV10A.
- A distance of at least 3 feet should be maintained between the VP504 FHDTV10A and any heat source, i.e. radiator, heater, oven, amplifier etc. Do not install the product close to smoke. Operating the product close to smoke or moisture may cause fire or electric shock.
- Slots and openings in the back and bottom of the cabinet are provided for ventilation. To ensure reliable operation of the VP504 FHDTV10A and to protect it from overheating, be sure these openings are not blocked or covered. Do not place the VP504 FHDTV10A in a bookcase or cabinet unless proper ventilation is provided.
- Never push any object into the slot on the VP504 FHDTV10A cabinet. Do not place any objects on the top of the product. It could short circuit parts causing a fire or electric shock. Never spill liquids on the VP504 FHDTV10A.
- The VP504 FHDTV10A should be operated only from the type of power source indicated on the label. If you are not sure of the type of power supplied to your home, consult your dealer or local power company.
- The power cable must be replaced when using different voltage from that specified in the User Manual. For more information, contact your dealer.
- The VP504 FHDTV10A is equipped with a **three-pronged grounded plug, a plug with a third (grounding) pin**. This plug will fit only into a grounded power outlet as a safety feature. If your outlet does not accommodate the three-wire plug, have an electrician install the correct outlet, or use an adapter to ground the appliance safely.

Do not defeat the safety purpose of the grounded plug.

- Appliance inlet (or AC inlet) is used as the disconnect device.
- Use only with the cart, stand, tripod, bracket or table specified by manufacturer, or sold with the apparatus. When a cart is used, use caution when moving the cart/apparatus combination to avoid injury from tip-over.



- The lightning flash with arrowhead symbol, within an equilateral triangle, is intended to alert the user to the presence of not isolated dangerous voltage within the inside of the product that may be sufficient magnitude to constitute a risk of electric shock to persons.
- The exclamation point within an equilateral triangle is intended to alert the user to the presence of important operating and servicing instructions in the literature to

accompanying the appliance.

- Do not overload power strips and extension cords. Overloading can result in fire or electric shock.
- The wall socket shall be installed near the equipment and shall be easily accessible.
- Only the marked power source can be used for the product. Any power source other than the specified one may cause fire or electric shock.
- Do not touch the power cord during lightning. To avoid electric shock, avoid handling the power cord during electrical storms.
- Unplug the unit during a lightening storm or when it will not be used for long period of time. This will protect the VP504 FHDTV10A from damage due to power surges.
- Do not attempt to repair or service the product yourself. Opening or removing the back cover may expose you to high voltages, the risk of electric shock, and other hazards. If repair is required, please contact your dealer and refer all servicing to qualified service personnel.
- Keep the product away from moisture. Do not expose this appliance to rain or moisture. If water penetrates into the product, unplug the power cord and contact your dealer. Continuous use in this case may result in fire or electric shock.
- Do not use the product if any abnormality occurs. If any smoke or odor becomes apparent, unplug the power cord and contact your dealer immediately. Do not try to repair the product yourself.
- Avoid using dropped or damaged appliances. If the product is dropped and the housing is damaged, the internal components may function abnormally. Unplug the power cord immediately and contact your dealer for repair. Continued use of the product may cause fire or electric shock.
- Do not install the product in an area with heavy dust or high humidity. Operating the product in environments with heavy dust or high humidity may cause fire or electric shock.
- Follow instructions for moving the product. Ensure that the power connector and any other cables are unplugged before moving the product.
- Hold the power connector when removing the power cable. Pulling the power cable itself may damage the wires inside the cable and cause fire or electric shock. When the product will not be used for an extended period of time, unplug the power connector.
- To reduce risk of electric shock, do not touch the connector with wet hands.



- Insert batteries in accordance with instructions. Incorrect polarities may cause damage and leakage of the batteries, operator injury and contamination the remote controller.
- If any of the following occurs please contact the dealer:
 - The power connector fails or frays.
 - Liquid sprays or any object drops into the VP504 FHDTV10A.
 - The Display is exposed to rain or other moisture.
 - The Display is dropped or damaged in any way.
 - The performance of the Display changes substantially.
- Operating environment. Temperature: 40°F ~ 95°F, Humidity: 20% ~ 80% non-condensing, Altitude: 0 ~ 6500ft (0 ~ 2000m)

Television Antenna Connection Protection

External Television Antenna Grounding

If an outside antenna/satellite dish or cable system is to be connected to the TV, make sure that the antenna or cable system is electrically grounded to provide some protection against voltage surges and static charges.

Article 810 of the National Electrical Code, ANSI/NFPA 70, provides information with regard to proper grounding of the mast and supporting structure, grounding of the lead-in wire to an antenna discharge unit, size of the grounding conductors, location of antenna discharge unit, connection to grounding electrodes, and requirements of the grounding electrode.

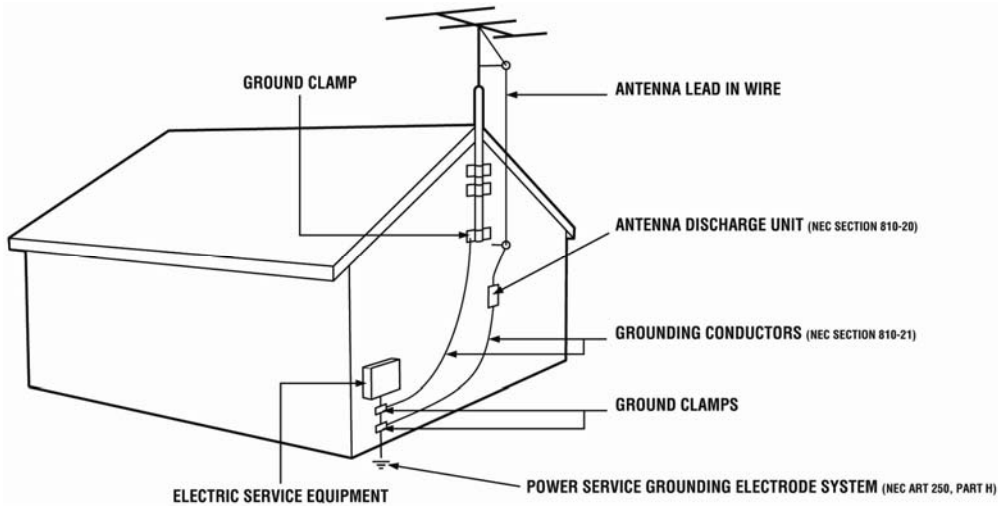

Lightning Protection

For added protection of the TV during a lightning storm or when it is left unattended or unused for long periods of time, unplug the TV from the wall outlet and disconnect the antenna or cable system.

Power Lines

Do not locate the antenna near overhead light or power circuits, or where it could fall into such power lines or circuits.

Remember, the screen of the coaxial cable is intended to be connected to earth in the building installation.



Opening the Package

Your VIZIO VP504 FHDTV10A and its accessories are carefully packed in a cardboard carton that has been designed to protect it from transportation damage. Now you have opened the carton check that the VP504 FHDTV10A is in good condition and that all of the accessories are included.

The VP504 FHDTV10A weighs approximately 96lb and is about 50" wide; please exercise care when unpacking the HDTV.

The screen can easily be scratched or broken so please handle the product gently and never place the HDTV with the glass facing downwards on a surface without protective padding.

IMPORTANT: Save the carton and packing material for future shipping.

Package Contents

VIZIO VP504 FHDTV10A

VIZIO Remote Control VUR8P

HDMI Cable

VIZIO TV Stand

Premium Size VIZIO Screen Cleaning Cloth

Power Cord

This User Manual

Quick Setup Guide

Registration Card

VIP Services Brochure

2 AA Batteries for the Remote Control

VIZIO Warranty and Repair Information



Additional Certified Accessories for the VIZIO VP504 FHDTV10A are sold separately

Wall Mounts

High Definition Cables

Extra or replacement Remote

VIZIO also offers Installation Services and Extended Warranty Services for your VIZIO VP504 FHDTV10A

To purchase or inquire about additional accessories and services for your VIZIO product, visit our web site at www.VIZIO.com or call us toll free at 888-VIZIOCE (888-849-4623)

Installation Preparation

Please read this user manual carefully before installing your VIZIO HDTV.

The power consumption of the TV is up to 700W, please use the power cord designated for TV. When an extension cord is required, use one with the correct power rating. The cord must be grounded and the grounding feature must not be defeated.

The TV should be installed on a flat surface to avoid tipping. For proper ventilation, you must allow space between the back of the TV and the wall. If you would like to mount your TV on the wall, please see below 'Preparing Your PLASMA HDTV for Wall Mounting' for additional information. Avoid installing the TV in places with high humidity, dust or smoke so as not to shorten the service life of the electronic components.

Install the TV in landscape orientation; any 90° clockwise or counter-clockwise installation may induce poor ventilation and excessive component damage.

The VIZIO VP504 FHDTV10A can either be kept on the stand base or mounted on the wall for viewing. If you choose to mount the VP504 FHDTV10A on the wall, please refer to "preparing your PLASMA HDTV for wall mounting" on page 6.

VIZIO offers professional installation services. Please contact VIZIO for more information on these services at 888-VIZIOCE (888-849-4623) or www.VIZIO.com.

Attaching the Safety Strap

For when the VP504 FHDTV10A is not mounted on the wall with a Wall Mount, a Safety Strap has been included to attach the HDTV to the wall to reduce the chance of the HDTV being pulled over. The Safety Strap should be used with common sense practice such as ensuring that children (or adults) do not climb up, grabbing the top of the HDTV and pulling it onto themselves.

1. Fix one end of the strap to the wall. If you have a drywall finish it is preferable to fix it to a stud, using a washer underneath the screw head. If you have a solid wall you should use a lag bolt, again using a washer under the nut.



2. Fix the other end of the Safety Strap to one of the upper wall mounting holes on the back of the HDTV, using a washer under the screw head.



Preparing Your PLASMA HDTV for Wall Mounting

To remove the stand base

1. Unplug all of the cables and cords from your VIZIO VP504 FHDTV10A.
2. Place the VP504 FHDTV10A face down on a soft and flat surface (blanket, foam, cloth, etc) to prevent any damage to the TV.
3. Remove the cover on the stand.
4. Remove the six (6) screws holding the base to the VP504 FHDTV10A.
5. Carefully remove the stand base.



Now, the VP504 FHDTV10A can fit securely to a mount (sold separately) by utilizing the mounting holes in the center of the back panel of the High Definition TV. Please make sure to read the instructions of your specific mount to properly hang the VP504 FHDTV10A.

The pitch of the mounting holes is 600mm horizontally and 200mm vertically.

The screw type required is metric M8, 20mm long, 1.25mm pitch. The length of the screws will depend on the thickness plate being attach to the TV; our brackets come with different length screws.

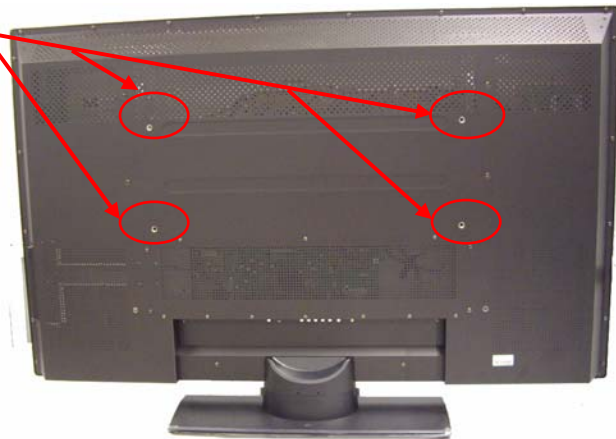

To find the perfect mount for the VIZIO VP504 FHDTV10A, browse VIZIO's certified mount selection at www.VIZIO.com or call directly 888-VIZIOCE (888-849-4623).



Table of Contents

Chapter 1 Basic Controls and Connections	9
1.1 Front Panel.....	9
1.2 Side Panel Controls.....	9
1.3 Rear Panel Connections	10
1.4 Right-Side Panel Connection	11
1.5 VIZIO Universal Remote Control.....	12
1.5.1 Insertion of Batteries in the Remote Control.....	15
1.5.2 Remote Control Range	15
1.5.3 VIZIO Universal Remote Control Precautions	15
Chapter 2 Connecting Equipment	16
2.1 Which Video Connection Should I Use?.....	16
2.2 Connecting Coaxial (RF).....	17
2.2.1 Using Your Antenna or Digital Cable for DTV.....	17
2.2.2 Using the Antenna or Cable through your VCR	17
2.3 Connecting Your HDTV Set-Top Box.....	18
2.3.1 Using HDMI Input	18
2.3.2 Using Component Video.....	20
2.4 Connecting Your Basic Set-Top Box.....	21
2.4.1 Using Composite Video	21
2.4.2 Using Coax (RF).....	21
2.5 Connecting Your DVD Player.....	22
2.5.1 Using HDMI Input	22
2.5.2 Using Component Video.....	24
2.5.3 Using S-Video (AV/S-VIDEO).....	25
2.5.4 Using Composite (AV) Video Input	25
2.6 Connecting Your VCR or Video Camera.....	26
2.7 Connecting an external Receiver/Amp.....	27
2.7.1 Optical Output of Audio received	28
2.8 Connecting a PC Computer	29
2.8.1 Preset PC Resolutions.....	30
2.8.2 Resolution (1920x1080) through RGB (15-Pin VGA) Input.....	30
Chapter 3 Setting Up to Watch Television	31
3.1 Basic PLASMA HDTV Start Up	31
3.2 Watching a TV Program	36
3.3 Adjusting Basic HDTV Settings	37
3.4 Program Information.....	38
3.5 Information on HDTV Status	38
Chapter 4 Advanced Adjustment of HDTV	39
4.1 Using the On Screen Display (OSD)	39
4.2 DTV / TV Input Picture Adjustment.....	40
4.2.1 Picture Mode	40
4.2.2 Brightness.....	40
4.2.3 Contrast.....	41
4.2.4 Color.....	41
4.2.5 Tint.....	41
4.2.6 Sharpness	42
4.2.7 Advanced Video Features	42
4.2.8 Reset Picture Mode	43
4.3 DTV / TV Input Audio Adjustment.....	44
4.3.1 Audio Mode	44
4.3.2 Equalizer.....	44
4.3.3 Balance.....	45
4.3.4 Surround.....	45
4.3.5 Digital Audio Out.....	45
4.3.6 Speakers	45
4.3.7 Audio Out.....	46
4.3.8 Lip Sync.....	46
4.3.9 Reset Audio Mode	46
4.4 DTV / TV Tuner Setup.....	47
4.4.1 Tuner Mode	47



4.4.2 Auto Search.....	47
4.4.3 Partial Channel Search.....	48
4.4.4 Skip Channel.....	48
4.4.5 MTS.....	48
4.4.6 Time Zone.....	48
4.4.7 Daylight Saving.....	49
4.5 DTV / TV Input Setup.....	50
4.5.1 Language.....	50
4.5.2 PIP (Picture-in-Picture).....	50
4.5.3 Adjusting Basic PIP Settings.....	52
4.5.4 Sleep Timer.....	53
4.5.5 Wide.....	53
4.5.6 Input Naming.....	54
4.5.7 CC (Closed Caption).....	55
4.5.8 H/V Position.....	56
4.5.9 DTV / TV Input Parental Control.....	57
4.5.10 Channel Block.....	57
4.5.11 US TV Rating.....	58
4.5.12 US Movie Rating (For US).....	59
4.5.13 Canadian English Rating.....	59
4.5.14 Canadian French Rating.....	60
4.5.15 DTV Rating.....	60
4.5.16 Blocked Unrated Programming.....	61
4.5.17 Change the Password.....	61
4.5.18 Reset All Settings.....	62
4.5.19 Image Cleaner.....	62
4.6 HDMI Input Picture Adjustment.....	63
4.7 HDMI Input Audio Adjustment.....	63
4.8 HDMI Input Setup.....	63
4.9 Video Input Picture Adjustment.....	64
4.10 Video Input Audio Adjustment.....	64
4.11 Video Input Setup.....	64
4.11.1 Auto Phase (for Component input).....	65
4.12 Video Input Parental Control.....	66
4.13 PC Input Picture Adjustment.....	66
4.13.1 Auto Adjust.....	66
4.13.2 Brightness.....	66
4.13.3 Contrast.....	67
4.13.4 Color Temperature.....	68
4.13.5 H-SIZE.....	68
4.13.6 H. Position.....	68
4.13.7 V. Position.....	69
4.13.8 Fine Tune.....	69
4.14 PC Input Audio Adjustment.....	69
4.15 PC Input Setup.....	69
4.16 Understanding Viewing Features.....	70
4.16.1 Viewing Modes.....	70
Chapter 5 Maintenance and Troubleshooting.....	71
5.1 Maintenance.....	71
5.2 Troubleshooting Guide.....	71
5.3 Telephone & Technical Support.....	74
5.4 Compliance.....	75
5.5 FCC Class B Radio Interference Statement.....	75
Chapter 6 Miscellaneous Information.....	76
6.1 Specifications.....	76
6.2 Glossary – Standard Definitions.....	77
6.3 Index.....	78
6.4 Component Program Codes.....	80



Chapter 1 Basic Controls and Connections

1.1 Front Panel

POWER ‘VIZIO’ LIGHT– The VIZIO name lights white when powered on and orange when powered off.

REMOTE CONTROL SENSOR – This is the window through which all of the remote control signals pass to the sensor. Point the remote control directly at this window for the best response to the remote signal.

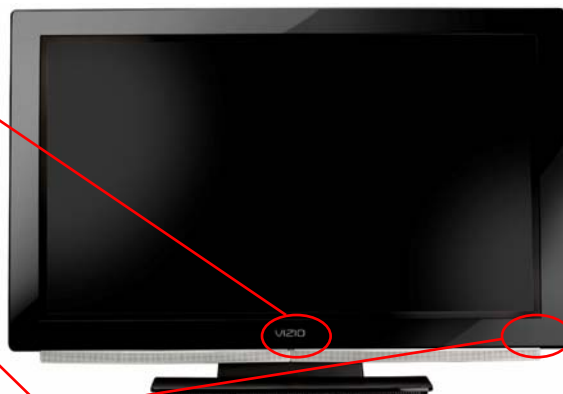

1.2 Side Panel Controls

POWER (⏻) – Switch the VP504 FHDTV10A on by pressing the button once. Press the button again to the VP504 FHDTV10A off.

MENU – This button activates the On Screen Display (OSD). If a sub-menu is active, pressing this button will return to the previous menu level.

CH + / - – Use these buttons to step up or down the TV channels. While the OSD is active, these buttons function as up and down controls in the OSD menus.

VOL + / - – Use these buttons to increase or decrease to the speaker volume. While the OSD is active, these buttons function as left and right controls in the OSD menus.

INPUT (ENTER) – Repeated pressing of this buttons steps through the input sources in the following sequence: TV, AV/S-Video, Component, RGB, HDMI 1, HDMI 2, HDMI 3 and HDMI 4. Once you have stepped through the entire sequence, you will return to the beginning.

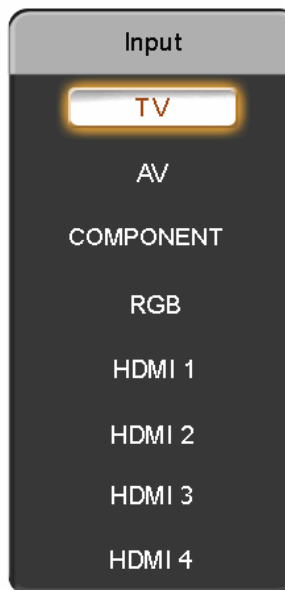

Additionally, when the OSD is active, this button confirms the menu function to be adjusted. When the OSD is not active, pressing this button will display the current input mode.



1.3 Rear Panel Connections

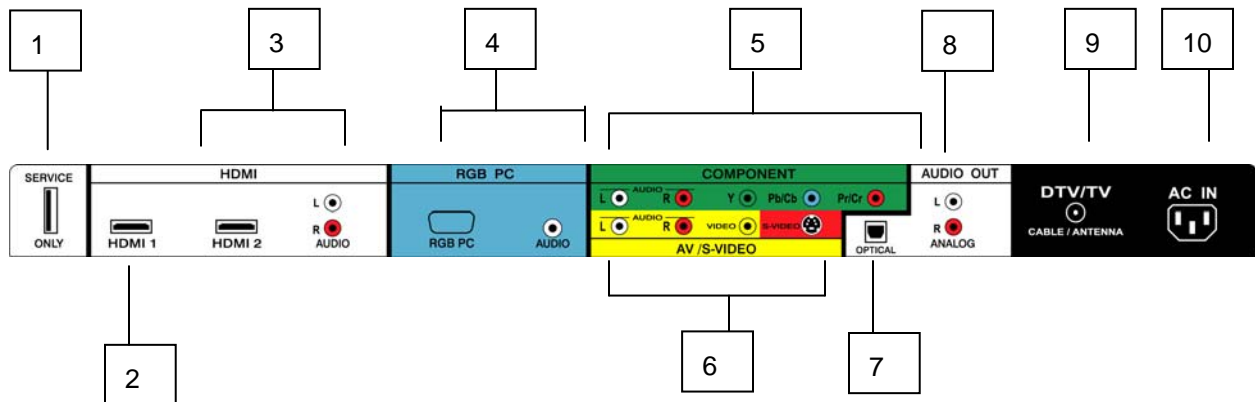

1. **SERVICE** – This custom communication port is for factory service only. **Use of this input for any purpose other than factory authorized service will void the manufacturer's warranty of this equipment.**
2. **HDMI 1** – Connect the primary source for digital video such as a DVD multimedia player or set top box through this all digital connector. The white color band on the rear of the TV indicates this connection.
3. **HDMI 2** – Connect a secondary source for digital video such as a DVD multimedia player or set top box through this all digital connector. The white color band on the rear of the TV indicates this connection. For users who want to connect to a DVI enabled device, use a DVI-HDMI cable and connect the Analog Audio output of the device to the L+R AUDIO here. . Your VIZIO Certified HDMI and HDMI-DVI cables are available for purchase from www.VIZIO.com or by calling 888-VIZIOCE (888-849-4623).
4. **RGB PC** – Connect the video and audio from a computer here. The blue color band on the rear of the TV indicates this connection. A 1/8" plug stereo cable is needed to connect the audio out from the computer to the connector in the rear of the TV for audio from computer.
5. **COMPONENT (YPb/CbPr/Cr with Audio L/R)** – Connect the source for component video devices such as a DVD Player or set top box here. From left to right, use white for left audio and red for right audio inputs, green for Y, blue for Pb (or Cb) and red for Pr (or Cr). The green color band on the rear of the TV indicates this connection.
6. **AV/S-VIDEO IN** – Connect the primary source for composite video devices, such as a VCR or video game. Use the white and red connectors to connect the external audio from the same source, then use the S-Video or yellow connector to connect the external video from the same source. The S-Video, if connected, will take priority over AV RCA (yellow) connector. The yellow color band on the rear of the TV indicates this connection.
7. **OPTICAL AUDIO OUT** – When an audio signal is associated with an input which is selected for viewing, the audio associated with the programming will be available on this SPDIF Optical connector for connection to your home theatre system. The white color band on the rear of the TV indicates this connection.
8. **ANALOG AUDIO OUT** – Connect the audio from the PLASMA HDTV to an external device, such as a home theater system, external amplifier or stereo. Speakers cannot be connected directly to here. The white color band on the rear of the TV indicates this connection.
9. **DTV** – Connect to an antenna or digital cable (out-of-the-wall, not from Cable Box) for Digital TV.*
10. **AC IN** – Plug-in the supplied AC Power Cord here.

* For digital TV stations in your area visit www.antennaweb.org.



1.4 Right-Side Panel Connection

1. **HDMI 3** - Connect the third source for digital video such as a DVD multimedia player or set top box through this all digital connector. The white color band on the side of the TV indicates this connection.
2. **HDMI 4** - Connect the fourth source for digital video such as a DVD multimedia player or set top box through this all digital connector. The white color band on the side of the TV indicates this connection.



1.5 VIZIO Universal Remote Control

The VIZIO Universal Remote Control is a comprehensive remote that can be used to control up to four different components. The remote button functions are explained on the following pages.

Remote LED – Blinks when the remote operates.



This button starts all programming of the Remote Control.



Press this button to turn the TV on from the Standby mode. Press it again to return to the Standby mode.



This button selects a programmed DVD player.



This button selects a programmed Audio Receiver/Amp/Home Theatre System.



This button selects a programmed cable TV set-top box or a satellite TV set-top box.



This button has been pre-programmed to select the codes to operate the VIZIO HDTV.



Use these buttons to select a channel or enter a password.



This button allows the user to cycle through the inputs.

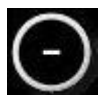

This DASH button is for the DTV mode. When selecting a digital channel directly use this button for the separation of main and sub-channels. For example, channel 28-2 would be selected by the button sequence 2 8 DASH 2.

NOTE: This is a programmable remote supporting up to 4 devices (see TV, VCR, CABLE, DVD buttons at the top of the remote). If the remote is not working with your VIZIO TV, press the TV button on the remote to set the functions back to TV.





Use this button for the On-Screen Display (OSD) menus.



This button displays the image and system information display.



Use the NaVigation Wheel to operate the On-Screen Display (OSD) after it has been activated by pressing the MENU button.

Use the **OK** button to select your chosen option in On-Screen Display (OSD) menus.



GUIDE – This button displays program information. Note: this button is only functional for DTV.



EXIT – This button exits the On-Screen Display (OSD) menus.



VOL (+ or -) – These buttons turn the volume up or down.



LAST – This button recalls the previously viewed channel.



MUTE – This button turns the sound on and off.



CH (+ or -) – These buttons change the channels up or down.





When CABLE is selected and the code to match your Cable (or Satellite) Box has been entered, this button will operate the Cable (or Satellite) Box the same as this button on your Cable (or Satellite) Remote. When TV is selected, this button activates Picture-in-Picture mode.



When CABLE is selected and the code to match your Cable (or Satellite) Box has been entered, this button will operate the Cable (or Satellite) Box the same as this button on your Cable Remote. When TV is selected, press this button to select the size of the PIP screen from one of the following: small, medium or large



When CABLE is selected and the code to match your Cable Box (or Satellite) has been entered, this button will operate the Cable Box (or Satellite) the same as this button on your Cable Remote (or Satellite). When TV is selected, press the button to choose the PIP input. Note: The TV must be in PIP mode for this button to be functional.



When CABLE is selected and the code to match your Cable Box (or Satellite) has been entered, this button will operate the Cable Box (or Satellite) the same as this button on your Cable Remote (or Satellite). When TV is selected, this button is used to select the channels within the PIP screen when DTV/TV is the PIP input selected



Press this button to select TV programming.



Repeated pressing of this button will switch between AV1 and AV2 inputs.



Repeated pressing of this button will switch between Component 1 and Component 2 inputs.



Repeated pressing of this button will switch between HDMI 1, HDMI 2, HDMI 3 and HDMI 4 inputs.



This button cycles through the available screen formats. The options are Wide, Normal, Zoom, Panoramic. Note: in RGB/PC mode the options are 4:3 and 16:9. This button also starts recording when using the remote to control your Cable/Satellite Box or VCR.



This button allows the user to select the sleep options by adjusting the timer in 30 minute increments up to 120 minutes. This button also Pauses playback when using the remote to control your Cable/Satellite Box or VCR.



This button will select the MTS options of Stereo, SAP or Mono in standard TV mode and alternate audio channels, where available, in DTV mode. This button also starts Playback when using the remote to control your Cable/Satellite Box or VCR.



This button will select the Closed Caption mode. The options are OFF, CC1, CC2, CC3, CC4 and if Digital Cable Service is the signal; you would get Service1 through Service6, depending on your local company. This button also Stops playback/recording when using the remote to control your Cable/Satellite Box or VCR.



Press this button to "Freeze-Frame" the current screen. Press this button again the continue playing. This button also skips to the previous chapter when using the remote to control your Cable/Satellite Box or DVD Player.



Press this button to switch the audio from the main screen to the sub-screen while in PIP or POP mode.



While in PIP/POP mode; pressing SWAP will switch the displays from the main screen to the sub-screen or vice versa.

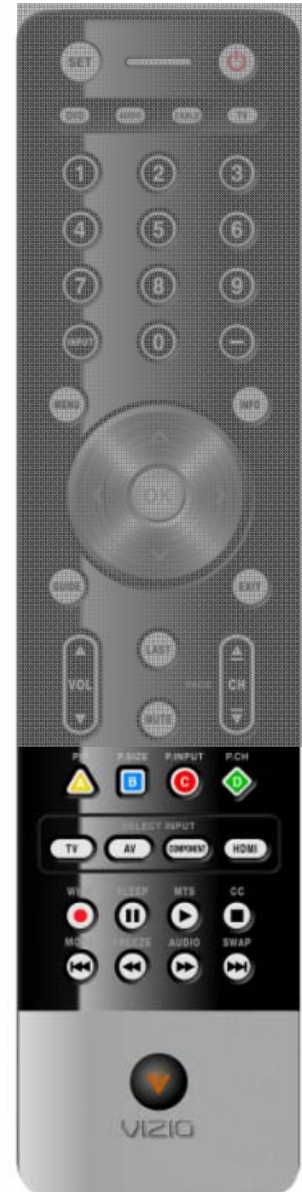

1.5.1 Insertion of Batteries in the Remote Control

Insert two AA batteries into the remote control. Make sure that you match the (+) and (-) symbols on the batteries with the (+) and (-) symbols inside the battery compartment. Re-attach the battery cover.

Precautionary Tips for Inserting the Batteries:

Only use the specified AA batteries.

Do not mix new and old batteries. This may result in cracking or leakage that may pose a fire risk or lead to personal injury.

Inserting the batteries incorrectly may also result in cracking or leakage that may pose a fire risk or lead to personal injury.

Dispose of the batteries in accordance with local laws and regulations.

Keep the batteries away from children and pets.



1.5.2 Remote Control Range

Point the remote control at the remote control sensor to transmit the commands.

Do not place any obstacles between the remote control and the receiver window.

The effective range of the remote control is approximately 30 feet (10 meters) from the front of the receiver window, 30° to the left and right, 20° up and down.

1.5.3 VIZIO Universal Remote Control Precautions

The remote control should be kept dry and away from heat sources. Avoid humidity.

If the TV responds erratically to the remote control or does not respond at all, check the batteries. If the batteries are low or exhausted, replace them with fresh batteries.

When not using the remote control for a long period of time, remove the batteries.

Do not take the batteries apart, heat them, or throw them into a fire.

Do not subject the remote control to undue physical stress, such as striking or dropping it.







Do not attempt to clean the remote control with a volatile solvent. Wipe it with a clean, damp cloth.



Chapter 2 Connecting Equipment

2.1 Which Video Connection Should I Use?

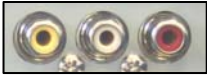
The VIZIO VP504 FHDTV10A has six different ways to connect your video equipment from a basic connection to the most advanced for digital displays.

Connection Quality (type)	Connector	Rear Panel Color Codes	Description
Best (digital)		White	HDMI (High-Definition Multimedia Interface) - It is the first and only industry-supported, uncompressed, all-digital audio/video interface. HDMI provides an interface between any audio/video source, such as a set-top box, DVD player, or A/V receiver and an audio and/or video monitor, such as a digital television (DTV), over a single cable.
Best (digital) ----- Good (analog)		Black	DTV Coaxial RF. When used for MPEG2 encoded bit streams from ATSC broadcast programming, this input takes advantage of the High Definition content. ----- TV Coaxial RF. This is the connection for standard NTSC TV using antenna or cable.
Best (analog)		Blue	RGB PC (VGA) – This video input has separate red, green and blue color components. The signal carries horizontal and vertical sync information on the green signal. This is most commonly used for PC input.
Better (analog)		Green	Component - The video signal is separated into three signals, one containing the black-and-white information and the other two containing the color information. This enhancement over S-Video takes advantage of the superior picture provided by progressive scan DVD players and HDTV formats.
Good (analog)	 	Yellow, and Red	Composite - The complete video signal is carried through this single pin connector. This is the most commonly used video connection. S-Video - The video signal is separated into two signals, one containing the black-and-white information and the other containing the color information. Separating the color in this way avoids 'cross color' effects where closely spaced black and white lines are erroneously displayed in color. It also enables text to be displayed more sharply.

Note: For more info refer to the Quick Start Guide



2.2 Connecting Coaxial (RF)

2.2.1 Using Your Antenna or Digital Cable for DTV



1. Turn off the power to the HDTV.
2. Connect the coaxial (RF) connector from your antenna or digital cable (out-of-the-wall, not from the Cable Box) to the DTV/TV CABLE/ANTENNA connector on the rear of the HDTV.
3. Turn on the power to the HDTV.
4. Select DTV using the INPUT button on the remote or side of the HDTV, or directly by pressing the TV button on the Remote Control.



Note:

- a) Not all digital TV broadcasts are High Definition (HD). Refer to the program guides, or consult your cable, satellite or TV station operator.
- b) Digital broadcasts are not available in all areas. Refer to www.antennaweb.org for detailed information.
- c) Make sure the antenna and coaxial cable are correctly grounded.
- d) For Professional antenna installation contact us at www.VIZIO.com or call 1-888-VIZIOCE (1-888-849-4623).

2.2.2 Using the Antenna or Cable through your VCR



1. Turn off the power to the HDTV and VCR.
2. Connect the “Output to TV”, “RF Out” or “Antenna Out” connector on the rear of your VCR to the DTV/TV CABLE/ANTENNA connector at the rear of the HDTV.
3. Turn on the power to the HDTV and VCR.
4. Select TV using the INPUT button on the remote or side of the HDTV, or directly by pressing the TV button on the Remote Control.



Note: If you have an off-air antenna or cable TV, connect it to the “Antenna In” connector on the rear of your VCR.



2.3 Connecting Your HDTV Set-Top Box

2.3.1 Using HDMI Input

HDTV Set-Top Boxes that have a HDMI digital interface should be connected to the HDMI input of the PLASMA HDTV for optimal results.

Note: To maintain the display quality, use a VIZIO certified HDMI cable. Length is available up to 10 meters. See www.vizio.com or call 1-888-VIZIOCE (1-888-849-4623) for details.

Connecting your HDTV Set-Top Box (Best):

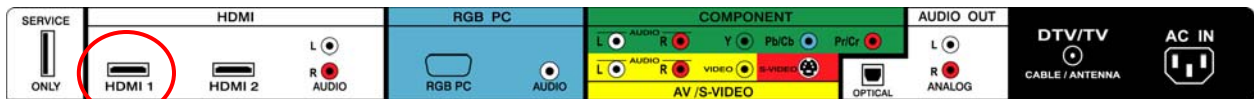

1. Turn off the power to the HDTV and HDTV Set-Top Box.
2. Connect a HDMI cable to the HDMI output of your HDTV Set-Top Box and the other end to the HDMI Input (white color area) at the rear of the HDTV.
3. Turn on the power to the HDTV and HDTV Set-Top Box.
4. Select HDMI using the INPUT button on the remote or side of the HDTV, or directly by pressing the HDMI button on the Remote Control.

Note:

- a) The HDMI input on the HDTV supports High-bandwidth Digital Content Protection (HDCP). HDCP encrypts the transmission between the video source and the digital display for added security and protection.
- b) Refer to your HDTV Set-Top Box user manual for more information about the video output requirements of the product or consult your cable or satellite operator.



For HDTV Set-Top Boxes with DVI:

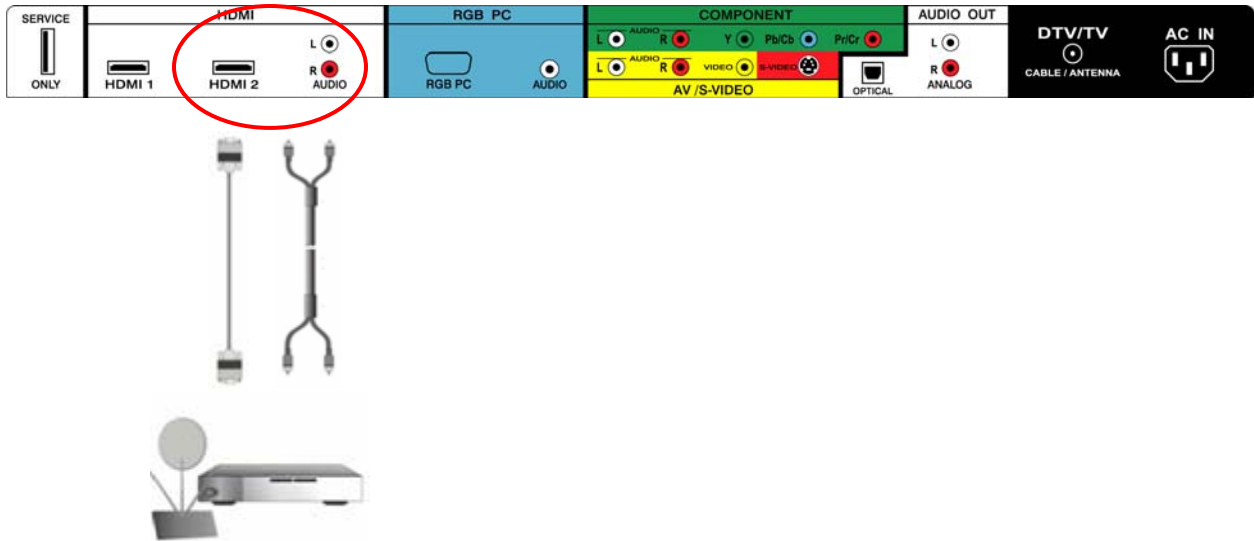

1. Turn off the power to the HDTV and HDTV Set-Top Box.
2. Using a HDMI-DVI cable, connect the DVI end to your HDTV Set-Top Box and the HDMI end to the HDMI 2 Input (white color area) at the rear of the HDTV.
3. Using an audio cable (white and red connectors), connect the cable to the audio output connectors associated with the DVI output on your HDTV Set-Top Box and connect the other end to the audio connectors associated with the HDMI input (white area) at the rear of the HDTV.
4. Turn on the power to the HDTV and HDTV Set-Top Box.
5. Select HDMI 2 using the INPUT button on the remote or side of the HDTV, or directly by pressing the HDMI button on the Remote Control.

Note:

- a) The HDMI input on the HDTV supports High-bandwidth Digital Content Protection (HDCP). HDCP encrypts the transmission between the video source and the digital display for added security and protection.
- b) Refer to your HDTV Set-Top Box user manual for more information about the video output requirements of the product or consult your cable or satellite operator.



2.3.2 Using Component Video

Connecting your HDTV Set-Top Box (Better):

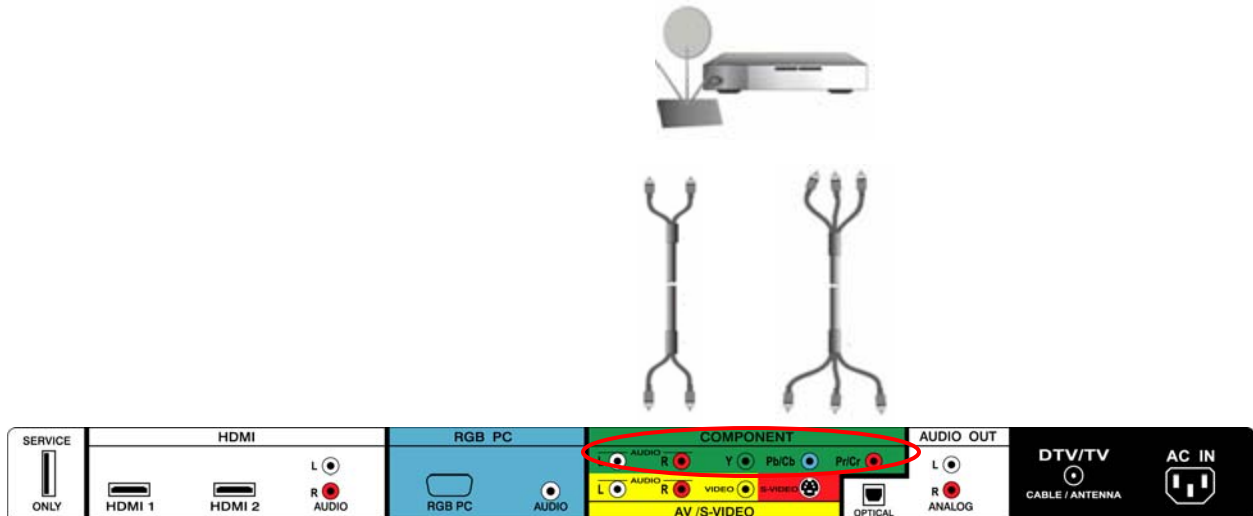

1. Turn off the power to the HDTV and HDTV Set-Top Box.
2. Connect the Y (green color) connector on your HDTV Set-Top Box to the corresponding Y (green color) connector in the Component group (green color area - row of connectors nearest to you when viewing from the rear of the TV) at the rear of the HDTV.
3. Connect the Pb (blue color) connector on your HDTV Set-Top Box to the corresponding Pb (blue color) connector in the Component input (green color area - row of connectors nearest to you when viewing from the rear of the TV) at the rear of the HDTV.
4. Connect the Pr (red color) connector on your HDTV Set-Top Box to the corresponding Pr (red color) connector in the Component input (green color area - row of connectors nearest to you when viewing from the rear of the TV) at the rear of the HDTV.
5. Using an audio cable (white and red connectors), connect the cable to the audio output connectors associated with the Component output on your HDTV Set-Top Box and connect the other end to the audio connectors associated with the Component1 input (green color area) at the rear of the HDTV.
6. Turn on the power to the HDTV and HDTV Set-Top Box.
7. Select Component using the INPUT button on the remote or side of the HDTV, or directly by pressing the Component button on the Remote Control.

Note:

- a) Refer to your HDTV Set-Top Box user manual for more information about the video output requirements of the product or consult your cable or satellite operator.



2.4 Connecting Your Basic Set-Top Box

2.4.1 Using Composite Video

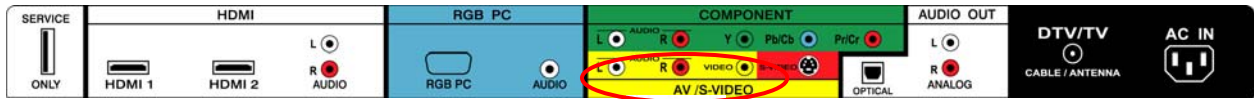

1. Turn off the power to the HDTV and Set-Top Box.
2. Using the AV Cable, connect the Video (yellow color) connector on your Set-Top Box to the corresponding Video (yellow color) connector in the AV input (yellow color area) at the rear of the HDTV.
3. Using the white and red connectors, connect the cable to the audio output connectors associated with the Video output on your Set-Top Box and connect the other end to the audio connectors associated with the AV input (yellow color area) at the rear of the HDTV.
4. Turn on the power to the HDTV and Set-Top Box.
5. Select AV using the INPUT button on the remote or side of the HDTV, or directly by pressing the AV button on the Remote Control.

2.4.2 Using Coax (RF)

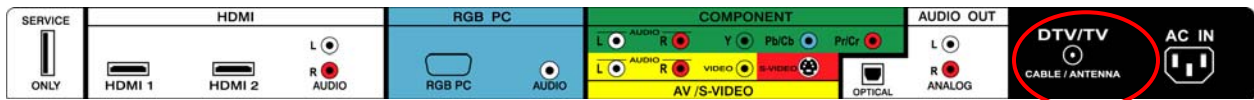

1. Turn off the power to the HDTV and Set-Top Box.
2. Using a Coax (RF) cable, connect one end to the TV OUT (RF) on your Set Top Box and the other end to the DTV/TV input at the rear of the HDTV.
3. Turn on the power to the HDTV and Set-Top Box.
4. Select TV using the INPUT button on the remote or side of the HDTV, or directly by pressing the TV button on the Remote Control.

Note: Refer to your Set Top Box user manual for more information about selecting the video or RF output of the product.



2.5 Connecting Your DVD Player

You have several options for connecting your DVD player to your VP504 FHDTV10A; HDMI, Component, AV (S-Video or Composite) inputs. Based on your configuration, you can decide which option is right for you.

2.5.1 Using HDMI Input

DVD players that have a digital interface such as HDMI (High Definition Multimedia Interface) should be connected to the HDMI input of the VIZIO VP504 FHDTV10A for optimal results.

Note: To maintain the display quality, use a VIZIO certified HDMI cable available up to 10 meters. See www.VIZIOCE.com or call 1-888-VIZIOCE (1-888-849-4623) for details.

Connecting your DVD Player (Best):



1. Turn off the power to the HDTV and DVD player.
2. Connect a HDMI cable to the HDMI output of your DVD player and the other end to the HDMI1 Input (white color area) at the rear of the HDTV.
3. Turn on the power to the HDTV and DVD player.
4. Select HDMI1 using the INPUT button on the remote or side of the HDTV, or directly by pressing the HDMI button on the Remote Control.
5. If HDMI1 is being used, connect to either HDMI 2 or HDMI 3 as the input and follow steps 1 through 3; and then select the corresponding HDMI input step 4.



For DVD Players with DVI:

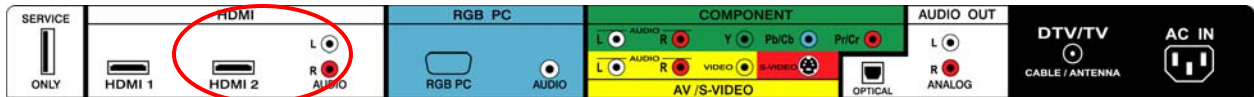

1. Turn off the HDTV and DVD player.
2. Using a HDMI-DVI cable, connect the DVI end to your DVD player and the HDMI2 end to the HDMI Input (white color area) at the rear of the HDTV.
3. Connect an audio cable (white and red connectors) to the audio output connectors associated with the DVI output of the DVD player and connect the other end to the audio connectors by the HDMI input (white area) at the rear of the HDTV.
4. Turn on the power to the HDTV and your DVD player.
5. Select HDMI 2 using the INPUT button on the remote or side of the HDTV, or directly by pressing the HDMI button on the Remote.

Note: Refer to your DVD player user manual for more information about the video output requirements of the product.



2.5.2 Using Component Video

Connecting your DVD Player (Better):

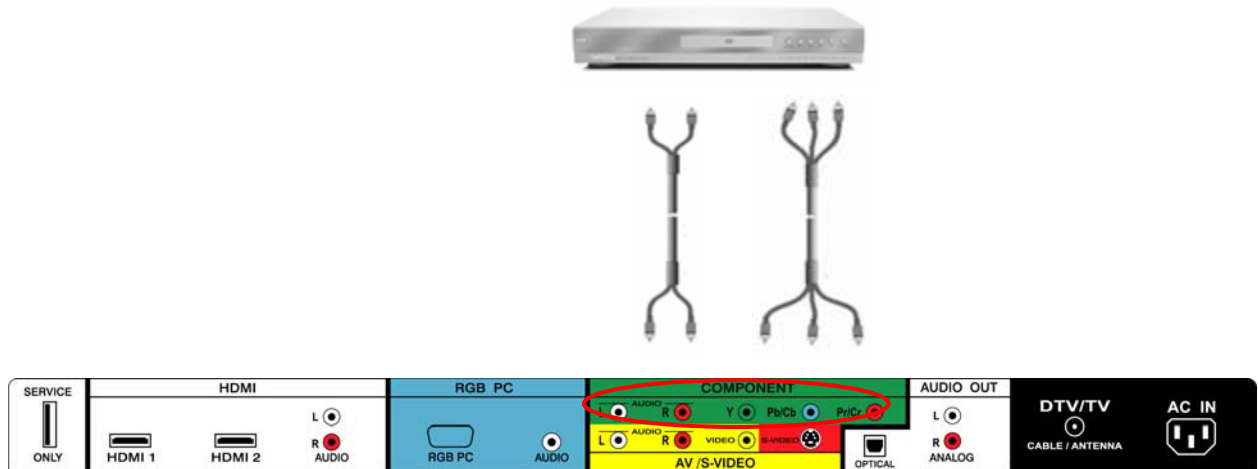

1. Turn off the power to the HDTV and DVD player.
2. Connect the Y (green color) connector on your DVD player to the corresponding Y (green color) connector in the Component input (green color area - row of connectors nearest to you when viewing from the rear of the TV) at the rear of the HDTV.
3. Connect the Pb (blue color) connector on your DVD player to the corresponding Pb (blue color) connector in the Component input (green color area - row of connectors nearest to you when viewing from the rear of the TV) at the rear of the HDTV.
4. Connect the Pr (red color) connector on your DVD player to the corresponding Pr (red color) connector in the Component input (green color area - row of connectors nearest to you when viewing from the rear of the TV) at the rear of the HDTV.
5. Using an audio cable (white and red connectors), connect the cable to the audio output connectors associated with the Component output on your DVD player and connect the other end to the audio connectors associated with the Component input (green color area) at the rear of the HDTV.
6. Turn on the power to the HDTV and DVD player.
7. Select Component using the INPUT button on the remote or side of the HDTV, or directly by pressing the Component button on the Remote Control.

Note:

- a) Refer to your DVD player user manual for more information about the video output requirements of the product.



2.5.3 Using S-Video (AV/S-VIDEO) Connecting your DVD Player (Good):

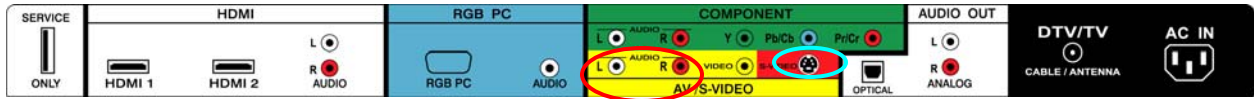

1. Turn off the power to the HDTV and DVD player.
2. Connect the S-Video jack on the rear of your DVD player to the S-Video jack in the AV/S-VIDEO input (yellow/red area) at the rear of the HDTV.
3. Connect an audio cable (white and red connectors) to the audio output connectors associated with the S-Video output on your DVD player and connect the other end to the audio connectors associated with the AV input (yellow/red area) at the rear of the HDTV.
4. Turn on the power to the HDTV and DVD player.
5. Select AV using the INPUT button on the remote or side of the HDTV, or directly by pressing the AV button on the Remote Control.



2.5.4 Using Composite (AV) Video Input

Connecting your DVD Player (Good) :

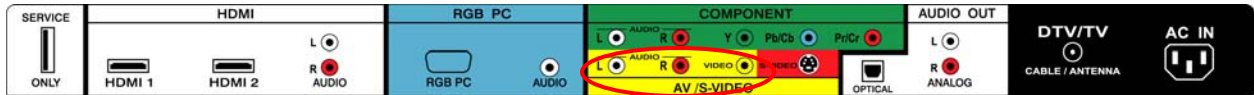

Turn off the power to the HDTV and DVD player.

1. Connect the Video (yellow color) connector on your DVD player to the Video (yellow color) connector in the AV/S-VIDEO input (yellow/red color area - row of connectors furthest from you when viewing from the rear of the HDTV) at the rear of the HDTV.
2. Connect the R (red color) and L (white color) audio connectors on your DVD player to the corresponding R (red color) and L (white color) audio input connectors in the AV input (yellow/red color area - row of connectors furthest from you when viewing from the rear of the TV) on the rear of the HDTV.
3. Turn on the power to the HDTV and DVD Player.
4. Select AV using the INPUT button on the remote or side of the HDTV, or directly by pressing the AV button on the Remote Control.



Note: Refer to your DVD player user manual for more information about the video output requirements of the product.



2.6 Connecting Your VCR or Video Camera

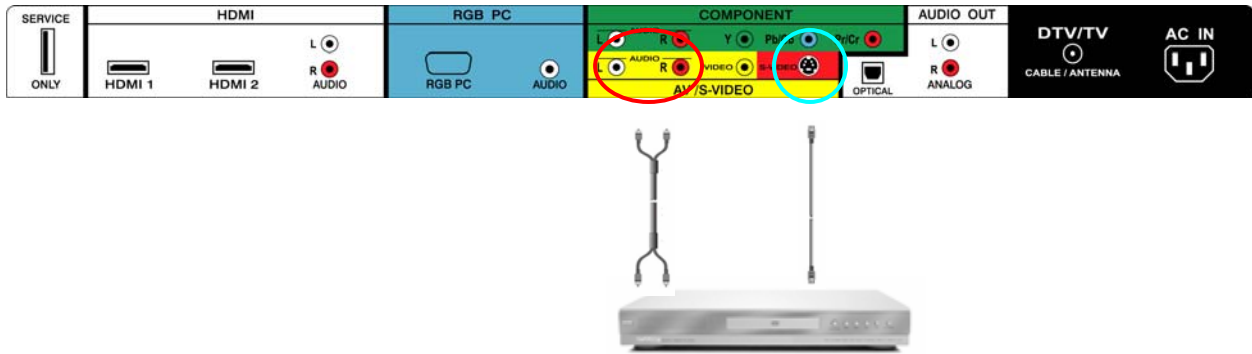





1. Turn off the HDTV and VCR or Video Camera.
2. Connect the S-Video jack on the rear of your VCR or Video Camera to the S-Video jack in the AV input (yellow/red area) at the rear of the HDTV.
3. Connect an audio cable (white and red connectors) cable to the audio output connectors associated with the S-Video output on your VCR or Video Camera and connect the other end to the audio connectors associated with the AV input (yellow/red area) at the rear of the HDTV.
4. Turn on the power to the HDTV and VCR or Video Camera.
5. Select AV using the INPUT button on the remote or side of the HDTV, or directly by pressing the AV button on the Remote Control.

Note: Refer to your VCR or Video Camera user manual for more information about the video output requirements of the product.

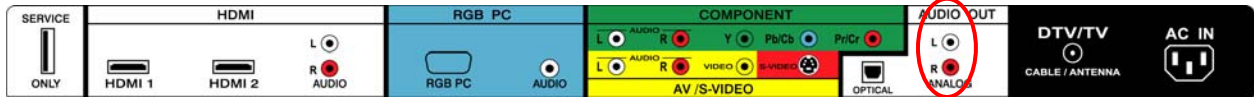

2.7 Connecting an external Receiver/Amp



1. Turn off the power to the PLASMA HDTV and Receiver/Amp.
2. Using an audio cable (white and red connectors), connect the cable to the audio input connectors on the Receiver/Amp and connect the other end to the ANALOG OUT (white area) audio connectors at the rear of the PLASMA HDTV.
3. Turn on the power to the PLASMA HDTV and Receiver/Amp.
4. Then press the **MENU** button on the remote control to open the On-Screen Display (OSD) menu.
5. Press the  on the remote control to select the Audio Adjust menu.
6. Press the  on the remote control to select SPEAKERS.
7. Press the  on the remote control to select OFF so that the sound from the PLASMA HDTV will now be routed through your Receiver/Amp system.



2.7.1 Optical Output of Audio received

If your sound system has a SPDIF (optical) digital audio input you can connect it to the optical AUDIO OUT (white area) at the rear of the VP504 HDTV10A.

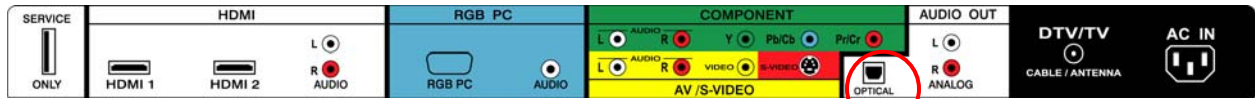

1. Turn off the power to the PLASMA HDTV and Receiver/Amp.
2. Using an SPDIF cable, connect the cable to the audio input connector on the Receiver/Amp and connect the other end to the OPTICAL OUT (white area) audio connectors at the rear of the PLASMA HDTV.
3. Turn on the power to the PLASMA HDTV and Receiver/Amp.
4. Then press the **MENU** button on the remote control to open the On-Screen Display (OSD) menu.
5. Press the on the remote control to select the Audio Adjust menu.
6. Press the on the remote control to select SPEAKERS.
7. Press the on the remote control to select OFF so that the sound from the PLASMA HDTV will now be routed through your Receiver/Amp system.



Press the **LAST** key once to return to the previous screen or repeatedly to return to your program if task has been completed.

Note:

- a) Refer to your Receiver/Amp user manual to select the corresponding audio input.
- b) The audio output is not amplified and cannot be connected directly to external speakers.



2.8 Connecting a PC Computer

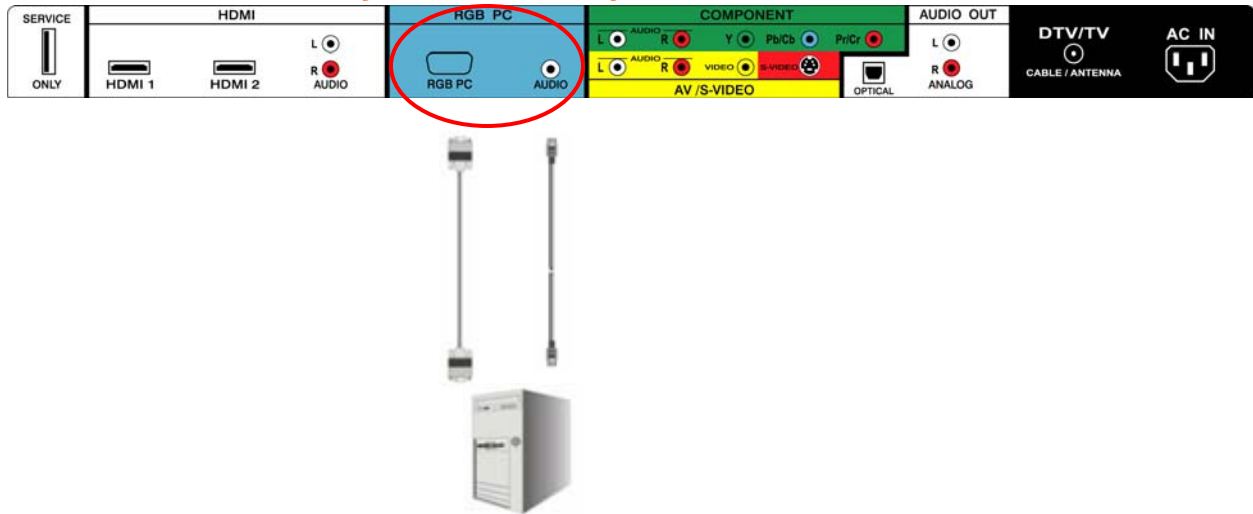

1. Turn off the power to the HDTV and PC Computer.
2. Connect a 15-pin D-Sub RGB (VGA) cable to the RGB output of your pc computer and the other end to the RGB PC input (blue area) at the rear of the HDTV.
3. Connect the Audio Out on your pc computer to the RGB PC Audio input (blue area) at the rear of the HDTV.
4. Turn on the HDTV and PC Computer.
5. Select RGB using the INPUT button on the remote or side of the HDTV.

Note:

- a) For the best picture quality when connecting a pc computer through RGB PC, set your pc computer timing mode to VESA 1920x1080 at 60Hz. Please refer to the pc or graphic card's user guide for additional information on how to set the timing mode and the video output requirements of the product.
- b) A RGB (VGA) cable and stereo mini jack cable are not included and can be purchased at an electronics store.



2.8.1 Preset PC Resolutions

If connecting to a PC through the RGB PC input, set the TV timing mode to VESA 1920x1080 at 60Hz for best picture quality (refer to the graphic card's user guide for questions on how to set this timing mode). Please see the table below for the factory preset resolutions.

Resolution	Refresh (Hz)	H.Freq (kHz)	V.Freq (Hz)	H.Sync	V.Sync	Pixel Freq (MHz)
640x480	60	31.47	59.94	N	N	25.18
640x480	75	37.50	75.00	N	N	31.50
720x400**	70	31.46	70.08	N	P	28.32
800x600	60	37.90	60.32	P	P	40.00
800x600	72	48.07	72.19	P	P	50.00
800x600	75	46.90	75.00	P	P	49.50
1024x768	60	48.40	60.01	N	N	65.00
1024x768	70	56.48	70.07	N	N	75.00
1024x768	75	60.00	75.03	P	P	78.75
1366x768	60	47.70	60.00	P	P	85.50
1920x1080*	60	66.50	60.00	P	P	136.500

NOTES: N = Negative, P = Positive, *Native Resolution with Reduced Blanking, see below for more details, ** = DOS Mode

2.8.2 Resolution (1920x1080) through RGB (15-Pin VGA) Input

If your PC supports VESA Reduce Blanking timing via the VGA card drive program (usually offered by the VGA Card Manufacturer), your TV set is equipped to have the 1920X1080 resolution display through this connection using the following timing 136.5MHz. The following parameters are often the values required by the software or programs to set up the display:

Parameters	Horizontal Values (Pixels)	Vertical Values (Lines)
Address	1920	1080
Front Porch	32	1
Sync Width	32	3
Back Porch	64	27
Total	2048	1111
Frequency	66.7 kHz	60 Hz
Sync Polarity	P	P
Pixel Rate (MHz)	136.5	
Refresh Rate (Hz)	60	





Chapter 3 Setting Up to Watch Television

For 'Preparing Your PLASMA HDTV for Wall Mounting', see page 6.

3.1 Basic PLASMA HDTV Start Up

1. **Connecting the Power Cable**
Connect the power cord to the power cord connector on the back of the HDTV, and then plug the power cord into an AC wall socket.
2. **Connect Audio and Video Cables to the HDTV**
(see pages 16 ~ 30 for detailed steps)
3. **Turning Power On**
Once all the components are connected, press the Power ON button on the side of the HDTV, or press the Power ON (Orange) button on the remote control.
4. **Initial Setup**

After powering on the TV set, the Initial Setup screen will come up; please press the  button on the remote control.

The Language choice screen will be displayed; the default English option is highlighted. If you wish to change the OSD language to Español or Français, press the  button on the remote control to select the language you want.

Press the  button on the remote to go to the next screen.

Note: At this point, if a Set-Top Box from your Local Cable or Satellite Service Company or other equipment is been used; please press the **LAST** key on the remote control and skip to Step 5. If this is not your case, please continue at Step b.

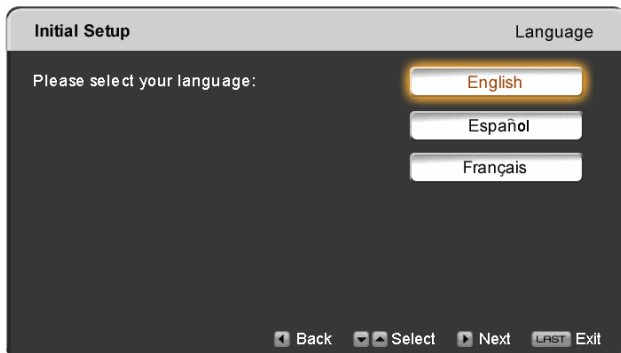
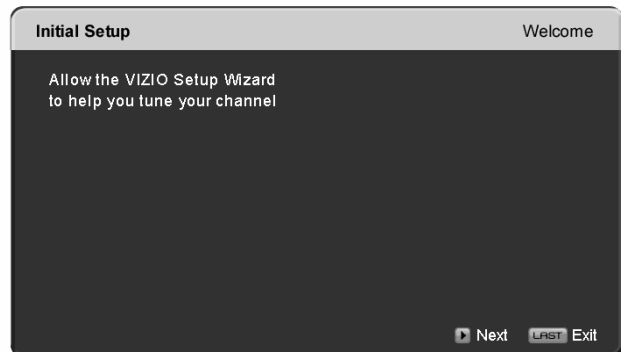

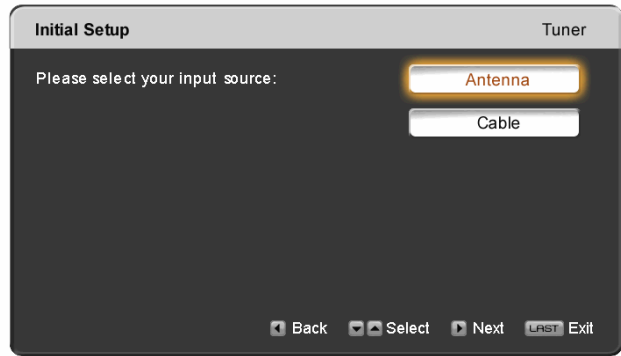

- a. The Tuner screen will be displayed; default choice is Antenna. If you are using Cable (No Box) Service, press the  button on the remote control to highlight CABLE.

Press the  button on the remote to go to the next screen.



- b. The Channel Scan screen will be displayed; default choice is Scan.

Press the  button on the remote control to commence the search for available channels to be stored into memory.

If you do not want to scan for channels at this time, press the  button on the remote to highlight Skip Scan and then press the  button.

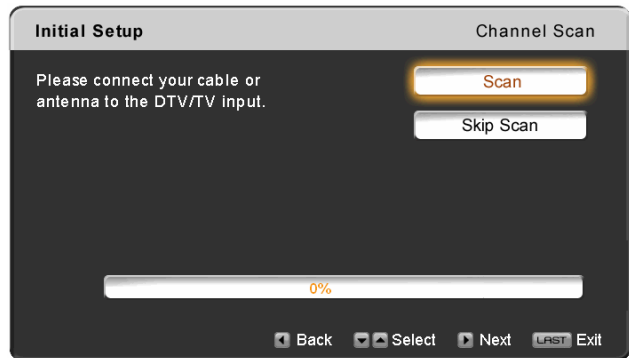

Note: If you select Skip Scan, next time that you decide to complete this procedure; you will need to select the TV as input (through the Input key) and then go through the Menu option to select the Tuner setup to get the option of scanning the channels again.



- c. The screen will now change to show the progress of the search for Analog (NTSC) and Digital (ATSC) channels.

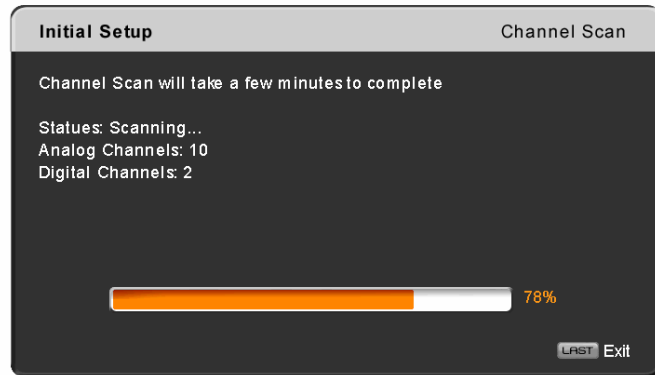

Note: DTV digital broadcast is not available in all areas. Refer to www.antennaweb.org to get information about availability in your area, type of antenna and in which direction to point your antenna. The channel availability through cable depends upon which channels your cable operator supplies in Clear QAM; consult your cable operator for more information.

- d. When finished, the Complete screen will be displayed to inform you that the HDTV has completed the Initial Setup.

Press the  button on the remote control to exit and begin watching TV.

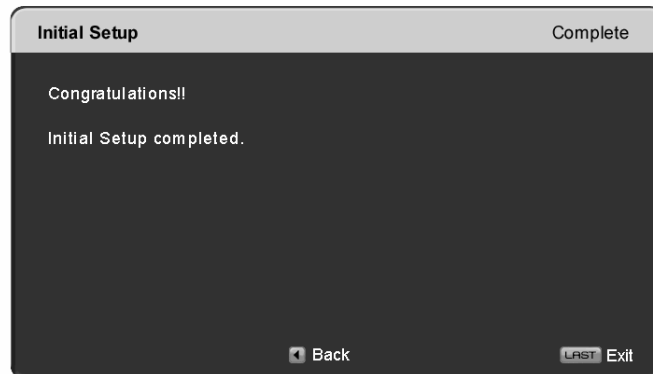

5. Select Input Source

Select the Input Source for the HDTV by pressing the INPUT button on the side of the TV or using the Input button on the remote control. Pressing this button will cycle you through the following options: TV, AV/S-VIDEO, Component, RGB, HDMI1, HDMI2, HDMI3 and HDMI4.

Now follow the procedure below to display channels from a different signal (External TV Tuner, VCR, Cable Box or Satellite Receiver) source, using different inputs at the back of you TV set.

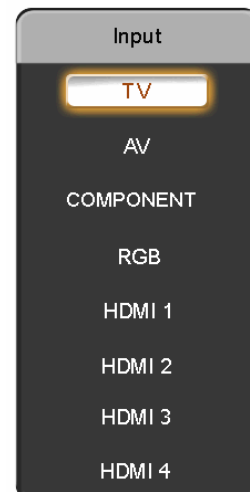

- a. Select the correct input connection; RF (DTV/TV) connector, Composite (Yellow, Red and White) connectors, Component (Red, Green, Blue plus Red and White) connectors, HDMI connectors or Separate-Video (S-Video) plus Red and White connectors (if applicable). Make the physical connection or hook up.
- b. If you have an HD service you must use the HDMI (best) or Component connection.



Note: Composite (AV) and S-Video Cables can only be used for SD (480i) pictures.

- c. Turn on your Cable Box, VCR, External TV Tuner or Satellite Receiver and you will see a picture on your TV set. If there is not picture, make sure you have selected the correct input on the TV set.
- d. If the selected input is RF, you should be aware that the TV set needs to be on either channel 3 or channel 4 matching the channel which has been selected on the back of the VCR, Cable Box, External TV Tuner or Satellite Receiver; please refer to Owner or User's Manual of such equipment for details.



Note: The TV set will be displaying any television station or program selected by the Cable Box, VCR, External Tuner or Satellite Receiver. The TV set will not be able to change programs or channels; this is controlled by the equipment sending the signal. **If the service being used is the one which setup includes a box with two different outputs for two different (distant) rooms, then scanning channels would help you to find the signal. Be aware that the channel to be selected varies from provider to provider; meaning that, you may have to call your provider company so they could provide you the specific channel when using high definition made TV sets. Some examples of these channels are: 105, 106, 115 and 116.**

6. Fine Tuning your TV set for Home Use.



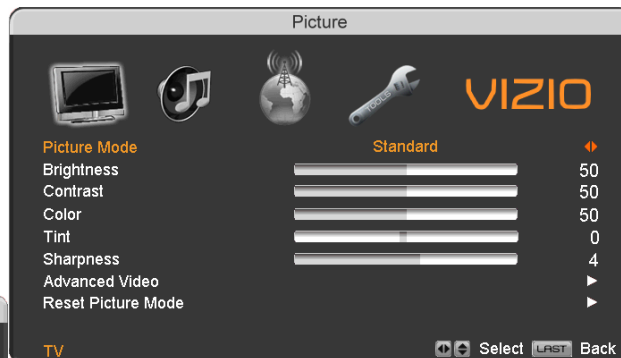

After completing Procedure 4 or Procedure 5; please follow the steps below to optimize your TV set display:

- a. Press the **MENU** or **OK** key to bring up the Menu display. Use the  or  button to scroll to the Advanced Video option.





- b. Press the **MENU** or **OK** button to select it.
- c. Use the  or  button to scroll to the Color Temperature option.

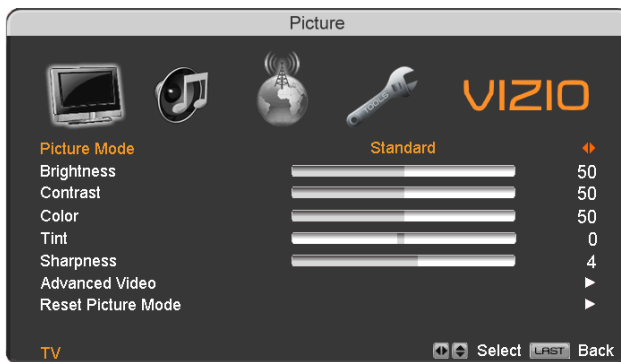
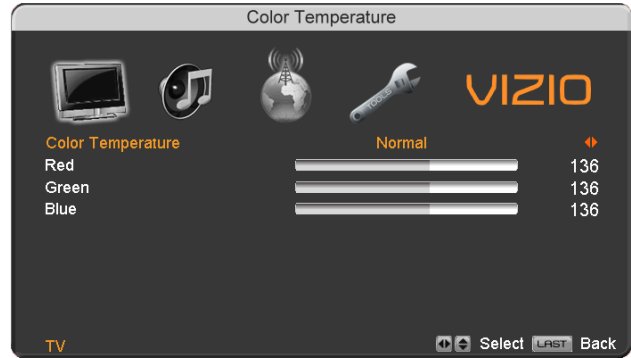

- d. Press **MENU** or **OK** button to select it.
- e. Press either  or  button to change setting to Normal, and then press the **LAST** key again to go back to previous screen.
- f. Press either  or  button to select the Picture Mode option.





- g. Press either  or  button to change the Picture Mode option to Standard.
- h. Press the **LAST** key to exit the on screen display Menu.

Note: If Procedure 4 had been done, you would like to do the following to ensure that the correct program times are shown when pressing the Guide key:

Press the Menu key, this will bring up the picture mode menu.

Press either  or  button scroll across to the icon showing the little satellite dish or antenna. The next screen will appear showing Time Zone.

Press either  or  button to select it.

Press either  or  button to choose the proper Time Zone of your area.

Press the **LAST** key once to return to the previous screen or repeatedly to return to your program if task has been completed.

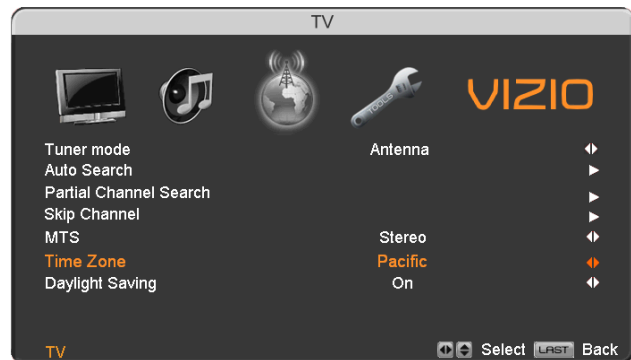

Your new TV set is now ready to automatically reproduce the best picture quality out of the input signal which is been fed into it. Enjoy your TV watching!!



3.2 Watching a TV Program

Before you start watching TV, please make sure that any cable, satellite or off-air antenna connections are secure. Also, verify that the power cord is plugged into a correctly grounded electrical outlet or surge protector.

1. Press the power button on the remote or on the side of the HDTV. The VIZIO logo on the front will change from orange to white.
2. There are 3 options for selecting your programming:
 - a. If you are using an antenna or cable connected through the DTV/TV CABLE/ANTENNA input, you can select TV directly by pressing the TV button on the remote, or by pressing the INPUT button on the remote or on the side of the HDTV.
 - b. If you are watching broadcasts through a cable or satellite set-top box connected by an HDMI cable, select HDMI directly by pressing the HDMI button on the remote, or by pressing the INPUT button on the remote or on the side of the HDTV.
 - c. If you are watching broadcasts through a cable or satellite set-top box connected by a Component (YPbPr) cable, select Component directly by pressing the Component button on the remote, or by pressing the INPUT button on the remote or on the side of the HDTV.

Note: You should be able to see a picture. If you do not, make sure that all of the HDTV connections are secure and you have selected the correct video input source.

3. When using option 2a, press the Channel buttons on the remote or the CH +/- buttons on the side of the HDTV to change the channel. Note: The Channel buttons, on the side of the HDTV and on the remote, control will not work if you are watching a program using HDMI, Component, AV-S (S-Video) and AV-C (Composite) inputs.



3.3 Adjusting Basic HDTV Settings



Volume

To adjust the volume, press and hold the VOL+ or VOL- button on the side of the PLASMA HDTV or remote control until the desired level is reached.

TV Channels

To step up or down through the available TV channels, press the CH+ or CH- button on the side of the HDTV or remote control once for the next or previous channel, or hold it depressed until the desired channel is reached. *Note:* Channel up and down will only operate in DTV and TV modes.

Wide

Using this feature, you can watch video content in different size modes on the HDTV.

Press the **MENU** button on the remote control to bring up the OSD screen.

Press either the  or  button to select Setup (wrench look alike icon) options.

Press the  button scroll down to Wide and select it.

Press either the  or  button to select among the modes.

Fore more information see Section Understanding Viewing Features - Viewing Modes, on page 70.



3.4 Program Information

Press the **GUIDE** button twice on the remote and program information for the channel you are watching will be displayed on the screen with the live program content in a small window in the lower left corner.

Press the **▲** or **▼** button to scroll up or down the channels. Each time you pause at a channel, the program list will update with the program schedule for the channel and the window will show the live program for that channel. Press the **GUIDE** button to exit this feature.



3.5 Information on HDTV Status

When you change TV channels or inputs, or press the **INFO** button twice on the remote, an Information Banner is displayed for a few seconds to tell you the status of the PLASMA HDTV.



Chapter 4 Advanced Adjustment of HDTV



4.1 Using the On Screen Display (OSD)

The remote control or the control buttons on the right hand side of the TV can control all the function settings. The On Screen Display (OSD) allows you to adjust the save contrast, brightness and other settings. The TV will save changes made to the settings, even if the TV is turned off.

The OSD consists of several menu options: Picture Adjust, Audio Adjust, Setup and TV Tuner Setup. The main menu options may vary depending on your selected input source.

Note: Some of the main menu options may have additional submenus, i.e. the TV Rating submenu for Parental Controls.

Press the **MENU** button on the remote control or the side of the TV and the Picture Adjust menu will be shown on the screen.

Press the  or  button on the remote control or the **VOL +** or **VOL -** button on the side of the HDTV to select one of the other menu options.

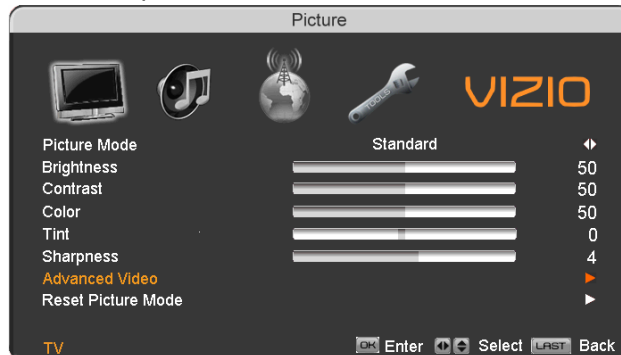



Picture Adjust

Audio Adjust

TV Tuner Setup

Setup

Once the menu option is displayed, press the  or  button on the remote control or the **CH +** or **CH -** button on the side of the TV to select one of the items to adjust.

Press the  button on the remote control or the **VOL -** button on the side of the HDTV to begin adjustment of the item.

Press **OK** when finished.

Press the **LAST** key once to return to the previous screen or repeatedly to return to your program if task has been completed.





4.2 DTV / TV Input Picture Adjustment

4.2.1 Picture Mode

When the **MENU** button is pressed, the On Screen Display (OSD) appears on the PICTURE adjustment page.

Press the  button to highlight the Picture Mode selection.

Use the  or  button to choose from Custom, Standard, Movie, Game, Vivid, Football, Golf, Basketball and Baseball.

Picture Adjustments are available for you to set them to your preferred settings.

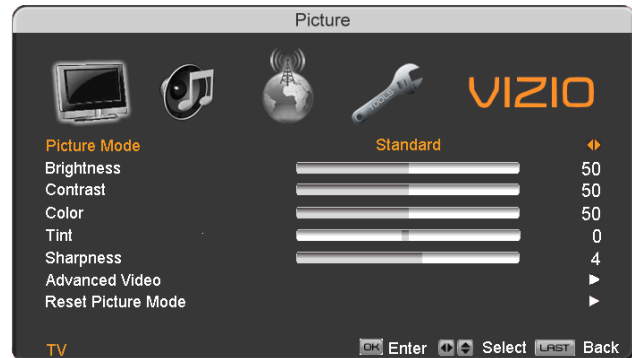



Once the adjustments are completed press the **LAST** button repeatedly to exit the OSD completely.

4.2.2 Brightness

Press the  button to highlight the Brightness selection.

Press the  button to start adjusting the brightness and the menu page will disappear and be replaced by a small Brightness Indicator Bar so you can see the brightness level between the minimum and maximum available levels.

Use the  or  button to adjust the level.



The Brightness adjusts the black levels in the picture. If the brightness is too low you will not be able to see the detail in darker parts of the picture and if the brightness is too high the picture will look washed out.

Once the adjustments are completed press the **LAST** button repeatedly to exit the OSD completely.



4.2.3 Contrast

Press the  button to highlight the Contrast selection.

Press the  button to start adjusting the contrast and the menu page will disappear and be replaced by a small Contrast Indicator Bar so you can see the contrast level between the minimum and maximum available levels.

Use the  or  button to adjust the level.

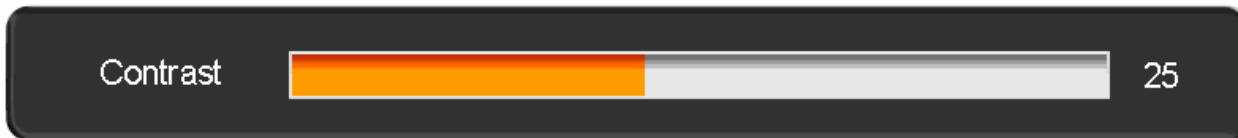

The Contrast adjusts the white levels in the picture. If the contrast is too low the picture will look washed out and if the contrast is too high you will not be able to see any detail in the bright parts of a picture. Once the adjustments are completed press the **LAST** button repeatedly to exit the OSD completely.

4.2.4 Color

Press the  button to highlight the Color selection.

Press the  button to start adjusting the color and the menu page will disappear and be replaced by a small Color Indicator Bar so you can see the color level between the minimum and maximum available levels.

Use the  or  button to adjust the level.



The Color adjusts the amount of color in the picture. Once the adjustments are completed press the **LAST** button repeatedly to exit the OSD completely.

4.2.5 Tint

Press the  button to highlight the Tint selection.

Press the  button to start adjusting the tint and the menu page will disappear and be replaced by a small Tint Indicator Bar so you can see the tint adjustment to the left or right of the nominal position.

Use the  or  button to adjust the level.





The Tint adjusts the hue of the picture. The easiest way to set tint is to look at flesh tones and adjust for a realistic appearance. In most cases, the default middle position is correct. If people's faces look too orange try reducing the level of color first as the case of this is often too much color. Once the adjustments are completed press the **LAST** button repeatedly to exit the OSD completely.



4.2.6 Sharpness

Press the  button to highlight the Sharpness selection.



Press the  button to start adjusting the sharpness and the menu page will disappear and be replaced by a small Sharpness Indicator Bar so you can see the sharpness level between the minimum and maximum available levels. Use the  or  button to adjust the level.





The Sharpness adjusts the sharpness of the picture.

Once the adjustments are completed press the **LAST** button repeatedly to exit the OSD completely.

4.2.7 Advanced Video Features

Press the  button to highlight the option for Advanced Video selection and press either the  button to select it. A new menu will be displayed showing the advanced functions available for fine tuning of the picture.

Noise Reduction (NR)

Press the  button to highlight Noise Reduction (NR). Use this feature to diminish picture artifacts caused by the digitizing of image motion content that may be present in the picture. Press the  or  button to choose from the Off, Low, Medium or Strong setting.

Once the adjustments are completed press the **LAST** button repeatedly to exit the OSD completely.

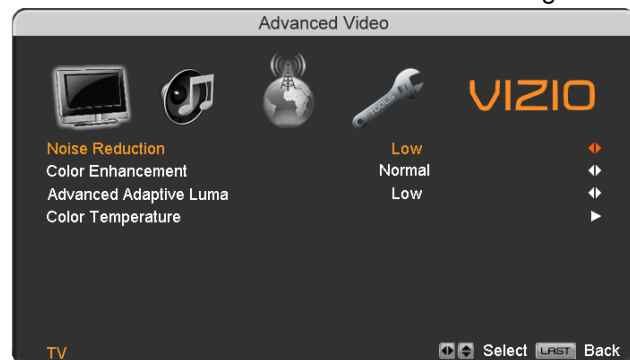

Color Enhancement

Press the  button to highlight Smart Color Enhancement. Use this feature to increase the picture reproduction performance of the picture.

Press the  or  button to choose from Off, Normal, Rich Color, Green/Flesh and Green/Blue setting.

Once the adjustments are completed press the **LAST** button repeatedly to exit the OSD completely.

Advanced Adaptive Luma

Press the  button to highlight Advanced Adaptive Luma. Large areas of darkness in a picture will result in a lower Average Picture Level (APL) and the overall picture will look too dark; activation of this feature will raise the APL to counteract this effect.

Press the  or  button to choose from the Off, Low, Medium, Strong, or Extend setting.



Once the adjustments are completed press the **LAST** button repeatedly to exit the OSD completely.



Color Temperature

Press the  button to highlight the option for Color Temperature selection.

The default is COOL; this is the 9300K setting.

Press the  or  button if you want to choose the Normal, Warm or Custom option.

If you choose the Custom option, then a new menu will be displayed showing the primary color items, Red, Green and Blue.

Press the  button to highlight the color you wish to adjust.

Press the  button to start adjusting the color and the menu page will disappear and be replaced by a small Color (Red, Green or Blue) Indicator Bar as before.

Use the  or  button to adjust the color.

Press the **OK** button when finished. Repeat the procedure to adjust the other colors if desired.

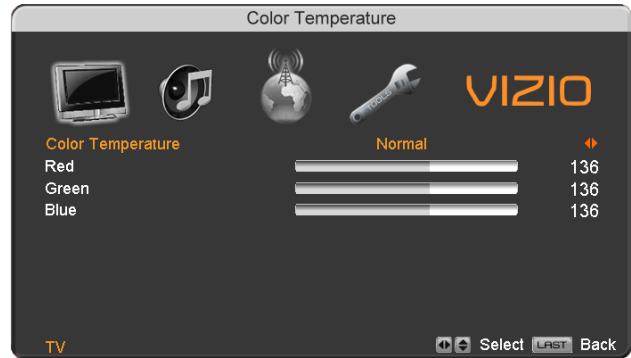

4.2.8 Reset Picture Mode

Press the  button to highlight the option for Reset Picture Mode selection

Press  button to return on Picture settings to factory default.

Once the adjustments are completed press the **LAST** button repeatedly to exit the OSD completely.

Note: Only settings under the pictures adjustment tab will be reset.

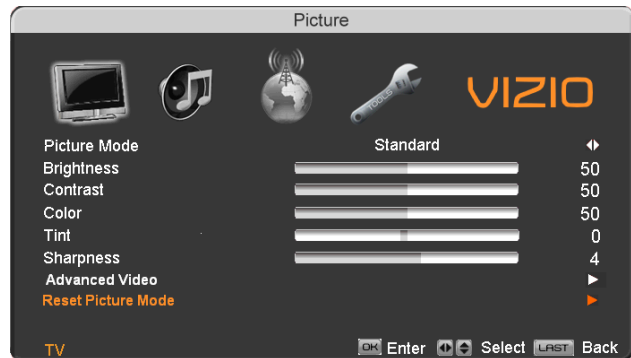



4.3 DTV / TV Input Audio Adjustment

4.3.1 Audio Mode

When the **MENU** button is pressed, the On Screen Display (OSD) appears on the PICTURE adjustment page.

Press the  button to display the AUDIO ADJUST page.

Press the  button to highlight the Audio Mode selection.

Use the  or  button to choose from Flat, Rock, Pop, Classic or Jazz.

Equalizer adjustments are available for you to set them to your preferred settings.



Once the adjustments are completed press the **LAST** button repeatedly to exit the OSD completely.

4.3.2 Equalizer



Press the  button to highlight the Equalizer selection.

Press the  button to start adjusting

A new menu will be displayed showing volumes of different frequencies (itches).

Starting from lowest to the highest pitch, they are 120 Hz, 500Hz, 1.5kHz, 5kHz and 10kHz.

Press the  button to highlight the frequency you wish to adjust.

Use the  or  button to adjust for boost or attenuation. For example if you want to boost the bass you would highlight 120Hz and turn it up.

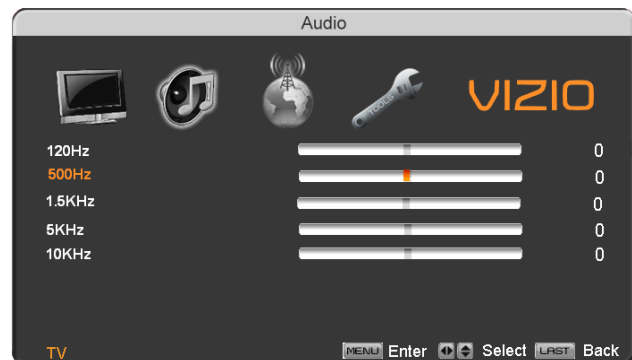



Once the adjustments are completed press the **LAST** button repeatedly to exit the OSD completely.



4.3.3 Balance

Press the  button to highlight the Balance selection.

Press the  button to start adjusting the balance and the menu page will disappear and be replaced by a small Balance Indicator Bar, as before, so you can see the balance adjustment to the left or right of the nominal position.

Use the  or  button to adjust the left/right balance.



Once the adjustments are completed press the **LAST** button repeatedly to exit the OSD completely.

4.3.4 Surround

Press the  button to highlight the Surround selection.

Press the  button to select for the simulated surround sound feature to be On or Off.

Once the adjustments are completed press the **LAST** button repeatedly to exit the OSD completely.



4.3.5 Digital Audio Out



Press the  button to highlight the Digital Audio Out selection.

Press the  or  button to make the proper selection. The options are OFF, Dolby Digital and PCM.

Once the adjustments are completed press the **LAST** button repeatedly to exit the OSD completely.

4.3.6 Speakers

Press the  button to highlight the Speakers selection.



Press either  or  button to turn the internal speakers On or Off. You may want to turn-off the internal speakers when listening to the audio through your Home Theatre System.

Press the **LAST** key once to return to the previous screen or repeatedly to return to your program if task has been completed.



4.3.7 Audio Out

Press the  button to highlight the Audio Out selection.



Press either  or  button to turn the audio out signal to Fixed or Variable. When it is set to variable, volume from the external speakers will change according to the volume setting on the TV. If it is fixed, the volume can only be changed by the settings on the external stereo system.

Press the **LAST** key once to return to the previous screen or repeatedly to return to your program if task has been completed.



4.3.8 Lip Sync

Included with the advanced technology of your TV, a feature which will compensate the shortcomings of signal transmission called audio sync (Lip Sync). Lip Sync is designed to adjust the audio of the program being viewed so that it matches the movement of the lips of someone talking on the screen. This feature is built into your set, and it can be applied to all inputs. To use this feature, follow the steps below.

Press the **MENU** key to bring up the OSD.

Using either the  or  button scroll across to the microphone icon, the Audio menu will be displayed.

Press either  or  button to scroll either up or down to Lip Sync.

Press either  or  button to make the appropriated adjustment.

Press the **LAST** key once to return to the previous screen or repeatedly to return to your program if task has been completed.



4.3.9 Reset Audio Mode

Press the  button to highlight the option for Reset Audio Mode selection

Press  button to return on Audio settings to factory default.

Once the adjustments are completed press the **LAST** button repeatedly to exit the OSD completely.

Note: Only settings under the audio adjustment tab will be reset.





4.4 DTV / TV Tuner Setup

When you first used your HDTV you will have setup your TV for DTV / TV channels using the Initial Setup screens. If you did not do this or if your setup has changed, you can do this from the TV TUNER SETUP menu.

Once the adjustments are completed press the **LAST** button repeatedly to exit the OSD completely.

4.4.1 Tuner Mode

When the **MENU** button is pressed, the On Screen Display (OSD) appears on the PICTURE adjustment page. Press the  button to display the TV page.

Press the  button to highlight the Tuner Mode selection.

Press the  button to choose Cable or Air (Antenna) depending upon which equipment you have attached to the DTV / TV Input.

Once the adjustments are completed press the **LAST** button repeatedly to exit the OSD completely.

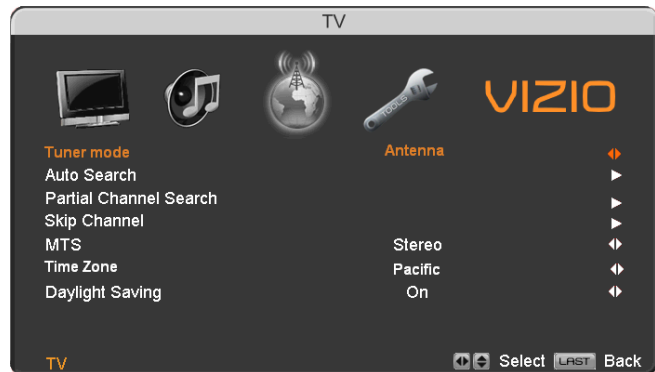

4.4.2 Auto Search

Press the  button to highlight the Auto Search selection.

Press the  button to Auto Search for TV channels available. The TV will automatically search for analog and digital channels.

Once the adjustments are completed press the **LAST** button repeatedly to exit the OSD completely.

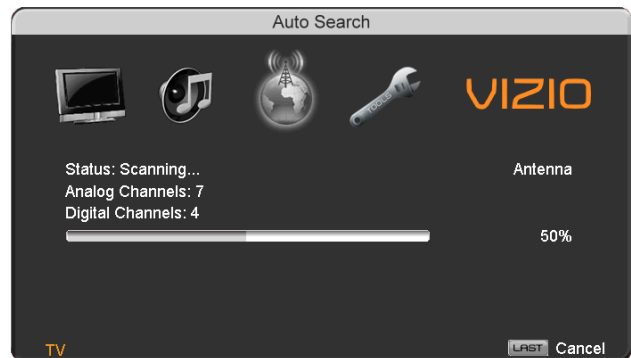



4.4.3 Partial Channel Search

If you believe channels are missed from the auto search, you can do a partial channel search to look for channel in a certain channel range again. Press the  button to highlight the Partial Channel Search selection.

Press the  button to enter the submenu.

Press the  button to select scan mode to look for Analog, Digital, or both Analog/Digital channels.



Press the  button to highlight the “To” and “From” selection. Press the  button to select the range of channel numbers you want to start searching in.

Press **OK** to start channel search.

Once the adjustments are completed press the **LAST** button repeatedly to exit the OSD completely.





4.4.4 Skip Channel

After the TV has stored all of the available DTV channels in memory you will find that some channels will be too weak to watch comfortably or they may be channels you do not want to see. Select the channel you wish to remove, press **OK** and  buttons to open the TV TUNER SETUP menu and then press the  button to highlight SKIP CHANNEL. Press the  button to select this channel to be skipped when using the CH+ or CH- button. You will still be able to select this channel using the number buttons on the remote control.

4.4.5 MTS

This feature allows you, the user to select the different languages in which the signal provider or broadcaster is transmitting the audio with the program you are watching. This signal is usually or in most cases Spanish language.

Press the  button as many times as it takes to scroll down to this option and get it highlighted.

Press either  or  button to go through the settings of this feature to make your selection.

Once the adjustments are completed press the **LAST** button repeatedly to exit the OSD completely.

4.4.6 Time Zone

Setting the correct Time Zone for your area will ensure that the correct program times are shown after pressing the **MENU** button on the remote control.

Press the  button to highlight the Time Zone selection.

Press the  or  button to select your area.

Once the adjustments are completed press the **LAST** button repeatedly to exit the OSD completely.

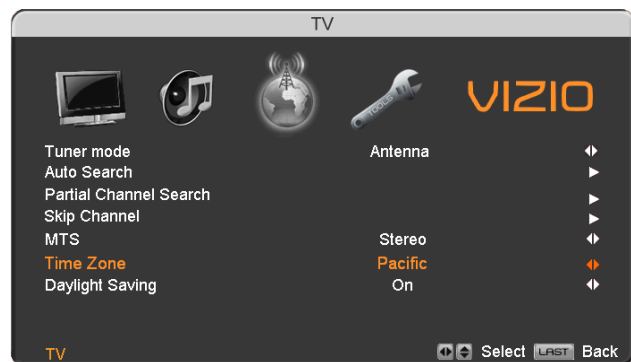

4.4.7 Daylight Saving

As for Time Zone, setting the daylight saving time for your area will ensure that the correct program times are shown after pressing the GUIDE button on the remote control.

Press the  button to highlight the Daylight Saving selection.

Press the  or  button to select On or Off.

Once the adjustments are completed press the **LAST** button repeatedly to exit the OSD completely.



4.5 DTV / TV Input Setup

4.5.1 Language

When the **MENU** button is pressed, the On Screen Display (OSD) appears on the PICTURE adjustment page. Press the  button until the SETUP page is displayed.

Press the  button to highlight the Language selection. The default is English.

Press the  or  button to select Español or Français.

Once the adjustments are completed press the **LAST** button repeatedly to exit the OSD completely.





4.5.2 PIP (Picture-in-Picture)

Press the  button to highlight the PIP(Picture-in-Picture) selection.

Press the  button. A separate menu will appear with the following PIP settings.

PIP Mode



Press the  button to highlight the PIP mode selection.

Press the  or  button to select Off, PIP or POP(Picture-outside picture). In the PIP mode a smaller sub screen will be displayed on top of the main screen. For the POP mode the main screen and sub screen will be of equal size and be positioned side by side.



PIP Input

When PIP or POP is selected, Press the  button to highlight the PIP input selection.

Press the  or  button to choose the input source for the sub screen. The input sources available will vary according to which input is used for the main screen; see the table below to find which inputs can PIP/POP with each other.



See below for detailed information regarding the PIP sources.

MAIN \ SUB	DTV	TV	AV	Component	HDMI1	HDMI2	HDMI3	HDMI4	RGB
DTV				✓	✓	✓	✓	✓	✓
TV				✓	✓	✓	✓	✓	✓
AV				✓	✓	✓	✓	✓	✓
Component	✓	✓	✓		✓	✓	✓	✓	
HDMI 1	✓	✓	✓	✓					✓
HDMI 2	✓	✓	✓	✓					✓
HDMI 3	✓	✓	✓	✓					✓
HDMI 4	✓	✓	✓	✓					✓
RGB	✓	✓	✓		✓	✓	✓	✓	

 – Indicates which inputs are available for PIP and POP modes.



PIP Position

When PIP is selected, Press the  button to highlight the PIP position selection.

Press the  or  button to choose where on the picture you want the PIP screen positioned over the main screen.



PIP Size

When PIP is selected, Press the  button to highlight the PIP size selection.

Press the  or  button to choose Small, Medium or Large.

PIP Audio Source

When PIP or POP is selected, Press the  button to highlight the PIP audio source selection.

Press the  or  button to choose the audio source from the main screen or the sub screen.

Once the adjustments are completed press the **LAST** button repeatedly to exit the OSD completely.



4.5.3 Adjusting Basic PIP Settings

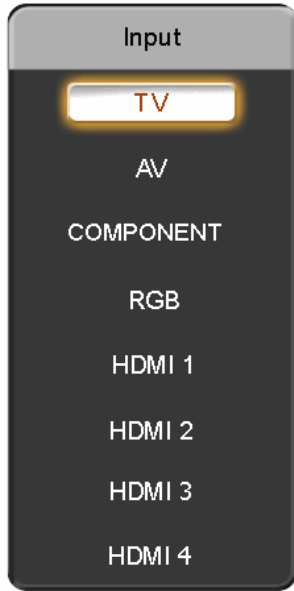

The PIP channel is independent of the main TV channel. To change the PIP channel, press the PIP CH button on the remote control. Alternatively, you can change the PIP channel by pressing the CH+ or CH- button.

Repeated pressing of the PIP button will turn on, turn off the PIP mode.

Press the PIP SIZE button to alternate between Small, Medium and Large PIP sizes.

Repeated pressing of the PIP INPUT button will cycle through the inputs for PIP. This button has no effect when PIP is off.





You can swap the program that is in the main picture with the program in the PIP sub-picture. To swap the main picture program with the PIP sub-picture program, press SWAP on the remote control. If you press SWAP again, it will return the program to the main picture.



4.5.4 Sleep Timer

Press the  button to highlight the Sleep Timer selection.

Press the  or  button to select the timer to turn-off the TV in 30, 60, 90 or 120 minutes.



Once the adjustments are completed press the **LAST** button repeatedly to exit the OSD completely.



4.5.5 Wide

The Wide option is the feature which allows you to select how your display would be size wise. When in TV mode; the selections are Normal, Wide, Zoom and Panoramic views.

Press the  button as many times as it takes to scroll down to this option and highlight it.

Press either  or  button to make the correct selection, you will see the screen adjusting to the different sizes which apply to this feature.

Once the adjustments are completed press the **LAST** button repeatedly to exit the OSD completely.



4.5.6 Input Naming

This feature has been added to facilitate you, the user in identifying or label the input and signal which is being watched. You could use up to 7 characters; either letters or numbers or combinations of both.



Press  button to highlight this option.

Press  button to obtain the next screen which shows the different inputs.

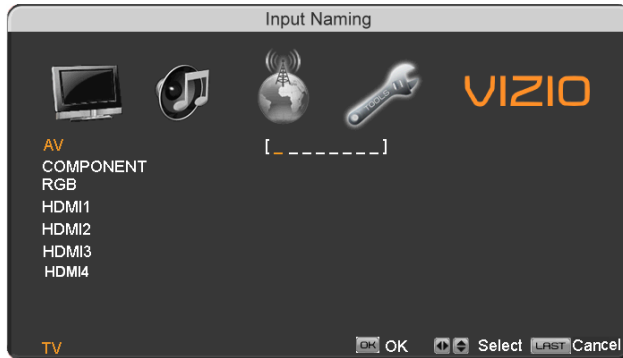

Press  button to select the desired input which you want to label or name (Examples: VCR, DVD,..., etc.) it with any name which will make easier for you to recognize it.

Press the **OK** key to go to the first space () in the bracket.



Press either the  or  button and select either the letter or number belongs to this place.

Press the  button to go to the next space () and again

Using either the  or  button select the second character of the name given to this Input.

Repeat the last previous two steps until the name of the input is completed.



Press the **OK** key to accept the name of the input or the **LAST** key to cancel the setting. .

Press the **LAST** key when you have finished to go to the previous menu.

Since you are already in this feature; it is recommendable to name all the Inputs which are being used as well as these for which you have an idea what their name is going to be.

Press the **LAST** key once to return to the previous screen or repeatedly to return to your program if task has been completed.



4.5.7 CC (Closed Caption)

Press the  button to highlight the CC (Closed Caption) selection.

Press the  button. A separate menu will appear with the following CC settings

Closed Caption on Mute

When selecting Closed Caption as a feature to be used; Closed Caption On Mute will provide you with the option to obtain closed captioning when you press the key labeled mute on your Remote Control.

Press  button as many times as it takes to get this option highlighted.

Press either  or  button to toggle between Off and On to make the correct selection.

Press the key labeled **LAST** as many times as it takes to exit the menu screens.



CC

When watching regular analog (NTSC) TV, the CC feature is available in the Setup menu.

Press the  button to highlight the CC selection.

Press the  button to select CC1, CC2, CC3 or CC4.

Once the adjustments are completed press the **LAST** button repeatedly to exit the OSD completely.

Closed Caption for regular TV is usually CC1 or CC2.



Digital Closed Caption Style

When watching DTV, the Digital CC Style feature is available in the Setup menu.

Press the  button to highlight the Digital CC Style selection.

Press the  button to go to the next screen.

Press either  or  button to toggle between the two options; As Broadcaster and Custom.

If Custom is selected then you will have the way of customize the way Closed Caption will be displayed by changing these different parameters to your like: **Font Size** (letters size), **Font Color** (letters color) **Font Opacity** (transparency of the letters), **Background Color** (color of the background area where Closed Caption is going to be displayed), **Background Opacity** (allows to either see through at the scene being played or it could be a solid screen), **Window Color** (it gives the color to the area where characters will be displayed on) and finally **Window Opacity** (allows the area of the characters to be changed) . There are no

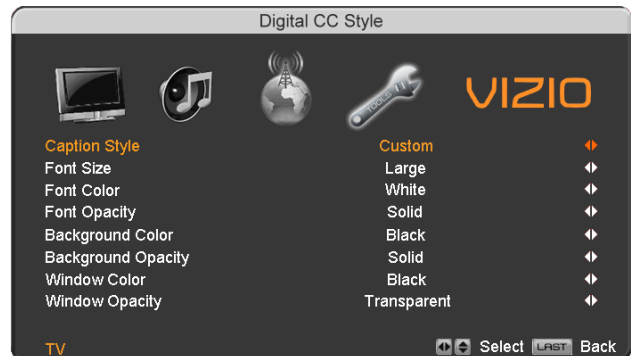

recommendations of setting these parameters since you, the user would have your own taste or like of them.

Press the key labeled **LAST** as many times as it takes to exit the menu screens.

4.5.8 H/V Position



Press the  button to highlight the H/V Position selection.

Press the  button. A separate menu will appear with the following H/V Position settings

H. Position

Press the  button to highlight the Horizontal Shift selection.

Press the  button to start adjusting the horizontal position of the picture.

Use the  or  button to adjust the horizontal position.



Once the adjustments are completed press the **LAST** button repeatedly to exit the OSD completely.



V. Position

Press the  button to highlight the Vertical Shift selection.

Press the  button to start adjusting the vertical position of the picture.

Use the  or  button to adjust the vertical position.



Once the adjustments are completed press the **LAST** button repeatedly to exit the OSD completely.



H-SIZE

Press the  button to highlight the H-Size selection.

Press the  button to start adjusting the horizontal size of the picture.



Use the  or  button to adjust the horizontal size.

Once the adjustments are completed press the **LAST** button repeatedly to exit the OSD completely.

V-SIZE

Press the  button to highlight the V-Size selection.

Press the  button to start adjusting the vertical size of the picture.

Use the  or  button to adjust the vertical size.

Once the adjustments are completed press the **LAST** button repeatedly to exit the OSD completely.





4.5.9 DTV / TV Input Parental Control

If you want to restrict certain channel and program viewing, you can do this by turning on the Parental Control. Selected programs, movies and channels can then be made available only after an authorized password has been entered and accepted by the TV.

When the **OK** button is pressed, the On Screen Display (OSD) appears on the PICTURE adjustment page.

Press the  button to display the SETUP page.

Press the  button to highlight Parental, then press the  button.

The Password must be entered before the TV will continue with Parental settings. The default password set in the factory is 0 0 0 0. If you are going to use the Parental Control feature you should change the password.

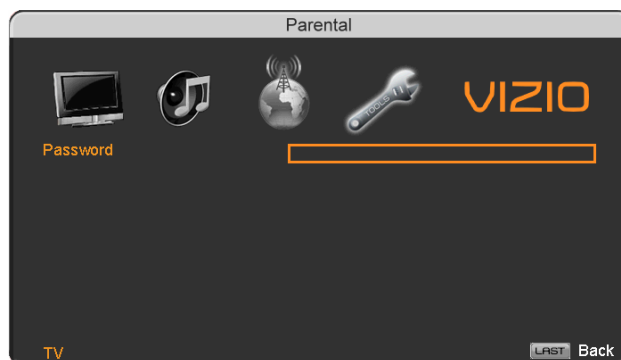

Note: Make sure you write down and store the new password in a secure place. The Reset All Settings feature (see page 62) does NOT reset the password.

4.5.10 Channel Block

Press the  button to highlight the Channel Block selection.

Press the  button to go to the next screen.

Press the  button to highlight the channel you want to block.

Press the **OK** button to block the highlighted channel.

Once the adjustments are completed press the **LAST** button repeatedly to exit the OSD completely.



4.5.11 US TV Rating

Follow the procedure in the previous section to display the Parental Control menu and then press the  button to highlight the US TV Rating selection.

Press the **OK** button and the Block TV Rating panel will be displayed.

In the Block TV Rating panel you can customize the program blocking of the following TV ratings:

Y – All children

Y7 – Older children

G – General audience

PG – Guidance suggested

14 – Strongly cautioned

MA – Mature audience

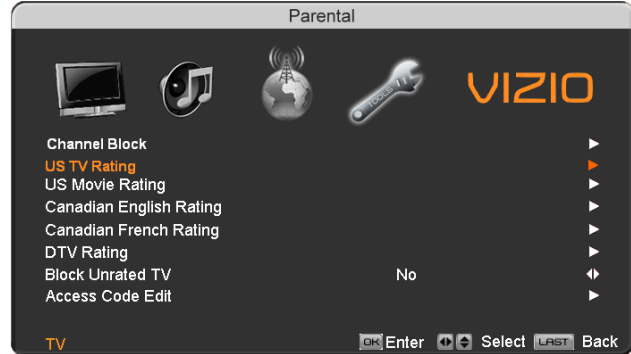

You can also customize the TV ratings for the following content:

A – All subratings

D – Sexual dialog

L – Adult language

S – Sexual situations

V - Violence

FV – Fantasy violence

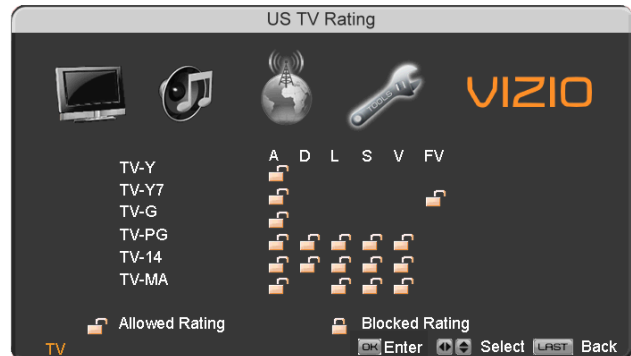

Press the  or  button to navigate through the TV rating options.

Press the **OK** button to block (locked) or allow (unlocked).





4.5.12 US Movie Rating (For US)

Press the  button to highlight the US Movie Rating selection.

Press the  button and the Block Movie Rating panel will be displayed.

In the Block Movie Rating panel you can customize the program blocking of the following Movie ratings:

- G – General audience
- PG – Parental guidance suggested
- PG-13 – Recommended for children 13 years of age or older
- R – Mature audience
- NC-17 – No one under 17 years of age
- X – No one under 17 years of age

Press the  or  button to navigate through the Movie rating options.

Press the **OK** button to block (locked) or allow (unlocked).

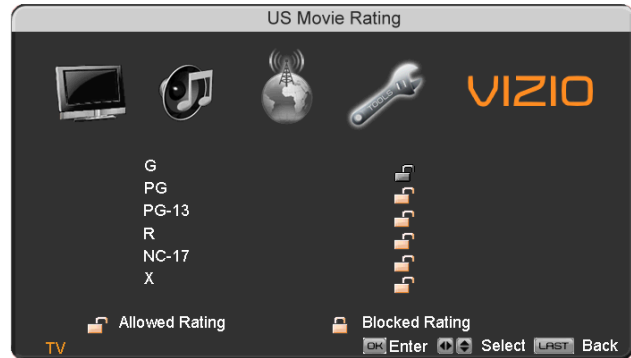

4.5.13 Canadian English Rating

Press the  button to highlight the Canadian English Rating selection.

Press the  button and the Block Canadian English Rating panel will be displayed.

In the Block Canadian English Rating panel you can customize the program blocking of the following ratings:

- C – Children
- C8+ – Children 8 years or older
- G – General Programming, suitable for all audiences
- PG – Parental guidance
- 14+ – Viewers 14 years or older
- 18+ – Adult programming

Press the  or  button to navigate through the Movie rating options.

Press the **OK** button to block (locked) or allow (unlocked).

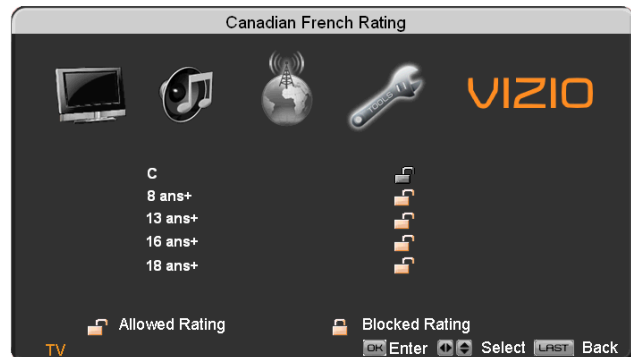

4.5.14 Canadian French Rating

Press the button to highlight the Canadian French Rating selection.

Press the button and the Block Canadian French Rating panel will be displayed.

In the Block Canadian French Rating panel you can customize the program blocking of the following ratings:

- G – General audience
- 8 ans+ – General – not recommended for young children
- 13 ans+ – Not suitable for children under 13 years of age
- 16 ans+ – Not suitable for under 16 years of age
- 18 ans+ – Adults only

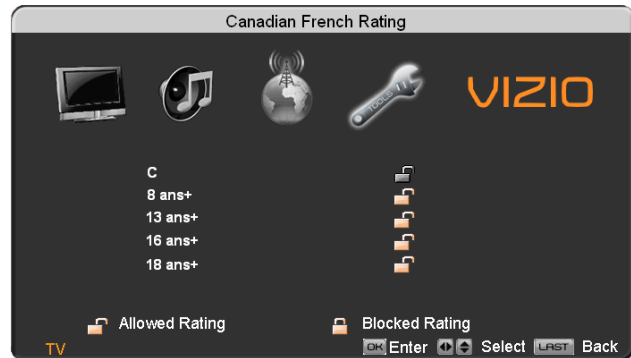

Press the or button to navigate through the Movie rating options.

Press the **OK** button to block (locked) or allow (unlocked).

4.5.15 DTV Rating

This option is designed to update the TV or Movie table of different ratings for programs being viewed in your local or regional area. It will allow the parental guidance control feature in your TV to have the most current parental control database for a digital signal. This option may be available in the future for activation. This option works as follows: Whenever you decide to use the Parental Control feature and this option has been activated in your area, the Check for New DTV Rating will be a solid color indicating that an update is available for any rating tables. After entering the password, the Parental menu will appear on the screen, and then do the following.

Observe the status of the **DTV Rating**. Press either or button to select this option.

Press button to execute this operation. Please follow the on screen instructions to complete this procedure.





Press either or to select and then adjust any other option in this menu.

Press the **LAST** key once to return to the previous screen or repeatedly to return to your program if task has been completed.



4.5.16 Blocked Unrated Programming

Follow the procedure in the previous section 4.5.9 to display the Parental Control menu and then press the  button to highlight the Block Unrated TV selection.

Press the  button to turn-on or turn-off the blocking of programming that does not have a rating.

Once the adjustments are completed press the **LAST** button repeatedly to exit the OSD completely.

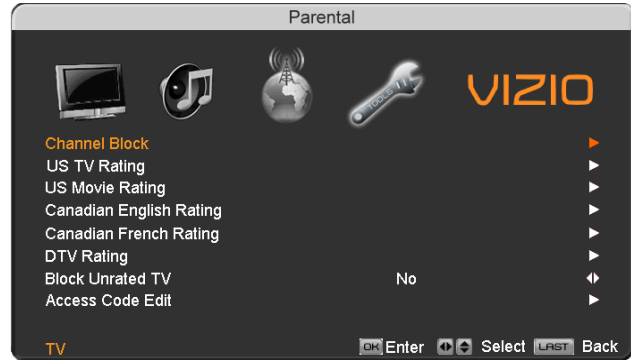

4.5.17 Change the Password

Press the  button to highlight the Access Code Edit selection.

Press the  button and the new Password panel will be displayed.

Enter the new, 4-digit password using the number buttons on the remote. Enter it a second time to confirm you entered it correctly.

Once the adjustments are completed press the **LAST** button repeatedly to exit the OSD completely.

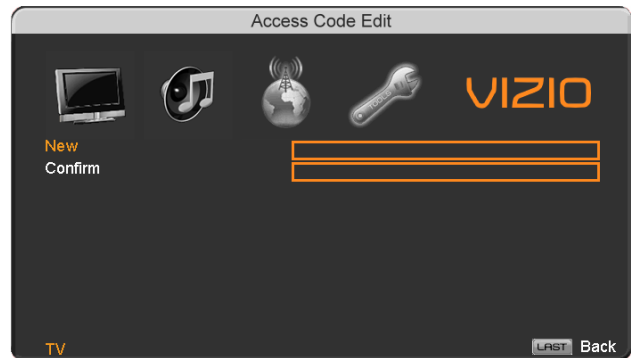
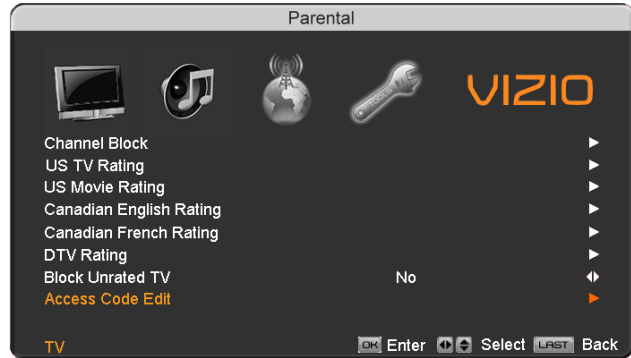

Note: Make sure you write down and store the new password in a secure place. The Reset All Settings feature (see below) does NOT reset the password.



4.5.18 Reset All Settings

Press the  button to highlight the Reset All Settings selection.

Press the  button to reset the TV to the default factory settings.

Once the adjustments are completed press the **LAST** button repeatedly to exit the OSD completely.

Note: This does NOT reset the Parental Control Password.



4.5.19 Image Cleaner

This feature may allow ghosts of previous images to be removed.

Press the  button to highlight the Image Cleaner option.

Press the  button to turn this feature On

It usually takes 60 or more minutes for this feature to run a full cycle, and then the TV will turn off automatically without any supervision

Note: Prolonged display of stationary images (such as on a video game or a computer or a still picture) will cause them to remain on the screen. Higher brightness and contrast levels will make the panel more susceptible to image retention. To minimize image retention, reduce the degree of brightness and contrast of the screen when displaying a still image. Image Cleaner will not remove images that have been displayed for too long. Image sticking is not covered under standard warranty.



4.6 HDMI Input Picture Adjustment

The Picture Adjust menu operates in the same way for the HDMI Input as for the DTV / TV input in section 4.2. Once the adjustments are completed press the **LAST** button repeatedly to exit the OSD completely.



4.7 HDMI Input Audio Adjustment

The Audio Adjust menu operates in the same way for the HDMI Input as for the DTV / TV input in section 4.3.



4.8 HDMI Input Setup

The Setup menu operates in the same way for the HDMI Input as for the TV input in section 4.5. The menu difference is that there is no DTV / TV or Parental Control adjustments.



4.9 Video Input Picture Adjustment

The Picture Adjust menu operates in the same way for Video Inputs (Component and AV) as for the DTV / TV input in section 4.2. The menu difference is that there is no icon along the top for DTV / TV adjustments.

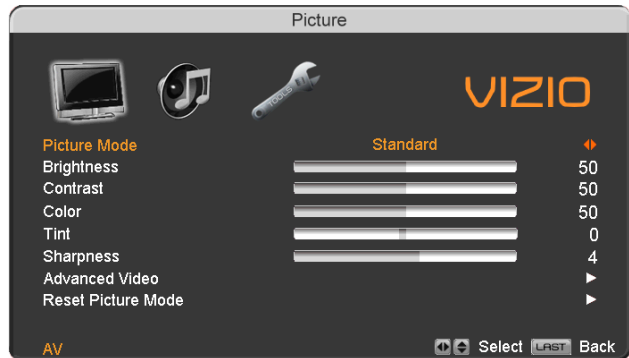

4.10 Video Input Audio Adjustment

The Audio Adjust menu operates in the same way for Video Inputs (Component and AV) as for the DTV / TV input in section 4.3. The menu difference is that there is no icon along the top for DTV / TV adjustments.

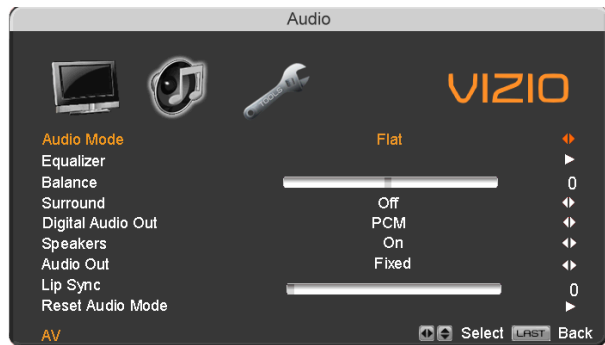

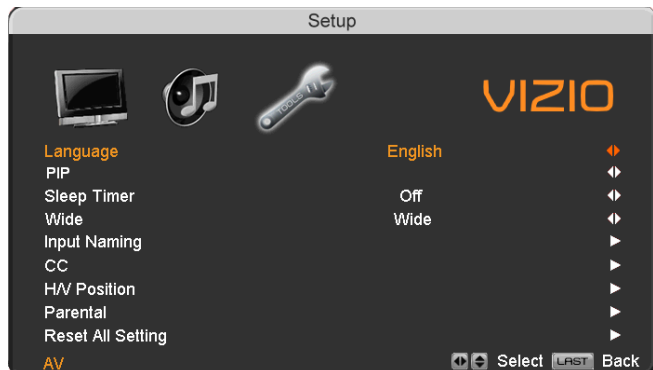

4.11 Video Input Setup

The Setup menu operates in a similar way for Video Inputs (Component and AV) as for the TV input in section 4.5. The menu difference is that there is an auto phase setting under the H/V Position submenu when using Component input.



4.11.1 Auto Phase (for Component input)

Press the  button to highlight the H/V Position.

Press the  button and the new H/V Position submenu will be displayed.

Press the  button to highlight Auto Phase.

Press the  button to execute this option. The TV will automatically look for the phase of the signal to fine tune the picture.

Once the adjustments are completed press the **LAST** button repeatedly to exit the OSD completely.



4.12 Video Input Parental Control

The Parental Control menu operates in the same way for Video Inputs (Component and AV) as for the DTV / TV input in section 4.5.9. The menu difference is that there is no icon along the top for DTV / TV adjustments.





4.13 PC Input Picture Adjustment

The Picture Adjust menu operates in the same way for the PC Input as for the DTV / TV input in section 4.2 for Contrast, Brightness and Color Temperature.

4.13.1 Auto Adjust

When the **MENU** button is pressed, the On Screen Display (OSD) appears on the PICTURE adjustment page.

Press the  button to highlight the Auto Adjust selection.

Press the  button for the PLASMA HDTV to adjust to the PC signal timing automatically.

Once the adjustments are completed press the **LAST** button repeatedly to exit the OSD completely.

The Backlight level does not affect the Brightness (black level) or Contrast (white level) of the picture, it adjusts the lamp current and this affects the overall brilliance of the picture.

Once the adjustments are completed press the **LAST** button repeatedly to exit the OSD completely.

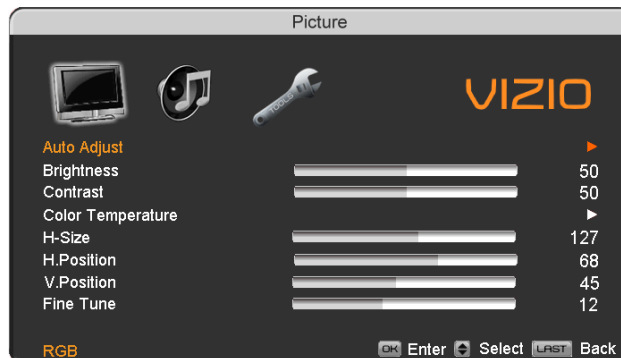

4.13.2 Brightness

Press the  button to highlight the Brightness selection.

Press the  button to start adjusting the brightness and the menu page will disappear and be replaced by a small Brightness Indicator Bar so you can see the brightness level between the minimum and maximum available levels.

Use the  or  button to adjust the level.





The Brightness adjusts the black levels in the picture. If the brightness is too low you will not be able to see the detail in darker parts of the picture and if the brightness is too high the picture will look washed out.

Once the adjustments are completed press the **LAST** button repeatedly to exit the OSD completely.

4.13.3 Contrast

Press the  button to highlight the Contrast selection.

Press the  button to start adjusting the contrast and the menu page will disappear and be replaced by a small Contrast Indicator Bar so you can see the contrast level between the minimum and maximum available levels.

Use the  or  button to adjust the level.

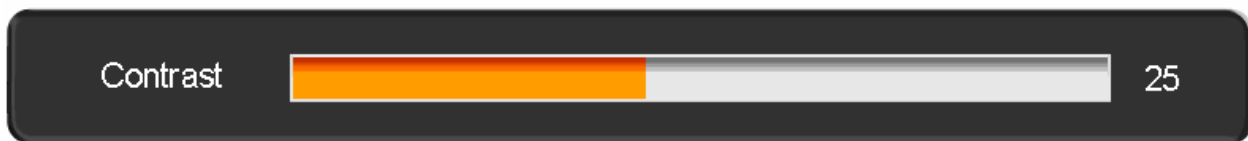

The Contrast adjusts the white levels in the picture. If the contrast is too low the picture will look washed out and if the contrast is too high you will not be able to see any detail in the bright parts of a picture.



Once the adjustments are completed press the **LAST** button repeatedly to exit the OSD completely.



4.13.4 Color Temperature

Press the  button to highlight the option for Color Temperature selection.



The default is the 9300K (Cool) setting.

Press the  or  button if you want to choose the 9300, 6500 or Custom option.

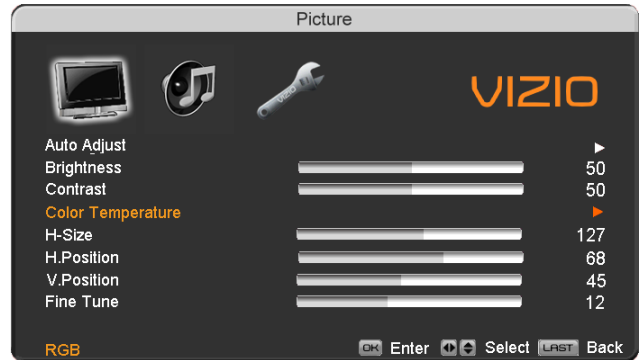
Once the adjustments are completed press the **LAST** button repeatedly to exit the OSD completely.



If you choose the Custom option, then a new menu will be displayed showing the primary color items, Red, Green and Blue. Press the  button to highlight the color you wish to adjust.

Press the  button to start adjusting the color and the menu page will disappear and be replaced by a small Color (Red, Green or Blue) Indicator Bar as before. Use the  or  button to adjust the color.

Press the **OK** button when finished. Repeat the procedure to adjust the other colors if desired.

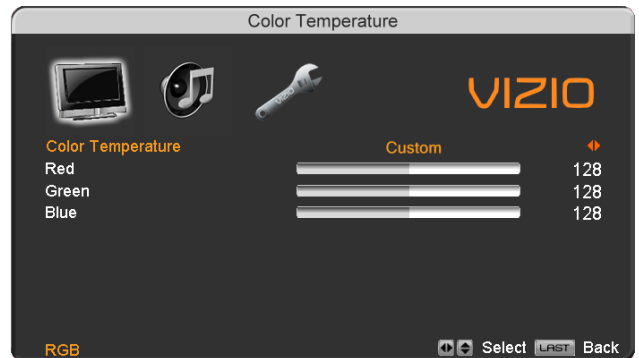

Once the adjustments are completed press the **LAST** button repeatedly to exit the OSD completely.



4.13.5 H-SIZE

Press the  button to highlight the H-Size selection.

Press the  button to start adjusting the horizontal size of the picture.



Use the  or  button to adjust the horizontal size.

Once the adjustments are completed press the **LAST** button repeatedly to exit the OSD completely.

4.13.6 H. Position

Press the  button to highlight the Horizontal Shift selection.

Press the  button to start adjusting the horizontal position of the picture.

Use the  or  button to adjust the horizontal position.



Once the adjustments are completed press the **LAST** button repeatedly to exit the OSD completely.



4.13.7 V. Position

Press the  button to highlight the Vertical Shift selection.

Press the  button to start adjusting the vertical position of the picture.

Use the  or  button to adjust the vertical position.

Once the adjustments are completed press the **LAST** button repeatedly to exit the OSD completely.

4.13.8 Fine Tune

Press the  button to highlight the Fine Tune selection.

Press the  button to start tuning the to the PC signal.

Use the  or  button to adjust the tuning.

Once the adjustments are completed press the **LAST** button repeatedly to exit the OSD completely.

4.14 PC Input Audio Adjustment

The Audio Adjust menu operates in the same way for the PC Input as for the DTV / TV input in section 4.3. The menu difference is that there are no icons along the top for DTV / TV and Parental Control adjustments.

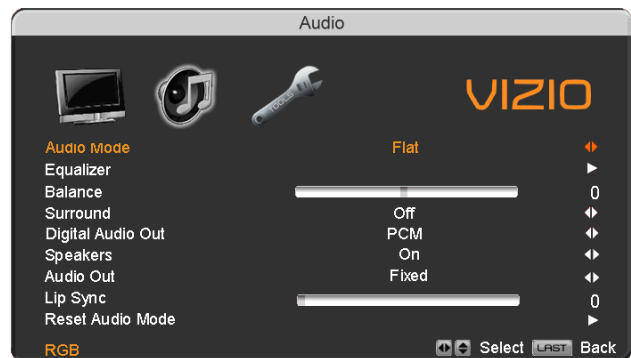

4.15 PC Input Setup

The Setup menu operates in the same way for the PC Input as for the DTV / TV input in section 4.4. The menu difference is that there is no icon along the top for TV adjustments and no Closed Caption.

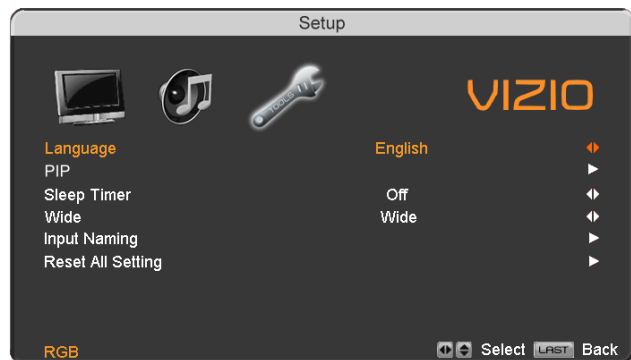

4.16 Understanding Viewing Features

Your HDTV features the following viewing modes. You can switch viewing modes using the remote control, please follow the instructions in page 37.

4.16.1 Viewing Modes

Normal Mode

The original 4:3 aspect ratio (1.33:1 source) is preserved, so black bars are added to the left and right of the display image. Standard TV broadcasts are displayed with a 4:3 Aspect Ratio. Movies in 4:3 Aspect Ratio may be referred to as pan-and-scan or full frame. These movies were originally filmed in 16:9 (widescreen), and then modified to fit a traditional TV screen (4:3).

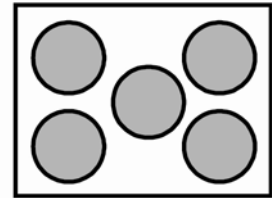

Wide Mode

When watching a standard broadcast or full-frame movie in this mode, the display image is stretched proportionately to fill the TV screen. When watching a standard definition 4:3 source the picture will stretch horizontally and fill the screen; people will look fatter than they are. When watching a widescreen (1.78:1 source) program or movie, the display image fills the TV screen. If you are watching a widescreen (1.85:1 or 2.35:1 source) program or movie, there will still be black bars at the top and bottom.

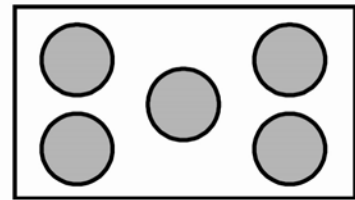

Zoom Mode

When watching a widescreen (1.78:1, 1.85:1, or 2.35:1 source) program or movie, the display image is zoomed proportionally to fill the width of the screen. The top and bottom are cut off to remove most of the source material's black bars. This mode is good for programs or movies with sub-titles.

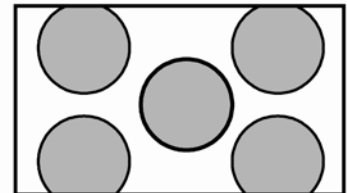

Panoramic Mode

When watching a standard broadcast or full frame movie in this mode, the 4:3 Aspect Ratio (1.33:1 source) display image is stretched horizontally on the left and right sides to fill the TV screen. The center of the image is not stretched.

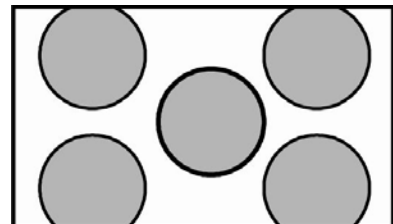

Chapter 5 Maintenance and Troubleshooting

5.1 Maintenance

Important

1. Make sure that the power cable is removed from the socket before cleaning the TV.
2. Do not use volatile solvent (such as toluene, rosin and alcohol) to clean the TV. Such chemicals may damage the housing, screen glass and remote control, and cause paint to peel.

Cleaning the Housing and Remote Control

1. Use a soft cloth for cleaning.
2. If the housing or remote control is seriously contaminated, use a soft cloth moistened with diluted neutral cleaner to clean the display. Wring water out of the cloth before cleaning to prevent water from penetrating into the housing. Wipe the display with a dry cloth after cleaning.

Cleaning the Screen

1. Use a soft cotton cloth to gently clean the screen.
2. The screen glass is very fragile. Do not scrape it with any sharp object. Do not press or tap the screen to avoid cracking. When the screen is seriously contaminated, use a soft cloth moistened with diluted neutral cleaner to clean the display. Wring water out of the cloth before cleaning to prevent water from penetrating into the housing. Wipe the display with a dry cloth after cleaning.

5.2 Troubleshooting Guide

If the TV fails or the performance changes dramatically, check the display in accordance with the following instructions. Remember to check the peripherals to pinpoint the source of the failure. If the display still fails to perform as expected, contact the VIZIO for assistance by calling 1-877-MYVIZIO (698-4946) or e-mail us at techsupport@vizio.com.

Problem	Solution
No power.	<p>Make sure the power button is ON (White VIZIO Logo).</p> <p>Make sure AC power cord is securely connected to the AC socket.</p> <p>Plug another electrical device (like a radio) to the power outlet to verify that the outlet is supplying the proper voltage.</p>
No sound.	<p>Check your audio connection</p> <p>Press MUTE on the remote control again, so that MUTE disappears from the screen</p> <p>Check your audio settings, your TV audio may be set to SAP, min or speakers off</p> <p>Press the Volume + (Up) key on your remote control</p>



Problem	Solution
	Make sure that headphones are not connected
If the screen is black.	Check your input connections.
Power is ON but no screen image.	<p>Make sure the video cable supplied with the TV is secured to the correct video output port on the back of the VCR and the TV. Make any cable you have attached to the TV is secured to the correct output your Set-Top Box, DVD, etc.</p> <p>Adjust brightness and contrast.</p> <p>Check Source settings.</p>
Wrong or abnormal colors appear.	If any colors (red, green, or blue) are missing, check the video cable to make sure it is securely connected.
Control buttons do not work.	Press only one button at a time.
Remote Control does not work.	<p>Make sure batteries are inserted correctly</p> <p>Batteries could be weak.</p> <p>Make sure you have selected TV on the remote.</p>
There appears to be image quality issues.	For best image quality, view HD wide screen programs where possible. If HD content is not available view "Standard Definition" from a digital source. Standard, analog TV will always be noticeably inferior to HD because your digital flat panel TV has video that is many times better than old TV's and so you can see interference and deficiencies you did not know you had.
You cannot see a picture.	<p>Make sure that the power cord is plugged into a grounded electrical outlet.</p> <p>Make sure that the power button is turned on.</p> <p>Make sure that the selected input source is connected to a working input source.</p> <p>If your TV is connected to your computer in RGB or HDMI mode, press any key on your keyboard to "wake" your computer.</p>
You see a distorted picture or hear unusual sound.	You may be getting interference from electrical appliances, cars, motorcycles, or fluorescent lights. If you have not mounted it on the wall, try moving your TV to another location to see if this is the cause of the problem.
The picture has abnormal patterns.	<p>Make sure that the input source cable is attached securely and correctly to the back of your TV.</p> <p>Make sure that the video input source is within the range of your TV. Compare the video input source's specifications with your TV specifications.</p>
The display image does not cover the entire screen.	<p>If you are using RGB mode, make sure that H Size and V Position in the On Screen Display (OSD) are set correctly.</p> <p>If you are using TV, AV-C (Composite), AV-S (S-Video) or Component with 480i input, follow instructions in page 53 to obtain the desired screen mode.</p>
You can see a picture but you cannot hear sound.	<p>Make sure that the volume is not turned down.</p> <p>Make sure that the sound is not muted.</p> <p>Make sure that your audio input source cables are connected securely and correctly.</p>
The TV has pixels that are always dark or colored.	Your PLASMA HDTV is manufactured using an extremely high level of precision technology, however, sometimes some pixels of your PLASMA



Problem	Solution
	HDTV may not display. Pixel defects within industry specifications are inherent to this type of product and do not constitute a defective product.
You see "noise" or "trash" on the screen.	When your PLASMA HDTV's digital capabilities exceed a digital broadcast signal, the signal is up-converted (increased) to match your TV's display capabilities. Up-converting can cause noise or trash.
You switch to a different input and the volume changes.	The TV remembers the volume level from the last time you adjusted it. If the sound level is higher or lower from another source, then the loudness will change.
You switch to a different input and the screen size changes.	The TV remembers the viewing mode from the last time you used a particular input (AV-C (Composite), AV-S (S-Video), Component, HDMI and TV).



<p>Tips for High-Definition Users.</p>	<p>The PLASMA HDTV is an ideal platform for viewing High Definition Content. Best Image Quality will be achieved by the HDMI Input, then YPbPr, then RGB. However, due to variances in broadcast practices, it is possible some image distortions can occur.</p>
<p>Tips for Letterbox Content Users.</p>	<p>Letterboxed (or “Widescreen”) versions of DVD movies are most commonly formatted for standard 4:3 Televisions. The PLASMA HDTV has the capability of expanding this content so the entire screen is filled at the expense of image accuracy. Follow the instructions in page 53.</p>

5.3 Telephone & Technical Support

Products are often returned due to a technical problem rather than a defective product that may result in unnecessary shipping charges billed to you. Our trained support personnel can often resolve the problem over the phone. For more information on warranty service or repair, after the warranty period, please contact our Support Department at the number below.

Customer support and quality service are integral parts of VIZIO’s commitment to service excellence. For technical assistance contact our VIZIO Technical Support Department via email or phone.

E-mail: techsupport@vizio.com

Tel: 877-MYVIZIO (877-698-4946)

Hours of operations:

6:00am – 9:00pm PST Monday – Friday

8:00am – 4:00pm PST Saturday – Sunday

Please have your VIZIO model number, serial number and date of purchase available before you call.

VIZIO

39 Tesla

Irvine, CA 92618

Tel: (949) 428-2525 Fax: (949) 585-9514

Web: www.VIZIO.com



5.4 Compliance

Caution: Always use a power cable that is properly grounded. Please use the AC cords listed below for each area.

USA	UL
Canada	CSA
Germany	VDE
UK	BASE/BS
Japan	Electric Appliance Control Act

5.5 FCC Class B Radio Interference Statement

NOTE: This equipment has been tested and found to comply with the limits for a Class B digital device, pursuant to Part 15 of the FCC Rules. These limits are designed to provide reasonable protection against harmful interference in a residential installation. This equipment generates, uses and can radiate radio frequency energy, and if not installed and used in accordance with the instructions, may cause harmful interference to radio communications. However, there is no guarantee that interference will not occur in a particular installation. If this equipment does cause harmful interference to radio or television reception, which can be determined by turning the equipment off and on, the user is encouraged to try to correct the interference by one or more of the following measures:

1. Reorient or relocate the receiving antenna.
2. Increase the separation between the equipment and receiver.
3. Connect the equipment into an outlet on a circuit different from that to which the receiver is connected.
4. Consult the dealer or an experienced radio/TV technician for help.

Notice:

1. The changes or modifications not expressly approved by the party responsible for compliance could void the user's authority to operate the equipment.
2. Shielded interface cables and AC power cord, if any, must be used in order to comply with the emission limits.
3. The manufacturer is not responsible for any radio or TV interference caused by unauthorized modification to this equipment. It is the responsibilities of the user to correct such interference.



Chapter 6 Miscellaneous Information

6.1 Specifications

Specifications	
Panel	50" Diagonal, 16:9 Aspect Ratio
Resolution	1920 x 1080 pixels
Pixel (Dot) Pitch	0.576 mm (H) x 0.576 mm (V)
Display Compatibility	Full HDTV (1080P)
Colors	1.073 Billion
Brightness	1,000 cd/m ² (typical)
Contrast	30000:1 (typical)
Viewing Angle	Up to 178° (horizontal/vertical)
Inputs	1 x Co-axial RF (ATSC/QAM/NTSC), 4 x HDMI™ (v1.3) with HDCP (plus 1 x Stereo Audio RCA for DVI source), 1 x Component YPbPr plus Stereo Audio, 1 x RGB PC plus Stereo Audio, 1 x S-Video (AV) plus Stereo Audio, 1 x Composite Video (AV)
Outputs	1x SPDIF Optical Digital Audio, 1x Analog Stereo Audio
Features	ATSC/Clear QAM tuner, NTSC video decoding via RF or composite video, 3:2 or 2:2 reverse pull-down, Motion adaptive de-interlace, Progressive video scan via component video/VGA/HDMI, HDTV via HDMI or component video, FHDTV via HDMI or component video, Color temperature adjustments of 5400K/6500K/9300K, Independent Red/Green/Blue adjustments for color temperature fine tuning, Signal Compatibility 480i (SDTV), 480P (EDTV), 720P (HDTV), 1080i (HDTV), 1080P (FHDTV), Computer support at 640x480/800x600/1024x768/1360x768 via VGA/HDMI,
Speakers	Built-in, 10Wx2 Speakers
Panel Life	60,000 hours to half the original brightness
Power	
Input	IEC Connector for direct power line connection
Voltage Range	120Vac at 50/60Hz
Power Consumption	700W (max) , <1W standby
Environmental Conditions	
Operating	Temperature: 5°C~35°C, Relative Humidity: 20~80%, Altitude: 0~14,000 ft
Non-Operating	Temperature: -20°C~50°C, Relative Humidity: 10~90%, Altitude: 0~40,000 ft
Dimensions	48.57"W x 32.42"H x 10.23"D (1233.80mm x 823.40mm x 259.80mm) with stand; 48.57"W x 30.44"H x 3.71"D (1233.80mm x 773.10mm x 94.20mm) without stand
Net Weight	95.90lbs (43.50kg) with stand, 88.63lbs (40.20kg) without stand
Gross Weight	114.64lbs (52kg)



Certifications	CSA/CSA-US, FCC Class B
----------------	-------------------------

*Product specifications may change without notice or obligation.

6.2 Glossary - Standard Definitions

Analog TV: Today's TV system using radio frequency waves to transmit and display pictures and sound.

Aspect Ratio (4x3): Traditional TV "aspect ratio", that is, the screen's width as compared to its height. For example, a "32 inch TV screen" would be 25 inches wide and 19 inches tall.

Aspect Ratio (16x9): "Wide screen TV" aspect ratio which is more like a movie screen than a traditional TV. For example, a "32 inch TV screen" would be 28 inches wide and 16 inches tall.

Digital TV (DTV): Television delivered and displayed using radio frequency waves that contain information that is digitally encoded for improved quality and efficiency.

Enhanced Definition TV (EDTV): A better digital television transmission than SDTV with at least 480P, in a 16x9 or 4x3 display and Dolby digital surround sound. 480P is the quality used by most DVD players. EDTV provides 300-400,000 pixels.

HDTV Monitor (sometimes called HDTV Ready): A set that can display HDTV programming if you have a separate HDTV tuner, HD Cable Set-Top Box or HD Satellite Set-Top-Box Receiver.

HDTV Tuner (also decoder, receiver, set-top box): A device capable of receiving and outputting HDTV signals for display. It may be stand-alone or integrated in the set.

High-Definition Television (HDTV): The best quality picture, wide screen (16x9) display with at least 720 progressively scanned lines (720P) or 1080 interlaced lines (1080i) and Dolby digital surround sound. HDTV provides 900,000-2.1 million pixels.

Integrated HDTV: An HDTV that has the digital tuner built into the set. It does not need a separate set-top box to receive over-the-air DTV signals.

Interlace Scan: A way to scan vertical lines onto a TV picture by scanning all the odd lines first, then filling the in the even lines (this happens instantaneously).

Plug-and-Play or Digital Cable Ready: A DTV or other device for digital cable consumers that plugs directly into the cable jack and does not require a separate set-top box. Plug-and-Play TV owners must obtain a CableCARD from their cable company in order to view scrambled programming services.

Progressive Scan: A way to scan vertical lines onto a TV picture by scanning all the lines consecutively (progressively).

Standard Definition TV (SDTV): Basic digital television transmission that may be displayed with fewer than 480 progressively scanned lines (480P) in 16 x 9 or 4 x 3 format. 480 interlaced (480i) is the quality of today's analog TV system.

Source: Buying a Digital Television, CEA, HDTV Guide, 2005

Note: The Federal Communications Commission (FCC), the Consumer Electronics Association (CEA) and the Consumer Electronics Retailers Coalition (CERC) have made a new tip sheet available for digital television (DTV) retailers to reproduce and distribute to consumers on the sales floor. The file may be downloaded online at www.dtv.gov. While you're there, check out the other useful information in the FCC is making available to consumers interested in learning more about the analog to digital transition.



6.3 Index

A

- Accessories, 5
- Adjustments
 - Closed Caption, 14
 - Selecting the Screen Size, 14, 76
 - Stepping through TV Channels, 37
 - Volume, 9, 37, 71
- Advanced Video Features
 - Color Temperature (Color Temperature), 43
 - CTI (Color Transient Improvement), 42
 - DNR (Dynamic Noise Reduction), 42

C

- Cleaning your VIZIO TV, 71
- Coax (RF)
 - Connecting for DTV, 17
- Component
 - Connecting your DVD Player, 24
 - Connecting your HDTV Set-Top Box, 20
- Composite (AV)
 - Connecting your Basic Set-Top Box, 21
 - Connecting your DVD Player, 25
- Controls
 - Front Panel, 9
 - Side Panel, 9

D

- Disassembling, 7
- DTV
 - Audio Adjustment, 44
 - Parental Control, 57
 - Picture Adjustment, 40
 - Special Features, 50
 - Tuner Setup, 47
- DTV Audio Adjust
 - Audio Out, 46
 - Balance, 45
 - Digital Audio Out, 45
 - Equalizer, 44
 - Lip Sync, 46
 - Reset Audio Mode, 46
 - Speakers, 45
 - Surround, 45
 - Volume, 44
- DTV Picture Adjust
 - Advanced Video, 42
 - Brightness, 40, 66
 - Color, 41
 - Color Temperature, 68
 - Contrast, 40, 67
 - Reset Picture Mode, 43
 - Sharpness, 41
 - Tint, 41

- DTV Special Features
 - Digital Closed Caption, 55
 - Input Naming, 54
 - Language, 50
 - PIP, 50
 - Reset, 62
 - Sleep Timer, 50, 53
 - Wide, 53
- DTV Tuner Setup
 - Auto Search, 47
 - Daylight Saving, 49
 - MTS, 48
 - Partial Channel Search, 48
 - Skip Channel, 48
 - Time Zone, 48
 - Tuner Mode, 47

DVI

- Connecting your DVD Player, 23
- Connecting your HDTV Set-Top Box, 19

G

- Glossary, 76

H

- HDMI
 - Connecting your DVD Player, 22
 - Connecting your HDTV Set-Top Box, 18
- HDMI Input
 - Audio Adjustment, 63
 - Picture Adjustment, 63
 - Setup, 63

I

- Inputs
 - Antenna, 3
 - Connectors, 16
 - Rear Label, 10
- Installation
 - Base removal, 6
 - Preparation, 5
 - Safety Strap, 5
 - Safety Instructions, 2
 - Wall Mounting, 5, 6, 31

O

- OSD
 - Brightness Adjustment, 75
 - Closed Caption Selection, 14
 - Color Adjustment, 16
 - Contrast Adjustment, 75
- Outputs
 - Using 5.1 Surround with a Home Theatre System, 28



P

- Parental Control
 - Block Unrated Programming, 61
 - Canadian English Rating, 59
 - Canadian French Rating, 60
 - Channel Block, 57
 - DTV Rating, 60
 - Movie Rating, 59
 - Password change, 61
 - TV Rating, 58
- PC Input
 - Audio Adjustment, 69
 - Auto Adjust, 66
 - Picture Adjustment, 66
 - Setup, 69
- PC Picture Adjust
 - Fine Tune, 69
 - H/V Position, 56
 - Horizontal Position**, 56, 68
 - Horizontal Size**, 56, 68
 - Vertical Position**, 56, 69
- PC Resolutions, 30
- PIP and POP
 - Settings, 52

R

- Remote
 - Batteries, 15
 - Layout, 12, 15
 - Range, 15
- RGB
 - Connecting your PC, 29

S

- Screen Size explanation, 69
- S-Video
 - Connecting your DVD Player, 25
 - Connecting your VCR, 26
 - Connecting your Video Camera, 26

T

- Technical Specifications, 75
- Troubleshooting Guide, 71

TV

- Audio Adjustment, 44
- Parental Control, 57
- Picture Adjustment, 40
- Special Features, 50
- TV Picture Adjust
 - Advanced Video, 42
 - Brightness, 40, 66
 - Color, 41
 - Color Temperature, 68
 - Contrast, 40, 67
 - Reset Picture Mode, 43
 - Sharpness, 41
 - Tint, 41
- TV Special Features
 - Closed Caption, 55
 - Input Naming, 54
 - Language, 50
 - PIP, 50
 - Reset, 62
 - Sleep Timer, 50, 53
 - Wide, 53
- TV Tuner Setup, 47
 - Auto Search, 47
 - MTS, 48
 - Partial Channel Search, 48
 - Skip Channel, 48
 - Tuner Mode, 47

V

- Video Input
 - Audio Adjustment, 64
 - Auto Phase, 65
 - Parental Control, 66
 - Picture Adjustment, 64
 - Setup, 64

W

- Watching TV
 - Basic Adjustments, 37
 - Basic connections, 31
 - First Startup, 31
 - Getting your Programs, 36
 - Program Information, 38
 - Status Information, 38



6.4 Component Program Codes

Setup Code for VCR's	
A-Mark	20037, 20240, 20000, 20278, 20046
ABS	21972
Admiral	20048, 20209, 20060, 20039, 20047, 20104, 20020, 20062
Adventura	20037, 20240, 20000
Adyson	20072
Aiko	20278
Aiwa	20037, 20479, 20000, 20124, 20307
Alba	20209, 20072, 20278
Alienware	21972
Allegro	20039
America Action	20278, 10180
American High	20035, 20081
Amoisonic	20479
Anam	20162, 20037, 20240, 20278
Anam National	20162

Setup Code for VCR's	
Asha	20240
Audiovox	20037, 20278, 10180, 20038
Beaumark	20240
Bell & Howell	20035, 20048, 20039, 20000, 20104, 20046, 20479
Broksonic	20184, 20121, 20209, 20002, 20208, 20479, 11929, 21479
Calix	20037
Candle	20037, 20038
Canon	20035
Capehart	20002, 20020, 20062
Carrera	20240
Carver	20081
CCE	20072, 20278
Cineral	20278
Changhong	20048, 20081
Citizen	20035, 20037, 20240, 20000, 20209, 20278, 20479, 21278

Setup Code for VCR's	
Classic	20037
Colortyme	20060, 20035, 20045, 20278
Colt	20072, 20000
Craig	20037, 20047, 20240, 20072, 20271
Criterion	20000, 20072
Crosley	20035, 20081, 20000, 20149
Crown	20072, 20278
Curtis Mathes	20060, 20035, 20162, 11919, 20240, 20000, 20041, 20278, 20432, 20760, 21035
Cybernex	20240
CyberPower	21972
Daewoo	20037, 20045, 20020, 20278, 20046, 20561, 21278
Daytron	20037, 20278, 20020
Dell	21972



Setup Code for VCR's	
Denon	20042, 20081
DirecTV	20739
Dual	20000
Durabrand	20039, 20038
Dynatech	20240, 20000
Electrohome	20037, 20060, 20240, 20000, 20043, 20209, 20061
Electroponic	20037
Emerald	20184, 20121
Emerex	20032
Emerson	20035, 20037, 20184, 20240, 20045, 20121, 20043, 20209, 20002, 20278, 20479, 10236, 11928, 11929
Fisher	20047, 20104, 20039, 20000, 20046
Fuji	20035, 20033
Fujitsu	20045, 20000
Funai	20037, 20000, 20072, 20278, 20593, 21593
Garrard	20000

Setup Code for VCR's	
Gateway	21972
GE	20060, 20035, 20240, 20048, 20000, 20149, 20202, 20760
Gemini	20060
General	20045
Genexxa	20037, 20000, 20278
Go Video	20432, 20240, 20526, 20614
GoldStar	20037, 20035, 20000, 20278, 20209, 20038, 20225, 21237
Goodmans	20037, 20081, 20000, 20072, 20278, 20020, 20062
Gradiente	20000, 20008
Granada	20081, 20042
Grundig	20081
Harley Davidson	20000
Haojie	20240
Harman/Kardon	20081, 20038
Harvard	20072
Harwood	20072

Setup Code for VCR's	
Headquarter	20046
Hewlett Packard	21972
HI-Q	20047, 20035, 20000
Hitachi	20035, 20037, 20045, 20000, 20042, 20041, 20089, 20105, 21037
Howard Computers	21972
HP	21972
Hughes Network Systems	20042, 20739
Humax	20739
Hush	21972
Hytex	20047, 20000, 20072
iBUYPOWER	21972
ITT Nokia	20240, 20041
Janeil	21972
Jensen	20067, 20041
JVC	20045, 20067, 20008, 20061, 21162
KEC	20037, 20278
Kenwood	20067, 20038,



Setup Code for VCR's	
	20041, 20046
KLH	20072
Kodak	20035, 20037
Kolin	20043
KTV	20000
LG	20037, 20045, 20042, 20209, 20038, 20240, 21037
Linksys	21972
Lloyd's	20240, 20000, 20072, 20038, 20208
Loewe	20081
Logik	20072, 20240, 20000
LXI	20037, 20000, 20042, 20067
Lumatron	20278
Luxor	20046, 20106
M Electronic	20240
Magnasonic	20037, 20240, 20000, 20072, 20278, 20020, 20593, 21278
Magnavox	20035, 20037, 20048, 20039, 20081, 20240,

Setup Code for VCR's	
	20000, 20149
Magnin	20240
Marantz	20035, 20081, 20038, 20062
Marta	20037
Matsui	20037, 20209
Matsushita	20035, 20162, 20081, 21162
Media Center PC	21972
MEI	20035
Memorex	20035, 20162, 20037, 20048, 20039, 20047, 20240, 20104, 20209, 20479, 20000, 20072, 20278, 20062, 20046, 20307, 20479
Metz	20037
MGA	20240, 20043, 20060, 20061
MGN Technology	20240
Microsoft	21972
Midland	20240
Mind	21972
Minolta	20042, 20105

Setup Code for VCR's	
Mitsubishi	20060, 20048, 20047, 20000, 20042, 20067, 20043, 20041, 20061, 20807
Motorola	20035, 20048
Movie Walker	20072
MTC	20240, 20000, 20072
MTX	20000
Multitech	20072, 20000, 20039
NAD	20240, 20104
NEC	20035, 20037, 20048, 20104, 20067, 20038
New Tech	20072
Nikko	20037, 20278
Nikkodo	20037, 20278
Nishi	20240
Niveus Media	21972
Newave	20037
Noblex	20240
Northgate	21972
Olympus	20035
Optimus	21062, 20035, 20162, 20037,



Setup Code for VCR's	
	20048, 20047, 20240, 20000, 20104, 20062, 20432, 20593, 21048, 21162, 21262
Optonica	20062
Orion	20184, 20240, 20000, 20104, 20121, 20209, 20002, 20278
Panama	20035
Panasonic	21062, 20035, 20162, 20000, 20020, 20225, 20614, 20616, 21035, 21162, 21262
Penney	20035, 20162, 20037, 20047, 20081, 20240, 20000, 20042
Pentax	20042, 20105
Philco	20035, 20479, 20081, 20000, 20209
Philips	20035, 20162, 20048, 20081, 20045, 20000, 20209, 20062,

Setup Code for VCR's	
	20616, 20618, 20739, 21081, 21181
Pilot	20037
Pioneer	20162, 20081, 20042, 20067
Polk Audio	20081
Portland	20278, 20020
Presidian	21593
Profitronic	20240
Proscan	20060, 20202, 20760, 21060
Protec	20072, 20000
Protech	20072
Pulsar	20039
Pulser	20240
Quarter	20046
Qisheng	20060
Quasar	20035, 20162, 20002, 21035, 21162
Quartz	20035, 20047, 20046
Radio Shack	20035, 20162, 20037, 20048, 20047, 20240, 20000, 20104,

Setup Code for VCR's	
	20046, 20062, 21037, 21162
Radix	20037
Randex	20037
RCA	20060, 20035, 20048, 20240, 20045, 20000, 20042, 20149, 20105, 20106, 20202, 20760, 20807, 20880, 21035, 21060
Realistic	20035, 20162, 20037, 20048, 20047, 20104, 20240, 20000, 20121, 20278, 20046, 20062, 21162
ReplayTV	20616, 20614
Ricavision	21972
Runco	20039
Sampo	20037, 20048
Samsung	20060, 20240, 20045, 20000, 20038, 20432, 20739, 21014
Samtron	20240
Sanky	20048, 20039



Setup Code for VCR's	
Sansui	20240, 20000, 20067, 20209, 20041, 20072, 20002, 20271, 20479, 21479
Sanyo	20047, 20240, 20104, 20000, 20046, 20159, 20479
Scientific Atlanta	20008
Scott	20184, 20045, 20121, 20043, 20208
Sears	20060, 20035, 20162, 20037, 20048, 20039, 20047, 20033, 20045, 20000, 20042, 20104, 20067, 20043, 20209, 20041
Sharp	20048, 20047, 20032, 20000, 20062, 20807, 20848
Shintom	20072, 20039, 20208, 20240, 20000
Shogun	20240
Siemens	20037, 20104

Setup Code for VCR's	
Signature	20060, 20035, 20037, 20048, 20000, 20149, 20046, 20479
Singer	20037, 20240, 20072
Sonic Blue	20616, 20614
Sonographe	20046
Sony	20035, 20047, 20032, 20033, 20000, 20067, 20046, 20636, 21032, 21232, 21972
Soundmaster	20000
Stack 9	21972
STS	20042, 20105
SV2000	20000, 20072
SVA	20000
Sylvania	20035, 20081, 20043, 20000, 20593, 21593, 21781
Symphonic	20240, 20000, 20002, 20593, 21593
Systemax	21972
Tagar Systems	21972

Setup Code for VCR's	
Tandy	20000, 20104
Tashiko	20037
Tatung	20048, 20081, 20000, 20067
Tatung	20041, 20008
Teac	20000, 20067, 20041
Technics	20035, 20162, 20037, 20000
Teco	20035, 20037, 20048, 20038
Teknika	20035, 20037, 20000
Telecorder	20240
Telefunken	20041, 20208
Tevion	20479
Thomas	20000, 20002
Thomson	20060, 20041, 20202
Tisonic	20278
Tivo	20636, 20618, 21503, 20739
TMK	20240, 20000, 20208
TNIX	20037
Tocom	20240



Setup Code for VCR's	
Toshiba	20240, 20045, 20042, 20000, 20043, 20209, 20041, 20062, 20845, 21008, 21145, 21972, 21996
Tosonic	20278
Totevision	20037, 20240
Touch	21972
Trix	20037
Ultra	20045, 20278, 20020
Unitech	20240
Vector	20045
Vector Research	20038, 20184
Vextra	20072
Victor	20067, 20041, 20008
Video Concepts	20045, 20061
Videomagic	20037
Videosonic	20240, 20000, 20072
Viewsonic	21972
Villain	20000
Voodoo	21972
Wards	20060, 20035,

Setup Code for VCR's	
	20037, 20048, 20047, 20081, 20033, 20240, 20042, 20072, 20045, 20000, 20043, 20041, 20038, 20149
Wharfedale	20593
White Westinghouse	20209, 20000, 20072, 20278, 20479
World	20209, 20002, 20479
XR-1000	20035, 20072, 20240, 20000, 20208
Yamaha	20038, 20041
Zenith	20037, 20039, 20033, 20000, 20209, 20041, 20278, 20479, 21139, 21479
ZT Group	21972

Setup Code for Cable Converters	
ABC	00003, 00008, 00014, 00237, 00017

Setup Code for Cable Converters	
Accuphase	00003, 00014, 00017
Acorn	00023
Action	00023
Active	00023
A-Mark	00008, 00144
Americast	00899
Amino	01822
Archer	00237
BCC	00276
Bell & Howell	00014
Bell South	00899
British Telecom	00003
Clearmaster	00883
ClearMax	00883
Cool Box	00883
Coolmax	00883
Daeryung	01877, 00877, 00477, 00008
Digeo	01187
Digi	00637
Director	00476
Dumont	00637
DX Antenna	01500



Setup Code for Cable Converters	
Emerson	00014
Fosgate	00276
Fujitsu	01497
GE	00144
Gehua	00476
General Instrument	00476, 00810, 00276, 00003, 00014, 00012
Gibraltar	00003
GMI	00883
GoldStar	00144
Hamlin	00009, 00273
Hitachi	00014, 00003, 00008, 00009
Insight	00476, 00810
Jebsee	00014
Jerrold	00476, 00810, 00276, 00003, 00012, 00014
KNC	00008
LG	00144
Memorex	00000
Motorola	01376, 00476, 00810, 00276, 01187, 01254,

Setup Code for Cable Converters	
	00014, 01106
Multitech	00883
MultiVision	00012
Myrio	01822
NEC	01496
Nova Vision	00008
Novaplex	00008, 00017
NSC	00012, 00637
Oak	00017
Pace	01877, 00877, 00237, 00008
Panasonic	00000, 00008, 00107, 0144, 01488
Panther	00637
Paragon	00000, 00008, 00525
Penney	00000, 00637
Philips	00317, 01305
Pioneer	01877, 00877, 00144, 00533, 01500
Prism	00012
Pulsar	00000
Quasar	00000

Setup Code for Cable Converters	
RadioShack	00883
RCA	01256
Regal	00279, 00273
Runco	00000
Samsung	00000, 00144
Scientific Atlanta	01877, 00877, 00477, 00237, 00003, 00000, 00008, 00012, 00017, 01510
Sony	01006, 01460
Sprucer	00144
Starcom	00003, 00014
Stargate	00014
Storm	00637
Sumitomo	01500
Supercable	00276
Supermax	00883
Tocom	00012
Torx	00003
Toshiba	00000, 01509
Trans PX	00276
Tristar	00883
TS	00003



Setup Code for Cable Converters	
United Cable	00276, 00003, 00014
US Electronics	00276, 00003, 00008, 00017
V2	00883
Viewmaster	00883
Vision	00883
Vortex View	00883
Zenith	00000, 00525, 00899, 00017

Setup Code for Satellite Receivers	
Aiwa	01514
AlphaStar	00772
Bell ExpressVu	00775
Chaparral	00216
Crossdigital	01109
DirecTV	01377, 00392, 00566, 00639, 01639, 01142, 00247, 00749, 01749, 00724, 00819, 01856, 01076, 01108, 00099, 01109, 01392, 01414,

Setup Code for Satellite Receivers	
	01442, 01443, 01444, 01609, 01640
Dish Network System	01505, 01005, 00775, 01170, 01775
Dishpro	01005, 00775, 01505, 01775
DX Antenna	01530
Echostar	01005, 00775, 01505, 01170, 01775
Expressvu	00775, 01775
Fortec Star	01821
Funai	01377
GE	00566, 00392
General Instrument	00869
GOI	00775, 01775
Goodmans	01246
Hisense	01535
Hitachi	00819, 00222, 01250, 00749
Houston	00775
HTS	00775
Hughes Network	01142, 00749,

Setup Code for Satellite Receivers	
Systems	01749, 01442, 01443, 01444
Humax	01790
iLo	01535
Innova	00099
Jerrold	00869
JVC	00775, 01170, 01507, 01775
LG	01414, 01226
Magnavox	00724, 00722
Maspro	01530
McIntosh	00869
Memorex	00724
Mitsubishi	00749
Motorola	00869
NEC	01270, 01519
Netsat	00099
Next Level	00869
Optimus	00724
Panasonic	00247, 00701, 01508
Paysat	00724, 01807
Philips	01142, 00749, 01749, 00724, 00775, 00819,



Setup Code for Satellite Receivers	
	01076, 00722, 00099, 01442
Pioneer	01142, 01442
Primestar	00869
Proscan	00392, 00566
Proton	01535
RadioShack	00869, 00775, 00566
RCA	00392, 00566, 00855, 00143, 01392, 01442, 00775, 01142
Samsung	01276, 01109, 01108, 01142, 01377, 01442, 01609
Sanyo	01219
Sharp	01489
SKY	00856, 00099
Sony	00639, 01640, 01639, 01524
Star Choice	00869
Star Trak	00772, 00869
Thomson	00392, 00566
Tivo	01142, 01442, 01443, 01444

Setup Code for Satellite Receivers	
Toshiba	00749, 01749, 00790, 00819, 01285, 01501, 01530
UltimateTV	01640, 01392
Ultrasat	01806
Uniden	00724, 00722
US Digital	01535
USDTV	01535
Voom	00869
Zenith	00856, 01856

Setup Code for DVD Players	
3D Lab	20503, 20539
Accurian	21072, 21416
Acoustic Solutions	20730
Advent	21016
Afreedy	20698
Aiwa	20641, 21912
Akai	20770, 20705, 20695, 20899, 21089
Alba	20672, 20717
Alco	20790

Setup Code for DVD Players	
Allegro	20869
Amphion Media Works	20872
AMW	20872
Apex Digital	20533, 20672, 20717, 20755, 20794, 20796, 20797, 20830, 21004, 21020, 21056, 21061, 21100
Arrgo	21023
Aspire Digital	21168, 21407
Audiovox	20717, 20790, 21041, 21071, 21072, 21121, 21122
Awa	20730
Axion	21071, 21072
Blaupunkt	20717
Blue Parade	20571
Blue Sky	20695
Bose	21895
Brandt	20651
Broksonic	20695, 20868
Byd;sign	20872
California Audio	20490



Setup Code for DVD Players	
labs	
Celestial	21020
Centrex	20672, 21004
Changhong	20627, 21061
Cinea	20831
CineVision	20869
Citizen	21003, 21277
Clairtone	20571
Coby	21086, 20778, 21107, 21177
Craig	20831
Creative	20503, 20539
Curtis Mathes	21087
CyberHome	20816, 20874, 21023, 21024, 21117, 21129, 21502
Cytron	20705
Daewoo	20784, 20705, 20770, 20833, 20869, 21169, 21172, 21234, 21242
Dansai	20770
Daytek	20872
Decca	20770
Denon	20490, 20634

Setup Code for DVD Players	
DVD2000	20521
Emerson	20591, 20675, 20821, 21268
Enterprise	20591
Entivo	20503, 20539
Enzer	20770
ESA	20821, 21268
Firstline	20651
Fisher	21919, 20670
Funai	20675, 21268, 21334
Gateway	21158, 21073
GE	20522, 20717, 20815
Go Video	20573, 20744, 20717, 20715, 20714, 20783, 20833, 20869, 21044, 21075, 21099, 21158, 21304, 21730
GoldStar	20741, 20801, 20869
Goodmans	20790
Gardiente	20490, 20651
Grundig	20539, 20705
Greenhill	20717

Setup Code for DVD Players	
Harman/Kardon	20582, 20702
Hitachi	20573, 20664, 21919, 21247, 21764
Hiteker	20672
Humax	21588
iLo	21348
Initial	20717
Insignia	21268
Integra	20627, 21924
IRT	20783
JBL	20702
Jensen	21016
JMB	20695
JVC	20558, 20623, 20867, 21164
Kawasaki	20790
Kenwood	20490, 20534
KLH	20717, 21020, 21149, 20790
Kloss	20533
Koss	20651, 21061
Lasonic	20798
Lecson	20627, 20798
Lenoxx	21533



Setup Code for DVD Players	
LG	20591, 20869, 20801, 20741
Liquid Video	21980
Lite-On	21158, 21058, 21416, 21440
Loewe	20511, 20741
Logix	20783
Magnasonic	20651, 20675
Magnavox	20503, 20539, 21976, 21914, 20675, 20646, 20821, 21268
Malata	20782, 21159
Marantz	20539, 20503, 20675
McIntosh	21533
Medion	20651
Memorex	20695, 20831, 21270
Microsoft	20522, 21708
Minato	20752
Mintek	20717, 20839
Mitsubishi	21521, 20521, 21403
Momitsu	21082
Mustek	20730

Setup Code for DVD Players	
NAD	20591, 20741
Naiko	20770
NEC	20785, 20869
Nesa	20717
NexxTech	21402
Norcent	21003
Onkyo	20503, 20627, 21924, 20792
Optimus	20571
Oritron	20651, 21980
Palsonic	20672
Panasonic	20503, 20490, 20571, 20703, 21362, 21462, 21490, 21632, 21762
Philips	20503, 20539, 20646, 21914, 20675, 20854, 21260, 2167, 21354
PianoDisc	21024
Pioneer	20525, 20571, 20631
Polaroid	21086, 21061, 21020
Polk Audio	20539

Setup Code for DVD Players	
Portland	20770
Presidian	20675, 21072
Prima	21016
Proceed	20672
Proscan	20522
ProVision	20778
Qwestar	20651
Radionette	20741
RadioShack	20571
RCA	20522, 20571, 20717, 20822, 20790, 21022, 21132
Realistic	20571
Reoc	20752
Rio	20869
Rotel	20623
Rowa	20823, 21004
Saba	20651
Sampo	20752, 20698
Samsung	20490, 20573, 21932, 21075, 20820, 20744, 20899, 21044
Sansui	20695
Sanyo	20695, 20670,



Setup Code for DVD Players	
	20675, 20873, 21334
Schneider	20783
Schwaiger	20752
Sensory Science	21158
Sharp	20630, 20752, 20675, 21256, 21642
Sharper Image	21117
Sherwood	20770, 21043
Shinco	20717
Shinsonic	20533, 20839
Slim Art	20784
SM Electronic	20730
Sonic Blue	20573, 20715, 20783, 20869, 21099
Sony	20533, 21533, 20864, 21033, 21070, 21431
Sova	21122
Superscan	20821
SVA	20717, 20860
Sylvania	20675, 20821, 21268
Symphonic	20675, 20821, 21268, 21334

Setup Code for DVD Players	
Tatung	20770
Teac	20717, 21984, 20809, 20790
Technics	20490
Technika	20770
Technosonic	20730
Tevion	20651
Theta Digital	20571
Thomson	20522, 20511
Tivo	21503, 21588
Toshiba	20503, 20573, 20539, 20695, 21045, 21154, 21503, 21588, 21639
Tredex	20800
Unimax	20770
United	20730
Universum	20591
Urban Concepts	20503, 20539
US Logic	20839
V	20123, 20124, 21064, 21226
Venturer	20790
Victor	21597
VIZIO	21064, 21226

Setup Code for DVD Players	
Xbox	20522
Yamaha	20490, 20539, 20545
Yamakawa	20872
Zenith	20503, 20591, 20741, 20869
Zeus	20784
Zoece	21265

Setup Code for CD Players	
Acoustic Research	30420
Admiral	30305
Aiwa	30157
Arcam	30157
Audio Research	30157
Burmester	30420
Cairn	30157
California Audio Labs	30029
Cambridge Soundworks	30157
Carver	30157, 30179
Curtis Mathes	30032
Denon	30873
DKK	30000



Setup Code for CD Players	
DMX Electronics	30157
Dynamic Bass	30179
Emerson	30305
Fisher	30179, 30000
Funai	30305
Garrard	30420, 30393
Genexxa	30032, 30305
Grundig	30157
Hafler	30173
Harman/Kardon	30157, 30173
Hitachi	30032
Inkel	30157, 30180
Integra	30101
Jerrold	30003
JVC	30072, 30032
Kenwood	30826, 30626, 30028, 30037, 30036, 30190
KLH	31318, 31372, 31373, 31711
Krell	30157
Linn	30157
Magnavox	30157, 30038, 30274, 30305
Marantz	30626, 30029, 30157, 30038,

Setup Code for CD Players	
	30180, 30435
McIntosh	30256, 30290, 30660
MCS	30029
Miro	30000
Mission	30157
Modulaire	30000, 30032, 30037, 30087, 30179, 30180, 30305, 30393, 30420, 30468
MTC	30420
NSM	30157
Onkyo	30868, 30101
Optimus	31063, 30000, 30032, 30037, 30420, 30179, 31075, 30145
Panasonic	30029, 30303, 30388, 30752
Parasound	30420
Penney	30029
Philips	30626, 30157, 30274
Pioneer	31063, 31062, 30032, 31087, 30305, 30468
Polk Audio	30157

Setup Code for CD Players	
Proceed	30420
Proton	30157
QED	30157
Quad	30157
Quasar	30029
RadioShack	30000, 30032, 30179, 30180, 30420, 30468
RCA	31062, 30032, 30420, 30179, 30053, 30305, 30420, 30468
Realistic	30420, 30179, 30180, 30305, 30468, 30000, 30032, 30087
Revox	30157
Roksan	30435
Rotel	30157, 30420
SAE	30157
Sansui	30157, 30000, 30305
Sanyo	30179, 30000, 30087
SAST	30157
Scott	30305
Sears	30179, 30305



Setup Code for CD Players	
Sharp	30861, 30037, 30034, 30180
Sherwood	30180
Silsonic	30888, 30036
Sonic Frontiers	30157
Sony	30490, 30000, 30100, 31364, 30185
Soundesign	30145
Sugden	30157
Sylvania	30157
Symphonic	30180, 30305
TAG McLaren	30157
Tandy	30032
Tascam	30420, 30393
Teac	30420, 30393, 30490, 30180, 30378
Technics	30029, 30303
Techwood	30303
Thule Audio	30157
Victor	30072
Wards	30157, 30053, 30032, 30087, 30179
Yamaha	30888, 30036,

Setup Code for CD Players	
	30490, 31292
Yorx	30000
Zonda	30157

Setup Code for Video Accessories	
ABS	01272
Accurian	01653
Alienware	01272
Allegro	00160
Archer	00160
Bantor	00160
Centronic	00160
CyberPower	01272
D-Link	01554, 01731
Epson	01563
Gateway	01272
GC Electronics	00160
Hauppauge	01757
Hewlett Packard	01272, 01267
Howard Computers	01272
HP	01272, 01267
Hush	01272
iBUYPOWER	01272

Setup Code for Video Accessories	
Jebsee	00160
JVC	01384
Keyspan	01344
Leadtek	01614
LG	01415
Linksys	01272, 01365
Macro Image Technology	01383
Media Center PC	01272
Microsoft	01272
Mind	01272
Motorola	01363
MyHD	01383
Niveus Media	01272
Northgate	01272
Panasonic	01120
Pinnacle Systems	01268
Pioneer	01010
Princeton	00113, 00295
RadioShack	00160
Ricavision	01272
Roku	01486
Samsung	01190, 01490
Sensory Science	01126



Setup Code for Video Accessories	
Sharp	01010
Sony	01272, 01324, 01364
Stack 9	01272
Sylvania	01563
Systemax	01272
Tagar Systems	01272
Toshiba	01272
Touch	01272
Verator	00113
Viewsonic	01272, 01329
VIZIO	01126
Voodoo	01272
ZT Group	01272

Setup Code for Audio Accessories	
Accurian	31106
Altec Lansing	31056, 31485
Apple	31115, 31644
Cambridge Soundworks	31530
Creative	30872
D-Link	31522

Setup Code for Audio Accessories	
Imerge	31491
Integra	31789
iPort	31917
Marantz	31491
Motorola	31464
NaviPod	31644
Netgear	31785
Omnifi	31605
Onkyo	31789
Roku	31828
Russound	32019
Slim Devices	31844
Sonance	31917
SSI	31522
Yamaha	31809, 31810

Setup Code for Audio Receivers	
ADC	30531
Adcom	30616
Aiwa	31405, 30189, 30121, 31388, 31641
Akai	30244, 31512

Setup Code for Audio Receivers	
Alco	31390
AMC	31077
Amphion Media Works	31563, 31615
AMW	31563, 31615
Anam	31609, 31074
Apex Digital	31257, 31430, 31774
Arcam	31189
Audiotronic	31189
Audiovox	31390, 31627
BK	30701, 30702, 30820, 30840
Bose	31229, 30639, 31253, 31841, 31933
Brix	31602
Cairn	30189
Cambridge Soundworks	31370
Capetronic	30531
Carver	31189, 30189, 30121, 31289
Classic	31352
Coby	31389



Setup Code for Audio Receivers	
Criterion	31420
Curtis Mathes	30014
Daewoo	31250
Delphi	31414
Denon	31360, 30121, 30771, 31142, 31306
Emerson	30531
Fisher	31801
Garrard	30463
Gateway	31517
Go Video	31532
Grundig	30189
Harman/kardon	30110, 30189, 30891, 31289, 31304, 31306
Hitachi	31273, 31801
Initial	31426
Inkel	30491
Insignia	31030
Integra	30135, 30842, 31298, 31320
JBL	30110, 31306
JVC	31058, 30074, 31374, 31495,

Setup Code for Audio Receivers	
	31811
Kawasaki	31390, 31313, 31570, 31569, 30186
Kenwood	31313, 31570, 31569, 30186
KLH	31390, 31412, 31428
Koss	31366, 31497
Lasonic	31798
Lenoxx	31437
Lexicon	31076
LG	31293
Linn	31089
Liquid Video	31497
Magnavox	31189, 31269, 30189, 30391, 30531, 31266, 31514
Marantz	31189, 31269, 30189, 30891, 31289
McIntosh	31289
Micromega	31189, 30189
Mitsubishi	31393
Myryad	31189

Setup Code for Audio Receivers	
Nakamichi	31313, 30097
New Castle	30502
Norcent	31389
Nova	31389
Onkyo	30135, 30380, 30842, 31298, 31320, 31531
Optimus	31023, 30074, 30014, 30121, 30186, 30502, 30532, 30670, 31074
Oritron	31366, 31497
Outlaw	30391
Panasonic	31308, 31518, 30309, 30367, 31288, 31316, 31548, 31633, 31763, 31764
Philips	31189, 31269, 30189, 30391, 30891, 31266
Pioneer	31023, 30014, 30150, 30244, 30531, 30630, 31384
Polaroid	31508



Setup Code for Audio Receivers	
Polk Audio	30189, 31289, 31414
Proscan	31254
Radioshack	31609
RCA	31023, 31609, 31254, 30531, 31074, 31390, 31511
Realistic	31609, 30121, 30186
Regent	31437
Revox	30189
Rio	31869
Saba	31519
Samsung	31295, 31304, 31500
Sansui	31189, 30189, 31764
Sanyo	31251, 31469, 31801
Sharp	30186, 30771, 31286
Sharper Image	31556
Sherwood	30491, 30502, 31077, 31423, 31517, 31653

Setup Code for Audio Receivers	
Shinasonic	31426
Sirius	31602, 31627, 31811, 31987
Sonic Blue	31532, 31869
Sony	31058, 31441, 31258, 31759, 31622, 30168, 30474, 31406, 31558, 31658, 31758, 31858
Soundesign	30670
Stereophonics	31023
Sunfire	31313
Teac	30463, 31074, 31390, 31528
Technics	31308, 31518, 30309, 31384, 31633
Thorens	31189
Toshiba	30135, 30842, 31788
Venturer	31390
Victor	30074
Waitec	31352
Wards	30189, 30014
XM	31406, 31414

Setup Code for Audio Receivers	
Yamaha	31023, 30176, 30186, 31176, 31276, 31331, 31375, 31476
Zenith	30857, 31293

Setup Code for Audio Amplifiers	
Adcom	30577, 31100
Bose	30674
Carver	30892
Curtis Mathes	30300
Durabrand	31561
Elan	30647
GE	30078
Harman/Kardon	30892
JVC	30331
Left Coast	30892
Lennox	31561
Marantz	30321
McIntosh	30251
Modulaire	30395
Nakamichi	30321
NEC	30264



Setup Code for Audio Amplifiers	
Optimus	30395, 30013, 30300, 30823
Parasound	30246
Philips	30892
Pioneer	30013, 30300, 30823
Polk Audio	30892
Radio Shack	30395
RCA	30013, 30300, 30823
Realistic	30395, 30013
Sansui	30321
Shure	30264
Sony	30689, 30815
Soundesign	30078
Victor	30331
Wards	30078, 30013
Yamaha	30354, 30133

Setup Code for Audio Amp/Tuners	
ADC	30531
Aiwa	31405, 31243, 30121
Anam	31609, 31074

Setup Code for Audio Amp/Tuners	
Audiotronic	31189
Bose	31229
Capetronic	30531
Carver	31189
Coby	31263
Denon	31360, 31142, 30904
Fonmix	31360
Glory Horse	31263
Harman/Kardon	30110
Hitachi	31273
Inkel	30027
Integra	30135
JBL	30110
JVC	30074, 31263
Kenwood	31313, 31570, 30027
KLH	31428
Magnavox	31189, 31269, 30531
Marantz	31189, 31269, 30039
MCS	30039
Onkyo	30842, 30135

Setup Code for Audio Amp/Tuners	
Optimus	31023, 30670, 30531, 31074
Panasonic	31518, 30039
Philips	31189, 31269
Pioneer	31023, 30150, 30014, 30630, 30531
Proscan	31254
Qisheng	31609
Quasar	30039
RadioShack	31263
RCA	31023, 31609, 31254, 30531, 31074
Sharper Image	31263
Silsonic	30176
Sony	31058, 31441, 31258, 31759
Soundesign	30670
Stereophonics	31023
Sunfire	31313
Teac	31074, 31267
Technics	31308, 31518, 30039
Thorens	31189



Setup Code for Audio Amp/Tuners	
Victor	30074
Wards	30014
Yamaha	30176, 31276, 31176

Setup Code for TV's	
A-Mark	10047, 10054, 10165
Accuscan	10047, 10018, 10135
Action	10030, 10185
Addison	10092
Admiral	10047, 10054, 10017, 10051, 10093, 10463, 10180, 10018, 10165
Advantz	10282
Advent	10761, 10842, 11933, 10817, 10783, 10815
Adventuri	10000
Agna	10150
Aiko	10092
Aiwa	11914
Akai	10060, 10812,

Setup Code for TV's	
	10702, 10030, 10672, 11903, 10145, 10151
Albatron	10700, 10843
Alfide	10672
Alleron	10030
Ambassador	10150, 10177
America Action	10180
American High	10000, 10060
Ampro	10751
Amstrad	10171, 10177
Amtron	10000, 10180
Anam	10250, 10180, 10700
Anam National	10250, 10650, 10055
Anhua	10051
AOC	10451, 10093, 10180, 10060, 10030, 10178, 10092, 10185
Apex Digital	10748, 10156, 10879, 10765, 10185, 10767, 11943
Audiovox	10451, 10180, 10875, 10092, 10623, 10802,

Setup Code for TV's	
	11937, 11951
Aventura	10171
Axion	11937
Baile	10661
Baysonic	10180
Beaumarck	10017, 10178, 10030
Beijing	10812, 10661
Belcor	10030
Bell & Howell	10154
BenQ	11032
Boxlight	10893
Bradford	10180
Broksonic	10236, 10463, 11911, 11938, 11905, 11935, 11929, 10180, 10177
Cailing	10748
Candle	10030
Capehart	10017, 10178, 10030, 10092
Carnivale	10030
Carver	10054
Celebrity	10000
Celera	10765



Setup Code for TV's	
Changcheng	10051, 10661
Changhong	10156, 10765, 11156, 10767
Ching Tai	10092
Chun Yun	10000, 10180, 10700, 10092, 10843
Chung Hsin	10180, 10053
Cinema	10672
Cineral	10451, 10092
Citizen	10054, 10000, 10451, 10463, 10180, 10060, 10030, 10171, 10092, 10282, 11928
Civet	10185
Clairtone	10185
Clarion	10180
Classic	10030, 10092
Colortyme	11447, 10047
Commercial Solutions	11447, 10047
Conic	10178
Conrowa	10156, 10145, 11156
Contec	10180, 10185

Setup Code for TV's	
Craig	10180, 10171, 10282
Crosley	10054, 10000, 10180, 10030, 10171, 10187
Crown	10180, 10093, 10672
Crown Mustang	10672
Curtis Mathes	10047, 10054, 10154, 10000, 10051, 10451, 10093, 10180, 10060, 10702, 10178, 10030, 10145, 10166, 10018, 10466, 11147, 11347, 11919
CXC	10180
Cytron	11326
Daewoo	10154, 10451, 10180, 10030, 10178, 10672, 11928, 10092, 10661, 11909, 10623, 10700
Dayu	10661
Dell	11080, 11178
Denon	10145, 10055,

Setup Code for TV's	
	10511
Denstar	
Digital Life	
Dumont	10017
Durabrand	10463, 10180, 10178, 10171, 11034
Electroband	10000
Emerson	10047, 10154, 10451, 10236, 10463, 10180, 10150, 10178, 10171, 11944, 11929, 11928, 10623, 10282, 10185, 10177, 10135
Envision	10030, 10813
Ether	10030
Epson	10833, 10840
ESA	10812, 10171, 11944
Firstar	10236
Fisher	10154, 10054, 10000, 10159
Fortress	10093
Fujitsu	10809, 10853, 10683



Setup Code for TV's	
Funai	10180, 10171, 11904, 10000
Furi	10145
Futuretech	10180
Gateway	11756, 11755
GE	11447, 10047, 10000, 10051, 10451, 10060, 10178, 10030, 10135, 10055, 10282, 11147, 11347, 10018, 11917, 11919, 11922
Gemini	10047
Gibraltar	10017, 10030, 10000
Go Video	10886
Go Vision	11937
GoldStar	10047, 10054, 10178, 10030, 10018, 11154, 11926
Gradiente	10053
Grundig	10706, 10672, 10683
Grundy	10180
Grunpy	10180

Setup Code for TV's	
Haier	11034, 10768
Hallmark	10178, 10236, 10180, 10135, 10187
Hankook	10180, 10030, 10178
Harley Davidson	11904, 10030, 10178, 10000, 10180, 10060
Harman/Kardon	10054
Harvard	10180
Havermy	10093
Heathkit	10017
Helios	10865
Hello Kitty	10451
Hewlett Packard	11089, 11494, 11502
Hisense	10156, 10748, 10145, 11156
Hitachi	10047, 10054, 10017, 10000, 10051, 10178, 11145, 10145, 10018, 10055, 10151, 10185, 11904, 11960
HP	11089, 11494, 11502

Setup Code for TV's	
Hongmei	10093
Huafa	10145
Huari	10145
Huodateji	10051
Hyundai	10849, 10865
Ima	10236, 10180, 10178
Imperial Crown	10661
Infinity	10054
Insignia	10171, 11326, 11517
Inteq	10017
JBL	10054
JCB	10000
Jean	10156, 10051, 10236, 10092
Jensen	10761
Jiahua	10051
Jinfeng	10051
Jinxing	10054, 10156, 10145
Jutan	10030
JVC	10053, 11923, 11253, 10054, 10030, 10055, 10731, 11253



Setup Code for TV's	
Kamp	10017, 10180, 10185
Kangli	10661
Kawasho	10030, 10185
KEC	10180, 10060
Kenwood	10030, 10180
KLH	10765, 10767, 10156, 10180
Kolin	10180, 10150, 10053
Konka	10180, 10080, 10628, 10632, 10638, 10703, 10707, 10720
Kost	11262
Kloss	10030
KTV	10180, 10030, 10185, 10463
Kunlun	10051, 10661
Lark	10154
LG	10054, 11265, 10060, 10178, 10030, 10700, 10856, 11154, 11178, 11758
Lloyd's	11904, 10236, 10180, 10030

Setup Code for TV's	
LXI	10047, 10054, 10154, 10156, 10178, 10017, 10000, 10051, 10093, 10060, 10053, 10178, 10030, 10171, 10166, 10055, 10135, 10018, 10159, 10165
Magnasonic	10054, 10000, 10156, 10093, 10030, 10092, 11928
Magnavox	10047, 11454, 10054, 10154, 10000, 10250, 10051, 10180, 10060, 10030, 10171, 10092, 10706, 10187, 10282, 10386, 10802, 11254, 11755, 11904, 11931, 11944
Majestic	10017
Magnin	11907
Marantz	10054, 10030, 10704, 11454, 10854, 10855, 11154

Setup Code for TV's	
Matsushita	10250, 10650, 10051
Maxent	11755, 11756
Megapower	10700
Megatron	10178, 10145, 10047, 10151
MEI	10185
Memorex	10154, 10463, 10185, 10150, 10178, 11911, 11926, 11924, 11920, 11927, 10030, 10165
MGA	10150, 10030, 10178, 11907
MGN Technology	10178
Micro Genius	10150
Midland	10047, 10017, 10051, 10018, 10135
Mitsubishi	10154, 10250, 10093, 10236, 10180, 11250, 10150, 10030, 10178, 11917, 10836
Monivision	10843, 10700
Motorola	10093, 10051, 10054, 10150,



Setup Code for TV's	
	10055
MTC	10060, 10030, 10180, 10092, 10185, 10282
Mudan	10051
Multitech	10180
NAD	10156, 10178, 10866, 10166
National	10051
NEC	10047, 10156, 10178, 10030, 10497, 10704, 10882, 11704
NetTV	11755
Newave	10093, 10178, 10092
Nikko	10030, 10178, 10092
Nikkodo	10178, 10030, 10092
Nishi	10030, 10018
Norcent	10748, 10824, 11089
Noshi	10018
NTC	10092
Nyon	10000
Olevia	11144, 11240,

Setup Code for TV's	
	11331
Onwa	10180
Optimus	10154, 10250, 10093, 10180, 10150, 10178, 10030, 10166, 10165, 10650
Optoma	10887
Optonica	10093, 10165
Orion	10017, 10236, 10463, 10180, 10178, 11463, 10177, 11929
Pace	10092
Panasonic	10054, 10000, 10156, 10250, 10051, 10236, 10030, 10018, 10055, 10650, 11291, 11410, 11919, 11941, 11946, 11947
Panda	10051, 10706
Penney	10047, 10000, 10156, 10250, 10051, 10060, 10178, 10030, 10018, 10135, 10159, 11347, 11919, 11926

Setup Code for TV's	
Philco	10054, 10180, 10030, 10178, 10187, 10145, 10463
Philips	11454, 10054, 10030, 10171, 10187, 10690, 11154, 11254
Pilot	10030, 10051, 10060, 10178
Pioneer	10166, 10866, 10679, 10055, 11260
Polaroid	10765, 10865, 11262, 11276, 11314, 11316, 11326, 11327
Portland	10092
Precision	10236, 10180, 10177, 10185, 10282
Prima	10761, 10783, 10815, 10817, 11933
Princeton	10700, 10717
Prism	10051
Proscan	11447, 10047, 11922, 10018, 10135, 10466,



Setup Code for TV's	
	11347
Proton	10030, 10178
Pulsar	10017, 10092
Quartz	10150, 10178
Quasar	10250, 10051, 11924, 10650, 10055, 10165, 11919
Rabbit	10047
RadioShack	10047, 10154, 10180, 10150, 10178, 10030, 10165, 11904
RCA	11447, 10047, 10054, 10000, 10051, 10093, 10178, 11958, 11953, 11948, 11922, 11919, 11917, 11547, 11347, 11247, 11147, 11047, 10774, 10679, 10165, 10135, 10090, 10018
Realistic	10047, 10154, 10180, 10150, 10178, 10030, 10165
Rhapsody	10185

Setup Code for TV's	
Road Authority	10282
Rowa	10748
Runco	10017, 10030
Sampo	10154, 10093, 10030, 10178, 10171, 10700, 10650, 11755, 10092
Samsung	10154, 10156, 10060, 10812, 10702, 10030, 10178, 11060, 10814, 10092, 11903, 10090, 10766
Sansui	10463, 11904, 11935, 11929, 11911
Sanyo	10154, 10156, 10180, 10145, 11907
Sanyuan	10093
Scotch	10178
Scott	10236, 10180, 10178
Sears	10047, 10054, 10154, 10156, 10178, 10171, 11926, 11904

Setup Code for TV's	
Shaofeng	10145
Sharp	10093, 10030, 10650, 11917
Shen Ying	10092
Shencai	10145
Sheng Chia	10093, 10236
Skygiant	10180
Skyworth	10748
Sony	11100, 10000, 10650, 11925, 11904
Soundesign	10180, 10178
Sowa	10156, 10051, 10060, 10178, 10092
Squareview	10171
SSS	10180
Starlite	10180
Studio Experience	10843
Supreme	10000
SVA	10748, 10865
Sylvania	10054, 10030, 10171, 11944, 11931
Runco	10017, 10060, 10030, 10497, 10603



Setup Code for TV's	
Sampo	10047, 10030, 11755, 11756
Samsung	10047, 10054, 10017, 10154, 10060, 10812, 10702, 10178, 10030, 11959, 11903, 11312, 11060, 10814, 10766, 10587, 10055
Sanky	10060, 10030
Sansui	10463, 10060, 10030, 10165, 11904, 11929, 11935
Sanyo	10047, 10054, 10154, 10000, 10463, 10171, 10159, 10799, 10893, 11755
Saville	10060
Sceptre	10878
Scotch	10178
Scott	10236, 10180, 10178, 10030, 10177
Sears	10047, 10054, 10017, 10154, 10000, 10156,

Setup Code for TV's	
	10051, 10093, 10060, 10053, 10178, 10030, 10171, 10166, 10055, 10135, 10018, 10159, 10165, 11904, 11926
Sharp	10054, 10093, 10180, 10165, 10386, 10491, 10688, 10689, 10818, 10851, 11393, 11917
Sheng Chia	10093
Shivaki	10178
Seimens	10145
Signature	10047, 10093, 10030, 10165, 10187
Signet	11262
Simpson	10178, 10030, 10187
Singer	10060, 10092
Solar Drape	10000
Sole	10813
Sony	10017, 10154, 11100, 10000, 10150, 10053,

Setup Code for TV's	
	10080, 10632, 10834, 11904, 11925
Soundesign	10180, 10178
Sova	11952
Spectravision	10156, 10178, 10159
Squareview	10171
SR2000	10154, 10171
SSS	10180
Starlite	10236, 10180
Studio Experience	10843
Superscan	10093, 10864, 11944
Supreme	10000
SV2000	10054
SVA	10748, 10587, 10768, 10865, 10870, 10871, 10872
Sylvania	10047, 10054, 10154, 10000, 10051, 10178, 10030, 10171, 10092, 10159, 10187, 11904, 11926, 11931, 11944



Setup Code for TV's	
Symphonic	10000, 10180, 10178, 10171, 11904, 11944
Synco	10000, 10451 10093, 10060,
Syntax	11144, 11240, 11331
Tacico	10178, 10092
Tandy	10093, 10165
Tashiko	10092, 10650
Tatung	10054, 10154, 10156, 10051, 10060, 11156, 11756, 11254, 10000
Teac	10154, 10706, 10159, 10282, 10689
Technics	10250, 10051, 10055, 10054
Technovox	10030
Techview	10847
Techwood	10051, 10250, 10060, 10055
Teco	10051, 10093, 10178, 10092
Teknika	10054, 10463, 10180, 10150,

Setup Code for TV's	
	10060, 10178, 10092
Telecolor	10017
Telefunken	10702
Tera	10030
Thomas	11904, 10047, 10178
Thomson	11447, 10047
Tiane	10093
TMK	10178, 10236, 10180, 10177
TNCi	10017
Tobo	10748
Tocom	10156
Tomashi	10282
Toshiba	10154, 11256, 10156, 10150, 11265, 10060, 11145, 10145, 10166, 11945, 11936, 11935, 11918, 11704, 11656, 11356, 11156, 10845, 10832, 10650
Tosonic	10185
Totevision	10051
Toyomenka	10178

Setup Code for TV's	
Truetone	10250, 10051, 10055
Tuntex	10030, 10092
TVS	10463
Ultra	10095
Universal	10047, 10135
Universum	10177
V	10178, 10864, 10885, 11755, 11756
VIZIO	10178, 10864, 10885, 11499, 11756, 11758, 10030
Vector Research	10030
Victor	10250, 10053, 10650
Vidikron	10054
Vidtech	10178
Viewsonic	11755, 10885, 10864, 11578, 10857
Viking	10060
Wards	10047, 10054, 10017, 10154, 10000, 10051, 10093, 10236, 10178, 10030,



Setup Code for TV's	
	10166, 11156, 10866, 10187, 10165, 10151, 10080, 10018
Warumaia	10661
Waycon	10156
Welton	10178
Westinghouse	10000, 10451, 10885, 10889, 11282
White Westinghouse	10463, 11909, 10623, 10451, 10236, 10889
World	10451, 10236, 10463, 10180
XR-1000	10154, 10180, 10171
Yamaha	10030
Yapshe	10250
Yorx	10030
Zenith	10047, 10017,

Setup Code for TV's	
	10000, 10093, 10463, 11265, 10812, 10178, 10030, 11145, 10145, 10171, 10092, 11904, 11929

Setup Code for Home Automation	
Accutek	31215
Amana	31716
Bonaire	30846, 31215
Frigidaire	31333
GE	30240
GoldStar	31537
Holmes	31215
Kenmore	31537
Lasko	30846
LG	31537

Setup Code for Home Automation	
Lightolier	30184
Lutron	30597, 30318, 31239, 31597
Marmitek	30167
One For All	30167
PCS	30184
RadioShack	30240
Royal Sovereign	31651
Security System	30167
Sharper Image	30846
SmartLinc	30184
Universal	30167
Universal X10	30167
Whirlpool	31332
Windmere	31215
X10	30167

