

# RCA SCENIUM

## LCD User's Guide



### Find Inside:

- *Connections* ..... page 6
- *Remote*..... page 19
- *Features* ..... page 27
- *Menus* ..... page 36
- *FAQs*..... page 45
- *Troubleshooting* ..... page 46



[rca.com/television](http://rca.com/television)

# Important Information

## CAUTION

RISK OF ELECTRIC SHOCK  
DO NOT OPEN

Caution: To reduce the risk of electric shock, do not remove cover (or back). No user serviceable parts inside. Refer servicing to qualified service personnel.



This symbol indicates "dangerous voltage" inside the product that presents a risk of electric shock or personal injury.



This symbol indicates important instructions accompanying the product.

## WARNING

To reduce the risk of fire or electric shock, do not expose this product to rain or moisture. The apparatus shall not be exposed to dripping or splashing. No objects filled with liquids, such as vases, shall be placed on the apparatus.

## WARNING

The TV is unstable if it is not properly attached to the base or mounted to the wall. Please follow the base or wall mounting instructions provided in the User's Guide to ensure your safety.



This symbol indicates that this product contains mercury. Special disposal of this product for environmental reasons may be required under the laws applicable to your jurisdiction. For disposal or recycling information, please contact your local authorities or the Electronic Industries Alliance: [www.eiae.org](http://www.eiae.org).

Refer to the identification/rating label located on the back panel of your product for its proper operating voltage.

FCC Regulations state that unauthorized changes or modifications to this equipment may void the user's authority to operate it.

**Cable TV Installer:** This reminder is provided to call your attention to Article 820-40 of the National Electrical Code (Section 54 of the Canadian Electrical Code, Part 1) which provides guidelines for proper grounding and, in particular, specifies that the cable ground shall be connected to the grounding system of the building as close to the point of cable entry as practical.

**Important:** This television is a table model and is designed to sit on a firm, flat, surface. Don't place the TV on soft carpeting or similar surface because the ventilation slots on the bottom of the unit will be blocked resulting in reduced lifetime from overheating. To assure adequate ventilation for this product, maintain a spacing of 4 inches from the top and sides of the TV receiver and 2 inches from the rear of the TV receiver and other surfaces.

Also, make sure the stand or base you use is of adequate size and strength to prevent the TV from being accidentally tipped over, pushed off, or pulled off. This could cause personal injury and/or damage the TV. Refer to the Important Safety Instructions on the next page.

## Product Registration

Please fill out the product registration card (packed separately) and return it immediately. For US customers: Your RCA Consumer Electronics product may also be registered at [www.rca.com/television](http://www.rca.com/television). Registering this product allows us to contact you if needed.

## Product Information

Keep your sales receipt to obtain warranty parts and service and for proof of purchase. Attach it here and record the serial and model numbers in case you need them. These numbers are located on the product.

Model No. \_\_\_\_\_ Serial No. \_\_\_\_\_ Purchase Date \_\_\_\_\_

Dealer/Address/Phone \_\_\_\_\_

## Important Safety Instructions

### Important Safety Instructions

1. Read these instructions.
2. Keep these instructions.
3. Heed all warnings.
4. Follow all instructions.
5. Do not use this apparatus near water.
6. Clean only with dry cloth.
7. Do not block any ventilation openings. Install in accordance with the manufacturer's instructions.
8. Do not install near any heat sources such as radiators, heat registers, stoves, or other apparatus (including amplifiers) that produce heat.
9. Do not defeat the safety purpose of the polarized or grounding-type plug. A polarized plug has two blades with one wider than the other. A grounding type plug has two blades and a third grounding prong. The wide blade or the third prong is provided for your safety. If the provided plug does not fit into your outlet, consult an electrician for replacement of the obsolete outlet.
10. Protect the power cord from being walked on or pinched particularly at plugs, convenience receptacles, and the point where they exit from the apparatus.
11. Only use attachments/accessories specified by the manufacturer.
12. Use only with the cart, stand, tripod, bracket, or table specified by the manufacturer, or sold with the apparatus. When a cart is used, use caution when moving the cart/apparatus combination to avoid injury from tip-over.
13. Unplug this apparatus during lightning storms or when unused for long periods of time.
14. Refer all servicing to qualified service personnel.



Servicing is required when the apparatus has been damaged in any way, such as power-supply cord or plug is damaged, liquid has been spilled or objects have fallen into the apparatus, the apparatus has been exposed to rain or moisture, does not operate normally, or has been dropped.

15. If an outside antenna or cable system is connected to the product, be sure the antenna or cable system is grounded so as to provide some protection against voltage surges and built-up static charges. Section 810 of the National Electrical Code, ANSI/NFPA No. 70-1984 (Section 54 of Canadian Electrical Code, Part 1) provides information with respect to proper grounding of the mast and supporting structure, grounding of the lead-in wire to an antenna-discharge unit, size of grounding conductors, location of antenna-discharge unit, connection to grounding electrodes, and requirements for the grounding electrode. See following example.

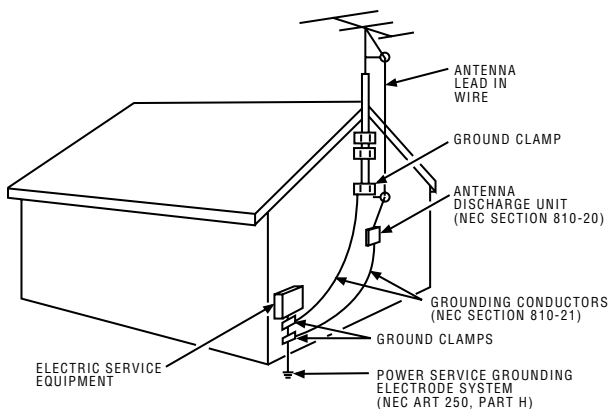

# Table of Contents

Important Safety Instructions .....	i
<b>Chapter 1: Connections and Setup</b>	
<b>Things to Consider Before You Connect .....</b>	<b>5</b>
Protect Against Power Surges.....	5
Protect Devices from Overheating .....	5
Position Cables Properly to Avoid Audio Interference .....	5
Use Indirect Light.....	5
Check Supplied Parts .....	5
<b>Get the Picture .....</b>	<b>6</b>
Getting Channels .....	6
<b>Choose Your Connection .....</b>	<b>7</b>
Video (Basic) Connection .....	8
Component Video (Advanced) Connection .....	8
HDMI/DVI Connection .....	10
USB Connection .....	12
VGA Connection .....	13
<b>Plug in the TV .....</b>	<b>14</b>
<b>Put Batteries in the Remote .....</b>	<b>14</b>
<b>Turn on the TV.....</b>	<b>14</b>
<b>How to Use the Remote Control to Complete the Initial Setup .....</b>	<b>14</b>
<b>Complete the Initial Setup .....</b>	<b>15</b>
Set the Menu Language .....	15
Complete Channel Setup .....	15
<b>What To Expect .....</b>	<b>16</b>
Watching TV.....	16
Changing Channels.....	16
<b>Explanation of Jacks (in alphabetical order).....</b>	<b>17</b>
<b>Buttons and Other Jacks On Your TV .....</b>	<b>18</b>
Side Input Jacks.....	18
Front Panel Buttons.....	18
<b>Chapter 2: Using the Remote Control</b>	
<b>The Buttons on the Remote Control.....</b>	<b>19</b>
Using the INPUT Button .....	20
<b>Programming the Remote to Operate Other Devices.....</b>	<b>20</b>
Find Out If You Need to Program the Remote ...	20
Programming the Remote .....	21
<b>How to Use the Remote After You've Programmed It .....</b>	<b>22</b>
Modes of Operation .....	22
<b>Volume Punchthrough Feature .....</b>	<b>22</b>
Deleting ALL Volume Punchthrough Commands .....	23
<b>Remote Code List .....</b>	<b>24</b>

## Chapter 3: Using the TV's Features

<b>Channel Banner.....</b>	<b>27</b>
<b>Autotuning .....</b>	<b>27</b>
<b>Parental Controls and V-Chip .....</b>	<b>29</b>
How V-Chip Works for USA and Canada.....	29
Lock/Unlock Parental Controls.....	29
US V-Chip TV Ratings.....	30
Blocking Canadian V-Chip Ratings .....	31
V-Chip Movie Rating Limit .....	32
Block Channels.....	32
Front Panel Block.....	32
Blocking Unrated/Exempt Programs .....	33
Future Rating Region .....	33
<b>Additional Features .....</b>	<b>33</b>
Screen Formats.....	33
PIP (Picture-in-Picture) Operation.....	34

## Chapter 4: Using the TV's Menu System

<b>Using the Menu System .....</b>	<b>36</b>
<b>Channel List Menu .....</b>	<b>36</b>
<b>Sound Menu .....</b>	<b>36</b>
<b>Picture Menu .....</b>	<b>38</b>
<b>PIP Menu.....</b>	<b>40</b>
<b>Setup Menu .....</b>	<b>40</b>
<b>Parental Control Menu .....</b>	<b>42</b>
<b>Time Menu.....</b>	<b>43</b>
<b>USB Menu .....</b>	<b>43</b>

## Chapter 5: Other Information

<b>Frequently Asked Questions (FAQs).....</b>	<b>45</b>
<b>Troubleshooting .....</b>	<b>46</b>
<b>Mounting Your TV to the Wall.....</b>	<b>49</b>
<b>V-Chip Rating Explanations.....</b>	<b>50</b>
US V-Chip Rating System .....	50
Canadian English V-Chip Rating System.....	50
Canadian French V-Chip Rating System .....	51
<b>Limited Warranty .....</b>	<b>52</b>
<b>Care and Cleaning.....</b>	<b>53</b>

# Chapter 1: Connections and Setup

## Things to Consider Before You Connect

### Protect Against Power Surges

- Connect all devices before you plug any of their power cords into the wall outlet or power strip. NEVER plug your TV into an outlet that is controlled by a wall switch.
- Turn off the TV and/or device(s) before you connect or disconnect any cables.
- Make sure all antennas and cables are properly grounded. Refer to the Important Safety Instructions at the beginning of the User's Guide.

### Protect Devices from Overheating

- Don't block ventilation holes on any of the devices. Arrange the devices so that air can circulate freely.
- Don't stack devices.
- If you place devices in a stand, make sure you allow adequate ventilation.
- If you connect an audio receiver or amplifier, place it on the top shelf so the heated air from it won't flow around other devices.

### Position Cables Properly to Avoid Audio Interference

- Insert each cable firmly into the designated jack.
- If you place devices above the TV, route all cables down the side of the back of the TV instead of straight down the middle.
- If your antenna uses 300-ohm twin lead cables, do not coil the cables. Also, keep the twin lead cables away from audio/video cables.

### Use Indirect Light

Don't place the TV where sunlight or room lighting will be directed toward the screen. Use soft or indirect lighting.

### Check Supplied Parts

Check that the following parts were packed with your product.

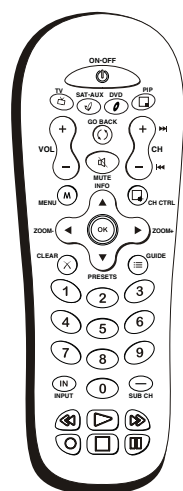

Remote control  
Part # R301C1

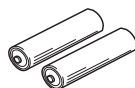

2 AA batteries

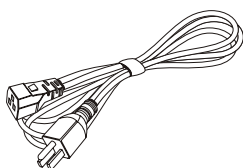

Power cord

**Note:** If you need to replace your remote, call 1-800-338-0376. A shipping and handling fee, and the appropriate sales tax, will be charged upon ordering. Have your Visa, MasterCard, or Discover Card ready.

# Connections and Setup

ANT/CABLE INPUT

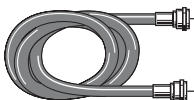
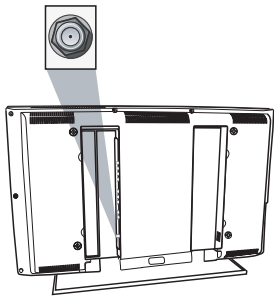

Coaxial cable

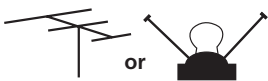

Outdoor or Indoor antenna

## Get the Picture

The first part of connecting your TV is to get the picture, also known as the signal. The back panel of your TV allows you to receive analog and/or digital channels by using the ANT/CABLE INPUT. See the graphic to the left for the location of the jack.

## Getting Channels

### What You Need

- Antenna ("rabbit ears") or outdoor antenna with coaxial cable

OR

- Coaxial cable with cable service

- A. Do you have an indoor or outdoor antenna? If not, go to step B. If so, plug the antenna or coaxial cable from the wall outlet into the ANT/CABLE Input to receive free off-air local digital and analog channels.
- B. Do you have cable? If so, plug the coaxial cable from the wall outlet into the ANT/CABLE Input to receive your cable channels.
- C. Do you have a set-top box? If so, you need to call your cable company or satellite service provider. They may use special cables to allow you to view digital channels.

### What You Need To Know



- Visit [www.antennaweb.org](http://www.antennaweb.org) to get help deciding what type of antenna to use to receive the local digital channels available to you. By entering where you live, this mapping program tells you what local analog and digital stations are available using a certain antenna.
- When you are ready to watch channels, the channel banner displays the type of channel you're viewing. Look for a *D* at the bottom of the screen for digital channels; look for an *A* for analog channels. Go to page 16 for more information.

# Connections and Setup

## Choose Your Connection

For additional assistance while using your RCA product, please visit [www.rca.com/customersupport](http://www.rca.com/customersupport).

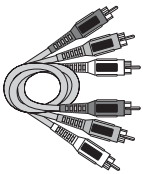
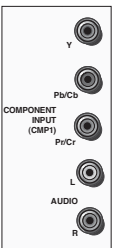
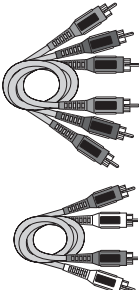
There are several ways to connect your TV. Please use the following chart to determine which connection is best for you. Proceed to the appropriate page and connect your TV.

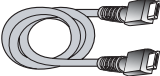
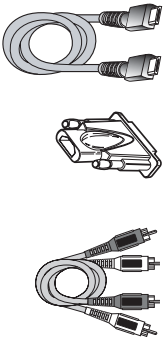
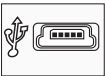
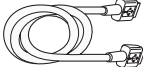
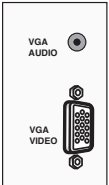
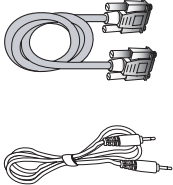
Jacks Used	Cables Needed	Go to...
 <p><b>Video1</b> <b>Audio1 R and L</b></p>	 <p><b>Audio/Video</b></p>	<b>page 8-9</b>
 <p><b>Y Pb/Cb Pr/Cr</b> <b>Audio R and L</b></p>	 <p><b>Component Video</b> <b>Audio</b></p>	<b>page 8-9</b>
 <p><b>HDMI/DVI</b></p>	 <p><b>HDMI™</b></p> <p><b>OR</b></p>	<b>page 10-11</b>
	 <p><b>HDMI™</b> + <b>HDMI/DVI adapter</b> + <b>Audio</b></p>	
 <p><b>USB</b></p>	 <p><b>USB</b></p>	<b>page 12</b>
 <p><b>VGA</b> <b>Audio</b></p>	 <p><b>VGA</b> <b>Audio</b></p>	<b>page 13</b>

HDMI, the HDMI logo, and High-Definition Multimedia Interface are trademarks or registered trademarks of HDMI Licensing LLC.



# Connections and Setup

## Video (Basic) Connection

This is an example of a connection using the Video jack. Go to the top of page 9 for specific instructions.

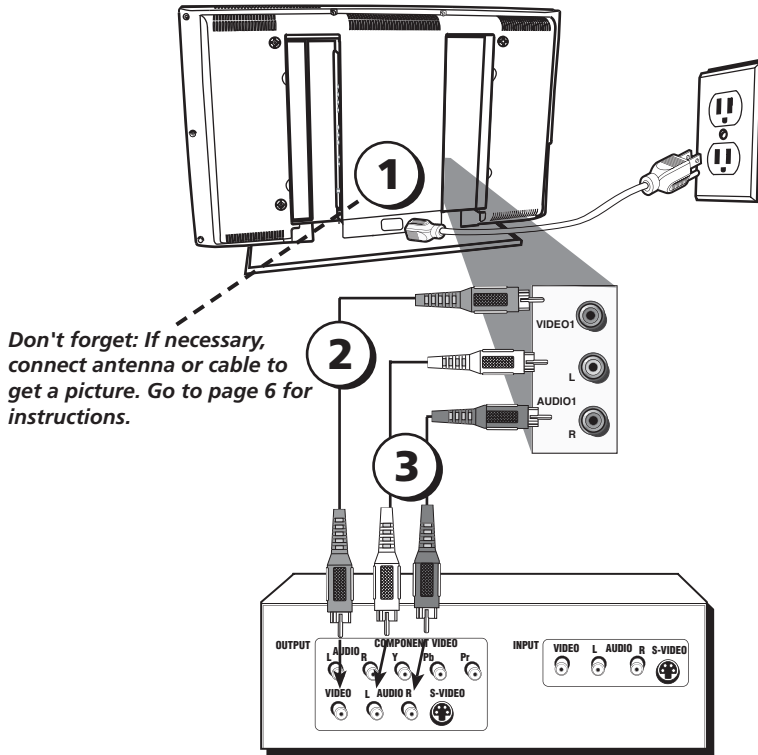

## Component Video (Advanced) Connection

This is an example of a connection using the Component Video jacks. Go to the middle of page 9 for specific instructions.

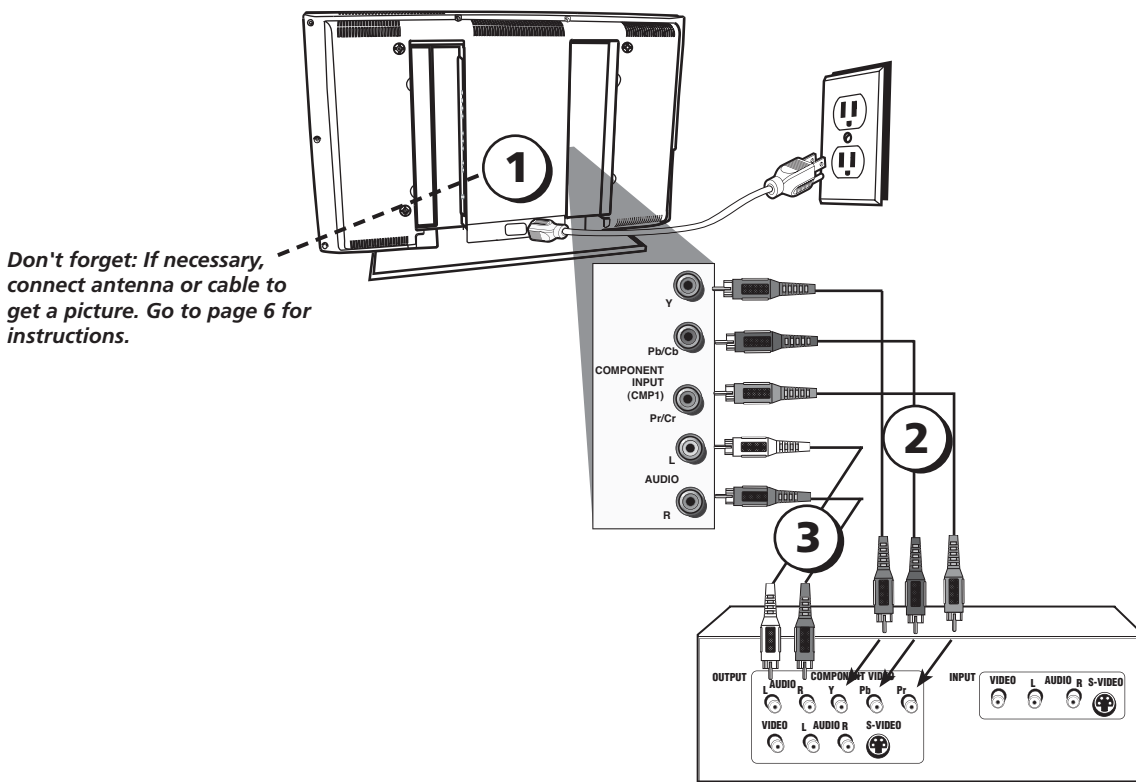



# Connections and Setup

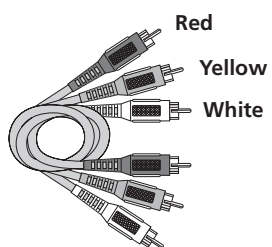

Composite cables are color coded- Yellow= video; Red= right audio; white= left audio

## Connecting the Device with Video (Basic)

This connection allows you to connect a device that has a Video Out jack, for example, a DVD player.

**Note:** If the device you're connecting also has Component Video jacks and you have component video cables, we recommend you use the Component Video (Advanced) Connection instead. See instructions below.

Using the example of a DVD player:

1. If necessary, connect your cable and/or off-air antenna as described on page 6.
2. Connect your yellow video cable.

Connect a video cable to the VIDEO1 Input jack on the back of the TV and to the Video Output jack on the DVD player.

3. Connect your red and white audio cables.

Connect the audio (red and white) cables to the AUDIO1 R and L/MONO jacks on the back of the TV and to the Audio Output jacks on the DVD player.

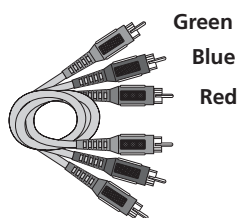

Component video cables (Y Pb Pr) are color coded-Green, Blue and Red

## Connecting the Device with Component Video (Advanced)

This connection allows you to connect a device that has Y Pb Pr or Y Cb Cr jacks, for example, a DVD player.

Using the example of a DVD player:

1. If necessary, connect your cable and/or off-air antenna as described on page 6.
2. Connect your Y Pb Pr component video cables.

Connect three video cables or special Y Pb Pr cables to the COMPONENT INPUT (CMP1) Y Pb/Cb Pr/Cr jacks on the back of the TV and to the Y Pb Pr or Y Cb Cr outputs on the DVD player.

3. Connect your red and white audio cables.

Connect the audio (red and white) cables to the CMP1 AUDIO R and L jacks on the back of the TV and to the Audio Output jacks on the DVD player.

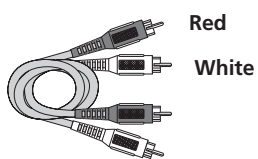

Audio cables are color coded- Red= right audio; white= left audio

## Viewing the Picture from the Connected Device

1. Plug in the TV (see page 14 for details) and the device, if they aren't already plugged in.
2. Turn on the TV and the device you want to view, for example a DVD player.
3. Repeatedly press the INPUT button on the remote control until you see VID1 (if connected to the VIDEO1 jack) or CMP1 (if connected to the CMP1 jacks) displayed at the bottom of the TV's screen. To go back to viewing TV channels, use the number buttons to enter the channel or press CH+/- to go to the channel list from the input list.

**Note:** If the picture from the DVD player appears black and white and your device is connected to the VIDEO Input, you might be tuned to the wrong input. Make sure you press INPUT until you see VID1 displayed at the bottom of the TV's screen.

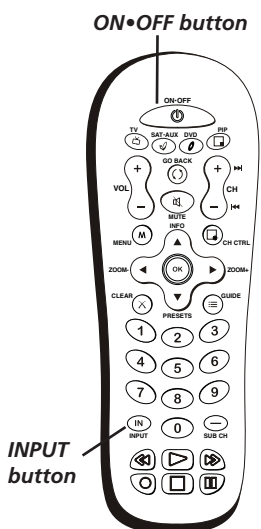

Use these buttons to view the picture of the device you've connected to the TV.

• If you're done connecting devices to your TV, go to page 14 to complete the Initial Setup.

• To continue connecting devices, go to the next page.

# Connections and Setup

## HDMI/DVI Connection

This is an example of a connection using the HDMI/DVI jack.

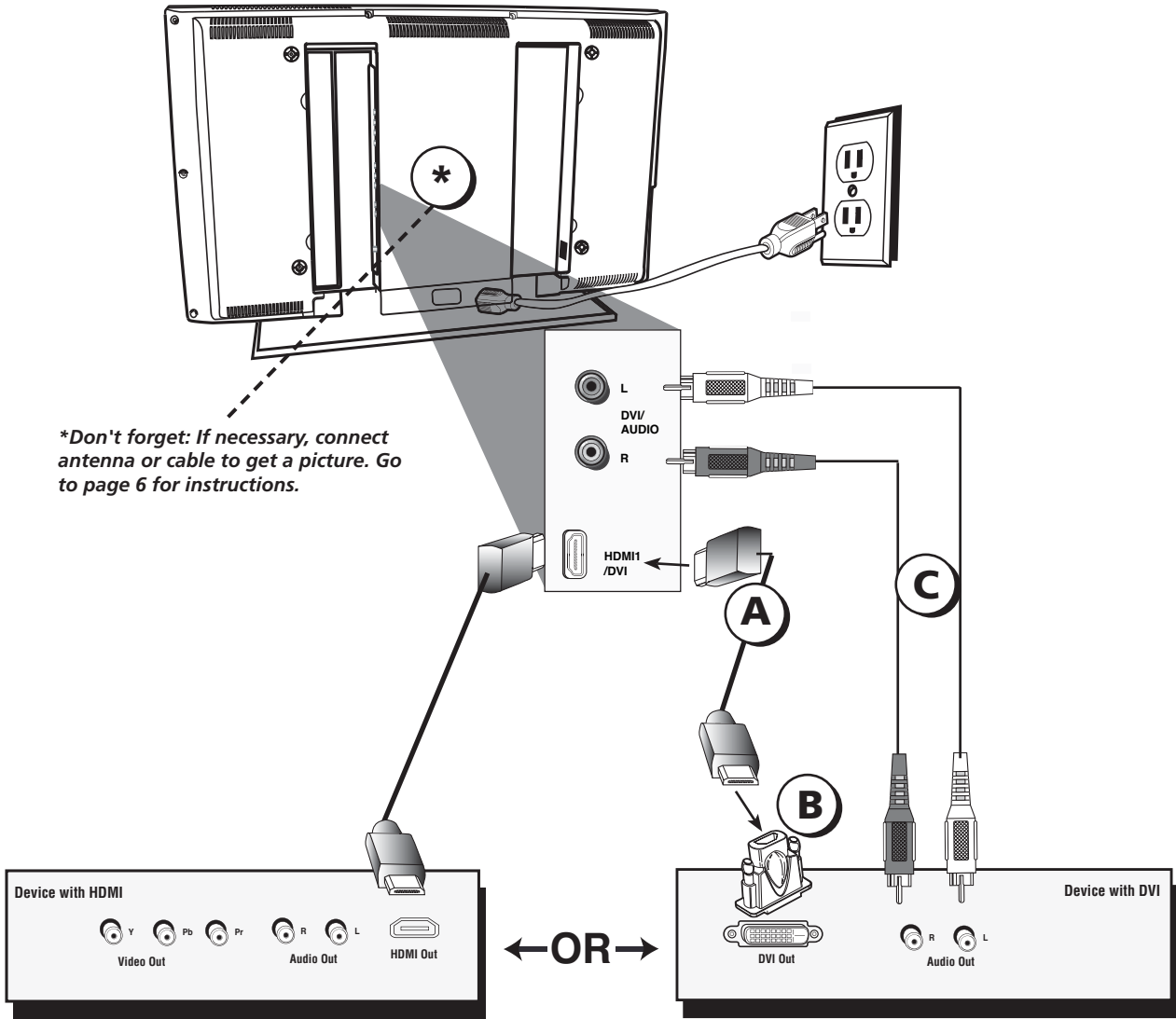

## Connecting the Device

High-Definition Multimedia Interface (HDMI) technology is an uncompressed digital connection that carries both video and audio data by way of an integrated mini-plug cable. Since HDMI technology is based on Digital Visual Interface (DVI), the jack on the back of your TV is also compatible with devices that have a DVI output jack.

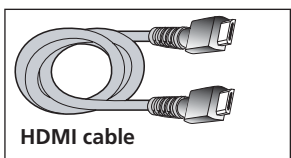

### Using the example of a set-top box:

- **If your set-top box has an HDMI jack, connect an HDMI cable.**

Connect an HDMI cable to the HDMI1/DVI Input jack (or the HDMI2 jack if it is more convenient) on the back of the TV and to the HDMI Out jack on the back of the device.

–OR–

- **If your set-top box has a DVI jack, connect an HDMI cable and an HDMI/DVI adapter.**

- Connect an HDMI cable to the HDMI1/DVI Input jack on the back of the TV.
- Attach an HDMI/DVI adapter to the end of the HDMI cable, then connect the adapter to the DVI Out jack on the set-top box.
- Since you're using an HDMI/DVI adapter, you need to connect Audio left and right cables to the DVI AUDIO R and L jacks on the back of the TV and to the R and L jacks on the back of the device.

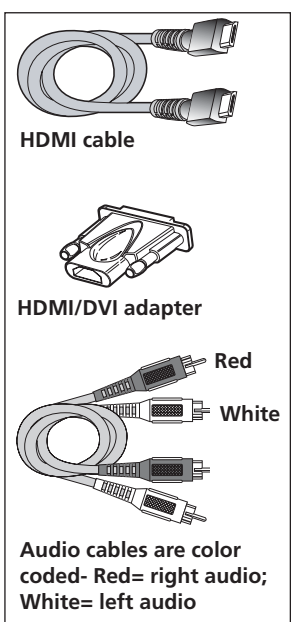

## Viewing the Picture from the Connected Device

The device in this connection is connected to the HDMI1/DVI jack. To view this device:

1. Plug in the TV (see page 14 for details) and the device, if they aren't already plugged in.
2. Turn on the TV and the device you want to view, for example a set-top box.
3. Repeatedly press the INPUT button on the remote control until you see *HDMI1* displayed at the bottom of the TV's screen. To go back to viewing TV channels, use the number buttons to enter the channel or press CH+ or CH- buttons.

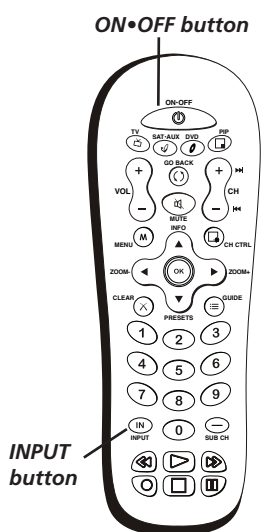

Use these buttons to view the picture of the device you've connected to the TV.

• If you're done connecting devices to your TV, go to page 14 to complete the Initial Setup.

• If you experience HDMI problems, go to the HDMI Troubleshooting section on page 47.

# Connections and Setup

## USB Connection

This is an example of a connection using the USB jack.

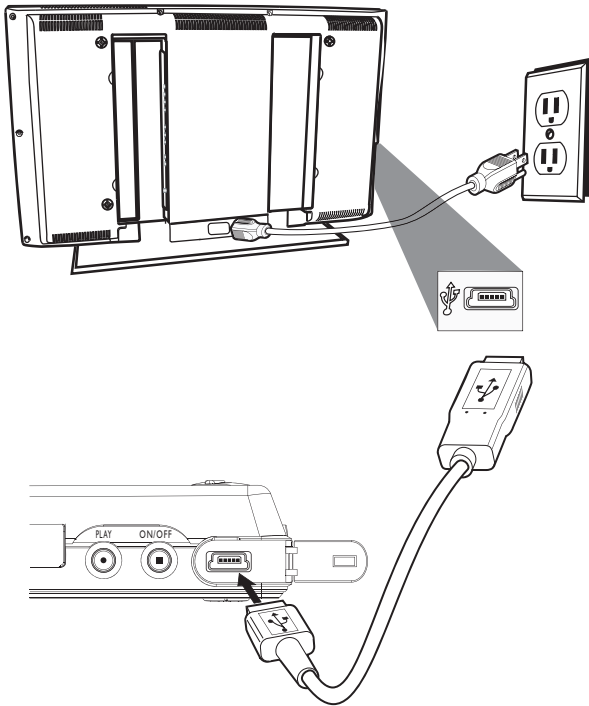

## Connecting the Device

This connection allows you to connect to a compatible mass storage device with USB, such as a digital camera, JumpDrive (FlashDrive), or mp3 player.

- Connect one end of the USB cable to the USB device and the other end to the USB jack on the TV.

## Viewing the Connected Device

1. Plug in the TV and the USB device, if they aren't already plugged in.
2. Turn on the TV and the device.
3. To access and adjust the options of the USB device, press MENU then choose *USB* from the Main menu. Go to page 43 for more information.

**Note:** When using a USB connection, you can play a picture slideshow from a folder not a picture.

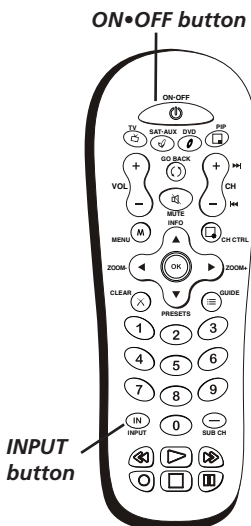

Use these buttons to view the picture of the device you've connected to the TV.

## VGA Connection

This is an example of a connection using the VGA jacks.

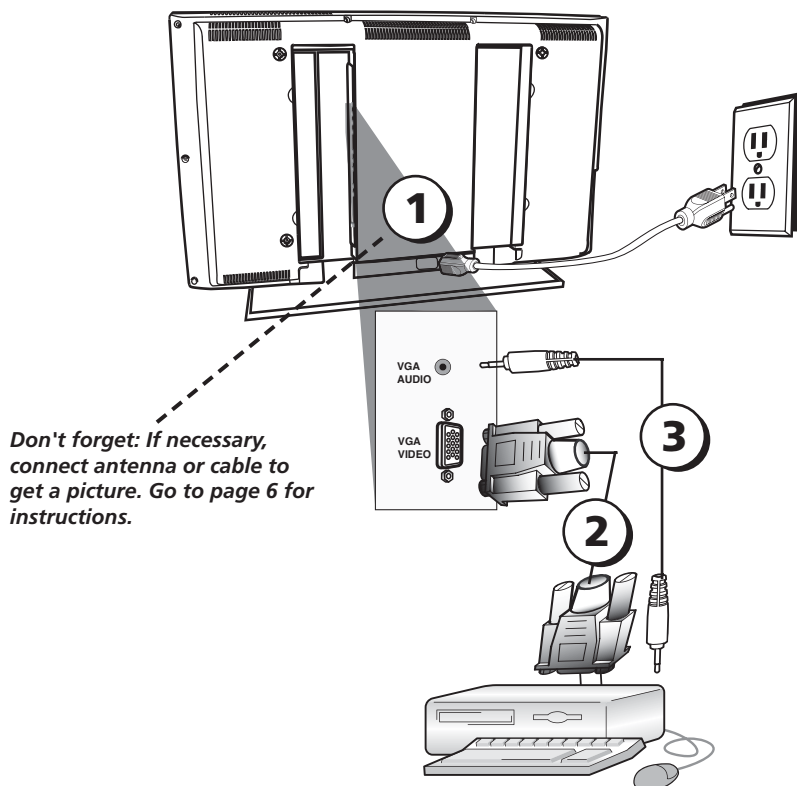

## Connecting the Device

This connection allows you to connect to a personal computer.

**1. If necessary, connect your cable and/or off-air antenna as described on page 6.**

**2. Connect your monitor cable.**

Connect one end of a 15-pin monitor cable to the VGA VIDEO jack on the TV and the other end to the PC's video output jack. Note, if your PC's video output isn't 15-pin, you'll need an adapter that can connect to a 15-pin monitor cable.

**3. Connect your audio cable.**

Connect a 3.5 mm stereo mini pin cable (sometimes referred to as 1/8" stereo mini pin) to the VGA AUDIO jack on the back of the TV and the other end to the Audio Output jack on the PC.

**Notes:** The maximum resolution is 1024 x 768. Be sure to set your PC to the correct monitor output setting.

To hear sound from the TV while using the PC, press the PRESETS button. Highlight PC Sound source and press the right arrow to choose TV tuner. Go to page 35 for more information about how to use PIP with this connection.

## Viewing the PC

1. Plug in the TV and the PC, if they aren't already plugged in.
2. Turn on the TV and the PC.
3. Repeatedly press the INPUT button on the remote control until you see VGA displayed at the bottom of the TV's screen. To go back to viewing TV channels, use the number buttons to enter the channel or press CH+ or CH- buttons.

# Connections and Setup

## Plug in the TV

Plug the end of the power cord into the back of the TV. Plug the other end into a grounded wall outlet. Insert the plug completely into the outlet. Do not plug into an outlet controlled by a light switch.

## Put Batteries in the Remote

- Remove the battery compartment cover from the back of the remote by pushing the tab and lifting off the cover.
- Insert two fresh batteries. Make sure the polarities (+ and -) are aligned correctly.
- Replace the cover.

## Turn on the TV

Turn on your TV by pressing the Power button on the front of the TV or ON•OFF on the remote control.

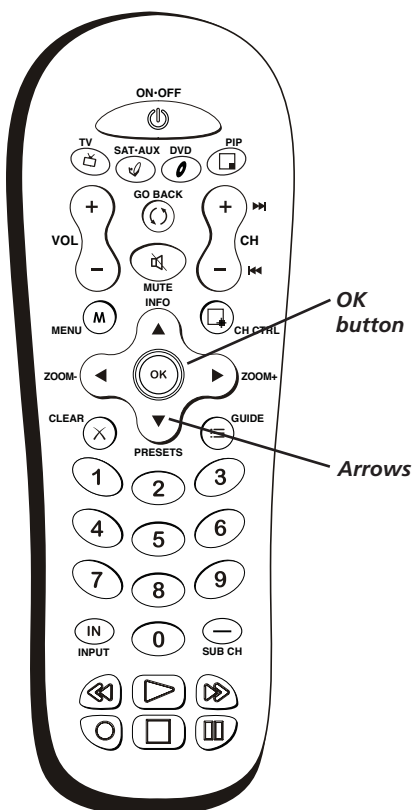

## How to Use the Remote Control to Complete the Initial Setup

The technical term is “Navigation” – how you move through the on-screen menus. The theory is the same throughout the menu screens: highlight your choice and select it.

To highlight a menu item, press the arrow buttons on the remote to highlight one of the items listed on the screen. Use the up or down arrow button to move up or down. Use the right or left arrow button to view other selections for a menu choice or to display a sub-menu. More than one selection displays, for example, *On...*; a menu choice with a sub-menu displays dots (...).

**Note:** *Highlighted means that the menu item stands out from other menu items on the list (appears darker, brighter, or a different color).*

### Tip

To access the setup menus manually, press **MENU** and choose **Setup**.

## Complete the Initial Setup

The menu system in your TV allows the TV's features to work properly. The first time you turn on your TV, the language screen appears.

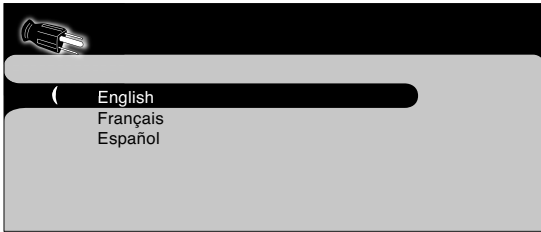

### Set the Menu Language

The first part of the setup allows you to select your preferred language for the menu system.

If English is your preferred language, press OK. To choose another language, press the down arrow button until that language is highlighted, and press OK.

## Complete Channel Setup

Make sure you've connected the TV to cable and/or an off-air signal before you start the next part of the setup.

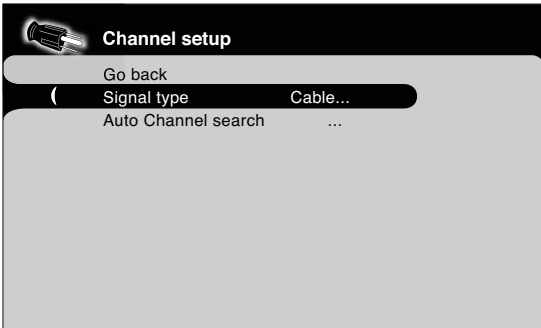

### Set the Signal Type

If you connected Cable to your ANT/CABLE jack, the option is chosen for you and you can press the down arrow button to continue. To choose *Antenna*, press the right arrow button and then press the down arrow button to continue.

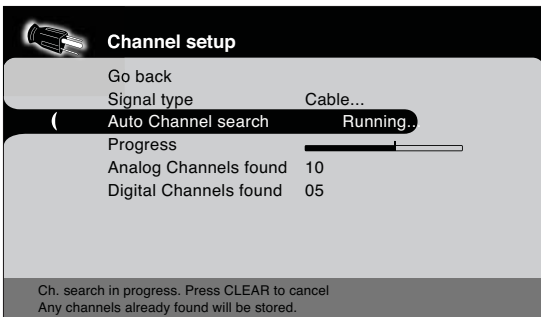

### Complete the Channel Search

Even though the initial channel search can take several minutes, you must complete it in order for your TV to display channels and programming. Press OK to begin the channel search. The menu shows the TV is running a channel search. When it's complete, the *Channel setup* menu remains on-screen. To exit the menu system, press CLEAR.

Some channels might have been found during the channel search that are unavailable to view and you might want to get rid of these so they don't appear as you change channels. To do this press OK (the *List and Labels* menu appears). Note that removing channels from your channel list may be time consuming, so you might want to do it later. Go to page 40 for details on editing your channel list.

**If you have analog and digital channels, the TV's search might take longer since it is looking for both.**



# Connections and Setup

## What To Expect

### Watching TV

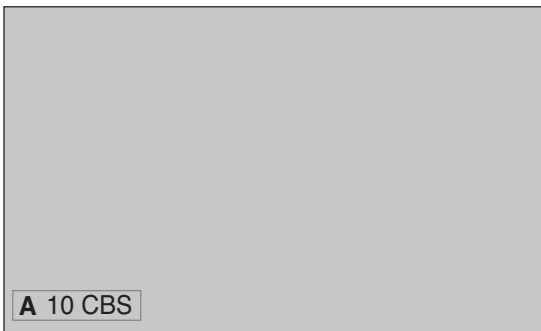

Look for the *A* at the bottom of the screen to see if you're watching an analog channel.



Look for the *D* at the bottom of the screen to see if you're watching a digital channel.

- **Remember:** Look for an *A* at the bottom of the screen to see if you're watching an analog channel.

Analog video is sent in a 4/3 format, which your TV displays these channels in a 16/9 format. Press the ZOOM+/- button to view the different formats available. Go to page 33 for more explanation of screen formats.

- **Remember:** Look for a *D* at the bottom of the screen to see if you're watching a digital channel.

Most digital video is sent in a 16/9 format which does fill your screen, but sometimes is sent in 4/3 which does not fill your screen. It depends on how the station or source device is formatting the video. **If there are bars on-screen, press the ZOOM+/- button to try a different format that may eliminate the bars.** Go to page 33 for more explanation of screen formats.

### Changing Channels

- Digital channels can have both primary channels (like the analog channel number) and sub-channels. To tune to a digital channel with a sub-channel, enter the primary channel number, then press either the right arrow or the SUB CH button. Enter the sub-channel number and press OK.
- Depending upon the type of signals you have connected to your HDTV, you might notice that the channels change slower than you're used to. This is perfectly normal. Digital cable channels sometimes take longer to tune.

## Explanation of Jacks (in alphabetical order)

This section describes the jacks on the back panel of your TV. There are several ways to connect devices.

**ANT/CABLE Input** Lets you connect a coaxial cable to receive the signal from your antenna, cable, or cable box.

**COMPONENT INPUTS** Lets you connect a device that has component video jacks, such as a DVD player.

- **CMP1 Y Pb/Cb Pr/Cr (Component Video)** Provides optimum picture quality because the video is separated into three signals. Use three video-grade or component video cables for the connection. When using CMP1 Y Pb/Cb Pr/Cr, make sure you connect left and right audio cables to the CMP1 L and R AUDIO jacks.
- **CMP1 L AUDIO** Provides left audio connection when using the CMP1 video inputs. The left audio connector is usually white.
- **CMP1 R AUDIO** Provides right audio connection when using the CMP1 video inputs. The right audio connector is usually red.
- **CMP2 Y Pb/Cb Pr/Cr (Component Video)** Same as described for CMP1 Y Pb/Cb Pr/Cr and CMP1 Audio above. Make sure you connect the left and right audio cables to the CMP2 L and R AUDIO jacks.

**HDMI1/DVI Input** Lets you connect a device, such as a digital cable box, with an HDMI or a DVI output.

- **HDMI1/DVI INPUT** (High-Definition Multimedia Interface/Digital Visual Interface) Provides an uncompressed digital connection that carries both video and audio data by way of an integrated mini-plug cable. Since HDMI technology is based on Digital Visual Interface (DVI), the jack on the back of your TV is also compatible with DVI devices.
- **L AUDIO (used for DVI only)** Provides left audio connection when using the DVI jack. The left audio connector is usually white.
- **R AUDIO (used for DVI only)** Provides right audio connection when using the DVI jack. The right audio connector is usually red.

***Note:** Remember to connect the left and right audio cables because the DVI cable carries only the picture signal, not the sound.*

**HDMI2 Input** Lets you connect a device, such as a digital cable box, with an HDMI output.

**SPDIF OUT** Use a digital coaxial cable to connect your TV to a compatible audio receiver.

**VGA** Connect your computer, or other device with a VGA output, to this jack using a 15 pin D-sub cable. Go to page 34 for more information about how to use PIP with this connection.

**VGA AUDIO (Stereo mini jack)** Use to obtain sound when a PC is connected to the VGA jack. Use a 3.5 mm stereo mini pin cable (sometimes referred to as 1/8" stereo mini pin) to connect a PC to your TV.

**VIDEO1 Input** Lets you connect a device that has composite video jacks, such as a VCR or DVD player.

- **L AUDIO** Provides left audio connection when using the VIDEO1 jack. The left audio connector is usually white.
- **R AUDIO** Provides right audio connection when using the VIDEO1 jack. The right audio connector is usually red.

# Connections and Setup

**VIDEO OUT** Connect a VCR or DVD-recorder to record digital and analog programs from the Digital or Analog Input (excluding copy-protected programs and component video formats) while the TV is turned on. You must leave the TV on the same channel you are recording.

- **L (AUDIO)** Provides left audio connection. The left audio connector is usually white.
- **R (AUDIO)** Provides right audio connection. The right audio connector is usually red.

## Buttons and Other Jacks On Your TV

### Side Input Jacks

**USB** Allows you to connect a compatible mass storage device with a USB jack. Go to page 12 for more information.

 **(Headphones)** Allows you to connect headphones to listen to the sound coming from the TV. To adjust volume control of the headphones, go to the *Headphone settings* option in the *Sound* menu.

**S-VIDEO Input** Allows you to connect an S-Video cable from another device. Make sure you also connect audio cables from the device to the TV. To access a device connected to the S-VIDEO jack, press the INPUT button on your remote until *VID2* appears at the bottom of the screen.

**VIDEO2 Input** Receives video from another device such as a camcorder, video game console, VCR, or DVD player. To access a device connected to the VIDEO jack, press the INPUT button on your remote until *VID2* appears at the bottom of the screen.

***Note:** Do not connect an S-Video and a regular video cable to the side jacks at the same time.*

**AUDIO L/MONO and R** Receives audio from another device such as a camcorder, video game console, VCR, or DVD player. Use when connecting to the VIDEO or S-VIDEO Input.

### Front Panel Buttons

If you cannot locate your remote, you can use the front panel buttons of your TV to operate many of the TV's features.

**MENU** Brings up the TV Main menu.

**VOL <** Decreases the volume. In the TV menu system, acts like the left arrow button on the remote control and adjusts menu controls.

**VOL >** Increases the volume. In the TV menu system, acts like the right arrow button on the remote control and adjusts menu controls.

**CH ^** Scans down through the channel list. In the TV menu system, acts like the down arrow button on the remote control and adjusts menu controls.

**CH v** Scans up through the channel list. In the TV menu system, acts like the up arrow button on the remote control and adjusts menu controls.

 (Power indicator) Turns the TV on and off.

## Chapter 2: Using the Remote Control

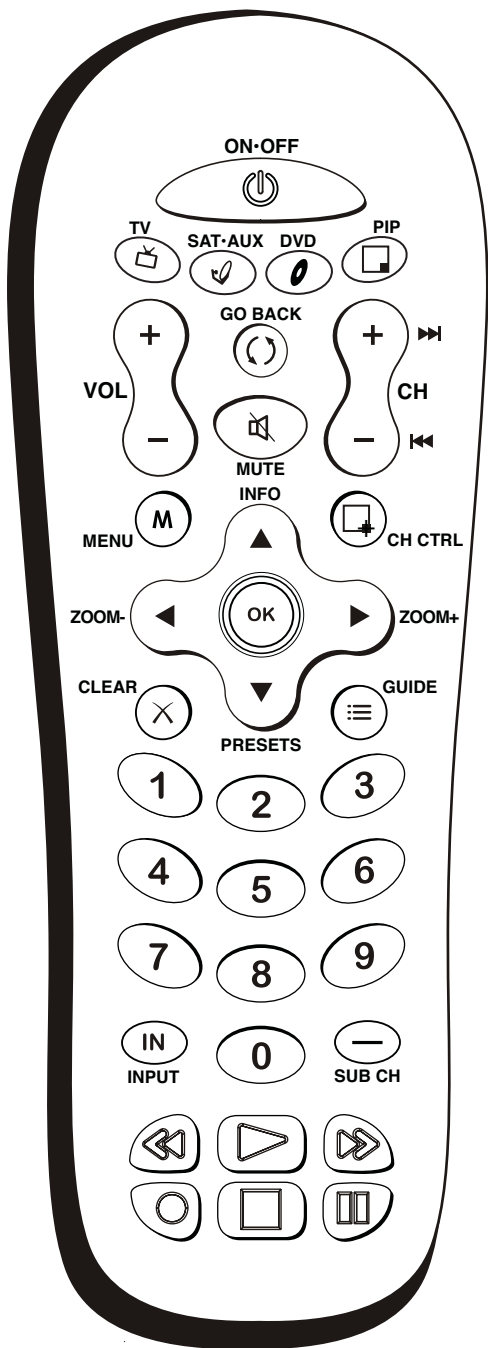

Remote control part number R301C1

**Note:** If you need to replace your remote, call 1-800-338-0376. A shipping and handling fee, and the appropriate sales tax, will be charged upon ordering. Have your Visa, MasterCard, or Discover Card ready.

### Tip

To turn off most RCA, GE, and Proscan components that are connected to the TV, press ON•OFF twice within two seconds.

This feature only works with most RCA, GE, and Proscan products.

## The Buttons on the Remote Control

**Alphanumeric Buttons** Enter channel numbers; time settings; and options with letters, such as the *Message* option, using these buttons. To enter a channel, press the number buttons and press OK (or just let the entry timeout).

To enter a digital channel with a sub-channel, enter the main channel, then press the right arrow to enter the sub-channel and press OK.

**Arrows** Used to highlight different items in the TV menu and to adjust the menu controls. **When viewing a channel, press the left or right arrow to change the screen format: 4/3, 16/9 zoom, Cinerama, and 16/9.** Go to page 33 for more information on screen formats.

**CH + or CH -** Scans up or down through the current channel list. Press once to change the channel up or down; press and hold to continue changing channels.

**CH CTRL (Channel control)** Toggles between the main TV picture and the PIP window. Use CH+/-, INPUT, SAT•AUX, DVD, or the number buttons to change channels in PIP.

**CLEAR** Removes any menu or display from the screen and returns you to normal viewing.

**GO BACK** Returns you to the previous channel.

**GUIDE** Displays an electronic program guide (when available).

**INFO** If no menus are on-screen, displays the channel banner; press again to clear the screen.

**INPUT** Accesses the available video input channels (*VID1*, *VID2*, *CMP1*, *CMP2*, *VGA*, *HDMI1* and *HDMI2*). To resume TV viewing, press the number buttons to enter the channel or press CH+ or CH- buttons.

**MENU** Brings up the Main menu.

**MUTE** Reduces the TV's volume to its minimum level. Press again to restore the volume. To program this button to work with an audio system, follow the instructions for *Volume Punchthrough Feature* on page 22.

**OK** When in the menu system, selects highlighted items.

**ON•OFF** When in TV mode, turns the TV on or off. If in another mode (SAT•AUX or DVD) and programmed, will turn the device on or off.

**PIP** Makes the PIP or POP window appear and disappear. Go to page 34 for more information on PIP.

**PRESETS** Displays *Picture* and *Sound preset*; *CC Settings*; *Current Audio Track*, *PC Sound source*; and *CH+/CH-* buttons.

**REVERSE, PLAY, FORWARD, RECORD, STOP, PAUSE (buttons at bottom of the remote)** If programmed, provides transport control for some remote-controllable VCRs or DVD players.

# Using the Remote Control

**SAT•AUX** Places the remote in SAT•AUX mode. If Auto Tuning is enabled, turns on the TV and tunes it to the satellite or cable box Video Input Channel. This button lights when you press a valid button in SAT•AUX mode (see *Modes of Operation* on page 22 for more details).

**SUB CH** When entering a digital channel that has a subchannel, press this button to access the subchannel entry field. Once the channel is entered, press the OK button to tune to the channel.

**TV** Turns on the TV and puts the remote in TV mode. Also displays current status.

**VOL – or VOL +** Decreases or increases the TV's volume. To program this button to work with an audio system, follow the instructions for *Volume Punchthrough Feature* on page 22.

**ZOOM– or ZOOM +** When viewing a channel, press to change the screen format: 4/3, 16/9 zoom, Cinerama, and 16/9. Go to page 33 for more information on screen formats.

## Using the INPUT Button

Use the INPUT button to scroll through the available video input channels and view devices you have connected to the TV.

1. Make sure the device you want to view is turned ON.
2. Press INPUT to tune to an available video input source and view the device.
3. To return to the previous channel, press INPUT until you return to the channel.

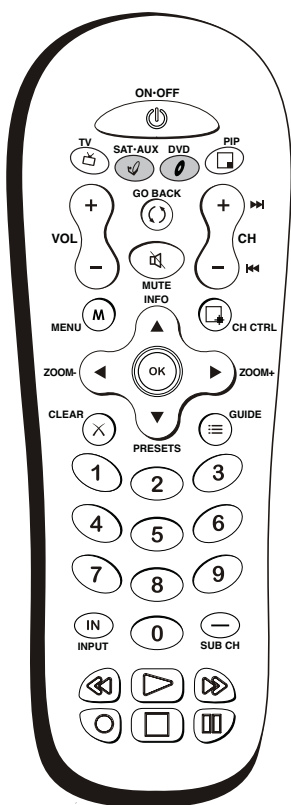

*The darkened buttons are the device buttons that can be programmed.*

## Programming the Remote to Operate Other Devices

The universal remote can be programmed to operate many brands of remote-controllable VCRs, audio devices, DVD players, cable boxes, satellite receivers and other devices. In addition to being programmed to operate your television, it's already programmed to operate some RCA devices.

**Notes:** *The TV button can't be programmed on this remote to control any device; it controls only this TV.*

*The remote may not be compatible with all models of all brands of devices. It also may not operate all functions of your device.*

## Find Out If You Need to Program the Remote

To determine whether the universal remote needs to be programmed to operate one of the devices connected to your TV, such as a VCR, do the following:

1. Turn on the device (in this example, a VCR).
2. Point the remote at the device.
3. Press the corresponding device button (in this example, VCR).
4. Press ON•OFF to see if the VCR responds. If the VCR doesn't respond, you need to program the remote to operate it.

# Using the Remote Control

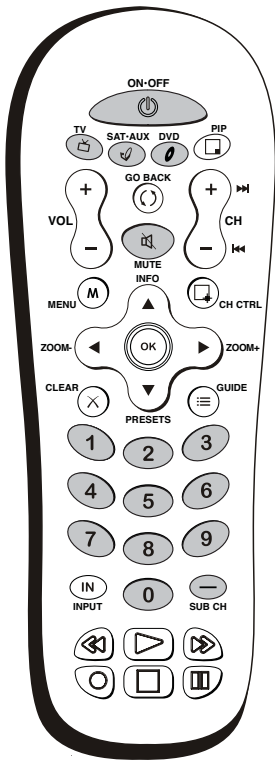

You'll use these darkened buttons for Direct Entry.

## Programming the Remote

There are three ways to program the remote control to operate other devices: *Direct Entry*, *Manual Code Search*, and *Automatic Code Search*. If you have recently purchased the device you want to control or if the device has many codes, you might want to try the manual code search first.

## Using Direct Entry

1. Turn on the device you want to control.
2. Look up the brand and code number(s) for the device in the code list at the end of this section.
3. On your remote control, simultaneously press and hold the ON•OFF and MUTE buttons (approximately 3 seconds) until a device button remains lit. Then release the buttons.
4. Press and release the device button (SAT•AUX or DVD) you want to program.
5. Enter a three digit code from the code list.
6. To test the code you've programmed for that device button, point the remote at the device and then press ON•OFF to see if the device responds to the remote control.

If the device turns off, you've entered the correct programming code for your device. Circle the code you entered for future reference.

If the device doesn't turn off, repeat these steps until you've tested all codes for your device's brand or try to run a manual code search.

## Using Manual Code Search

**Note:** Before using manual code search, you must use Direct Entry first. This lets the remote know which type of device to begin searching codes. Then proceed with the following steps.

1. Turn on the device you want to control.
2. On your remote control, simultaneously press and hold the ON•OFF and MUTE buttons (approximately 3 seconds) until a device button remains lit. Then release the buttons.
3. Press and release the device button (SAT•AUX or DVD) you want to program.
4. Repeatedly press and release the ON•OFF button, watching for the device to respond. If it does turn off, press and release the OK button within 3 seconds to save the code. If you accidentally passed the code before saving it, press the left arrow button to backtrack through the codes; then use the right arrow button to go forward through the codes again.

When all codes have been searched, the device button flashes 3 times, then the remote exits manual code search and returns to normal operation.

## Using Automatic Code Search

1. Turn on the device you want to control.
2. On your remote control, simultaneously press and hold ON•OFF and MUTE (approximately 3 seconds) until a device button remains lit. Then release the buttons.
3. Press and release the device button you want to program.

*continued on next page...*



# Using the Remote Control

---

4. Press and release the ON•OFF button once. There is a delay of approximately 6 seconds before the remote starts the code search.  
The device button blinks each time the remote control sends a code to test with your device. Keep pointing the remote at the device.
5. Once the device turns off, quickly press the OK button to save the code.
6. If you accidentally passed the code before saving it, press the left arrow button to back-track through the codes; then use the right arrow button to go forward through the codes again.

When all codes have been searched, the device button flashes 3 times, then the remote exits automatic code search and returns to normal operation.

## How to Use the Remote After You've Programmed It

Once the remote has been programmed successfully, you are ready to use it to operate your devices.

To operate the device:

1. Press the appropriate device button (SAT•AUX or DVD) to set the remote to control the device, for example, press DVD to control your DVD player.
2. Press ON•OFF to turn the device ON or OFF.
3. Use the remote buttons that apply to that device.

*Notes: The remote control may not be compatible with all brands and models of devices.*

## Modes of Operation

The button corresponding to the mode the remote is in lights up when you press any button that works in that mode. For example, if you're in TV mode and you press the VOL+ button, the TV button lights up. This tells you that the command to increase the volume is being sent to the TV (and not the satellite receiver, for example).

## Volume Punchthrough Feature

You may find this feature helpful if you've connected your devices to an audio system, and you want to use the TV's remote control to operate the volume for a device that is connected to the audio system. An example follows:

Let's say you've connected your DVD player to your audio system. You've also programmed your TV remote control to operate your DVD player. Since the DVD player sends its volume through the audio system, you would have to bounce back and forth between two remote controls: the audio system's remote to adjust the volume and the TV's remote control to operate the DVD player.

The Volume Punchthrough feature eliminates the need for you to use two remote controls and saves a button press when you're using the TV remote to adjust the volume. In effect, you are telling the TV remote to retrieve and send volume commands from the audio system whenever the TV remote is in DVD mode.



# Using the Remote Control

Therefore, after you've successfully set up the Volume Punchthrough feature, whenever the TV remote is in DVD mode (press the DVD button) and you want to adjust the volume, you only have to press the VOL +/- or MUTE buttons. Follow the instructions below to set up Volume Punchthrough.

1. On your remote control, simultaneously press and hold the ON•OFF and MUTE buttons (approximately 3 seconds) until a device button remains lit. Then release the buttons.
2. Press and hold the MUTE button until the device button blinks off, then release the MUTE button.
3. Press and release the device button that you programmed to operate the audio system (receiver or amplifier).
4. Press and release the MUTE button.
5. Now, test it by turning on your audio system.
6. Turn on the device that is connected to the audio system (satellite receiver, for example).
7. Put the TV's remote in SAT•AUX mode by pressing the SAT•AUX button.
8. Press VOL+ or VOL-. The volume from the audio system should increase or decrease accordingly.

## Deleting ALL Volume Punchthrough Commands

To delete all programmed Volume Punchthrough settings and return the remote control back to the factory defaults:

1. Simultaneously press and hold the ON•OFF and MUTE buttons (approximately 3 seconds) until a device button remains lit. Then release the buttons.
2. Press and hold the MUTE button until the device button blinks off, then release the MUTE button.
3. Press and release the MUTE button until the device button light turns off.
4. The remote returns to normal Volume/Mute control.

# Using the Remote Control

## Remote Code List

**Note:** The codes are programmable to any of the device buttons (SAT•AUX or DVD) on the remote.

### Audio Codes

AIWA	839 842 851 860
APEX	436
BOSE	672
CARVER	825
CITIZEN	826
CRITERION	448
DENON	803 817 852
DELPHI	708
FISHER	814 821
GOLDSTAR	766
HARMAN KARDON	804 818
JVC	790 813 819
KENWOOD	683 808 816 828 832 869
KOSS	415
MAGNAVOX	796 814 915 756
MARANTZ	688 824
mitsubishi	877
NAD	721 739 743
NEO	725
NORCENT	907
ONKYO	805 811 812 892
OPTIMUS	667 747 748 749 751 752 754 793
PANASONIC	791 810 815 823 863 864 891 950
PHILIPS	755 814 823 824 825
PIONEER	837 866 867 878 893
RADIO SHACK	706 754 793 806 865 866 867 868 875 878 879
RCA	717 726 772 781 795 827 845 866 867 870 871 872 875 878 879 449 895
REALISTIC	822
SABA	894
SAMSUNG	454
SANYO	705
SCOTT	768
SHARP	671 684 809
SHERWOOD	706 806 858 859
SKYFI	725
SONY	323 778 779 785 797 798 799 833 834 835 836 843 909
TAO	725
TEAC	710 807 855 856 857
TECHNICS	791 810 815 823 863 864
TEVION	448
VENTURER	745
XM RADIO	708 725
YAMAHA	801 802 838 840 841 846 847 848 849
ZENITH	676 730 749 759 765 766 784 814 787 850 405

### Cable

ABC	461 464 465 466 463
ADELPHIA	512 511
ALLEGRO	525 524
AMERICAST	527
ANTRONIX	468 469
ARCHER	468 469 470 471
AT&T	511
BELL SOUTH	527
CABLETENNA	468
CABLEVIEW	468
CABLEVISION	506
CENTURY	471
CITIZEN	471
COGECO	511
COLOR VOICE	472 473
COMCAST	511
COMTRONICS	474 475
CONTEC	476
DIGITAL MUSIC EXPRESS	514
EASTERN	477
EVERQUEST	474
GARRARD	471
GC ELECTRONICS	469
GEMINI	536 479
GE	549
OAK	476 489
PACE	532
PANASONIC	460 508
PARAGON	486 488
PHILIPS	471 479 485 490 491 492
PHILIPS-MAGNAVOX	505 534

PIONEER	478 506 493 494
PULSAR	486
RADIO SHACK	505 534 525
RCA	460 471 507
REALISTIC	469
REGAL	482
REGENCY	477
REMBRANDT	463
ROGERS	506
RUNCO	486
SAMSUNG	474 494
SCIENTIFIC ATLANTA	498 497 506 535 512 466 496
SHAW	511
SIGNAL	474
SIGNATURE	463
SL MARX	474
SPRUCER	460
STANDARD	499
STARCOM	461 518
STARGATE	474
STAR SIGHT	507
STAR TRAK	516
TANDY	500
TELEVIEW	474
TEXSCAN	499
TIME WARNER	506
TOCOM	464 513 520 501
TOSHIBA	486
TV86	487
UNIKA	468 469 471
UNITED CABLE	461
UNIVERSAL	468 469 470 471 502 524
VIDEOWAY	504
VIDEOTRON	506
VIEWSTAR	475 485 487 500
VIDEO TECH	550
ZENITH	503 525 471 486 521 522 523
ZENITH NETWORK	527

### CD

ADC	660
ADCOM	661 714
AIWA	663 707 842
AKAI	715 737 830
AUDIO TECHNICA	665
CALIFORNIA AUDIO LABS	716
CAPETRONIC	669
CARVER	666 667 668 825
CASIO	777
CITIZEN	826
CURTIS MATHES	777
DENON	670
EMERSON	661 673
FISHER	667 675 676 677 718
GENEXXA	673 678 719
GOLDSTAR	720
HARMAN KARDON	680 691
HITACHI	678
INKEL	681
JC PENNEY	690 777
JVC	682 813
KENWOOD	679 683 685 727 728 828
KRELL	666
KYOCERA	660
LUXMAN	686 687 729 738
LXI	777
MAGNAVOX	666 731 800
MARANTZ	666 688 689 732
MCS	690 777
MGA	691
MISSION	666
MITSUBISHI	691 692
NAD	721 743
NAKAMICHI	693 694 831
NEC	690
NIKKO	665 673 676
NSM	666
ONKYO	695 696 722 811
OPTIMUS	667 668 678 679 697 698 699 700 744 747 751
PANASONIC	716 733 740 820 862
PHILIPS	666 731 825

PIONEER	678 701 702 719 750 837 876
PROTON	666
QUASAR	716
RADIO SHACK	668 699 706 750 786 868 874 876
RCA	661 667 703 723 750 795 844 873 874 876
REALISTIC	661 667 669 673 678 689 697 699
ROTEL	666
SAE	666
SAMSUNG	741
SANSUI	666 704 723 734
SANYO	667 705 718 735 742
SCOTT	661 673
SEARS	679 689 777
SHARP	679 689
SHERWOOD	681 689 698 706 859
SHURE	690
SONY	707 792 794 800
STS	660
SYLVANIA	666
SYMPHONIC	709
TEAC	676 689 699 709 710 711 856
TECHNICS	716 733 820 862
THETA DIGITAL	731
TOSHIBA	721
VICTOR	682
YAMAHA	665 712 713 724 846
ZENITH	676 730 759 784 850

### DVD

ADVENT	922
AFREY	417
AIWA	414
AKAI	395 435
AMES	431
AMW	917 918
ANABA	961
APEX	386 390 391 392 424 430 436 439 445 457 459 938 949 913 401
ASPIRE	933
A-TREND	393
AUDIOVOX	921
AXION	921
B & K	978
BLAUPUNKT	430
BODYSONIC	417
BOSE	672
BROKSONIC	394 932 967
CENTRIOS	951
CHANGHONG	401
CINEVISION	405
CLASSIC	401 431
COBY	926 946 947 916 445 928 894
CONCEPT	430
CRITERION	448
CURTIS INTERNATIONAL	929 928
CYBERHOME	393 985 939
CYTRON	446 388
DAEWOO	440 441 444 971 965
DENON	400 421
DENZEL	428
DESAY	958
DIAMOND VISION	948 892 896
DIGIX	934
DIGITREX	445
DISNEY	458
DUAL	447 984 956 428 446
DURABRAND	449 405
DVD 2000	402
ELTA	434 435
EMERSON	405 456 458 940 899
ESA	956
FARENHEIT	960
FISHER	416
FUNAI	456 458
GE	409 430
GOLDSTAR	405
GO-VIDEO	407 426 455 431 937 971 454 902 901
GPX	936 944
GRADIENTE	415
GREENHILL	430
HAAS	451 452
HAIER	935

# Using the Remote Control

HARMAN KARDON .....	427
HITACHI .....	404 407 419 428
HITEKER .....	445
HUMAX .....	912
ILO .....	959
INFINITY .....	417
INSIGNIA .....	405 456 905 921 430
INITIAL .....	430
INTEGRA .....	422
JBL .....	427
JVC .....	406 418 923 964 900
JWIN .....	390 893 895
KAWASAKI .....	945 449
KENWOOD .....	400 429
KISS .....	428
KLH .....	430 906 386
KONKA .....	410 411 412 413 905
KOSS .....	415 388
KXD .....	894
LASONIC .....	451 948
LENOXX .....	931 435
LG .....	405 972 907
LINN .....	443
LITEON .....	982 902 898
MAGNAVOX .....	398 408 979 981 980 456 915 914 969
MARANTZ .....	398 405 408 423 981
MAXENT .....	923
MEDION .....	911 446 903 896
MEMOREX .....	446
MICROSOFT .....	409
MINTEK .....	430
MINTEK .....	402
MUSTEK .....	431
MYRON & DAVIS .....	962
NAD .....	405 433
NAKAMICHI .....	432
NESA .....	430
NEXXTECH .....	952 954 955 956
NORCENT .....	926 982 927 925 928
ONKYO .....	422 975
OPTIMUS .....	404
ORION .....	394
ORITRON .....	415
PANASONIC .....	387 396 400 437 974 950 970
PACIFIC .....	446
PHILIPS .....	398 408 423 755 979 981 980 456 458 969
PHILIPS-MAGNAVOX .....	398 408 423 979 980
PIONEER .....	403 404 976 977 968 909
POLAROID .....	385 949 957
POLK AUDIO .....	398 408 981
PORTLAND .....	435
PROLINE .....	415
PROSCAN .....	409 890
PROSONIC .....	926
RADIO SHACK .....	449 453 919 920
RCA .....	409 430 449 453 920 890
REGENT .....	931
REOC .....	451
ROSEN .....	930
ROTEL .....	406
SABA .....	919
SAMSUNG .....	407 454 455 942 963 891
SAMPO .....	417
SANSUI .....	394
SANYO .....	416 904
SEARS .....	394 456
SEG .....	428
SHARP .....	397 897
SHERWOOD .....	425
SHINCO .....	430
SHINSONIC .....	430
SONIC BLUE .....	937
SONY .....	987 988 989 389 399 986
SOUNDSTORM .....	910 911
SUNGALE .....	953
SUPERSCAN .....	456
SV2000 .....	456
SYLVANIA .....	456 458
SYMPHONIC .....	456 458 899
TEAC .....	404 449
TECHNICS .....	400
TECHWOOD .....	433
TERAPIN .....	943
TEVION .....	388 446 447 448 450 451 452
THETA DIGITAL .....	404
TIVO .....	912 909
TOSHIBA .....	394 398 973 924 983
TREDEX .....	941
UNITED .....	449
VENTURER .....	449
WHARFEDALE .....	442 417

WHITE WESTINGHOUSE .....	458
X-BOX .....	409
XENIUS .....	388
YAMAHA .....	400 420 979 980
YAMAKAWA .....	438 428
ZENITH .....	405 907

## DVD/VCR Combo Codes

Where the code is listed as [### ##] the first is for the DVD and the second is for the VCR. Otherwise just the one code operates both the DVD and the VCR.

APEX .....	949
BROKSONIC .....	394 967
CINEVISION .....	[405 245]
DAEWOO .....	971
DIAMOND VISION .....	896
DURABRAND .....	[405 245]
EMERSON .....	456 [458 227]
FISHER .....	[416 267]
FUNAI .....	456 [458 227]
GO-VIDEO .....	407 426 455 971
HITACHI .....	[419 227]
INSIGNIA .....	[405 245]
JVC .....	418
LG .....	907
MAGNAVOX .....	456 [914 286] [969 286]
MEDION .....	896
PANASONIC .....	437
PHILIPS .....	456 [969 286]
POLAROID .....	949
RCA .....	[409 255]
SAMSUNG .....	455 963
SANSUI .....	394
SANYO .....	[416 267]
SEARS .....	394
SONY .....	389
SYLVANIA .....	456 [458 227] [458 236]
SYMPHONIC .....	456 [458 227] [899 236]
TOSHIBA .....	924
WHITE WESTINGHOUSE .....	[458 227]
ZENITH .....	[405 245]

## DVR/DVD Combos

HUMAX .....	912
PANASONIC .....	387
PIONEER .....	909 977
TIVO .....	912 909
TOSHIBA .....	983 973

## DVR Codes

Where codes are shown like this [###] each one can be used if you have 2 or more of the SAME device.

AT&T .....	373
HUGHES .....	580
HUMAX .....	912
PANASONIC .....	373
PHILIPS .....	[371] [344] [345]
PIONEER .....	909 977
RCA .....	409
REPLAYTV .....	373
SONIC BLUE .....	373
SONY .....	372 657
TIVO .....	371 372 344 345 657 983 912 909
TOSHIBA .....	983

## DVR/Cable Combos

CABLEVISION .....	506
ILICO .....	506
PIONEER .....	506
ROGERS .....	506
SCIENTIFIC ATLANTA .....	506
TIME WARNER .....	506
VIDEOTRON .....	506

## DVR/SAT Combos

BELL EXPRESSVU .....	647 655
DISH NETWORK .....	655 647
DREAMBOX .....	620
ECHOSTAR .....	655 647
EXPRESSVU .....	647 655
FORTEC STAR .....	569 555 556
HUGHES NETWORK .....	621 580
RCA .....	653
PHILIPS .....	621
PROSCAN .....	653

SAMSUNG .....	583
SONY .....	657 659
ULTIMATE TV .....	653 659
ZENITH .....	656

## Home Theatre in a Box

Where the code is listed as [### ##] the first is for the DVD and the second is for the AUDIO. Otherwise just the one code operates both the DVD and the AUDIO.

AIWA .....	[414 839]
AMW .....	918
APEX .....	436
BOSE .....	672
CRITERION .....	448
DURABRAND .....	449 405
EMERSON .....	940
JVC .....	964
KLH .....	906
KOSS .....	415
LENOXX .....	931
LG .....	972
MAGNAVOX .....	915 [969 756] [408 756]
MYRON & DAVIS .....	962
NORCENT .....	928
ONKYO .....	975
PANASONIC .....	974
PHILIPS .....	755 [969 756]
PIONEER .....	976 968
RADIO SHACK .....	449 894 895 [453 879]
RCA .....	449 920 [453 879]
REGENT .....	931
SABA .....	919
SAMSUNG .....	454 942
SONY .....	986
TEVION .....	448
ZENITH .....	[405 787]

## Satellite/DTV Receivers

Where codes are shown like this [###] each one can be used if you have 2 or more of the SAME device or brand.

AMPLICA .....	575
BELL EXPRESSVU .....	654 647 655 628
CHANNEL MASTER .....	577 578 579
CHAPPARAL .....	560 561
CHEYENNE .....	561
DRAKE .....	562 574 587
DREAMBOX .....	620
DIRECTV .....	622 632 629 621 623 576 586 616 613 630 634 636 638641 652 653 657 659 607 619 641
DISH NETWORK .....	[655] [647] 628 612 654 588 589 590
DISHPRO .....	588 589 590 654
DX ANTENNA .....	568 582
ECHOSPHERE .....	628
ECHOSTAR .....	[655] [647] 628 612 654 588 589 590
EXPRESSVU .....	654 647 655 628
FORTEC STAR .....	569 555 556 557 558 559
FUJITSU .....	591 592
GE .....	636 649 637 622 653 650 651 652
GEMINI .....	595
GENERAL INSTRUMENT (GI) .....	[627] [642] [643] [644] 648 640 645 564 565 566 593
GO VIDEO .....	610
HITACHI .....	638 629 630 632 641 607
HUGHES NETWORK .....	621 641 607 580 [632] [638] [629] [630]
JVC .....	628
KENWOOD .....	598
LUXOR .....	599
MAGNAVOX .....	576 612 639
MACOM .....	600
MINTEK .....	641 632 638 629 630 607
MOTOROLA .....	648 618
NORSTAT .....	601
PACE .....	614 615 646
PANSAT .....	584
PANASONIC .....	626 586 596
PRIMESTAR .....	627 640
PHILIPS .....	576 612 621 629 630 632 638 641 607 639
PHILIPS-MAGNAVOX .....	576 612 639
PIONEER .....	604
PROSAT .....	563
PROSCAN .....	636 637 650 653 651 652
RCA .....	[636] 649 [637] 622 658 653 650 651 652 098
REALISTIC .....	567 603
SAMSUNG .....	594 583 613 616 619

# Using the Remote Control

SHARP .....	604
SKY NETWORK .....	614 615 646
SIERRA I II III .....	561
SONY .....	623 657 659 602
STARCHOICE .....	640 645 627
STAR SIGHT .....	633
STAR TRAK .....	608
STS .....	568 570 571
SUPER GUIDE .....	609
SYLVANIA .....	581
TOSHIBA ....	641 632 638 629 630 607 572 624 625 631
ULTIMATE TV .....	653 659
UNIDEN .....	633 573 611
UNITED .....	597
VIDEO CIPHER II .....	574
WEB TV .....	612 585
ZENITH .....	617 634 656 595 646 562 574 587 635

## VCR Codes

Where codes are shown like this [###] each one can be used if you have 2 or more of the SAME device or brand.

ACCELE .....	354
ADMIRAL .....	226
ADVENTURA .....	251
AIKO .....	252
AIWA .....	245 227 269 251
AKAI .....	227 229 228 230 231 254 303 337
ALLEGRO .....	247 329 243
AMERICAN HIGH .....	292
APEX .....	949
ASHA .....	354
AT&T .....	373
AUDIO DYNAMICS .....	376 377 234
AUDIOVOX .....	245
BELL & HOWELL .....	268
BEAUMARK .....	354
BROKSONIC .....	256 250 257 310 394 967 237 289
CALIX .....	245
CANDLE .....	240 245 354 234 242 244
CANNON .....	225 292 339
CAPEHART .....	329
CARVER .....	287
CCE .....	252 356
CINEVISION .....	245
CITIZEN .....	240 245 252 354 234 242 244
COLORTYME .....	234
COLT .....	356
CRAIG .....	245 354 356 248
CURTIS MATHES .....	225 287 227 334 354 358 234 249 292
CYBERNEX .....	354
DAEWOO .....	279 240 250 252 334 242 244 251 971
DBX .....	376 377 234
DIAMOND VISION .....	896
DIMENSIA .....	225
DURABRAND .....	245
DYNATECH .....	227 251
ELECTROHOME .....	245 254
ELECTROPHONIC .....	245
EMERSON ...	250 245 252 256 257 290 310 325 354 240 233 227 265 266 268 269 456 458 231 237 249 251 254 259 262 263 270 289 292 301 330 341
FISHER .....	304 268 267 287 234 248 273 274
FUJI .....	229 292
FUNAI .....	227 456 458 251
GARRARD .....	251
GE .....	225 311 335 342 354 278 292
GOLDSTAR .....	227 245 338 329 346 234
GRADIENTE .....	251
GO-VIDEO .....	354 375 407 426 455 971 368
HARLEY DAVIDSON .....	251
HARMAN KARDON .....	234 254
HARWOOD .....	356
HEADQUARTER .....	268
HITACHI .....	369 227 347 303 332
HI-Q .....	248
INFINITY .....	288
INSIGNIA .....	245
INSTANT REPLAY .....	227 292
INTEQ .....	245
JC PENNEY ..	225 245 268 354 369 376 377 292 303 332 343 234
JCL .....	292
JENSEN .....	369 303
JVC .....	376 377 268 247 418 234 303
KENWOOD .....	268 376 377 234 303
KLH .....	356
KODAK .....	245 292
LG .....	227 329 338 907

LLOYD .....	227 251
LOGIK .....	356
LXI .....	227 245
MAGNAVOX ..	287 288 329 226 225 456 286 235 227 914 969 292
MAGNIN .....	354
MARANTZ .....	287 268 376 377 289 292 339 234
MARTA .....	245
MATSUSHITA .....	292
MEDION .....	896
MEI .....	292
MEMOREX ..	287 245 268 304 310 329 354 226 227 337 248 251 292
MGA .....	290 254
MGN TECHNOLOGY .....	354
MIDLAND .....	278
MINOLTA .....	369 332
MITSUBISHI .....	290 298 369 376 377 254 295
MONTGOMERY WARD .....	226 300
MOTOROLA .....	226 292
MTC .....	227 354 251
MULTITECH .....	227 354 251 278 356
NEC .....	268 376 377 289 301 302 303 234 249
NIKKO .....	245
NOBLEX .....	354
OLYMPUS .....	292
OPTIMUS .....	239 354 363 245 361 374 381 226
OPTONICA .....	354 300
ORION .....	256 310
PANASONIC .....	363 381 374 373 225 437 292
PENTAX .....	369 234 332
PHILCO .....	287 225 235 292
PHILIPS .....	287 288 344 345 371 378 383 456 286 292
PHILIPS-MAGNAVOX .....	287 288 226
PILOT .....	245
PIONEER .....	305 369 376 377 343
PORTLAND .....	242 244
PROSCAN .....	225 308
PROTEC .....	356
PULSAR .....	329
QUARTER .....	268
QUARTZ .....	268
QUASAR .....	363 374 225 381 292
RADIO SHACK .....	225 226 227 239 . 245 268 342 354 361 363 248 251 254 274 292 300 337
RADIX .....	245
RANDEX .....	245
RCA ...[225] 245 [308] 309 311 312 313 314 315 316 335 342 ..... 354 369 228 278 292 332	
REALISTIC ...	225 226 227 245 268 354 361 363 248 251 ..... 254 274 292 300 337
REPLAYTV .....	373
RICOH .....	353
RUNCO .....	329
SAMSUNG .....	354 358 240 369 455 942 963 230 337
SANKY .....	226 329
SANSUI .....	310 376 377 394 256 303
SANYO .....	304 267 268 354 248
SCOTT .....	240 250 257 290 341 237 263
SEARS ...	363 245 268 287 369 394 456 248 273 274 292 332 343
SHARP .....	360 361 226 227 266 242 254 300
SHINTOM .....	229 353 369 356 357
SHOGUN .....	354
SIGNATURE .....	227
SINGER .....	292 356
SONIC BLUE .....	373
SONY ...	379 324 229 323 353 389 372 364 365 366 380 STS .....
STS .....	369 292 332
SUPERSCAN .....	456
SYLVANIA .....	227 287 290 225 236 456 458 251 292
SYMPHONIC .....	227 236 456 251
TANDY .....	227 268
TASHIKO .....	245
TATUNG .....	303
TEAC .....	227 251 303
TECHNICS .....	292
TEKNIKA .....	227 245 325 251 292
TIVO .....	371 372
TMK .....	354 249 301
TOSHIBA ....	240 261 260 287 290 358 369 924 274 341
TOTEVISION .....	245 354
UNITECH .....	354
VECTOR RESEARCH .....	240 376 377 234
VICTOR .....	376 377
VIDEO CONCEPTS .....	240 376 377 234 254
VIDEOSONIC .....	354
WARDS .	225 226 227 240 245 354 369 248 251 254 292 300 326 332 341 356

WHITE WESTINGHOUSE .....	227 279
XR-1000 .....	251 292 356
YAMAHA .....	376 377 234 303
ZENITH 329 247 252 266 288 226 227 338 347 353 358 245 229 310 232 232 376 377 279 368 243	

## Web TV

JVC .....	612
SONY .....	585

# Chapter 3: Using the TV's Features

## Channel Banner

There are several indicators that might appear when you press the INFO button on the remote. This display is called the Channel Banner. The following list describes the items on the Channel Banner screen (left to right and top to bottom).

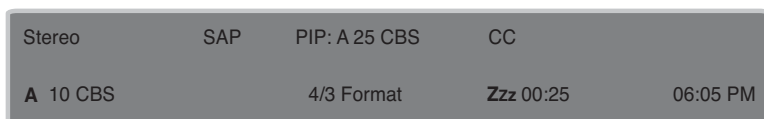

- TV-14** The current program rating.
- Stereo** *Stereo* appears when the current channel is broadcasting in stereo. *Mono* appears when the current channel is broadcasting in mono.
- SAP** The current channel is broadcasting SAP (Second Audio Program) information.
- PIP: A 25 CBS** Displays the current tuner, channel and program that's playing in the PIP window.
- CC** Closed Captioning is available on the current channel.
- A 10 CBS (analog)** The *A* means it's an analog channel. If it's a digital channel, *D* is displayed. The channel, sub-channel (if available for digital channels) and program you're currently viewing are displayed.
- 4/3 or 16/9 format** Current screen format. If there are bars on-screen you might be able to get rid of them by pressing the ZOOM buttons on the remote. Go to page 33 for more information on screen formats.
- Zzz 00:25** Current time left on sleep timer, if the sleep timer is set.
- 06:05 pm** Current time.

## Autotuning

**Note:** This feature only works with other RCA devices.

The autotuning feature automatically tunes the TV to the correct video input channel for different devices you have connected to your TV. When you set up autotuning in the menu system you don't have to remember to change your TV to the VID1 input, for example, when you want to watch a tape on the VCR. To set up the autotuning feature:

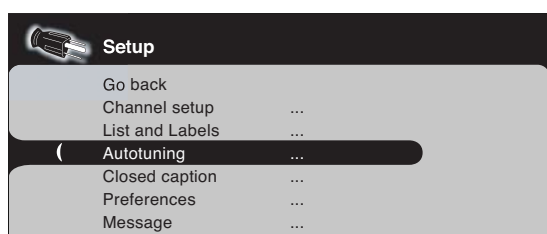

1. Press MENU (the MAIN MENU appears).
2. Highlight *Setup* and press OK on your remote control.
3. Highlight *Autotuning* and press OK.
4. Choose which device button you would like to set:

**Set VCR Channel** If the DVD or SAT•AUX button is programmed to your VCR, lets you set up the channel the TV tunes to when you press the corresponding button.

**Set DVD Channel** Lets you set up the channel the TV tunes to when you press the DVD button.

**Set SAT•AUX Channel** Lets you set up the channel the TV tunes to when you press the SAT•AUX button.

# Using the TV's Features

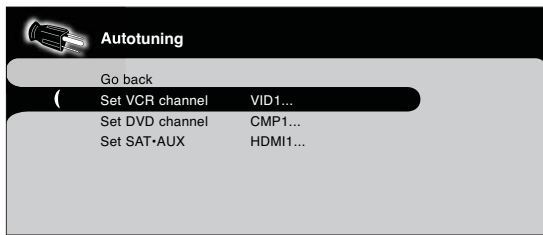

5. Press the right arrow button to select the choice that matches the way you have the device connected to this TV.

You can select from the following inputs or channels:

**N/A** Choose this if you don't have this particular device connected to the TV, or if you don't want the TV to automatically tune to the correct channel/input when you're using this device.

**Channel 3 or 4** Device is connected to the ANT/CABLE jack on the back of the TV, and you want the TV to tune to channel 3 when you press the corresponding button on the remote. Reminder: make sure the device's Channel 3/4 switch is set to channel 3.

**VID1 or VID2 (Video Input)** Device is connected to the VIDEO1 jack on the back of the TV or the VIDEO2 jack on the side of the TV and you want the TV to tune to the VIDEO input channel when you press the corresponding device button.

**CMP1 or CMP2 (Component Video Input)** Compatible component video source, such as an HDTV tuner or satellite receiver, is connected to the three COMPONENT VIDEO INPUT jacks (Y Pb Pr) on the back of the TV and you want the TV to tune to the component video input channel (CMP1 or CMP2) when you press the corresponding device button.

**VGA** Device is connected to the VGA jack on the back of the TV and you want the TV to tune to the VGA input channel when you press the corresponding device button

**HDMI1 or HDMI2** Device is connected to the HDMI1/DVI or HDMI2 jack on the back of the TV and you want the TV to tune to the HDMI input channel when you press the corresponding device button.



## Parental Controls and V-Chip

The choices in the *US V-Chip* and *Canada V-Chip* menus involve software inside your TV (referred to as V-Chip) which allows you to block TV programs and movies. TV programs can be blocked by age-based ratings, such as TV-MA, which is explained on page 31. If available, TV programs can also be blocked by content, such as adult language (L). This is explained on page 29. Movies can only be blocked by age-based ratings. This is explained on page 30.

Once you block programs, you can unblock programs by entering a password.

By default, the software inside your TV is turned off or unlocked. For instructions to lock V-Chip, see below.

**Note:** Parental control settings are not available for HDMI1/DVI, HDMI2, CMP1, or 2 inputs. These settings must be set in the connected device's parental controls.

## How V-Chip Works for USA and Canada

V-Chip reads the program's age-based rating (TV-MA, TV-14, etc.) and content themes [(Violence (V), Adult Language (L), etc.)]. If you have blocked the rating and/or content themes that the program contains, you will receive the message *This channel is blocked. Change channel or press OK to enter your password and temporarily deactivate the parental controls.*

Broadcasters are not required to provide content themes, so programs received with no content themes will only be blocked if you block their age-based rating. You can also block out programs that have been given an Exempt rating, and programs that are considered unrated. Go to page 50 for the US and Canada ratings explanations.

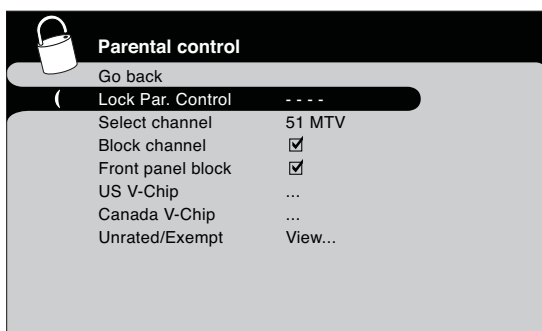

## Lock/Unlock Parental Controls

Selecting this option lets you lock and unlock parental controls settings using a password.

**If you do not lock parental controls, none of the settings for V-Chip, Channel Block, or Front Panel Block will take effect.**

If you forget your password, turn off the TV. Simultaneously press and hold VOL- on the front panel and CLEAR on the remote for 10 seconds. Next time you enter the *Parental control* menu enter a new password.



# Using the TV's Features

## The V-Chip Rating Screen

The following is an example of where items are located within the Rating Limit screen.

### Rating Status Field

Lets you select whether the status of the age-based rating limit to the left is *View* or *Block*.

### Rating Field

Lets you select from a list of age-based ratings you can block or view.

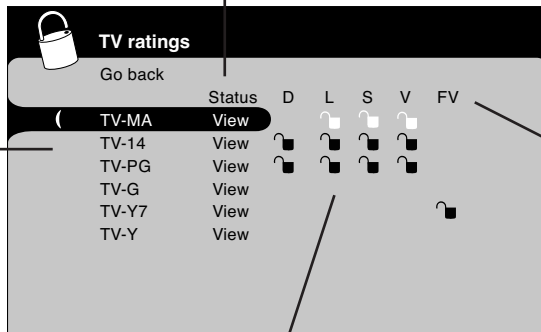

### Content Themes

Lets the content themes you can block or view.

### Content Status Fields

Lets you select which content themes to view for the selected rating, and whether the status of the content theme is currently unlocked (🔓) or locked (🔒).

Hierarchy of Age-Based Ratings	
TV-MA	Mature Audience Only
TV-14	Parents Strongly Cautioned
TV-PG	Parental Guidance Suggested
TV-G	General Audience
TV-Y7	Directed to Children 7 years and older
TV-Y	All Children

## US V-Chip TV Ratings

### Blocking Age-Based Ratings

You can automatically block all program ratings above a specified age-based rating level.

1. Choose *Parental control* from the Main Menu. If Parental controls have previously been locked, you must enter your password.
2. Highlight and select *US V-Chip*. Then select *TV ratings*.
3. Press the up or down arrow button to scroll to the rating corresponding with the lowest rating you do not want the child to watch.
4. Press the OK button to toggle between *View* and *Block*. The status for the rating and all higher ratings automatically changes to Block.
5. Use the up/down arrow buttons to highlight *Go back* and press OK.
6. Select *Lock Parental Controls* from the *Parental Control* menu for rating limits to take effect.

**Note:** If you forget your password, turn off the TV. Simultaneously press and hold **VOL-** on the front panel and **CLEAR** on the remote for 10 seconds. Next time you enter the Parental control menu enter a new password.

To view age-based ratings after you've locked them, follow the same steps as above to unlock.

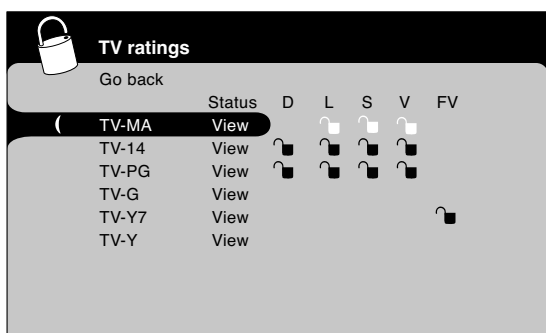

# Using the TV's Features

Content Themes	
D	Sexually explicit dialogue
L	Adult language
S	Sexual situations
V	Violence
FV	Fantasy Violence

## Blocking Specific Content Themes

You can block programs based on their content. (Content is represented by the *D*, *L*, *S*, *V* and *FV* on your screen.) When you block a content theme for a particular rating, you automatically block that content theme for higher rated programs as well.

To block program content:

1. Determine the content themes you want to block.
2. Press the down arrow button to scroll to the rating whose content theme you want to change.
3. Press the right arrow button to move the highlight to a particular content theme.
4. Press the OK button to change its status to lock. (In the example to the left, you block the language (L) corresponding with TV-14. The language for TV-MA is blocked as well.)

**Notes:** Broadcasters are not required to provide content themes or age-based ratings.

You must remember to lock Parental controls for rating limits to take effect.

To view content theme after you've locked them, follow the same steps as above to unlock. Note that if you unlock the language corresponding with TV-14, the language for TV-MA doesn't unlock. You have to unlock the content theme status for each rating separately.

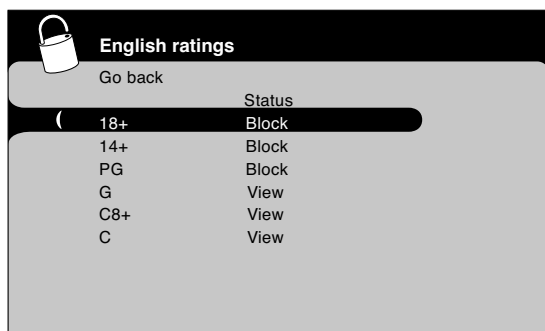
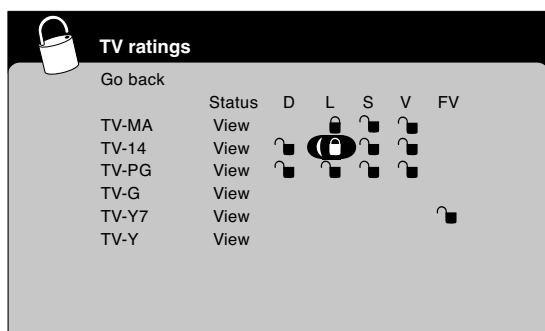

## Blocking Canadian V-Chip Ratings

If you receive Canadian programs you can block Canadian English and French V-Chip by ratings only. When you block a particular rating, you automatically block the higher rated programs as well.

To block Canadian English and French program ratings:

1. Select *Canada V-Chip* from the *Parental control* menu.
2. Highlight *English ratings* or *French ratings* and press OK.
3. Determine the rating you want to block.
4. Press the down arrow button to scroll to the rating you want to change.
5. Press the OK button to change its status to block (all ratings above the one you selected change to block).

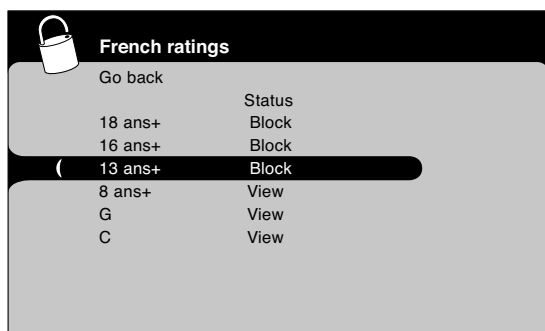

# Using the TV's Features

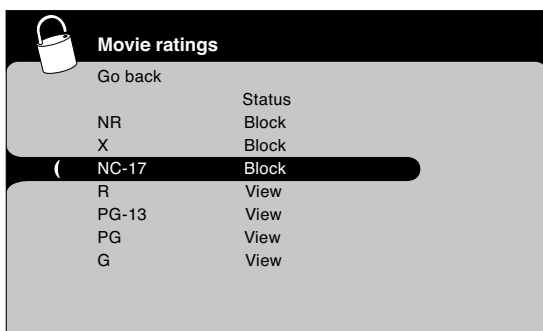

## V-Chip Movie Rating Limit

Set movie rating limits by blocking movies rated above a specified level.

To access the Movie Rating Limit menu:

1. Press MENU on the remote control (the TV's *Main Menu* appears).
2. Select *Parental control*.
3. Select *US V-Chip*.
4. Select *Movie ratings*.

## Blocking Movie Ratings

Once you are in the *Movie ratings* menu, follow the same steps described for blocking Canadian ratings.

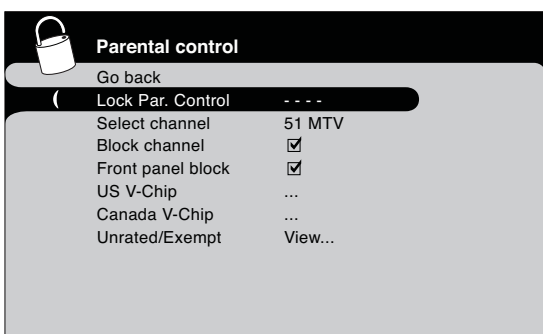

## Block Channels

Turn this option on to block the channel you choose in the *Select channel* option.

Use the number buttons to enter the channel you want to block, then press the down arrow button. Press OK to place a check mark in the *Block channel* box to block the channel. When you tune to that channel you'll need to enter a password to view the channel if the TV is locked.

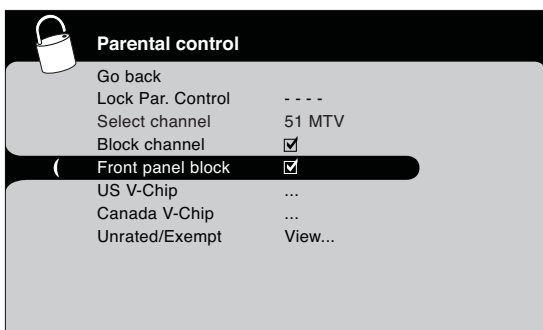

## Front Panel Block

Select this option to block (disable) or unblock (enable) the TV's front panel buttons so that they can't be used by someone, like a young child. The remote still tunes to any channel. If you're using this to keep children from changing channels, remove access to any remote that is capable of operating the television while you have the front panel blocked.

Don't forget to lock parental controls after you change the status. If you don't, the front panel block will not take effect.

# Using the TV's Features

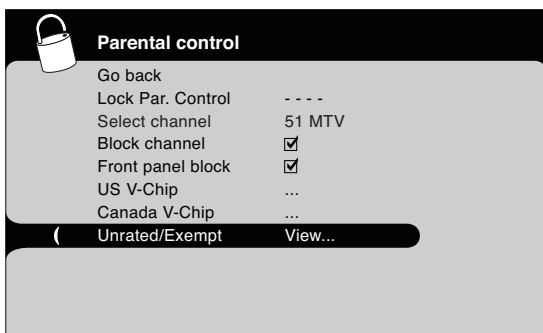

## Blocking Unrated/Exempt Programs

The *Unrated/Exempt* option lets you decide if programs that the V-Chip recognizes as unrated or exempt can be viewed. Unrated TV programs may include news, sports, political, religious, local and weather programs, emergency bulletins, public announcements, and programs without ratings. The Exempt option applies to both USA and Canadian unrated programs and Canadian programs rated *E*.

*View* All unrated programs are available.

*Block* All unrated programs are not available.

**Note:** You must remember to lock Parental controls for rating limits to take effect.

Press the down arrow button to highlight *Unrated/Exempt*. Then press the right arrow button to toggle between *View* and *Block*.

## Future Rating Region

You might notice an option in your Parental control menu that wasn't there before. This is because broadcasters have the capability to add a new rating system for TV programs. These ratings let you define additional parameters for parental controls. This option and its name are dependent on the content acquired from the broadcaster.

**Note:** These ratings are available only if the broadcaster is sending them.

## Additional Features

There are additional features available unrelated to Parental Controls. These features can be found in other menus.

## Screen Formats

Screen format is the way the picture is displayed on your TV. Press the ZOOM +/- button on your remote to see if a different format is available for the video you are viewing. The format changes as you press the ZOOM buttons and the format type is displayed at the bottom of the screen.

Analog video is sent in a 4/3 format, which your TV displays in a 16/9 format. Most digital video is sent in a 16/9 format which does fill your screen, but sometimes is sent in 4/3 which does not fill your screen. It depends on how the station or device connected to your TV is formatting the video. If there are bars on-screen, press the ZOOM +/- button to try a different format that may eliminate the bars.

The different formats available and what they look like follow.

*Continued on next page...*

# Using the TV's Features

## (Screen Formats continued)



4/3 (available for analog video; may be available for digital video)

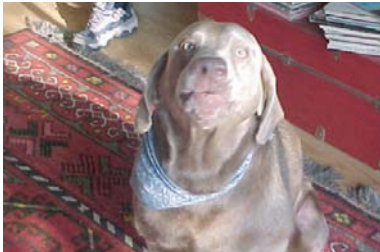

16/9 zoom (available for analog video; may be available for digital video)

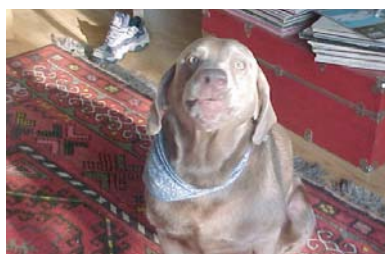

16/9



Cinerama

## PIP (Picture-in-Picture) Operation

The PIP (Picture-In-Picture) feature lets you display a second, smaller picture on top of the main picture or display two pictures side by side, called POP. For more information on customizing the PIP feature, go to page 40. The main and PIP channels must be from different tuners. The VGA, COMPONENT INPUTS, HDMI1/DVI, and HDMI2 can't be displayed in the smaller window.

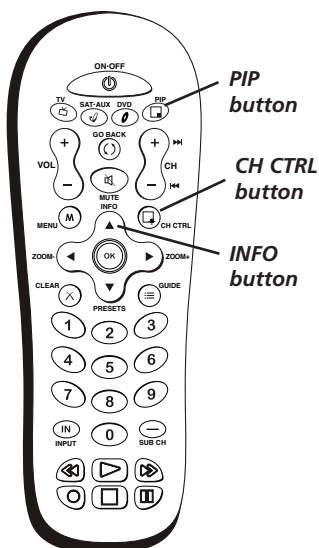

Use these buttons for the PIP feature

### PIP Buttons

There are certain remote buttons that control the way the PIP window works:

**PIP** Brings up the PIP window. Press PIP again to remove the window.

**CH CTRL** (Channel Control) Lets you switch channel control between the PIP window and the main picture. To determine whether you are controlling the PIP or the main picture, look at the channel banner as you change channels or press INFO button. The PIP window has a yellow highlight around it if you are controlling it.

## Using the PIP Feature

While you may use PIP in different ways, this basic PIP scenario should get you started. When watching a channel, follow these steps.

1. Press the PIP button on the remote control and the PIP window appears on the screen.
2. Press the CH CTRL (Channel Control) button on the remote to highlight the PIP window. (A yellow border appears around the edge).  
Use the channel up and down, INPUT, or component buttons that have been auto tuned, to change the PIP channel.
3. To change the program in the main picture window, press CH CTRL. Then use any of the above mentioned buttons. To go back and forth between controlling the PIP window and the main picture, press the CH CTRL button.

## Using PIP with the VGA jack

When watching content from the VGA input, follow these steps.

1. Press the PIP button on the remote control and the PIP window appears on the screen.
2. Press the CH CTRL (Channel Control) button on the remote to highlight the PIP window. (A yellow border appears around the edge).  
Use the channel up and down, INPUT, or component buttons that have been auto tuned, to change the PIP channel.
3. To change the program in the main picture window, press CH CTRL. Then use any of the above mentioned buttons. To go back and forth between controlling the PIP window and the main picture, press the CH CTRL button.
4. Press the PRESETS button on the remote control and go to *PC Sound source*. Choose *PC* if you want to hear sound from the device connected via the VGA jack. Choose *PIP/POP* if you want to hear sound from the main window.

## PIP Problems?

- If you are channel surfing or changing inputs in the main window and PIP disappears, you may have tuned to an input that doesn't support PIP.
- If you press PIP and the PIP window is gray, you may have activated the Parental Control feature and the program exceeds the rating limits you set. For information on removing limits, see the *Parental Controls* section.
- Closed captioning is not viewable in the PIP window.

# Chapter 4: Using the TV's Menu System

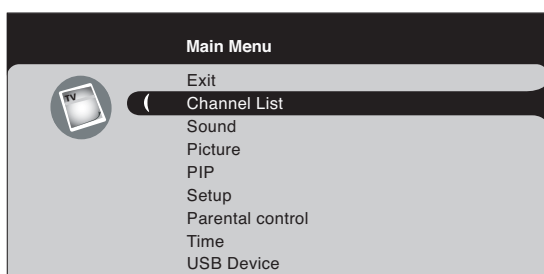

## Using the Menu System

This section explores the menus of your TV. Each menu is outlined and detailed to help you get the most from your TV. The *Parental control* menu is discussed in the Features chapter.

To access the menu system:

1. Press the MENU button.
2. Use the up and down arrow buttons to highlight an option and press OK to display it. The name of the menu is displayed at the top of the menu screen.
3. Press the up and down arrow buttons to move to a different option within the menu. If necessary, press the OK button to display the choices of the option you've highlighted. If available, use the text at the bottom of each screen for help.
4. To return to the Main Menu, press the MENU button until it's displayed.

**Note:** Options in the menus that are grayed-out and can't be highlighted are unavailable or in progress.

Descriptions of each menu are discussed in the order they appear.

There are two ways to exit a menu:

- Press the CLEAR button. The menus are cleared from the screen and you return to TV viewing.
- Press the MENU button repeatedly until the menu disappears.

## Channel List Menu

The Channel List menu allows you to view all the channels available in your channel list. Press the up or down arrow button to highlight a channel then press OK to tune to the channel and exit the menu.

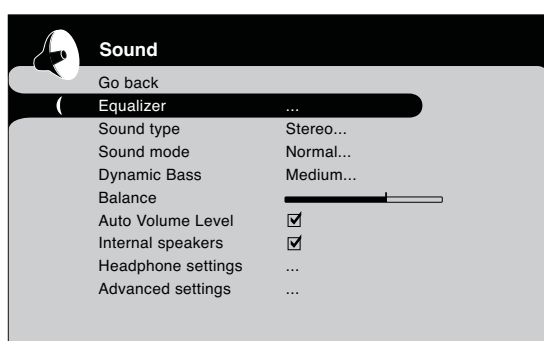

## Sound Menu

The Sound menu lets you adjust audio output. To access the Sound menu, press MENU on the remote, and then select *Sound* from the Main Menu. The following audio items can be adjusted:

**Equalizer** The five-band graphic equalizer lets you adjust the audio frequency settings. You can select one of the five-band Equalizer Presets or create your own personal preset.

**Sound preset** Allows you to choose a specific sound preset. Press the right arrow to cycle through the options: *Standard*, *Movie*, *Voice*, *Music* and *Personal*.

**Frequency range** Displays the different graphic equalizer bands set for each Sound preset option. Choose a band and make adjustments. When you make adjustments, the *Sound preset* option automatically changes to *Personal*. Press the left or right arrow button to select the frequency (100Hz, 300Hz, 1kHz, 3kHz, 10kHz) you want to adjust. Then use the up or down arrow button to adjust the level. When you're done adjusting the levels, press the MENU button to exit.



# Using the TV's Menu System

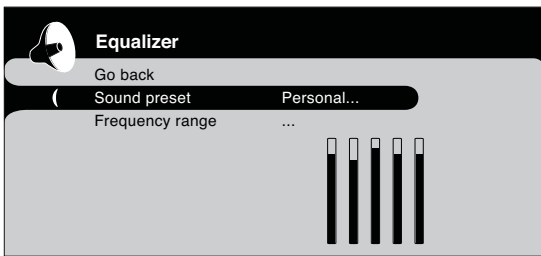

To view the frequency range of another *Sound preset* option, press the right or left arrow until no band is selected and *Frequency range* is highlighted. Then press the up arrow to highlight *Sound preset*.

**Sound type** Controls the way the sound comes through your speakers. The options available vary according to the input selected.

**Mono** (available for regular TV viewing only) Plays the sound in mono only. Use this setting when receiving broadcasts with weak stereo signals.

**Stereo** Splits the incoming stereo audio signal into left and right channels. Most TV programs and recorded materials have stereo audio. The word *Stereo* appears in the channel banner when you tune to a program that is broadcast in stereo.

**Note:** *Sound type and its menu choices are only available with components programmed to the SAT•AUX button.*

**Sound mode** Provides special processing through your speakers (depending on the setting you chose as your *Sound type*). The available audio modes are:

**Normal** Does not give any special processing, simply provides the mono or stereo sound provided by the signal you're watching.

**Wide** (available only for mono signals) “Widens” sound from mono broadcasts and mono devices connected to your TV for a fuller, more spacious sound.

**Stereo Wide** Available only for stereo signals. Gives a surround effect with more bass.

**BBE** Maximizes simulated sound effects while maintaining clarity and definition.

**Dynamic Bass** Improves bass output. Displays a choice list of available settings you can adjust: *Off*, *Medium* and *High*.

**Balance** Adjusts how much audio is sent to the left and right speakers.

**Auto Volume Level** Reduces the annoying blasts in volume during commercial breaks, and also amplifies softer sounds in program material. Eliminates the need to constantly adjust the volume.

**Internal speakers** Turn on or off the internal speakers. If you have a device connected to the Audio Output jacks on the back of the TV and you want to control the sound by the device instead, uncheck the box.

**Headphone settings** Displays a choice list of available settings you can adjust: *Volume*, *Bass* and *Treble*. The *Headphone sound* option allows you to choose *Stereo*, *Mono* or *Auto*. These descriptions are same as for *Sound Type* (see above).

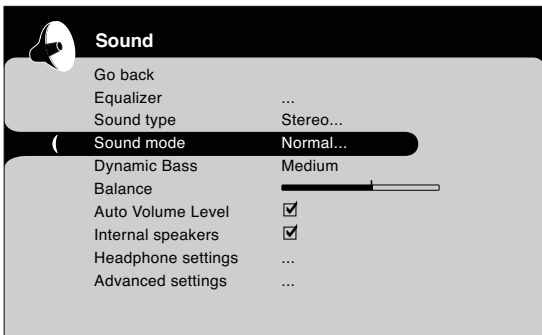

# Using the TV's Menu System

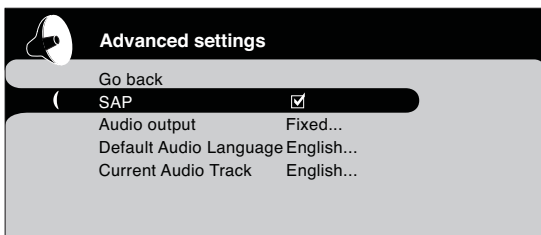

## Advanced settings

**Second Audio Program (SAP)** Plays the program's audio in a second language, if one is available. The letters *SAP* appear in the channel banner when you tune to a program that is broadcast with SAP information. SAP audio is broadcast in mono. SAP is also used to broadcast a program's audio with descriptions of the video for the visually impaired.

**Audio Output** Lets you choose a setting for the AUDIO OUTPUT jacks.

- **Variable** Provides variable output from the AUDIO OUTPUT jacks. Use this setting if the TV is not connected to an audio receiver or amplifier and the volume is controlled by the TV.
- **Fixed** Provides fixed output from the AUDIO OUTPUT jacks to a receiver or amplifier. With the Fixed Output, the TV's volume control, graphic equalizer, and mute are disabled. This output is ideal when connecting to an audio receiver or amplifier that has its own remote control for controlling the volume.

**Default Audio Language** Choose the language you prefer for dialog on digital channels. If your preferred language is being broadcast with a program, then the TV plays it. If not, then the TV plays the default audio for the program (usually English in the U.S.). The default digital channel audio language options are *English, Spanish, French, German, Italian, Japanese, Chinese,* and *Korean*.

**Current Audio Track** Press the right arrow to choose from the audio languages available for the program you're watching. The language you choose becomes your preferred audio language for all digital channels until you turn the TV off. If the language you choose here is not being broadcast with a program, then the TV plays the default audio for the program (usually English in the U.S.).

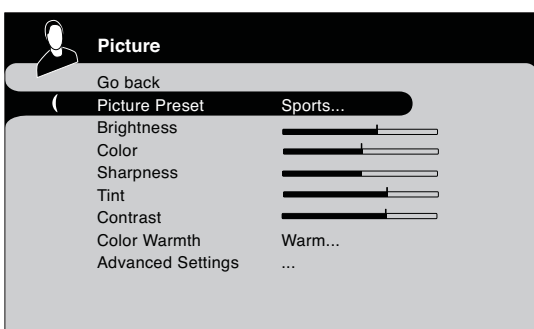

## Picture Menu

The *Picture* menu contains menus and controls to configure how the picture looks. The Picture menu options apply to the video for the main TV and video input selections. All picture options can be applied to each input- VID1, VID2, CMP1 or CMP2, HDMI1 or HDM2, VGA, and USB.

**Picture preset (not available on VGA)** Displays a choice list that lets you select one of the preset picture settings: *Vibrant, Cinematic, Natural, Sports, Videogame, Video camera* or *Personal*. Choose the setting that is best for your viewing environment.

**Brightness** Adjusts the brightness of the picture.

**Color (not available on VGA)** Adjusts the richness of the color.

**Sharpness (not available on VGA)** Adjusts the crispness of the edges in the picture.

**Tint** Adjusts the balance between the red and green levels.

**Contrast** Adjusts the difference between the light and dark areas of the picture.

# Using the TV's Menu System

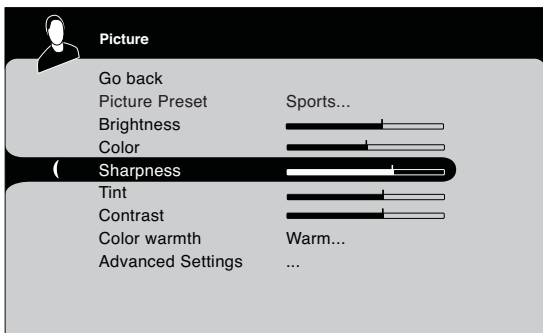

**Color Warmth** Displays a choice list that lets you set one of three automatic color adjustments: *Cool* for a more blue palette of picture colors; *Normal*; or *Warm* for a more red palette of picture colors. The warm setting corresponds to the NTSC standard of 6500 K.

When you change any of these picture settings, the *Picture Preset* changes to *Personal*. Use the left or right arrow button to make adjustments. To return to the *Picture* menu, press the up or down arrow button.

## **Advanced picture settings (not available on VGA)**

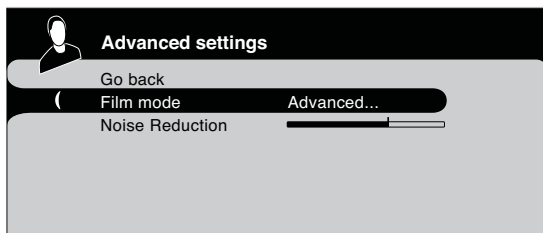

**Film mode (3:2 Pulldown)** Automatically detects video sources that were originally recorded on film (like most movies) and subsequently converted to a different format (for TV broadcast, for example). Film mode processes the converted signal so that it looks as close as possible to the original. Another name for this process is reverse 3:2 pulldown.

**Advanced** (recommended) enables the feature only when the TV detects that movie playback quality could be improved. *Advanced* is the default setting.

The **On** setting should only be used in rare circumstances when the TV is used solely with film-based sources (like DVDs on a non-progressive-scan player).

The **Off** setting turns off film mode upconversion. Try using this setting if you think the reverse 3:2 pulldown is causing distortions in your picture.

**Noise reduction** Reduces picture "static" or any type of interference. This feature is especially useful for providing a clearer picture in weak analog signal conditions. Press the right arrow to choose between: *Off* for no noise reduction; *Low* for a softer, smoother picture that retains picture sharpness and detail; *Medium* for a slightly softer picture than the *Low* setting; *High* for an even softer, smoother picture than the other settings (the picture detail is somewhat decreased).

**Note:** Video noise reduction is available for the CMP1 and CMP2 inputs only if the signal is 480i.

# Using the TV's Menu System

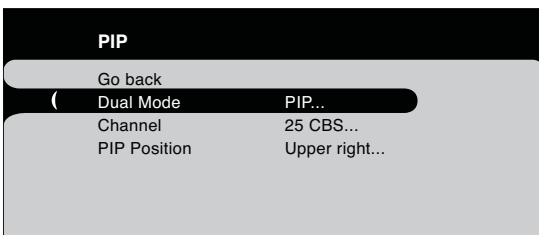

## PIP Menu

The PIP menu lets you customize the PIP feature. To access the *PIP* menu, press MENU on the remote, and then select *PIP* from the Main Menu. Go to page 34 for more information on using the PIP feature.

**Dual Mode** Adjusts the way the picture is displayed. The choices are: *PIP* (Picture-in-Picture), *POP* (Picture-on-Picture- pictures are side by side) or *Off*.

**Channel** Select the channel displayed in the PIP or POP window.

**PIP Position** Select the location where the PIP window is displayed: *Upper Left*, *Bottom Left*, *Upper Right*, or *Bottom Right*.

## Setup Menu

The Setup menu lets you configure the TV to fit its surroundings and your preferences. To access the *Setup* menu, press MENU on the remote, and then select *Setup* from the Main Menu.

### Channel setup

**Signal type** Choose the type of signal you have connected to the ANT/CABLE Input.

**Auto Channel search** Searches for channels the signal is receiving. Go to page 15 for more information.

**List and Labels** Edit the channels in the list or choose labels for each channel.

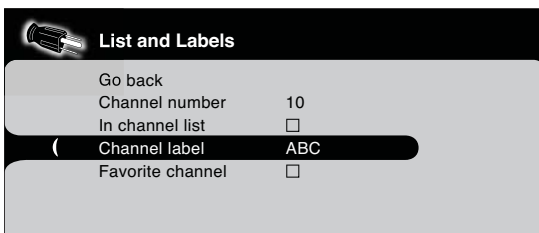

**Channel number** Use the number buttons on your remote to enter the channel number.

**In channel list** If you've entered a channel you want to add to the channel list, highlight *In channel list* and press the right arrow to place a check in the check box. If you've entered a channel you want to delete from the channel list, press the right arrow button to uncheck the box.

**Channel label** Allows you to add a six character label, which is displayed on-screen when you tune to the channel entered in the *Channel number* option above. Press the alphanumeric button corresponding with character you want to enter. Continue to press the right arrow button to highlight the next space to add another character.

**Favorite channel** The channel you entered for *Channel number* can be saved as a favorite channel. You can have up to 6 favorite channels.

**Autotuning** Go to Chapter 3 for details about the Autotuning feature.

**Closed caption** Many programs are encoded with closed-captioning information, which lets you display the audio portion of a program as text on the TV screen.

**Note:** *Closed caption settings are not available for HDMI1/DVI, HDMI2, CMP1, or 2 inputs. These settings must be set in the connected device's menu.*

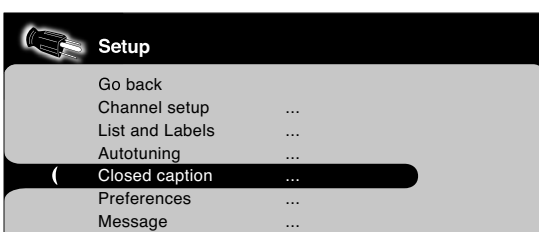

# Using the TV's Menu System

Closed captioning is not available on all channels at all times. Only specific programs encoded with closed-captioning information. When a program is closed captioned, *CC* is displayed in the channel banner. See Chapter 3 for more information about the channel banner. The closed caption options are:

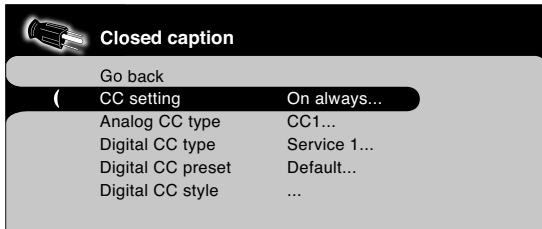

**CC setting** Lets you choose the way closed captioning information appears on the screen.

**Off** No captioning information displayed.

**On always** Captioning information shown always, when available.

**On when muted** Displays captioning information, when available, whenever the TV's sound is muted by pressing the MUTE button. The captioning information is not displayed when the sound is not muted.

**Analog CC type** If available, lets you select the captioning mode used for displaying captioning information. If you are unsure of the differences among the modes, you may prefer to leave the closed captioned mode set to CC1, which displays complete text of the program in the primary language in your area.

**Digital CC type** If available, lets you select a closed caption service mode (1-6) for digital channels.

**Digital CC preset** If available, lets you select between *Default* and *Custom* options. Custom changes according to what you set for the options below.

**Digital CC style** If available, lets you customize the following display options:

**Digital CC size** Lets you set the size of the digital closed-caption text. You can choose *Standard*, *Large*, or *Small*.

**Digital CC font** Lets you select a character design for the digital closed-caption text. A font is a complete assortment of letters, numbers, punctuation marks, etc. in a given design. You can choose from a variety of fonts (Ashley, Floridian, etc.).

**Digital CC opacity** Lets you set the appearance of the digital closed-caption text: *Solid*, *Transparent*, *Translucent*, or *Flashing*.

**Digital CC color** Lets you choose the color of the digital closed-caption text: *White*, *Black*, *Red*, *Green*, *Blue*, *Yellow*, *Magenta*, or *Cyan*.

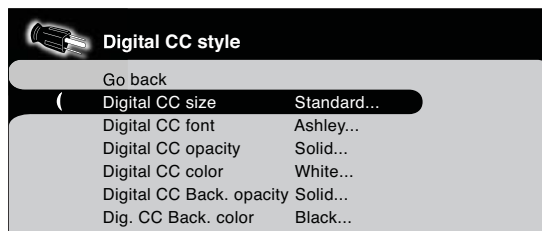

"Monotype" is a trademark of Monotype Imaging, Inc. registered in the U.S. Patent and Trademark Office and may be registered in certain other jurisdictions.

"iType" is a trademark of Monotype Imaging, Inc. and may be registered in certain other jurisdictions.

"Floridian", "Plate Gothic", and "Screen" are trademarks of The Monotype Corporation and may be registered in certain other jurisdictions.

"Ashley" is a trademark of The Monotype Corporation Registered in the U.S. Patent and Trademark Office and may be registered in certain other jurisdictions.

# Using the TV's Menu System

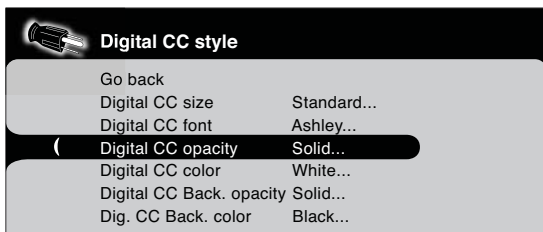

**Digital CC back. opacity** Lets you set the appearance of the space behind the digital closed-caption text: *Solid*, *Transparent*, *Translucent*, or *Flashing*.

**Dig. CC back. color** Lets you choose the color of the area of the screen behind the digital closed-caption text: *White*, *Black*, *Red*, *Green*, *Blue*, *Yellow*, *Magenta*, or *Cyan*.

**Note:** These captioning style options only have an effect on true digital closed captions.

Not all captioning on digital channels is digital captioning—it depends on what the broadcaster is sending. If the closed captioning for a program is not digital, the Digital CC style settings will not have an effect.

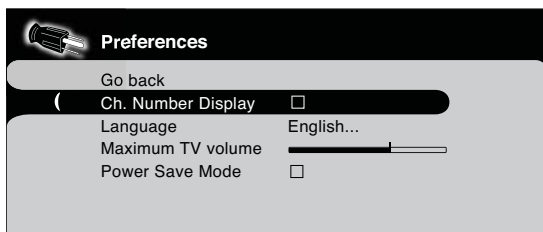

## Preferences

**Ch. Number Display** Turn this feature on if you want the channel number displayed on-screen.

**Language** Lets you select your preferred language for the menus: *English*, *Español* or *Français*.

**Maximum TV volume** This feature is intended to stop volume from being turned up too loudly. Set the volume at the loudest level you'd want to hear. Press and hold OK to hear the maximum volume you set.

**Power Save Mode** If no signal is detected from the VGA input jack for 5 minutes, puts the TV in power save mode.

**Message** Set a message that appears at the bottom of the TV screen. Press the CLEAR button to clear the message. If *Display* is turned on, the message appears when the TV is turned back on after being turned off.

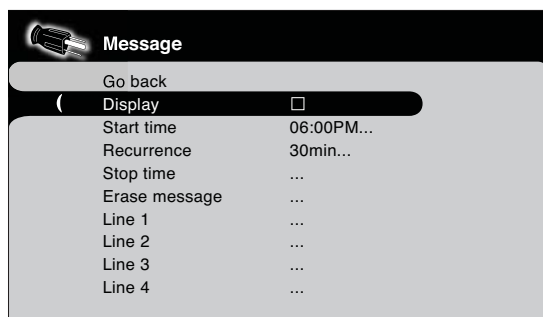

**Display** Turns on or off to display a message on the TV.

**Start time** Set the time you want to display the message. Not available if the time hasn't been set in the *Time* menu.

**Recurrence** Set how often to display the message- 10min- 60 min.

**Stop time** Set the time you want the message to stop.

**Erase message** Clears all lines of text you've entered.

**Line 1-Line 4** Enter up to 4 lines of text- 25 characters per line. Press the right arrow button to start entering text on a line, then press the up and down arrow buttons to change characters. Press OK when you're done entering text for a line.

## Parental Control Menu

The Parental control menu was explained in Chapter 3. Go to page 29 for more information.



# Using the TV's Menu System

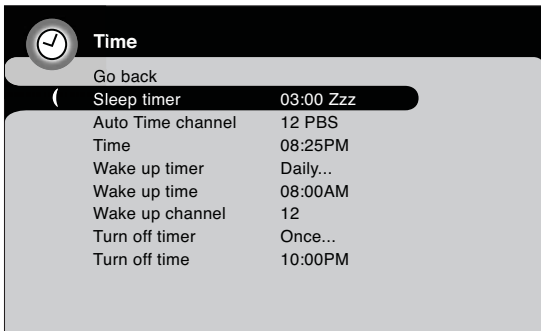

## Time Menu

**Sleep timer** Lets you set the TV to turn off after a given amount of time.

**Auto Time channel** Choose your PBS station to have the TV set the time for you. Wait about one minute for the time to be set.

**Time** If you didn't set the time reference channel, enter the current time manually. If it is eight o'clock, for example, you must first enter the number zero, then number eight. Use the OK button to choose between AM and PM.

**Wake up timer** Lets you set the TV to turn itself on.

*Note: The Wake up timer is available only when the time has been set.*

**Wake up time** Lets you set the time you want the TV to turn itself on.

**Wake up channel** Lets you select a specific channel the TV tunes to when the wake up timer is set.

**Turn off timer** Lets you set the TV to turn itself off.

**Turn off time** Lets you set the time you want the TV to turn itself off.

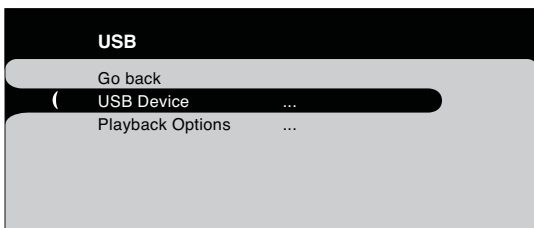

## USB Menu

This menu lets you customize options for the USB device connected to your TV.

### USB Device

**Pictures** If you have pictures on your USB device connected to your TV, this menu allows you to view the pictures individually by pressing the up/down arrow buttons to highlight the picture (the picture is displayed on the right). For slideshow options, go to the *Playback Options* menu.

*Note: To play a slideshow of all the pictures available on your device, highlight a folder and press PLAY.*

**Music** If you have .mp3 audio files on your USB device connected to your TV, this menu allows you to play files individually by pressing the up/down arrow buttons to highlight the song. For slideshow options, go to the *Playback Options* menu.

*Note: To play a slideshow of all the music files available on your device, highlight a folder and press PLAY.*

**Playback Options** Choose playback options for pictures and audio files.

**Slideshow Speed** Adjust how many seconds is between each slide played: 2s, 4s, 8s.

**Transition Effect** Turn this feature on to have pictures slowly fade as the next picture is displayed.

**Music Playback** Select a way to play your audio files: *Play*- plays from the audio file highlighted to the end of the current folder; *Repeat*- repeats current folder or file selected; *Random*- randomly plays all audio files in the current folder.

*Note: Folder names containing special characters might not be recognized by the television.*





*This page left intentionally blank.*



### Frequently Asked Questions (FAQs)

#### **What's the quickest way to view High Definition (HD) video?**

Connect an off-air antenna to the ANT/CABLE Input to view free local digital channels. You might need to purchase an antenna. Go to page 6 for more information.

Visit [www.antennaweb.org](http://www.antennaweb.org) to get help deciding what type of antenna to use to receive the local digital channels available to you. By entering where you live, this mapping program tells you what local analog and digital stations are available using a certain antenna.

#### **Are there other ways to view High Definition (HD) video?**

Besides using an off-air antenna as mentioned above, you can also use a set-top box to receive digital video. Contact your cable company or satellite provider to purchase digital programming and have them connect the box for you to ensure you're viewing channels the best way.

#### **How do I tell an analog channel from a digital channel?**

Press the INFO button to display the channel banner. Look at the bottom left corner of the screen. An *A* is displayed for an analog channel. A *D* is displayed for a digital channel.

#### **Why are there bars on my screen and can I get rid of them?**

Most digital video is sent in a 16/9 format which does fill your screen, but sometimes is sent in 4/3 which does not fill your screen. It depends on how the station or device connected to your TV is formatting the video. If there are bars on-screen, press the ZOOM +/- button to try a different format that may eliminate the bars. The format changes as you press the ZOOM buttons and the format type is displayed at the bottom of the screen. For more information on screen formats, go to page 33.

#### **Why does channel search find a lot of channels, but when I try to tune to them there's nothing there?**

Some channels are enabled by the cable company that don't carry programming, such as video-on-demand. When channels are unavailable, your TV's screen is blank or appears like snow. You probably want to get rid of these so they no longer appear in your channel list. Remove these in the *Channel List* menu. Go to page 40 for more information.

#### **Why does the first channel search take a long time?**

If you have both analog and digital channels, the TV is looking for all available channels in the channel list. If you do have digital channels, the TV is also searching for each sub-channel of that digital channel.



# Other Information

---

## Troubleshooting

Most problems you encounter with your TV can be corrected by consulting the following troubleshooting list.

### ***TV Problems***

---

#### **TV won't turn on**

- Make sure the TV is plugged in.
- Check the wall receptacle (or extension cord) to make sure it is “live” by plugging in something else.
- The front panel controls may be locked (disabled). Use the remote control to unlock the front panel controls by selecting the *Front Panel Block* in the *Parental control* menu and press OK to uncheck the box.

#### **No picture, no sound but TV is on**

- You might be tuned to an input with no device connected to it to view. If you're trying to view a connected device, press INPUT until the picture from that device appears.
- Maybe the *Signal type* option is set incorrectly. Go to page 15 for detailed instructions.
- The channel might be blank — change channels.
- If you're watching your VCR and it's connected with coaxial cable to the ANT/CABLE jack, tune the TV to channel 3 or 4 (whichever channel is selected on the 3/4 switch on the back of your VCR). Also check to make sure the TV/VCR button on the VCR is in the correct mode (press the TV/VCR button on your VCR).

#### **Sound okay, picture poor**

- If you're getting a black and white picture from a device you've connected to your TV, you might have your video cables connected to the wrong jacks. A yellow Video cable connects to the yellow VIDEO input jack on the side or back of your TV; three video cables or bundled component video cables (red, blue, and green) connect to the corresponding COMPONENT INPUT jacks on the back of your TV.
- If you're getting no picture from a device you've connected to your TV, you might have your video cable connected to the VIDEO OUT jacks on the back of your TV. These jacks are used to connect recording devices. A yellow Video cable connects to the yellow VIDEO input jack on the side or back of your TV.
- Check antenna connections. Make sure all of the cables are firmly connected to the jacks.
- Try adjusting sharpness function to improve weak signals. Go to page 38 for more instructions.

#### **No sound, picture okay**

- Maybe the sound is muted. Try pressing the volume up button to restore sound.
- If using DVI, S-Video, or Y, PB, PR, remember to also connect the device's left and right audio output jacks to the TV's L and R Audio Input jacks.
- The sound settings may not be set correctly. Go to page 36 for more information.
- The internal speakers might be turned off. Go to page 37 for more information.

#### **Blank screen**

- Check your connections. If you used yellow, red, and white cables to connect, make sure they're connected to the yellow, red, and white video INPUT jacks on the side or back of the TV, not to the VIDEO OUT jacks on the back of the TV.
- If you're trying to watch something that's playing on a device connected to the TV (like a DVD), press INPUT until you get to the correct video input channel.
- Make sure the device connected to the TV is turned on.
- Try another channel.

### Buttons don't work

- The front panel controls may be locked (disabled). Use the remote control to unlock the front panel controls by selecting the *Front Panel Block* in the *Parental control* menu and press OK to uncheck the box.
- Unplug the TV for ten minutes and then plug it back in. Turn the TV on and try again.

### TV turns off unexpectedly

- Sleep timer may have been activated. Go to page 43 for instructions.
- Electronic protection circuit may have been activated because of a power surge. Wait 30 seconds and then turn on again. If this happens frequently, the voltage in your house may be abnormally high or low.
- Unplug. Wait ten minutes. Plug in again.

### TV turns on unexpectedly

- Wake up timer might have been activated. Go to page 43 for instructions.

### Can't select certain channel

- Channel may be blocked or not approved in the *Parental Controls* menu.
- If using a VCR, check to make sure the TV/VCR button on the VCR is in the correct mode (press the TV/VCR button on your VCR).
- Press the TV button and then try to change channels.

### Noisy stereo reception

- May be a weak station. Use *Sound* menu to choose mono sound.

### Black box appears on the screen

- Closed-captioning might be on. Check *Closed Caption* in the *Setup* menu. Go to page 40 for more instructions.

## ***Problems with HDMI Connection***

---

- Make sure the HDMI or DVI device is turned on and the cables are firmly connected. If problems still occur, turn off your device. Re-connect your device. Reset the power by unplugging the power cord and plugging it back in.
- If you are tuned to the HDMI/DVI input and you're receiving *Unusable Signal* message on-screen, press the INFO button on the remote. If *Acquiring Channel* appears in the channel banner, the HDMI or DVI device isn't responding. Contact the manufacturer of the HDMI or DVI device for further assistance.
- If you tune to the HDMI/DVI input and you see snow, the video goes in and out, or the video takes a long time to appear, your HDMI or DVI device is having trouble sending video information to the TV. Re-connect your device. Reset the power by unplugging the power cord and plugging it back in. If problems persist, try connecting the Y Pb Pr jacks instead if they are available or contact the manufacturer of the HDMI or DVI device for further assistance.
- If you have black bars on each side of your picture, the device you connected might have a switch or a menu option allowing you to change the picture quality output that will fix this. Choose either 720p or 1080i.
- 480i signals aren't supported by the HDMI1/DVI or HDMI2 input.

## ***The Remote Control Doesn't Work***

---

- Something might be between the remote and the remote light sensor on the front of the TV. Make sure there is a clear path.
- Maybe the remote isn't aimed directly at the TV.
- Maybe batteries in remote are weak, dead, or installed incorrectly. Put new batteries in the remote. (Note, if you remove the batteries, you may have to reprogram the remote to operate other devices.)



# Other Information

---

## ***Problems with V-Chip/Parental Controls***

---

### **The rating limits don't work**

- You must lock the settings. Go to the *Main Menu* (press MENU on your remote), select *Parental control*, select *Lock Parental Controls*.

### **I don't remember my password and I want to unlock the TV**

- If you forget your password, turn the TV off. Simultaneously press and hold VOL- on the front panel and CLEAR on the remote for 10 seconds. Next time you enter the *Parental control* menu enter a new password

### **The V-Chip won't let me watch a program even though it's not rated as violent.**

- Maybe the movie was given an NR (Not Rated) status. After you block movie ratings, you must set *NR* to *View* separately in order to view movies with an NR rating.

## ***What Else Can I Do?***

---

If you've been through the Troubleshooting section and nothing has fixed your problem, try rebooting your TV. Note that after a reboot you may need to run your TV through the setup process again. To do a reboot, unplug the power cord from the wall outlet, power strip, etc. Keep your TV unplugged for about 5 minutes. Then plug the TV back in, turn on the TV, and see if the problem is fixed. If the problem remains, then please visit [www.rca.com/television](http://www.rca.com/television) for updated FAQs or contact RCA Customer Support at the support number provided in your Warranty under *How To Get Service*.

## Mounting Your TV to the Wall

**Caution:** The wall mount must bear a minimum of five times the TV's net weight without causing damage.

To mount your TV to the wall you need to purchase a VESA wall mount. For model L26WD14, purchase a VESA MIS-F, 400, 200, 4 (400, 200 means the mounting measurements are 400mm horizontally and 200mm vertically; 4 means M4 type screws need to be used). For models L32WD14 and L37WD14, purchase a VESA MIS-F, 400, 200, 6 (400, 200 means the mounting measurements are 400mm horizontally and 200mm vertically; 6 means M6 type screws need to be used).

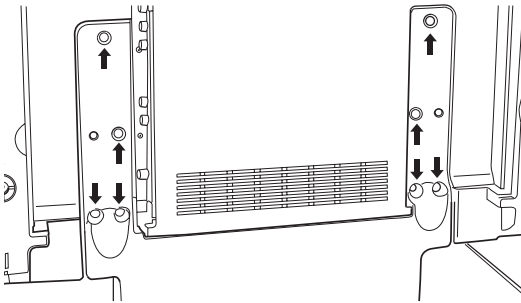

Remove the screws from the four holes on each side of the TV's base.

1. You need to remove the base first before attaching the wall mount.
  - A. Place the TV facedown on a surface that is soft, yet strong enough to hold the TV.
  - B. Use a screwdriver to remove the screws from the four holes on each side of the TV's base as the arrows indicate on the base.
2. Make sure all cables are already connected to the TV.
3. Follow the directions included with the wall mount to mount the TV to the wall.

# Other Information

---

## V-Chip Rating Explanations

### US V-Chip Rating System

**TV-MA (Mature Audience Only)** Specifically designed to be viewed by adults and may be unsuitable for children under 17. It contains one or more of the following content themes: crude indecent language (L), explicit sexual activity (S), or graphic violence (V).

**TV-14 (Parents Strongly Cautioned)** Contains some material that many parents would find unsuitable for children under 14. Parents are strongly urged to exercise greater care in monitoring this program and are cautioned against letting children under the age of 14 watch unattended. This program contains one or more of the following content themes: intensely suggestive dialogue (D), strong coarse language (L), intense sexual situations (S), or intense violence (V).

**TV-PG (Parental Guidance Suggested)** Contains material that parents may find unsuitable for younger children. Many parents may want to watch it with their younger children. The program contains one or more of the following content themes: some suggestive dialogue (D), infrequent coarse language (L), some sexual situations (S), or moderate violence (V).

**TV-G (General Audience)** Most parents would find this program suitable for all ages. It contains little or no sexual dialogue (D) or situations (S), no strong language (L), and little or no violence (V).

**TV-Y7 (Directed to Children 7 years and older)** Designed for children ages 7 and above. It may be more appropriate for children who have acquired the developmental skills needed to distinguish between make-believe and reality. Themes and elements in this program may include mild fantasy violence (FV) or comedic violence, or may frighten children under the age of 7.

**TV-Y (All Children)** Themes and elements in this program are designed for a young audience, including children from ages 2-6. It is not expected to frighten younger children.

### Canadian English V-Chip Rating System

**18+ (Adults)** Programming intended for adults 18 and older. It may contain elements of violence, language, and sexual content which could make it unsuitable for viewers under 18. Violence Guidelines: May contain violence integral to the development of the plot, character or theme, intended for adult audiences. Other Content Guidelines: May contain graphic language and explicit portrayals of nudity and/or sex.

**14+ (Viewers 14 and over)** Programming contains themes or content which may not be suitable for viewers under the age of 14. Parents are strongly cautioned to exercise discretion in permitting viewing by pre-teens and early teens. Violence Guidelines: May contain intense scenes of violence. Could deal with mature themes and societal issues in a realistic fashion. Other Content Guidelines: May contain scenes of nudity and/or sexual activity. There could be frequent use of profanity.

**PG (Parental Guidance)** Programming intended for a general audience but which may not be suitable for younger children (under the age of 8). Parents may consider some content inappropriate for unsupervised viewing by children aged 8-13. Violence Guidelines: Depictions of conflict and/or aggression will be limited and moderate; may include physical, fantasy, or supernatural violence. Other Content Guidelines: May contain infrequent mild profanity, or mildly suggestive language. Could also contain brief scenes of nudity.

**G (General Audience)** Programming considered acceptable for all ages groups. While not designed specifically for children, it is understood younger viewers may be part of the audience. Violence Guidelines: Will contain very little violence, either physical or verbal or emotional. Will be sensitive to themes which could frighten a younger child, will not depict realistic scenes of violence which minimize or gloss over the effects of violent acts. Other Content Guidelines: There may be some inoffensive slang, no profanity and no nudity.



**C8+ (Children 8 and Older)** Programming generally considered acceptable for children 8 years and over to watch on their own. Violence Guidelines: Violence will not be portrayed as the preferred, acceptable, or only way to resolve conflict or encourage children to imitate dangerous acts which they may see on television. Any realistic depictions of violence will be infrequent, discreet, of low intensity and will show the consequences of the acts. Other Content Guidelines: There will be no profanity, nudity or sexual content.

**C (Children)** Programming intended for children under age 8. Violence Guidelines: Careful attention is paid to themes which could threaten children's sense of security and well being. There will be no realistic scenes of violence. Depictions of aggressive behaviour will be infrequent and limited to portrayals that are clearly imaginary, comedic or unrealistic in nature. Other Content Guidelines: There will be no offensive language, nudity or sexual content.

### Canadian French V-Chip Rating System

**18+ (Adults)** Programming is for adults only. This program contains sustained violence or extremely violent scenes.

**16+ (Viewers 16 and over)** Programming is not suitable for those under age 16. This program contains frequent scenes of violence or intensely violent scenes.

**13+ (Viewers 13 and over)** Programming may not be suitable for children under the age of 13. This program either contains several violent scenes or one or more scenes that are violent enough to affect them. Viewing in the company of an adult is therefore strongly recommended for children under the age of 13.

**8+ (Viewers 8 and over)** Not recommended for young children. This program is suitable for most audiences, but it contains mild or occasional violence that could upset young children. Viewing in the company of an adult is therefore recommended for young children (under the age of 8) who do not distinguish between reality and imagination.

**G (General Audience)** This program is suitable for audiences of all ages. It contains no violence, or any violence that it does contain is either minimal or is presented in a humorous manner, as a caricature, or in an unrealistic way.

# Other Information

---

## Limited Warranty

### What your warranty covers:

- Defects in materials or workmanship.

### For how long after your purchase:

- 1 year from date of purchase for parts and labor.

### What we will do within one year:

- At our option, either (a) pay any Authorized RCA Television Service Center the labor charges, plus replacements parts, to repair your television, or (b) replace your television.
- At our option, the replacement parts or replacement television provided under the warranty may be new or refurbished.

### What your warranty *does not* cover:

- Acts of nature, such as but not limited to lightning damage.
- Adjustment of customer controls.
- Damage from misuse or neglect.
- A unit that has been modified or incorporated into other products or is used for institutional or other commercial purposes.
- Batteries.
- Units purchased or serviced outside the U.S.A.
- Shipping damage if the unit was not packed and shipped in the manner prescribed by TTE Technology, Inc..
- Customer Instruction. (Your Owner's Manual describes how to install, adjust, and operate your unit. Any additional information should be obtained from your dealer.)

### How you get service:

- Take your RCA television to any Authorized RCA Television Service Center and pick up when repairs are complete.
- To identify your nearest Authorized RCA Television Service Center, ask your dealer, visit [www.rca.com/television](http://www.rca.com/television), look in the Yellow Pages, or call 1-800-951-9582.
- Proof of purchase in the form of a bill of sale or receipted invoice which is evidence that the product is within the warranty period must be presented to obtain warranty service. For rental firms, proof of first rental is also required.

### Product Registration:

- Please complete and mail the Product Registration Card packed with your TV or register on-line at [www.rca.com/television](http://www.rca.com/television). It will make it easier to contact you should it ever be necessary. The return of the card is not required for warranty coverage.

### Limitation of Warranty:

- **THE WARRANTY STATED ABOVE IS THE ONLY WARRANTY APPLICABLE TO THIS PRODUCT. ALL OTHER WARRANTIES, EXPRESS OR IMPLIED (INCLUDING ALL IMPLIED WARRANTIES OF MERCHANTABILITY OR FITNESS FOR A PARTICULAR PURPOSE) ARE HEREBY DISCLAIMED. NO VERBAL OR WRITTEN INFORMATION GIVEN BY TTE TECHNOLOGY, INC., ITS AGENTS OR EMPLOYEES SHALL CREATE A WARRANTY OR IN ANY WAY INCREASE THE SCOPE OF THIS WARRANTY.**
- **REPAIR OR REPLACEMENT AS PROVIDED UNDER THIS WARRANTY IS THE EXCLUSIVE REMEDY OF THE CONSUMER. TTE TECHNOLOGY, INC. SHALL NOT BE LIABLE FOR INCIDENTAL OR CONSEQUENTIAL DAMAGES RESULTING FROM THE USE OF THIS PRODUCT OR ARISING OUT OF ANY BREACH OF ANY EXPRESS OR IMPLIED WARRANTY ON THIS PRODUCT. THIS DISCLAIMER OF WARRANTIES AND LIMITED WARRANTY ARE GOVERNED BY THE LAWS OF THE STATE OF INDIANA. EXCEPT TO THE EXTENT PROHIBITED BY APPLICABLE LAW, ANY IMPLIED WARRANTY OF MERCHANTABILITY OR FITNESS FOR A PARTICULAR PURPOSE ON THIS PRODUCT IS LIMITED TO THE APPLICABLE WARRANTY PERIOD SET FORTH ABOVE.**

### How state law relates to warranty:

- Some states do not allow the exclusion nor limitation of incidental or consequential damages, or limitations on how long an implied warranty lasts, so the above limitations or exclusions may not apply to you.
- This warranty gives you specific legal rights, and you also may have other rights that vary from state to state.

### If you purchased your product outside the United States:

- This warranty does not apply. See your dealer for warranty information.

**Service calls which do not involve defective materials or workmanship are not covered by this warranty. Costs of such service calls are the sole responsibility of the purchaser.**

## Care and Cleaning

CAUTION: Turn OFF your TV before cleaning.

You can clean the TV as required, using a soft lint-free cloth. Be sure to occasionally dust the ventilation slots in the cabinet to help assure adequate ventilation.

**IMPORTANT: Never use strong cleaning agents, such as ammonia-based cleaners, or abrasive powder. These types of cleaners will damage the TV.**

**The TV's screen may be cleaned with a soft, lint-free cloth as well. Take care not to scratch or mar the screen. If necessary, you may use a cloth dampened with warm water.** While cleaning do not spray liquid directly on the screen, or allow liquid to run down the screen and inside the TV. Also, never place drinks or vases with water on top of the TV. This could increase the risk of fire or shock hazard or damage to the TV.



*This page left intentionally blank.*





*This page left intentionally blank.*



## FCC Information

This equipment has been tested and found to comply with the limits for a Class B digital device, pursuant to Part 15 of the FCC Rules. These limits are designed to provide reasonable protection against harmful interference in a residential installation. This equipment generates, uses, and can radiate radio frequency energy and, if not installed and used in accordance with the instructions, may cause harmful interference to radio communications. However, there is no guarantee that interference will not occur in a particular installation. If this equipment does cause harmful interference to radio or television reception, which can be determined by turning the equipment off and on, the user is encouraged to try to correct the interference by one or more of the following measures:

- Reorient or relocate the receiving antenna.
- Increase the separation between the equipment and receiver.
- Connect the equipment into an outlet on a circuit different from that to which the receiver is connected.
- Consult the dealer or an experienced radio/TV technician for help.

This Class B digital apparatus complies with Canadian ICES-003.

---

**Visit the RCA website at [www.rca.com/television](http://www.rca.com/television)**

---

Please do not send any products to the Indianapolis address listed in this manual or on the carton. This will only add delays in service for your product.

**TTE**

**TTE Technology, Inc.**  
**101 West 103rd Street**  
**Indianapolis, IN 46290**

©2006 TTE Technology Inc.  
RCA and associated marks are trademarks of THOMSON S.A.  
used under license to TTE Corporation.

Printed in China  
**TOCOM 1668591B**