



**Dear VIZIO Customer,**

Congratulations on your new VIZIO SV320XVT & SV370XVT television purchase. Thank you for your support. For maximum benefit of your set, please read these instructions before making any adjustments, and retain them for future reference. We hope you will experience many years of enjoyment from your new VIZIO HDTV High Definition Television.

**For assistance**, please call **(877) 668-8462** or e-mail us at [www.vizio.com](http://www.vizio.com).

To purchase or inquire about accessories and installation services for your VIZIO HDTV, please visit our website at [www.vizio.com](http://www.vizio.com) or call toll free at **(888) 849-4623**.

We recommend you register your VIZIO HDTV either at our website [www.VIZIO.com](http://www.VIZIO.com) or fill out and mail your registration card. For peace of mind and to protect your investment beyond the standard warranty, VIZIO offers on-site extended warranty service plans. These plans give additional coverage during the standard warranty period. Visit our website or call us to purchase a plan.

Write down the serial number located on the back of your HDTV.

-----

Purchase Date \_\_\_\_\_

*VIZIO is a registered trademark of VIZIO, Inc. dba V, Inc.  
HDMI logo and "High Definition Multimedia Interface" are registered trademarks of HDMI Licensing LLC.  
Manufactured under license from Dolby Laboratories.  
Dolby and the double-D symbol are trademarks of Dolby Laboratories.*



*TruSurround HD and TruVolume are trademarks of SRS Labs, Inc.  
TruSurround HD and TruVolume technologies are incorporated under license from SRS Labs, Inc.*

*THE TRADEMARKS SHOWN HEREIN ARE THE PROPERTY OF THEIR RESPECTIVE OWNERS; IMAGES USED ARE FOR ILLUSTRATION PURPOSES ONLY. BRAVO, VIZIO AND THE V LOGO AND WHERE VISION MEETS VALUE AND OTHER VIZIO TRADEMARKS ARE THE INTELLECTUAL PROPERTY OF VIZIO INC. PRODUCT SPECIFICATIONS ARE SUBJECT TO CHANGE WITHOUT NOTICE OR OBLIGATION. © 2008 VIZIO INC. ALL RIGHTS RESERVED.*



## Important Safety Instructions

Your HDTV is designed and manufactured to operate within defined design limits, and misuse may result in electric shock or fire. To prevent your HDTV from being damaged, the following rules should be observed for the installation, use, and maintenance of your HDTV. Read the following safety instructions before operating your HDTV. Keep these instructions in a safe place for future reference.

- To reduce the risk of electric shock or component damage, switch off the power before connecting other components to your HDTV.
- Unplug the power cord before cleaning your HDTV. A damp cloth is sufficient for cleaning your HDTV. Do not use a liquid or a spray cleaner for cleaning your HDTV. Do not use abrasive cleaners.
- Always use the accessories recommended by the manufacturer to insure compatibility.
- When moving your HDTV from an area of low temperature to an area of high temperature, condensation may form in the housing. Wait before turning on your HDTV to avoid causing fire, electric shock, or component damage.
- Use only with the cart, stand, tripod, bracket, or table specified by manufacturer or sold with your HDTV. When a cart is used, use caution when moving the cart/HDTV combination to avoid injury from tip-over. Do not place your HDTV on an unstable cart, stand, or table. If your HDTV falls, it can injure a person and cause serious damage to your HDTV. Use only a cart or stand recommended by the manufacturer or sold with your HDTV.
- A distance of at least 3 feet should be maintained between your HDTV and any heat source, such as a radiator, heater, oven, amplifier etc. Do not install your HDTV close to smoke. Operating your HDTV close to smoke or moisture may cause fire or electric shock.
- Slots and openings in the back and bottom of the cabinet are provided for ventilation. To ensure reliable operation of your HDTV and to protect it from overheating, be sure these openings are not blocked or covered. Do not place your HDTV in a bookcase or cabinet unless proper ventilation is provided.
- Never push any object into the slots and openings on your HDTV cabinet. Do not place any objects on the top of your HDTV. Doing so could short circuit parts causing a fire or electric shock. Never spill liquids on your HDTV.
- Your HDTV should be operated only from the type of power source indicated on the label. If you are not sure of the type of power supplied to your home, consult your dealer or local power company.
- Do not apply pressure or throw objects at your HDTV. This may compromise the integrity of the display. The manufacturer's warranty does not cover user abuse or improper installations.
- The power cord must be replaced when using different voltage than the voltage specified. For more information, contact your dealer.
- Your HDTV is equipped with a **three-pronged grounded plug (a plug with a third grounding pin)**. This plug will fit only into a grounded power outlet. This is a safety feature. If your outlet does not accommodate the three-pronged, have an electrician install the correct outlet, or use an adapter to ground your HDTV safely. **Do not defeat the safety purpose of the grounded plug.**
- When connected to a power outlet, power is always flowing into your HDTV. To totally disconnect power, unplug the power cord.



- The lightning flash with arrowhead symbol within an equilateral triangle is intended to alert the user to the presence of un-isolated, dangerous voltage within the inside of your HDTV that may be of sufficient magnitude to constitute a risk of electric shock to persons.



- The exclamation point within an equilateral triangle is intended to alert the user to the presence of important operating and servicing instructions in the literature accompanying your HDTV.
- Do not overload power strips and extension cords. Overloading can result in fire or electric shock.



- The wall socket should be installed near your HDTV and easily accessible.
- Only power of the marked voltage can be used for your HDTV. Any other voltage than the specified voltage may cause fire or electric shock
- Do not touch the power cord during lightning. To avoid electric shock, avoid handling the power cord during electrical storms.
- Unplug your HDTV during a lightning storm or when it will not be used for long period of time. This will protect your HDTV from damage due to power surges.
- Do not attempt to repair or service your HDTV yourself. Opening or removing the back cover may expose you to high voltages, electric shock, and other hazards. If repair is required, contact your dealer and refer all servicing to qualified service personnel.
- Keep your HDTV away from moisture. Do not expose your HDTV to rain or moisture. If water penetrates into your HDTV, unplug the power cord and contact your dealer. Continuous use in this case may result in fire or electric shock.
- Do not use your HDTV if any abnormality occurs. If any smoke or odor becomes apparent, unplug the power cord and contact your dealer immediately. Do not try to repair your HDTV yourself.
- Avoid using dropped or damaged appliances. If your HDTV is dropped and the housing is damaged, the internal components may function abnormally. Unplug the power cord immediately and contact your dealer for repair. Continued use of your HDTV may cause fire or electric shock.
- Do not install your HDTV in an area with heavy dust or high humidity. Operating your HDTV in environments with heavy dust or high humidity may cause fire or electric shock.
- Follow instructions for moving your HDTV. Ensure that the power cord and any other cables are unplugged before moving your HDTV.
- When unplugging your HDTV, hold the power plug, not the cord. Pulling on the power cord may damage the wires inside the cord and cause fire or electric shock. When your HDTV will not be used for an extended period of time, unplug the power cord.
- To reduce risk of electric shock, do not touch the connector with wet hands.
- Insert batteries in accordance with instructions. Incorrect polarities may cause the batteries to leak which can damage the remote control or injure the operator.
- If any of the following occurs, contact the dealer:
  - The power cord fails or frays.
  - Liquid sprays or any object drops into your HDTV.
  - Your HDTV is exposed to rain or other moisture.
  - Your HDTV is dropped or damaged in any way.
  - The performance of your HDTV changes substantially.



## Television Antenna Connection Protection

### External Television Antenna Grounding

If an outside antenna/satellite dish or cable system is to be connected to the TV, make sure that the antenna or cable system is electrically grounded to provide some protection against voltage surges and static charges.

Article 810 of the National Electrical Code, ANSI/NFPA 70, provides information with regard to proper grounding of the mast and supporting structure, grounding of the lead-in wire to an antenna discharge unit, size of the grounding conductors, location of antenna discharge unit, connection to grounding electrodes, and requirements of the grounding electrode.

#### Lightning Protection

For added protection of the TV during a lightning storm or when it is left unattended or unused for long periods of time, unplug the TV from the wall outlet and disconnect the antenna or cable system.

#### Power Lines

Do not locate the antenna near overhead light or power circuits, or where it could fall into such power lines or circuits.

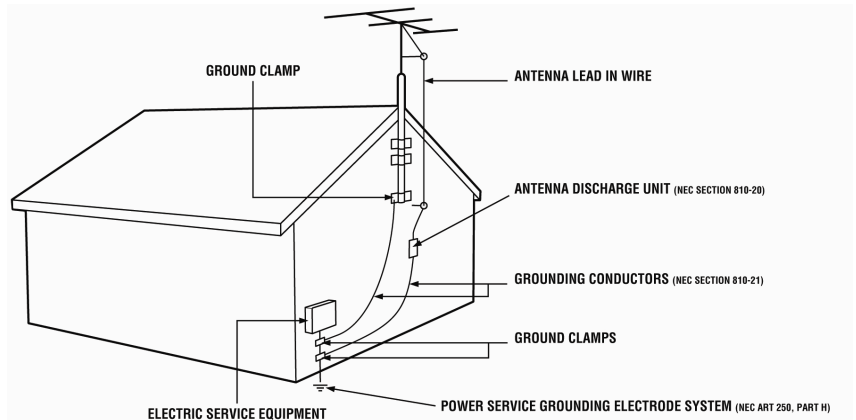

**Remember, the screen of the coaxial cable is intended to be connected to earth in the building installation.**



## Advisory of the DTV Transition

The nationwide switch to digital television broadcasting will be complete on June 12, 2009, but your local television stations may switch sooner. After the switch, analog-only television sets that receive TV programming through an antenna will need a converter box to continue to receive over-the-air TV. Watch your local stations to find out when they will turn off their analog signal and switch to digital-only broadcasting. Analog-only TVs should continue to work as before to receive low power, Class A or translator television stations and with cable and satellite TV services, gaming consoles, VCRs, DVD players, and similar products.

For additional information, please contact the parties listed below, as appropriate:

FCC (US Federal Communications Commission)

<http://www.fcc.gov/>

Phone: 1-888-CALL-FCC (1-888-225-5322)

TTY: 1-888-TELL-FCC (1-888-835-5322)

Fax: 1-866-418-0232

E-mail: [fccinfo@fcc.gov](mailto:fccinfo@fcc.gov)

NTIA (National Telecommunications and Information Administration)

<http://www.ntia.doc.gov/>

1-888-DTV-2009

Listings of US Television Stations

<http://www.high-techproductions.com/usTVstations.htm>

**Note:** Your VIZIO HDTV is capable of receiving Digital Broadcasts, and no Digital Converter Box is required.



## Table of Contents

Important Safety Instructions.....	2
Television Antenna Connection Protection .....	4
Advisory of the DTV Transition.....	5
TV Setup and Stand Assembly .....	10
Setting Up Your HDTV .....	11
Wall Mounting your HDTV.....	11
<b>CHAPTER 1 BASIC CONTROLS AND CONNECTIONS.....</b>	<b>12</b>
Front Panel.....	12
Side Panel Controls.....	12
Rear Panel Connections.....	13
VIZIO Remote Control.....	14
Quick Menu Operation.....	15
Insertion of Batteries in the Remote Control.....	16
Remote Control Range.....	16
VIZIO Remote Control Precautions .....	16
<b>CHAPTER 2 CONNECTING EQUIPMENT.....</b>	<b>17</b>
Which Video Connection Should I Use? .....	17
Connecting Your Cable or Satellite Box.....	18
Using HDMI (Best).....	18
HDMI Connections for Cable or Satellite Boxes with DVI .....	19
Using Component Video (Better).....	19
Using S-Video (Compatible) .....	20
Using Composite Video (Compatible).....	20
Using Coaxial (Antenna) (Compatible).....	20
Connecting Coaxial (RF).....	21
Using Your Antenna or Digital Cable for Standard TV or Digital TV .....	21
Using the Antenna or Cable through Your VCR.....	21
Connecting Your DVD Player.....	22
Using HDMI (Best).....	22
HDMI Connections for DVD Players with DVI .....	22
Using Component Video (Better).....	23
Using S-Video (Compatible) .....	23
Using Composite (AV) Video (Compatible) .....	24
Connecting Your VCR or Video Camera.....	24
Connecting an External Receiver/Amp .....	25
Optical Output of audio received with HD Programs.....	25
Connecting a Computer.....	26
Preset PC Resolutions.....	27
Resolution through RGB Input.....	27
<b>CHAPTER 3 USING THE MEDIA PORT.....</b>	<b>28</b>
Supported File Formats.....	28
Viewing Multimedia Content.....	29
Picture Settings .....	30
Slideshow Mode.....	30
Slideshow with Music.....	30
Music file browser .....	30
Audio Mode.....	30
Repeat.....	30
Sort By .....	30
Duration .....	30
Slideshow Effect .....	31



Thumbnail Size .....	31
Info .....	31
Music Settings .....	31
Sort By .....	31
Play Mode .....	31
Repeat.....	31
Audio Mode .....	31
Info .....	31
Video Settings .....	32
Sort By .....	32
Play Mode .....	32
Repeat.....	32
Picture Mode .....	32
Wide Format .....	32
Audio Mode .....	32
Info .....	32
<b>CHAPTER 4 USING YOUR HDTV THE FIRST TIME.....</b>	<b>33</b>
Setup Wizard .....	33
Select Input Source .....	35
Fine Tuning the picture.....	36
Watching a TV Program .....	37
Adjusting Basic HDTV Settings .....	38
Program Information.....	38
<b>CHAPTER 5 ADVANCED ADJUSTMENT OF HDTV.....</b>	<b>39</b>
Using the On Screen Display (OSD).....	39
Picture Menu .....	40
Picture Mode .....	40
Backlight .....	40
Brightness .....	40
Contrast .....	40
Color.....	40
Tint .....	40
Sharpness.....	40
Advanced Video.....	41
Reset Picture Mode .....	41
Audio Menu .....	42
Audio Mode.....	42
Equalizer .....	42
Balance .....	42
SRS TSHD.....	42
SRS TruVolume .....	42
Digital Audio Out.....	42
Speakers.....	42
Analog Audio Out.....	43
Lip Sync .....	43
Reset Audio Mode .....	43
TV Menu .....	44
Tuner Mode.....	44
Auto Search .....	44
Partial Channel Search.....	44
Skip Channel.....	44
MTS.....	44
Time Zone.....	44
Daylight Saving .....	44



Channel Info.....	44
Setup Menu .....	45
Language.....	45
PIP .....	45
CEC Menu .....	46
Sleep Timer.....	46
Wide.....	46
Input Naming.....	47
CC (Closed Caption).....	47
H/V Position .....	48
Parental.....	48
System Info .....	50
System Reset.....	50
Understanding Viewing Features .....	51
Viewing Modes .....	51
<b>CHAPTER 6 PROGRAMMING THE VIZIO UNIVERSAL REMOTE CONTROL.....</b>	<b>52</b>
Programming for VCR.....	52
Programming for Cable Set-Top Box.....	52
Programming for DVD Player .....	53
Searching for Component Codes .....	53
Using a Cable or Satellite Remote .....	53
<b>CHAPTER 7 MAINTENANCE AND TROUBLESHOOTING .....</b>	<b>54</b>
Maintenance .....	54
Troubleshooting Guide .....	55
Telephone & Technical Support .....	57
Compliance.....	58
FCC Class B Radio Interference Statement .....	58
<b>CHAPTER 8 SPECIFICATIONS .....</b>	<b>59</b>
Remote Control Codes .....	61
<b>LIMITED PRODUCT WARRANTY .....</b>	<b>71</b>
<b>VIZIO RETURN POLICY.....</b>	<b>72</b>
Index.....	74





## Opening the Package

Your HDTV and its accompanying accessories are carefully packed in a cardboard carton that has been designed to protect it from transportation damage. Once you have opened the carton, check that your HDTV is in good condition and that all of the contents are included.

The screen can easily be scratched or broken, so handle your HDTV gently and never place your HDTV with the screen facing downwards on a surface without protective padding.

**IMPORTANT:** Save the carton and packing material for future shipping.

## Package Contents

- VIZIO SV320XVT or SV370XVT
- Stand with thumb screw (attached)
- VIZIO remote control VUR9M
- AAA batteries for remote control (2)
- Power cord
- Cleaning Cloth
- This user manual
- Quick Setup Guide
- Registration Card



## Additional certified accessories for your HDTV are sold separately:

- Wall mounts
- High Definition cables
- Extra or replacement remote control

VIZIO also offers installation services and extended warranty services for your HDTV.

To purchase or inquire about additional accessories and services for your VIZIO HDTV, visit our web site at [www.VIZIO.com](http://www.VIZIO.com) or call us toll free at 888-VIZIOCE (888-849-4623)

**Caution:** Do not apply pressure or throw objects at your HDTV. This may compromise the integrity of the display. The manufacturer's warranty does not cover user abuse or improper installations.



## TV Setup and Stand Assembly

### To unpack the TV and stand base:

1. Remove the remote control, batteries, and power cord from the foam end caps.
2. Remove the top foam end caps.
3. Remove the stand base and the thumb screw.
4. Remove the TV from the box and lay it face down on a clean, flat surface.

**Note:** Make sure that the surface is free of debris to prevent the TV screen from getting scratched.

### To attach the TV stand base:

1. Push the stand base onto the stand neck (already connected to TV).
2. On the bottom of the base, insert the thumb screw and tighten. Move the TV into an upright position.

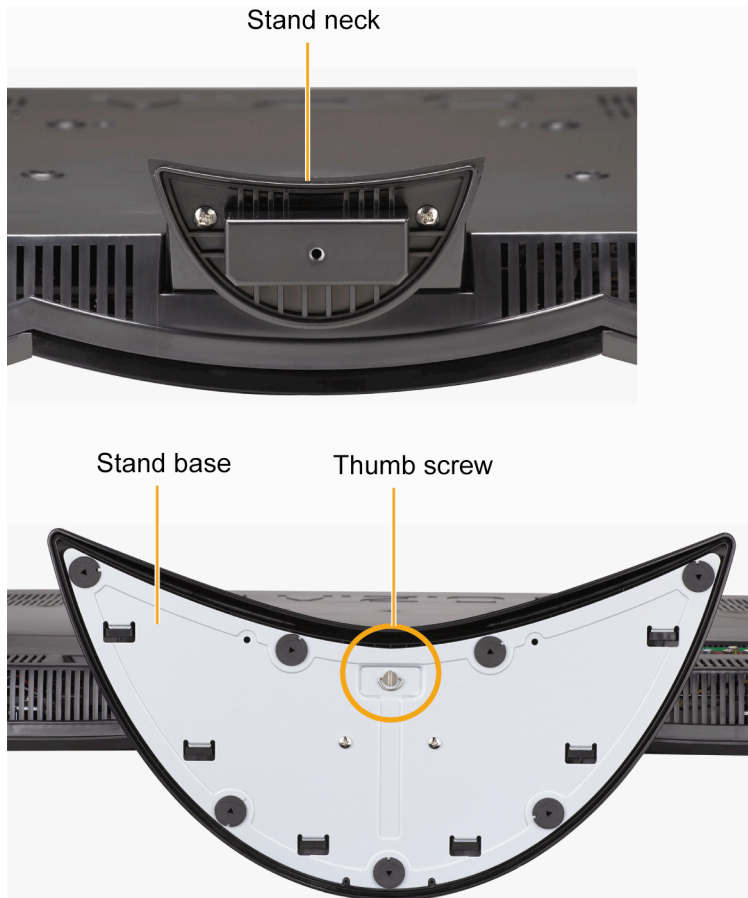

## Setting Up Your HDTV

- Read this user manual carefully before installing your HDTV.
- The power consumption of your HDTV is about 98W (AVG) for the SV320XVT; 125W (AVG) for the SV370XVT. Use the included power cord. When an extension cord is required, use one with the correct power rating. The cord must be grounded and the grounding feature must not be compromised.
- Your HDTV should be installed on a flat surface to avoid tipping.
- For proper ventilation, you must allow space between the back of your HDTV and the wall.
- If you want to mount your HDTV on the wall, see below for additional information.
- Avoid installing your HDTV in places with high humidity, dust, or smoke so you do not shorten the service life of the electronic components.
- Install your HDTV in a level, landscape orientation, with the VIZIO logo at the bottom to prevent poor ventilation and excessive component damage.

VIZIO offers professional installation services. Contact VIZIO for more information on these services at 888-VIZIOCE (888-849-4623) or [www.VIZIO.com](http://www.VIZIO.com).

## Wall Mounting your HDTV

Your HDTV can be mounted on the wall for viewing. If you choose to mount your HDTV on the wall, follow the instructions below.

1. Remove the stand base and neck:
  - a. Disconnect the cables from your HDTV.
  - b. Place your HDTV face down on a soft, flat surface to prevent damage to the screen.
  - c. Remove the six screws and pull off base.

**Note:** To remove the base from the neck, unscrew thumbscrew on bottom.

2. Mount your HDTV on the wall:
  - a. Attach your HDTV to a wall mount (sold separately) using the mounting holes in the back panel of your HDTV.
  - b. Read the instructions that came with your specific wall mount to properly hang your HDTV.

**Note:** Use M6 x 20mm 1.0 pitch screws in two upper holes, M6 x 14mm in two lower holes.

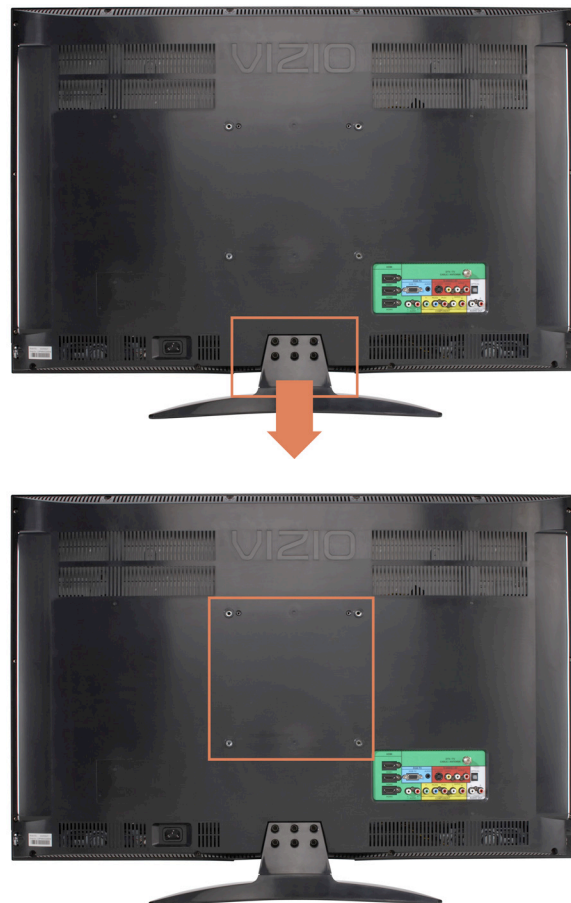

## Chapter 1 Basic Controls and Connections

### Front Panel

**POWER 'VIZIO' LIGHT**– The VIZIO name lights white when powered on and orange when powered off.

**REMOTE CONTROL SENSOR** – Point the remote control directly at this window for the best response to the remote signal.



### Side Panel Controls



#### Right side

**POWER/Jog Wheel** (  ) – Switch the HDTV on by pressing the button once. Press the button again to turn the HDTV off.



#### Left side

**Multimedia Port** – Insert a FAT/FAT32 formatted USB drive to view pictures, listen to music, or watch movies.



## Rear Panel Connections

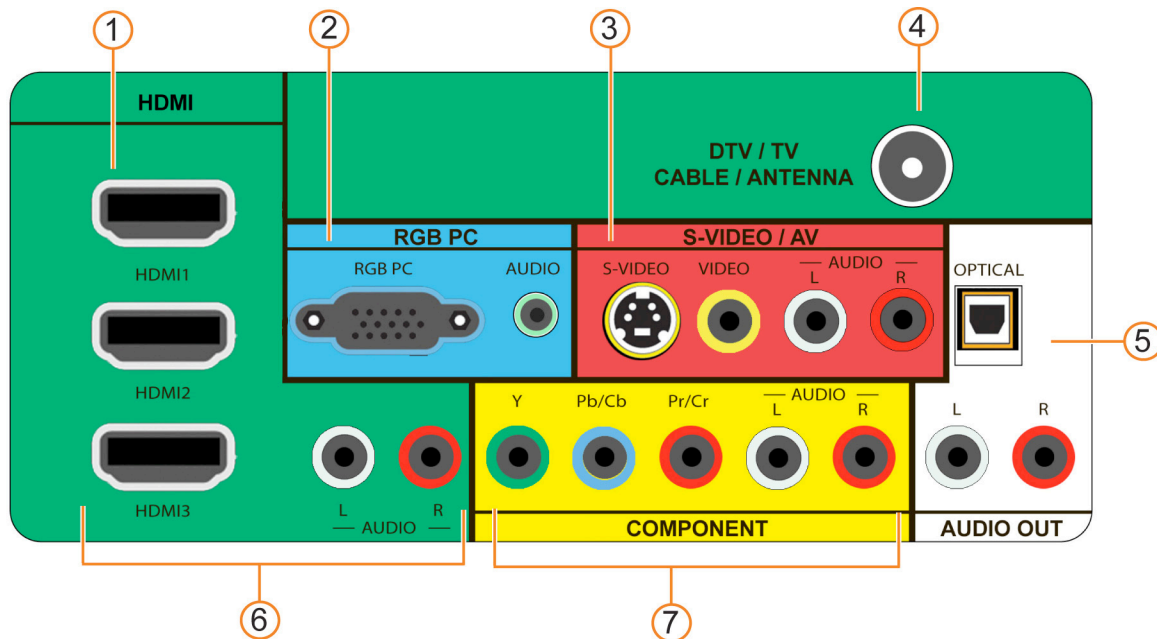

1. **HDMI 1 & 2** – Connect digital video devices such as DVD multimedia players or set top box through these all digital connectors.
2. **RGB PC** – Connect the video and audio from a computer here. A cable with a 1/8" mini plug stereo connector at the end connecting to the TV is needed if sound is also transmitted with this signal.
3. **S-VIDEO/AV** – Connect composite or S-Video video devices, such as a VCR or video game. Use the white and red connectors to connect the external audio from the same source.
4. **DTV/TV** – Connect to an antenna or digital cable (no Cable Box) for Digital TV. For digital TV stations in your area visit [www.antennaweb.org](http://www.antennaweb.org).
5. **AUDIO OUT** –
  - a. (OPTICAL) When digital TV is selected for viewing, the audio associated with the programming will be available on the SPDIF Optical connector for connection to your home theater system.
  - b. (ANALOG L/R) Connect the audio from the HDTV to an external device, such as a home theater system, external amplifier or stereo. Speakers can not be connected directly here.
6. **HDMI 3** - Connect another digital video device such as a DVD multimedia player or set top box through this all digital connector. For users who want to connect to a DVI enabled device, use a DVI-HDMI cable and connect the analog audio output of the device to the L+R AUDIO here. Your VIZIO Certified HDMI and HDMI-DVI cables are available for purchase from [www.VIZIO.com](http://www.VIZIO.com) or by calling 888-VIZIOCE (888-849-4623).
7. **COMPONENT (YPb/CbPr/Cr with Audio L/R)** – Connect component video devices such as a DVD Player or set top box here.



## VIZIO Remote Control



**POWER** (  ) – Press this button to turn the TV on from the Standby mode. Press it again to return to the Standby mode.

**SET** – This button starts all programming of the Remote Control.

**HDMI** – Press this button to select the HDMI input. By pressing it repeatedly you will go through all HDMI inputs in sequence.

**COMP** – Press this button to select Component input.

**AV** – Press this button to select AV (either Composite or S-Video) input.

**TV** – Press this button to select TV.

**PIP** – Pressing this button will activate the picture-in-picture feature. The screen will display the sub-screen in the corner over the main screen. Pressing it again will display the POP (Picture Outside Picture) option.

**P.SIZE** – Repeatedly press this button to set the size of the PIP screen to small, medium, or large.

**P.INPUT** – Press the button to choose the input source for the PIP screen.

**P.CH** – Press this button to change the channels in the PIP screen when TV is selected as PIP input.

**WIDE** – This button cycles through the available screen formats. The options are Zoom1, Zoom2, Stretch, Panoramic, Full, and Normal (depending on input selected).

**FREEZE** – Press this button to “Freeze-Frame” the current screen. Press this button again to continue playing.

**MTS** – This button will select the MTS options of Stereo, SAP or Mono in standard TV mode and alternate audio channels, where available, in DTV mode.

**SWAP** – While in PIP/POP mode; pressing SWAP will switch the displays from the main screen to the sub-screen or vice versa.

**MODE** – Use this button to change the picture mode from Custom, Standard, Movie, Game, Vivid, Football, Golf, Basketball, and Baseball.

**INFO** – This button displays the image and system information display.

**P.AUDIO** – Press this button to switch the audio from the main screen to the sub-screen while in PIP or POP mode.

**CC** – This button will select the Closed Caption mode.

**DVD** – This button selects a programmed DVD player.

**AUDIO** – This button selects a programmed Audio Receiver/Amp/Home Theater System.

**CABLE** – This button selects a programmed cable TV set-top box or a satellite TV set-top box.

**TV** – This button has been pre-programmed to select the codes to operate the VIZIO HDTV.

**MENU** – Use this button for the On-Screen Display (OSD) menu. When it is used within a menu selection, pressing this button will return to the previous selection or exit the menu.

**EXIT** – Press this button to exit from the On-Screen Display (OSD) menu

**OK** – Use this button for the On-Screen Display (OSD) menu. Press it to confirm or choose a highlighted menu selection. In Multi Media mode,





press this button to select folders and files and to play/pause a slideshow, playing music, or movies.

**▲▼◀▶** -These buttons are used to navigate the OSD menu. They will also be used as value settings when the slide bar is shown on the screen and option settings to turn a feature off or on.

**GUIDE** – This button displays program information. Note: This function is only available on DTV.

**LAST** – This button recalls the previously viewed channel. If the On-Screen Display (OSD) menu is being used, this button will allow you to get back to previous menu screen or out to your program when you press it repeatedly.

**MEDIA** – Press this button to view pictures, listen to music, or watch movies on a USB drive connected to the Multi Media port on the side of the HDTV.

**VOL +/-** – This button turns the volume up or down.

**CH ▲/▼** – This button changes the channels up or down.

**MUTE** – This button turns the sound on and off.

**NUMBER BUTTON PAD** – Use these buttons to select a channel or enter a password.

**INPUT** – This button allows the user to cycle through the inputs. Repeatedly pressing this button will step you through the input sources in the following sequence: TV, AV, Component, RGB, HDMI1, HDMI2, and HDMI3. Once you have stepped through the entire sequence, you will return to the beginning.

- **(DASH)** – When selecting a digital channel directly, use this button between the main and sub-channels. For example, channel 28-2 would be selected by the button sequence 2, 8, DASH, 2.

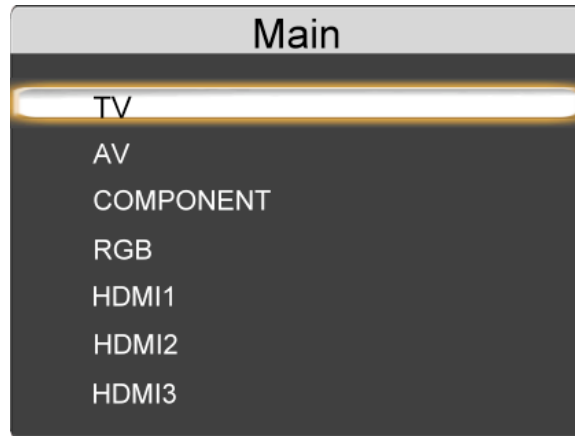

**Quick Menu Operation**

**Standby/Power on**

By pressing the Power button, VIZIO logo turns to white to indicate power on. To turn off the HDTV, press this button again.

**Note:** When the Quick Menu is not displayed, pressing this button turns the HDTV On or Off.

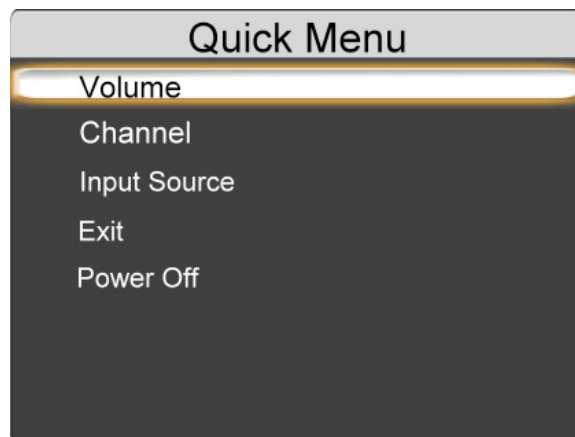

**Menu operation**

Rotate the Jog Wheel Left or Right to activate the QUICK MENU, then rotate Left or Right to select one of the functions:

**Volume adjustment**

Rotate the Jog Wheel Left or Right to select **Volume** and press in on the button. Rotate the Jog Wheel Left or Right to increase or decrease volume.

**Channel selection**

Rotate the Jog Wheel Left or Right to select **Channel** and press in on the button. A Channel list will appear. Select a channel by rotating the Jog Wheel Left or Right, then press in on the button to confirm the channel selection.



### Input Source

Rotate the Jog Wheel Left or Right to select **Input** and press in on the button. Rotate the Jog Wheel Left or Right to cycle through the input sources by the following sequence: TV, AV(S-video or Composite), COMPONENT, RGB ,HDMI1 , HDMI2, HDMI3. Press in on the button to confirm the channel selection.

### Exit

Rotate the Jog Wheel Left or Right to select **Exit**. Press in on the button to exit the Quick Menu.

### Power Off

Rotate the Jog Wheel Left or Right to select Power Off and Press in to turn off the HDTV.

**Note:** When the Quick Menu is displayed and no selection is made within three seconds, the menu will exit automatically.

### Insertion of Batteries in the Remote Control

Insert two AAA batteries into the remote control. Make sure that you match the (+) and (-) symbols on the batteries with the (+) and (-) symbols inside the battery compartment. Re-attach the battery cover.

#### Precautionary Tips for Inserting the Batteries:

- Only use the specified AAA batteries.
- Do not mix new and old batteries. This may result in cracking or leakage that may pose a fire risk or lead to personal injury.
- Inserting the batteries incorrectly may also result in cracking or leakage that may pose a fire risk or lead to personal injury.
- Dispose of the batteries in accordance with local laws and regulations.
- Keep the batteries away from children and pets.



### Remote Control Range

Point the remote control at the remote control sensor to transmit the commands.

Do not place any obstacles between the remote control and the receiver window.

The effective range of the remote control is approximately 30 feet (10 meters) from the front of the receiver window, 30° to the left and right, 20° up and down.

### VIZIO Remote Control Precautions

The remote control should be kept dry and away from heat sources. Avoid humidity.

If the TV responds erratically to the remote control or does not respond at all, check the batteries. If the batteries are low or exhausted, replace them with fresh batteries.

When not using the remote control for a long period of time, remove the batteries.

Do not take the batteries apart, heat them, or throw them into a fire.

Do not subject the remote control to undue physical stress, such as striking or dropping it.

Do not attempt to clean the remote control with a volatile solvent. Wipe it with a clean, damp cloth.







## Chapter 2 Connecting Equipment

### Which Video Connection Should I Use?

The VIZIO HDTV has six different ways to connect your video equipment from a basic connection to the most advanced for digital displays.

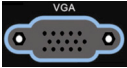
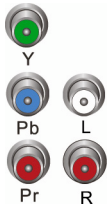
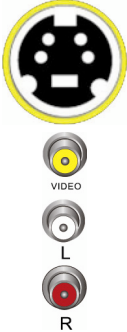
Connection Quality (type)	Connector	Description
Best (digital)	 <p>HDMI</p>	HDMI provides an interface between any audio/video source, such as a set-top box, DVD player, or A/V receiver and a digital television (DTV), over a single cable.
Best (digital) ----- Compatible (analog)		Connect a digital or analog antenna cable or coaxial cable to watch TV programming.
Best (analog)	 <p>VGA</p>	RGB PC (VGA) – This is most commonly used for PC input.
Better (analog)	 <p>Y Pb L Pr R</p>	Component - Component video provides a sharper image than composite video and S-video because the three video signals are transmitted via three separate channels.
Compatible (analog)	 <p>VIDEO L R</p>	<p>S-Video (AV) - Combining the three video signals into two channels, S-Video provides a sharper image than Composite video, but is not as good as Component video.</p> <p>Composite (AV) - All three video signals are combined into one channel, thus making the image less sharp than Component or S-Video.</p>



## Connecting Your Cable or Satellite Box

You have four options for connecting your cable or satellite box to your HDTV: HDMI, Component, Composite, or Coax (RF). Based on your home theater configuration, you can decide which option is the right one for you. Refer to your set-top box user manual for more information about the video output requirements or consult your cable or satellite operator.



### Using HDMI (Best)

Cable and Satellite Boxes that have a HDMI digital interface should be connected to the HDMI input of the HDTV for optimal results.

**Note:** To maintain the display quality, use a VIZIO certified HDMI cable. Length is available up to 10 meters. See [www.vizio.com](http://www.vizio.com) or call 1-888-VIZIOCE (1-888-849-4623) for details.

1. Turn off the power to the HDTV and HDTV Set-Top Box.
2. Connect an HDMI cable to the HDMI output of your HDTV Set-Top Box and the other end to the **HDMI 1** input at the rear of the HDTV.
3. Turn on the power to the HDTV and HDTV Set-Top Box.
4. Select **HDMI 1** using the **INPUT** button on the remote control, or directly by pressing the **HDMI** button on the remote control.

**Note:**

- The HDMI input on the HDTV supports High-bandwidth Digital Content Protection (HDCP). HDCP encrypts the transmission between the video source and the digital display for added security and protection.
- If you are already using the HDMI1 input for another device, or you do not want to use the HDMI1 input for the Set-Top Box, you can connect the Set-Top Box to another HDMI connection.
- Refer to your HDTV Set-Top Box user manual for more information about the video output requirements of the product or consult your cable or satellite operator.



### HDMI Connections for Cable or Satellite Boxes with DVI

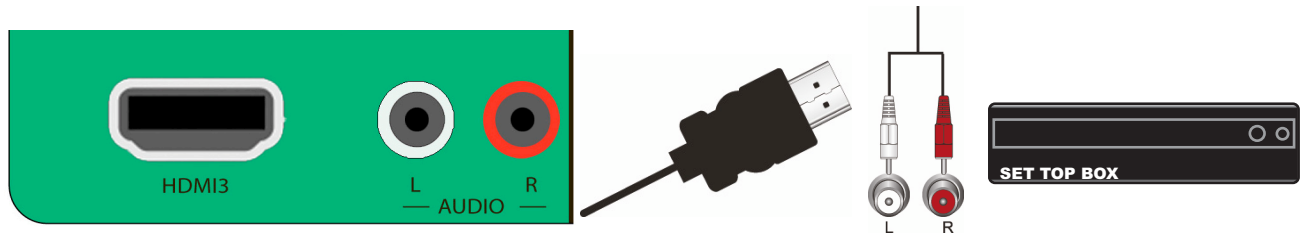

1. Turn off the power to the HDTV and HDTV Set-Top Box.
2. Using a HDMI-DVI cable, connect the DVI end to your HDTV Set-Top Box and the HDMI end to the **HDMI 3** input at the rear of the HDTV.
3. Using an audio cable, connect the cable to the audio output connectors associated with the DVI output on your HDTV Set-Top Box and connect the other end to the audio connectors associated with the HDMI input at the rear of the HDTV.
4. Turn on the power to the HDTV and HDTV Set-Top Box.
5. Select **HDMI 3** using the **INPUT** button on the remote control, or directly by pressing the **HDMI** button on the remote control.

**Note:**

- The HDMI input on the HDTV supports High-bandwidth Digital Content Protection (HDCP). HDCP encrypts the transmission between the video source and the digital display for added security and protection.
- Refer to your HDTV Set-Top Box user manual for more information about the video output requirements of the product or consult your cable or satellite operator.

### Using Component Video (Better)

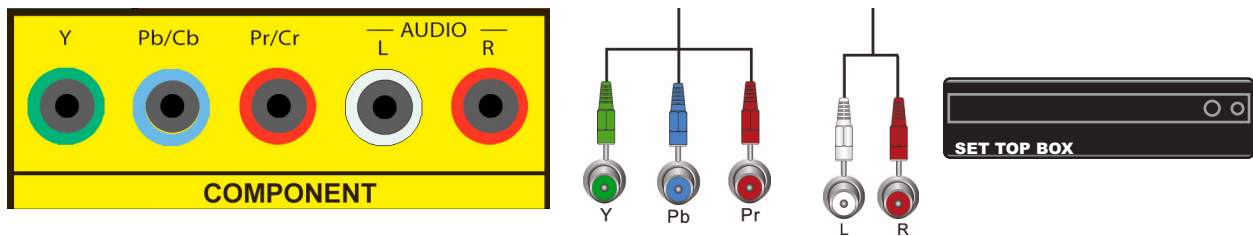

1. Turn off your HDTV and set-top box.
2. Connect the component cables (green, blue, and red) from your set-top box to the **COMPONENT** jacks on the back of your HDTV.
3. Connect the audio cables (white and red) from your set-top box to the adjacent **COMPONENT L** and **R Audio** jacks on the back of your HDTV.
4. Turn on your HDTV and set-top box.
5. Press **COMP** on the remote control to view the content.



### Using S-Video (Compatible)

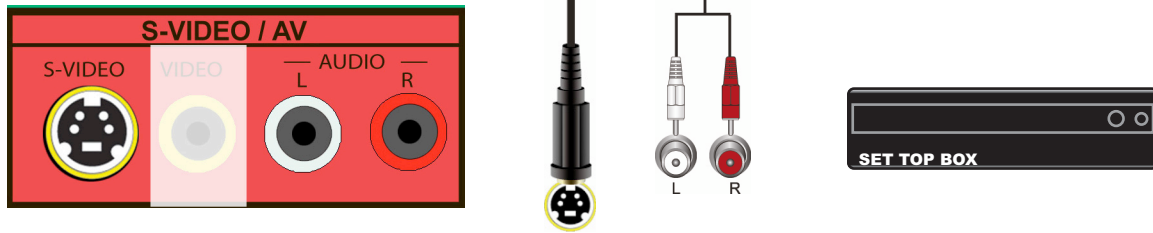

1. Turn off your HDTV and set-top box.
2. Connect the S-VIDEO cable from your set-top box to the **S-VIDEO** jack on the back of your HDTV.
3. Connect the audio cables (white and red) on your set-top box to the corresponding **L** and **R AUDIO** jacks on the back of your HDTV.
4. Turn on your HDTV and set-top box.
5. Press **AV** on the remote control to view the content.

### Using Composite Video (Compatible)

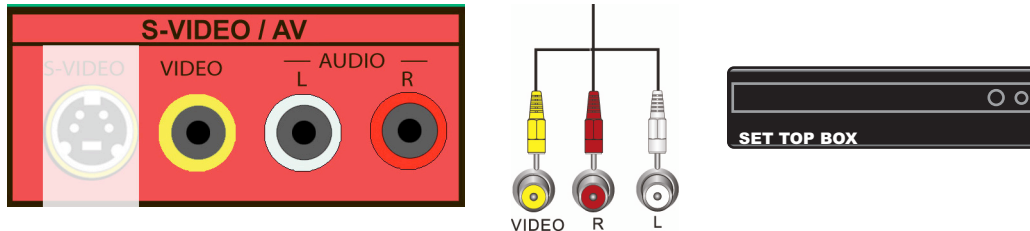

1. Turn off your HDTV and set-top box.
2. Connect the video cable (yellow) from your set-top box to the **AV** jack (yellow) on the back of your HDTV.
3. Connect the audio cables (white and red) on your set-top box to the corresponding **L** and **R AUDIO** jacks on the back of your HDTV.
4. Turn on your HDTV and set-top box.
5. Press **AV** on the remote control to view the content.

### Using Coaxial (Antenna) (Compatible)

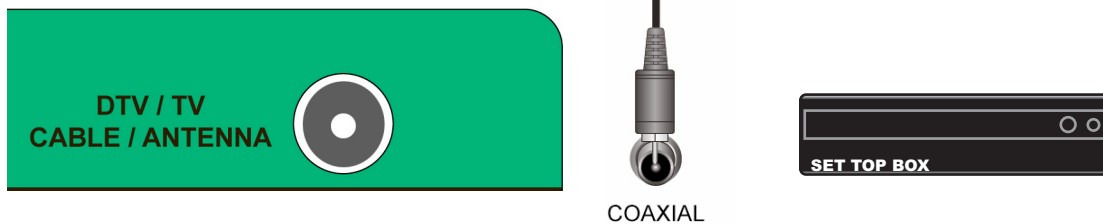

1. Turn off the power to the HDTV.
2. Connect the coaxial (RF) connector from your antenna or digital cable to the **DTV/TV CABLE/ANTENNA** connector at the rear of the HDTV.
3. Turn on the power to the HDTV.
4. Select TV using the **INPUT** button on the remote control, or directly by pressing the **TV** button on the remote control.



## Connecting Coaxial (RF)

### Using Your Antenna or Digital Cable for Standard TV or Digital TV



COAXIAL



1. Turn off the power to the HDTV.
2. Connect the coaxial (RF) connector from your antenna or cable to the **DTV/TV CABLE/ANTENNA** connector at the rear of the HDTV
3. Turn on the power to the HDTV.
4. Select TV using the **INPUT** button on the remote control, or directly by pressing the **TV** button on the remote control.

### Using the Antenna or Cable through Your VCR



COAXIAL



1. Turn off the power to the HDTV and VCR.
2. Connect the "Output to TV", "RF Out" or "Antenna Out" connector on the rear of your VCR to the **DTV/TV CABLE/ANTENNA** connector at the rear of the HDTV.
3. Turn on the power to the HDTV and VCR.
4. Select TV using the **INPUT** button on the remote control, or directly by pressing the **TV** button on the remote control.

**Note:** If you have an off-air antenna or cable TV, connect it to the "Antenna In" connector on the rear of your VCR.



## Connecting Your DVD Player

You have several options for connecting your DVD player to your HDTV: HDMI, Component, S-Video and Composite (AV) inputs. Based on your home theater configuration, you can decide which option is the right one for you.

### Using HDMI (Best)



For optimal results, DVD players that have a digital interface such as HDMI should be connected to the HDMI input on your HDTV.

1. Turn off your HDTV and DVD player.
2. Connect a HDMI cable to the HDMI output of your DVD player and the other end to the **HDMI 1** input at the rear of the HDTV.
3. Turn on the power to the HDTV and your DVD player.
4. Select **HDMI 1** using the **INPUT** button on the remote control, or directly by pressing the HDMI button on the remote control.

**Note:** If HDMI 1 is being used, connect to another HDMI port instead.

### HDMI Connections for DVD Players with DVI

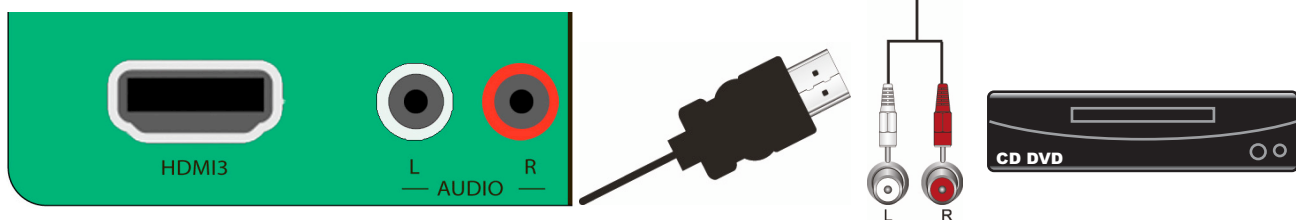

1. Turn off your HDTV and DVD player.
2. Using a HDMI-DVI cable, connect the DVI end to your DVD player and the HDMI end to the **HDMI 3** Input at the rear of the HDTV.
3. Connect the audio cables (white and red) from the DVI audio output jacks on the DVD player to the adjacent **HDMI 3 L** and **R AUDIO** jacks on the back of your HDTV.
4. Turn on the power to the HDTV and your DVD player.
5. Select **HDMI 3** using the **INPUT** button on the remote control, or directly by pressing the **HDMI** button on the remote control.

**Note:** To maintain the display quality, use a VIZIO certified HDMI cable. Length is available up to 10 meters. See [www.VIZIO.com](http://www.VIZIO.com) or call 1-888-VIZIOCE (1-888-849-4623) for details.



### Using Component Video (Better)

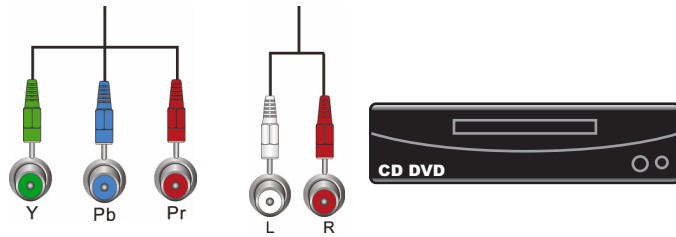
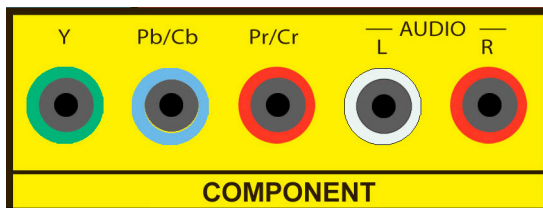

1. Turn off the power to the HDTV and DVD player.
2. Connect the component cable (green, blue, and red) from your DVD player to the **COMPONENT** jacks on the back.
3. Connect the audio cables (white and red) from your DVD player to the **COMPONENT L** and **R AUDIO** jacks on the back.
4. Turn on the power to the HDTV and DVD player.
5. Select **Component** using the **INPUT** button on the remote control, or directly by pressing the **COMP** button on the remote control.

### Using S-Video (Compatible)

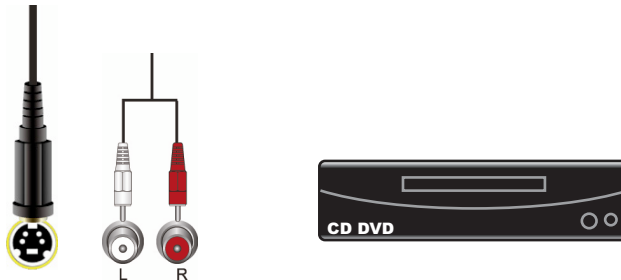
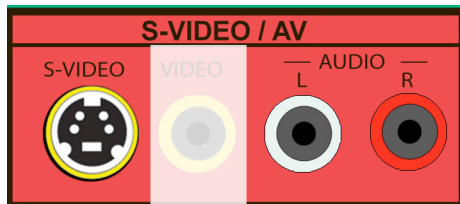

1. Turn off the power to the HDTV and DVD player.
2. Connect the S-VIDEO cable from your DVD player to the **S-VIDEO** jack on the back of your HDTV.
3. Using an audio cable, connect the cable to the audio output connectors associated with the S-Video output on your DVD player and connect the other end to the audio connectors associated with the AV input at the rear of the HDTV.
4. Turn on the power to the HDTV and DVD player.
5. Select **AV** using the **INPUT** button on the remote control, or directly by pressing the **AV** button on the remote control.



## Using Composite (AV) Video (Compatible)

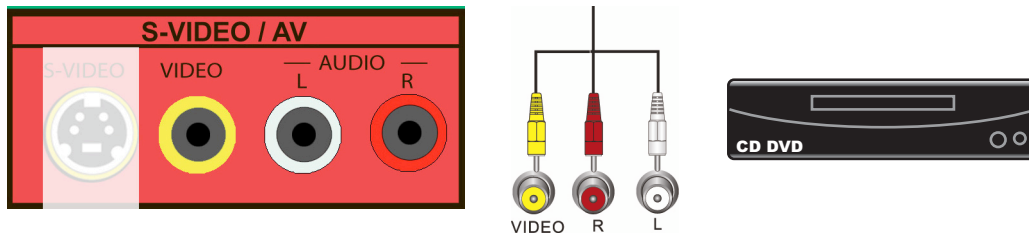

1. Turn off the power to the HDTV and DVD player.
2. Connect the Video cable (yellow) from your DVD player to the **S-VIDEO/AV** jack on the back of your HDTV.
3. Connect the audio cables (white and red) on your DVD player to the **S-VIDEO/AV L** and **R AUDIO** jacks on the back of your HDTV.
4. Turn on the power to the HDTV and DVD Player.
5. Select **AV** using the **INPUT** button on the remote control, or directly by pressing the **AV** button on the remote control.

## Connecting Your VCR or Video Camera

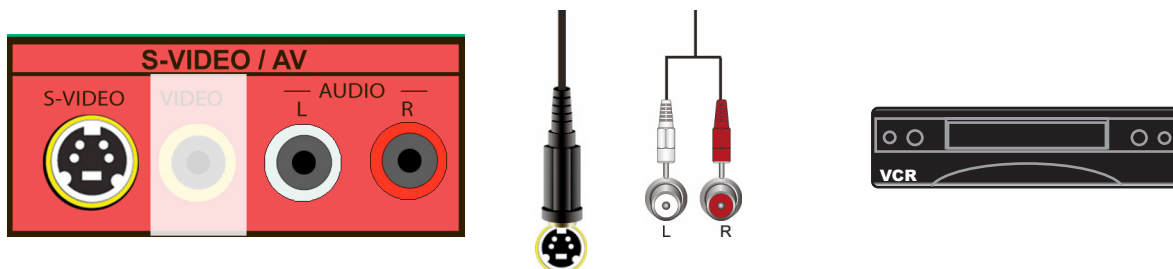

1. Turn off the power to the HDTV and VCR or Video Camera.
2. Connect the S-VIDEO cable from your VCR or video camera to the **S-VIDEO** jack on the back of your HDTV.
3. Connect the audio cables on your set-top box to the corresponding **L** and **R AUDIO** jacks on the back of your HDTV.
4. Turn on the power to the HDTV and VCR or Video Camera.
5. Select **AV** using the **INPUT** button on the remote control, or directly by pressing the **AV** button on the remote control.

**Note:** Refer to your VCR or Video Camera user manual for more information about the video output requirements of the product.





## Connecting an External Receiver/Amp

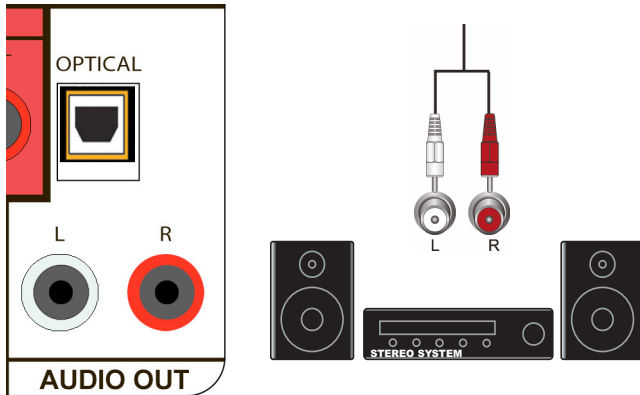

1. Turn off the power to the HDTV and Receiver/Amp.
2. Using an audio cable (white and red connectors), connect the cable to the audio input connectors on the Receiver/Amp and connect the other end to the **AUDIO OUT** audio connectors at the rear of the HDTV.
3. Turn on the power to the HDTV and Receiver/Amp.
4. Then press the **MENU** button on the remote control to open the On-Screen Display (OSD) menu.
5. Press **▼** on the remote control to highlight the Audio menu, then press **OK** to select.
6. Press **▼** on the remote control to select **SPEAKERS**.
7. Press **▶** on the remote control to select OFF so the sound from the HDTV will be routed through your Receiver/Amp system.



### Note:

- Refer to your Receiver/Amp user manual to select the corresponding audio input.
- The audio output is not amplified and cannot be connected directly to external speakers.

## Optical Output of audio received with HD Programs

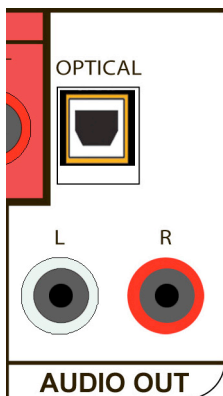

If your sound system has a SPDIF (optical) digital audio input you can connect it to the **OPTICAL** digital audio out at the rear of the HDTV. This is active when receiving audio with the programs being viewed no matter what input is being used.



## Connecting a Computer

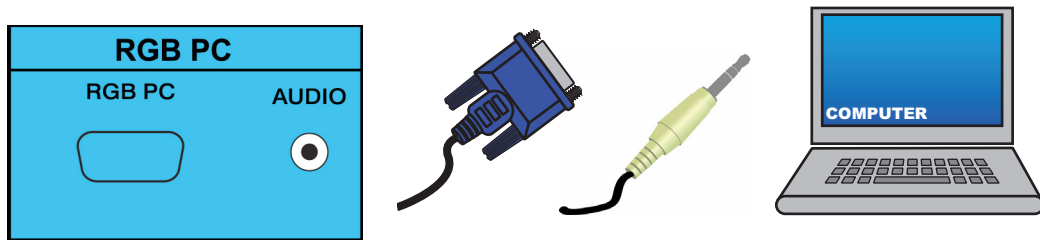

1. Turn off the power to the HDTV and Computer.
2. Connect the VGA cable from your computer to the **RGB PC** jack on the back of your HDTV.
3. Connect the 1/8-inch audio cable from your computer to the RGB PC **Audio** jack on the back of your HDTV. This step is optional and only needed if you want to transmit audio from the Computer through the TV.
4. Turn on the power to the HDTV and Computer.
5. Select **RGB** using the **INPUT** button on the remote control.

### Note:

- For a better picture quality when connecting a PC computer through RGB PC, set your PC computer timing mode to VESA 1920 x 1080 at 60Hz.
- Refer to your PC computer user manual for more information about the video output requirements of the product.
- A RGB (VGA) cable and stereo mini jack cable are not included and can be purchased at an electronics store.

**Preset PC Resolutions**

If connecting to a PC through the RGB PC input, set the TV timing mode to VESA 1920x1080 at 60Hz for better picture quality (refer to the graphic card’s user guide for questions on how to set this timing mode). See the table below for the factory preset resolutions. Also see Resolution through RGB Input chart below for the best resolution available through RGB PC input when video card supports 1920x1080 resolution.

Mode No.	Resolution	Refresh Rate (Hz)	Horiz. Freq (KHz)	Vert Freq (Hz)	Horiz Sync Polarity (TTL)	Vert Sync Polarity (TTL)	Pixel Rate (MHz)	Remark
1	640 x 480	60	31.469	59.941	N	N	25.175	Windows
2	640 x 480	75	37.500	75.000	N	N	31.500	Windows
3	800 x 600	60	37.879	60.317	P	P	40.000	Windows
4	800 x 600	72	48.077	72.188	P	P	50.000	Windows
5	800 x 600	75	46.875	75.000	P	P	49.500	Windows
6	1024 x 768	60	48.363	60.004	N	N	65.000	Windows
7	1024 x 768	70	56.476	70.069	N	N	75.000	Windows
8	1024 x 768	75	60.023	75.029	P	P	78.750	Windows
9	720 x 400	70	31.469	70.087	N	P	28.322	DOS
10	Ⓢ1920 x 1080	60	66.587	59.934	P	N	138.50	Windows

**Note:** P: positive, N: negative, Ⓢ: Primary mode

**Resolution through RGB Input**

If your PC supports VESA Reduced Blanking timing via the VGA card drive program (usually offered by the VGA Card Manufacturer), your TV set is equipped to have the 1920 x 1080 resolution display through this connection using the following timing 138.5MHz. The following parameters are often the values required by the software or programs to set up the display:

Parameters	Horizontal Values (Pixels)	Vertical Values (Lines)
Address	1920	1080
Front Porch	48	3
Sync Width	32	5
Back Porch	80	23
Total	2080	1111
Frequency	66.587 kHz	58.934 Hz
Sync Polarity	P	N
Pixel Rate (MHz)	138.5	
Refresh Rate (Hz)	59.934	



## Chapter 3 Using the Media Port

With the Multimedia Viewer you can enjoy digital content such as photos, music, and movies on your HDTV using a USB flash drive connected to the Media Port on the left-hand side of the TV.

USB drives that are USB 2.0 and FAT or FAT32 are supported but the Media Port does not support hard drives or USB hubs.

If your USB drive is oversized and does not physically fit in the Media Port, use a USB extension cable. Connect one end of the cable to your USB drive and the other end to the Media Port.

Multimedia Viewer Specifications	
<b>Supported File Extensions</b>	<b>Video:</b> .asf, .wmv, .avi, .mp4, .mov, .mpg, .mpeg, .vob (DVD) <b>Audio:</b> .mp3 <b>Image:</b> .jpg, .jpeg (up to 17,000 x 10,000 pixels)
<b>Readable Data Format</b>	FAT and FAT32
<b>Maximum folder depth</b>	Folders can be up to 20 levels deep. The first folder on the drive is Level 1. A folder within that folder is Level 2, a folder within that folder is Level 3, etc.
<b>Display Limits</b>	The Multimedia Viewer will show the first 1000 folders and 1000 files in the list

### Supported File Formats





The following are the supported file formats that can be played on your HDTV. Media server content protected by digital rights management such as WMDRM10 (Windows Media Digital Rights Management 10), may not play.

File Extension	Video Encoders Supported	Audio Encoders Supported	Resolutions Supported
.avi	H.264/AVC	AAC	Up to 1920 x 1080
.mp4	MPEG 4 ASP	AAC	Up to 1280 x 720
.asf .wmv	WMV7 (WMV1) WMV8 (WMV2) VC-1/WMV9 (WMV3/WVC1)	WMA7(V1) WMA8(V2)	Up to 1920 x 1080
.mov	H.264/AVC	AAC	Up to 1920 x 1080
.mpg .mpeg	MPEG2	AC3	Up to 1920 x 1080
.vob	MPEG2	AC3	Up to 1920 x 1080

Note: Even the supported format files listed above may or may not play properly or completely, depending on the USB device, bit rate stream and other content characteristics, as well as other factors.



## Viewing Multimedia Content

1. Insert a USB device with digital content such as photos, music, and movies into the Media Port on the left-hand side of your HDTV. If a USB device is already connected, press the **MEDIA** button on the remote control. A message will appear asking if you want to play multimedia content.
2. Press ◀ or ▶ to highlight OK, and then press **OK** to select it.
3. Press ◀ or ▶ to highlight the folder that contains the content you want to see or hear, and then press **OK** to select it. A sub-menu will be displayed, showing the folders and files that are on your USB device.
4. Press ◀ or ▶ to highlight the folder or file you want to play, and then press **OK** to select it. The file will be playing.
5. While playing videos or music, fast forward or fast reverse by pressing ◀ or ▶.
  - a. Press ◀ or ▶ to increase the playback speed forward or reverse 2X. The display at the bottom will show  or .
  - b. Press ◀ or ▶ again to increase the playback speed forward or reverse 4X, 8X, 16X, or 32X. The display at the bottom will show  or .
  - c. Press ◀ or ▶ again to resume normal playback.
6. When finished, press EXIT once to return to the previous screen or repeatedly to return to the main menu.

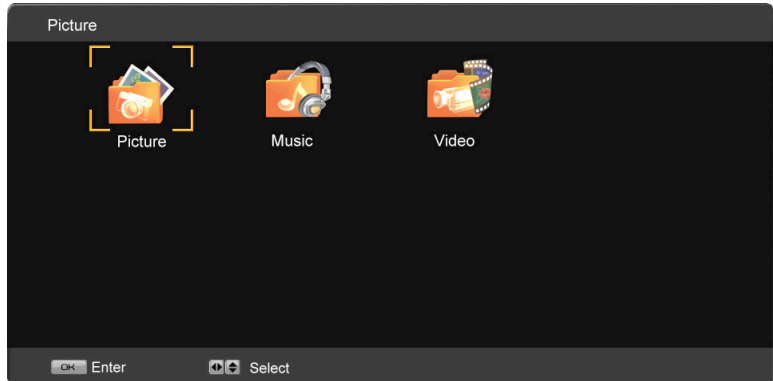
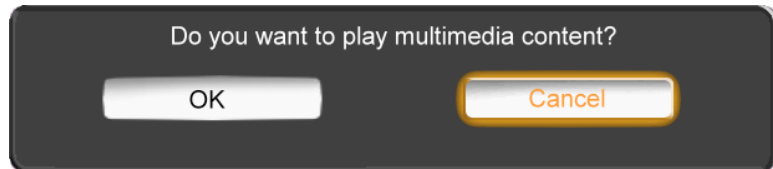

## Picture Settings

When viewing pictures you can adjust various settings, including slideshow, picture duration, etc.

1. Insert a USB device and select the Picture Folder.
2. Press the **MENU** button on the remote control. The Picture menu will be displayed.
3. Press **▲** or **▼** on the remote control to highlight Picture menu option, and then press **◀** or **▶** to adjust the setting.
4. Press the **MENU** button once to close the menu.

### Slideshow Mode

Choose from Shuffle, Single, and Sequence to set the slideshow mode. Single will show all of the pictures once and stop the slideshow after displaying the last picture, Sequence will show your pictures in the order they are listed on your USB device until you stop the slideshow, and Shuffle will show your pictures in random order until you stop the slideshow.

Press **OK** to begin the slideshow. Press **EXIT** to stop the slideshow.

### Slideshow with Music

Choose from Off, Single, Sequence, and Shuffle to set the slideshow with music mode. The music will automatically stop when the slideshow stops.

Press **OK** to begin the slideshow. Press **EXIT** to stop the slideshow.

### Music file browser

Select the slideshow music. Press **OK** to browse for music on your USB device that you want playing during the slideshow. The *Slideshow with Music* option above must be set to Single, Sequence, and Shuffle for this option to work.

### Audio Mode

Choose from Flat, Rock, Pop, Classic, or Jazz to adjust the overall quality of the audio being played during the slideshow. Press **OK** to enter the Audio sub menus for additional adjustments to audio. See Audio Menu adjustment on page 42. Turn SRS TruVolume Off when listening to music.

### Repeat

Choose from On or Off to repeat the slideshow.

### Sort By

You can choose to sort the pictures on the USB device by Photo Date, File Date, or alphabetically (File A-Z).

### Duration

Set the amount of time the picture will remain on the screen during the slideshow. Choose a time between 5 seconds and 32 seconds.

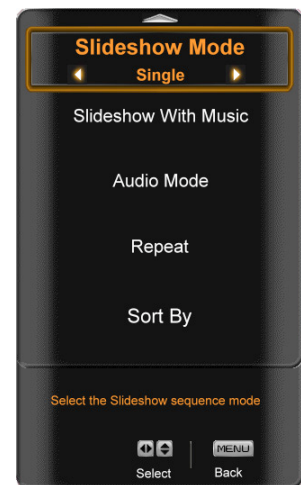

## Slideshow Effect

Choose from Random, Dissolve, Wipe Right, Wipe Left, Wipe Up, Wipe Down, Box In, or Box Out to set the transition type when changing from one picture to another during a slideshow.

## Thumbnail Size

Set the size of the preview pictures (thumbnails) in the menu. Choose from Small, Medium, or Large.

## Info

When set to on, information about the picture briefly appears on the TV.

## Music Settings

When listening to music you can adjust various settings, including selecting an audio mode, choosing repeat options, etc.

1. Insert a USB device and select the Music Folder.
2. Press the **MENU** button on the remote control. The Music menu will be displayed.
3. Press **▲** or **▼** on the remote control to highlight Music menu option, and then press **◀** or **▶** to adjust the setting.
4. Press the **MENU** button once to close the menu.



## Sort By

You can choose to sort the songs by File/Title, Genre, Artist, or Album.

## Play Mode

Choose from Shuffle, Single, and Sequence to set the play sequence mode. Single will play a single song once and stop playing at the end of that song, Sequence will play the songs in the order they are listed on your USB device until you stop it, and Shuffle will play the songs in random order until you stop it.

## Repeat

When set to On, the music will continue playing until you stop it.

## Audio Mode

Choose from Flat, Rock, Pop, Classic, and Jazz to adjust the overall quality of the audio being played.

## Info

When set to on, information about the song briefly appears on the TV.





## Video Settings

When watching videos you can adjust various settings, including selecting an audio mode, setting to a wider format, etc.

1. Insert a USB device and select the Video Folder.
2. Press the **MENU** button on the remote control. The Video menu will be displayed.
3. Press **▲** or **▼** on the remote control to highlight Video menu option, and then press **◀** or **▶** to adjust the setting.
4. Press the **MENU** button once to close the menu.

### Sort By

You can choose to sort the videos by Type, Date, or, File Name.

### Play Mode

Choose from Shuffle, Single, and Sequence to set the video sequence mode. Single will play a video once and stop playing at the end of that song. Sequence will play the videos in the order they are listed on your USB device until you stop it. Shuffle will play the videos in random order until you stop it.

### Repeat

When set to On, the video(s) will continue playing until you stop it.

### Picture Mode

Choose from Custom, Standard, Movie, Game, Vivid, Football, Golf, Basketball and Baseball to adjust the overall quality of the picture. Press **OK** to enter the Picture sub menus for additional adjustments to audio. See Picture Menu adjustment on page 40.

### Wide Format

Set the way the picture looks on the screen:

- 4:3 Aspect Ratio: choose from Normal, Panoramic, Zoom1, or Zoom2.
- 16:9 Aspect Ratio: choose from Full, Stretch, Zoom1, and Zoom2

### Audio Mode

Choose from Flat, Rock, Pop, Classic, Jazz, and Soft to adjust the overall quality of the audio being played.

### Info

When set to on, information about the video briefly appears on the TV.





## Chapter 4 Using your HDTV the first time

### Setup Wizard

1. **Connect the Power Cable**  
Connect the power cord to the power cord connector on the back of the HDTV, and then plug the power cord into an AC wall socket.
2. **Connect Audio and Video Cables to the HDTV**  
(see Chapter 2 for detailed steps)
3. **Turn Power On**  
Once all the components are connected, press the Power ON button on the remote control or on the side of your HDTV.
4. **Initial Setup**
  - a. After powering on the TV set, the *Initial Setup Welcome* screen will come up. Press the **OK** button on the remote control.
  - b. The *Language* choice screen will be displayed; the default English option is highlighted. If you wish to change the OSD language to Español or Français, press the ▼ button on the remote control to select the language you want.
  - c. Press the **OK** button on the remote control to go to the next screen.
  - d. The next screen will display the options **Home Mode** and **Retail Mode**. Selecting Home Mode will give you an opportunity to save energy.
  - e. Press the **OK** button on the remote control to go to the next screen.
  - f. If **Retail Mode** is selected by mistake; the next option will allow you to switch your selection back to **Home Mode**.
  - g. Press the **OK** button on the remote control to go to the next screen.

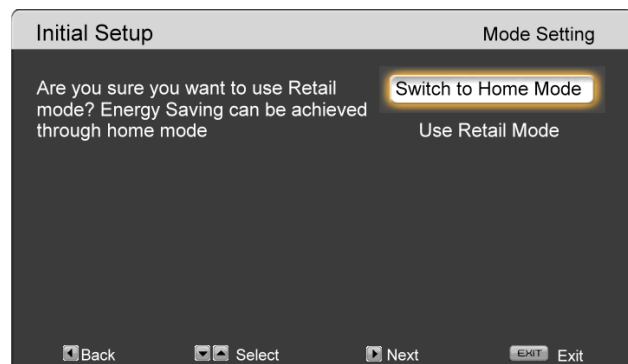
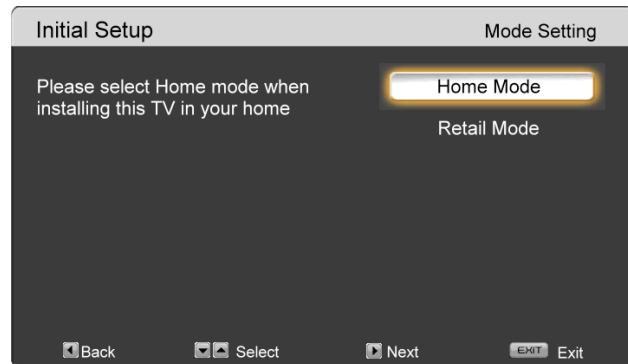
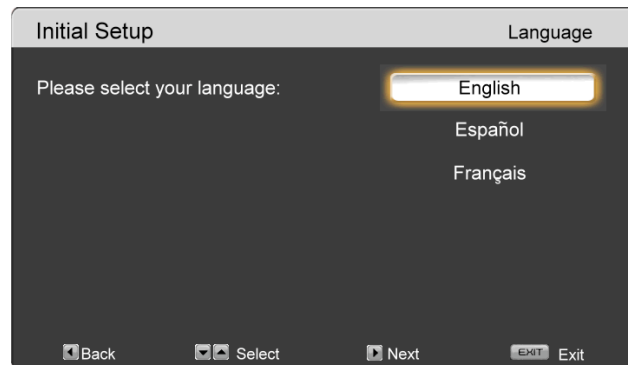
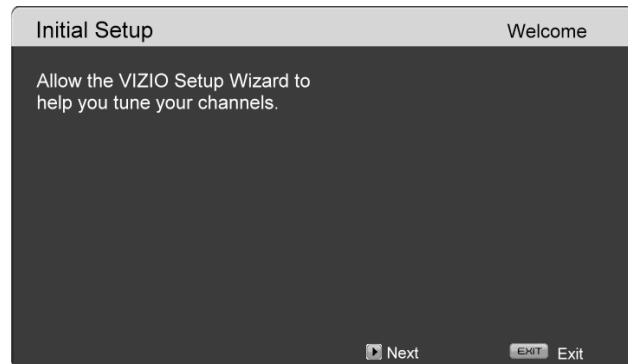

**Note:** At this point, if a set-top box from your cable or satellite service company is being used, press the **OK** button on the remote control and select *Skip Scan*. Otherwise continue with next step:

- h. The *Tuner* screen will be displayed. If you are using Cable Service (with no box), press the ▼ button on the remote control to choose **CABLE**.
- i. Press the **OK** button on the remote control to go to the next screen.
- j. The *Channel Scan* screen will be displayed; default choice is **Scan**.
- k. Press the **OK** button on the remote control to start the search for available channels.
- l. If you do not want to scan for channels at this time, press the ▼ button on the remote control to highlight *Skip Scan* and then press the **OK** button. The screen will now change to show the progress of the search for Analog (NTSC) and Digital (ATSC) channels.

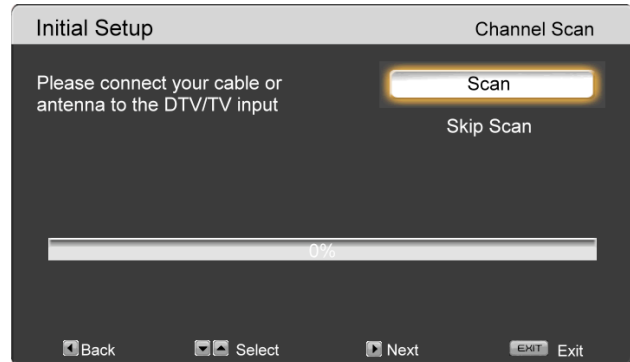
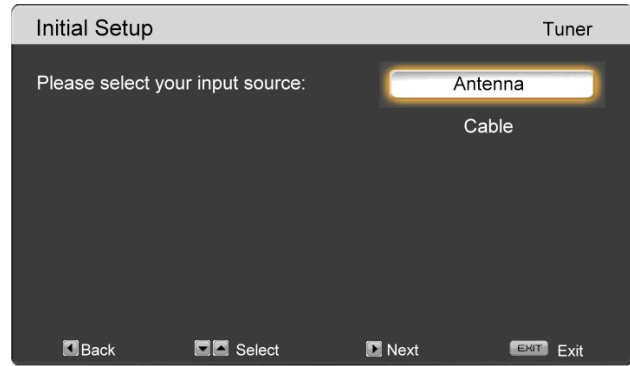

**Note:** If you select *Skip Scan*, you can scan channels at a later time by selecting the TV input, then going to the Menu and selecting the Auto Search option in the TV menu.

Note: Refer to [www.antennaweb.org](http://www.antennaweb.org) to get information about availability in your area, type of antenna and in which direction to point your antenna. The channel availability through cable depends upon which channels your cable operator supplies in Clear QAM; consult your cable operator for more information.

- m. When finished, the *Complete* screen will be displayed to inform you that the HDTV has completed the Initial Setup. Press the **OK** button on the remote control to exit and begin watching TV.

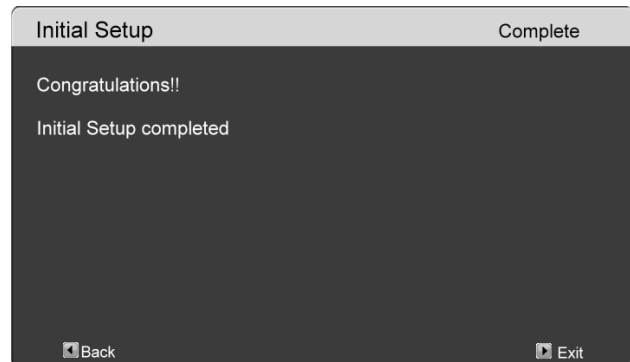
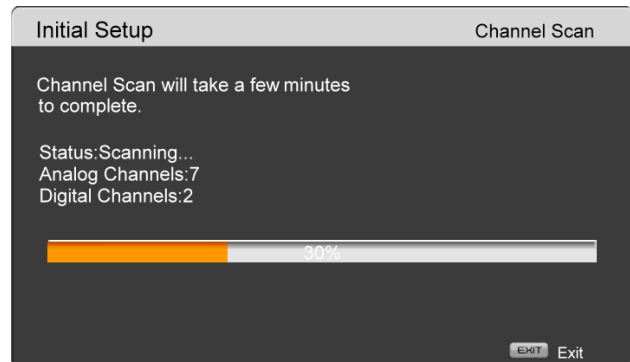

## Select Input Source

Select the Input Source for the HDTV by pressing the **INPUT** button on the remote control. Pressing this button will cycle you through the following options: TV, AV, Component, RGB, HDMI1, HDMI2, and HDMI3.

Turn on your Cable Box, VCR, External TV Tuner or Satellite Receiver and you will see a picture on your HDTV. If there is no picture, make sure you have selected the correct input on the HDTV.

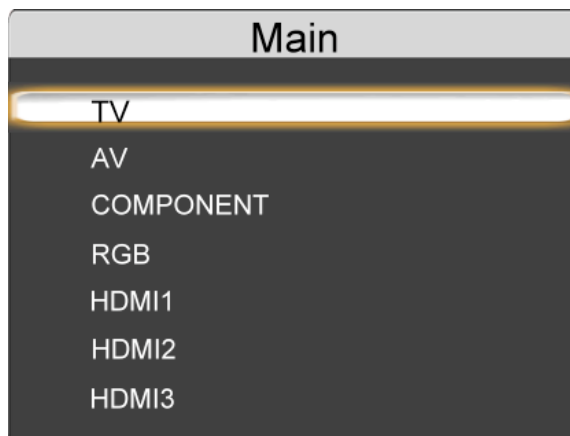

If the selected input is RF, you should be aware that the HDTV needs to be on either channel 3 or channel 4 matching the channel which has been selected on the back of the VCR, Cable Box, External TV Tuner or Satellite Receiver; please refer to Owner or User's Manual of such equipment for details.

**Note:** Your HDTV will display the television station or program selected by the cable box, VCR, external tuner, or satellite receiver. Use the remote control that came with that component to change programs or channels. If the service being used is the one which setup includes a box with two outputs for two different (distant) rooms, then scanning channels will help you to find the signal. Be aware that the channel to be selected varies from provider to provider. You may have to call your provider to get the specific channel when using your HDTV. Some examples of these channels are 105, 106, 115, and 116.



## Fine Tuning the picture

1. Press the **MENU** button to bring up the Menu display. The Picture Menu is highlighted. Press **OK** to select it. Use the **▲** or **▼** buttons to scroll to the Advanced Video option.
2. Press the **▶** button to select it.
3. Use either **▲** or **▼** to scroll to the Color Temperature option.
4. Press the **▶** button to select it.
5. Press either **◀** or **▶** to change setting to **Normal**, and then press the **MENU** button repeatedly until the Picture Mode is displayed.
6. Press either **◀** or **▶** to change the Picture mode option to **Standard**.
7. Press either **▲** or **▼** to scroll to the TV option, and then press **OK** to select it.
8. Press either **▲** or **▼** to scroll to Time Zone, and then press either **◀** or **▶** to set the proper Time Zone of your area.
9. Press **▼** to scroll down to Daylight Saving, and then press either **◀** or **▶** to set to On or Off.
10. Press the **MENU** button once to return to the previous screen or repeatedly to return to your program if task has been completed.

Your new HDTV is now ready to use. Enjoy your TV watching!!

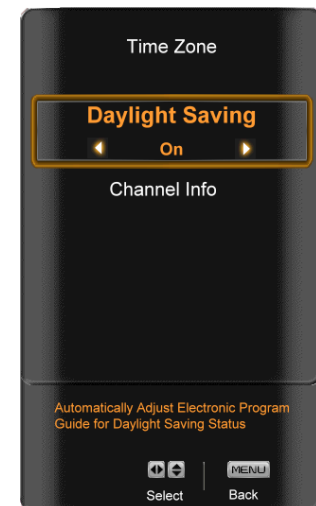

## Watching a TV Program

Before you start watching TV, please make sure that any cable, satellite or off-air antenna connections are secure. Also, verify that the power cord is plugged into a correctly grounded electrical outlet or surge protector.

1. Press the power button on the remote control. The VIZIO logo on the front will change from orange to white.
2. There are 3 options for selecting your programming:
  - a. If you are using an antenna or cable connected through the DTV/TV CABLE/ANTENNA input, you can select TV directly by pressing the **TV** button on the remote control or by selecting TV from the Input menu after pressing **INPUT** on the remote control.
  - b. If you are watching broadcasts through a cable or satellite set-top box connected by an HDMI cable, select HDMI directly by pressing the HDMI button on the remote control, or by selecting HDMI from the Input menu after pressing **INPUT** on the remote control.
  - c. If you are watching broadcasts through a cable or satellite set-top box connected by a Component (YPbPr) cable, select Component directly by pressing the **COMP** button on the remote control or by selecting Component from the Input menu after pressing **INPUT** on the remote control.

**Note:** You should be able to see a picture. If you do not, make sure that all of the HDTV connections are secure and you have selected the correct video input source. Each press of the **HDMI** or **COMP** button on the remote control will cycle through the available inputs. Press the button until the input associated with the device you wish to view is shown in the Info box at the upper right corner of the screen.

3. When using option 2a, press the Channel buttons on the remote control or the CH **▲** or **▼** buttons to change the channel. The Channel buttons and on the remote control, control will not work if you are watching a program using HDMI, Component, or AV (S-Video or Composite) inputs.



## Adjusting Basic HDTV Settings

### Volume

To adjust the volume, press and hold the VOL+ or VOL- button or remote control until the desired level is reached.

### TV Channels

To step up or down through the available TV channels, press the CH ▲ or ▼ button on the remote control once for the next or previous channel, or hold it depressed until the desired channel is reached. Note: Channel up and down will only operate in TV mode.



## Program Information

When watching a digital TV program, the On Screen Display will function as follows:

- When a channel is selected, an information header is shown over the picture for a few seconds.

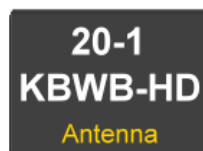

- When you press the **GUIDE** button on the remote control, the information header and a short summary of the program content, when available from the broadcaster, is displayed.

<b>Charmed</b> 10:00PM-11:00PM TV-14-V	English Stereo 1080i HD	<b>20-1</b> <b>KBWB-HD</b> Antenna
Zanku taps the services of the insidious Alchemist (John Kassir) to weaken the nerves of the sisters in a poly to gain control of the Book of Shandows. Meanwhile, Darryl struggles to keep Insp. Sheridan (Jenya Lano) in the dark about the Charmed Ones. Zan		

This information consists of the channel number and name, the format in which the program is broadcast (480i SD, 480P SD, 720P HD, 1080i HD), audio channel 1/2 or 2/2 (omitted if alternate channel is not broadcast), language, program title, program start and end time, program rating and if CC is available.

- Press the **GUIDE** button one more time to close the display



## Chapter 5 Advanced Adjustment of HDTV

### Using the On Screen Display (OSD)

The remote control can control all the function settings. The On Screen Display (OSD) allows you to adjust contrast, brightness and other settings. The TV will save changes made to the settings, even if the TV is turned off.

The OSD consists of several menu options: Picture, Audio Mode, TV, and Setup. The main menu options may vary depending on your selected input source.

**Note:** Some of the main menu options may have additional submenus, for example, the TV Rating submenu for Parental Controls.

1. Press the **MENU** button on the remote control and the Picture menu will be shown on the screen.
2. Press either **▲** or **▼** on the remote control to select one of the other menu options:
  - Picture (Picture Adjust)
  - Audio Mode (Audio Adjust)
  - TV (TV Tuner Setup)
  - Setup (Global Settings)
3. Press **OK** to select the option or feature you want to adjust.
4. Once the menu option is displayed, press **▲** or **▼** on the remote control to select one of the items to adjust.
5. Press **OK** to select, and then press **◀** or **▶** to adjust the selection.
6. Press the **MENU** button once to return to the previous screen or repeatedly to return to your program if adjustments have been completed.



## Picture Menu

1. Press the **MENU** button on the remote control.
2. Press **▲** or **▼** on the remote control to highlight the Picture menu, and then press **OK** to select it.
3. Press **▲** or **▼** on the remote control to select a Picture menu option.
4. Once the menu option is highlighted, press **◀** or **▶** on the remote control to adjust the setting.
5. Press the **MENU** button once to return to the previous screen or repeatedly to return to your program if the task has been completed.

### Picture Mode

Choose from Custom, Standard, Movie, Game, Vivid, Football, Golf, Basketball and Baseball.

### Backlight

The Backlight level adjusts the lamp current and this affects the overall brilliance of the picture but does not affect the Brightness (black level) or Contrast (white level) of the picture.

### Brightness

The Brightness adjusts the black levels in the picture. If the brightness is too low you will not be able to see the detail in darker parts of the picture and if the brightness is too high the picture will look washed out.

### Contrast

The Contrast adjusts the white levels in the picture. If the contrast is too low the picture will look washed out and if the contrast is too high you will not be able to see any detail in the bright parts of a picture.

### Color

Color adjusts the amount of color in the picture.

### Tint

The Tint adjusts the hue of the picture. The easiest way to set tint is to look at flesh tones and adjust for a realistic appearance. In most cases, the default middle position is correct. If people's faces look too orange try reducing the level of color first.

### Sharpness

The Sharpness adjustment adjusts the sharpness of the edges of elements in the picture. It does not produce detail that otherwise does not exist. This adjustment is helpful when viewing (Standard Definition) sources.





## Advanced Video

To select the options in the Advanced Video sub-menu, press the **OK** button or the **▶** button. A new menu will be displayed showing the advanced functions available for fine tuning of the picture.

### Noise Reduction

This feature diminishes picture artifacts caused by the digitizing of image motion content that may be present in the picture. Choose from the Off, Low, Medium, or Strong setting.

### Color Enhancement

This feature increases the picture reproduction performance of the picture by reducing oversaturation of certain colors and improving flesh tones. Choose from Off, Normal, Rich Color, Green/Flesh, and Green/Blue setting.

### Advanced Adaptive Luma

Large areas of brightness in the picture will result in a higher Average Picture Level (APL) and the overall picture will look too light. This feature will lower the APL to counteract this effect. Choose from Off, Low, Medium, Strong, or Extend.

### Backlight Control

Set this feature to OFF, DCR, or OPC. DCR (Dynamic Contrast Ratio) improves the black level performance and increases contrast ratio. OPC (Optimum Power Control) Reduces power consumption while maintaining the same picture brightness.



### Color Temperature

Color Temperature is the “warmness” or “coolness” of the white areas of the picture. Choose from Normal, Custom, Cool, or Computer. Normal is the setting for television broadcasting. Custom allows you to set a preset calibrated for a white point to suit individual preferences. Cool produces a blue-hued image. The Computer setting sets the white point at the established setting for a PC display (9300K). Each preset may also be adjusted for a customized setting.

### Smooth Motion

The Smooth Motion™ Effect option activates Motion Estimation/Motion Compensation (ME/MC), which suppresses motion judder, or “stuttering” of the image when the camera pans across a scene, or there is horizontal motion in the scene. Choose from Off, Low, Middle or High.

### Film Mode

Choose from Auto or Off. When set to Auto, the TV will detect the cadence (for example at 24 frames/second for film, or normal video at 60 fps). When set to Off it will stay at 60 fps.

## Reset Picture Mode

Return all Picture settings to factory default. A screen will come up to confirm your selection or to cancel it. Press either **◀** or **▶** to make the selection, and then press **OK** to accept it.

**Note:** Only settings under the Picture menu will be reset.



## Audio Menu

1. Press the **MENU** button on the remote control and the Picture menu will be shown on the screen.
2. Press **▲** or **▼** on the remote control to highlight the Audio menu, and then press **OK** to select it.
3. Press **▲** or **▼** on the remote control to select an Audio menu option.
4. Once the menu option is highlighted, press **◀** or **▶** on the remote control to adjust the setting.
5. Press the **MENU** key once to return to the previous screen or repeatedly to return to your program if the task has been completed.

## Audio Mode

Choose from Flat, Rock, Pop, Classic or Jazz.

## Equalizer

To select the options in the Equalizer sub-menu, press the **OK** button. A new menu will be displayed showing the volumes of different frequencies (pitches).

Starting from lowest to the highest pitch, they are 120 Hz, 500Hz, 1.5 kHz, 5 kHz and 10 kHz.

1. Press **◀** or **▶** to select the frequency to be adjusted.
2. Use **▲** or **▼** to adjust to adjust the selected frequency to your preference. Values above 0 will boost the frequency and values below 0 will attenuate the frequency.



**Note:** The Equalizer adjustment will only be available when SRS TSHD is set to Off.

## Balance

Adjust the sound to the left or the right.

## SRS TSHD

This option sets the SRS TruSurround HD surround sound process. Choose from On or Off.

**Note:** When SRS TSHD is ON, Equalizer adjustments are not available.

## SRS TruVolume

When the programming switches to a commercial or when changing from channel to channel, volume fluctuations occur. When turned ON, SRS TruVolume™ provides the listener with a comfortable and consistent volume level. Turn this option Off when listening to music.

## Digital Audio Out

This option allows selection of the type of processing for the SPDIF (Optical connector) when used with a Receiver/Amplifier/Home Theater system. Select to choose from OFF, Dolby Digital or PCM.

## Speakers

Turn the internal speakers On or Off. You may want to turn the internal speakers off when listening to the audio through your Home Theater System.



### Analog Audio Out

This option sets the volume control properties when using the RCA (white and red) connectors as audio line out to connect a Receiver/Amplifier/Home Theater system. Choose from Fixed or Variable. When set to Variable, volume from the external speakers will change according to the volume setting on the TV. If it is set to Fixed, the volume can only be changed by the settings on the external stereo system.

### Lip Sync

Lip Sync is designed to adjust the audio of the program being viewed so that it matches the movement of the lips of someone talking on the screen.

### Reset Audio Mode

Return all Audio settings to factory default. A screen will come up to confirm your selection or to cancel it. Press ◀ or ▶ to make the selection, and then press **OK** to accept it.

**Note:** Only settings under the Audio menu will be reset.

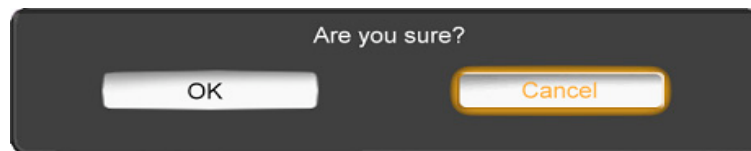

## TV Menu

When you first turned on your HDTV you set up your TV for DTV / TV channels using the Initial Setup screens. If you did not do this or if your setup has changed, you can do this from the TV menu.

1. Press the **MENU** button on the remote control and the Picture menu will be shown on the screen.
2. Press **▲** or **▼** on the remote control to highlight the TV menu, and then press **OK** to select it.
3. Press **▲** or **▼** on the remote control to select a TV menu option.
4. Once the menu option is highlighted, press **◀** or **▶** on the remote control to adjust the setting.
5. Press the **MENU** key once to return to the previous screen or repeatedly to return to your program if the task has been completed.

### Tuner Mode

Select Cable or Antenna depending upon which equipment you have attached to the DTV / TV Input.

### Auto Search

Automatically search for TV channels that are available in your area. The TV will search for analog and digital channels.

### Partial Channel Search

If you believe channels are missed from the auto search, you can do a partial channel search to look for channel in a certain channel range again. Select to scan for Analog, Digital, or both Analog/Digital channels, then press the **▼** button to highlight the "From" and "To" selection. Press the **▶** button to select the range of channel numbers you want to start searching in. Press **OK** to start channel search.

### Skip Channel

After the TV has stored all of the available digital channels in memory you will find that some channels are too weak to watch comfortably or they may be channels you do not want to see. Press the **OK** button to select the channel to be skipped when using the **CH▲** or **CH▼** buttons. You will still be able to select this channel using the number buttons on the remote control.

### MTS

This feature allows you to select the different languages the broadcaster is transmitting the audio with the program you are watching. This signal is usually Spanish.

### Time Zone

Setting the correct Time Zone for your area will ensure that the correct program times are shown after pressing the **INFO** button on the remote control.

### Daylight Saving

Setting the daylight saving time for your area will ensure that the correct program times are shown after pressing the **INFO** button on the remote control.

### Channel Info

Channel Info displays the technical information of the channel including channel number, frequency, modulation type, status, SNR (signal noise ratio), and signal strength.

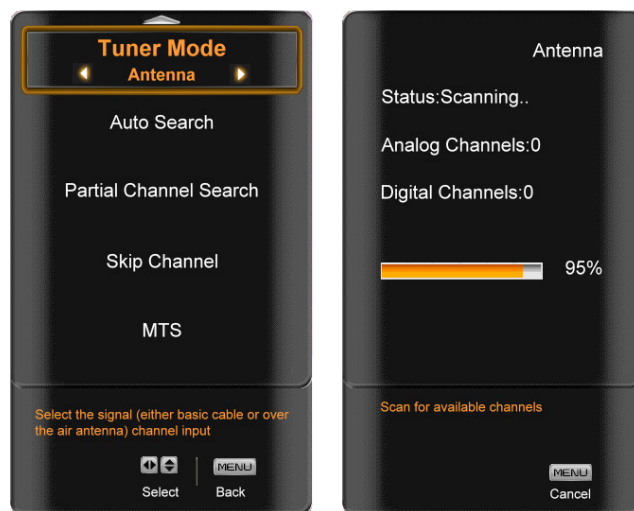

## Setup Menu

1. Press the **MENU** button on the remote control and the Picture menu will be shown on the screen.
2. Press **▲** or **▼** on the remote control to highlight the Setup menu, and then press **OK** to select it.
3. Press **▲** or **▼** on the remote control to select an Input menu option.
4. Once the menu option is highlighted, press **◀** or **▶** on the remote control to adjust the setting.
5. Press the **MENU** key once to return to the previous screen or repeatedly to return to your program if the task has been completed.

### Language

Select to change the Language of the OSD. The default is English. You can also select Español or Français.

### PIP

Your TV features PIP mode so you can watch two pictures at the same time. One picture is displayed as the full screen (main screen) and the other picture is displayed in a small window (sub screen).

**Note:** PIP is only available when the Rating Enable option in the Parental Controls Menu is OFF.

To select the options in the PIP sub-menu, press the **OK** button. A new menu will be displayed showing the following PIP settings:



### PIP Mode

Select from Off, PIP or POP (Picture-outside picture). In PIP mode a smaller sub-screen is displayed on top of the main screen. In POP mode the main screen and sub-screen are of equal size and are positioned side-by-side.



**PIP Source**

Select the input source for the sub-screen. The input sources available will vary according to which input is used for the main screen.

MAIN \ SUB	SUB					
	DTV	TV	AV	Component	HDMI1, HDMI2, HDMI3	RGB
DTV				✓	✓	✓
TV				✓	✓	✓
AV				✓	✓	✓
Component	✓	✓	✓		✓	
HDMI 1	✓	✓	✓	✓		✓
HDMI 2	✓	✓	✓	✓		✓
HDMI 3	✓	✓	✓	✓		✓
RGB	✓	✓	✓		✓	

“✓” – Indicates which inputs are available for PIP and POP modes.

**PIP Position**

Select where you want the PIP screen positioned over the main screen.

**Size**

Set the size of the PIP window. Choose from Small, Medium or Large.

**Audio Source**

Select the audio source associated with the main screen or the sub screen.

**CEC Menu**

Consumer Electronics Control (CEC) allows you to control devices that are connected through HDMI, such as a Blu-ray DVD player, with just one remote control.

- When the TV is turned off, all HDMI-CEC devices will turn off automatically.
- When an HDMI-CEC device is turned on, the TV will turn on automatically.

**CEC Function**

Select whether to allow the TV to control the HDMI-CEC device. Choose Enable (On) or Disable (Off).

**Device Discovery**

Search for all available HDMI-CEC devices connected to the TV.

**Sleep Timer**

Select the timer to turn off the TV in 30, 60, 90 or 120 minutes.

**Wide**

Select how the picture displays on the screen. As you select an option, you will see the screen adjusting to the different sizes. Refer to Understanding Viewing Features for additional details.



### Input Naming

This feature helps you identify the input being watched. You can use up to 8 characters; either letters or numbers or combinations of both, to add a name that will make it easier for you to recognize the input.

1. Press the ► button to go to the next screen that shows the different inputs.
2. Press the ▼ button to select the desired input which you want to label.
3. Press the **OK** button to go to the first space in the bracket.
4. Press either the ▲ or ▼ button and select a desired letter or number.
5. Press the ► button to go to the next space and select a second character.
6. Repeat the step 4 and 5 until the name of the input is complete.
7. Press the **OK** button to accept the name of the input or the **MENU** key to cancel the setting.



### CC (Closed Caption)

To select the options in the CC sub-menu, press the **OK** button or the ► button. A new menu will be displayed showing the following CC settings:

#### CC

The CC feature is available when watching regular analog (NTSC) TV. Select from CC1, CC2, CC3, CC4, Service1, Service2, Service3, Service4, Service5, or Service6. Closed Caption for regular TV is usually CC1 or CC2.

#### Digital CC Style

The Digital CC Style feature is available when watching digital TV. Select either As Broadcaster or Custom. If Custom is selected then you can customize the way Closed Caption is displayed. The options available are:

- **Font Size** (letter size)
- **Font Color** (letter color)
- **Font Opacity** (letter transparency)
- **Background Color** (color of the background where Closed Caption is displayed)
- **Background Opacity** (sets the transparency of the background)
- **Window Color** (color of the area where characters are displayed)
- **Window Opacity** (transparency of the area where characters are displayed)



### H/V Position

To select the options in the H/V Position sub-menu, press the **MENU** button or the **▶** button. A new menu will be displayed showing the following H/V Position settings:

#### H-Position

Adjust the horizontal position of the picture.

#### V-Position

Adjust the vertical position of the picture.

#### H-SIZE

Adjust the horizontal size of the picture.

#### V-SIZE

Adjust the vertical size of the picture.

#### Auto Phase (for Component input only)

The TV will automatically look for the phase of the signal to fine tune the picture.

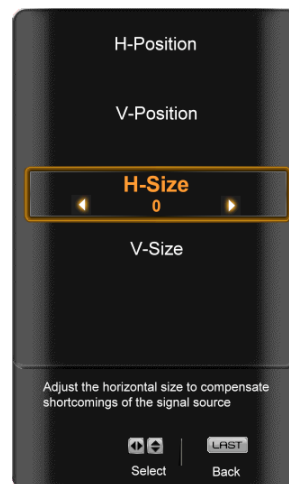

### Parental

If you want to restrict certain channel and program viewing, you can do this by turning on the Parental Control. Selected programs, movies and channels can then be made available only after an authorized password has been entered and accepted by the TV.

To select the options in the Parental sub-menu, press **OK**. Enter a password to access the Parental menu. The default password set in the factory is **0 0 0 0**.

**Note:** The Parental menu does not appear when the input mode is set to HDMI.

A new menu will be displayed showing the following Parental settings:

#### Rating Enable

Select from ON or OFF. If set to OFF, you will not be able to set the US TV, US Movie, Canadian English, or Canadian French Ratings.

#### Channel Block

Block individual channels from being displayed.

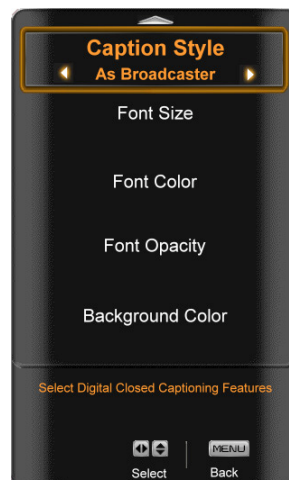
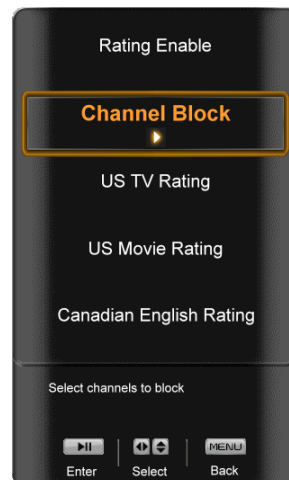



### US TV Rating

**Note:** When Rating Enable is OFF, US TV Rating adjustments are not available.

Press the OK button to block (locked) or allow (unlocked) channels by the following US TV ratings:

- Y – All children
- Y7 – Older children
- G – General audience
- PG – Guidance suggested
- 14 – Strongly cautioned
- MA – Mature audience

You can also customize the TV ratings for the following content:

- A – All sub-ratings
- D – Sexual dialog
- L – Adult language
- S – Sexual situations
- V - Violence
- FV – Fantasy violence

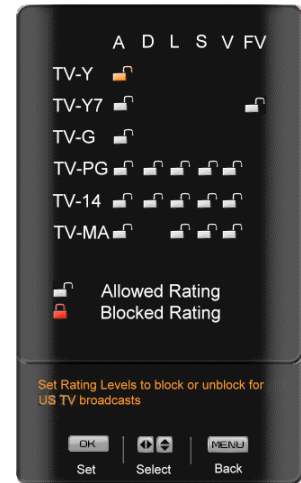

### US Movie Rating

**Note:** When Rating Enable is OFF, US Movie Rating adjustments are not available.

Press the **OK** button to block (locked) or allow (unlocked) channels by the following US Movie ratings:

- G – General audience
- PG – Parental guidance suggested
- PG-13 – Recommended for children 13 years of age or older
- R – Mature audience
- NC-17 – No one under 17 years of age
- X – No one under 17 years of age

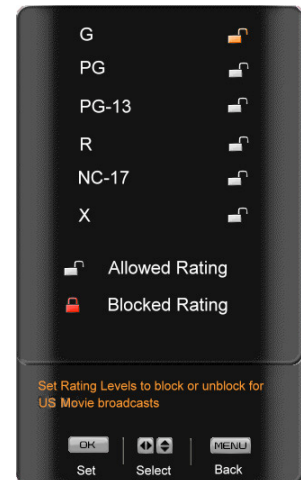

### Canadian English Rating

**Note:** When Rating Enable is OFF, Canadian English Rating adjustments are not available.

Press the **OK** button to block (locked) or allow (unlocked) channels by the following Canadian English ratings:

- C – Children
- C8+ – Children 8 years or older
- G – General Programming, suitable for all audiences
- PG – Parental guidance
- 14+ – Viewers 14 years or older
- 18+ – Adult programming



### Canadian French Rating

**Note:** When Rating Enable is OFF, Canadian French Rating adjustments are not available.

Press the **OK** button to block (locked) or allow (unlocked) channels by the following Canadian French ratings:

- G – General audience
- 8 ans+ – General – not recommended for young children
- 13 ans+ – Not suitable for children under 13 years of age
- 16 ans+ – Not suitable for under 16 years of age
- 18 ans+ – Adults only

### DTV Rating

This option updates the TV or Movie rating table for digital programs in your local or regional area. It will allow the parental guidance control feature in your TV to have the most current parental control database for a digital signal. If *Not Available* appears at the bottom of the menu, then no update is available (the option is not activated in your area). This option may be available in the future for activation.

### Block Unrated TV

Block programming that does not have a rating.

### Change the Password

Select Access Code Edit to enter a new, 4-digit password using the number buttons on the remote control. Enter it a second time to confirm you entered it correctly.

**Note:** Make sure you write down and store the new password in a secure place. The System Reset feature (following) does NOT reset the password.



### System Info

Display the technical information including model name, version and revision of firmware, source type, and resolution.

### System Reset

To select the options in the System Reset sub-menu, press the **OK** button or the **▶** button. A new menu will be displayed showing the following System Reset settings:

#### Setup Wizard

Use this function to return to the Initial Setup menu. Use this function if you want to have a guided setup when you move your TV. Please refer to Chapter 3 for more information.

**Note:** Previously scanned channels will be removed.

#### Reset All Settings

Use this function to reset the TV to the default factory settings.

The screen will display a message to confirm that you want to reset the values to factory settings.

**Note:** This does **NOT** reset the Parental Control Password.



## Understanding Viewing Features

Your HDTV features the following viewing modes. You can switch viewing modes using the remote control, please follow the instructions on page 14.

### Viewing Modes

#### Normal Mode

The original 4:3 aspect ratio (1.33:1 source) is preserved, so black bars are added to the left and right of the display image. Standard TV broadcasts are displayed with a 4:3 Aspect Ratio. Movies in 4:3 Aspect Ratio may be referred to as pan-and-scan or full frame. These movies were originally filmed in 16:9 (widescreen), and then modified to fit a traditional TV screen (4:3).

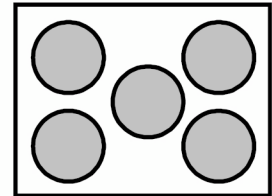

#### Full

Full mode allows you to view the entire picture. Recommended for HDMI and RGB / Computer viewing so you can see the complete picture without the image overstretching beyond the viewing area. If you experience “noise” along the border switch to Zoom 1. For 720p, 1080i, 1080p only.

#### Zoom 1

When watching a standard broadcast or full-frame movie in this mode, the display image is stretched proportionately to fill the TV screen. When watching a widescreen (1.78:1 source) program or movie, the display image fills the TV screen. If you are watching a widescreen (1.85:1 or 2.35:1 source) program or movie, there will still be black bars at the top and bottom.

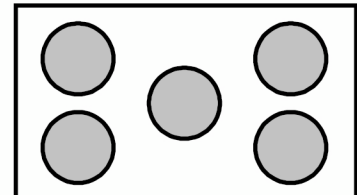

#### Zoom 2

Zooms in by 14% to crop the top and bottom bars for 2.35:1 film resolutions. For 480i/p, 4:3 only.

#### Stretch Mode

When watching a widescreen program (1.78:1 source) with black bars on the sides, the display image will stretch to fill the TV screen. People will appear wider than they really are. If you are watching a widescreen (1.85:1 or 2.35:1 source) program or movie, there will still be black bars at the top and bottom. This mode is available only when watching a widescreen program.

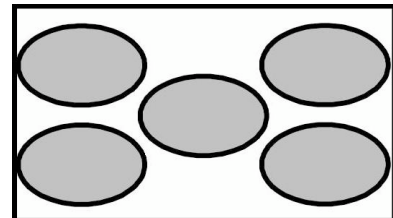

#### Panoramic Mode

When watching a standard broadcast or full frame movie in this mode, the 4:3 Aspect Ratio (1.33:1 source) display image is stretched horizontally on the left and right sides to fill the TV screen. The center of the image is not stretched.

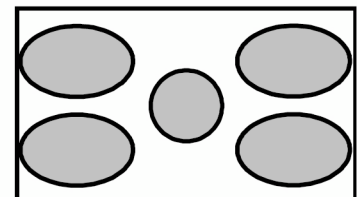

**Note:** When in PIP/POP the screen is fixed in Zoom1 mode.



## Chapter 6

# Programming the VIZIO Universal Remote Control

You can program the remote control to work with up to four different pieces of equipment including your VIZIO HDTV. Listed below are the steps for programming your VCR, Cable Box and DVD Player.

### Programming for VCR

1. Manually turn on the VCR.
2. Press the VCR button on the remote control.
3. Press and hold the SET button until the LED LIGHT flashes twice.
4. Find the programming code for your VCR in the code list in the back of this book and enter it using the Number Buttons. If the code is accepted, the LED flashes twice after the last digit is entered.  
If the LED does not flash twice, repeat Steps 2 through 4 with the next code listed for the component and manufacturer.
5. Point the remote control at the VCR and press the POWER button. The VCR will turn off.

#### Note:

- If your VCR does not respond, try all the codes for your VCR brand. If the codes do not work, or your brand is not listed, see "Searching for Component Codes."
- Sometimes a code listed will only include limited functions. Try other codes that may include more functionality.

### Programming for Cable Set-Top Box

1. Manually turn on the Cable Box.
2. Press the CBL button on the remote control.
3. Press and hold the SET button until the LED LIGHT flashes twice.
4. Find the programming code for your Cable Box in the code list in the back of this book and enter it using the Number Buttons. If the code is accepted, the LED flashes twice after the last digit is entered.  
If the LED does not flash twice, repeat Steps 2 through 4 with the next code listed for the component and manufacturer.
5. Point the remote control at the Cable Box and press the POWER button. The Cable Box will turn off.  
If the LED does not flash twice, repeat Steps 2 through 4 with the next code listed for the component and manufacturer.

#### Note:

- If your Cable Set-Top Box does not respond, try all the codes for your brand. If the codes do not work, or your brand is not listed, see "Searching for Component Codes."
- Sometimes a code listed will only include limited functions. Try other codes that may include more functionality.



## Programming for DVD Player

1. Manually turn on the DVD Player.
2. Press the DVD button on the remote control.
3. Press and hold the SET button until the LED LIGHT flashes twice.
4. Find the programming code for your DVD player in the code list in the back of this book and enter it using the Number Buttons. If the code is accepted, the LED flashes twice after the last digit is entered.  
If the LED does not flash twice, repeat Steps 2 through 4 with the next code listed for the component and manufacturer.
5. Point the remote control at the DVD Player and press the POWER button. The DVD Player will turn off.

### Note:

- If your DVD player does not respond, try all the codes for your brand. If the codes do not work, or your brand is not listed, see “Searching for Component Codes.”
- Sometimes a code listed will only include limited functions. Try other codes that may include more functionality.

## Searching for Component Codes

If you cannot find the manufacturer in the component list or the program code does not work, you can use the remote control to search for the correct component code.

To search for a component code:

1. Turn on the component.
2. Press the matching component button on the remote control.
3. Press and hold the SET button until the LED flashes twice.
4. Press 9 9 1. The LED flashes twice.
5. Point the remote control at the component and then alternate between pressing the POWER button and the component button on the remote control until the component turns off. If the component still does not respond, clear the component button, then repeat the search procedure.

## Using a Cable or Satellite Remote

Your VIZIO remote uses codes 000, 047, 050, 067, 329, 331 and 339 to work your LCD HDTV. To use a cable or satellite remote to work the LCD HDTV, refer to your cable or satellite remote user guide for more information on how to program the remote. If your cable or satellite remote uses a 5-digit code (like most Direct TV units), first try 11758 and then, if that does not work, 10178. If your cable or satellite remote uses a 4-digit code, try 1758 and then 0178 as an alternative. If your cable or satellite remote uses a 3-digit code (EchoStar or Dish Network for example), use code 627.

**Note:** Some buttons may not function as expected on your cable or satellite remote. Typically power, volume and mute will work.



## Chapter 7 Maintenance and Troubleshooting

### Maintenance

#### Important

1. Make sure that the power cable is removed from the socket before cleaning the TV.
2. Do not use volatile solvent (such as toluene, rosin and alcohol) to clean the TV. Such chemicals may damage the housing, screen glass and remote control, and cause paint to peel.

#### Cleaning the Housing and Remote Control

1. Use a soft cloth for cleaning.
2. If the housing or remote control is seriously contaminated, use a soft cloth moistened with diluted neutral cleaner to clean the display. Wring water out of the cloth before cleaning to prevent water from penetrating into the housing. Wipe the display with a dry cloth after cleaning.

#### Cleaning the Screen

1. Use a soft cloth to gently clean the screen.
2. The screen glass is very fragile. Do not scrape it with any sharp object. Do not press or tap the screen to avoid cracking. When the screen is seriously contaminated, use a soft cloth moistened with diluted neutral cleaner to clean the display. Wring water out of the cloth before cleaning to prevent water from penetrating into the housing. Wipe the display with a dry cloth after cleaning.



## Troubleshooting Guide

If the TV fails or the performance changes dramatically, check the display in accordance with the following instructions. Remember to check the peripherals to pinpoint the source of the failure. If the display still fails to perform as expected, contact the VIZIO for assistance by calling 1-877-MYVIZIO (698-4946) or e-mail us at [techsupport@vizio.com](mailto:techsupport@vizio.com).

General TV Problems	Solution
Receive the error message "No Signal."	<ul style="list-style-type: none"> <li>• Press the INPUT button on the remote control to select a different input source.</li> <li>• If you are using cable connected directly to the TV or an antenna, scan for channels from the Tuner menu in the OSD.</li> </ul>
No power.	<ul style="list-style-type: none"> <li>• Make sure the power button is ON (VIZIO logo glows white).</li> <li>• Make sure AC power cord is securely connected to the AC socket.</li> <li>• Plug another electrical device to the power outlet to verify that the outlet is working.</li> </ul>
No sound.	<ul style="list-style-type: none"> <li>• Press Volume + (Up) on the remote control.</li> <li>• Press MUTE on the remote control to make sure that MUTE is not ON.</li> <li>• Check your audio settings. The audio may be set to SAP, or the speakers are set to off.</li> <li>• Make sure that headphones are not connected.</li> <li>• Check the audio connections of external devices that may be connected to the HDTV.</li> <li>• If you are using an antenna, the signal strength of the channel may be low. Make sure your antenna is connected securely to the TV and move the antenna around the room or close to a window.</li> </ul>
If the screen is black.	<ul style="list-style-type: none"> <li>• Make sure the power button is ON (VIZIO Logo glows white).</li> <li>• Press the INPUT button on the remote control to select a different input source.</li> <li>• Check the connections of external devices that may be connected to the HDTV.</li> </ul>
Power is ON but there is no image on the screen.	<ul style="list-style-type: none"> <li>• Make sure all cables attached to the HDTV are connected to the correct output on the external device.</li> <li>• Adjust brightness, contrast or backlight.</li> <li>• Press the INPUT button on the remote control to select a different input source.</li> </ul>
Wrong or abnormal colors appear.	<ul style="list-style-type: none"> <li>• Check Color and Tint settings in Picture Menu.</li> <li>• Reset Picture settings.</li> <li>• Check the video cables to make sure they are securely connected.</li> <li>• If you are using an antenna, the signal strength of the channel may be low. Make sure your antenna is connected securely to the TV and move the antenna around the room or close to a window.</li> </ul>
Control buttons do not work.	<ul style="list-style-type: none"> <li>• Press only one button at a time.</li> </ul>
Remote control does not work.	<ul style="list-style-type: none"> <li>• Point the remote control directly at the remote sensor on your TV.</li> <li>• Remove any obstacles between the remote control and the remote sensor.</li> <li>• Replace dead batteries with new ones.</li> <li>• Make sure you have selected TV mode on the remote control.</li> </ul>
There appear to be image quality issues.	<ul style="list-style-type: none"> <li>• If you are using an antenna, the signal strength of the channel may be low. Make sure your antenna is connected securely to the TV and move the antenna around the room or close to a window.</li> <li>• For best image quality, view HD wide-screen programs where possible.</li> <li>• If HD content is not available view "Standard Definition" from a digital source.</li> </ul>



General TV Problems	Solution
	<ul style="list-style-type: none"> <li>Standard, analog TV will always be noticeably inferior to HD because your digital flat panel TV has video that is many times better than old TV so you will see interference and deficiencies you did not know you had.</li> </ul>
<p>You cannot see a picture.</p>	<ul style="list-style-type: none"> <li>Make sure the power button is ON (VIZIO logo glows white).</li> <li>Make sure AC power cord is securely connected to the AC socket.</li> <li>Press the INPUT button on the remote control to select a different input source.</li> <li>Check the connections of external devices that may be connected to the HDTV.</li> <li>If your HDTV is connected to a computer, press any button on your keyboard to “wake” your computer.</li> <li>If you are using an antenna, the signal strength of the channel may be low. Make sure your antenna is connected securely to the TV and move the antenna around the room or close to a window.</li> </ul>
<p>You see a distorted picture or hear unusual sound.</p>	<ul style="list-style-type: none"> <li>You may be getting interference from electrical appliances, cars, motorcycles, or fluorescent lights. If you have not mounted it on the wall, try moving your HDTV to another location to see if this is the cause of the problem.</li> </ul>
<p>The picture has abnormal patterns.</p>	<ul style="list-style-type: none"> <li>Check the connections of external devices that may be connected to the HDTV.</li> <li>Make sure the specifications of external devices meet the specifications of your HDTV (i.e. resolution).</li> <li>If you are using an antenna, the signal strength of the channel may be low. Make sure your antenna is connected securely to the TV and move the antenna around the room or close to a window.</li> </ul>
<p>The display image does not cover the entire screen.</p>	<ul style="list-style-type: none"> <li>If you are in RGB mode (Computer), make sure that H-Size and V-Position in the On Screen Display (OSD) are set correctly.</li> <li>If you are using TV, AV, or Component with 480i input, press WIDE button on the remote control to scroll through various screen modes.</li> </ul>
<p>You can see a picture but you cannot hear sound.</p>	<ul style="list-style-type: none"> <li>Press Volume + (Up) on the remote control.</li> <li>Press MUTE on the remote control to make sure that MUTE is not ON.</li> <li>Check your audio settings. The audio may be set to SAP, or the speakers are set to off.</li> <li>Make sure that headphones are not connected.</li> <li>Check the audio connections of external devices that may be connected to the HDTV.</li> </ul>
<p>The TV has pixels (dots) that are always dark or colored.</p>	<ul style="list-style-type: none"> <li>Your HDTV is manufactured using an extremely high level of precision technology, however, sometimes some pixels of your HDTV may not display. Pixel defects within industry specifications are inherent to this type of product and do not constitute a defective product.</li> </ul>
<p>You see “noise” or “trash” on the screen.</p>	<ul style="list-style-type: none"> <li>When your HDTV’s digital capabilities exceed a digital broadcast signal, the signal is up-converted (increased) to match your TV’s display capabilities. Up-converting can cause noise or trash.</li> <li>If you are using an antenna, the signal strength of the channel may be low. Make sure your antenna is connected securely to the TV and move the antenna around the room or close to a window.</li> </ul>
<p>You switch to a different input and the volume changes.</p>	<ul style="list-style-type: none"> <li>The TV remembers the volume level from the last time you adjusted it. If the sound level is higher or lower from another source, then the volume will change.</li> </ul>
<p>You switch to a different input and the screen size changes.</p>	<ul style="list-style-type: none"> <li>The TV remembers the viewing mode from the last time you used a particular input (AV-1, AV-2, Component, HDMI and TV).</li> </ul>
<p>Tips for High-Definition Users.</p>	<ul style="list-style-type: none"> <li>Your HDTV is an ideal platform for viewing High Definition Content.</li> <li>Best image quality will be achieved by HDMI. The next best is Component,</li> </ul>





General TV Problems	Solution
	followed by Composite. <ul style="list-style-type: none"> <li>• Due to variances in broadcast practices, it is possible some image distortions can occur.</li> </ul>
Tips for Letterbox Content Users.	<ul style="list-style-type: none"> <li>• Some Letterboxed (or “Widescreen”) versions of DVD movies are formatted for standard 4:3 Televisions. Your HDTV has the ability to expand this content so the entire screen is filled at the expense of image accuracy. To use this function, press ZOOM on the remote control to cycle among the options.</li> </ul>

Media Viewer Problems	Solution
USB device is not recognized.	<ul style="list-style-type: none"> <li>• Make sure the device is correctly inserted.</li> <li>• Make sure the device is FAT or FAT32</li> <li>• Make sure it contains the supported files.</li> </ul>
Image or sound is interrupted or distorted.	<ul style="list-style-type: none"> <li>• Make sure the device is correctly inserted.</li> <li>• Make sure that the file complies with the supported format, bit rate and/or profile. Also check the file for damage.</li> <li>• Some files that comply with the supported format may not play back or display properly.</li> </ul>
Slideshow doesn't start.	<ul style="list-style-type: none"> <li>• Make sure the viewer isn't in pause, rotation, or zoom mode.</li> </ul>

## Telephone & Technical Support

Products are often returned due to a technical problem rather than a defective product that may result in unnecessary shipping charges billed to you. Our trained support personnel can often resolve the problem over the phone. For more information on warranty service or repair, after the warranty period, please contact our Support Department at the number below.

Customer support and quality service are integral parts of VIZIO's commitment to service excellence. For technical assistance contact our VIZIO Technical Support Department via email or phone.

Email: [techsupport@vizio.com](mailto:techsupport@vizio.com)

(877) 698-4946 Fax: (949) 585-9563

Hours of operation: Monday - Friday: 6 am to 9 pm

Saturday – Sunday: 8 am to 4 pm

Please have your VIZIO model number, serial number, and date of purchase available before you call.

**VIZIO**

Address:

39 Tesla

Irvine, CA 92618, USA

Telephone: (949) 428-2525 Fax: 949-585-9514

Web: [www.vizio.com](http://www.vizio.com)



## Compliance

Caution: Always use a power cable that is properly grounded. Please use the AC cords listed below for each area.

USA	UL
Canada	CSA
Germany	VDE
UK	BASE/BS
Japan	Electric Appliance Control Act

## FCC Class B Radio Interference Statement

NOTE: This equipment has been tested and found to comply with the limits for a Class B digital device, pursuant to Part 15 of the FCC Rules. These limits are designed to provide reasonable protection against harmful interference in a residential installation. This equipment generates, uses and can radiate radio frequency energy, and if not installed and used in accordance with the instructions, may cause harmful interference to radio communications. However, there is no guarantee that interference will not occur in a particular installation. If this equipment does cause harmful interference to radio or television reception, which can be determined by turning the equipment off and on, the user is encouraged to try to correct the interference by one or more of the following measures:

1. Reorient or relocate the receiving antenna.
2. Increase the separation between the equipment and receiver.
3. Connect the equipment into an outlet on a circuit different from that to which the receiver is connected.
4. Consult the dealer or an experienced radio/TV technician for help.

Notice:

1. The changes or modifications not expressly approved by the party responsible for compliance could void the user's authority to operate the equipment.
2. Shielded interface cables and AC power cord, if any, must be used in order to comply with the emission limits.
3. The manufacturer is not responsible for any radio or TV interference caused by unauthorized modification to this equipment. It is the responsibilities of the user to correct such interference.



## Chapter 8 Specifications

Specifications			
Panel	<b>SV320XVT:</b> 31.55" Diagonal, 16:9 Aspect Ratio <b>SV370XVT:</b> 37" Diagonal, 16:9 Aspect Ratio		
Resolution	1920 x 1080 pixels		
Pixel (Dot) Pitch	<b>SV320XVT:</b> 0.36375mm(H) x 0.36375mm(V) <b>SV370XVT:</b> 0.42675mm(H) x 0.42675mm(V)		
Display Compatibility	HDTV (1080P)		
Colors	1.06 Billion		
Brightness cd/m <sup>2</sup> (typical)	500nits		
Contrast	<b>SV320XVT:</b> 1200:1; DCR: 50,000:1 <b>SV370XVT:</b> 1300:1; DCR: 50,000:1		
Response Time	<b>SV320XVT:</b> 6ms (typical) <b>SV370XVT:</b> 5ms (typical)		
Viewing Angle	178° (horizontal/vertical)		
Inputs	<table border="0"> <tr> <td style="vertical-align: top;">                     1x RF                      1x Composite Video and stereo audio (one stereo audio shared with Component input)                      1x S-Video                 </td> <td style="vertical-align: top;">                     1x Component and stereo audio (one stereo audio shared with Composite input)                      3x HDMI                      1x RGB                      1x Media Port (USB)                 </td> </tr> </table>	1x RF 1x Composite Video and stereo audio (one stereo audio shared with Component input) 1x S-Video	1x Component and stereo audio (one stereo audio shared with Composite input) 3x HDMI 1x RGB 1x Media Port (USB)
1x RF 1x Composite Video and stereo audio (one stereo audio shared with Component input) 1x S-Video	1x Component and stereo audio (one stereo audio shared with Composite input) 3x HDMI 1x RGB 1x Media Port (USB)		
Outputs	1x SPDIF Optical Digital Audio, 1x Stereo Audio		
Features	1080P HDTV, MEMC, 120Hz Panel, HDMI v1.3, 3D Comb Filter, Digital Audio Amplifier, Dolby Digital for ATSC/QAM, Signal Compatibility: 480I(SDTV), 480P(EDTV), 720P(HDTV), 1080I(HDTV), 1080P(HDTV), Channel Skip/Add, VIDEO/INPUT Naming Capability, Closed Caption, Parental Control/V-CHIP 2.0, Programmable Timer, Freeze, PIP/POP, SRS TSHD, SRS TruVolume, Zero Bright Pixel Guarantee, Dynamic Contrast Ratio Technology, HD Game Port, Game Mode, Noise Reduction, 10-bit(D) panel, 10-bit video processing, MTS Stereo Decoder, Dolby Digital for ATSC/QAM, VESA Mount Compatible. ATSC/Clear QAM tuner, NTSC video decoding, 3:2 or 2:2 reverse pull-down, Motion adaptive de-interlace, Progressive video scan via Component/VGA/HDMI, HDTV via HDMI or Component, Color temperature adjustments of 6500K/9300K/11000K, Independent Red/Green/Blue adjustments for color temperature fine tuning, Computer support at 640x480/800x600/1360x768/1920x1080 via VGA/HDMI.		
Special Features	<ul style="list-style-type: none"> <li>• Detachable Base</li> <li>• Mega DCR</li> <li>• MEMC, 120Hz Panel</li> <li>• SRS TruVolume, SRS TSHD</li> <li>• Optimal power control to reduce average power consumption</li> </ul>		
Speakers	2xBuilt-in, 10W Speakers		
Panel Life	50,000 hours to half the original brightness		



Power	
Input	IEC Connector for direct power line connection
Voltage Range	100~240Vac at 50/60Hz
Power Consumption	<b>SV320XVT:</b> 98W (Avg), <0.5W standby <b>SV370XVT:</b> 125W (AVG) , <0.5W standby
Environmental Conditions	
Operating	Temperature: 5°C~35°C, Relative Humidity: 20~80%, Altitude: 0~14,000 ft
Non-Operating	Temperature: -20°C~50°C, Relative Humidity: 10~70%, Altitude: 0~40,000 ft
Dimensions	<b>SV320XVT:</b> 30.6"W x 22.4" H x 9.3" D with stand; 30.6" W x 22.1" H x 2.2" D without stand <b>SV370XVT:</b> 35.6"W x 24.8" H x 9.3" D with stand; 35.6" W x 23.1"H x 2.2" D without stand
Net Weight	<b>SV320XVT:</b> 23.2 lbs without stand, 25.4 lbs with stand <b>SV370XVT:</b> 28.7 lbs without stand, 30.5 lbs with stand
Gross Weight	<b>SV320XVT:</b> 30.86 lbs <b>SV370XVT:</b> 37.04 lbs
Certifications	CSA, CSA-US, FCC Class B
Compliances	Energy Star 3.0. ATSC Spec A/65, EIA/CEA-766-A

\*Product specifications may change without notice or obligation.

**Note:** The Federal Communications Commission (FCC), the Consumer Electronics Association (CEA) and the Consumer Electronics Retailers Coalition (CERC) have made a new tip sheet available for digital television (DTV) retailers to reproduce and distribute to consumers on the sales floor. The file may be downloaded online at [www.dtv.gov](http://www.dtv.gov). While you're there, check out the other useful information in the FCC is making available to consumers interested in learning more about the analog to digital transition.



## Remote Control Codes

Cable Box Codes (including Cable / PVR Boxes)	
A-Mark	00008, 00144
ABC	00237, 00003, 00008, 00014, 00017
Accuphase	00003, 00014, 00017
Acorn	00237
Action	00237
Active	00237
Americast	00899
Amino	01822
Archer	00237
BCC	00276
Bell & Howell	00014
Bell South	00899
British Telecom	00003
Century	00008
Citation	00017
Clearmaster	00883
ClearMax	00883
Cool Box	00883
Coolmax	00883
Digeo	01187
Digi	00637
Director	00476
Dumont	00637
DX Antenna	01500
Emerson	00014
Fosgate	00276
Fujitsu	01497
GE	00144
General Instrument	00476, 00810, 00276, 00003, 00012, 00014
Gibraltar	00003
GMI	00883

Cable Box Codes (including Cable / PVR Boxes)	
GoldStar	00144
Hamlin	00009, 00273
Hitachi	00003, 00008, 00009
Insight	00476, 00810
Jebsee	00014
Jerrold	00476, 00810, 00276, 00003, 00012, 00014
Maspro	01510
Memorex	00000
Mitsubishi	00003
Motorola	01376, 00476, 00810, 00276, 01187, 01254, 00014, 01106
Multitech	00883
Myrio	01822
NEC	01496
Nova Vision	00008
Novaplex	00008, 00017
NSC	00012, 00637
Oak	00017
Pace	01877, 00877, 00237, 00008
Panasonic	00000, 00008, 00144, 00107, 01488
Panther	00637
Paragon	00000, 00008, 00525
Penney	00000, 00637
Philips	01305, 00317
Pioneer	01877, 00877, 00144, 00533, 01500
Prism	00012
Pulsar	00000
Quasar	00000

Cable Box Codes (including Cable / PVR Boxes)	
RadioShack	00883
RCA	01256
Regal	00276, 00279, 00273
Runco	00000
Samsung	00003, 00144
Scientific Atlanta	01877, 00877, 00477, 00237, 00003, 00000, 00008, 00012, 00000, 00525, 00899, 00017
Sony	01006, 01460
Sprucer	00144
Starcom	00003, 00014
Stargate	00014
Storm	00637
Sumitomo	01500
Supercable	00276
Supermax	00883
Thomson	01256
Tocom	00012
Torx	00003
Toshiba	00000, 01509
Tristar	00883
United Cable	00276, 00003, 00014
US Electronics	00276, 00003, 00008, 00017
V2	00883
Videoway	00000
Viewmaster	00883
Vision	00883
Vortex View	00883
Zenith	00000, 00525, 00899, 00017



Satellite Receiver Codes (including Sat / PVR Boxes)	
Aiwa	01514
AlphaStar	00772
Bell ExpressVu	00775
Chaparral	00216
Coolsat	01806
Crossdigital	01109
DirectTV	01377, 00392, 00566, 00639, 01639, 01142, 00247, 00749, 01749, 00724, 00819, 01856, 01076, 01108, 00099, 01109, 01392, 01414, 01442, 01443, 01444, 01609, 01640
Dish Network System	01505, 01005, 00775, 01170, 01775
Dishpro	01505, 01005, 00775, 01775
DX Antenna	01530
Echostar	01505, 01005, 00775, 01170, 01775
Expressvu	00775, 01775
Fortec Star	01821
Funai	01377
GE	00392, 00566
General Instrument	00869
GOI	00775, 01775
Hisense	01535
Hitachi	00749, 00819, 01518
Houston	00775
HTS	00775, 01775
Hughes Network Systems	01142, 00749, 01749, 01442, 01443, 01444, 20739
Humax	01790

Satellite Receiver Codes (including Sat / PVR Boxes)	
iLo	01535
Innova	00099
Jerrold	00869
JVC	00775, 01170, 01507, 01775
LG	01226, 01414
Magnavox	00724, 00722
Maspro	01530
McIntosh	00869
Memorex	00724
Mitsubishi	00749
Motorola	00869
NEC	01519
Netsat	00099
Next Level	00869
Optimus	00724
Panasonic	00247, 00701, 01508
Pansat	01807
Paysat	00724
Philips	01142, 00749, 01749, 00775, 00724, 00819, 01076, 00722, 00099, 01442, 20739
Pioneer	01142, 01442
Primestar	00869
Proscan	00392, 00566
Proton	01535
RadioShack	00566, 00775, 00869
RCA	00392, 00566, 01142, 00775, 00855, 00143, 01392, 01442
Samsung	01377, 01142, 01276, 01108, 01109, 01442, 01609, 20739
Sharp	01489

Satellite Receiver Codes (including Sat / PVR Boxes)	
SKY	00099
Sony	00639, 01639, 01524, 01640
Star Choice	00869
Star Trak	00772, 00869
Thomson	00392, 00566
Tivo	01142, 01442, 01443, 01444
Toshiba	00749, 01749, 00790, 00819, 01285, 01501, 01530
UltimateTV	01392, 01640
Ultrasat	01806
Uniden	00724, 00722
US Digital	01535
USDTV	01535
Voom	00869
Zenith	01856

PVR Codes	
ABS	21972
Alienware	21972
CyberPower	21972
Dell	21972
DirectTV	20739
Gateway	21972
Hewlett Packard	21972
Howard Computers	21972
Hughes Network Systems	20739
Humax	20739
Hush	21972
iBUYPOWER	21972
Linksys	21972
Media Center PC	21972
Microsoft	21972



PVR Codes	
Mind	21972
Niveus Media	21972
Northgate	21972
Panasonic	20616
Philips	20618, 20739
RCA	20880
ReplayTV	20614, 20616
Samsung	20739
Sonic Blue	20614, 20616
Sony	20636, 21972
Stack 9	21972
Systemax	21972
Tagar Systems	21972
Tivo	20618, 20636, 20739
Toshiba	21008, 21972, 21996
Touch	21972
Viewsonic	21972
Voodoo	21972
ZT Group	21972

Blu-Ray DVD Player Codes	
Insignia	22428
Panasonic	21641
Philips	22084
Pioneer	20142
Samsung	20199
Sharp	22250
Sony	21516
Vizio	22553

DVD / PVR Combo Codes	
Emerson	20675, 20000
Go Video	21730
Hitachi	21764
Mitsubishi	21403
Panasonic	20490, 21632
Pioneer	20631
RCA	20522, 20880
Sharp	20630, 21256, 21642
Sony	21033
Sylvania	20675, 20000
Toshiba	21503, 21639, 21008, 21996
Victor	21597

DVD Player Codes	
3D LAB	20503, 20539
Accurian	21072, 21416
Acoustic Solutions	20730
Advent	21016
Afreey	20698
Aiwa	20641
Akai	20695, 20705, 20770, 20899, 21089
Alba	20672, 20717
Alco	20790
Allegro	20869
Amphion Media Works	20872
AMW	20872
Apex Digital	20533, 20672, 20717, 20755, 20794, 20796, 20797, 20830, 21004, 21020, 21056, 21061, 21100
Arrgo	21023

DVD Player Codes	
Aspire Digital	21168, 21407
Audiovox	20717, 20790, 21041, 21071, 21072, 21121, 21122
Awa	20730
Axion	21071, 21072
Blaupunkt	20717
Blue Parade	20571
Blue Sky	20695
Bose	21895
Brandt	20651
Broksonic	20695, 20868
Byd:sign	20872
California Audio Labs	20490
Celestial	21020
Centrex	20672, 21004
Cinea	20831
CineVision	20876, 20833, 20869
Citizen	21003, 21277
Clairtone	20571
Coby	20778, 21086, 21107, 21177
Craig	20831
Creative	20503, 20539
Curtis Mathes	21087
CyberHome	20816, 20874, 21023, 21024, 21117, 21129, 21502
Cytron	20705
Daewoo	20784, 20705, 20770, 20833, 20869, 21169, 21172, 21234, 21242
Dansai	20770
Daytek	20872
Decca	20770
Denon	20490, 20634



DVD Player Codes	
Denver	20778
Desay	21407
Digitrex	20672
Disney	20675, 21270
DiViDo	20705
Dual	20675, 21068, 21085
Durabrand	21127
DVD2000	20521
Electrohome	21003
Emerson	20591, 20675, 20821, 21268
Enterprise	20591
Entivo	20503, 20539
Enzer	20770
ESA	20821, 21268
Firstline	20651
Fisher	20670
Funai	20675, 21268, 21334
Gateway	21073, 21158
GE	20522, 20815, 20717
Go Video	20573, 20744, 20717, 20715, 20741, 20783, 20833, 20869, 21044, 21075, 21099, 21158, 21304, 21730
Go Vision	21071, 21072
GoldStar	20741, 20801, 20869
Goodmans	20790
Gradiente	20490, 20651
Greenhill	20717
Grundig	20539, 20705
Harman/Kardon	20582, 20702
Hitachi	20573, 20664, 21247, 21764
Hiteker	20672

DVD Player Codes	
Humax	21588
iLo	21348
Initial	20717
Insignia	21268
Integra	20571, 20627
IRT	20783
JBL	20702
Jensen	21016
JMB	20695
JVC	20558, 20623, 20867, 21164
Kawasaki	20790
Kenwood	20490, 20534
KLH	20717, 20790, 21020, 21149
Kloss	20533
Koss	20651, 21061
Lasonic	20627, 20798
Lecson	21533
Lenoxx	21127
LG	20591, 20741, 20801, 20869
LiteOn	21058, 21158, 21416, 21440
Loewe	20511, 20741
Logix	20783
Magnasonic	20651, 20675
Magnavox	20503, 20539, 20646, 20675, 20821, 21268
Malata	20782, 21159
Marantz	20503, 20539, 20675
McIntosh	21533
Medion	20651
Memorex	20695, 20831, 21270
Microsoft	20522, 21708
Minato	20752
Mintek	20839, 20717

DVD Player Codes	
Mitsubishi	21521, 20521, 21403
Momitsu	21082
Mustek	20730
NAD	20591, 20741
Naiko	20770
NEC	20785, 20869
Nesa	20717
NexxTech	21402
Norcent	21003, 20872, 21107, 21265
Onkyo	20503, 20627, 20792
Optimus	20571
Oritron	20651
Palsonic	20672
Panasonic	20503, 20490, 20571, 20703, 21362, 21462, 21490, 21632, 21762
Philips	20503, 20539, 20646, 20675, 20854, 21260, 21267, 21354
PianoDisc	21024
Pioneer	20525, 20571, 20631
Polaroid	21020, 21061, 21086
Polk Audio	20539
Portland	20770
Presidian	20675, 21072
Prima	21016
Proceed	20672
Proscan	20522
ProVision	20778
Qwestar	20651
Radionette	20741
RadioShack	20571
RCA	20522, 20571, 20717, 20790,





DVD Player Codes	
	20822, 21022, 21132
Realistic	20571
Reoc	20752
Rio	20869
Rotel	20623
Rowa	20823, 21004
Saba	20651
Sampo	20698, 20752
Samsung	20490, 20573, 20744, 20820, 20899, 21044, 21075
Sansui	20695
Sanyo	20670, 20675, 20695, 20873, 21334
Schneider	20783
Schwaiger	20752
Sensory Science	21158
Sharp	20630, 20675, 20752, 21256, 21642
Sharper Image	21117
Sherwood	20770, 21043
Shinsonic	20533, 20839
Slim Art	20784
SM Electronic	20730
Sonic Blue	20573, 20715, 20783, 20869, 21099
Sony	20533, 21533, 20864, 21033, 21070, 21431
Sova	21122
Superscan	20821
SVA	20717, 20860
Sylvania	20675, 20821, 21268
Symphonic	20675, 20821, 21268, 21334
Tatung	20770

DVD Player Codes	
Teac	20571, 20717, 20790
Technics	20490, 20703
Technika	20770
Technosonic	20730
Tevion	20651
Theta Digital	20571
Thomson	20522, 20511
Tivo	21503, 21588
Toshiba	20503, 20573, 20539, 20695, 21045, 21154, 21503, 21588, 21639
Tredex	20800
Unimax	20770
United	20730
Universum	20591
Urban Concepts	20503, 20539
US Logic	20839
V	21064, 21226
Venturer	20790
Victor	21597
Vizio	21064, 21226
Xbox	20522, 21708
Yamaha	20490, 20539, 20545
Yamakawa	20872
Zenith	20503, 20591, 20741, 20869
Zeus	20784
Zoece	21265

Amplifier / Receiver / Tuner Codes	
ADC	30531
Adcom	30616
Aiwa	31405, 30189, 30121, 31388, 31641
Akai	30244, 31512
Alco	31390
AMC	31077
Amphion Media Works	31563, 31615
AMW	31563, 31615
Anam	31609, 31074
Apex Digital	31257, 31430, 31774
Arcam	31189
Audiotronic	31189
Audiovox	31390, 31627
B & K	30701, 30702, 30820, 30840
BK	30702
Bose	31229, 30639, 31253, 31841, 31933
Brix	31602
Cairn	30189
Cambridge Soundworks	31370
Capetronic	30531
Carver	31189, 30189, 30121, 31289
Classic	31352
Coby	31389
Criterion	31420
Curtis Mathes	30014
Daewoo	31250
Delphi	31414
Denon	31360, 30121, 30771, 31142, 31306
Emerson	30531



Amplifier / Receiver / Tuner Codes	
Fisher	31801
Garrard	30463
Gateway	31517
Go Video	31532
Grundig	30189
Harman/Kardon	30110, 30189, 30891, 31289, 31304, 31306
Hitachi	31273, 31801
Initial	31426
Inkel	30491
Insignia	31030
Integra	30135, 30842, 31298, 31320
JBL	30110, 31306
JVC	31058, 30074, 31374, 31495, 31811
Kawasaki	31390
Kenwood	31313, 31570, 31569, 30186
KLH	31390, 31412, 31428
Koss	31366, 31497
Lasonic	31798
Lenoxx	31437
Lexicon	31076
LG	31293
Linn	30189
Liquid Video	31497
Magnavox	31189, 31269, 30189, 30391, 30531, 31266, 31514
Marantz	31189, 31269, 30189, 30891, 31289
McIntosh	31289
Micromega	31189, 30189
Mitsubishi	31393
Myryad	31189

Amplifier / Receiver / Tuner Codes	
Nakamichi	31313, 30097
New Castle	30502
Norcent	31389
Nova	31389
Onkyo	30135, 30380, 30842, 31298, 31320, 31531
Optimus	31023, 30074, 30014, 30121, 30186, 30502, 30531, 30670, 31074
Oritron	31366, 31497
Outlaw	30391
Panasonic	31308, 31518, 30309, 30367, 31288, 31316, 31548, 31633, 31763, 31764
Philips	31189, 31269, 30189, 30391, 30891, 31266
Pioneer	31023, 30014, 30150, 30244, 30531, 30630, 31384
Polaroid	31508
Polk Audio	30189, 31289, 31414
Proscan	31254
RadioShack	31609
RCA	31023, 31609, 31254, 30531, 31074, 31390, 31511
Realistic	31609, 30121, 30186
Regent	31437
Revox	30189
Rio	31869
Saba	31519
Samsung	31295, 31304, 31500
Sansui	31189, 30189,

Amplifier / Receiver / Tuner Codes	
	31764
Sanyo	31251, 31469, 31801
Sharp	30186, 30771, 31286
Sharper Image	31556
Sherwood	30491, 30502, 31077, 31423, 31517, 31653
Shinonic	31426
Sirius	31602, 31627, 31811, 31987
Sonic Blue	31532, 31869
Sony	31058, 31441, 31258, 31759, 31622, 30168, 30474, 31406, 31558, 31658, 31758, 31858
Soundesign	30670
Stereophonics	31023
Sunfire	31313
Teac	30463, 31074, 31390, 31528
Technics	31308, 31518, 30309, 31384, 31633
Thorens	31189
Toshiba	30135, 30842, 31788
Venturer	31390
Victor	30074
Waitec	31352
Wards	30189, 30014
XM	31406, 31414
Yamaha	31023, 30176, 30186, 31176, 31276, 31331, 31375, 31476
Zenith	30857, 31293



Audio Accessory Codes	
Accurian	31106
Altec Lansing	31056, 31485
Apple	31115, 31644
Cambridge Soundworks	31530
Creative	30872
D-Link	31522
Imerge	31491
Integra	31789
iPort	31917
Marantz	31491
Motorola	31464
NaviPod	31644
Netgear	31785
Omnifi	31605
Onkyo	31789
Roku	31828
Russound	32019
Slim Devices	31844
Sonance	31917
SSI	31522
Vizio	31517, 32454
Yamaha	31809, 31810

VCR Codes	
A-Mark	20037, 20240, 20000, 20278, 20046
ABS	21972
Admiral	20060, 20048, 20039, 20047, 20104, 20209, 20020, 20062, 20479
Adventura	20037, 20240, 20000
Adyson	20072
Aiko	20278
Aiwa	20037, 20000, 20124, 20307,

VCR Codes	
	20479
Akai	20041, 20061, 20106, 20175
Alba	20209, 20072, 20278
Alienware	21972
Allegro	20039
America Action	20278
American High	20035, 20081
Amstrad	20000
Asha	20240
Astra	20035, 20240
Audiovox	20037, 20278, 20038
Avis	20000, 20072
Beaumark	20240
Bell & Howell	20035, 20048, 20039, 20000, 20104, 20046, 20479
Broksonic	20184, 20121, 20209, 20002, 20208, 20479, 21479
Calix	20037
Candle	20037, 20038
Canon	20035
Capehart	20002, 20020, 20062
Carrera	20240
Carver	20035, 20081
CCE	20072, 20278
Cineral	20278
Citizen	20035, 20037, 20240, 20000, 20209, 20278, 20479, 21278
Classic	20037
Colortyme	20060, 20035, 20045, 20278
Colt	20000, 20072
Craig	20037, 20047, 20240, 20072,

VCR Codes	
	20271
Criterion	20000, 20072
Crosley	20035, 20081, 20000, 20149
Crown	20072, 20278
Curtis Mathes	20060, 20035, 20162, 20240, 20000, 20041, 20278, 20432, 20760, 21035
Cybernex	20240
CyberPower	21972
Daewoo	20037, 20045, 20278, 20020, 20046, 20561, 21278
Daytron	20037, 20278, 20020
Dell	21972
Denon	20081, 20042
Derwent	20041
DirectTV	20739
Dual	20000
Durabrand	20039, 20038
Dynatech	20240, 20000
Electrohome	20060, 20037, 20240, 20000, 20043, 20209, 20061
Electrophonic	20037
Emerald	20184, 20121
Emerex	20032
Emerson	20037, 20184, 20240, 20000, 20121, 20043, 20209, 20002, 20278, 20202, 20208, 20061, 20479, 20561, 20593, 21278, 21479, 21593
Fisher	20039, 20047, 20000, 20104, 20046
Fuji	20035, 20033
Fujitsu	20045, 20000



VCR Codes	
Funai	20037, 20000, 20072, 20278, 20593, 21593
Garrard	20000
Gateway	21972
GE	20060, 20035, 20048, 20240, 20000, 20149, 20202, 20760, 20807, 21035, 21060
Gemini	20060
General	20045
Genexxa	20037, 20000, 20278
Go Video	20240, 20432, 20526, 20614
GoldStar	20035, 20037, 20039, 20000, 20278, 20038, 21237
Goodmans	20037, 20081, 20000, 20072, 20278, 20020, 20062
Gradiente	20000, 20008
Granada	20081, 20042
Grundig	20081
Harley Davidson	20000
Harman/Kardon	20081, 20038
Harvard	20072
Harwood	20072
Headquarter	20046
Hewlett Packard	21972
HI-Q	20035, 20047, 20000
Hitachi	20035, 20037, 20045, 20000, 20042, 20041, 20089, 20105, 21037
Howard Computers	21972
Hughes	Systems

VCR Codes	
Network	20042, 20739
Humax	20739
Hush	21972
Hytek	20047, 20000, 20072
iBUYPOWER	21972
ITT Nokia	20240, 20041
Janeil	20240
Jensen	20067, 20041
JVC	20067, 20041, 20008, 20061, 21162
KEC	20037, 20278
Kenwood	20067, 20041, 20038, 20046
KLH	20072
Kodak	20035, 20037
KTV	20000
LG	20037, 20240, 20038, 21037
Linksys	21972
Lloyd's	20240, 20000, 20072, 20038, 20208
Loewe	20081
Logik	20240, 20000, 20072
Lumatron	20278
Luxor	20046, 20106
LXI	20037, 20000, 20042, 20067
M Electronic	20240
Magnasonic	20037, 20240, 20000, 20072, 20278, 20020, 20593, 21278
Magnavox	20035, 20037, 20048, 20039, 20081, 20240, 20000, 20149, 20563, 20593, 20618, 21593, 21781
Magnin	20240

VCR Codes	
Marantz	20035, 20081, 20038, 20062
Marta	20037
Matsui	20037, 20209
Matsushita	20035, 20162, 20081, 21162
Media Center PC	21972
MEI	20035
Memorex	20035, 20162, 20037, 20048, 20039, 20047, 20240, 20000, 20104, 20209, 20072, 20278, 20062, 20046, 20307, 20479, 21037, 21162, 21237, 21262
Metz	20037
MGA	20060, 20240, 20043, 20061
MGN Technology	20240
Microsoft	21972
Midland	20240
Mind	21972
Minolta	20042, 20105
Mitsubishi	20060, 20048, 20047, 20000, 20042, 20067, 20043, 20041, 20061, 20807
Motorola	20035, 20048
Movie Walker	20072
MTC	20240, 20000, 20072
MTX	20000
Multitech	20039, 20000, 20072
NAD	20240, 20104
NEC	20104, 20067, 20041, 20038
New Tech	20072
Nikko	20037, 20278



VCR Codes	
Nikkodo	20037, 20278
Nishi	20240
Niveus Media	21972
Noblex	20240
Northgate	21972
Olympus	20035, 20162, 20104
Onkyo	20222
Optimus	21062, 20035, 20162, 20037, 20048, 20047, 20240, 20000, 20104, 20062, 20432, 20593, 21048, 21162, 21262
Optonica	20062
Orion	20184, 20240, 20000, 20104, 20121, 20209, 20002, 20278, 20208, 20479, 21479
Panama	20035
Panasonic	21062, 20035, 20162, 20000, 20020, 20225, 20614, 20616, 21035, 21162, 21262
Penney	20035, 20162, 20037, 20047, 20081, 20240, 20000, 20042, 20067, 20038, 21035, 21237
Pentax	20042, 20105
Philco	20035, 20081, 20000, 20209, 20479
Philips	20035, 20162, 20048, 20081, 20045, 20000, 20209, 20062, 20616, 20618, 20739, 21081, 2118
Pilot	20037
Pioneer	20162, 20081,

VCR Codes	
	20042, 20067
Polk Audio	20081
Portland	20278, 20020
Presidian	21593
Profitronic	20240
Proscan	20060, 20202, 20760, 21060
Protec	20000, 20072
Protech	20072
Pulsar	20039, 20240, 20278
Pulser	20240
Quarter	20046
Quartz	20035, 20047, 20046
Quasar	20035, 20162, 20002, 21035, 21162
RadioShack	20035, 20162, 20037, 20048, 20047, 20240, 20000, 20104, 20046, 20062, 21037, 21162
Radix	20037
Randex	20037
RCA	20060, 20035, 20048, 20240, 20045, 20000, 20042, 20149, 20105, 20106, 20202, 20760, 20807, 20880, 21035, 21060
Realistic	20035, 20162, 20037, 20048, 20047, 20240, 20000, 20104, 20121, 20278, 20046, 20062, 21162
ReplayTV	20614, 20616
Ricavision	21972
Runco	20039
Samsung	20060, 20240, 20045, 20000, 20038, 20432,

VCR Codes	
	20739, 21014
Samtron	20240
Sanky	20048, 20039
Sansui	20240, 20000, 20067, 20209, 20041, 20072, 20002, 20271, 20479, 21479
Sanyo	20047, 20240, 20000, 20104, 20046, 20159, 20479
Scientific Atlanta	20008
Scott	20184, 20045, 20121, 20043, 20208
Sears	20060, 20035, 20162, 20037, 20048, 20039, 20047, 20033, 20045, 20000, 20042, 20104, 20067, 20043, 20209, 20041, 20072, 20046, 20105, 21237
Sharp	20048, 20047, 20032, 20000, 20062, 20807, 20848
Shintom	20039, 20240, 20000, 20072, 20208
Shogun	20240
Siemens	20037, 20104
Signature	20060, 20035, 20037, 20048, 20000, 20149, 20046, 20479
Singer	20037, 20240, 20072
Sonic Blue	20614, 20616
Sonographe	20046
Sony	20035, 20047, 20032, 20033, 20000, 20067, 20046, 20636, 21032, 21232, 21972



VCR Codes	
Stack 9	21972
Soundmaster	20000
STS	20042, 20105
SV2000	20000, 20072
SVA	20000
Sylvania	20035, 20081, 20000, 20043, 20593, 21593, 21781
Symphonic	20240, 20000, 20002, 20593, 21593
Systemax	21972
Tagar Systems	21972
Tandy	20000, 20104
Tatung	20048, 20081, 20000, 20067, 20041, 20008
Teac	20000, 20067, 20041
Technics	20035, 20162, 20037, 20000
Teknika	20035, 20037, 20000
Telecorder	20240
Telefunken	20041, 20208
Tevion	20479
Thomas	20000, 20002
Thomson	20060, 20041,

VCR Codes	
	20202
Tisonic	20278
Tivo	20618, 20636, 20739, 21996
TMK	20240, 20000, 20208
TNIX	20037
Tocom	20240
Toshiba	20240, 20045, 20000, 20042, 20043, 20209, 20041, 20062, 20845, 21008, 21145, 21972, 21996
Tosonic	20278
Totevision	20037, 20240
Touch	21972
Trix	20037
Ultra	20045, 20278, 20020
Unitech	20240
Vector	20045
Vector Research	20184, 20038
Vextra	20072
Victor	20067, 20041, 20008
Video Concepts	20045, 20061
Videomagic	20037

VCR Codes	
Videosonic	20240, 20000, 20072
Viewsonic	21972
Villain	20000
Voodoo	21972
Wards	20060, 20035, 20037, 20048, 20047, 20081, 20033, 20240, 20045, 20000, 20042, 20043, 20041, 20072, 20038, 20149, 20046, 20062, 20479, 20760
Wharfedale	20593
White Westinghouse	20000, 20209, 20072, 20278, 20479
World	20209, 20002, 20479
XR-1000	20035, 20240, 20000, 20072, 20208
Yamaha	20041, 20038
Zenith	20037, 20039, 20033, 20000, 20209, 20041, 20278, 20479, 21139, 21479
ZT Group	21972



## Limited Product Warranty

VIZIO provides a "ONE-YEAR LIMITED WARRANTY" against manufacturing defects in materials and workmanship to the original purchaser of a new VIZIO display purchased from an authorized VIZIO U.S. reseller and used in the fifty (50) United States or Puerto Rico.

### VIZIO's Responsibility

VIZIO displays purchased new from an authorized VIZIO U.S. reseller and that are used in the fifty (50) United States or Puerto Rico are warranted to be free from manufacturing defects in materials and workmanship for one (1) year from the date of the original retail purchase. If the display fails to conform to this limited warranty, VIZIO will, at its option and sole discretion, repair or replace the display.

### Labor

During the one-year limited warranty period, VIZIO will provide, when needed, service labor to repair a manufacturing defect. Repairs required on displays which are thirty (30) inches and larger generally will be made "on-site" where the display is installed. The determination for performing the on-site repair is dependent upon the manufacturing defect and is at VIZIO's option and sole discretion. Repairs required on displays which are less than thirty (30) inches generally will be performed at a VIZIO service center.

### Parts

Repairs may be made with new or recertified parts, or the entire unit may be replaced with a new or recertified unit, at VIZIO's option and sole discretion. Replacement parts or replacement units provided under this limited warranty are warranted for the remaining portion of the original warranty period, or for ninety (90) days from warranty service or replacement, whichever is later.

### How to Obtain Warranty Service

To obtain warranty service, contact VIZIO Technical Support via email at [TechSupport@VIZIO.com](mailto:TechSupport@VIZIO.com), via phone at 877-MYVIZIO (877-698-4946), or via postal mail at VIZIO Technical Support, 39 Tesla, Irvine, CA 92618. You must provide the model, serial number, and date of purchase. VIZIO Technical Support is available from 6:00AM to 9:00PM Pacific Time, Monday through Friday, and 10:00AM to 2:00PM Pacific Time, Saturday and Sunday. Please note that holiday hours may vary. For up to date information, please visit [www.VIZIO.com](http://www.VIZIO.com).

VIZIO reserves the right to assess all warranty claims and to determine if defects or damages are covered by this limited warranty. In case of a claim that is not covered by this warranty, you will be contacted to determine whether VIZIO should repair the damage for a fee or whether the product should be returned to you as received by the service technician or service center.

Parts and service labor that are VIZIO's responsibility under this limited warranty will be provided without charge. All other service is at the customer's expense. VIZIO reserves the right to charge the customer for any service call for anything not covered by this limited warranty. Before you ask for warranty service, please review your User Manual. You may avoid a service call and a service charge.

Please refer to the reverse side of this page for additional information regarding how to obtain warranty service.

**PLEASE DO NOT RETURN YOUR UNIT TO VIZIO WITHOUT PRIOR  
AUTHORIZATION.**

### Not Covered

This limited warranty does not cover the following: cosmetic defects; damage, malfunctions or failures resulting from shipping or transit, improper or faulty installation, abuse, operation contrary to furnished instructions, operation on incorrect power supplies, products not supplied by VIZIO, modification, alteration, improper servicing or tampering; damage from fire, water, lightning, power surges, abnormal environmental conditions or other acts of nature; normal wear and tear; unsatisfactory visual or audio performance not caused by a manufacturing defect; or displays with a missing or unreadable serial number. Operation of the display for commercial purposes or in applications or uses for which the display is not intended is not covered by this limited warranty. "Image Sticking", caused by static images on the screen for extended periods and or excessive brightness and contrast levels, is not covered by this





limited warranty. Installation, removal, transportation and reinstallation of a display, and routine maintenance and cleaning, are not covered by this limited warranty.

THERE ARE NO EXPRESS WARRANTIES OTHER THAN THOSE LISTED OR DESCRIBED ABOVE. ANY IMPLIED WARRANTIES, INCLUDING ANY IMPLIED WARRANTY OF MERCHANTABILITY AND FITNESS FOR A PARTICULAR PURPOSE, SHALL BE LIMITED IN DURATION TO THE PERIOD OF TIME SET FORTH ABOVE. VIZIO'S TOTAL LIABILITY FOR ANY AND ALL LOSSES AND DAMAGES RESULTING FROM ANY CAUSE WHATSOEVER, INCLUDING VIZIO'S NEGLIGENCE, ALLEGED DAMAGE, OR DEFECTIVE GOODS, WHETHER SUCH DEFECTS ARE DISCOVERABLE OR LATENT, SHALL IN NO EVENT EXCEED THE PURCHASE PRICE OF THE DISPLAY. VIZIO SHALL NOT BE RESPONSIBLE FOR LOSS OF USE, COMMERCIAL LOSS, LOST REVENUE OR LOST PROFITS, OR OTHER INCIDENTAL OR CONSEQUENTIAL DAMAGES. SOME STATES DO NOT ALLOW LIMITATIONS ON HOW LONG AN IMPLIED WARRANTY MENUS OR THE EXCLUSION OR LIMITATION OF INCIDENTAL OR CONSEQUENTIAL DAMAGES, SO THE ABOVE LIMITATIONS OR EXCLUSIONS MAY NOT APPLY TO YOU.

This warranty gives you specific legal rights, and you may also have other rights, which vary from state to state. This is the only warranty applicable; no one is authorized to extend or modify it or to grant any other warranty on VIZIO's behalf.

### **Owner's Responsibility**

To ensure warranty service, keep the dated bill or sales receipt as evidence of the purchase date and location. This limited warranty applies only to original purchaser and is non-transferable.

**Note:** Warranty service conditions are subject to change. For the latest Warranty Terms and Conditions and additional information regarding VIZIO's Limited Product Warranty, please see complete details online at [www.VIZIO.com](http://www.VIZIO.com).

## **VIZIO Return Policy**

VIZIO's return policy allows for products purchased directly from VIZIO to be returned by the original purchaser during the initial thirty (30) day period following the date of purchase. A VIZIO return authorization number must first be obtained as provided below. The refund will be the purchase price actually paid by the purchaser less a ten percent (10%) restocking fee per each item returned. Shipping and handling are not refundable.

The return authorization number must first be obtained from VIZIO's Customer Service by emailing [CustomerSupport@VIZIO.com](mailto:CustomerSupport@VIZIO.com) or by calling 949-428-2525, 6:00AM to 9:00PM Pacific Time, Monday through Friday, and 10:00AM to 2:00PM Pacific Time, Saturday and Sunday. Please note that holiday hours may vary. For up to date information, please visit [www.VIZIO.com](http://www.VIZIO.com).

Products must be returned to the address specified by VIZIO Customer Service and must be shipped in the original packaging, with freight prepaid to VIZIO, and must be received in new and unused condition. The return authorization number must be included in the packaging. VIZIO reserves the right to assess fees for any damaged or missing parts in addition to the ten percent (10%) restocking fee.

Return authorization numbers are valid for only fifteen (15) days from issuance. The customer is responsible for and must prepay all shipping charges and shall assume all risk of loss or damage to the product while in transit to VIZIO. If the product is returned to VIZIO (i) without a VIZIO return authorization number, and/or (ii) beyond the fifteen (15) day period, and/or (iii) without proper packaging, VIZIO retains the right to refuse delivery of such return or may return the unit to the customer at the customer's expense and with no refund issued. This return policy does not apply to defective products. Please read VIZIO's Limited Product Warranty for warranty terms and conditions.





## **On-Site Warranty Repair Procedure**

**On-Site Warranty Repair generally is performed on repairable displays which are 30 inches and larger.**

If VIZIO Technical Support determines that a problem with a display unit may be within the terms and conditions of the VIZIO Limited Product Warranty and that an on-site repair may be performed, the customer will be provided with an on-site repair authorization number and on-site repair instructions. The determination for performing the on-site repair may be dependent upon the manufacturing defect and is at VIZIO's option and sole discretion. Proof of purchase is required to confirm the product is within the one-year limited warranty period and meets the terms and conditions of the VIZIO Limited Product Warranty.

On-site repair service is requested through VIZIO's third-party service provider. After VIZIO provides the customer with the on-site repair (OSR) authorization number, the third-party service provider will contact the customer and will schedule the repair at the customer's location. The total approximate time for the repair process, which includes the repair diagnosis, dispatching the technician, shipping the replacement part(s), and arranging the appointment with the customer, is completed within approximately 3 to 5 business days, pending availability of these factors.

If it is determined the product can not be repaired on-site, the customer will be required to ship the unit to VIZIO's service center, per the below warranty replacement procedure.

VIZIO is not responsible for the de-installation or re-installation of the product. However, some standard installation may be performed during the on-site repair, at VIZIO's option and sole discretion. Please read VIZIO's Limited Product Warranty for warranty terms and conditions.

## **Warranty Replacement Procedure**

**Warranty Replacement generally is performed on displays which are determined to be economically unrepairable.**

If VIZIO Technical Support determines that a problem with a display unit may be within the terms and conditions of the VIZIO Limited Product Warranty and that a repair is not economically possible, based on certain manufacturing defects in materials and/or workmanship, and/or at VIZIO's option and sole discretion, the customer will be provided with a return authorization number and replacement instructions. Proof of purchase is required to confirm the product is within the one-year limited warranty period and meets the terms and conditions of the VIZIO Limited Product Warranty.

For displays forty-two inches (42") and larger, VIZIO will generally cover the transportation charges to perform an on-site swap of the original unit with the replacement unit. For displays under forty-two inches (42"), the customer is responsible for the transportation charges to VIZIO's service center. VIZIO will be responsible for the return transportation charges from the service center to the customer. Please read VIZIO's Limited Product Warranty for warranty terms and conditions.

## **Mail-In Warranty Repair Procedure**

**Mail-In Warranty Repair generally is performed on displays which are smaller than 30 inches.**

If VIZIO Technical Support determines that a problem with a display unit may be within the terms and conditions of the VIZIO Limited Product Warranty and that a mail-in repair may be performed, the customer will be provided with a return authorization number and mail-in repair instructions. Proof of purchase is required to confirm the product is within the one-year limited warranty period and meets the terms and conditions of the VIZIO Limited Product Warranty.

The customer will be provided with instructions for packing and shipping the unit to the VIZIO service center. The original carton box and packing material, or an equivalent as designated by VIZIO, must be utilized. The cost of shipping to VIZIO's service center is at the customer's expense. After the product is repaired and tested, the VIZIO service center will ship the unit back to the customer at VIZIO's expense. VIZIO is not responsible for the de-installation or re-installation of the product. Please read VIZIO's Limited Product Warranty for warranty terms and conditions.

**PLEASE DO NOT RETURN YOUR UNIT TO VIZIO WITHOUT PRIOR AUTHORIZATION.**



## Index

Accessories.....	9	DTV Transition .....	5
Adjustments		DVD Player	
Closed Caption.....	14	Connecting .....	22
Selecting the Screen Size .....	14	DVI	
Advanced Adjustments .....	39	Cable Box .....	19
Antenna.....	17	DVD Player .....	22
Audio Menu		Satellite Box .....	19
Analog Audio Out adjustments.....	42	Fine Tuning the picture .....	36
Audio Mode adjustments.....	42	HDMI .....	17
Balance adjustments.....	42	Horizontal/Vertical Position adjustments .....	48
Digital Audio Out .....	42	INFO Button .....	38
Equalizer adjustments.....	42	Input Source	
Lip Sync adjustments.....	43	Choosing.....	35
Reset Audio Mode.....	43	Inputs	
Speaker adjustments .....	42	Antenna.....	4
SRS TruVolume .....	42	Connectors.....	17
SRS TSHD (surround sound) adjustments .....	42	Installation services.....	9
Audio Menu Adjustments .....	42	Maintenance of TV .....	54
Blocking Channels .....	48	Media Port.....	28
Brightness .....	40	Music Settings.....	31
Cable Box		Picture Settings .....	30
Connecting .....	18	Video Settings.....	32
Camcorder		Naming Inputs .....	47
Connecting.....	24	On Screen Display .....	39
CC Closed Caption .....	47	OSD	
CEC .....	46	Closed Caption Selection.....	14
CEC Function.....	46	Parental Controls .....	48
Device Discovery .....	46	Block Unrated Programming .....	50
CEC Function.....	46	Canadian English Rating.....	49
CEC Menu .....	46	Canadian French Rating .....	50
Changing Channels.....	38	Change the Password.....	50
Channel information.....	44	Channel Block.....	48
Cleaning your VIZIO TV .....	54	DTV Rating.....	50
Coaxial connection		Rating Enable.....	48
Satellite box.....	21	US Movie Rating .....	49
Coaxial Connection		US TV Rating .....	49
cable TV.....	21	Picture Menu .....	40
Color .....	40	Adaptive Luma .....	41
Component Connector .....	17	Advanced Video .....	41
Composite Connector .....	17	Backlight .....	40
Computer		Backlight Control .....	41
Connecting.....	26	Brightness .....	40
PC Resolutions .....	27	Color .....	40
Connecting Equipment		Color Enhancement .....	41
Cable.....	18	Color Temperature .....	41
Computer .....	26	Contrast .....	40
DVD .....	22	Film Mode .....	41
Rear Panel Connections .....	13	Noise Reduction.....	41
Satellite Box .....	18	Picture Mode .....	40
Sound system .....	25	Reset Picture Mode.....	41
Stereo .....	25	Sharpness.....	40
VCR .....	24	Smooth Motion.....	41
Video Camera .....	24	Tint .....	40
Contents.....	9	PIP .....	45
Contrast .....	40	Remote Control.....	14
Controls		Batteries.....	16
Front Panel.....	12	Component Codes .....	53
Side Panel.....	12	Programming the Universal Remote .....	52
Daylight Savings setting.....	44	Programming to work your DVD Player .....	53
Device Discovery .....	46	Programming to work your Set-Top Box .....	52



Programming to work your VCR.....	52	Stand Assembly .....	10
Range .....	16	Stereo	
Using your Cable or Satellite Remote to Operate your VIZIO TV .....	53	Connecting .....	25
Reset All Settings.....	50	S-Video .....	17
Resetting the System .....	50	Technical Support .....	57
RGB .....	17	Time Zone setting .....	44
Connecting your PC .....	26	Tint.....	40
Safety Instructions.....	2	Troubleshooting .....	55
Satellite Box		TV Menu	
Connecting .....	18	Auto Search adjustments .....	44
Screen Size explanation .....	51	Partial Channel Search .....	44
Search for channels .....	44	Skip Channel.....	44
Select Language (MTS) .....	44	Tuner Mode adjustments .....	44
Setting picture formats .....	51	TV Menu Adjustments.....	44
Setting up.....	11	VCR	
Setup Menu.....	45	Connecting.....	24
CC.....	47	Viewing Modes.....	51
Language setup .....	45	Volume .....	38
Parental Controls .....	48	Wall mounting .....	11
PIP .....	45	Warranty .....	71
Setup Wizard.....	50	Warranty services .....	9
System Menu .....	50	Watching TV	
Wide.....	46	Basic Adjustments.....	38
Sharpness .....	40	Basic connections .....	33
Skip Channel.....	44	First Startup.....	33
Sleep timer settings.....	46	Getting your Programs .....	37
Specifications		Program Information .....	38
Media Port.....	28	Wide.....	46
TV .....	59	Wizard.....	50

