

HDMI™

This TV incorporates High-Definition Multimedia Interface (HDMI™) technology. HDMI, the HDMI logo and High-Definition Multimedia Interface are trademarks or registered trademarks of HDMI Licensing LLC.



Manufactured under license from Dolby Laboratories.

Dolby and the double -D symbol are trademarks of Dolby Laboratories.

Federal Communications Commission Statement



This equipment has been tested and found to comply with the limits of a class B digital device, pursuant to Part 15 of the FCC Rules. These limits are designed to provide reasonable protection against harmful interference in a residential installation. This equipment generates, uses and can radiate radio frequency energy and, if not installed and used in accordance with the instructions, may cause harmful interference to radio communications. However, there is no guarantee that interference will not occur in a particular installation. If this equipment does cause harmful interference to radio or television reception, which can be determined by turning the equipment off and on, the user is encouraged to try to correct the interference by one or more of the following measures:

1. Reorient/Relocate the receiving antenna.
2. Increase the separation between the equipment and receiver.
3. Connect the equipment into an outlet on a circuit which is different from what the receiver is connected to.
4. Consult the dealer or an experienced radio/TV technician for help.



Changes or modifications not expressly approved by the manufacturer responsible for compliance could void the user authority to operate the equipment.

WEEE



This product contains electrical or electronic materials. The presence of these materials may, if not disposed of properly, have potential adverse effects on the environment and human health. Presence of this label on the product means it should not be disposed of as unsorted waste and must be collected separately. As a consumer, you are responsible for ensuring that this product is disposed of properly. To find out how to properly dispose of this product, please go to www.polaroid.com and click on “Company” or call the customer service number for your country listed in the instruction manual.

Warnings and Precautions

To prevent any injuries, the following safety precautions should be observed in the installation, use, servicing and maintenance of this equipment.

Before operating this equipment, please read this manual completely, and keep it nearby for future reference.



This symbol is intended to alert the user to avoid the risk of electric shock. This equipment must not be disassembled by anyone except qualified service personnel.



This symbol is intended to alert the user to the presence of important operating and maintenance instructions in the literature accompanying the appliance.



To reduce the risk of fire or electric shock, do not expose this equipment to rain or moisture.

- TO REDUCE THE RISK OF ELECTRIC SHOCK, DO NOT REMOVE COVER (OR BACK).
- NO USER-SERVICEABLE PARTS INSIDE.
- REFER SERVICING TO QUALIFIED SERVICE PERSONNEL.



Use of controls, adjustments or performance of procedures other than those specified herein may result in hazardous radiation exposure.

Important Safety Instructions



This symbol indicates caution points.



This symbol indicates actions that should not be done.



This symbol indicates actions that must be performed.



• Do not place the equipment on any uneven or unstable carts, stands, tables, shelves etc. The equipment may fall, causing serious injury to children or adults and serious damage to the equipment itself.



• Use only a cart or stand recommended by the manufacturer. This equipment and recommended cart or stand should be handled with care. Quick stops, excessive force, and uneven surfaces may cause the equipment and cart/stand to overturn.



• Do not disable the 3-wire grounding type plug. The grounding pin on the 3-prong plug is an important feature. Removing the grounding pin will increase the risk of damaging the equipment.

• If you can not fit the plug into the electrical outlet, contact an electrician to install a grounding outlet.

• Always operate this equipment from the type of power source indicated on the rear of the serial/model plate.

• Never overload wall outlets and extensions.



- Use and handle the power cord with care. Do not place any heavy objects on the AC power cord.
- Do not pull the AC power cord. Do not handle the AC power cord with a wet hand.
- Do not touch the power cord and antenna cable during lightning.
- Remove the plug from the wall outlet, if the equipment will not be used for a long period of time.
- Do not place, use or handle this equipment near water.
- Never expose the equipment to liquid, rain, or moisture.
Seek for service if any of the above is spilled into the equipment.
- Do not expose the equipment to extreme temperature or to direct sunlight, as the equipment may heat up and suffer damage.
- Do not install the equipment near any heat sources such as radiators, heat registers, stoves, or any other apparatus that might produce heat.
- Do not attempt to service the equipment yourself.
- Opening and removing the covers may expose you to dangerous voltage or other hazards and may void your warranty. Refer service to qualified personnel.
- Do not place or drop any other objects on top.
- Do not insert anything into the ventilation holes of your equipment.
Inserting any metal or flammable objects may result to fire or electric shock.
- Do not place the equipment on uneven or unstable carts, stands, tables, shelves etc. The equipment may fall, causing serious injury to children or adults and serious damage to the equipment itself.
Always place the equipment on the floor or on a surface that is sturdy, level, stable and strong enough to support the weight of the equipment.
- Do not block any ventilating openings. Leave an open space around the equipment.
Never place the equipment :
on a bed, sofa, rug, or any other similar surfaces; too close to drapes/curtains/walls, in a bookcase, built-in cabinet, or any other similar places that may cause poor ventilation.
- Unplug this apparatus during lightning storms or when unused for long periods of time.
- Refer all servicing to qualified service personnel. Servicing is required when the apparatus has been damaged in any way, such as power-supply cord or plug is damaged, liquid has been spilled or objects have fallen into the apparatus, the apparatus has been exposed to rain or moisture, does not operate normally, or has been dropped.



- Always remove the power cord from the outlet before cleaning the equipment.
- Never use liquid or aerosol cleaners on the equipment.
Clean only with a soft dry cloth.



- Only use attachments/accessories specified by the manufacturer.

Antenna Safety Instructions

If an outdoor antenna is connected, follow the precautions below:



- An outdoor antenna should not be located in any area where it could come in contact with overhead power lines, or any other electric light or power circuits.
- When installing an outdoor antenna system, extreme caution should be taken to prevent contact with power lines. Direct contact with power lines may be fatal and should be avoided at all costs.

Section 810 of National Electrical Code (NEC) provides information with respect to proper grounding of the mast and supporting structure, grounding of the lead-in wire to an antenna discharge unit, size of grounding conductors, location of antenna discharge unit, connection to grounding electrodes, and requirements for the grounding electrode.

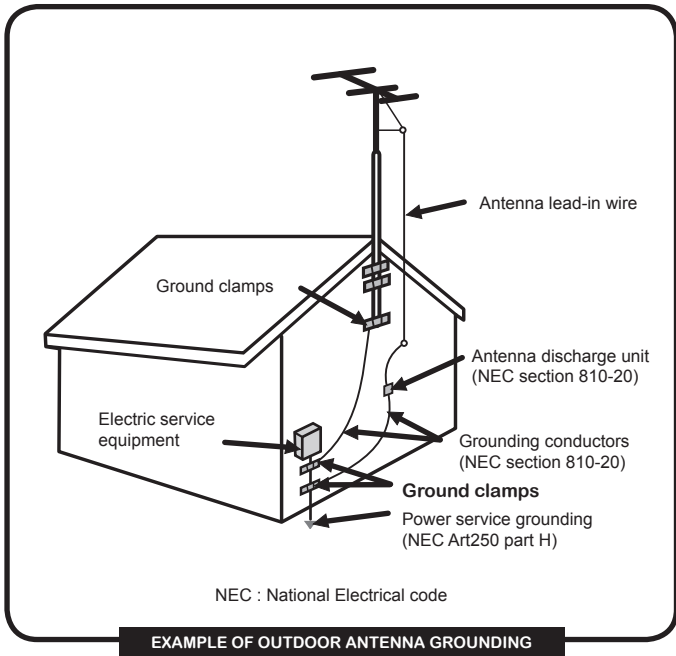

CONTENTS

■ Federal Communications Commission Statement	1
■ Warnings and Precautions	
Important Safety Instructions	2
Antenna Safety Instructions	4
■ Chapter 1 Introducing the LCD TV	
Key Features	6
Package Contents	7
Setting Your LCD TV	8
Your LCD TV	10
Your Remote Control	12
■ Chapter 2 Installing the LCD TV	
Connecting a TV Cable or an Antenna	14
Connecting a VCR	19
Connecting a Video Camera or Game Console	20
Connecting a DVD Player	21
Connecting a Digital TV Cable Box or Digital Satellite Receiver	23
Connecting an AV Equipment with HDMI Connector	24
Connecting an AV Equipment with DVI Connector	25
Connecting a PC	26
Connecting an Audio Receiver or a Dolby Digital 5.1 Sound System	27
■ Chapter 3 Using the Features	
Using Picture-In-Picture	28
Wide Screen Viewing	30
Using the Program Guide	31
Operating the Menu	32
Customizing the VIDEO Settings	34
Customizing the AUDIO Settings	36
Customizing the TV Settings	38
Customizing the SETUP Settings	40
Using the Program Block Settings	44
■ Specification	49
■ Display Mode	50

Chapter 1

Introducing the LCD TV

Key Features

Various Audio/Video terminals for external equipment connection

- 2 sets of composite A/V input terminals
- 1 set of S-VIDEO terminals
- 2 sets of component Video input terminals
- 1 VGA/ Audio input terminals
- 1 HDMI/Audio input terminals
- 1 set of Audio(L/R) output terminals
- 2 SPDIF output terminals (Optical x 1 /Coaxial x 1)
- 1 Headphone terminal

The built-in TV tuner to receive HD ATSC

- This function allows the reception of HD broadcasting without the addition of a set top box.

High Definition Multimedia Interface (HDMI)

- High Definition Multimedia Interface (HDMI) is a small, user-friendly interconnect that can carry up to 5 Gbps of combined video and audio in a single cable. This system eliminates the cost, complexity and confusion of multiple cables used to connect current A/V systems.

HDTV Component Video Inputs

- Offers the best video quality for DVD(720p,HD1080i,1080p) and digital set-top-box (720p,HD1080i,1080p) connections.

3D Digital Noise Reduction

- This function can digitally reduce image noise to provide better picture quality.

Film-Mode Detection (3:2 Reverse Pull Down)

- This function can automatically detect content derived from film and adjust the interlacer's frame matching to provide a more natural-looking, clearer image of the moving picture.

PIP Function

- Provides viewing of two programs simultaneously, in either picture-in-picture mode or picture-on-picture (side by side) mode.

Package Contents

Make sure all of the following contents are included.

- LCD TV



- Screw Driver and 4 Screws

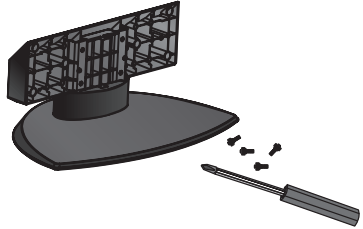

- Remote Control/
AAA Batteries x 2

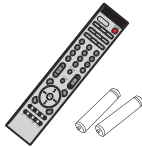

- VIDEO Cable



- Power Cord



- AUDIO Cable

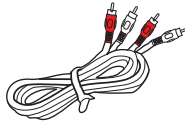

- Warranty Card



- User's Manual



- Quick Start Guide

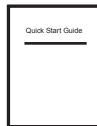

- Attention Card

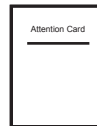

These items are all you need to set up and operate the LCD TV in its basic configuration.



Make sure all of the above contents are included in the package. If you are missing any items, please contact the customer service department.

Setting Up Your LCD TV

How to install the TV Stand

If you prefer to mount your new TV on a wall instead of attaching it to the stand, please reference the instructions included in the wall mounting kit(not included).



Attach the Stand the TV with the bottom foam packaging material still attached.

Read all instructions before continuing with the stand installation.

- Lift foam packaging material from the top of the LCD out of the box.
- Lift LCD out of the box, with the bottom foam packaging material still attached, and place onto a stable surface.

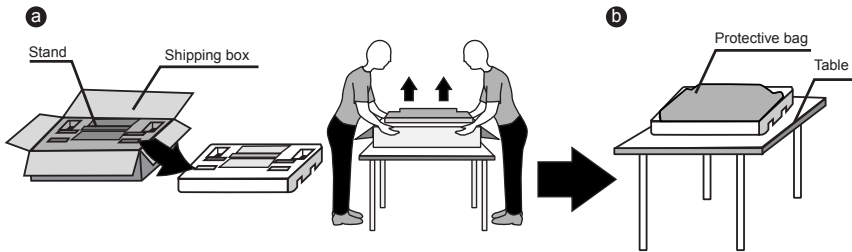

- Remove protective bag from LCD unit, but DO NOT remove the bottom foam packaging material from the TV.
- Locate the place on the back of the TV to attach the stand. Secure the stand to the LCD with all four screws.

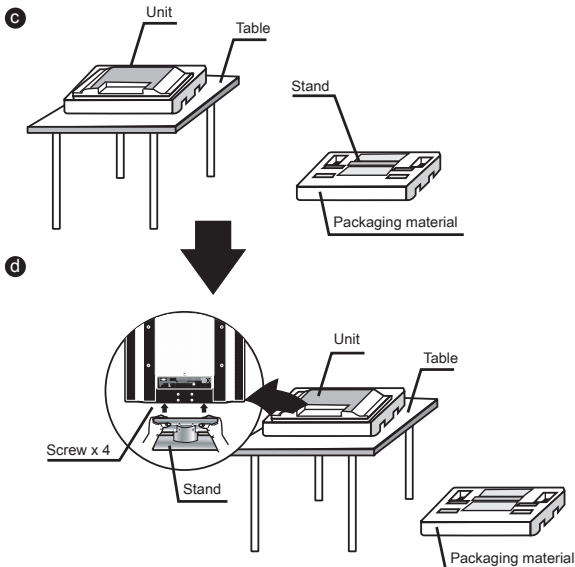

How to setup the TV

- 1 Use a supplied antenna cable to connect the VHF/UHF signal to the LCD TV's ANT. terminal (refer to page15-18).
- 2 Connect the AC power cord at the back of the TV and connect the power cord to wall outlet.
- 3 Insert the 2 batteries supplied in remote control.

Step1 Slide the back cover up to open the battery compartment of the remote control.

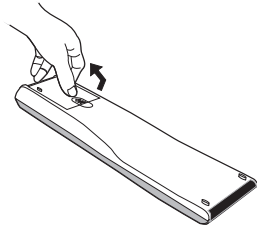

Step2 Insert two AAA size batteries. Make sure to match the (+) and (-) ends of the batteries with the (+) and (-) ends indicated in the battery compartment. Slide the cover back into place.

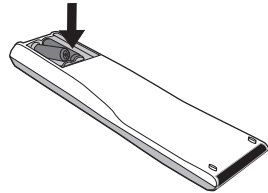

Do not use caustic cleaners (porcelain, stainless steel, toilet, or oven cleaner etc.) on the remote, as it may suffer damage.

- 4 Connect other an external AV device (refer to page19-27).

Your LCD TV

Front/Right Side View and Controls

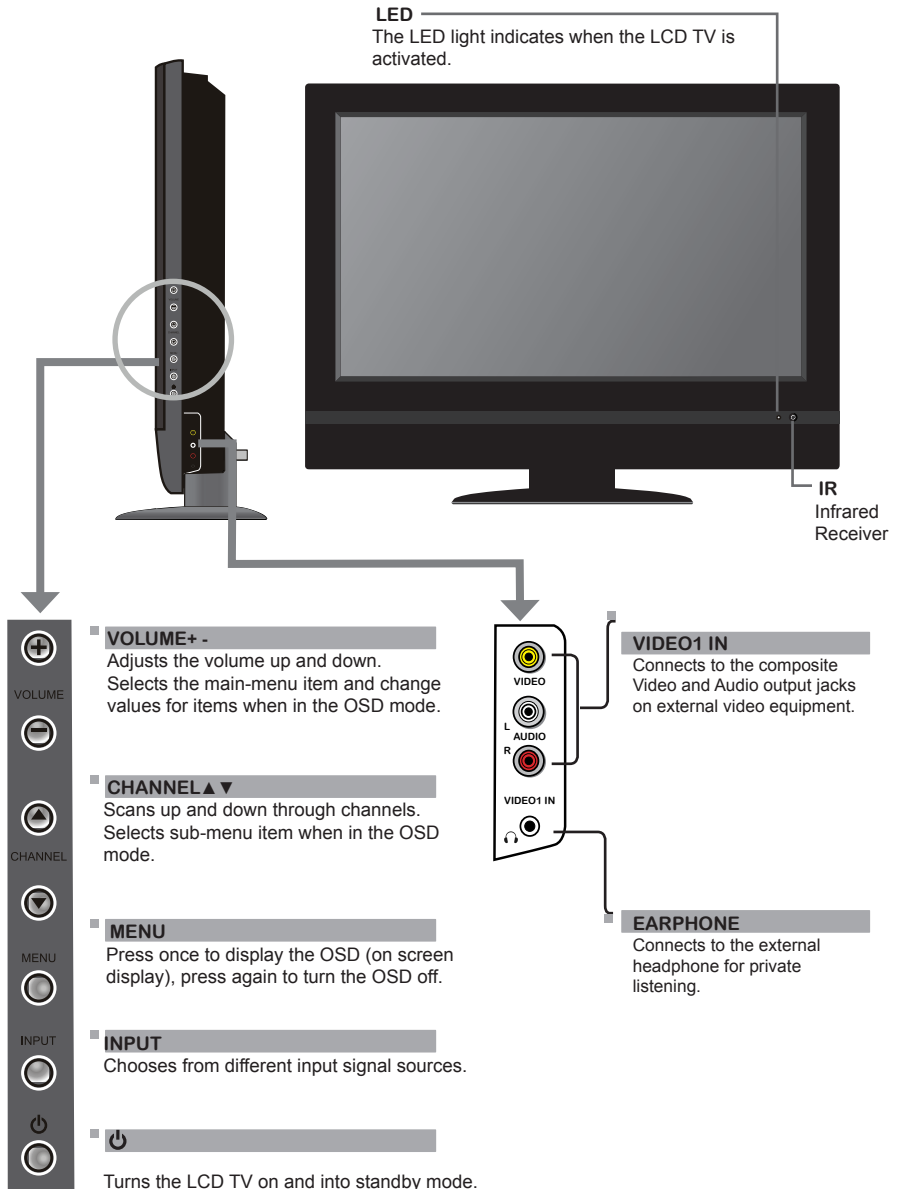

Rear View and Jacks

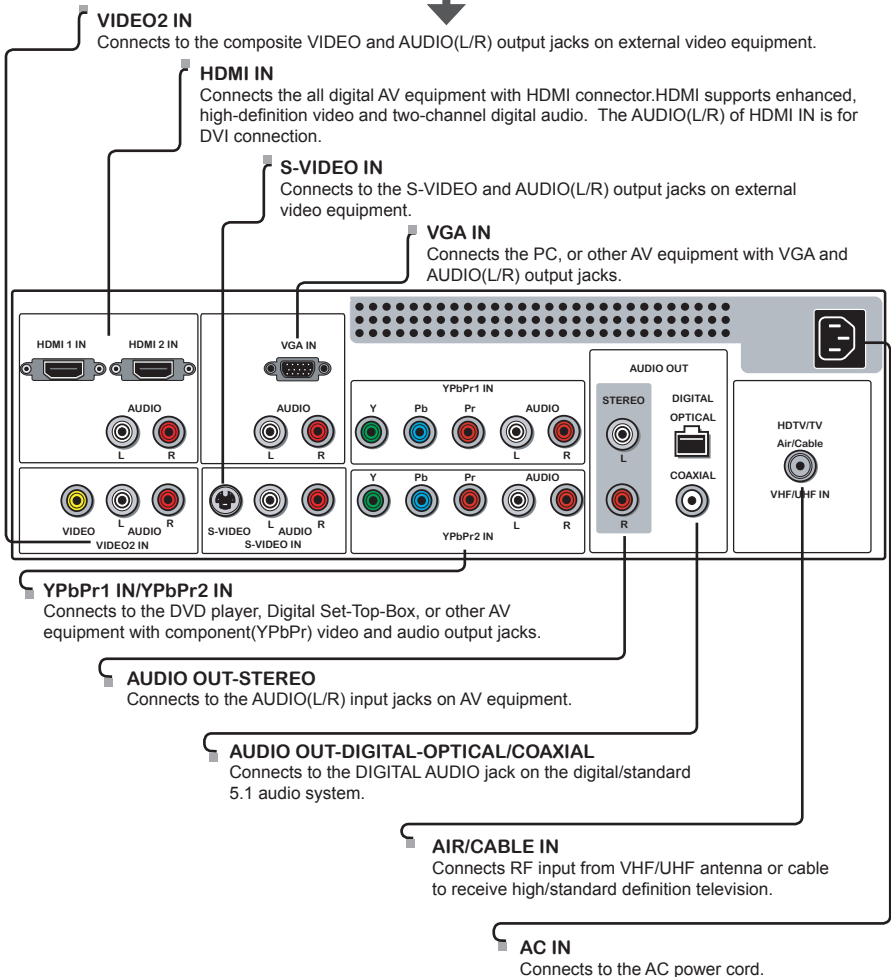

Your Remote Control

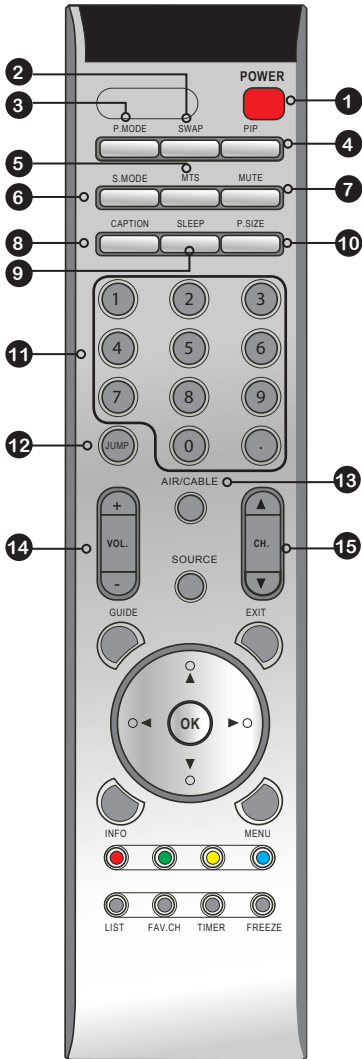

- | | | |
|-----------|------------------|--|
| 1 | POWER | Turns the LCD TV on and off. |
| 2 | SWAP | Swaps between the main and sub window in PIP/POP mode. |
| 3 | P.MODE | Selects picture mode: Vivid/Hi-Bright/Cinema/Sport/User |
| 4 | PIP | Turns PIP/POP on and off. |
| 5 | MTS | Cycles through the multi-channels TV sound(MTS) options: SAP/MONO/STEREO |
| 6 | S.MODE | Selects sound effect options: Surround/Live/Dance/Techno/Classic/Soft/Rock/Pop/Off. |
| 7 | MUTE | Mutes and restores the audio |
| 8 | CAPTION | Cycles through the Closed Caption:
<ul style="list-style-type: none"> ▪ Analog Closed Caption:CC1/CC2/CC3/CC4/TT1/TT2/TT3/TT4/Off ▪ Digital Closed Caption:Service1 |
| 9 | SLEEP | Cycles through the LCD TV sleep timer: OFF/10/20/30/40/50/60/90/120 mins |
| 10 | P.SIZE | Cycles through Wide mode settings : FULL/ ZOOM / WIDE /NORMAL |
| 11 | 0-9 | Select and switch to a channel by using 0-9 buttons.

<ul style="list-style-type: none"> • In TV mode, use with 0-9 and • buttons to select a digital channels. |
| 12 | JUMP | Returns to previously selected channel. |
| 13 | AIR/CABLE | Cycles through the TV receiving signal: AIR(antenna)/Cable(STD/IRC/HRC) |
| 14 | VOL.+/- | Increases and decreases volume. |
| 15 | CH.▲▼ | Scans up and down the channels |

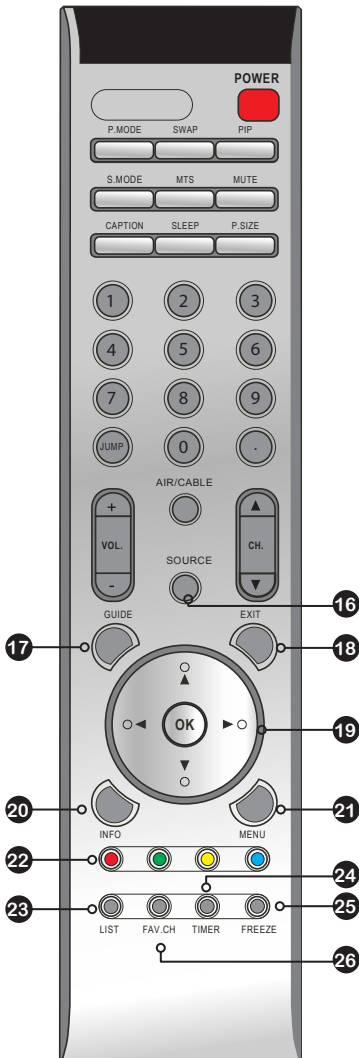

- 16 SOURCE** Pressing **SOURCE** display the source list, use **▲▼** to select the video inputs of your LCD TV : TV/VIDEO1/VIDEO2/VIDEO3/VIDEO4/VIDEO5/VIDEO6/COMPUTER

Input source
TV(CABLE/AIR)
VIDEO1 (SIDE)
VIDEO2 (REAR)
VIDEO3 (S-VIDEO)
VIDEO4 (YPbPr1)
VIDEO5 (YPbPr2)
VIDEO6 (HDMI)
COMPUTER(VGA)

- 17 GUIDE** Displays the Program Guide on the screen. Pressing again to turn GUIDE off.

- 18 EXIT** Exits the OSD menu.

- 19 ▲▼▶◀ OK** Cycles through OSD options and selects individual menu items. OK confirms option settings.

- 20 INFO** Pressing repeatedly displays a variety of information such as the current channel and the input source.

- 21 MENU** Displays the OSD menu on the screen.

- 22** For European TV system only.

- 23 LIST** Displays the received channel list

Channel List
5-2 RF5-2
9-1 KOED-HD
9-2 KOED-SD
8 CCT
12
13
15

- 24 TIMER** Displays the current time on the screen.

- 25 FREEZE** Pressing **FREEZE** to freeze the current picture, press again to restore the picture.

- 26 FAV.CH** Pressing **FAV.CH** display favorite channels.



Effective range:

The remote can control the LCD TV from up to 5m away, if pointed directly at the receiver.

Chapter 2

Installing the LCD TV

Refer to the owner's manual of any external equipment to be connected. When connecting any external equipment, do not connect any AC power cords to wall outlets until all other connections are completed.

Connecting a TV Cable or an Antenna

Antenna Connection

The antenna requirements for good color TV reception are more important than those for a black & white TV reception. For this reason, a good quality outdoor antenna is strongly recommended. The following is a brief explanation of the type of connection that is provided with the various antenna systems.

- A 75-ohm system is generally a round cable (not included) with F-type connector that can easily be attached to a terminal without tools.

F-type connector



75-ohm coaxial cable (round)

- A 300-ohm system is a flat twin-lead cable (not included) that can be attached to a 75-ohm terminal through a 300-75-ohm adapter (not included).



300-ohm twin-lead cable (flat)

Use one of the following two diagrams when connecting an outdoor antenna.

A: Shows how to use a VHF/UHF combination outdoor antenna.

B: Shows how to use a separate VHF and/or UHF outdoor antenna.

A. Combination VHF/UHF antenna

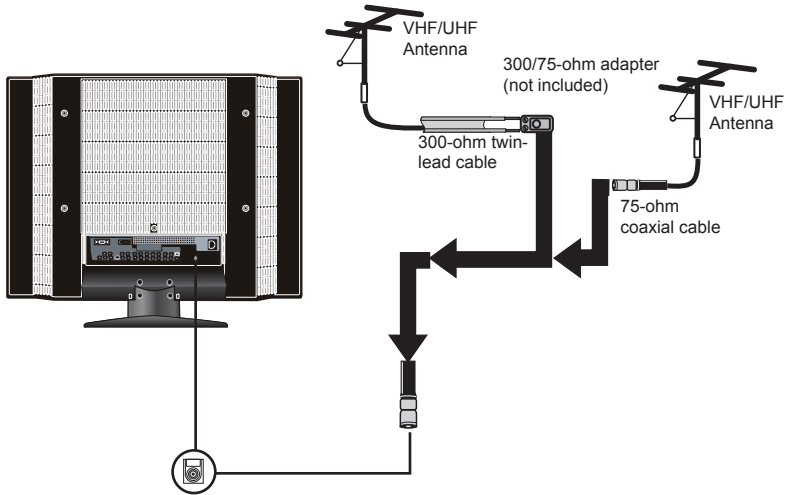

B. Separate VHF and/or UHF antennas

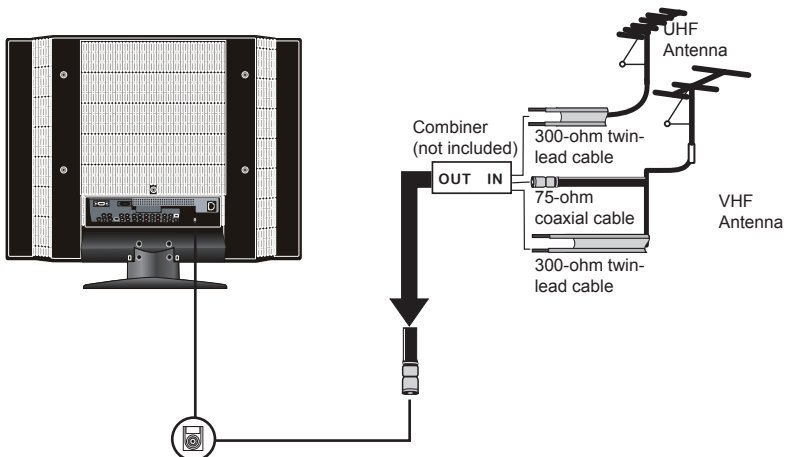

Cable TV (CATV) Connection

This reminder is provided to call the CATV system installer's attention to Article 820-40 of the National Electrical Code (NEC) that provides guidelines for proper grounding and, in particular, specifies that the cable ground shall be connected to the grounding system of the building accurately, or as close to the point of cable entry as possible. Use of this TV for other than private viewing of programs broadcasted on UHF, VHF or transmitted by cable companies for the use of the general public may require authorization from the broadcast/cable company, and/or program owner.

- **A 75-ohm coaxial cable connector is built into the set for easy hookup. When connecting the 75-ohm coaxial cable to the set, connect the 75-ohm cable into the ANT. terminal.**
- **Some cable TV companies offer premium pay channels. Since the signals of these premium pay channels are scrambled, a cable TV converter/descrambler is generally provided to the subscriber by the cable TV company.**

This converter/descrambler is necessary for normal viewing of scrambled channels. (Set your TV to channel 3 or 4, typically one of these channels is used. If this is unknown, consult your cable TV company.) For more specific instructions on installing cable TV, consult your cable TV company. One possible method of connecting the coverter/descrambler provided by your cable TV company is shown in the diagram below.

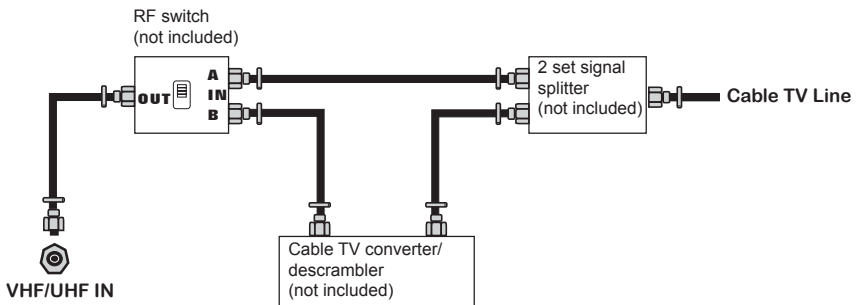

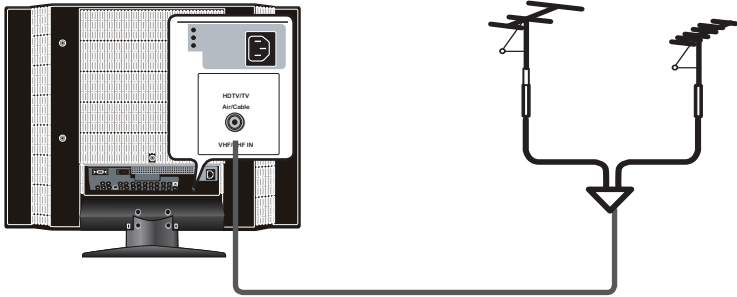

- The RF switch (not included) is required to provide two inputs (A and B). Setting the RF switch to position A allows viewing of all unscrambled channels by using the TV channel keys.
- Setting the RF switch to position B allows viewing of all scrambled channels via the converter/descrambler by using the converter channel keys.

- 1 Use a supplied antenna cable to connect the TV signal to the LCD TV's TV CABLE terminal.

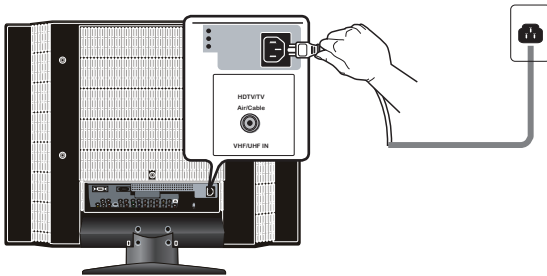

- 2 Connect the AC power cord at the back of the TV and connect the power cord to wall outlet.



- 3 Press the  button on the remote to turn on the LCD TV.



Always disconnect the LCD TV from the main voltage when the LCD TV will not be used for a long period of time. The POWER button on the front panel is only used for switching the LCD TV into standby, it does not disconnect the device from the main voltage. To completely disconnect the main voltage, please remove the power plug from the socket.

- Press the **SOURCE** button on the remote to display the Input Source List. Use the **▲▼** buttons to select **TV** and press the **OK** button.

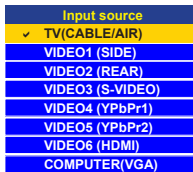

- Press the **MENU** button on the remote control to display the Main menu, and use the **◀▶** buttons to select the **TV**.

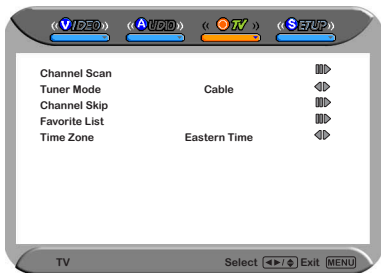

- Press the **▼** button to select **Channel Scan**, and press the **OK** button. The **Channel Scan** automatically creates a list of receivable channels. Press the **MENU** button at any time to interrupt the memorization process. (the list cannot be created if interrupted)

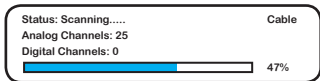

! The Channel Scanning will create a list of receivable channels for the current input (antenna or cable). You will be required to run Channel Scanning for each RF input to create a list of available channels from both inputs.

- Press the **OK** button to display the received channel list. Then press **▲▼** to select a channel and press again the **OK** button to display the channel detail.

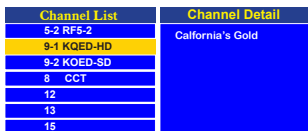

Or, use the **•** (Input button) with **0-9** buttons to select digital channel(for example 9.1)

! The digital main channel might include many subchannels (for example 9-1, 9-2..) that are showing program at the same time.

Connecting a VCR

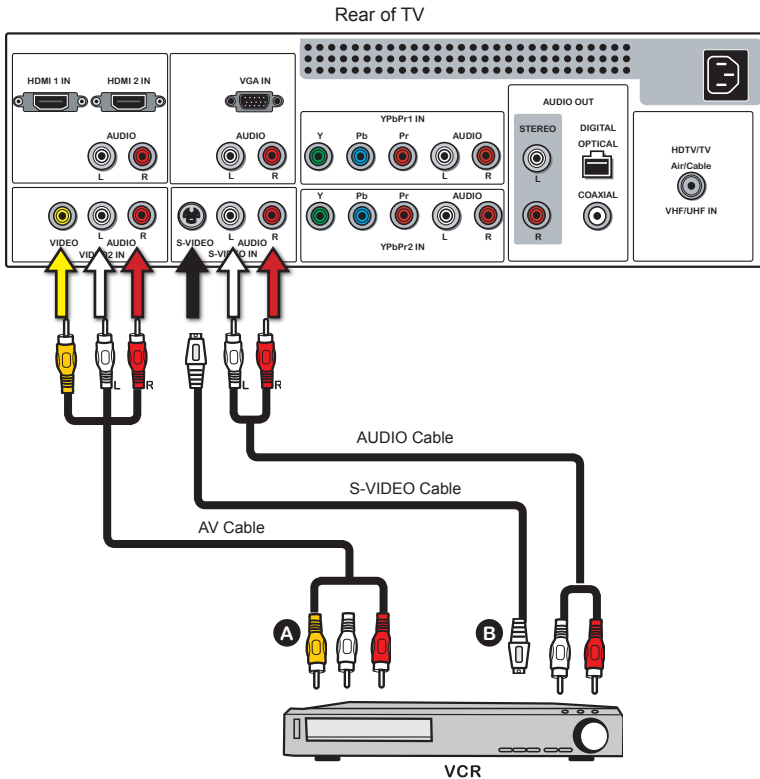

1

METHOD A:

Use a composite cable to connect the VCR's composite video/audio jacks to the LCD TV's VIDEO2 IN jacks.

METHOD B:

Use an audio cable to connect the VCR's audio output jacks to the LCD TV's audio inputs. Use a S-Video cable to connect the VCR's s-video output jack to the LCD TV's S-VIDEO IN input jack.

2

Connect all AC power sources, before turning on the power switch of the LCD TV or other connected equipment.

3

Press the  button on the remote to turn on the LCD TV.

4

To watch a videotape, press the **SOURCE** button on the remote to select **VIDEO2**(METHOD A), or **VIDEO3** (METHOD B).

Connecting a Video Camera or Game console

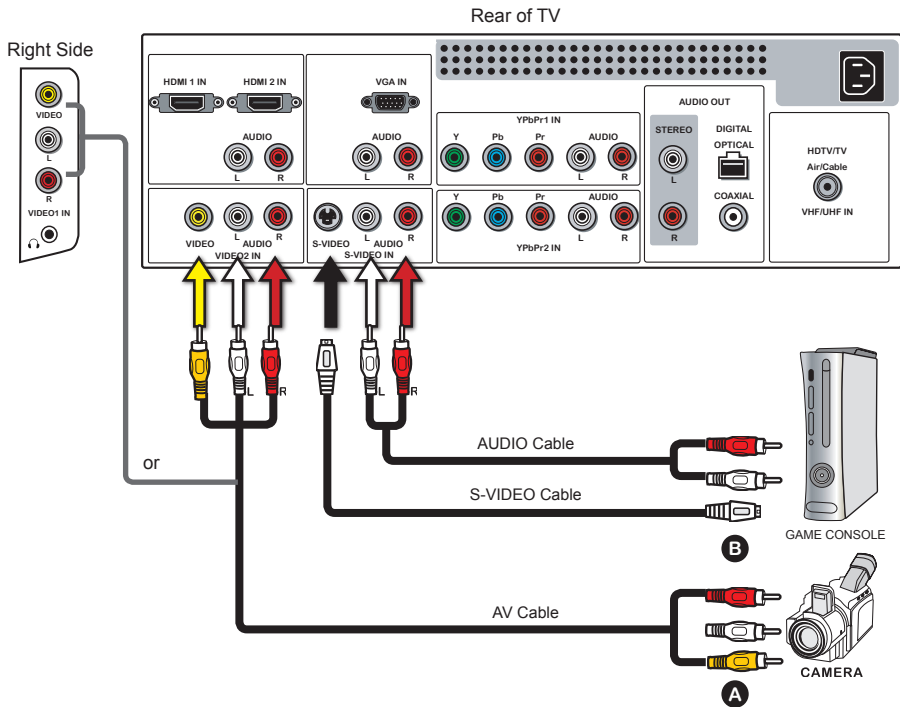

1

METHOD A:

Use a composite cable to connect the video camera's or game console's composite video/audio jacks to the LCD TV's VIDEO2 IN jacks or VIDEO1 IN jacks.

METHOD B:

Use an audio cable to connect the video camera's or game console's audio output jacks to the LCD TV's audio inputs. Use an S-Video cable to connect the video camera's or game console's s-video output jack to the LCD TV's S-VIDEO IN input jack.

2

Connect all AC power sources, before turning on the power switch of the LCD TV or other connected equipment.

3

Press the **POWER** button on the remote to turn on the LCD TV.

4

To watch a video vis camera or game console, press the **Input** button on the remote to select **VIDEO2/VIDEO1**(METHOD A), or **VIDEO3** (METHOD B).



Not all cameras have the ability to connect to a TV. Please check your video camera user guide for compatibility.

Connecting a DVD Player

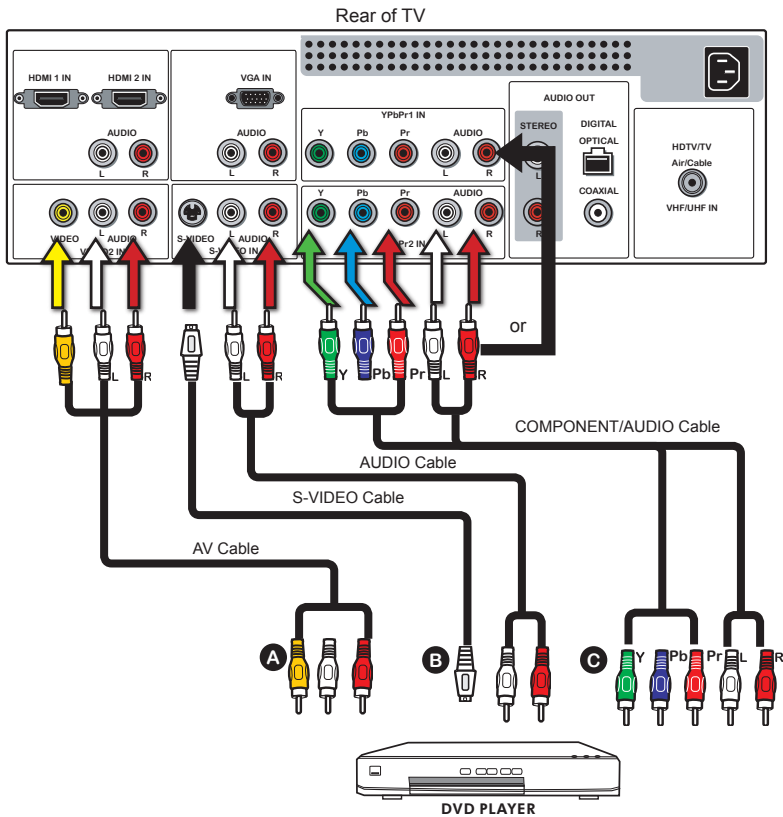

1

METHOD A:

Use a composite cable to connect the DVD player's composite video/audio jacks to the LCD TV's VIDEO2 IN jacks.

METHOD B:

Use an audio cable to connect the DVD player's audio output jacks to the LCD TV's audio inputs. Use an S-Video cable to connect the DVD player's s-video output jack to the LCD TV's S-VIDEO IN input jack.

METHOD C:

Use a component cable to connect the DVD player's component output jacks to the LCD TV's Y Pb Pr1 IN or Y Pb Pr2 IN input jacks. Use an audio cable to connect the DVD player's component audio jacks to the LCD TV's audio input jacks.



The component video jacks on your DVD player are sometimes labeled YPbPr, or YCbCr. For an explanation of component video, see your DVD player's user guide.

- 2 Connect all AC power sources, before turning on the power switch of the LCD TV or other connected equipment.
- 3 Press the  button on the remote to turn on the LCD TV.
- 4 To watch a DVD, press the **Input** button on the remote to select **VIDEO2**(METHOD A), or **VIDEO3** (METHOD B), or **VIDEO4/VIDEO5** (METHOD C).



For best picture quality, if your equipment has component video output, use a component cable instead of a composite video or S-video cable.

Connecting a Digital TV Cable Box or Digital Satellite Receiver

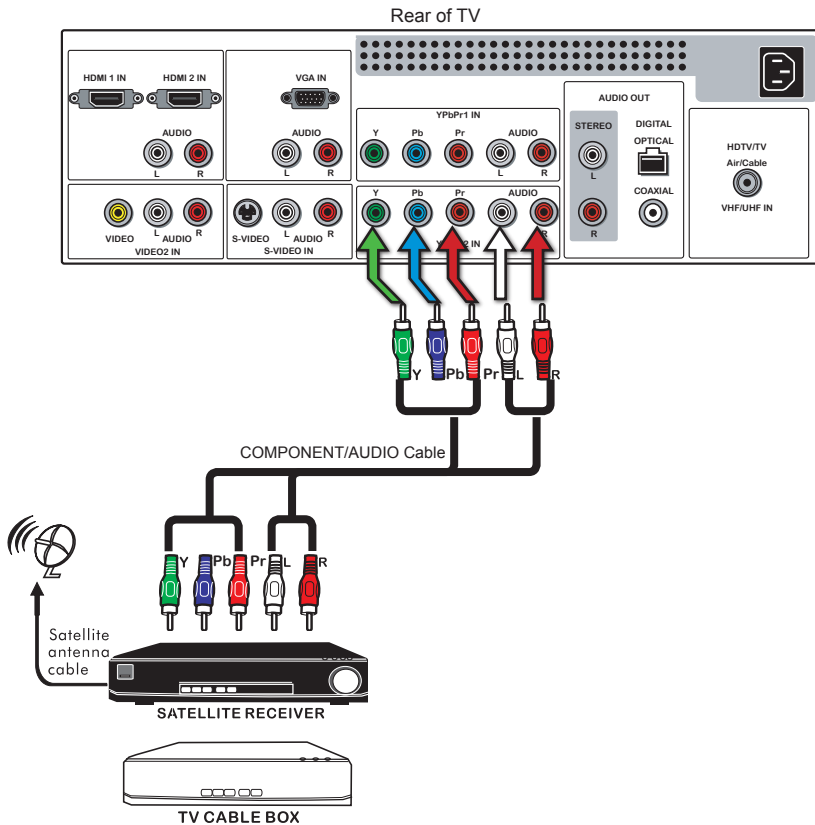

- 1** Use a component cable to connect the satellite receiver's/TV Cable Box's component (YPbPr1) output jacks to the LCD TV's component input jacks. Use an audio cable to connect the satellite receiver's/TV Cable Box's component audio jacks to the LCD TV's audio input jacks.
- 2** Connect all AC power sources, before turning on the power switch of the LCD TV or other connected equipment.
- 3** Press the  button on the remote to turn on the LCD TV.
- 4** To watch programs via satellite receiver or TV Cable Box, press the **Input** button on the remote to select **VIDEO4/VIDEO5**.

Connecting an AV Equipment with HDMI Connector

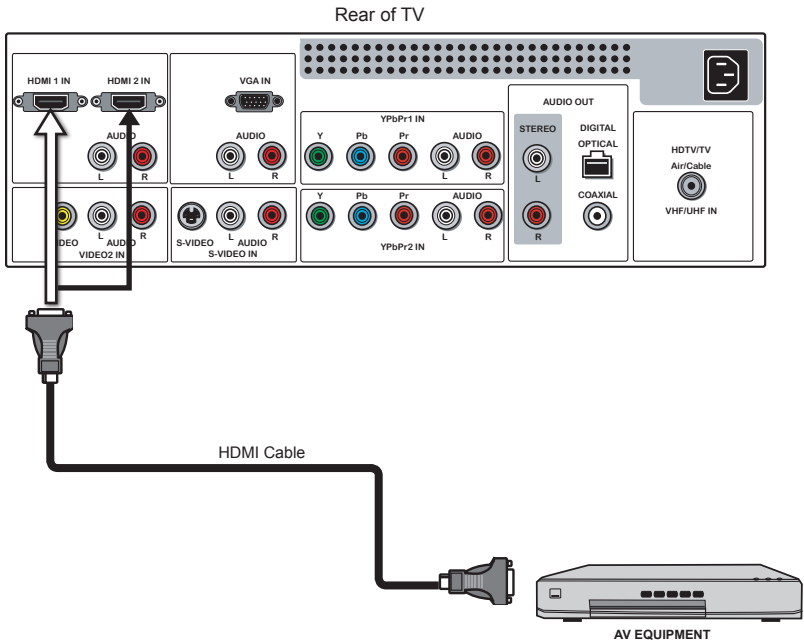

- 1 Use a HDMI cable to connect the AV equipment's HDMI output jack to the LCD TV's HDMI IN jacks.
- 2 Connect all AC power sources, before turning on the power switch of the LCD TV or other connected equipment.
- 3 Press the ^{POWER}  button on the remote to turn on the LCD TV.
- 4 Press the **Input** button on the remote to select **VIDEO06**.

 The HDMI connector provides both video and audio signals, it's not necessary to connect the audio cable.

Connecting an AV Equipment with DVI Connector

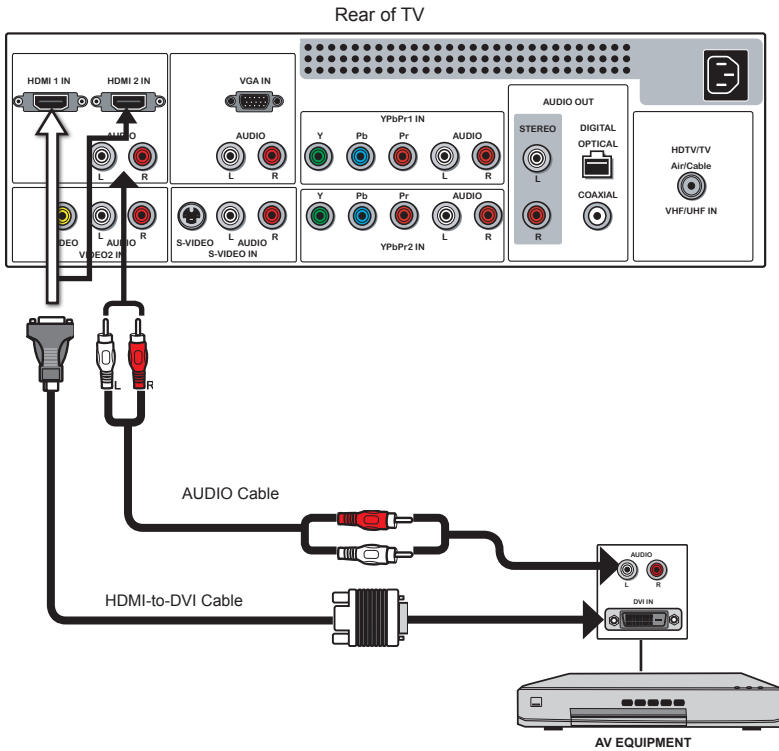

- 1 Use a HDMI-to-DVI cable to connect the AV equipment's DVI output jack to the LCD TV's HDMI IN jacks.
Use an audio cable to connect the AV equipment's audio output jacks to LCD TV's HDMI AUDIO jacks.
- 2 Connect all AC power sources, before turning on the power switch of the LCD TV or other connected equipment.
- 3 Press the  button on the remote to turn on the LCD TV.
- 4 Press the **Input** button on the remote to select **VIDEO6**.



If the LCD TV is connected to AV equipment's DVI connector, you will need an HDMI-to-DVI cable or an HDMI adapter(not supplied) and an audio cable.

Connecting a PC

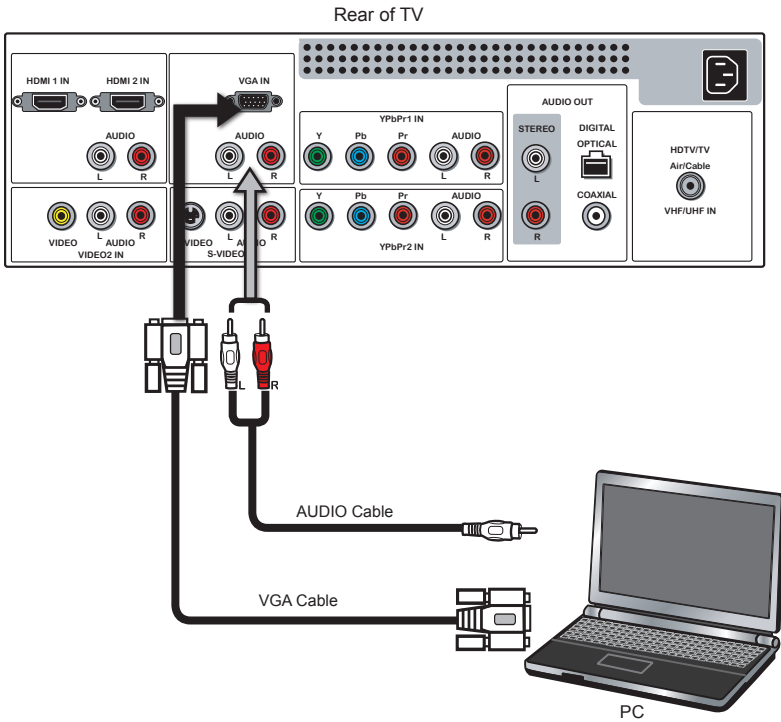

- 1 Use a D-SUB cable to connect the PC's D-SUB output jack to the LCD TV's VGA input jack. Use an audio cable to connect the PC's audio output jacks to LCD TV's.
- 2 Connect all AC power sources, before turning on the power switch of the LCD TV or other connected equipment.
- 3 Press the **POWER** button on the remote to turn on the LCD TV.
- 4 Press the **Input** button on the remote to select **COMPUTER**.

Connecting an Audio Receiver or a Dolby Digital 5.1 Sound System

For better sound quality, you may want to play the LCD TV audio through your stereo system.

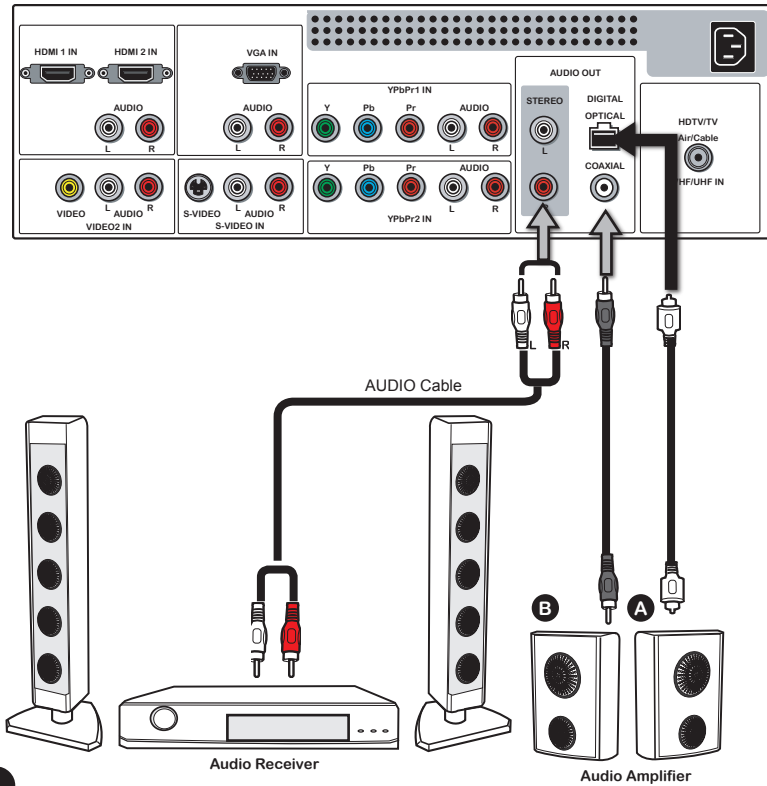

1

Connecting to Audio Receiver:

Use an audio cable to connect the audio receiver's audio LINE IN jacks to LCD TV's AUDIO OUT jacks.

2

Connecting to Digital 5.1 Sound System:

METHOD A:

Use a optical cable to connect the audio amplifier's OPTICAL IN jacks to LCD TV's OPTICAL OUT jacks.

METHOD B:

Use a coaxial cable to connect the audio amplifier's COAXIAL IN jacks to LCD TV's COAXIAL OUT jacks.

3

Connect all AC power sources, before turning on the power switch of the LCD TV or other connected equipment.

4

Press the  button on the remote to turn on the LCD TV.

Chapter 3

USING THE FEATURES

Using Picture-In-Picture

The PIP/POP feature allows simultaneous viewing of video from two sources (TV, VCR, DVD etc). Only one source's audio is played at a time; the user may select which source's audio is heard.

- 1 Press the **PIP** button once to enter picture in picture mode.

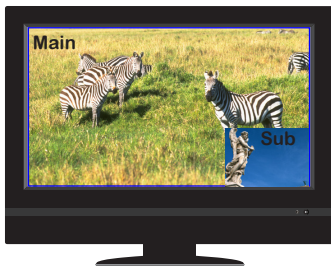

- Press ◀ ▶ to toggle the audio source between the main window and the sub window.
- Press the **OK** button to change the position of the sub window.

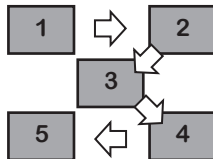

- Press ◀ ▶ to activate either the main or sub window, then press the **Input** button to display the Input List:

Input source
VIDEO4 (YPbPr1)
VIDEO5 (YPbPr2)
✓ VIDEO6 (HDMI)
COMPUTER (VGA)

✓ TV(CABLE/AIR)
VIDEO1 (SIDE)
VIDEO2 (REAR)
VIDEO3 (S-VIDEO)
VIDEO4 (YPbPr1)
VIDEO5 (YPbPr2)
COMPUTER (VGA)

Press ▲ ▼ to change input source and press the **OK** button.

- 2** Press the **PIP** button again to view images side by side.

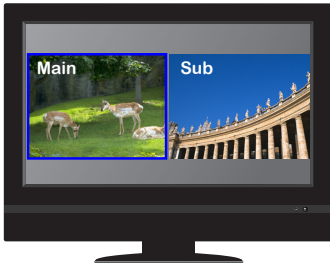

- Press ◀ ▶ to toggle the audio source between the main window and the sub window.
- Press the **SWAP** button to swap the pictures between the main and sub windows.

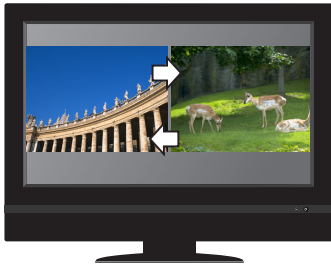

- Press ◀ ▶ to activate either the main or sub window, then press the **Input** button to display the Input List:

Input source
VIDEO4 (YPbPr1)
VIDEO5 (YPbPr2)
✓ VIDEO6 (HDMI)
COMPUTER (VGA)

✓ TV(CABLE/AIR)
VIDEO1 (SIDE)
VIDEO2 (REAR)
VIDEO3 (S-VIDEO)
VIDEO4 (YPbPr1)
VIDEO5 (YPbPr2)
COMPUTER (VGA)

Press ▲ ▼ to change input source and press the **OK** button.

- 3** Press the **PIP** button again to exit.

Wide Screen Viewing

Wide Screen function allows viewing of 4:3/16:9 images in wide screen mode, cycling through the following wide screen settings. Press the **P.SIZE** button repeatedly to select the screen format you want.

1

FULL

Stretches the image vertically and horizontally to keep the image size consistent in the center of the screen and stretches the sides

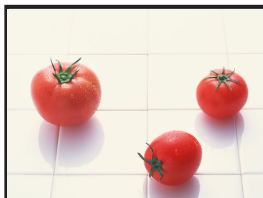

2

ZOOM

Stretches the image vertically and horizontally to fill the screen at 1:2.35 aspect ratio



3

WIDE

Stretches the image vertically and horizontally to fill the screen at 1:1.85 aspect ratio



4

NORMAL

Displays at 4:3 aspect ratio

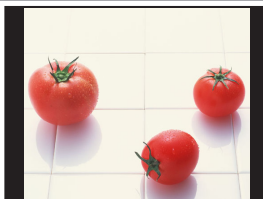

NORMAL is not available when you are watching 720p, 1080i, or 1080p source.

Using the Program Guide

The Program Guide feature brings all sorts of information to your screen, such as program title, program duration, time remaining, rating information, closed caption, availability, etc.

- 1 With the LCD TV connected to a television programming source, press the **TV** button on the remote control.
- 2 Press the **GUIDE** button on the remote control, the Program Guide will appear on the screen:





- 3 Press the ◀▶ button to select the channel.
- 4 Press the ▲▼ button to select the program from a list, the Program Guide provides introduction about the current program being shown on each channel. The Program information in the guide is provided by the broadcasters. It may sometimes include only the channel number, without a program title or description.



- 5 Press the **GUIDE** button again on the remote control to exit the Program Guide

Operating the Menu

1 Press the  button to turn the LCD TV on.

2 Press the **MENU** button on the remote control, the on-screen menu will appear on the screen. Use the   buttons to select your main menu option.

VIDEO MENU:

Allows you to make adjustments to your picture settings.

- If the signal source is TV/VIDEO/SVIDEO/YpPr/HDMI, the VIDEO MENU appears as:
- If the signal source is VGA, the VIDEO MENU appears as:

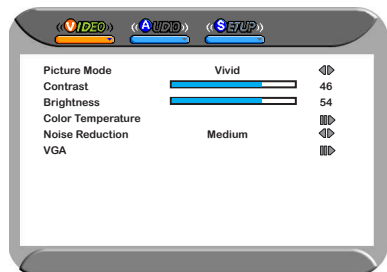
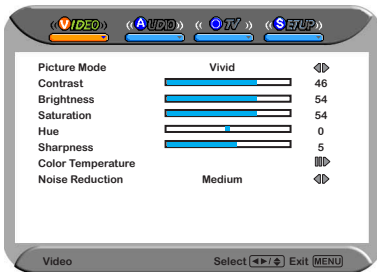

AUDIO MENU:

Allows you to customize the audio options and effects.

- If the signal source is VIDEO/SVIDEO/YpPr/HDMI/VGA, the AUDIO MENU appears as:
- If the signal source is TV, the AUDIO MENU appears as:

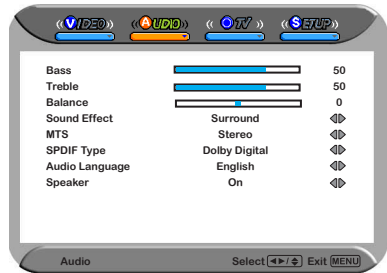
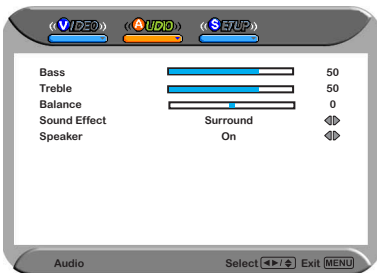

TV MENU:

Allows you to edit and label channels.

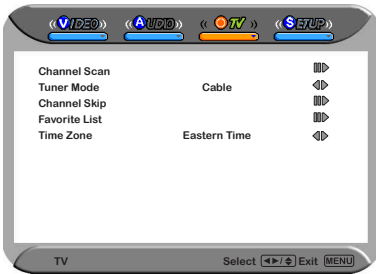
**SETUP MENU:**

Allows you to set up a variety of features: Language, Closed Caption, reset, Parental Control, sleep timer.

- If the signal source is TV, the SETUP MENU appears as:

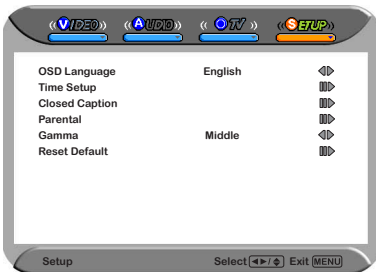

- if the signal source is VGA, the SETUP MENU appears as:

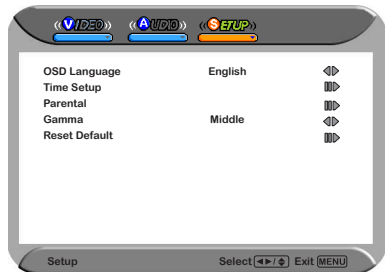

- If the signal source is VIDEO/SVIDEO/YPbPr/HDMI, the SETUP MENU appears as:

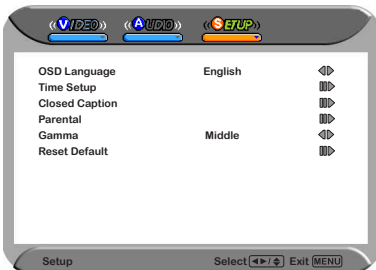

- Use the ▲▼ buttons to highlight the option of the sub-menu, and press the **OK** button. While in adjustment mode, and use the ◀▶ buttons to change the value of the item.

- Press the **EXIT** button to exit the menu.

Customizing the VIDEO Settings

- 1 Press the **⏻** button to turn the LCD TV on.
- 2 Press the **MENU** button on the remote control to display the Main menu, and use the **◀▶** buttons to select the **VIDEO**.
- 3 Use the **▲▼** buttons to highlight an individual VIDEO option, use the **◀▶** buttons to change the setting, and press the **MENU** to exit the menu

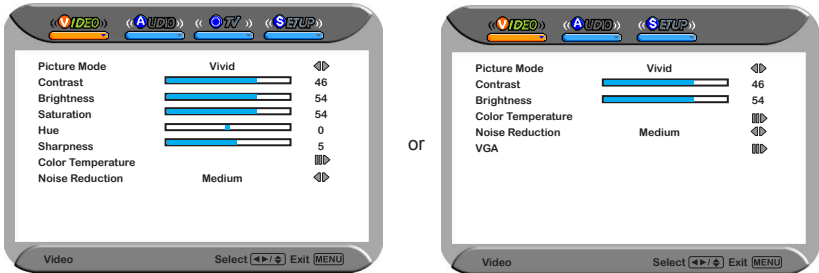

- 4 The **VIDEO** menu includes the following options:

Picture Mode	Cycles among display types: Vivid/Hi-Bright/Cinema/Sport/User
Contrast	Controls the difference between the brightest and darkest regions of the picture
Brightness	Controls the overall brightness of the picture
Saturation	Controls the color intensity
Hue	Controls the difference between the green and red regions of the picture
Sharpness	Increase this setting to see crisp edges in the picture; decrease it for soft edges

- Color temperature** Adjusts color components independently to achieve a warm or cool effect: Cool/Middle/Warm/User
- **Warm:** Increases red tint
 - **Natural :** Increases natural tint
 - **Cool :** Increases blue tint
 - **User :** Allows the user to adjust red, green and blue color component levels independently.

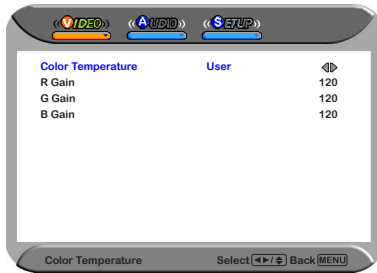

- Noise Reduction** Select to reduce the noise level of connected equipment: Off/Low/Strong /Medium.

VGA

Press the **OK** button to enter the VGA Setting:

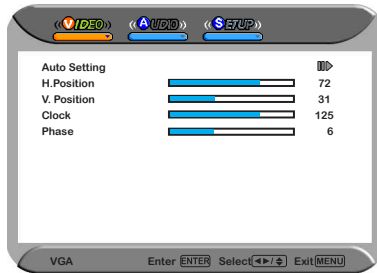

- **Auto Setting** Press the **OK** button to automatically adjust the display settings to optimize performance based on the VGA mode
- **H. Position** Adjusts the position of the picture left and right in the window
- **V. Position** Adjusts the position of the picture up and down in the window
- **Clock** Controls the width of the picture based on the VGA mode
- **Phase** Controls the signal phase, which can improve focus clarity and image stability based on the VGA mode

Customizing the AUDIO Settings

- 1 Press the **⏻** button to turn the LCD TV on.
- 2 Press the **MENU** button on the remote control to display the Main menu, and use the **◀▶** buttons to select the **AUDIO**.
- 3 Use the **▲▼** buttons to highlight an individual AUDIO option, use the **◀▶** buttons to change the setting, and press the **MENU** to exit the menu

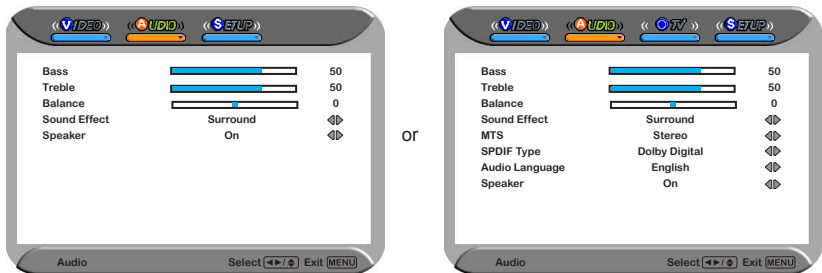

- 4 The **AUDIO** menu includes the following options:

Bass	Controls the relative intensity of lower-pitched sounds
<hr/>	
Treble	Controls the relative intensity of higher pitched sounds
<hr/>	
Balance	Adjusts the relative volume of the speakers in a multiple speaker system
<hr/>	
Sound Effect	Allows selection of an audio-enhancement technique from among the following options: Surround/Live/Dance/Techno/Classic/Soft/Rock/POP/Off
<hr/>	
Speaker	<ul style="list-style-type: none"> ▪ On: Selects to turn on the TV speakers. ▪ OFF: Selects to turn off the TV speakers and listen to the TV's sound through the external audio receiver and speakers
<hr/>	
MTS	Allows you to listen to high-fidelity stereo sound while watching TV
<hr/>	
	<ul style="list-style-type: none"> ▪ Stereo: Use separate audio tracks for left and right speakers, if available ▪ SAP: You can enjoy a second audio program from the speakers while watching a scene in the original program ▪ Mono: Allows mono output (useful when stereo is noisy or inconsistent)
<hr/>	

SPDIF Type	<p>Allows to selection of the digital sound format: PCM/OFF/Dolby Digital</p> <ul style="list-style-type: none">▪ PCM: The external audio system is connected to the AUDIO OUT (L/R) of the LCD TV▪ Dolby Digital: The external audio system is connected to the AUDIO OUT DIGITAL (OPTICAL or COAXIAL) of the LCD TV▪ OFF: Select OFF to turn off the external audio system
Audio Language	<p>Allows to select the audio language:English/Spanish/French.</p>

Customizing the TV Settings

- 1 Press the **⏻** button to turn the LCD TV on.
- 2 Press the **MENU** button on the remote control to display the Main menu, and use the **◀▶** buttons to select the **TV**.
- 3 Use the **▲▼** buttons to highlight an individual TV option, use the **◀▶** buttons changes the setting, and press the **MENU** exits the menu.

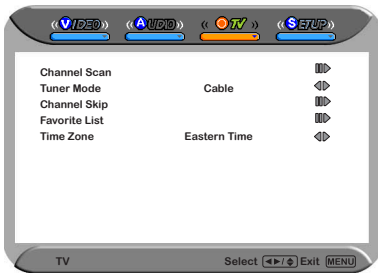

- 4 The **TV** menu includes the following options:

Channel Scan Press the **OK** button, the Channel Scanning automatically creates a list of receivable channels.

Tuner Mode Allows selection between TV cable and antenna signal sources:

- **AIR**
Choose this setting if you are receiving TV channels with an antenna (over the air)
- **Cable**
Choose this setting if you are receiving TV channels with a CATV (cable TV)

Channel Skip Allows addition/removal of channels on the channel list.
1 Press the **OK** button to display the Channel Skip menu:

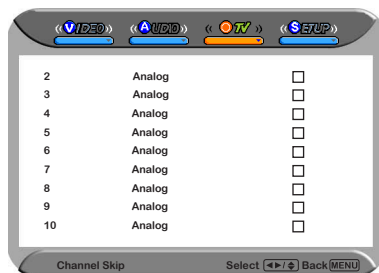

- ② Press the ▼ button to select the desired channel, and press the **OK** button repeatedly to select **show** (☑) or **hide** (☐)

Favorite List

- ① Select **Favorite List** from the TV option and press the **OK** button. The Favorite List menu appears:

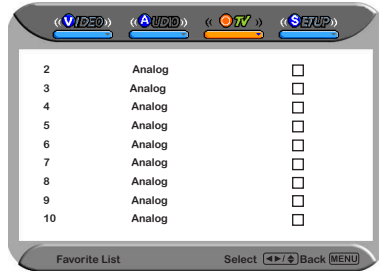

- ② Press the ▼ button to select the desired channel, and press the **OK** button repeatedly to select **show** (☑) or **hide** (☐)

Time Zone

Allows selection of regional TV systems of USA: Eastern Time/Indiana/Central time/Mountain Time/Arizona/Pacific Time/Alaska/Hawaii

Customizing the SETUP Settings

- 1 Press the **⏻** button to turn the LCD TV on.
- 2 Press the **MENU** button on the remote control to display the Main menu, and use the **◀▶** buttons to select the **SETUP**.
- 3 Use the **▲▼** buttons to highlight an individual SETUP option, use the **◀▶** buttons to change the setting, and press the **MENU** to exit the menu.

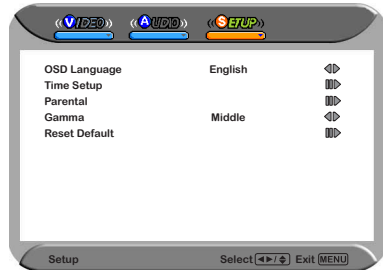
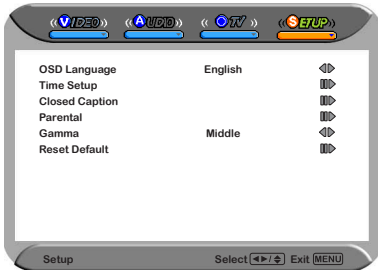

- 4 The **SETUP** menu includes the following options:

OSD Language Selects to display all on-screen menus in your language of choice: English/French/Spanish

Time Setup Allows to set the current time.

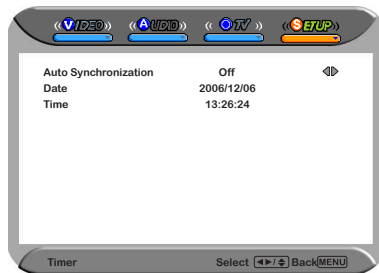

- **ON** :Selects to display the system current time.
- **OFF** :Selects to set the current time.
 - 1 Press the **▲▼** buttons to select the Date or Time.
 - 2 Press the **◀▶** buttons to move each setting, and use 0-9 keys to set the current time.

Closed Caption

Allows to select from analog or digital closed caption modes and press the **OK** button. The Closed Caption list appears:

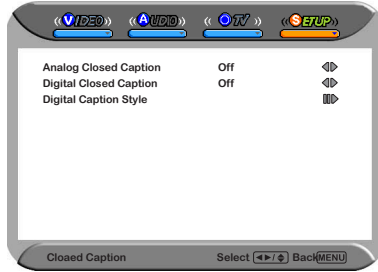
**1 Analog Closed Caption:**

Press the ◀▶ buttons to select the basic analog closed caption options:

▪ **CC1 /CC2 /CC3 /CC4:**

Display a printed version of the dialog and sound effects of the program being viewed

▪ **T1/T2:**

Display station information presented using either half or the whole screen

▪ **T3/T4:**

Extended Data Services. For example: Network name, program name, program length, etc.

2 Digital Closed Caption:

Press the ◀▶ buttons to select the digital closed caption options: Service1/Service2/Service3/Service4/Service5/Service6/OFF

Note: The setting here will be applied to each DTV channel

3 Caption Style:

Press **OK** button to customize the settings for digital closed caption option:

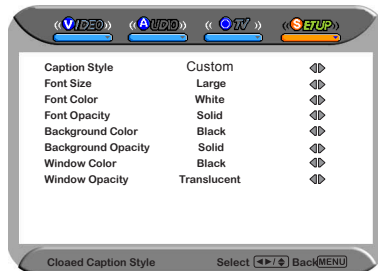

Parental

The Parental Control can be set up to the TV to block Channel, Video Source and to change password.

- 1 Use the **▼** button to select the **Parental**, and press the **OK** to display the Parental menu
- 2 Use the **Program Block** function, must enter a four-digit password. The factory password is 0000
- 3 The Parental list appears:

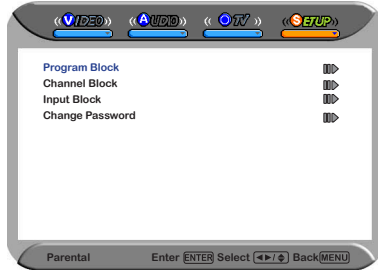

▪ **Program Block**

Allows to setup the TV and MPAA Rating Lock options (refer to "Using the Program Block Setting").

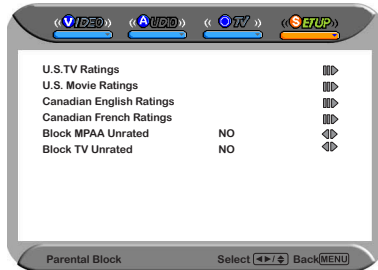

▪ **Channel Block** Allows to block digital channels.

- 1 Press the **▲▼** buttons to select the channel.
- 2 Press the **OK** button repeatedly to select **BLOCK** or **UNBLOCK** .

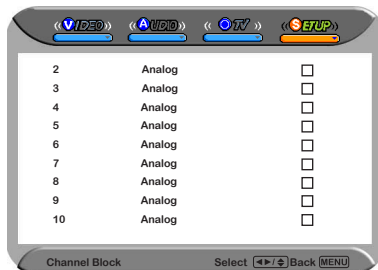

- **Input Block**

Selects to block a Input source signal

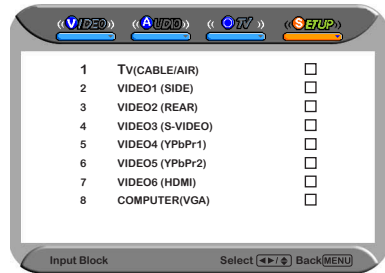

- 1 Press the ▲▼ buttons to select the input source.
- 2 Press the OK button repeatedly to select **BLOCK** or **UNBLOCK** .

- **Change Password** Selects to change your password

Gamma

Allows adjustment of the display's gamma correction, which fine tunes both brightness and red/green/blue ratios: Bright/Middle/Dark.

Reset Default

Press the OK button to restore factory settings

Using the Program Block Settings

- 1 Press the **MENU** button on the remote control to display the Main menu, and use the **◀▶** buttons to select the **SETUP**.
- 2 Use the **▼** buttons to highlight **Parental**, and press the **OK** button.

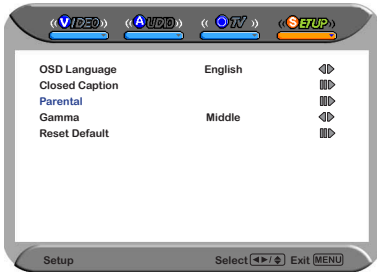

- 3 Use the **Parental** function, must enter a four-digit password. The factory password is 0000.

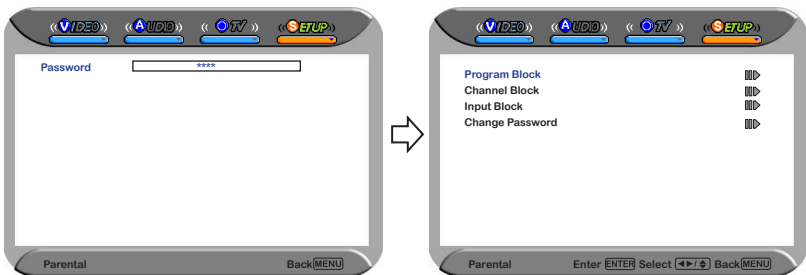

- 4 Use the **▼** button to select the **Program Block**, and press the **OK** to display the Program Block menu.

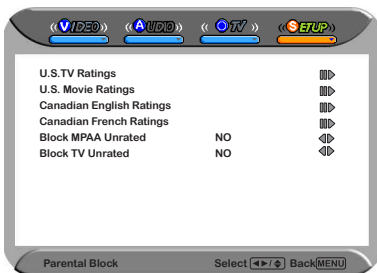

5

The **Parental block** menu includes the following options:

U.S. TV Ratings	Selects to activate the TV Rating programs.
U.S. Movie Ratings	Selects to activate the MPAA Rating programs.
Canadian English Ratings	Selects to activate the English Rating programs of Canada.
Canadian French Ratings	Selects to activate the French Rating programs of Canada
Block MPAA Unrated	<ul style="list-style-type: none"> ▪ YES: Block all movies that are broadcast without a MPAA rating. ▪ NO: Allows all movies that are broadcast without a MPAA rating
Block TV Unrated	<ul style="list-style-type: none"> ▪ YES: Block all movies that are broadcast without a TV rating. ▪ NO: Allows all movies that are broadcast without a TV rating.

U.S. TV Ratings

The U.S.TV Rating has 2 rating methods: Content-Based Rating and Age-Based Rating. The U.S.TV Rating includes the following options:

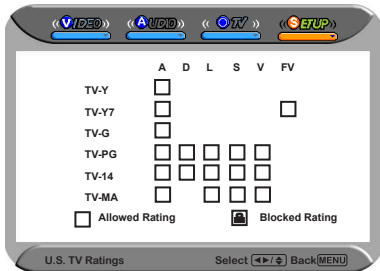

AGE-BASED

RATING	DESCRIPTION
TV-Y	All children
TV-Y7	Directed to children age 7 and older
TV-G	General Audience
TV-PG	Parental Guidance suggested
TV-14	Parents strongly cautioned
TV-MA	Mature Audience only

CONTENT-BASED

RATING	DESCRIPTION
FV	Fantasy violence
D	Suggestive dialogue
L	Strong language
S	Sexual situations
V	Violence
ALL	All contents are blocked

		CONTENT-BASED				
		FV	D	L	S	V
AGE-BASED	TV-Y					
	TV-Y7	✓				
	TV-G					
	TV-PG		✓	✓	✓	✓
	TV-14		✓	✓	✓	✓
	TV-MA			✓	✓	✓

✓ : To block programs by both content and age.



Use the ◀▶▲▼ buttons to select the rating you want and press the OK button repeatedly to select **BLOCK** or **UNBLOCK** .

Canadian English Ratings

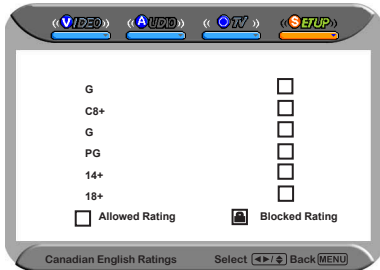
The Canadian English Ratings includes the following options:



RATING	DESCRIPTION
G	All children
C8+	Children 8 years and older
G	General programming
PG	Parental guidance
14+	Viewers 14 and older
18+	Adult programming



Use the ◀▶ ▲▼ buttons to select the rating you want and press the **OK** button repeatedly to select **BLOCK**  or **UNBLOCK** .

Canadian French Ratings

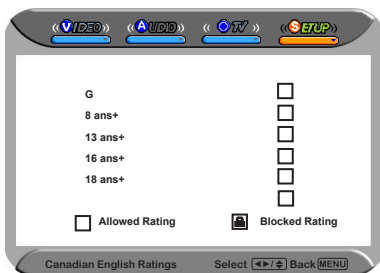
The Canadian French Ratings includes the following options:



RATING	DESCRIPTION
G	General programming
8 ans+	Not recommended for ages under 8
13 ans+	Not recommended for ages under 13
16 ans+	Not recommended for ages under 16
18 ans+	Programming restricted to adults.

Use the ◀▶ ▲▼ buttons to select the rating you want and press the **OK** button repeatedly to select **BLOCK**  or **UNBLOCK** .

U.S. Movie Ratings

The U.S. Movie Ratings is used for original movies rated by the Motion Picture Association of America(MPAA) as broadcasted on cable TV and not edited for television. The U.S. Movie Ratings includes the following options:

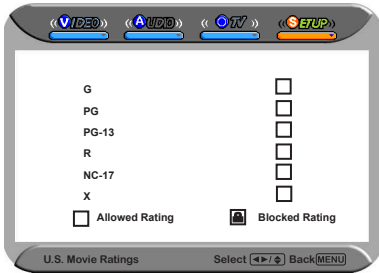

RATING	DESCRIPTION
G	General Audiences. Movie is appropriate for all ages
PG	Parental Guidance Suggested. May contain material not suited for younger viewers
PG-13	Contains content that may not be appropriate for viewers under the age of 13
R	Restricted. Contains adult content, no one under 17 admitted without parent
NC-17	No one 17 and under admitted
X	No one 17 and under admitted

Use the ◀▶▲▼ buttons to select the rating you want and press the OK button repeatedly to select BLOCK or UNBLOCK .

SPECIFICATIONS

MODEL		LVQ-32EF1A	LVQ-37EF1A
LCD Panel	Panel Size	32" TFT LCD	37" TFT LCD
	Brightness	500	500
	Contrast Ratio	800:1	1000:1
Max. Resolution		1366x768	1366x768
Input Connector	VIDEO/AUDIO(L/R)	2	2
	S-VIDEO/AUDIO(L/R)	1	1
	YPbPr/AUDIO(L/R)	2	2
	VGA/AUDIO(L/R)	1	1
	HDMI/AUDIO(L/R)	1	1
Output Connector	AUDIO OUT(L/R)	1	1
	OPTICAL/COAXIAL	1	1
	HEADPHONE	1	1
Power Source		AC100~240V, 50/60HZ, 2.2A	AC100~240V, 50/60HZ, 3.0A
Power Consumption		180 W, standby < 5 W	275 W, standby < 5 W
Dimension		31.7 w x 25.0 h x 9.3 d inch	36.6 w x 28.1 h x 10.4 d inch
WEIGHT		33.0 lbs	48.5 lbs

DISPLAY MODE

The screen resolution has been optimized during manufacture for the display modes listed below. If the signal from the system equals the standard signal mode, the screen is adjusted automatically. If the signal from the system does not equal the standard signal mode, adjusting the screen resolution by referring to your video card user guide otherwise there may be no video,

Video signal: (VGA Standard)

Resolution (Dot X Line)	Vertical Frequency(Hz)	Horizontal Frequency(kHz)
640 x 350	85	37.9
640 x 400	85	37.9
720 x 400	85	37.9
640 x 480	60	31.5
	72	37.9
	75	37.5
	85	43.3
800 x 600	56	35.1
	60	37.9
	72	48.1
	75	46.9
	85	53.7
1024 x 768	60	48.4
	70	56.5
	75	60.0
	85	68.7
1152 x 864	75	67.5
1280 x 960	60	60.0
1280 x 1024	60	64.0
1366 x 768	60	47.7