

LCD TELEVISION

AVC (Audio Video Control Center) & LCD Display Monitor

Operating Guide for 32HDL51

IMPORTANT SAFETY INSTRUCTIONS 2-3

FIRST TIME USE 4-26

THE REMOTE CONTROL 27-49

ON-SCREEN DISPLAY 50-77

USING THE RGB INPUT OF THE LCD TV 78-87

CARE OF YOUR HITACHI LCD TV & REMOTE CONTROL 88

RECEPTION PROBLEMS 89

USEFUL INFORMATION/INDEX 90-98



IMPORTANT SAFETY INSTRUCTIONS





SAFETY POINTS YOU SHOULD KNOW ABOUT YOUR HITACHI LCD TELEVISION

Our reputation has been built on the quality, performance, and ease of service of HITACHI LCD televisions.

Safety is also foremost in our minds in the design of these units. To help you operate these products properly, this section illustrates safety tips which will be of benefit to you. Please read it carefully and apply the knowledge you obtain from it to the proper operation of your HITACHI LCD television.

Please fill out your warranty card and mail it to HITACHI. This will enable HITACHI to notify you promptly in the improbable event that a safety problem should be discovered in your product model.

Follow all warnings and instructions marked on this LCD television. LCD television consists of AVC center and display Monitor.

 <table border="1"> <tr><td>CAUTION</td></tr> <tr><td>RISK OF ELECTRIC SHOCK DO NOT OPEN</td></tr> </table> 	CAUTION	RISK OF ELECTRIC SHOCK DO NOT OPEN	 <p>The lightning flash with arrowhead symbol, within an equilateral triangle, is intended to alert the user to the presence of uninsulated "dangerous voltage" within the product's enclosure that may be of a sufficient magnitude to constitute a risk of electric shock to persons.</p>
CAUTION			
RISK OF ELECTRIC SHOCK DO NOT OPEN			
<p>CAUTION: TO REDUCE THE RISK OF ELECTRIC SHOCK, DO NOT REMOVE COVER (OR BACK). NO USER SERVICEABLE PARTS INSIDE. REFER SERVICING TO QUALIFIED SERVICE PERSONNEL.</p>	 <p>The exclamation point within an equilateral triangle, is intended to alert the user to the presence of important operating and maintenance (servicing) instructions in the literature accompanying the appliance.</p>		

WARNING:

- TO REDUCE THE RISK OF FIRE OR ELECTRIC SHOCK, DO NOT EXPOSE THIS APPARATUS TO RAIN OR MOISTURE.
- THE LCD TELEVISION SHOULD NOT BE EXPOSED TO DRIPPING OR SPLASHING AND OBJECTS FILLED WITH LIQUIDS, SUCH AS VASES, SHOULD NOT BE PLACED ON THE TELEVISION.

NOTE:

- There are no user serviceable parts inside the AVC center/display monitor.
- Model and serial numbers are indicated on back side of the AVC center/display monitor.

CAUTION: Adjust only those controls that are covered in the instructions, as improper changes or modifications not expressly approved by HITACHI could void the user's authority to operate the television.



MODIFICATIONS: The FCC requires the user to be notified that any changes or modifications made to this device that are not expressly approved by Hitachi America, Ltd. Home Electronics Division may void the user's authority to operate the equipment.

POWER SOURCE

THIS TELEVISION IS DESIGNED TO OPERATE ON 120 VOLTS 60Hz, AC CURRENT. INSERT THE POWER CORD INTO A 120 VOLT 60Hz OUTLET.

TO PREVENT ELECTRIC SHOCK, DO NOT USE THE TELEVISION'S (POLARIZED) PLUG WITH AN EXTENSION CORD, RECEPTACLE, OR OTHER OUTLET UNLESS THE BLADES AND GROUND TERMINAL CAN BE FULLY INSERTED TO PREVENT BLADE EXPOSURE.

NEVER CONNECT THE TELEVISION TO 50Hz, DIRECT CURRENT, OR ANYTHING OTHER THAN THE SPECIFIED VOLTAGE.

NOTE: This television receiver will display television closed captioning, ( or ) , in accordance with paragraph 15.119 of the FCC rules.

 **CAUTION:** Never remove the back cover of the AVC center/display monitor as this can expose you to very high voltages and other hazards. If the television does not operate properly, unplug the LCD television and call your authorized dealer or service center.

IMPORTANT SAFETY INSTRUCTIONS



Read before operating equipment

Follow all warnings and instructions marked on this television.

1. Read these instructions.
2. Keep these instructions.
3. Heed all warnings.
4. Follow all instructions.
5. Do not use this apparatus near water.
6. Clean only with a dry cloth.
7. Do not block any ventilation openings. Install in accordance with the manufacturer's instructions.
8. Do not install near any heat sources such as radiators, heat registers, stoves, or other apparatus (including amplifiers) that produce heat.
9. Do not defeat the safety purpose of the polarized or grounding-type plug. A polarized plug has two blades with one wider than the other. A grounding type plug has two blades and a third grounding prong. The wide blade or the third prong are provided for your safety. If the provided plug does not fit into your outlet, consult an electrician for replacement of the obsolete outlet.
10. Protect the power cord from being walked on or pinched particularly at plugs, convenience receptacles, and the point where they exit from the apparatus.
11. Only use the attachments/accessories specified by the manufacturer.
12.  Use only with the cart, stand, tripod, bracket, or table specified by the manufacturer, or sold with the apparatus. When a cart is used, use caution when moving the cart/apparatus combination to avoid injury from tip-over.
13. Unplug this apparatus during lightning storms or when unused for long periods of time.
14. Refer all servicing to qualified service personnel. Servicing is required when the apparatus has been damaged in any way, such as power-supply cord or plug is damaged, liquid has been spilled or objects have fallen into apparatus, the apparatus has been exposed to rain or moisture, does not operate normally, or has been dropped.

15. Televisions are designed to comply with the recommended safety standards for tilt and stability. Do not apply excessive pulling force to the front, or top, of the cabinet which could cause the product to overturn resulting in product damage and/or personal injury.
16. Follow instructions for wall, shelf or ceiling mounting as recommended by the manufacturer.
17. An outdoor antenna should not be located in the vicinity of overhead power lines or other electrical circuits.
18. If an outside antenna is connected to the receiver be sure the antenna system is grounded so as to provide some protection against voltage surges and built up static charges. Section 810 of the National Electric Code, ANSI/NFPA No. 70-1984, provides information with respect to proper grounding for the mast and supporting structure, grounding of the lead-in wire to an antenna discharge unit, size of grounding connectors, location of antenna-discharge unit, connection to grounding electrodes and requirements for the grounding electrode.

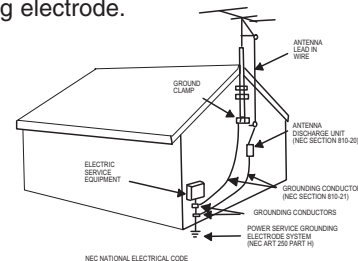

Note to the CATV system installer: This reminder is provided to call the CATV system installer's attention to Article 820-40 of the NEC that provides guidelines for proper grounding and, in particular, specifies that the cable ground shall be connected to the grounding system of the building, as close to the point of cable entry as practical.

Do not place any objects on the top of the television which may fall or cause a child to climb to retrieve the objects.

- **This product contains lead and lamps that contains mercury. Dispose of this product and its lamps in accordance with applicable environmental laws. For lamp recycling and disposal information, go to www.lamprecycle.org. For product recycling and disposal information, contact your local government agency or the Electronic Industries Alliance at www.eiae.org (in the US) or the Electronic Product Stewardship Canada at www.epsc.ca (in Canada). For more information, call "1-800-HITACHI."**

PUBLIC VIEWING OF COPYRIGHTED MATERIAL

Public viewing of programs broadcast by TV stations and cable companies, as well as programs from other sources, may require prior authorization from the broadcaster or owner of the video program material.

- This digital television is capable of receiving analog basic, digital basic and digital premium cable television programming by direct connection to a cable system providing such programming. A CableCARD provided by your cable operator is required to view encrypted digital programming. Certain advanced and interactive digital cable services such as video-on-demand, a cable operator's enhanced program guide and data-enhanced television services may require the use of a set-top box. For more information call your local cable company.
- This product incorporates copyright protection technology that is protected by U.S. patents and other intellectual property rights. Use of this copyright protection technology must be authorized by Macrovision Corporation, and is intended for home and other limited consumer uses only unless otherwise authorized by Macrovision. Reverse engineering or disassembly is prohibited.



ACCESSORIES

Check to make sure you have the following accessories before disposing of the packing material.

FIRST TIME USE

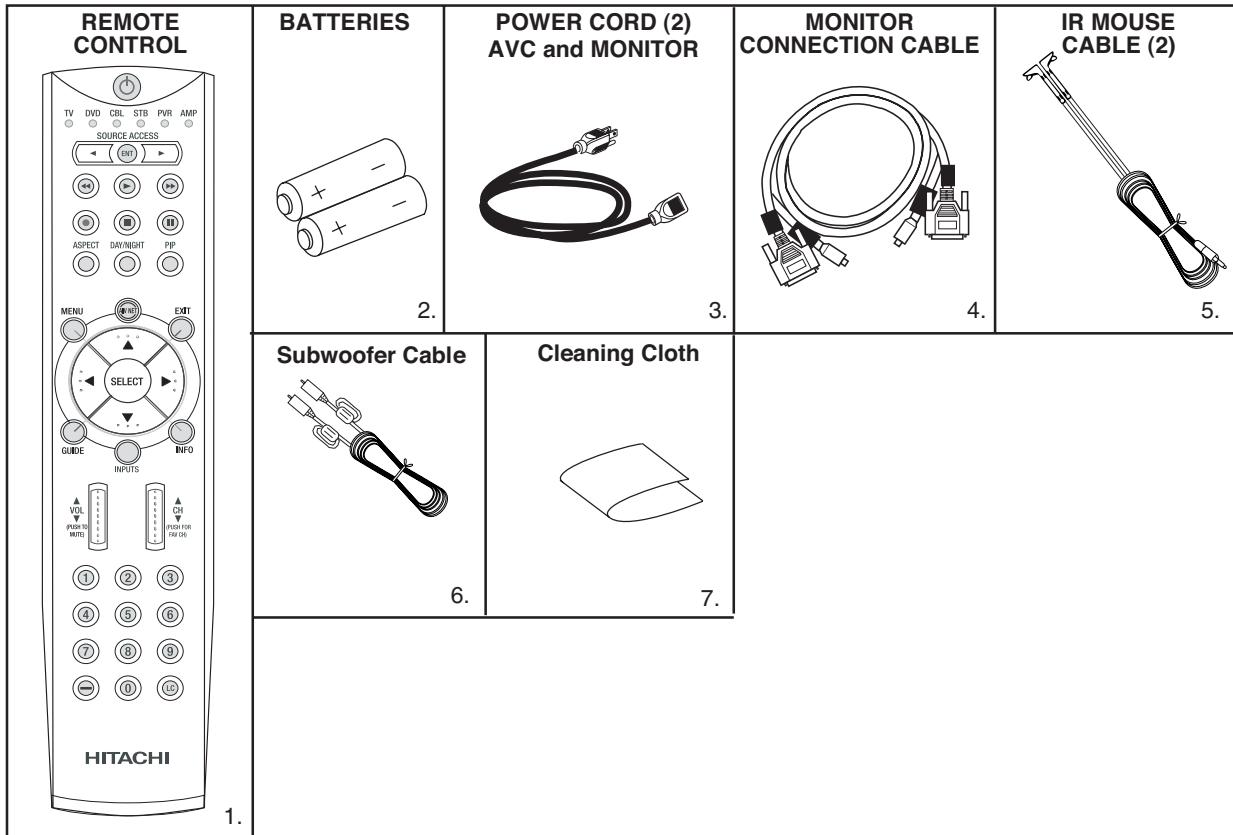

CAUTION: 1. Ceiling mounting is not recommended. Mounting the panel on the ceiling does not provide adequate ventilation for the electronics or proper support for the front glass panel.

- 1. Remote Control Unit CLU-3841WL (P# HL02061) or CLU-3843WL (P# HL02063).
- 2. Two "AA" size, 1.5V batteries (P# FQ00021).
- 3. Power Cord:

	32"
LCD Monitor	EV01841
AVC	EV01841
- 4. Monitor Connection Cable (P# EW07883).
- 5. Two IR Mouse cables (P# EY01641).
- 6. Sub Woofer Cable (P# VZ11701).
- 7. Cleaning Cloth (P# MS00931).

REMOTE CONTROL BATTERY INSTALLATION AND REPLACEMENT

- 1. Open the battery cover of the remote control by pushing the notched part of the cover with your fingers and pulling the cover off.
- 2. Insert two new "AA" size batteries for the remote control. When replacing old batteries, push them towards the springs and lift them out.
- 3. Match the batteries to the (+) and (-) marks in the battery compartment.
- 4. Replace the cover.

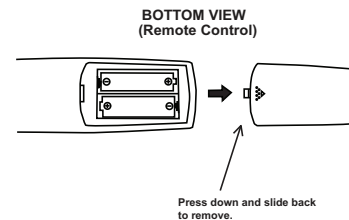

CAUTION: Danger of explosion if battery is incorrectly replaced. Replace with the same or equivalent type.

HOW TO SETUP YOUR NEW HITACHI LCD TELEVISION

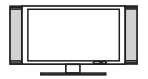

To take measures to prevent the LCD Display from tipping over and prevent possible injury it is important to mount the unit in a stable place.

Securing to a table-top

1. Using wood screws (two) fasten the set to the clamping screw holes on the rear of the LCD Display stand as shown below.
2. Using commercially available wood screws, secure the set firmly in position.
3. Leave some space around the unit for proper operation of the power swivel stand.

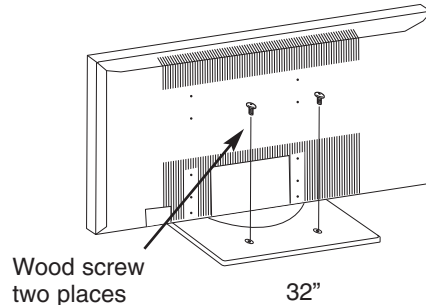

Securing to a wall

1. Keep the LCD Display monitor four inches away from the wall except those hung to a wall mount bracket.
2. Secure the monitor to the wall as shown below.

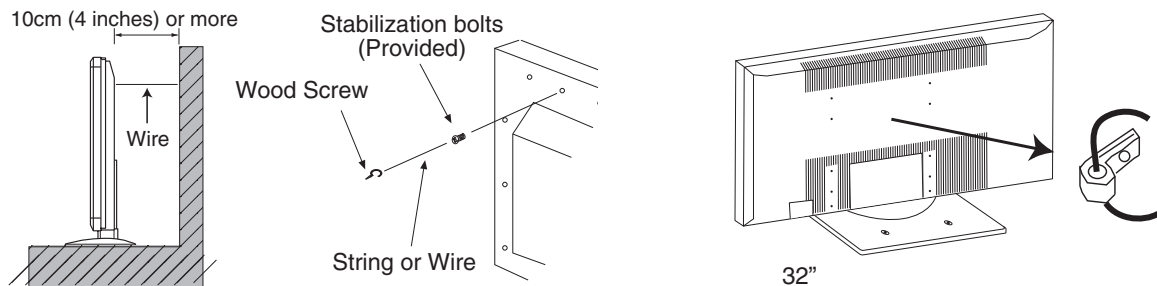

- NOTES:**
1. Do not block the ventilation holes of the LCD Display monitor or the AVC center. Blocking the ventilation holes might cause fire or defect.
 2. The LCD television has two AC cords, one on the AVC center and the other on the LCD Display monitor. In case of an abnormal symptom, unplug both AC cords.

Caution when moving the main unit

As this product is heavy, whenever it is moved, two people are required to transport it safely. Whenever the unit is moved it should be lifted forward using the top and bottom frame on both sides of the 32" for stability, as shown below.

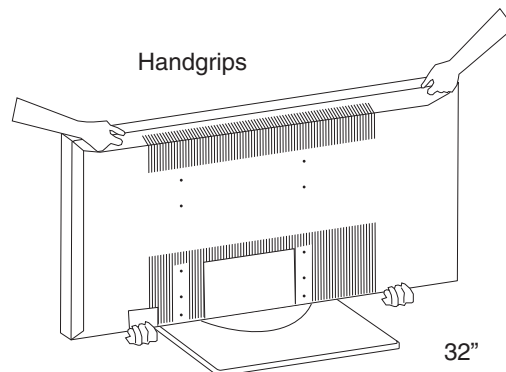

ANTENNA

Unless your LCD Television is connected to a cable TV system or to a centralized antenna system, a good outdoor color TV antenna is recommended for best performance. However, if you are located in an exceptionally good signal area that is free from interference and multiple image ghosts, an indoor antenna may be sufficient.

LOCATION

Select an area where sunlight or bright indoor illumination will not fall directly on the picture screen. Also, be sure that the location selected allows a free flow of air to and from the perforated back cover of the set.

To avoid cabinet warping, cabinet color changes, and increased chance of set failure, do not place the TV where temperatures can become excessively hot, for example, in direct sunlight or near a heating appliance, etc.

When installing your LCD TV against a wall, keep it at least 10 cm (4 inches) from the wall.



HOW TO SET UP YOUR NEW HITACHI LCD TELEVISION

FIRST TIME USE

VIEWING

The major benefit of the HITACHI LCD Television is its large viewing screen. To see this large screen at its best, test various locations in the room to find the optimum spot for viewing. The best picture is seen by sitting directly in front of the TV and about 8 to 18 feet from the screen.

During daylight hours, reflections from outside light may appear on the screen. If so, drapes or screens can be used to reduce the reflection or the TV can be located in a different section of the room.

If the TV's audio output will be connected to a Hi-Fi system's external speakers, the best audio performance will be obtained by placing the speakers equidistant from each side of the receiver cabinet and as close as possible to the height of the picture screen center. For best stereo separation, place the external speakers at least four feet from the side of the TV, place the surround speakers to the side or behind the viewing area. Differences in room sizes and acoustical environments will require some experimentation with speaker placement for best performance.

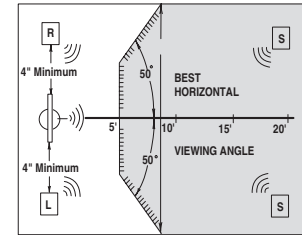
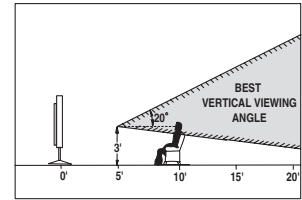

IMPORTANT NOTES

No.	Items	Notes
1	Arching sound from LCD display monitor's panel.	A buzzing sound might be heard when the LCD display monitor is turned on in a very quiet room. This is due to the LCD panel drive circuit when it is functioning. This arching sound is normal and it is not a malfunction.
2	Interference for infrared equipment.	Some infrared rays are emitted from the LCD display monitor's panel that might affect other infrared controlling equipment.
3	Picture Image (Spectrum)	When receiving still picture signals, (e.g. channel number indication or clock indication) for a while, you can see image-like when the picture varied. This is not a defect.
4	LCD Surface	The LCD panel is made from glass. Heavy shock on the front panel might damage it.
5	Transportation	When the LCD monitor is transported horizontally, the glass panel has the possibility of being broken or increasing the picture defects. At the time of transportation, horizontal style is prohibited. More-over, please treat the LCD panel with great care because of a precision apparatus. Please instruct transporters so that it should be put into the packing box at the time of shipment. (There is a possibility that breakage of the panel or defects will increase.) Rough transportation might cause damage to the panel and pixel failure.
6	Granular spots	When a screen is seen at point-blank range, a random fine grain may be visible to a dark part.
7	Black dots and Bright Points	Black dots and Bright points may appear on the LCD screen. This is a structural property of the LCD panel and is not a defect.
8	Disturbance to video apparatus	If an apparatus (VCR, etc.) antenna line is arranged near the monitor, the image may shake, or disturbance may be received.
9	Lip Sync	There is some time lag between the picture and the sound. You can see lip motion that is delayed compared to the sound.
10	Caution on prolonged storage	Storing the LCD television for a period of more than 2 to 3 months without use might cause an unstable picture when the set is turned on.
11	Operating	Operating altitude: 800 to 1,114hPa (6,194ft to -2,484ft). Operating temperature: 41°F to 95°F. Avoid operating the LCD TV below 41°F LCD response speed may slow down when operating at these temperatures. This is a normal operating characteristic of the LCD monitor.
12	Storage	Storage Altitude: 300 to 1,114hPa (31,912ft to -2,484ft). Storage temperature: 5°F to 140°F.
13	Power ON or OFF	Frequent use of the Power ON or OFF might trigger the power protection circuit. If the TV does not turn ON, please wait a little before turning ON again.

HOOKUP CABLES



Most video/audio connections between components can be made with shielded video and audio cables that have phono connectors. For best performance, video cables should use 75-Ohm coaxial shielded wire. Cables can be purchased from most stores that sell audio/video products. Below are illustrations and names of common connectors. Before purchasing any cables, be sure of the output and input connector types required by the various components and the length of each cable.

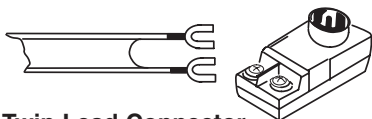

300-Ohm Twin Lead Connector

This outdoor antenna cable must be connected to an antenna adapter (300-Ohm to 75-Ohm).



Phono Connector

Used on all standard video and audio cables which connect to inputs and outputs located on the rear jack panel and front control panel.

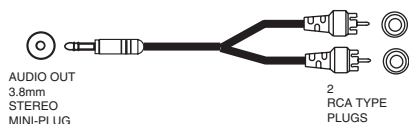

Stereo Cable (3.5 mm plug to 3.5 mm plug)

This cable is used to connect from external audio out to the audio input of the AVC Center (ex. RGB Input).

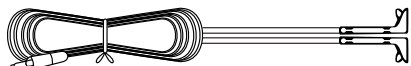

IR Mouse Cable (Provided)

Connect the IR Mouse to the IR output on your AVC center when A/V Network is used. You must place the IR mouse in front of the corresponding IR window of your cable box and VCR. This connection allows your TV to control your cable box and VCR.

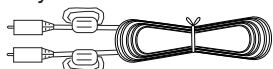

Subwoofer Cable (Provided)

This cable is used to connect an external audio component input to the subwoofer output of the Display Monitor.

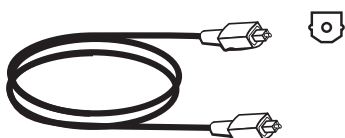

Optical Cable

This cable is used to connect to an audio amplifier with an Optical Audio In jack. Use this cable for the best sound quality.

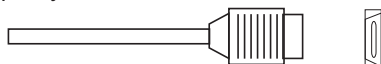

HDMI Cable

This cable is used to connect your external devices such as Set-Top-Boxes or DVD players equipped with an HDMI output connection to the TV's HDMI input.



IEEE1394 Cable

This cable is used to connect your digital television to external digital devices. This cable will carry both the video and audio information.



"F" Type 75-Ohm Coaxial Antenna Connector

For connecting RF signals (antenna or cable TV) to the antenna jack on the television.



S-Video (Super Video) Connector

This connector is used on camcorders, VCRs and laser-disc players with an S-Video feature in place of the standard video cable to produce a high quality picture.

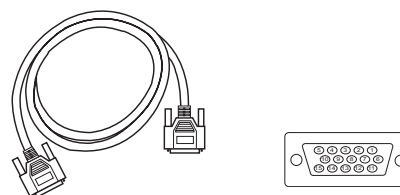

D-SUB MINI 15-Pin Cable

This cable is used to connect a computer output to the ANALOG input located on the rear panel of the AVC Center. The resolution should be set correctly to display the signal on the LCD Television.

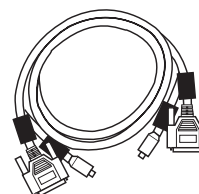

Monitor Connection Cable (Provided)

This cable is used to connect the Display Monitor to the AVC Center.

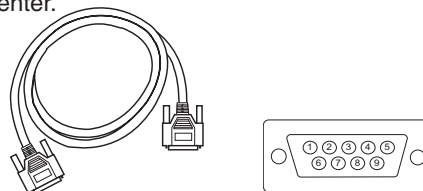

D-SUB MINI 9-Pin Cable

This cable is used to connect to the RS232C input located on the rear panel so you can control some of your TV functions from an external home control system.



USB Cable

This cable is used to connect your digital camera to the Photo Input in the front of the AVC.

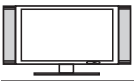

ANTENNA CONNECTIONS TO REAR PANEL JACKS

FIRST TIME USE

VHF (75-Ohm) antenna/CATV (Cable TV)

When using a 75-Ohm coaxial cable system, connect the outdoor antenna or CATV coaxial cable to the ANT A (75-Ohm) terminal. If you have a second antenna, connect the coaxial cable to the ANT B terminal.

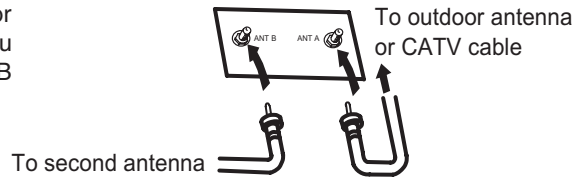

VHF (300-Ohm) antenna/UHF antenna

When using a 300-Ohm twin lead from an outdoor antenna, connect the VHF or UHF antenna leads to screws of the VHF or UHF adapter. Plug the adapter into the antenna terminal on the TV.



When both VHF and UHF antennas are connected

Attach an optional antenna cable mixer to the TV antenna terminal, and connect the cables to the antenna mixer. Consult your dealer or service store for the antenna mixer.

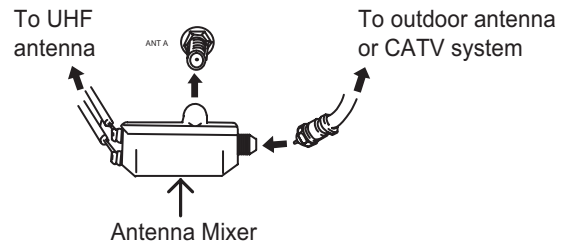

FRONT PANEL CONTROLS

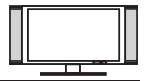

FRONT VIEW

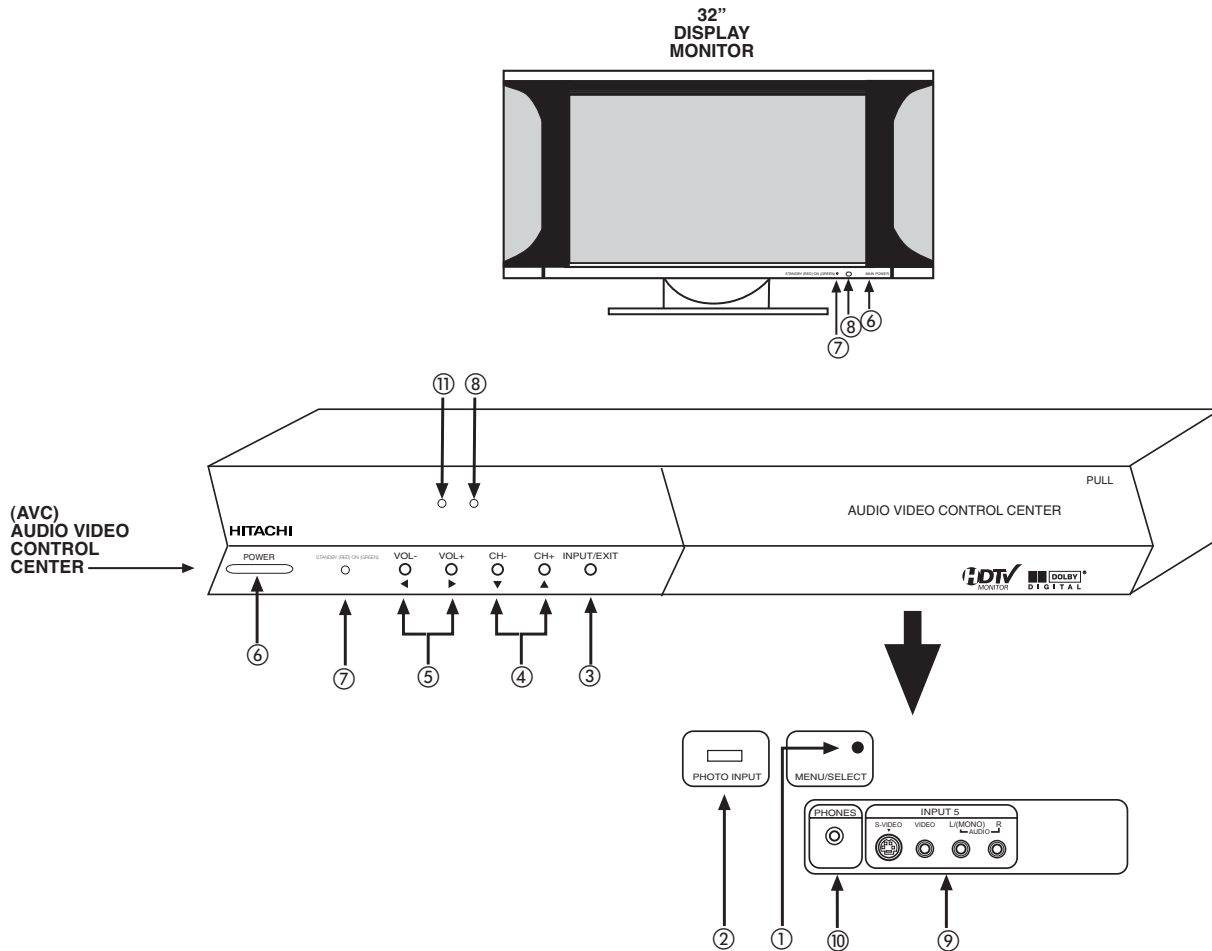

① MENU/SELECT button

This button allows you to enter the MENU, making it possible to set TV features to your preference without using the remote. This button also serves as the SELECT button when in MENU mode.

② PHOTO INPUT

Insert USB cable from your Digital Camera to view your digital still pictures (see pages 33-35).

③ INPUT/EXIT button

Press this button to select the desired input, VIDEO 1 to 5, RGB, IEEE 1394, Photo Input or Ant A/B source. Your selection is shown in the top right corner of the screen. This button also serves as the EXIT button when in MENU mode.

④ CHANNEL selector

Press these buttons until the desired channel appears in the top right corner of the TV screen. These buttons also serve as the cursor down (▼) and up (▲) buttons when in MENU mode.

⑤ VOLUME level

Press these buttons to adjust the sound level. The volume level will be displayed on the TV screen. These buttons also serve as the cursor left (◀) and right (▶) buttons when in MENU mode.



6 POWER button Display Monitor "MAIN POWER" button

This power button is for the complete system, and must be turned ON/OFF manually. It is recommended to leave the "MAIN POWER" to ON condition (lights red) for stand-by mode.



or

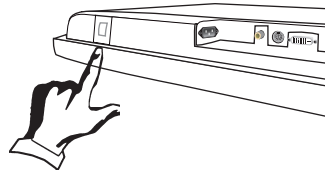

32"

AVC POWER button

The AVC power can be turned ON/OFF manually or by remote control. Turning on the AVC Power will only turn on the AVC box if the "MAIN POWER" of the display monitor is off.

7 POWER light indicator

To turn the monitor ON, press the main power switch located on the lower right side of the monitor. A red stand-by indicator lamp located on the lower right corner of the front bezel will illuminate. The LCD TV is now ready for remote on/off operation.

Indicating Lamp	Power Status	Operating
Off	Off	When the main power switch is set OFF.
Lights Red	Off (Stand-by)	When the main power switch on the display monitor is ON, and the AVC Center is OFF.
Lights Green	On	Display monitor MAIN POWER is ON and AVC Center power is ON.
Lights Orange	Off (Power Saving)	Display monitor MAIN POWER is ON and AVC Center power is ON, with no signal input except antenna (no sync. signal).

8 REMOTE CONTROL sensor

Point your remote at this area when selecting channels, adjusting volume, etc.

9 FRONT INPUT JACKS (for VIDEO: 5)

Use these audio/video jacks for a quick hook-up from a camcorder or VCR to instantly view your favorite show or new recording. Press the INPUTS button then use the CURSOR PAD and the SELECT button on the remote control to select INPUT 5. VIDEO: 5 appears in the top right corner of the TV screen. If you have mono sound, insert the audio cable into the left audio jack.

10 PHONES JACK

Use this jack for your head-phones. The TV's internal speakers can also be heard. Turn off the internal speakers (see page 57) if you wish to listen to the head-phones only.

11 LEARNING AV NET Sensor

Point your equipment's remote control at this area while using the AV NET Learning Wizard.

- NOTES:**
- Your HITACHI LCD TV will appear to be turned OFF (lights orange) if there is no video input when VIDEO: 1, 2, 3, 4, 5, or RGB is selected. Check the Power Light to make sure the Display Monitor is turned off or in Stand-by mode (lights red) when not in use.
 - Remote Control can not turn ON/OFF the "MAIN POWER" of the display monitor.

REAR PANEL JACKS



Audio Video Control Center (AVC)

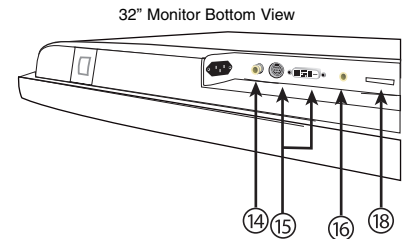
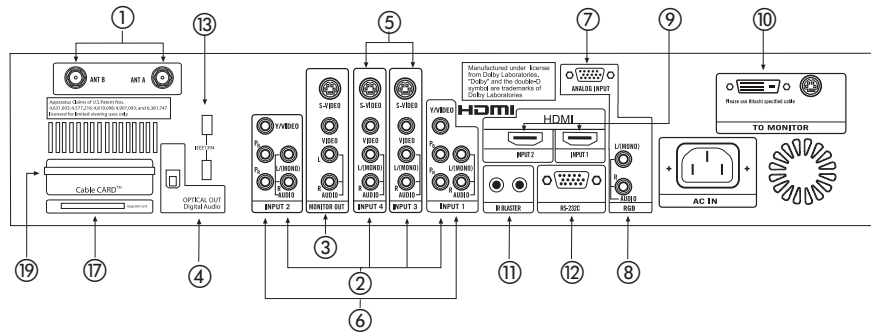

FIRST TIME USE

① Antenna Input

The remote control allows you to switch between two separate 75-Ohm RF antenna inputs, ANT A and ANT B. ANT A input can be displayed as a main picture or sub-picture. ANT B can only be displayed as a main picture (ANT B cannot be displayed as a sub-picture).

② Audio/Video Inputs 1, 2, 3 and 4

By using the INPUTS button, the CURSOR PAD, and the SELECT button of the remote control, you can select each video source. Use the audio and video inputs to connect external devices, such as VCRs, camcorders, laserdisc players, DVD players etc. (if you have mono sound, insert the audio cable into the left audio jack).

③ MONITOR OUT

These jacks provide fixed audio and video signals (ANT A/B, INPUT 1~5) which are used for recording. Use the S-VIDEO Output for high quality video output. Component signal to Input 1 and 2, RGB and HDMI inputs will not have monitor output.

④ Optical Out (Digital Audio)

This jack provides Digital Audio Output for your audio device that is Dolby® Digital and PCM compatible, such as an audio amplifier.

⑤ S-VIDEO Inputs 3 and 4

Inputs 3 and 4 provide S-VIDEO (Super Video) jacks for connecting equipment with S-VIDEO output capability.

NOTES:

1. You may use VIDEO or S-VIDEO inputs to connect to INPUT 3 and 4, but only one of these inputs may be used at a time.
2. S-VIDEO output may be used for recording, only when the input is of S-VIDEO type.

⑥ Component: Y-P_BP_R Inputs

Inputs 1 and 2 provide Y-P_BP_R jacks for connecting equipment with this capability, such as a DVD player or Set Top Box. You may use composite video signal for INPUTS 1 and 2.

NOTES:

1. DO NOT connect composite VIDEO and S-VIDEO to Input 3, 4 or 5 at the same time. S-Video has a higher priority over video input.
2. Your component outputs may be labeled Y, B-Y, and R-Y. In this case, connect the components B-Y output to the AVC Box's P_B input and the components R-Y output to the AVC Box's P_R input.
3. Your component outputs may be labeled Y-C_BC_R. In this case, connect the component C_B output to the AVC Box's P_B input and the component C_R output to the AVC Box's P_R input.
4. It may be necessary to adjust TINT to obtain optimum picture quality when using the Y-P_BP_R inputs (See page 54).
5. To ensure no copyright infringement, the MONITOR OUT output will be abnormal, when using the Y-P_BP_R jacks, RGB and HDMI inputs.



7 RGB - Analog Input

Use this 15-pin D-Sub input for your external devices with RGB output (see page 25).

8 RGB - Audio Input

Connect audio for RGB input (if you have mono sound, insert the audio cable into the left audio jack).

9 HDMI - Digital Input (INPUT 1 and INPUT 2)

About HDMI

HDMI is the next-generation all digital interface for consumer electronics. HDMI enables the secure distribution of uncompressed high-definition video and multi-channel audio in a single cable. Because digital television (DTV) signals remain in digital format, HDMI assures that pristine high-definition images retain the highest video quality from the source all the way to your television screen.

Use the HDMI input for your external devices such as Set-Top-Boxes or DVD players equipped with an HDMI output connection.



HDMI, the HDMI logo and High-Definition Multimedia Interface are trademarks or registered trademarks of HDMI Licensing LLC.

- NOTES:**
1. The HDMI input is not intended for use with personal computers.
 2. Only DTV formats such as 1080i, 720p, 480i and 480p are available for HDMI input.

10 To Monitor

Connect the Monitor Connection Cable to the AVC center's "TO MONITOR" connector, and to the display monitor's "FROM AVC" connector.

11 IR Blaster

This jack provides IR output to your external components (VCR, Cable box, DVD player, etc.). With this connection, your external components can automatically be controlled by the A/V network feature. This connection will allow you to control the external components with your LCD Television's remote control in TV mode.

12 RS232C Input

For use with third party home Audio/Video control systems which are commercially available. Please see your dealer regarding these "non Hitachi" home control systems (see page 76 to activate this input).

13 IEEE1394

These jacks provide a digital interface for your external digital devices, such as a Digital VCR (D-VHS or Set-Top-Box) by means of a single cable (see page 20). When using IEEE1394 connections, you enable video and audio digital data exchange between a compatible device. This connection also enables you to control basic equipment functions (such as VCR play, rewind, fast forward, stop, etc.) from your TV On-Screen Display.

14 Subwoofer Out

Connect this SUB WOOFER OUT output to the external audio component input using the sub woofer cable provided.

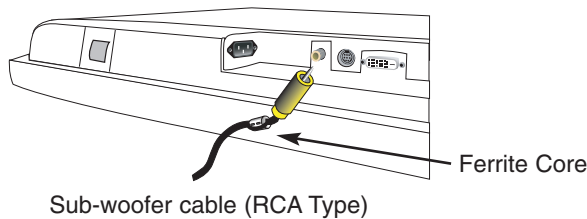

15 To AVC

Connect the Monitor Connection cable from the AVC center's "TO MONITOR" to these connectors ("FROM AVC").

16 SUB-POWER button

This power is for serviceman usage.

17 Upgrade Card

This card slot is for future software upgrades. Hitachi will notify you if a software upgrade is required for your TV. In order to receive written notification, please complete and return your warranty card.

18 To Power Swivel Connector

Connects to the Power Swivel Table Top Stand.

REAR PANEL JACKS

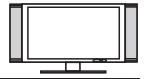

19 CableCARD Slot

This slot is for the CableCARD that will be provided by your local cable operator to gain access to chosen cable channels. The CableCARD will allow you to tune digital and high definition cable channels. Please call your local cable operator if this service is available before requesting a CableCARD (also known as Point of Deployment (POD) module).

Connect a coaxial cable to ANT A terminal of the Rear Panel Jacks.
 Insert the CableCARD into the slot (Top of card should be facing up as shown).

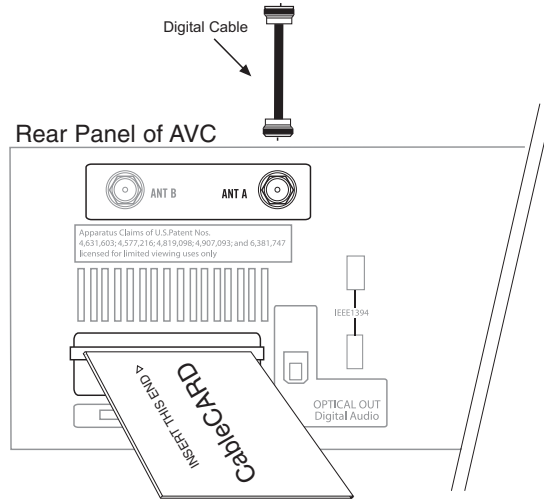

If the CableCARD is properly installed or not installed, the TV will display the following respective screens.

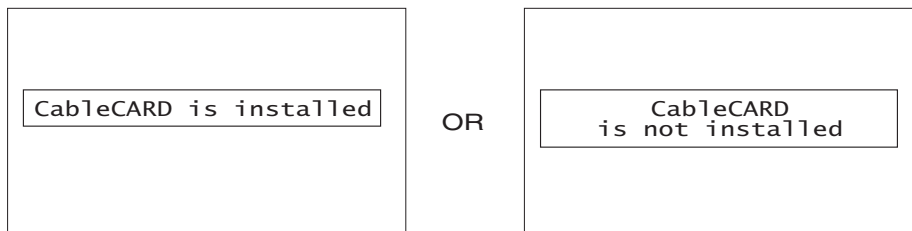

After the CableCARD is installed, wait until the second screen below appears. The third screen below will appear if a channel is not authorized for viewing. Press the EXIT button to exit the second screen.



Please take note of all information on the screen (you will provide this information to your cable operator). Call your cable operator and give them the information from the card to start your cable service.

- NOTES:**
1. A digital cable subscription is required.
 2. Antenna B will not be available when CableCARD is inserted.
 3. Do not insert a PCMCIA card into the CableCARD slot.
 4. Please see pages 63-64 and 76 for additional CableCARD information.

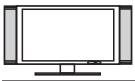

CONNECTING LCD DISPLAY MONITOR TO AVC BOX

FIRST TIME USE

1. From the owner's accessory you will find the Monitor Connector cable.
2. Firmly, and securely insert the Monitor Connection Cable to the rear panel of the AVC box "TO MONITOR" connectors.
3. Insert the other ends of the Monitor Connection Cable to the display monitor rear panel "FROM AVC" connectors.

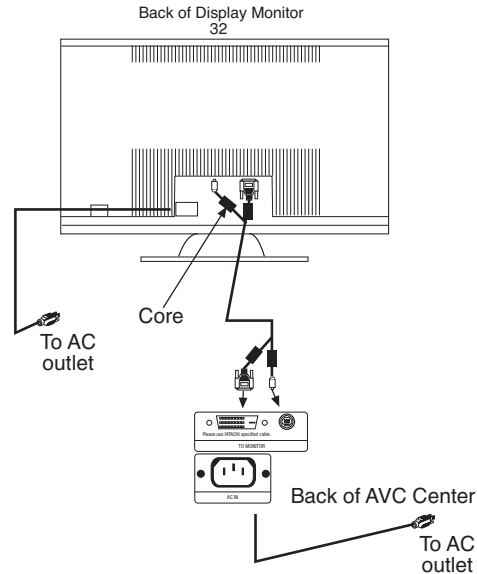

NOTE: The Display Monitor and the AVC Center have their own AC Power. Both AC cords must be completely plugged in to the AVC Center and the display monitor, then plug them in to the AC outlets.

CONNECTING EXTERNAL VIDEO SOURCES

The front panel jacks are provided as a convenience to allow you to easily connect a camcorder or VCR as shown in the following examples:

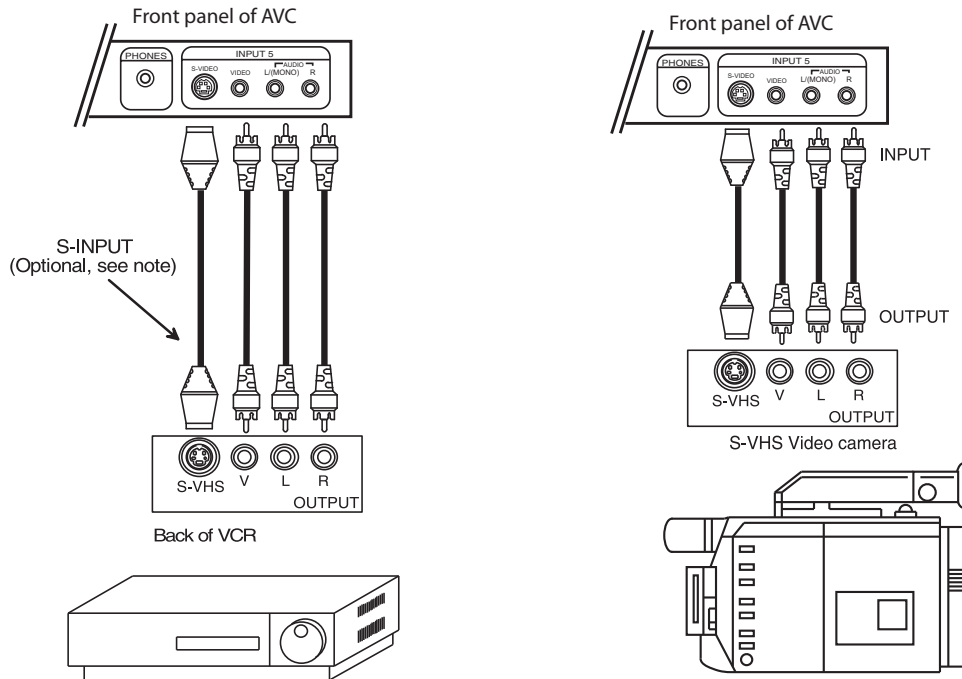

- NOTES:**
1. Completely insert connection cord plugs when connecting to front panel jacks. If you do not, the played back picture may be abnormal.
 2. If you have a S-VHS VCR, use the S-INPUT cable in place of the standard video cable.
 3. If you have a mono VCR, insert the audio cable into the left audio jack of your AVC box.
 4. S-VIDEO input takes priority over VIDEO input.
 5. If you have a VHS or 8mm camcorder, use the S-VIDEO cable in place of the VIDEO cable.

CONNECTING EXTERNAL VIDEO SOURCES



The exact arrangement you use to connect the VCR, camcorder, laserdisc player, DVD player, or HDTV Set Top Box to your LCD TV is dependent on the model and features of each component. Check the owner's manual of each component for the location of video and audio inputs and outputs.

The following connection diagrams are offered as suggestions. However, you may need to modify them to accommodate your particular assortment of components and features. For best performance, video and audio cables should be made from coaxial shielded wire.

Before Operating External Video Source

Connect an external source to one of the INPUT terminals, then press the INPUTS button to show the INPUTS menu. Use the CURSOR PAD to select the Antenna or Input of your choice. Then press the SELECT button to confirm your choice (see page 33).

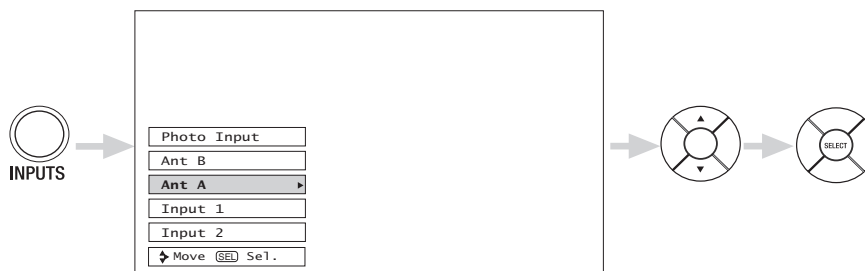

CONNECTING A MONAURAL AUDIO SOURCE TO INPUT1-INPUT5

1. Connect the cable from the VIDEO OUT of the VCR or the laserdisc player to the INPUT (VIDEO) jack, as shown on the AVC Center below.
2. Connect the cable from the AUDIO OUT of the VCR or the laserdisc player to the INPUT (MONO)/L(AUDIO) jack.
3. Press the INPUTS button, then select INPUT 3 from the INPUTS menu to view the program from the VCR or the laserdisc player. The VIDEO label disappears automatically after approximately four seconds.
4. Select Ant A or B from the INPUTS menu to return to the previous channel.

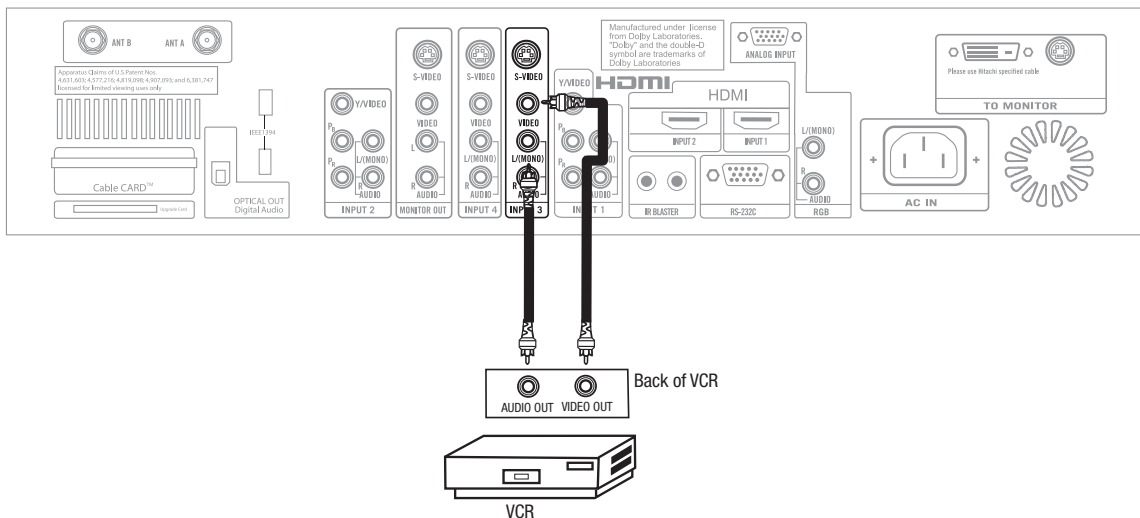

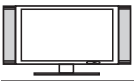

CONNECTING EXTERNAL VIDEO SOURCES

FIRST TIME USE

CONNECTING A STEREO VCR OR STEREO LASERDISC PLAYER

1. Connect the cable from the VIDEO OUT of the VCR or the laserdisc player to the INPUT (VIDEO) jack, as shown on the AVC Center below.
2. Connect the cable from the AUDIO OUT R of the VCR or the laserdisc player to the INPUT (AUDIO/R) jack.
3. Connect the cable from the AUDIO OUT L of the VCR or the laserdisc player to the INPUT (AUDIO/L) jack.
4. Press the INPUTS button, then select INPUT 3 from the INPUTS menu to view the program from the VCR or laserdisc player. The VIDEO label disappears automatically after approximately four seconds.
5. Select ANT A or B from the INPUTS menu to return to the previous channel.

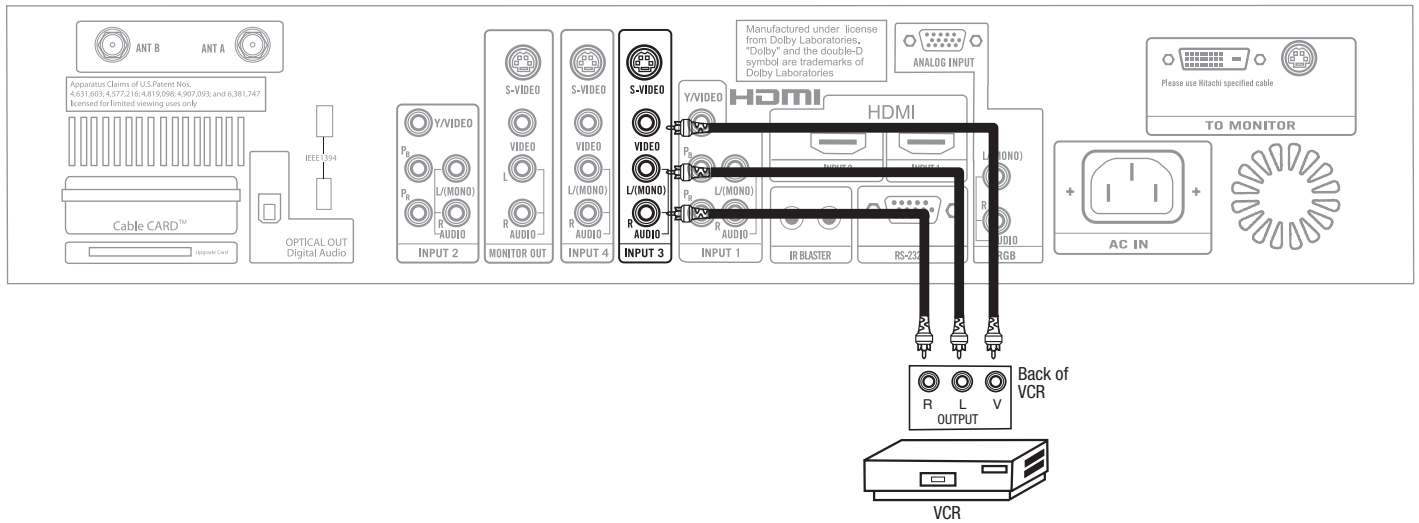

- NOTES:**
1. Completely insert the connection cord plugs when connecting to rear panel jacks. The picture and sound that is played back will be abnormal if the connection is loose.
 2. A single VCR can be used for VCR #1 and VCR #2, but note that a VCR cannot record its own video or line output (INPUT: 4 in example on page 25). Refer to your VCR operating guide for more information on line input-output connections.

CONNECTING EXTERNAL VIDEO SOURCES



CONNECTING S-VIDEO VCR OR LASERDISC PLAYER

1. Connect the cable from the S-VIDEO OUT of the S-VHS VCR or the laserdisc player to the INPUT (S-VIDEO) jack, as shown on the AVC Center below.
2. Connect the cable from the AUDIO OUT R of the VCR or the laserdisc player to the INPUT (AUDIO/R) jack.
3. Connect the cable from the AUDIO OUT L of the VCR or the laserdisc player to the INPUT (AUDIO/L) jack.
4. Press the INPUTS button, then select INPUT 4 from the INPUTS menu to view the program from the VCR or laserdisc player. The VIDEO label disappears automatically after approximately four seconds.
5. Select ANT A or B from the INPUTS menu to return to the previous channel.

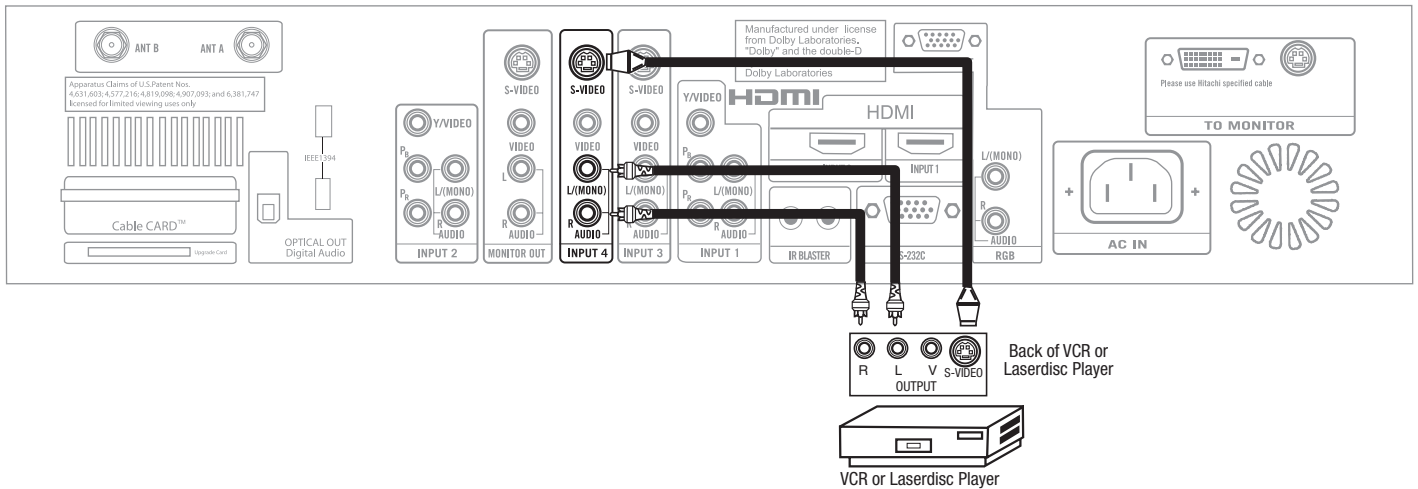

- NOTES:**
1. Completely insert the connection cord plugs when connecting to rear panel jacks. The picture and sound that is played back will be abnormal if the connection is loose.
 2. A single VCR can be used for VCR #1 and VCR #2, but note that a VCR cannot record its own video or line output (INPUT: 4 in example on page 25). Refer to your VCR operating guide for more information on line input-output connections.



CONNECTING EXTERNAL VIDEO SOURCES

FIRST TIME USE

CONNECTING A COMPONENT SOURCE WITH HDMI or DVI CAPABILITY TO INPUT 1 or INPUT 2

1. Connect the HDMI or DVI to HDMI connection cable from the output of the HDTV set top box or DVD player to the HDMI input as shown on the AVC Center below.
2. With DVI output, connect the cable from the AUDIO OUT R of the HDTV set top box or DVD player to the INPUT (AUDIO/R) jack.
3. With DVI output, connect the cable from the AUDIO OUT L of the HDTV set top box or DVD player to the INPUT (AUDIO/L) jack.
4. Press the INPUTS button, then select INPUTS 1 or 2 to view the program from the HDTV set top box or DVD player. The VIDEO OSD label disappears automatically after approximately four seconds.
5. Select ANT A or B from the INPUTS menu to return to the previous channel.

HDMI input

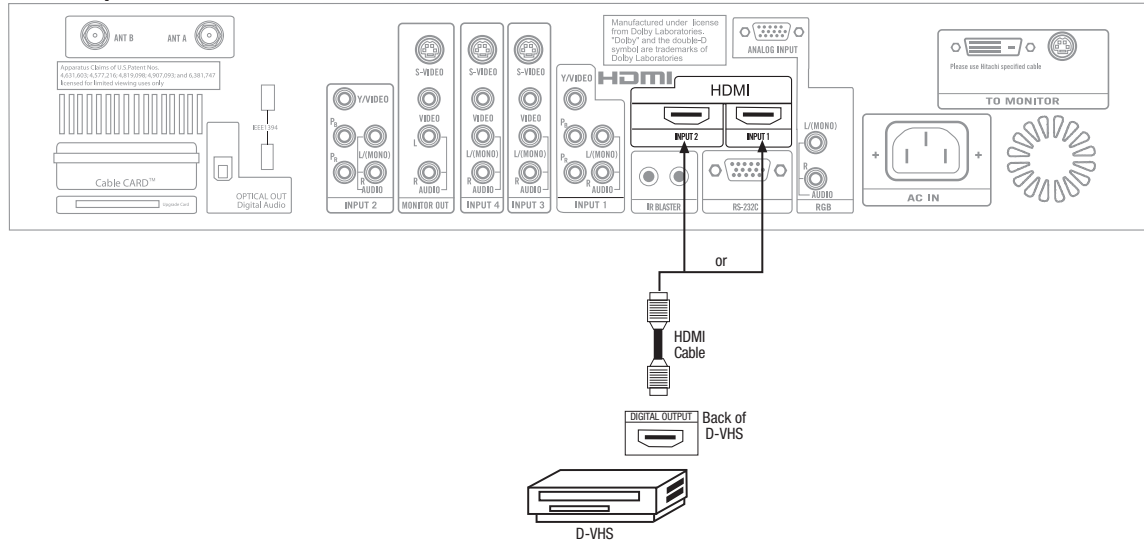

DVI to HDMI Input

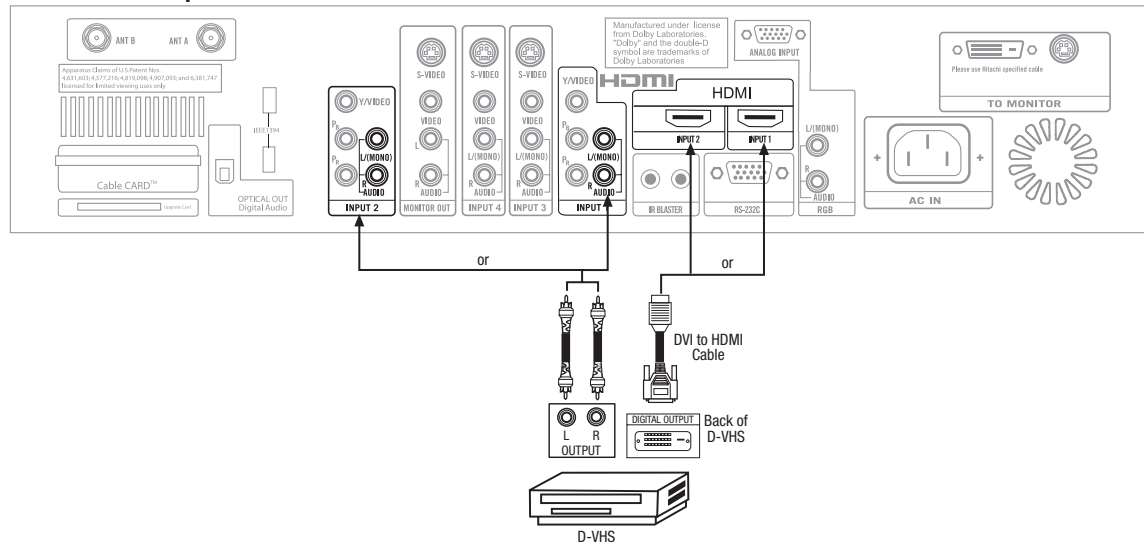

- NOTES:**
1. Completely insert the connection cord plugs when connecting to rear panel jacks. The picture and sound that is played back will be abnormal if the connection is loose.
 2. The HDMI input on INPUT 1 or 2 contains the copy protection system called High-bandwidth Digital Content Protection (HDCP). HDCP is a cryptographic system that encrypts video signals when using HDMI connections to prevent illegal copying of video contents.
 3. HDMI is not a "NETWORK" technology. It establishes a one-way point-to-point connection for delivery of uncompressed video to a display.
 4. The connected digital output device controls the HDMI interface so proper set-up of device user settings determines final video appearance.

CONNECTING EXTERNAL VIDEO SOURCES

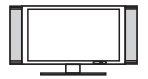

CONNECTING A STEREO LASERDISC/DVD PLAYER OR HDTV SET TOP BOX TO INPUT 1 OR 2 COMPONENT: Y-P_BP_R.

1. Connect the cable from the Y OUT of the Laserdisc/DVD player or HDTV set top box to the INPUT (Y) jack, as shown on the AVC Center below.
2. Connect the cable from the C_B/P_B OUT or B-Y OUT of the Laserdisc/DVD player or HDTV set top box to the INPUT (P_B) jack.
3. Connect the cable from the C_R/P_R OUT or R-Y OUT of the Laserdisc/DVD player or HDTV set top box to the INPUT (P_R) jack.
4. Connect the cable from the AUDIO OUT R of the Laserdisc/DVD player or HDTV set top box to the INPUT (AUDIO/R) jack.
5. Connect the cable from the AUDIO OUT L of the Laserdisc/DVD player or HDTV set top box to the INPUT (AUDIO/L) jack.
6. Press the INPUTS button, then select INPUT 1 or 2 from the INPUTS menu to view the program from the Laserdisc/DVD player or HDTV set top box. The VIDEO label disappears automatically after approximately four seconds.
7. Select ANT A or B to return to the previous channel.

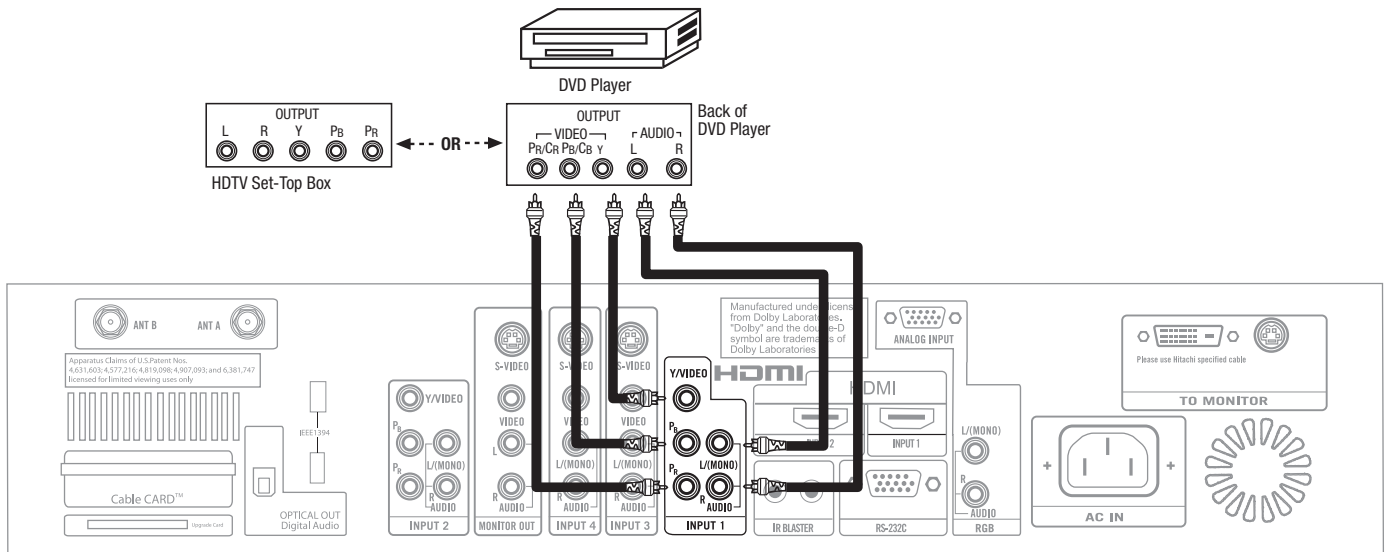

- NOTE:**
1. Completely insert the connection cord plugs when connecting to rear panel jacks. The picture and sound that is played back will be abnormal if the connection is loose.
 2. See page 26 for tips on REAR PANEL CONNECTIONS.



CONNECTING EXTERNAL VIDEO SOURCES

FIRST TIME USE

CONNECTING A COMPONENT SOURCE WITH DIGITAL INTERFACE CAPABILITY TO IEEE1394 TERMINALS

1. Connect the IEEE1394 cable from the output of the component with IEEE1394 capability, such as a Set-Top-Box or Digital VCR, to the IEEE1394 input terminals shown on the AVC Center below. IEEE 1394 allows the LCD television and the external device to communicate with one another. When using IEEE1394 connections, you enable video and audio digital data exchange between a compatible device. This connection also enables you to control basic equipment functions (such as VCR play, rewind, fast forward, stop, etc.) from your TV On-Screen Display.
2. Press the INPUTS button on the Remote Control.
3. Select the IEEE1394 option (see page 36).

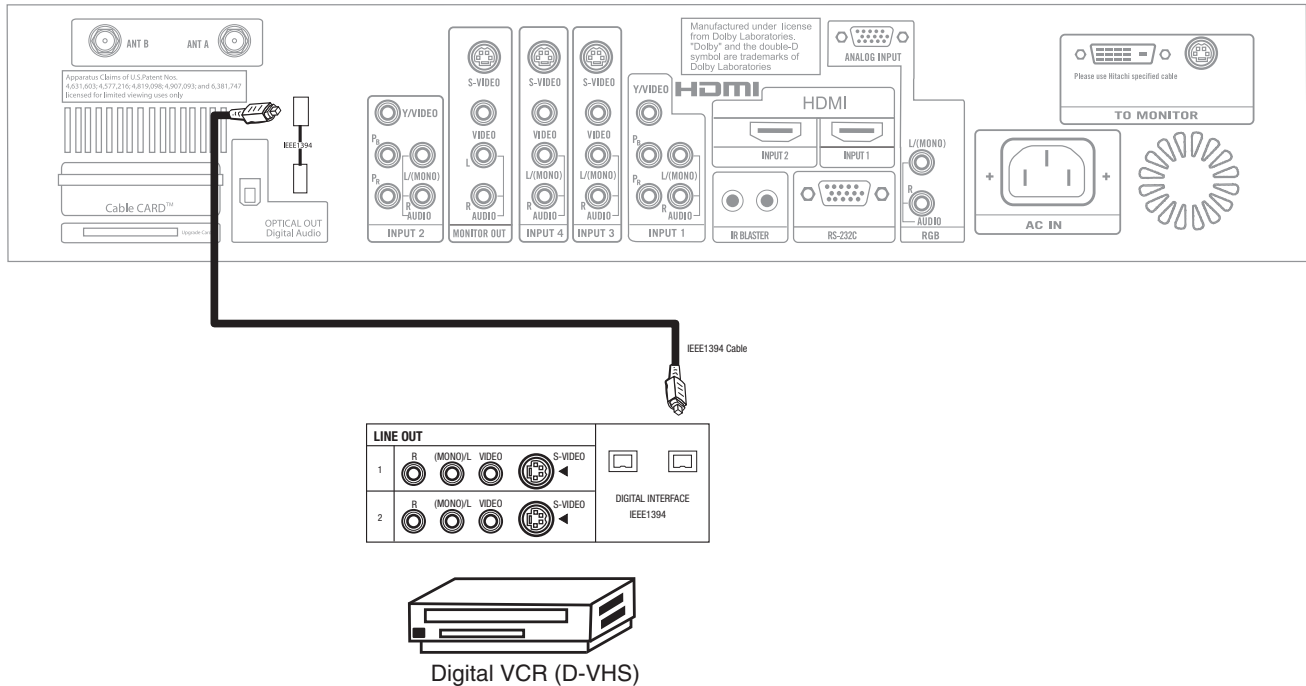

- NOTES:**
1. This LCD TV's IEEE1394 connection is not compatible with a DV camcorder (Digital Video camcorder) and a PC.
 2. With IEEE1394 connection, video and audio will be received by the TV. It will enable you to control the D-VHS from the TV IEEE1394 menu (see page 36).
 3. The IEEE1394 interface contains the copy protection standard called 5C or Digital Transmission Content Protection (DTCP).
 4. See page 26 for tips on Rear Panel Connections.

CONNECTING EXTERNAL AUDIO/VIDEO DEVICES

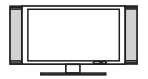

CONNECTING EXTERNAL AUDIO AMPLIFIER

To monitor the audio level of the LCD TV to an external audio amplifier, connect the system as shown below. The "OPTICAL OUT" from the AVC center is a fixed output. The Volume of the amplifier is controlled by the amplifier, not by the LCD Television. The OPTICAL OUT terminal outputs all audio sources with Optical IN capability.

FIRST TIME USE

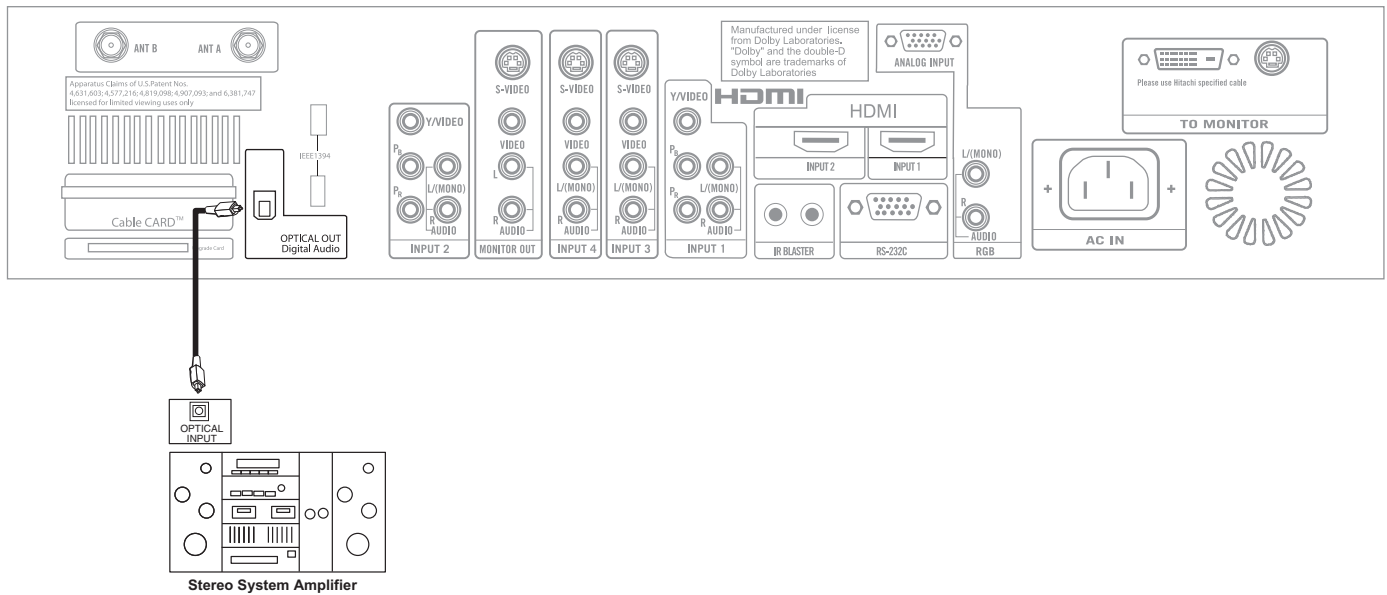

The MONITOR OUT terminal outputs video and audio of ANT A/B and INPUTS 1, 2, 3, 4 and 5. It does not output component video, HDMI or RGB.

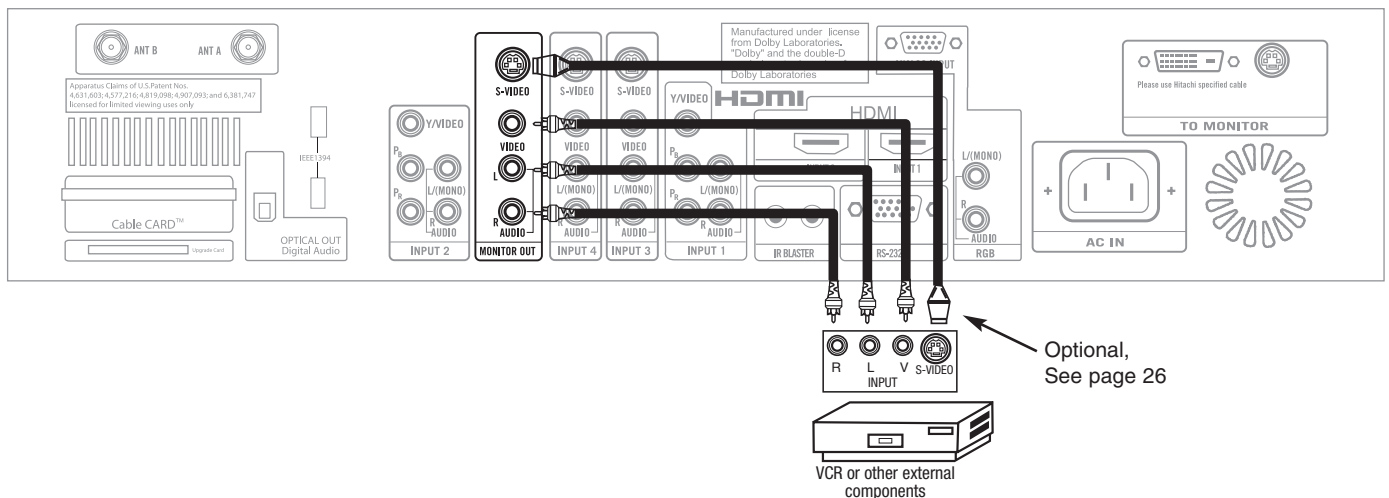



CONNECTING AV NETWORK

FIRST TIME USE

Your Hitachi LCD Television is equipped with an AV Network feature. This feature helps to control your external Audio/Video equipment (VCR, Set Top Box, DVD, etc.). Once this is setup, it allows your IR Mouse connector to control your equipment using your Hitachi LCD TV Remote Control. You can use your Hitachi remote control to control the Audio/Video equipment command without the equipment's remote control.

The LCD Television AVC Center has 2 IR BLASTER jacks. Each IR Mouse cable can connect up to 2 external Audio/Video components. Therefore, you can connect the LCD Television with up to four components. Please see the following example of an AV Network setup between your Hitachi LCD Television and external Audio/Video equipment (VCR and DVD Player).

CONNECTING EXTERNAL AUDIO/VIDEO COMPONENTS TO IR BLASTER FOR AV NETWORK

1. Connect your external Audio/Video components to the AVC Center shown on pages 15~21.
2. Connect the IR Mouse cable to the IR BLASTER output of the AVC Center.
3. Place the IR mouse in front of the infrared sensor of the external components you wish to control.

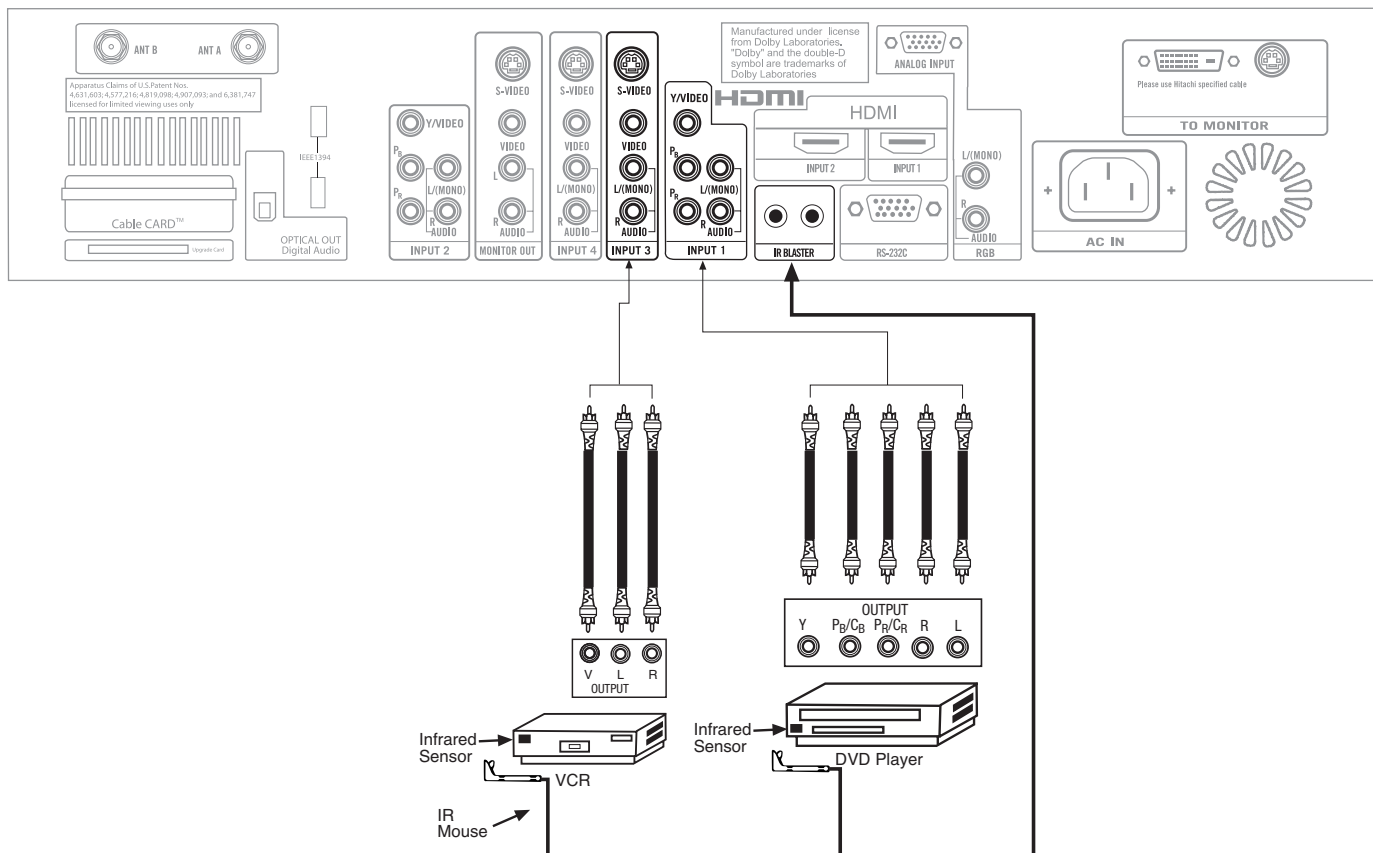

4. Press the AV NET button on the remote control. Use CURSOR PAD ▲ or ▼ to select and highlight the Device Setup

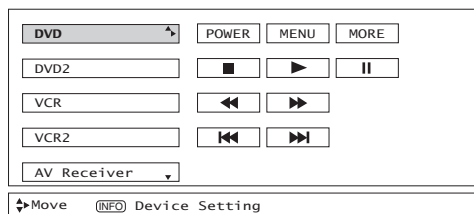

NOTES:

1. The AVC Center has two IR BLASTER outputs which can control up to a total of four external components.
2. The IR Mouse must be placed in front of the external components infrared sensor for the AV Network to work.
3. The correct codes must be entered for each of the Audio/Video components for the AV Network to function properly.
4. Audio/Video component codes for AV network are on page 24.

AV NETWORK SETUP WIZARD

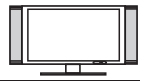

5. Follow the steps below to setup your AV network (See page 24 for AV Network Codes).

SETUP PROCEDURE (DVD setup example below).

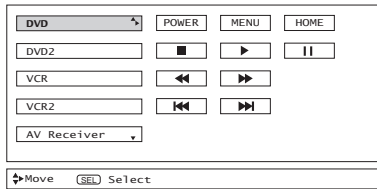

1. Press the A/V Net button on the remote control.

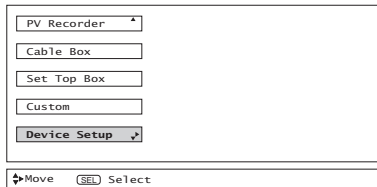

1. Use CURSOR PAD ▲, ▼ to select Device Setup.
2. Press the SELECT button on the remote control.

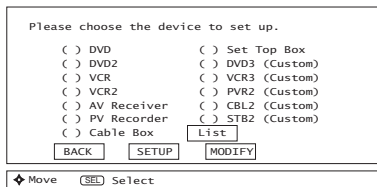

1. Use the CURSOR PAD ▲, ▼ to choose DVD and press the SELECT button on the remote control.
2. Cursor down to SETUP and press the SELECT button on the remote control. LIST: Select to view the list of devices that are setup.

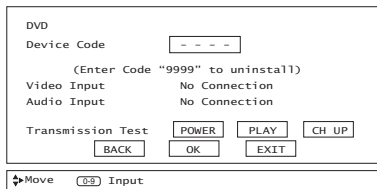

1. Using the remote, enter the four digit Device Code for your equipment, found on page 24.
2. Using the CURSOR PAD, set the Video and Audio Inputs to the INPUT to which your device is connected.
3. Perform a Transmission Test by selecting Power, Play, or CH UP softkeys. If the device responds, then it is properly set up. Select OK. (If the Transmission Test failed, try another code.)

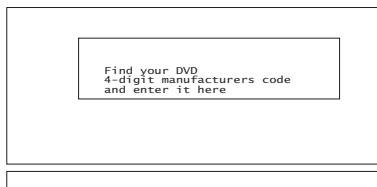

1. If "OK" was selected, and the 4 digit code was invalid, the screen on the left appears, then goes back to the device entry screen.

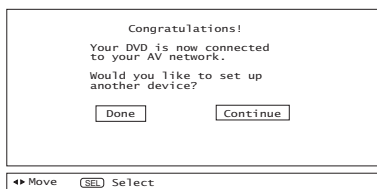

1. Select CONTINUE to setup another device.
2. Select DONE to finish and the following screen appears.

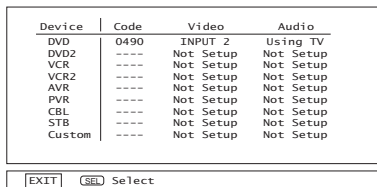

1. Select EXIT to quit.

6. See Remote Control AV NET button usage on pages 31 and 32.



AUDIO/VIDEO CODES FOR AV NETWORK (not for remote control)

FIRST TIME USE

VCR BRAND	CODE
Admiral	0048, 0209
Adventura	0000
Aiko	0278
Aiwa	0000, 0037
Akai	0041
America Action	0278
American High	0035
Asha	0240
Audiovox	0037, 0278
Beaurnark	0240
Bell & Howell	0104
Broksonic	0121, 0184, 0002, 0209, 0479, 1479, 0278
CCE	0072, 0278
Calix	0037
Canon	0035
Carver	0081
Cineral	0278
Citizen	0278, 0037, 1278
Colt	0072
Craig	0037, 0072, 0047, 0240
Curtis Mathes	0035, 0041, 0060, 0162, 0760, 1035
Cybernex	0240
Daewoo	0278, 1278, 0045
Denon	0042
Dynatech	0000
Electrohome	0037
Electrohome	0037
Emerex	0032
Emerson	0184, 0002, 0209, 0121, 0000, 0037, 0043
Fisher	0104, 0047
Fuji	0033, 0035
Funai	0000
GE	0035, 0060, 0240, 0760, 0807, 1035, 1060
Garrard	0000
Go Video	0432
GoldStar	0037, 0038, 1237
Gradiente	0000
Hi-Q	0047
Harley Davidson	0000
Harman/Kardon	0038, 0081
Harwood	0072
Hitachi	0000, 0041, 0042
Hughes Network Systems	0042
JVC	0067, 0041
Jensen	0041
KEC	0037, 0278
KLH	0072
Kenwood	0041, 0067, 0038
Kodak	0035, 0037
LXI	0037
Lloyd's	0000
Logik	0072
MEI	0035
MGA	0043, 0240
MGN Technology	0240
MTC	0000, 0240
Magnasonic	1278
Magnavox	0035, 0081, 0563, 0000, 0039, 0149, 1781
Magnin	0240
Marantz	0081, 0035
Marta	0037
Matsushita	0035, 0162, 0454
Memorex	0047, 0037, 0104, 0209, 0454, 0048, 0039, 0240, 0000, 0479, 1037, 1162, 1237, 1262
Minolta	0042
Mitsubishi	0043, 0067
Motorola	0035, 0048
Multitech	0000, 0072
NEC	0038, 0041, 0067, 0104
Nikko	0037
Noblex	0240
Olympus	0035
Optimus	1062, 0162, 0037, 0048, 0104, 0432, 0454, 1048, 1162, 1262
Orion	0184, 0209, 0002, 0479, 1479
Panasonic	1062, 0035, 0225, 0454, 0616, 1035, 1162, 1262
Penney	0035, 0037, 0240, 0042, 0038, 1035, 1237
Pentax	0042
Philco	0035, 0209, 0479
Philips	0081, 0035, 0618, 1081, 1181
Pilot	0037
Pioneer	0067
Polk Audio	0081
Proffron	0240
Proscan	0060, 0760, 1060
Protec	0072
Pulsar	0039
Quasar	0035, 0162, 0454, 1035, 1162
RCA	0060, 0240, 0042, 0149, 0760, 1035, 1060
Radio Shack	0000, 1037
Radix	0037
Randex	0037
Realistic	0035, 0037, 0048, 0047, 0000, 0104
ReplayTV	0614, 0616
Runco	0039
STS	0042
Samsung	0045, 0240
Sanky	0039, 0048
Sansui	0000, 0067, 0209, 0041, 0479, 1479
Sanyo	0047, 0240, 0104
Scott	0184, 0045, 0121, 0043
Sears	0035, 0037, 0047, 0000, 0042, 0104, 1237
Semp	0045
Sharp	0048, 0848
Shintom	0072

Shogun	0240
Singer	0072
Sonic Blue	0614, 0616
Sony	0035, 0032, 0000, 0033, 0636, 1032, 1232
Sylvania	0035, 0081, 0000, 0043, 1781
Symphonic	0000
TMK	0240
Tatung	0041
Teac	0000, 0041
Technics	0035, 0162
Teknika	0000, 0035, 0037
Thomas	0000
Tivo	0618, 0636
Toshiba	0045, 0043
Totevision	0037, 0240
Unitech	0240
Vector	0045
Vector Research	0038
Video Concepts	0045
Videomagic	0037
Videosonic	0240
Wards	0060, 0035, 0048, 0047, 0081, 0240, 0000, 0042, 0072, 0149, 0760
White Westinghouse	0072, 1278, 0209
XR-1000	0072, 0000, 0035
Yamaha	0038
Zenith	0039, 0000, 0209, 0033, 0479, 1479, 0033, 0209, 0479

DVD BRAND	CODE
Aiwa	0641
Apex	0672, 0717, 0755, 0794, 0795, 0796, 0797, 0830
Audiologic	0736
B & K	0655, 0662
Blue Parade	0571
Broksonic	0695
DVD2000	0521
Daewoo	0784
Denon	0490, 0634
Emerson	0591
Enterprise	0591
Fisher	0670
GE	0522, 0717, 0815
GPX	0769
Go Video	0715
Gradiente	0651
Greenhill	0717
Harman/Kardon	0582, 0702
Hitachi	0490, 0573, 0664
Hitek	0672
JBL	0702
JVC	0623, 0558, 0867
KLH	0717
Kenwood	0490, 0534, 0682
Konka	0711, 0719, 0721
Koss	0651
Lasonic	0798
Magnavox	0503, 0675
Malata	0782
Marantz	0539
Microsoft	0522
Mintek	0717
Mitsubishi	0521
Nesa	0717
Onkyo	0627, 0503
Ortron	0651
Panasonic	0490, 1362, 0632
Philips	0503, 0539, 0646, 0854
Pioneer	0525, 0571, 0632
Polk Audio	0539
Princeton	0674
Proscan	0522
RCA	0522, 0571, 1022, 0717
Rowa	0823
Sampo	0698
Samsung	0573, 0820
Sansui	0695
Sanyo	0670
Sharp	0630
Sherwood	0633
Sony	0533
Sylvania	0675
Technics	0490
Techwood	0692
Theta Digital	0571
Toshiba	0503, 0695
Urban Concepts	0503
Yamaha	0490, 0545, 0539
Zenith	0591, 0503

CABLE BRAND	CODE
ABC	0003, 0008, 0014, 0017
Americast	0899
Bell & Howel	0014
Bell South	0899
Director	0476
General Instrument	0003, 0476, 0276, 0810
GoldStar	0144
Hamlin	0009, 0273
Jerrold	0476, 0003, 0276, 0012, 0014, 0810
Memorex	0000
Motorola	0476, 1106, 0276, 0810
Pace	0237
Panasonic	0107, 0000
Philips	0305, 0317
Pioneer	0144, 0533, 0877, 1877
Pulsar	0000
Quasar	0000
Regal	0273, 0279
Runco	0000
Samsung	0144
Scientific Atlanta	0877, 0008, 0017, 0477, 1877

Sony	1006
Starcom	0003
Supercable	0276
Tocom	0012
Torx	0003
Toshiba	0000
Zenith	0000, 0525, 0899
SATELLITE BRAND (Set-Top-Box)	CODE
AlphaStar	0772
Chapparral	0216
Crossdigital	1109
DishPro	1005, 0775
Echostar	1005, 0775
Expressvu	0775
GE	0566
GOI	0775
General Instrument	0869
HTS	0775
Hitachi	0819
Hughes Network Systems	1142, 0749, 1749
JVC	0775
Magnavox	0724, 0722
Memorex	0724
Mitsubishi	0749
Motorola	0869
Next Level	0869
Panasonic	0247, 0701
Paysat	0724
Philips	1142, 0749, 0724, 1076, 0722, 1749
Proscan	0392
RCA	0392, 0566, 0855, 0143
Radioshack	0869
SKY	0856
Samsung	1109
Sony	0639
Star Choice	0869
Toshiba	0749, 0790, 1749
Uniden	0724, 0722
Zenith	0856, 1856

AMPLIFIER BRAND	CODE
Aiwa	0406
Bose	0674
Carver	0269
Curtis Mathes	0300
Denon	0160
GE	0078
Harman/Kardon	0892
JVC	0331
Left Coast	0892
Linn	0269
Luxman	0165
Magnavox	0269
Marantz	0269, 0321, 0892
NEC	0264
Nakamichi	0321
Optimus	0395, 0300
Panasonic	0308, 0521
Parasound	0246
Philips	0269, 0892
Pioneer	0013, 0300
Polk Audio	0269, 0892
RCA	0300
Realistic	0395
Sansui	0321
Shure	0264
Sony	0689, 0220
Soundesign	0078, 0211
Technics	0308, 0521
Victor	0331
Wards	0013, 0078, 0211
Yamaha	0354, 0133

RECEIVER BRAND (Amplifier)	CODE
ADC	0531
Adcom	0616
Aiwa	1089, 1405, 0121, 0158, 0189, 0405, 1321, 1388
Akai	0076, 0224
Alco	1390
Anam	1074, 1609
Apex Digital	1257
Arcam	1120
Audiotronic	1189
Audiovox	1390
Bose	1229
Capetronic	0531
Carver	1089, 1189, 0008, 0042, 0189, 0360
Casio	0195
Celestion	1264
Clarinette	0195
Compaq	1136
Curtis Mathes	0080
Denon	1104, 0004, 0273, 0771, 1311, 1360
Emerson	0424
Fisher	0042, 0219, 0360
GPX	1299
Garrard	0424, 0463
Glory Horse	1263
Harman/Kardon	0891, 0110, 0189
Hewlett Packard	1181
Inkel	0062
JBL	0110, 1306
JVC	0074, 1263, 1374
Kenwood	1313, 1027, 1570, 1569, 0027, 0042, 0077, 0186, 0313, 0314, 0569, 1051, 1052
Koss	0424, 1366
LXI	0181
Lexicon	1076
Linn	0189
Lloyd's	0195
MCS	0039, 0346

Magnavox	1089, 1189, 0128, 0189, 0195, 0391, 0531
Marantz	1089, 1189, 0039, 0128, 0189
Modulaire	0195
Musimagic	1089
NAD	0320
NEC	0235
Nakamichi	0097, 0347
Onkyo	0100, 0135, 0380, 0842, 1298
Optimus	1023, 0042, 0080, 0177, 0181, 0186, 0219, 0531, 0670, 0738, 0801, 1074
Panasonic	1518, 0039, 0309, 0367, 0518, 1288, 1350
Penney	0195
Philips	1089, 1189, 1269, 0189, 0391, 1120, 1268, 1283
Pioneer	1023, 0014, 0080, 0150, 0244, 0531, 0630, 1343, 1384
Polk Audio	0189
Proscan	1254
Quasar	0039
RCA	1023, 1254, 0054, 0080, 0346, 0360, 0530, 0531, 1074, 1154, 1390, 1609
Radio Shack	1263
Realistic	0163, 0181, 0195
Samsung	1295
Sansui	0189, 1089, 0193, 0346
Sanyo	0219, 0801, 1251
Scott	0163, 0322
Sharp	1286, 0186
Sherwood	0062, 0491, 0502
Sony	1058, 1258, 1158, 0158, 0168, 0474, 1042, 1458
Soundesign	0670
Stereophonics	1023
Sunfire	1313, 0313, 0314, 1052
Teac	0463, 0163, 1074
Technics	1308, 1309, 1518, 0039, 0208, 0309, 0518
Thorens	1189
Victor	0074
Wards	0014, 0054, 0080, 0158, 0189
Yamaha	0176, 0186, 1176
Yorx	0195
Zenith	0857

AUDIO BRAND	CODE
Aiwa	0010, 0404
AudioSource	0351
Cambridge Soundworks	0351
Carver	0351
Fisher	0052
Fosgate	0259
Harman/Kardon	0477
JBL	0477
JVC	0073
KLH	0351
Magnavox	0325
Nikko	0376
Paramount Pictures	0317, 0351
RCA	0056
SSI	0317
Sansui	0325
Schneider	0376
Sony	0010, 0576
Soundesign	0376
Yorx	0376

SET TOP BOX BRAND	CODE
Panasonic	1120
Pioneer	1010
Princeton	0113, 0295
Samsung	1190
Sensory Science	1126
Sharp	1010
Sony	0639

PERSONAL VIDEO RECORDER BRAND	CODE
Echostar	0775, 1005
Hughes	1142
Panasonic	0616
Philips	0618
Proscan	0392
ReplayTV	0614, 0616
SonicBlue	0614, 0616
Sony	0639, 0636
Tivo	0618, 0636

REAR PANEL CONNECTIONS

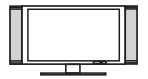

FIRST TIME USE

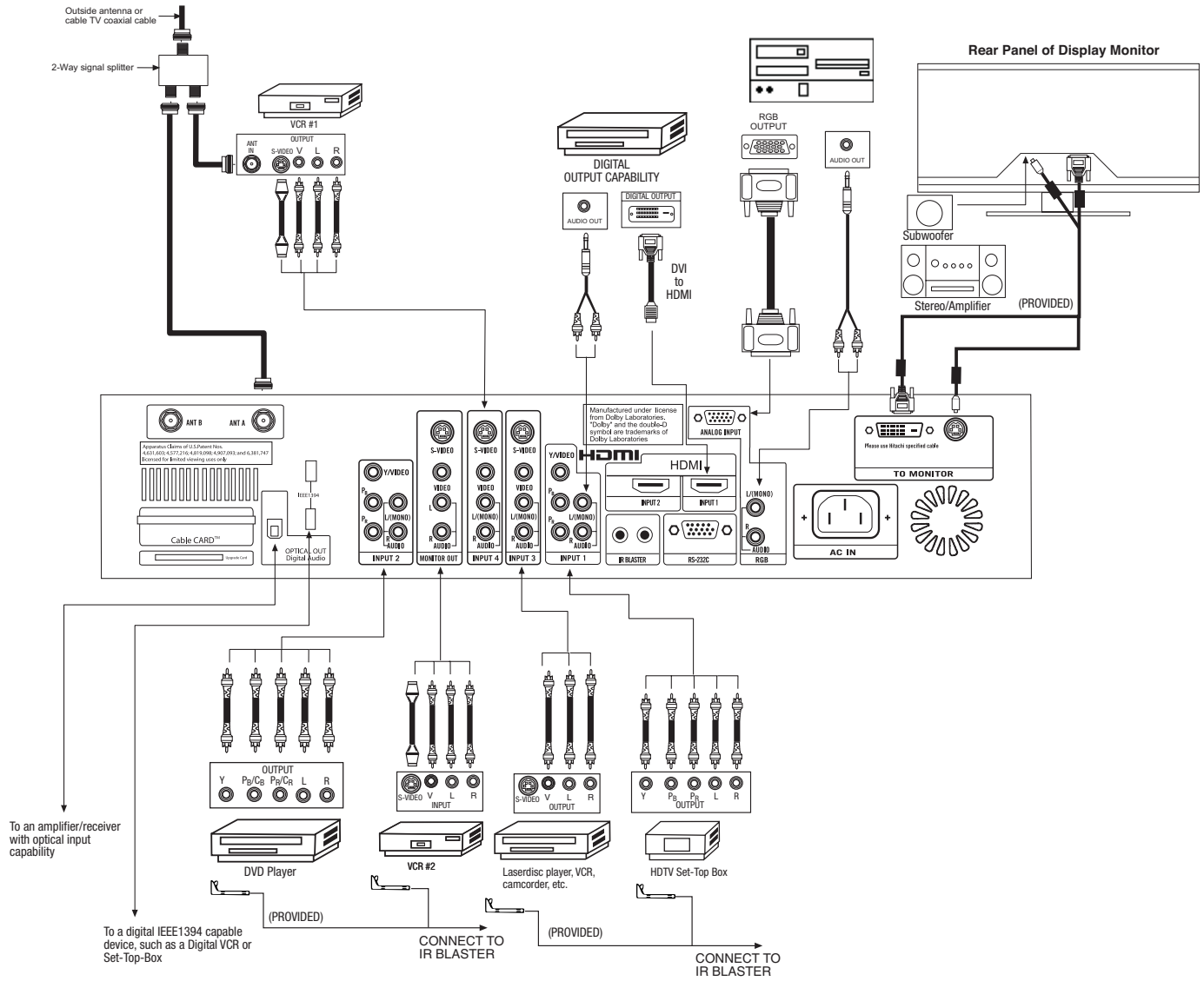

NOTE: Cables are optional, except when specified.

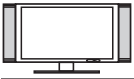

TIPS ON REAR PANEL CONNECTIONS

- S-VIDEO, YPbPR, IEEE 1394 or HDMI connections are provided for high performance laserdisc players, VCRs etc. that have this feature. Use these connections in place of the standard video connection if your device has this feature.
- If your device has only one audio output (mono sound), connect it to the left audio jack on the AVC Center.
- Refer to the operating guide of your other electronic equipment for additional information on connecting your hook-up cables.
- A single VCR can be used for VCR #1 and VCR #2, but note that a VCR cannot record its own video or line output (INPUT: 4 in the example on page 25). Refer to your VCR operating guide for more information on line input-output connections.
- Connect only 1 component (VCR, DVD player, camcorder, etc.) to each input jack.
- COMPONENT: Y-P_BP_R (Input 1 & 2) connections are provided for high performance components, such as DVD players and set-top-boxes. Use these connections in place of the standard video connection if your device has this feature.
- Your component outputs may be labeled Y, B-Y, and R-Y. In this case, connect the components B-Y output to the TV's P_B input and the components R-Y output to the TV's P_R input.
- Your component outputs may be labeled Y-C_BC_R. In this case, connect the components C_B output to the TV's P_B input and the components C_R output to the TV's P_R input.
- It may be necessary to adjust TINT to obtain optimum picture quality when using the Y-P_BP_R inputs. (See page 54)
- To ensure no copyright infringement, the MONITOR OUT output will be abnormal, when using the Y-P_BP_R, RGB and HDMI input jacks.
- Input 1 or 2 can accept HDMI signal.
- Input 1 or 2 can accept both component and composite video signal.
- S-VIDEO monitor output may be used for recording only when the input is of S-VIDEO type.
- When using a DVI or HDMI input from a Set-Top-Box, it is recommended to use a 1080i or 720p input signal.

THE REMOTE CONTROL



In addition to controlling all the functions on your HITACHI LCD TV, the new remote control is designed to operate different types of VCRs, CATV (Cable TV) converters, set-top-box, satellite receiver, DVD players, and other audio/video equipment with one touch. Basic operation keys are grouped together in one area.

To operate your LCD TV, point the remote control at the remote sensor of the AVC box/Display Monitor and select the TV by pressing the ◀ or ▶ button of the Source Access on the remote. The TV mode indicator will blink, indicating that the remote will now control your television.

To operate your VCR, point the remote at the remote sensor of the VCR and select PVR by pressing the ◀ or ▶ button of the Source Access on the remote. The PVR mode indicator will blink, indicating that the remote will now control your VCR (see page 45 for instructions on how to program the remote to control your VCR).

To operate your PVR (Personal Video Recorder), point the remote at the remote sensor of the PVR and select PVR by pressing the ◀ or ▶ button of the Source Access on the remote. The PVR mode indicator will blink, indicating that the remote will now control your PVR (see page 45 for instruction on how to program the remote to control your PVR).

To operate your cable box, point the remote at the remote sensor of the cable box and select the CABLE (CBL) by pressing the ◀ or ▶ button of the Source Access on the remote. The CBL mode indicator will blink, indicating that the remote will now control your cable box (see page 42 for instructions on how to program the remote to control your cable box).

To operate your set-top-box or satellite receiver point the remote at the remote sensor of the set-top-box and select the SET-TOP-BOX (STB) by pressing the ◀ or ▶ button of the Source Access on the remote. If you have a satellite receiver, use this button to program your satellite receiver. The STB mode indicator will blink, indicating that the remote will now control your set-top-box (see page 43 for instructions on how to program the remote to control your set-top-box).

To operate your DVD player, point the remote at the remote sensor of the DVD player and select DVD by pressing the ◀ or ▶ button of the Source Access on the remote. The DVD mode indicator will blink, indicating that the remote will now control your DVD Player (see page 44 for instruction on how to program the remote to control your DVD player).

To operate additional audio equipment, point the remote at the remote sensor of the component you wish to control and select AMP by pressing the ◀ or ▶ button of the Source Access on the remote. The AMP mode indicator will blink, indicating that the remote will now control your audio equipment (see page 46 for instructions on how to program the remote to control additional Audio/Video equipment).

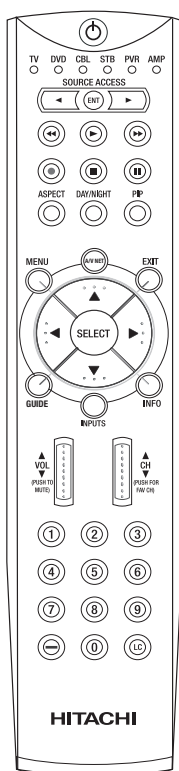

NOTE: When you are in a dark room, press any button on the remote to light up the buttons. The illumination will light for a few seconds during this time and the current mode indicator will flash one time. These buttons will not appear to light if the room is too bright.



HOW TO USE THE REMOTE TO CONTROL YOUR LCD TV

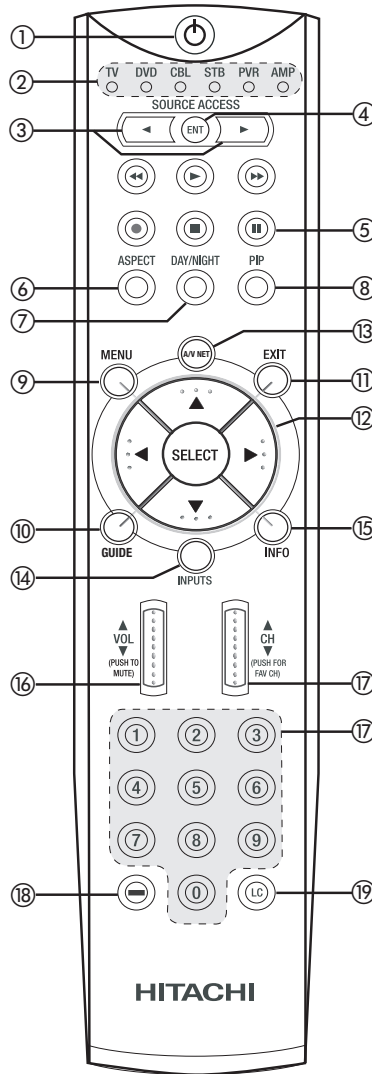

THE REMOTE CONTROL

- ① **POWER button**
Press this button to turn the TV set on or off when the remote is in TV mode. (See page 27 for instructions on how to set the remote control to TV mode.)
- ② **MODE Indicator**
Turns on or blinks to show remote control mode.
- ③ **SOURCE ACCESS (◀, ▶) buttons**
Press these buttons to select remote control mode.
- ④ **SOURCE ACCESS (ENT) button**
Hold down this button while entering your device code to program the remote (see pages 42-49). You can also use this button in an optional Input access feature (see page 47).
- ⑤ **PAUSE button**
Press the PAUSE button to freeze the picture. Press the EXIT button to return the picture to motion. Press the PAUSE button repeatedly to cycle through the three different freeze modes (see page 41).

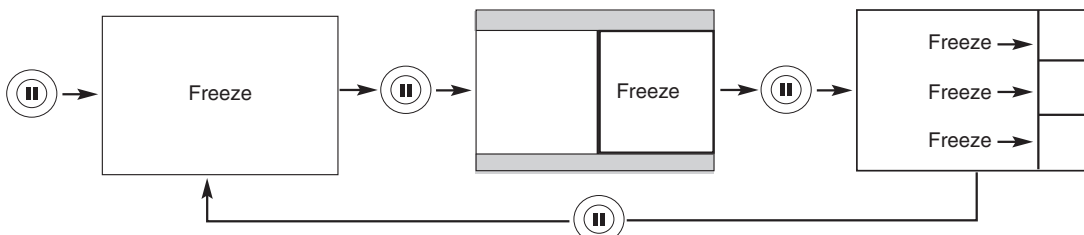

HOW TO USE THE REMOTE TO CONTROL YOUR LCD TV



⑥ ASPECT button

Press this button to quickly change the picture format ASPECT ratio.

Depending on the input signal format received, the picture format ratio allows you to adjust the images through the following options.

- 4:3 STANDARD Use this aspect mode to display conventional (4:3) images. Side panels (gray areas) are placed to the left and right of the image to preserve the original aspect ratio of the source. Note: Use this mode for only 15% of your total viewing time to prevent uneven aging of the phosphors. Phosphors in the lighted area of the picture will age more rapidly than the gray areas.
- 4:3 EXPANDED Use this aspect mode to display conventional (4:3) sources by linearly increasing image expansion from the center towards the edges of the display area in order to fill it.
- 4:3 Zoom1/Zoom2 Use these aspect modes to zoom in on conventional (4:3) sources.
- 16:9 STANDARD Use this aspect mode to display 16:9 sources like HDTV and DVD's preserving the original 16:9 aspect ratio.
- 16:9 Zoom Use this aspect to Zoom-in once while in 16:9 aspect.

(1) NTSC/480i/480P Input

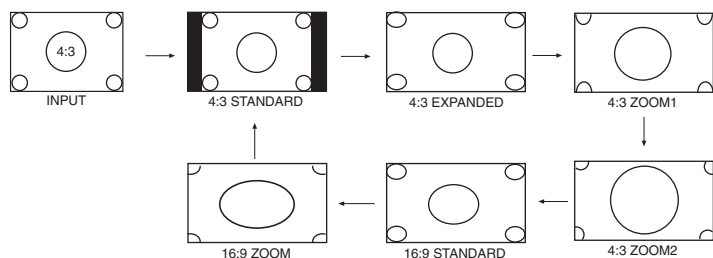

(2) 480i/480P Input

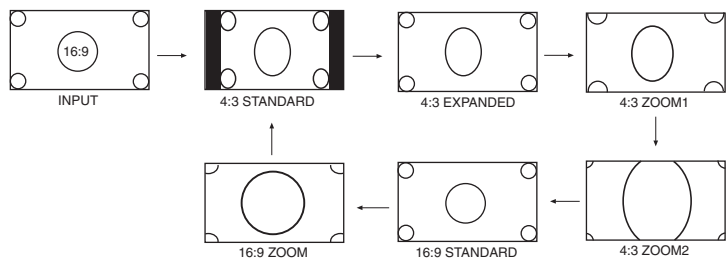

(3) 720P/1080i Input

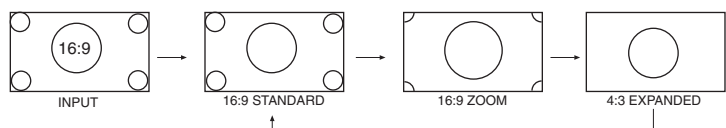

(4) RGB (Analog Input) ASPECT DISPLAY MODE.

RGB (Analog) INPUT SIGNAL						
	Others	SVGA/XGA	VGA	480p	720p	1080i
ASPECT MODE	X	REAL	REAL	REAL(1)	X	X
AVAILABILITY	NORMAL	NORMAL	NORMAL	NORMAL(1)	X	X
	FULL	FULL	FULL	FULL(1)	FULL(2,3)	FULL(2,3)

For numbers in (), please see corresponding note below.

- NOTES:**
- Lack of raster can be seen in RGB (Analog) when a 480p signal is input.
 - AUTO ADJUST function (see page 85) is not available in 720p and 1080i input signal.
 - FULL aspect mode, only 95% of information can be displayed (5% is treated as overscan).
 - Depending on the Aspect selection, Closed Caption display may be missing.



HOW TO USE THE REMOTE TO CONTROL YOUR LCD TV

⑦ DAY/NIGHT button

Press this button to toggle between Day and Night picture mode settings. Select Day for day time viewing with more brightness and contrast to compete with room light. Select Night for night time viewing with less brightness and contrast for a more detailed picture (see page 51 for settings changes).

NOTE: For automatic DAY/NIGHT picture mode settings, see page 68.

⑧ PICTURE-IN-PICTURE button

See separate section on pages 39-41 for a description.

⑨ MENU button

The MENU button will start the On-Screen Display.

⑩ GUIDE button

Press this button to access the Channel Guide. Press the GUIDE button again to return to normal viewing.

Select CHANNEL GUIDE to display available program information. Only scanned programs that are available at the present time will show in the Channel Guide (see Auto Channel Scan on page 60).

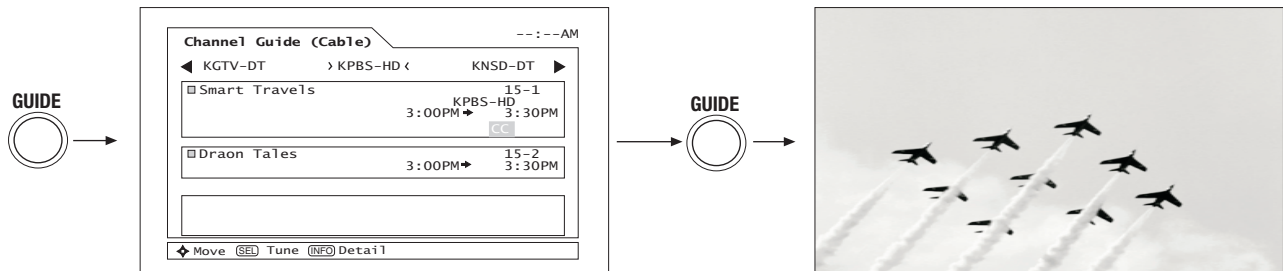

Use the CURSOR PAD ▲, ▼, ◀, ▶ to highlight the channel of choice (example: KPBS-HD). Press the CURSOR PAD ▲, ▼, to highlight the subchannel of choice (example: 15-1). Press the SELECT button to tune the subchannel of choice.

NOTE: The availability of Channel Guide Information will depend on the type of Antenna input (Analog, Digital) and Cable subscription.

⑪ EXIT button

This button will exit all On-Screen Displays.

⑫ CURSOR PAD/SELECT button

All the On-Screen Display features can be set or adjusted by using the CURSOR PAD, except for numeric entries. The CURSOR PAD will highlight functions or adjust and set different features. Press the CURSOR PAD toward desired direction and press the SELECT button to select.

HOW TO USE THE REMOTE TO CONTROL YOUR LCD TV



13 AV NET button

Press this button to access the Audio/Video network (AV Net) menu. The AV Net allows the user to control external components with the LCD TV's remote control. When you press the AV NET button, the following window will pop up within the Display Monitor screen. The window will disappear after 30 seconds if you don't press any buttons.

Select Device Setup to start.

Use CURSOR PAD ▲, ▼, ◀, ▶ to navigate and SELECT to select button. The command on the button is passed through the IR mouse and onto the AUDIO/VIDEO equipment. These on-screen buttons are called "Soft Keys".

Customize your Audio/Video equipment list and soft keys by selecting the Custom options and following the instructions of the AV NET learning wizard (see page 32).

This window shows the available Audio/Video equipment soft keys. The equipment list will scroll up or down.

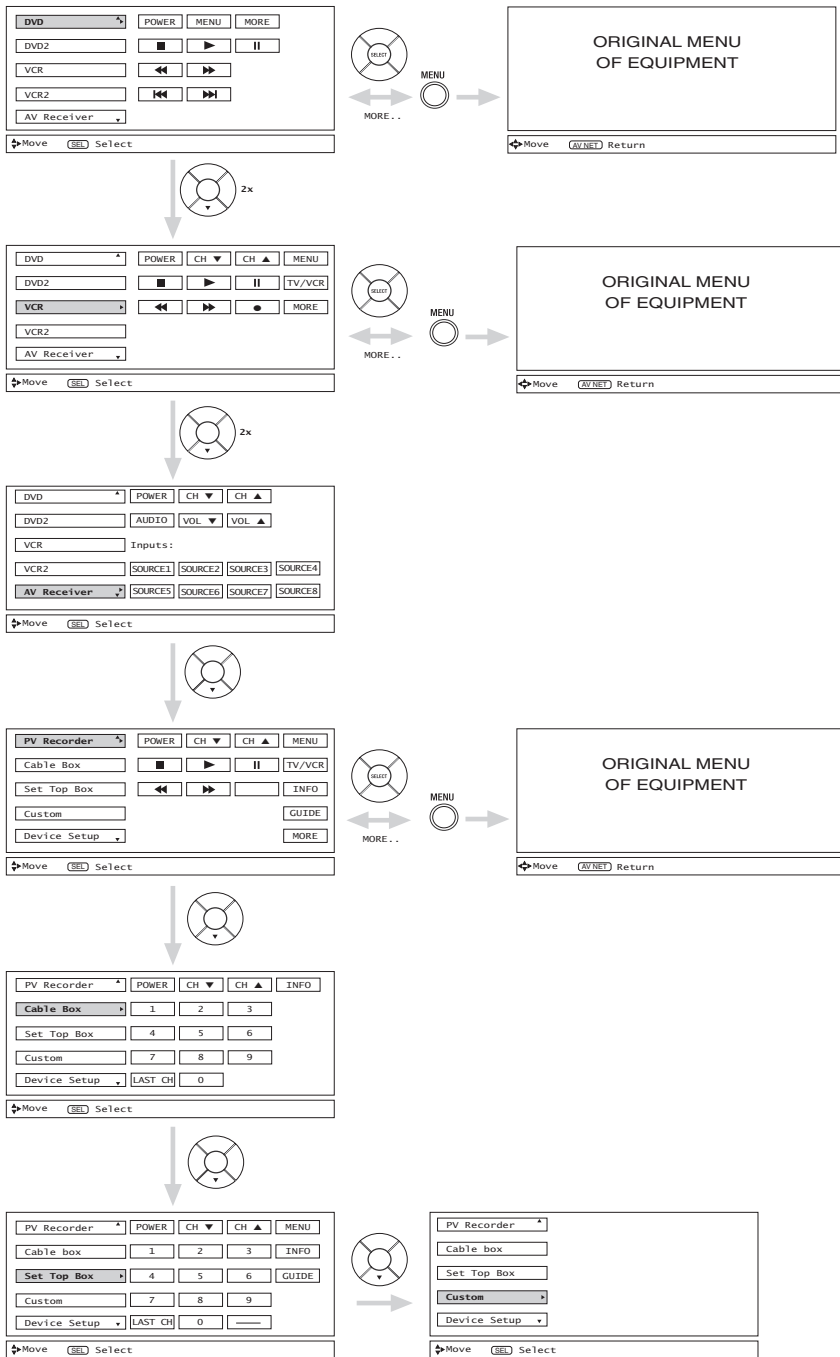

- NOTES:**
1. Devices will not be available until Device Setup is completed (see pages 22-24).
 2. The "Custom" option will not be available until the Custom device Setup is learned and completed. After completion, the "Custom" tag will be replaced with the device tag (see page 32).
 3. The Custom option only accepts one device at a time. The second Custom device setup will replace the first device.



HOW TO USE THE REMOTE TO CONTROL YOUR LCD TV

AV NET LEARNING WIZARD

This function of the AV NET makes it more expandable because it allows the user to use equipment that is not supported by the pre-code library, listed on page 24. For example, after programming your equipment to the AV NET and the soft keys do not work, the user just has to follow the steps below. The AV NET Learning Wizard will transfer any remote button IR code of your equipment to the soft keys of your AV NET. If all remote button transfers are successful, the user can now control their equipment by using the LCD TV remote control.

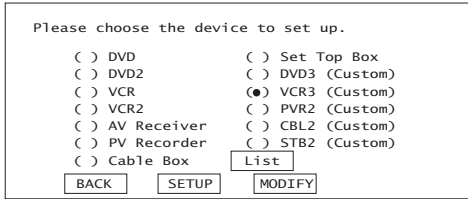

1. Press A/V NET button on the remote control.
2. Use the CURSOR PAD to select DEVICE SETUP, press the SELECT button.
3. Use the CURSOR PAD/SELECT button to choose CUSTOM option (Ex. VCR3).
4. Use the CURSOR PAD to select Setup, press the SELECT button.

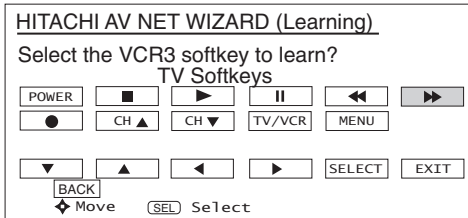

1. Select TV Softkeys to learn, press the SELECT button.

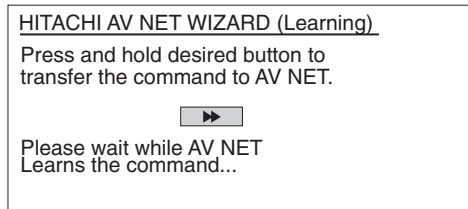

1. Press and hold the ►► button of the VCR remote control while pointing directly at the learning AV NET sensor of the AVC at a distance of 1 to 2 meters.

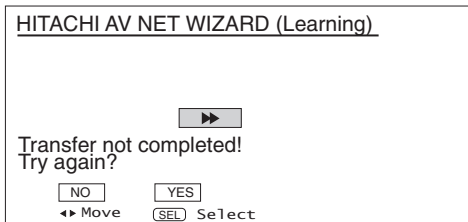

1. Select OK to continue.

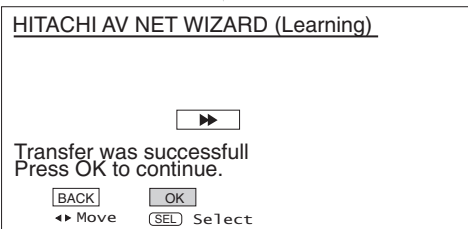

THE REMOTE CONTROL

NOTES:

1. It is very important to point the equipment's remote control directly close (about 12 inches) to the LEARNING AV NET sensor of the AVC (see pages 9-10) while trying to transfer the desired remote control button to the AV NET.
2. To access the Menu function of a specific equipment, select the "MENU" soft key on OSD, then press the MENU button of the LCD TV remote control. In order to use CURSOR PAD and EXIT button of the LCD TV remote control, "arrows, select, and EXIT" button must be learned. Then the menu of the programmed equipment can be controlled with the LCD TV remote control.

HOW TO USE THE REMOTE TO CONTROL YOUR LCD TV



14 INPUTS button

When the remote control is in TV mode, press this button to access the INPUTS menu. Use the CURSOR PAD and SELECT button to select the inputs that are being used. Pressing the INPUTS button repeatedly will also cycle through the Inputs menu items. Then press the SELECT button to select.

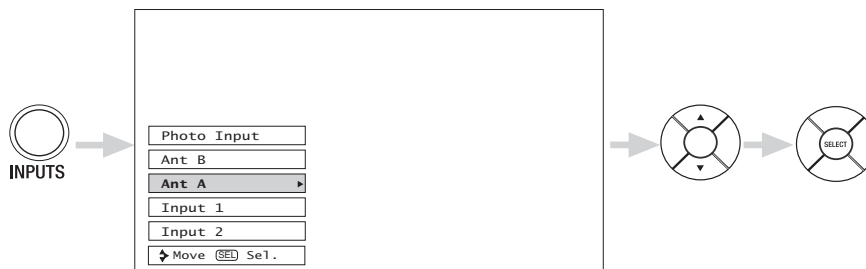

Photo Input	Select to access your pictures from a digital camera connected to the Photo Input in the front panel of the AVC (see page 34).
Ant B	Select to choose Antenna B.
Ant A	Select to choose Antenna A.
Input 1	Select to choose Input 1 for Video 1.
Input 2	Select to choose Input 2 for Video 2.
Input 3	Select to choose Input 3 for Video 3.
Input 4	Select to choose Input 4 for Video 4.
Input 5	Select to choose Input 5 for Video 5.
RGB	Select to choose for RGB input (see pages 78-87).
IEEE 1394	Select to choose for IEEE 1394 Input (see page 36).



HOW TO USE THE REMOTE TO CONTROL YOUR LCD TV

PHOTO INPUT

This feature is useful for viewing digital still pictures from your digital camera using the Photo Input in the front panel of the AVC.

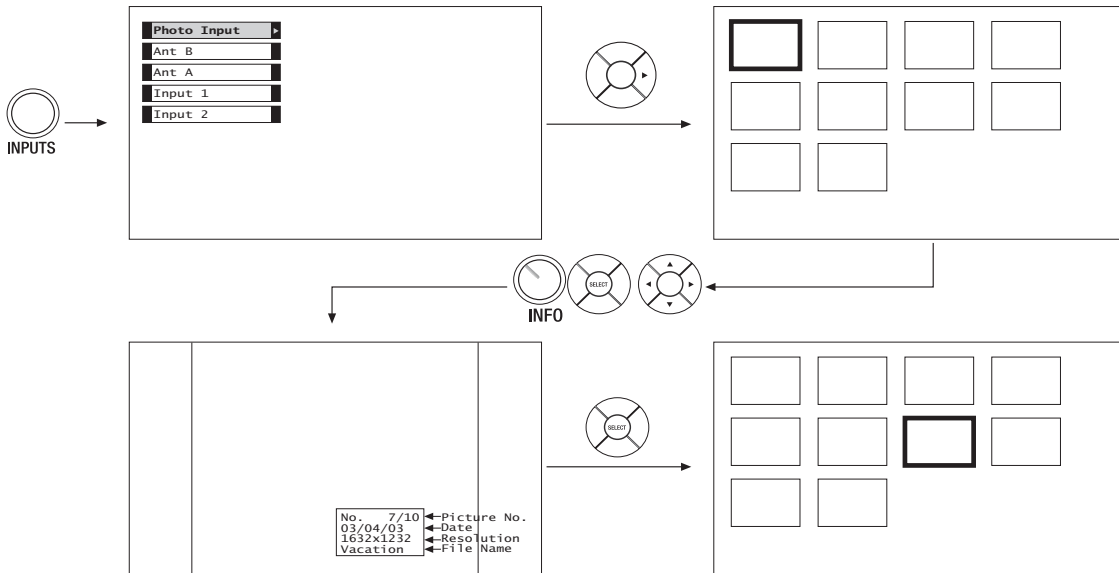

JUMP

Select this menu item to view the chosen picture number.

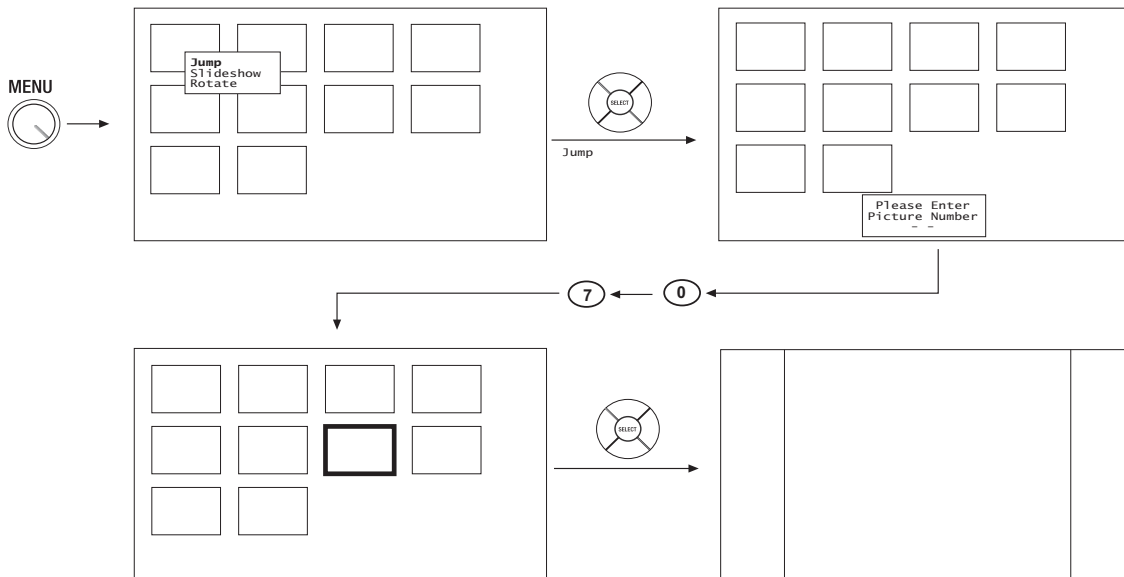

NOTES:

1. The maximum number of digital Photos that can be displayed is 999.
2. Press INFO button to show Picture Numbers in Thumbnail view, plus other information in individual photos.
3. Digital photos recorded on a DVD-RAM disc may not work with this Photo Input.
4. Certain types of digital cameras may not work with this Photo Input.
5. Digital cameras with low battery power may not properly display your photos in this input.
6. The screen may show "Input device not detected" if the digital camera's large capacity memory is fully loaded. Please wait 1 or 2 minutes before checking your Photo Input connections.
7. The screen may show "Input device not detected" due to slow access time on some digital cameras. Please wait 1 or 2 minutes before checking your Photo Input connections.

HOW TO USE THE REMOTE TO CONTROL YOUR LCD TV



SLIDESHOW

Select this menu item to start a slideshow of the Photos in the Digital Camera. Time interval selections can be set from 5, 10 and 30 seconds.

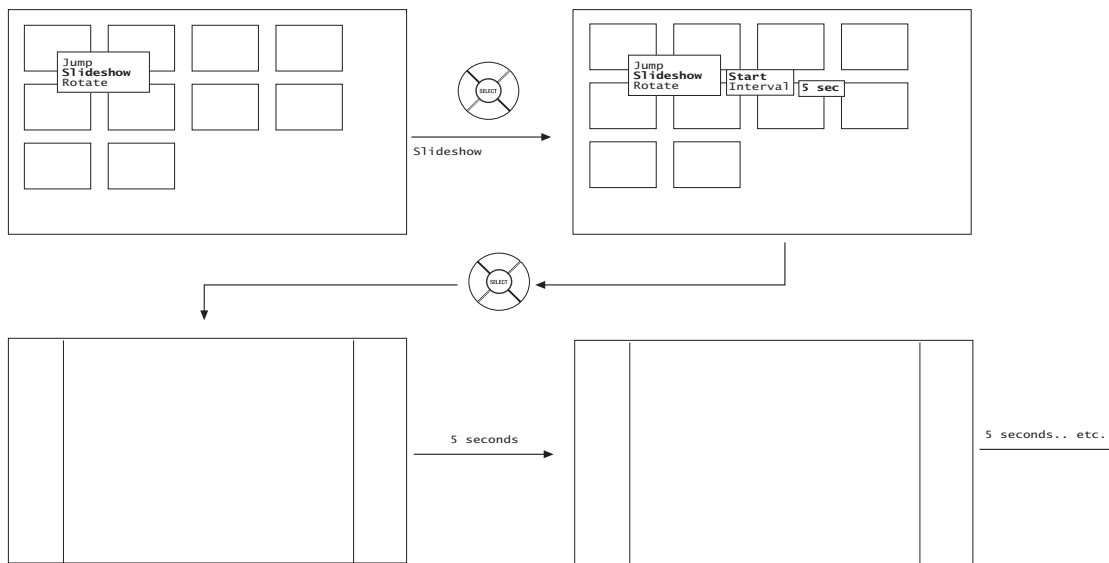

Use CURSOR PAD ▲, ▼ to highlight Slideshow item.

While interval is highlighted, press SELECT to change interval time from 5, 10 and 30 seconds. Each press will change interval time from the three mentioned choices.

Press SELECT to stop on a chosen picture of the slideshow. After 30 seconds, the slideshow will resume, or press SELECT again to continue the slideshow.

Press EXIT to exit the slideshow.

ROTATE

Select this menu item to rotate selected photos either clockwise (CURSOR PAD ►) and counterclockwise (CURSOR PAD ◀). Rotate menu item is also available in THUMBNAIL view.

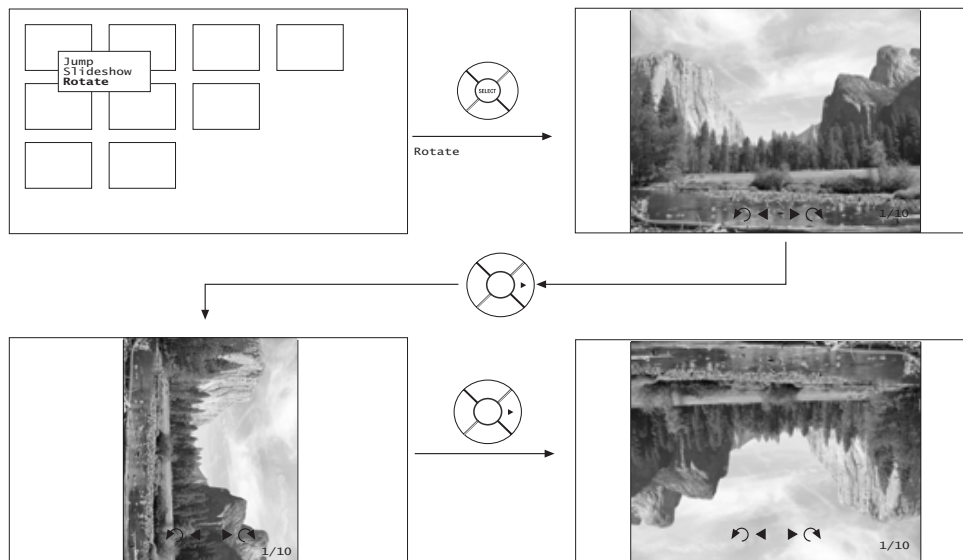

- NOTES:**
1. Photo file names modified on a computer should be 8 characters (Ex. ABCD1234.jpg). 1st character: letters; 2nd to 4th: letters or numbers; 5th to 8th: numbers. Photo files should be first placed on a sub directory name with 8 characters (Ex. 123ABCDE). 1st to 3rd: number; 4th to 8th: letters. The sub directory then should be placed on a main directory with a "dcim" file name format.
 2. Supported image types are up to 3072 x 2304; JPEG format should conform with DCF Standard (Design rule for Camera File System).
 3. This TV set displays only digital pictures from digital cameras which meet DCF Standard. Pictures that were copied, edited or modified on a computer may not be displayed on the TV set.



HOW TO USE THE REMOTE TO CONTROL YOUR LCD TV

IEEE1394 Use this function to control your devices with digital interface capability. Press the INPUTS button, CURSOR PAD and SELECT button to select IEEE 1394.

(When an IEEE1394 device is not connected)

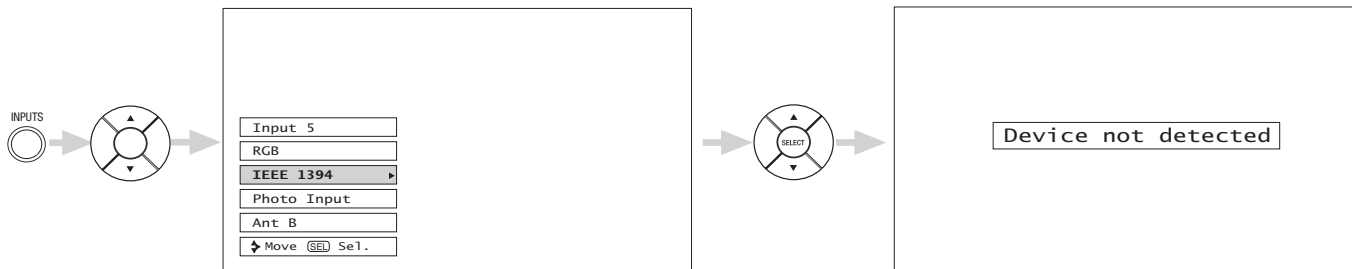

(When an IEEE1394 device is connected)

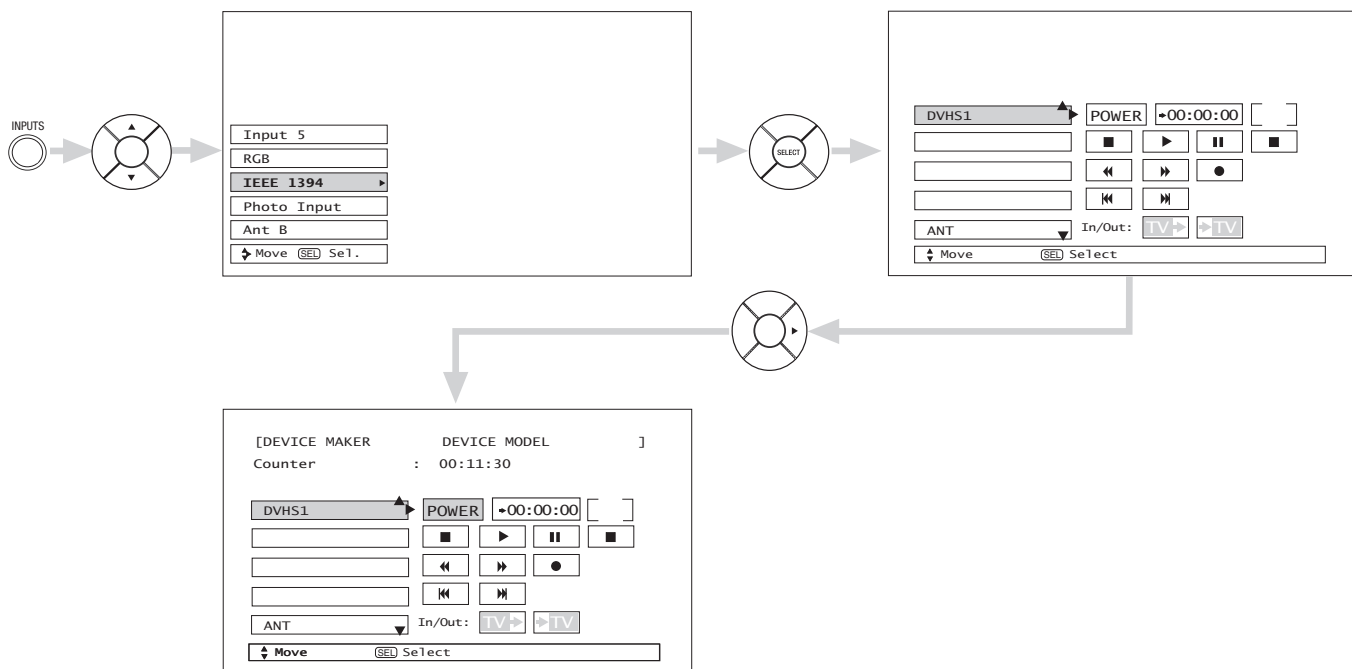

THE REMOTE CONTROL

Use CURSOR PAD ▲, ▼ to highlight connected device (example D-VHS1).
 Use CURSOR PAD ► to select connected device (example D-VHS1).
 Use CURSOR PAD cursors to highlight POWER.
 Press the SELECT button to power on the device.
 Use CURSOR PAD cursors to select D-VHS operation.
 Press down on the CURSOR PAD to enable the selected operation.
 Use CURSOR PAD cursors to highlight the TV IN/OUT operation.
 Press down on CURSOR PAD to select: TV IN is DVHS
 TV OUT is ANT A

- NOTES:**
1. The digital device will be automatically recognized if properly connected.
 2. Four (4) IEEE1394 devices can be listed on the menu, but only 1 device at a time can be used. If a fifth device is connected, it will replace the first device on the menu list.
 3. This TV's IEEE1394 connection is not compatible with a DV camcorder (Digital Video Camcorder) or a PC.
 4. The On-Screen-Display will not disappear until the EXIT button is pressed.
 5. Not all devices with IEEE1394 capability are compatible with this TV. Any compatibility problems with other manufacturers devices should be brought to the attention of those manufacturers.
 6. TV IN/OUT functions are not available when DVHS is in playback or recording.

HOW TO USE THE REMOTE TO CONTROL YOUR LCD TV



15 INFO button

Press this button when you want to check the channel being received, the picture source, if the channel has stereo (ST) or second audio program (SAP), the time, CHANNEL ID and if the TIMER is set.

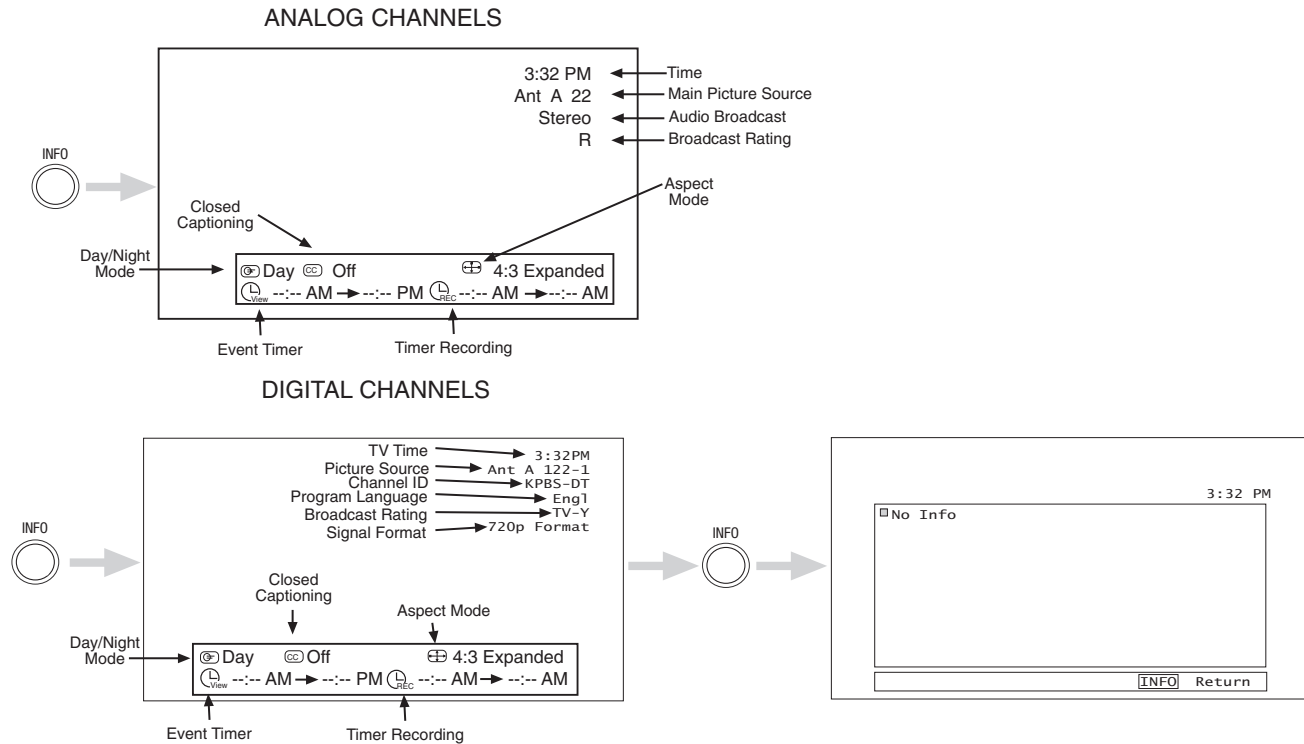

When an S-VIDEO Input is connected to VIDEO: 3.



When a COMPONENT VIDEO: Y-P_BP_R Input is connected to VIDEO: 1.

- NOTES:**
1. The Sleep Timer info will show momentarily after releasing INFO button.
 2. Press the INFO button again or the EXIT button to return to normal viewing.



HOW TO USE THE REMOTE TO CONTROL YOUR LCD TV

16 VOLUME (VOL) WHEEL, MUTE button

Use the VOL WHEEL (▲ or ▼) until you obtain the desired sound level.

To reduce the sound to one half of normal volume (SOFT MUTE) to answer the telephone, etc., press the VOL wheel down. Press the VOL wheel again to turn the sound off completely (MUTE). To restore the sound, press the VOL wheel one more time, or VOL Up (▲).

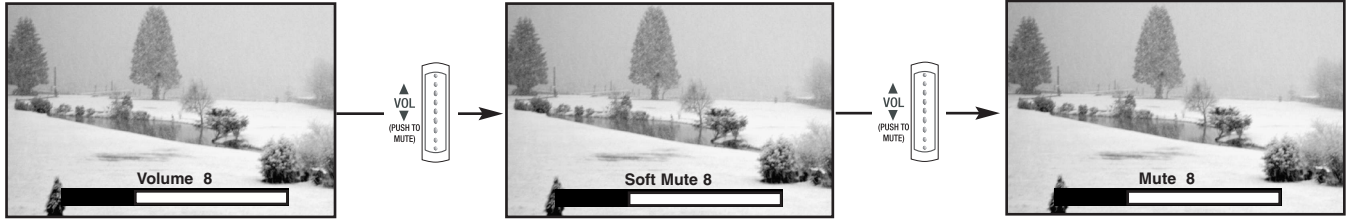

Closed Captioning will display automatically when MUTE/SOFT MUTE is on and Closed Caption is set to AUTO (see page 75).

When the TV power is turned off at a volume level 31 or greater, the volume level will default to 30 when the TV is turned on. However, if it is set to a level 30 or less, the volume level will be at the level it was set when the TV is turned ON.

17 CHANNEL (CH) WHEEL/CHANNEL SELECTOR buttons

The CHANNEL wheel or the CHANNEL SELECTOR buttons are used to select channels, lock access code, etc. Use the CHANNEL WHEEL (▲ or ▼) to select the desired channel. Use the CHANNEL SELECTOR buttons to enter one, two, or three numbers to select channels. Enter "0" first for channels 1 to 9, or simply press the single digit channel you wish to tune then wait a few seconds for the TV to tune. For Digital Channels, use the CHANNEL SELECTOR buttons with the (-) DASH button. Channel selection may also be performed by CHANNEL WHEEL up (▲) or CHANNEL WHEEL down (▼).

Press the channel (CH) wheel to switch to Favorite (FAV) channel mode. You will know you are in Favorite Channel mode when (FAV) is displayed and the displayed channel is GREEN. Press it again to return to your regular tuned channels. You can add any channel to your Favorite channel list by pressing and holding down the Channel (CH) wheel until the displayed channel turns from WHITE to highlighted GREEN. You can also delete a channel from your favorite channel list by pressing and holding down the Channel (CH) wheel until the displayed channel turns highlighted GREEN to WHITE.



18 (-) DASH button

Use the (-) DASH button with the CHANNEL SELECTOR buttons to enter Digital Channels that have subchannel numbers indicated by (-) DASH (example 15-1).

19 LAST CHANNEL (LC) button

Press this button to toggle between the current and last channel viewed.

PICTURE-IN-PICTURE (PIP)



Your HITACHI LCD TV incorporates Two Tuner technology designed for improved viewing enjoyment. This Two Tuner feature allows you to view antenna inputs on both the main picture and sub-picture simultaneously, with separate tuning control for each.

ANT A input can be viewed as both the main picture and the sub-picture simultaneously. ANT B can only be viewed as a main picture. To select between main picture and PIP sub-picture tuning, use the CURSOR PAD on the remote. The green highlighted channel display will move with every press of the CURSOR PAD (◀, ▶).

The Picture-in-Picture feature is convenient when you want to watch more than one program at the same time. You can watch a TV program while viewing other programs from any of the video inputs.

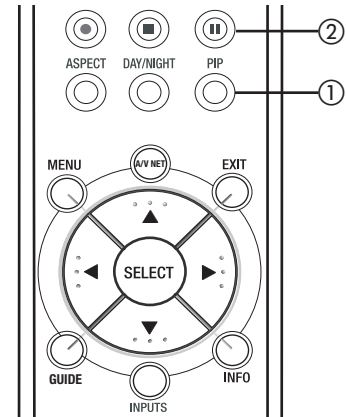
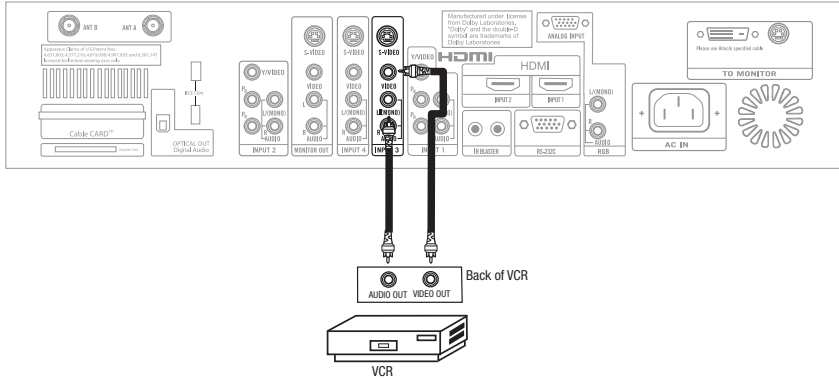

Use above connection to view VCR program as a sub-picture while viewing another program as main picture (ANT A, ANT B, INPUT:1, INPUT:2, INPUT:4, or INPUT:5). You may also view the VCR program as a main picture while viewing another program as a sub-picture (ANT A, INPUT:1, INPUT:2, INPUT:4 or INPUT:5).

When installing a CableCARD, connect your coaxial cable to ANT A (see page 13). ANT B will not be available while using a CableCARD.

① PIP button

Press the PIP button and a sub-picture will appear in one of the four different modes (POP, PIP, SPLIT or SURF), depending on the INPUT signal. To change the PIP mode, use the PIP button to cycle through the four different modes.

POP MODE PICTURE-IN-PICTURE

POP Mode PIP displays the sub-picture outside of the main picture. Use the CURSOR PAD (▲, ▼) to move the sub-picture. This feature is not available with a 1080i component input or Digital signal. Please refer to the PICTURE-IN-PICTURE MODES Table (see page 40).



- NOTES:**
1. Digital Channels cannot be viewed as a sub-picture.
 2. PIP MODE Picture-in-Picture is only available with a 1080i component or digital signal.
 3. Press the CURSOR PAD (◀, ▶) to enable the sub-picture sound.
 4. Sub-picture channel availability depends on the channel list.



PICTURE-IN-PICTURE (PIP)

PIP MODE PICTURE-IN-PICTURE

This feature is only available with a 1080i component input or Digital signal. To prevent a pattern burn, occasionally move the sub-picture using the CURSOR PAD.

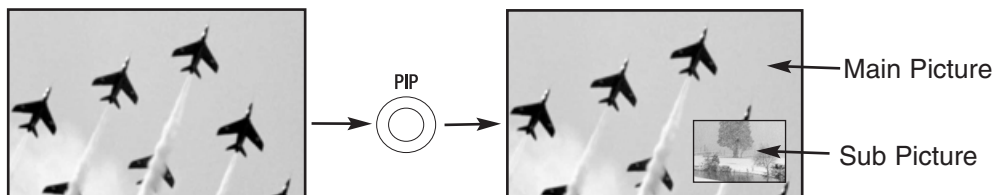

SPLIT MODE PICTURE-IN-PICTURE

Split Mode PIP displays the main picture and sub-picture evenly on the screen.

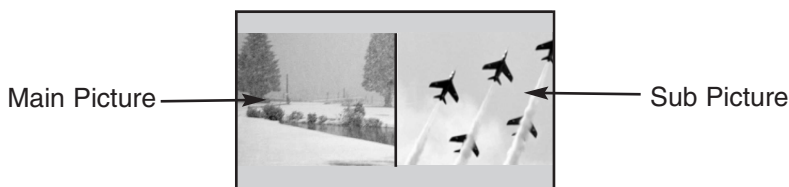

THE REMOTE CONTROL

SURF MODE PICTURE-IN-PICTURE

Surf Mode PIP automatically scans all active channels (those set in memory) and displays them as PIP Pictures or Thumbnail channels.



NOTE: Selecting individual sub-pictures while in Surf mode is not available.

PICTURE-IN-PICTURE (PIP) MODES

PIP Mode	Sub		NTSC	480i	480p	720p	1080i
	Main						
POP	NTSC		Yes	Yes	-	-	Yes
	480i		Yes	Yes	-	-	Yes
PIP 4x3	1080i		Yes	Yes	-	-	-
PIP 16x9	1080i		Yes	Yes	-	-	Yes
SPLIT	NTSC		Yes	Yes	Yes	Yes	Yes
	480i		Yes	Yes	Yes	Yes	Yes
	480p		Yes	Yes	Yes	Yes	Yes
	720p		Yes	Yes	Yes	Yes	Yes
	1080i		Yes	Yes	Yes	Yes	Yes
12 Pix	-		Ant A/B	-	-	-	-

PICTURE-IN-PICTURE (PIP)



② PAUSE button

If you wish to freeze the sub-picture, press the PAUSE button. This is convenient when trying to write down the address for a mail order company, recording statistics for a sporting event, etc. To return the picture to motion, press the EXIT button. Press the PAUSE button repeatedly to toggle between FREEZE modes (Main Freeze, SPLIT and STROBE).

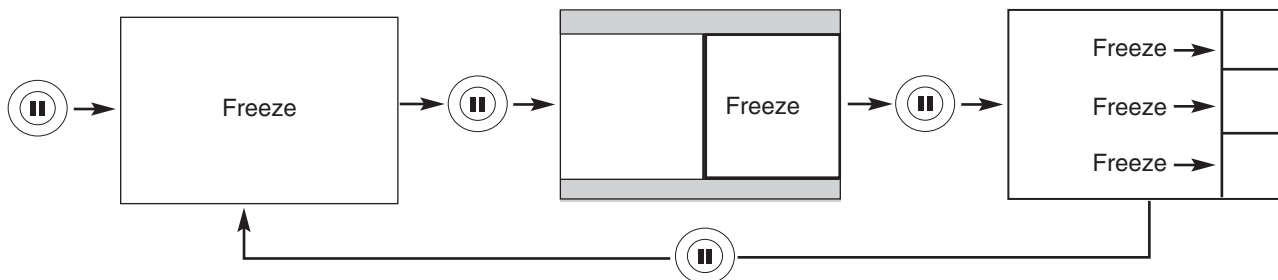

MAIN FREEZE

Press the PAUSE button to freeze one frame of the picture you are currently viewing and the frozen frame will show in the Main Picture. Press the EXIT button to return to normal viewing. This feature is useful for freezing a picture frame with addresses.

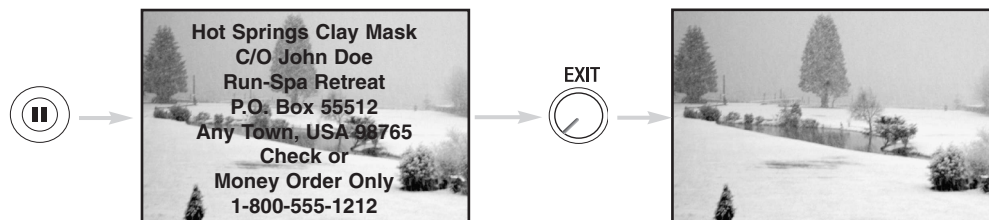

SPLIT FREEZE

Press the PAUSE button to freeze the picture you are currently viewing (only the right sub-picture will freeze). Press the EXIT button to return to normal viewing.

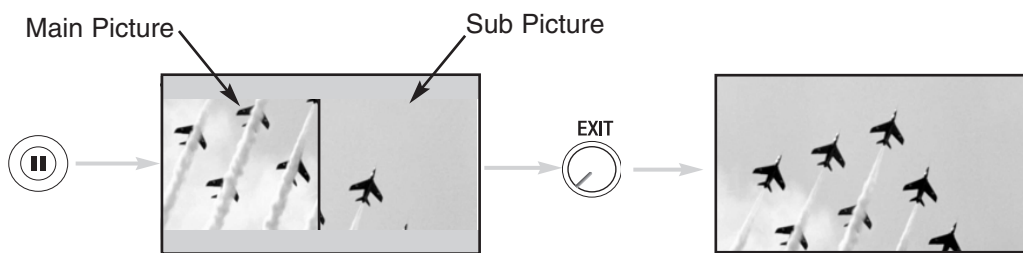

STROBE FREEZE

Press the PAUSE button to freeze three frames of the picture you are currently viewing (only the 3 sub-pictures will freeze). Press the EXIT button to return to normal viewing. This feature is useful for viewing a moving picture that has many details, for example, a close play in a sporting event or a golf swing.

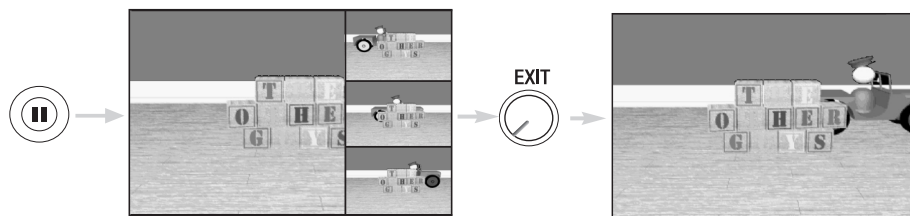

- NOTES:**
1. The default FREEZE mode is the MAIN freeze followed by the SPLIT freeze and then the STROBE freeze. The last Freeze mode you selected before you pressed the EXIT button will be the one that comes up after pressing the PAUSE button again.
 2. Each freeze frame in Strobe Freeze is delayed about 0.1 (1/10) second.
 3. Strobe Freeze is not available in 480p/720p/1080i inputs.



HOW TO USE THE REMOTE TO CONTROL CABLE BOX FUNCTIONS

Operating the precoded function for your cable box.

This remote is designed to operate different types of cable boxes. You must first program the remote to match the remote system of your cable box (refer to pages 48-49 for pre-codes).

1. Turn ON your cable box.
2. Aim the remote control at the front of your cable box.
3. To switch to Cable (CBL) pre-coded mode, use the SOURCE ACCESS buttons (◀, ▶) on the remote control to position the LED light to the corresponding selection.
4. Hold down the ENT button on the remote and enter the four digit preset code that matches your cable box as shown on pages 48-49. Release the ENT button. The indicator light will flash 3 times if the code was accepted.
5. Aim the remote at the cable box and press the POWER button. The remote will turn off your cable box when the correct four digit preset code is entered. When this occurs, the remote control is programmed for your cable box. If the cable box does not turn off, try a different four digit preset code.
6. The remote will now control your Cable box.

THE REMOTE CONTROL

NOTES:

1. If your cable box cannot be operated after performing the above procedures, your cable box code has not been precoded into the remote.
2. In the unlikely event that your cable box cannot be operated after performing the above procedures, please consult your cable box operating guide.
3. The remote control will remember the codes you have programmed until the batteries are removed from the remote control. After replacing the batteries repeat the entire programming procedure as stated above.

- ① **PRECODED CABLE BOX buttons**
These buttons transmit the chosen precoded cable codes.
- ② **EXCLUSIVE TV buttons**
These buttons are for operating the TV.

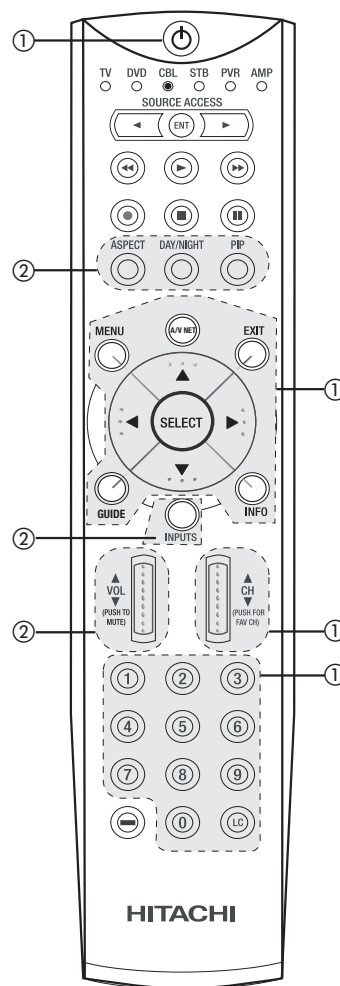

MY CABLE BOX CODE IS: _____

NOTE: Refer to instruction manual of the Cable Box for operation of the buttons exclusively for the Cable Box.

HOW TO USE THE REMOTE TO CONTROL SET-TOP-BOX/SATELLITE RECEIVER FUNCTIONS



Operating the precoded function for your set-top-box/satellite receiver.

This remote is designed to operate different types of set-top-box/satellite systems. You must first program the remote to match the remote system of your set-top-box/satellite systems (refer to pages 48-49 for pre-codes).

1. Turn ON your set-top-box/satellite systems.
2. Aim the remote control at the front of your set-top-box/satellite systems.
3. To switch to set-top-box/satellite (STB) pre-coded mode, use the SOURCE ACCESS buttons (◀, ▶) on the remote control to position the LED light to the corresponding selection.
4. Hold down the ENT button on the remote and enter the four digit preset code that matches your set-top-box/satellite receiver as shown on page 48-49. Release the ENT button. The indicator light will flash 3 times if the code was accepted.
5. Aim the remote at the set-top-box/satellite receiver and press the POWER button. The remote will turn off your set-top-box/satellite receiver when the correct four digit preset code is entered. When this occurs, the remote control is programmed for your set-top-box/satellite receiver. If the set-top-box/satellite receiver does not turn off, try a different four digit preset code.
6. The remote will now control your set-top-box/satellite receiver.

NOTES:

1. If your set-top-box/satellite receiver cannot be operated after performing the above procedures, your set-top-box/satellite receiver code has not been precoded into the remote.
2. In the unlikely event that your set-top-box/satellite receiver cannot be operated after performing the above procedures, please consult your set-top-box/satellite receiver operating guide.
3. The remote control will remember the codes you have programmed until the batteries are removed from the remote control. After replacing the batteries repeat the entire programming procedure as stated above.

① PRE-CODED SET-TOP-BOX/SATELLITE RECEIVER buttons

These buttons transmit the chosen pre-coded set-top-box/satellite codes.

② EXCLUSIVE TV buttons

These buttons are for operating the TV.

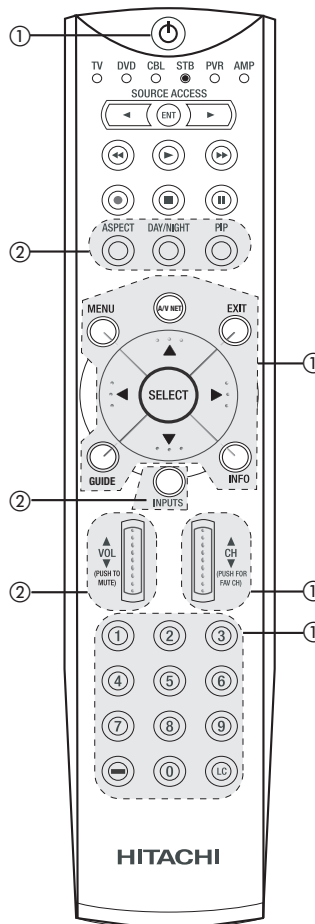

THE REMOTE CONTROL

MY SATELLITE RECEIVER/STB CODE IS: _____

NOTE: Refer to instruction manual of the set-top-box/satellite receiver for operation of the buttons exclusively for the set-top-box/satellite receiver.



HOW TO USE THE REMOTE TO CONTROL DVD FUNCTIONS

Operating the precoded function for your DVD player.

This remote is designed to operate different types of DVD players. You must first program the remote to match the remote system of your DVD player (refer to pages 48-49 for pre-codes).

1. Turn ON your DVD player.
2. Aim the remote control at the front of your DVD player.
3. To switch to DVD pre-coded mode, use the SOURCE ACCESS buttons (◀, ▶) on the remote control to position the LED light to the corresponding selection.
4. Hold down the ENT button on the remote and enter the four digit preset code that matches your DVD player, as shown on pages 48-49. Release the ENT button. The indicator light will flash 3 times if the code was accepted.
5. Aim the remote at the DVD player and press the POWER button. The remote will turn off your DVD player when the correct four digit preset code is entered. When this occurs, the remote control is programmed for your DVD player. If the DVD player does not turn off, try a different four digit preset code.
6. The remote will now control your DVD player.
7. You will need to set the display type of your DVD player to 16:9 widescreen.

THE REMOTE CONTROL

NOTES:

1. If your DVD player cannot be operated after performing the above procedures, your DVD player's code has not been precoded into the remote.
2. In the unlikely event that your DVD player cannot be operated after performing the above procedures, please consult your DVD player operating guide.
3. The remote control will remember the codes you have programmed until the batteries are removed from the remote control. After replacing the batteries repeat the entire programming procedure as stated above.

- ① **PRECODED DVD Buttons**
These buttons transmit the chosen precoded DVD codes.
- ② **EXCLUSIVE TV Buttons**
These buttons are for operating the TV.

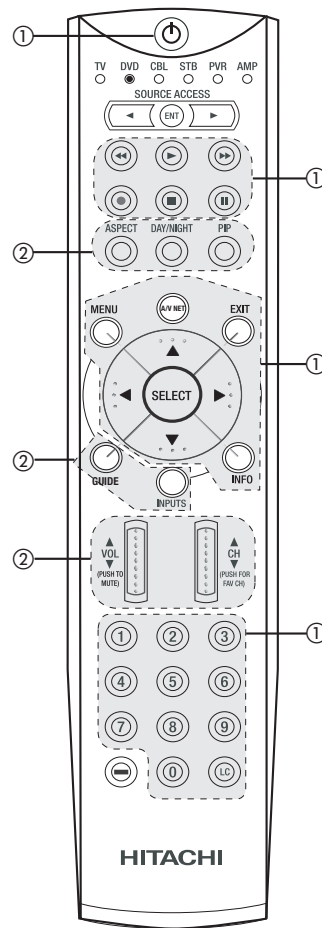

MY DVD PLAYER CODE IS: _____

NOTE: Refer to instruction manual of the DVD player for operation of the buttons exclusively for the DVD player.

HOW TO USE THE REMOTE TO CONTROL VCR/PVR FUNCTIONS



Operating the precoded function for your VCR/PVR (Personal Video Recorder).

This remote is designed to operate different types of VCRs/PVRs. You must first program the remote to match the remote system of your VCR/PVR (refer to pages 48-49 for pre-codes).

1. Turn ON your VCR/PVR.
2. Aim the remote control at the front of your VCR/PVR.
3. To switch to VCR/PVR pre-coded mode, use the SOURCE ACCESS buttons (◀, ▶) on the remote control to position the LED light to the corresponding selection.
4. Hold down the ENT button on the remote and enter the four digit preset code that matches your VCR/PVR, as shown on pages 48-49. Release the ENT button. The indicator light will flash 3 times if the code was accepted.
5. Aim the remote at the VCR/PVR and press the POWER button. The remote will turn off your PVR when the correct four digit preset code is entered. When this occurs, the remote control is programmed for your VCR/PVR. If the VCR/PVR does not turn off, try a different four digit preset code.
6. The remote will now control your VCR/PVR.

NOTES:

1. If your PVR cannot be operated after performing the above procedures, your PVR's code has not been precoded into the remote.
2. In the unlikely event that your PVR cannot be operated after performing the above procedures, please consult your PVR operating guide.
3. The remote control will remember the codes you have programmed until the batteries are removed from the remote control. After replacing the batteries repeat the entire programming procedure as stated above.
4. VCR precode library is included in the PVR mode. Default device for this mode is Hitachi VCR.
5. INFO, GUIDE and LC (Last Channel) buttons are for PVR devices, not for VCR.

① PRECODED VCR/PVR Buttons

These buttons transmit the chosen precoded VCR/PVR codes.

② EXCLUSIVE TV Buttons

These buttons are for operating the TV.

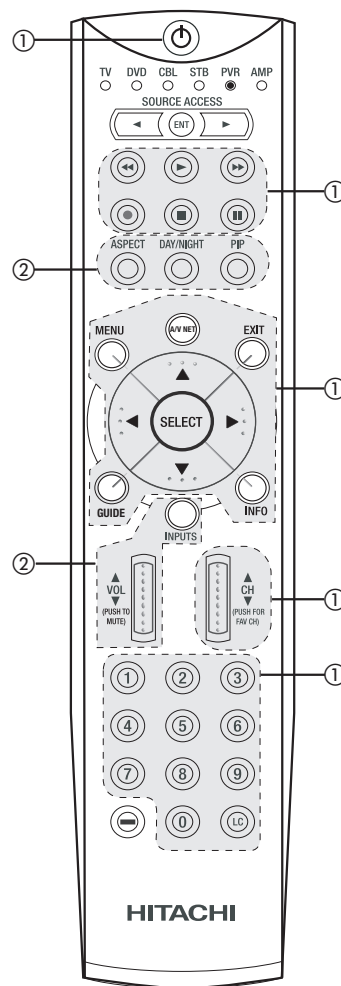

THE REMOTE CONTROL

MY VCR/PVR CODE IS: _____

NOTE: Refer to instruction manual of the VCR/PVR for operation of the buttons exclusively for the VCR/PVR.



HOW TO USE THE REMOTE TO CONTROL ADDITIONAL AUDIO EQUIPMENT

Operating the precoded function for your Audio component.

This remote is designed to operate different types of Audio component. You must first program the remote to match the remote system of your Audio component (refer to pages 48-49 for pre-codes).

1. Turn ON your Audio component you wish to control with the Remote.
2. Aim the remote control at the front of your Audio component.
3. To switch to Audio (AMP) component pre-coded mode, use the SOURCE ACCESS buttons (◀, ▶) on the remote control to position the LED light to the corresponding selection.
4. Hold down the ENT button on the remote and enter the four digit preset code that matches your Audio component, as shown on pages 48-49. Release the ENT button. The indicator light will flash 3 times if the code was accepted.
5. Aim the remote at the Audio component and press the POWER button. The remote will turn off your Audio component when the correct four digit preset code is entered. When this occurs, the remote control is programmed for your Audio component. If the Audio component does not turn off, try a different four digit preset code.
6. The remote will now control your Audio component.
7. Repeat steps 1 - 6 if you wish to program the remote to control another Audio component.

THE REMOTE CONTROL

NOTES:

1. If your Audio component cannot be operated after performing the above procedures, your Audio component's code has not been precoded into the remote.
2. In the unlikely event that your Audio component cannot be operated after performing the above procedures, please consult your Audio equipment operating guide.
3. The remote control will remember the codes you have programmed until the batteries are removed from the remote control. After replacing the batteries repeat the entire programming procedure as stated above.
4. CD precode library is included in the AMP mode. Default device for this mode is Hitachi Audio/Video Receiver (AVR/AMP).
5. INPUT, GUIDE, Channel (up/down), Volume (up/down) and REC button are not for CD devices.

① PRECODED AUDIO Buttons

These buttons transmit the chosen precoded Audio component codes.

② EXCLUSIVE TV Buttons

These buttons are for operating the TV.

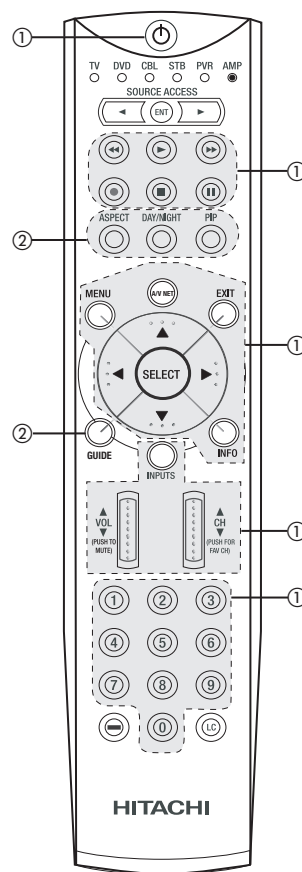

MY AUDIO EQUIPMENT CODE IS:

CD _____
 AMP/RCVR _____

- NOTES:**
1. The REC (Record) button only applies to some precoded amplifier/receiver codes.
 2. Refer to instruction manual of the Audio equipment for operation of the buttons exclusively for the Audio equipment.

HOW TO USE THE REMOTE “ENT” BUTTON TO ACCESS THE SPECIFIED INPUT OF THE LCD TV



INPUT ACCESS

This optional feature allows the user of the remote control to setup it's ENTER (ENT) button to access the specified input of the TV. Setup for this feature is applicable to the remote control's normal mode only and only applies to the DVD, CBL, STB, PVR and AMP modes.

1. Select the desired device mode (DVD, CBL, STB, PVR, or AMP) by using your SOURCE ACCESS buttons (◀, ▶) to position the LED indicator to the corresponding selection.
2. Hold down the ENTER (ENT) button on the remote and enter the four digit preset code that matches your device as shown on pages 48-49.
3. Then enter the assigned input number (1-5) that the device is related to.
4. Release ENTER (ENT) button.
5. If done correctly, the device LED indicator will flash 3 times to confirm proper setup.
6. The remote will now control the desired device.
7. Pressing the ENTER (ENT) button will now access the video input (1-5) of the desired device.

SETUP EXAMPLE (Hitachi DVD with precode 0573 connected to INPUT 1 of the TV)

- ① Select DVD mode by using your SOURCE ACCESS buttons (◀, ▶) to position the LED indicator to DVD.
- ② Hold down the ENTER (ENT) button and press the numbers 0, 5, 7 and 3.
- ③ Then press the number 1 for the assigned input number of the DVD player.
- ④ Release ENTER (ENT) button.
- ⑤ If done correctly, the device LED indicator will flash 3 times to confirm proper setup.
- ⑥ The remote will now control the DVD player.
- ⑦ Press the ENTER (ENT) button to instantly access the video input of your DVD on Input 1.

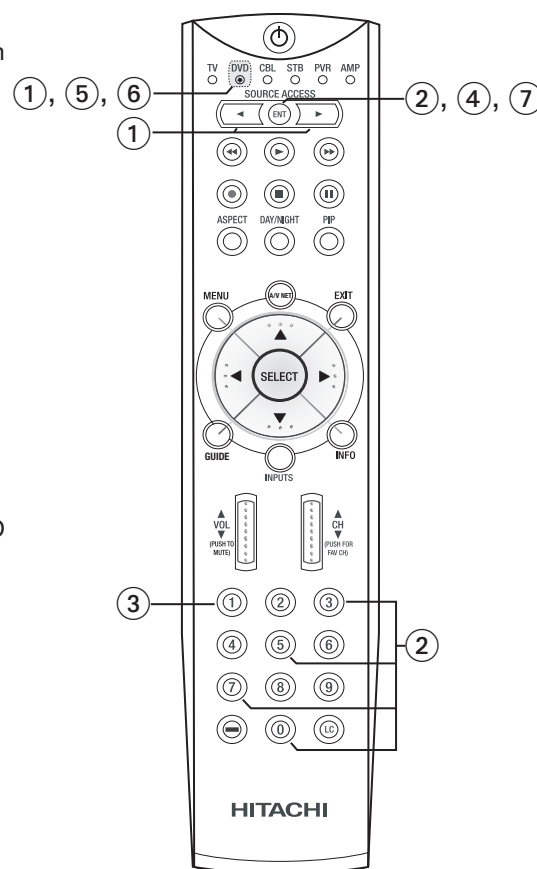

THE REMOTE CONTROL

- NOTES:**
1. This feature is optional.
 2. Assigned input numbers can be used more than once if applicable.



PVR/VCR, CABLE, SATELLITE, DVD AND AUDIO CODES FOR REMOTE CONTROL

THE REMOTE CONTROL

VCR BRAND	CODE	Matsushita	0035, 0162, 1162	Totevision	0037, 0240	Philips	0503, 0539, 0646, 0854
ABS	1972	Media Center PC	1972	Touch	1972	Pioneer	0525, 0571, 1902
Admiral	0048, 0209	Memorex	0035, 0162, 0037, 0048, 0039, 0047, 0240, 0000, 0104, 0209, 0046, 0307, 0479, 1037, 1162, 1262	Unitech	0240	Polaroid	1061, 1086
Adventura	0000	Microsoft	1972	Vector	0045	Polk Audio	0539
Aiko	0278	Mind	1972	Vector Research	0038	Proscan	0522
Aiwa	0000, 0037, 0307	Minolta	0042, 0105	Video Concepts	0045, 0061	Qwestar	0651
Akai	0041, 0061, 0106	Mitsubishi	0061, 0043, 0067	Videomagic	0037	RCA	0522, 0571, 0717, 0790, 0822, 1974
Alienware	1972	Motorola	0035, 0048	Videosonic	0240	Recco	0698
America Action	0278	Multitech	0000, 0072	Viewsonic	1972	Rio	0869
American High	0035	NEC	0038, 0041, 0067, 0104	Wards	0060, 0062, 0035, 0048, 0047, 0081, 0240, 0000, 0042, 0072, 0212	Rotel	0623
Asha	0240	Nikko	0037	White Westinghouse	0072, 0209	Rowa	0823
Audiovox	0037, 0278	Noblex	0240	XR-1000	0072, 0000, 0035	Sampo	0698, 0752
Beaumarck	0240	Northgate	1972	Yamaha	0038	Samsung	0490, 0573, 0820, 0744, 1075
Bell & Howell	0104	Olympus	0035	ZT Group	1972	Sansui	0695
Broksonic	0121, 0184, 0002, 0209, 0479	Optimus	0593, 1062, 0162, 0037, 0048, 0104, 0432, 1048, 1162, 1262	Zenith	0039, 0000, 0209, 0033, 0479, 1479	Sanyo	0670, 0695, 0873
CCE	0072, 0278	Optonica	0062			Sanyo	0503
Calix	0037	Orion	0184, 0209, 0002, 0479	DVD BRAND	CODE	Sharp	0630, 0752
Canon	0035	Panasonic	0162, 1062, 0035, 0616, 1162, 1262	AMW	0872	Shinsonic	0533, 0839
Carver	0081	Penney	0035, 0037, 0240, 0042, 0038	Aiwa	0641	Sonic Blue	0869
Cineral	0278	Pentax	0042, 0105	Allegro	0869	Sony	0533
Citizen	0278, 0037	Philco	0035, 0209, 0479, 0561	Apex Digital	0672, 0717, 0755, 0794, 0796, 0797, 1004, 1020, 1056, 1061, 1100, 1915, 1937	Sylvania	0675
Colt	0072	Philips	0081, 0035, 0618, 1081, 1181, 0062	Audiovox	0790, 1072	Symphonic	0675
Craig	0037, 0072, 0047, 0240, 0271	Pilot	0037	Axion	1072	TYT	0705
Curtis Mathes	0035, 0041, 0060, 0162	Pioneer	0067	Blaupunkt	0717	Teac	0790
CyberPower	1972	Polk Audio	0081	Blue Parade	0571	Technics	0490
Cybernex	0240	Profitronic	0240	Brooksonic	0695	Theta Digital	0571
Daewoo	0278, 0045, 0561	Proscan	0060, 0202, 0761	CAVS	1057	Tivo	1996
Dell	1972	Protec	0072	CineVision	0876, 0869	Toshiba	0503, 0695, 1045, 1988, 1996, 2006
Denon	0042	Pulsar	0039	Classic	1917	Tredex	0799, 0803
Durabrand	0039, 0038	Quarter	0046	Coby	1086	US Logic	0839
Dynatech	0000	Quartz	0046	Curtis Mathes	1087	Urban Concepts	0503
Dynatone	0037	Quasar	0035, 0162, 1162	CyberHome	0816, 1023, 1024	Venturer	0790
Electrohome	0037	RCA	0060, 0240, 0042, 0105, 0106, 0202, 0761, 0880	DVD2000	0521	XBox	0522
Electrosonic	0037	Radio Shack	0000, 1037	Daewoo	0784, 0705, 0833, 0869, 1918	Yamaha	0490, 0545, 0539
Emerex	0032	Radix	0037	Denon	0490, 0634	Zenith	0591, 0503, 0869
Emerson	0037, 0184, 000, 0121, 0043, 0209, 0002, 0278, 0061, 0208, 0212, 0479, 0561, 1593	Randex	0037	Dual	1068, 1085		
Fisher	0104, 0047, 0066	Realistic	0035, 0037, 0048, 0047, 0000, 0104, 0046, 0062, 0066	Emerson	0591, 0675	CABLE BRAND	CODE
Fuji	0033, 0035	ReplayTV	0614, 0616	Enterprise	0591	ABC	0003, 0008, 0011, 0013, 0014, 0017
Funai	0000, 1593	Runcos	0039	Fisher	0670	Allegro	0153, 0315
GE	0035, 0060, 0240, 0202, 0761	STS	0042	Funai	0675	Americast	0899
Garrard	0000	Samsung	0045, 0240, 0432	GE	0522, 0717, 0815	Antronix	022
Gateway	1972	Sanky	0039, 0048	GPX	0699, 0769	Archer	022, 0153, 0797
Go Video	0432, 0526	Sansui	0000, 0067, 0209, 0041, 0479, 1479, 0271	Gateway	1073	Bell & Howell	0014
GoldStar	0037, 0038	Sanyo	0047, 0240, 0104, 0046	Go Video	0744, 0715, 0783, 0833, 0869, 1075	Bell South	0899
Gradiente	0000, 0008	Scott	0184, 0045, 0121, 0043, 0210, 0212	Gradiente	0651	Cabletenna	0022
HI-Q	0047	Sears	0035, 0037, 0047, 0000, 0042, 0104, 1237, 0046, 0066, 0105	Greenhill	0717	Cableview	0022
HP	1972	Semp	0045	Grundig	0705	Century	0153
Harley Davidson	0000	Sharp	0048, 0848, 0062	Harman/Kardon	0702	Citizen	0153, 0315
Harman/Kardon	0038, 0081	Shintom	0072	Hitachi	0573, 0664, 0695	ClearMax	0883
Harwood	0072	Shogun	0240	Hiteker	0672	Clearmaster	0883
Headquarter	0046	Singer	0072	IRT	0783	Colour Voice	0025, 0031
Hewlett Packard	1972	Sonic Blue	0614, 0616	Initial	0717	Comtronics	0040
Hitachi	0000, 0041, 0042, 0105	Sony	0035, 0032, 0000, 0033, 0636, 1032, 1972	Integra	0627	Contec	0019
Howard Computers	1972	Sylvania	0035, 0081, 0000, 0043, 0593, 1593	Hiteker	0672	Coolmax	0883
Hughes Network Systems	0042	Symphonic	0000, 0593, 1593	JBL	0702	Digi	0637
iBuy Power	1972	Systemax	1972	JVC	0623, 0558, 0867, 1901	Director	0476
JVC	0067, 0041, 0008	TMK	0240, 0208	KLH	0717, 0790, 1020	Dumont	0637
Jensen	0041	Tagar Systems	1972	Kawasaki	0790	Emerson	0797
KEC	0037, 0278	Tatung	0041	Kenwood	0490, 0534	Everquest	0015, 0040
KLH	0072	Teac	0000, 0041	Koss	0651	Focus	0400
Kenwood	0041, 0067, 0038	Technics	0035, 0162	Lasonic	0798	Garrard	0153
Kodak	0035, 0037	Teknika	0000, 0035, 0037	Lite-On	1058	Gemini	0015, 0797
LG	0037	Thomas	0000	Magnavox	0503, 0675, 1914, 1976	General Instrument	0003, 0011, 0476, 0276, 0810
LXI	0037	Tivo	0618, 0636, 1503	Marantz	0539	GoldStar	0040, 0144
Lloyd's	0000, 0208	Toshiba	0045, 0043, 0066, 0210, 0212, 0366, 0845, 1008, 1145, 1503, 1972	Memorex	0695	Goodmind	0797
Logik	0072			Microsoft	0522	Hamlin	0009, 0020, 0034, 0273
Logitech	0035			Mintek	0717, 0839	Hitachi	0011
MGA	0043, 0240, 0061			Mitsubishi	0521, 1521	Jasco	0015, 0153, 0315
MGN Technology	0240			Nesa	0717	Jerrold	0003, 0011, 0012, 0014, 0015, 0024, 0276, 0476, 0810
MTC	0000, 0240			Norcent	1003, 0872	Memorex	0000
Magnasonic	0593			Onkyo	0627, 0503	Motorola	0276, 0476, 0810, 1106, 1254, 1376
Magnavox	0035, 0081, 0563, 0000, 0039, 0593			Oritron	0651	Movie Time	0063
Magnin	0240			Panasonic	0490	Multivision	0012
Marantz	0081, 0035			Philco	0790		
Marta	0037						

PVR/VCR, CABLE, SATELLITE, DVD AND AUDIO CODES FOR REMOTE CONTROL



NSC	0063	GOI	0775	Soundesign	0078, 0211	Wards	0014, 0080, 0158, 0189
Novaplex	0618	General Instrument	0869, 0547, 0554	Technics	0308, 0521	Yamaha	0176, 0186, 1176
Oak	0019	Gradiente	0856	Toshiba	0353	Yorx	0195
Optimus	0021	HTS	0775	Victor	0331	Zenith	0857
Pace	0237, 1877	Hitachi	0819	Wards	0013, 0078, 0211		
Panasonic	0000, 0021, 0107	homecable	0238	Yamaha	0354, 0133		
Panther	0637	Hughes Network Systems	1142, 0749, 1749, 1442, 1443, 1444				
Paragon	0000	Hytek	0095	RECEIVER BRAND (Amplifier) CODE			
Philips	0305, 0317	IQ	0210	ADC	0531		
Pioneer	0023, 0025, 0031, 0153, 0144, 0533, 0877, 1877	IQ Prism	0210	Aiwa	1405, 0121, 0158, 0189, 0405		
Popular Mechanics	0400	Innova	0099	Anam	1074, 1609		
Pulsar	0000	Intersat	0043	Arcam	1120		
Quasar	0000	JVC	0775, 1170	Audiotronic	1189		
RCA	0021	Janeil	0152	Bose	0639, 1229, 1253		
RadioShack	0015, 0315, 0797, 0883	Legend	0269	Capetronic	0531		
Recoton	0400	Macom	0018, 0061	Carver	1189, 0042, 0189		
Regal	0020, 0273, 0279	Magnavox	0724, 0722	Casio	0195		
Rembrandt	0011	Memorex	0724, 0269	Clarinet	0195		
Runco	0000	Mitsubishi	0749	Coby	1263		
SL Marx	0040	Motorola	0869	Compaq	1136		
Samsung	0040, 0144	Netsat	0099	Curtis Mathes	0080		
Scientific Atlanta	0877, 0008, 0017, 0477, 1877	Next Level	0869	Dell	1383		
Signal	0015, 0040	Norsat	0004	Denon	0004, 1360		
Signature	0011	Pace	0455	Fisher	0042		
Sony	1006	Panasonic	0247, 0701, 0152	Garrard	0463		
Sprucer	0021	Paysat	0724	Glory Horse	1263		
Starcom	0003, 0015	Philips	1142, 0749, 0724, 1076, 0722, 1749, 0856, 0099	Harman/Kardon	0891, 0110, 0189		
Stargate	0015, 0040, 0797	Pico	0075	Hewlett Packard	1181		
Starquest	0015	Proscan	0392, 0566	Hitachi	0228		
Supercable	0276	RCA	0392, 0566, 0855, 0143	Integra	0135		
Supermax	0883	Radioshack	0869, 0554	JBL	0110		
TFC	0310	Ramsey	0075	JVC	0074, 1263		
TV86	0063	Realistic	0052	KLH	1428		
Tandy	0258	SKY	0856, 1856, 0099	Kenwood	1313, 1570, 1569, 0027, 0042, 0186, 0239		
TeleCaption	0221	STS	0041, 0210	LXI	0181		
Televue	0040	Samsung	1276, 1109	Linn	0189		
Timeless	0040	Sony	0639, 1639	Lloyd's	0195		
Tocom	0012, 0013	Star Choice	0869	MCS	0039		
Torx	0003	Star Trak	0180, 0421, 0547	Magnavox	1189, 1269, 0189, 0195, 0391, 0531		
Toshiba	0000	Strong	0421	Marantz	1189, 0039, 0189, 1269		
Tristar	0883	Tivo	1142, 1442, 1443, 1444	Mitsubishi	1393		
Tusa	0015	Toshiba	0749, 1749, 0790, 0061, 0082, 1052, 1053, 1054, 1285, 1286, 1287, 1289	Modulaire	0195		
Unika	0022, 0153	Town & Country	0547	Musicmagic	1089		
Universal	0022, 0153, 0191	Uniden	0724, 0722, 0052, 0074, 0076, 0238, 0370, 0554	Nakamichi	0097		
V2	0883	Zenith	0856, 1856, 0061, 0064	Onkyo	0135, 0842		
ViewMaster	0883			Optimus	1023, 0042, 0080, 0177, 0181, 0186, 0219, 0531, 0670, 0738, 0801, 1074		
Viewstar	0063, 0258			Panasonic	1518, 0039, 0309, 0367		
Vision	0883			Penney	0195		
Vortex View	0883			Philips	1189, 1269, 0189, 0391, 1120		
Zenith	0000, 0054, 0525, 0899			Pioneer	1023, 0014, 0080, 0150, 0244, 0531, 0630		
Zentek	0400			Polk Audio	0189		
				Proscan	1254		
				Quasar	0039		
				RCA	1023, 1254, 0080, 0531, 1074, 1609		
				Radio Shack	1263		
				Realistic	0181, 0195		
				Rio	1383		
				Sansui	0189		
				Sanyo	0801, 1251		
				Scott	0163, 0322		
				Sharp	0186		
				Sharper Image	1263		
				Sherwood	0491, 0502		
				Sonic Blue	1383		
				Sony	1058, 1441, 1759, 0158, 0474, 1349, 1406, 1442		
				Soundesign	0670		
				Stereophonics	1023		
				Sunfire	1313		
				Teac	0463, 1074		
				Technics	1308, 1518, 0039, 0309		
				Thorens	1189		
				Toshiba	1572		
				Victor	0074		

THE REMOTE CONTROL

OSD (On-Screen Display)

1. Press MENU on the remote control to display the different features on your HITACHI LCD TV.
2. Use the CURSOR PAD to navigate to a different menu item.
3. Press EXIT on the remote control to quickly exit from a menu.
4. Press the A/V NET button on the remote control to access the AV Network menu to control external components.

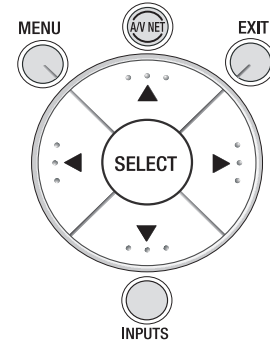

This part of the screen shows which selections are available.

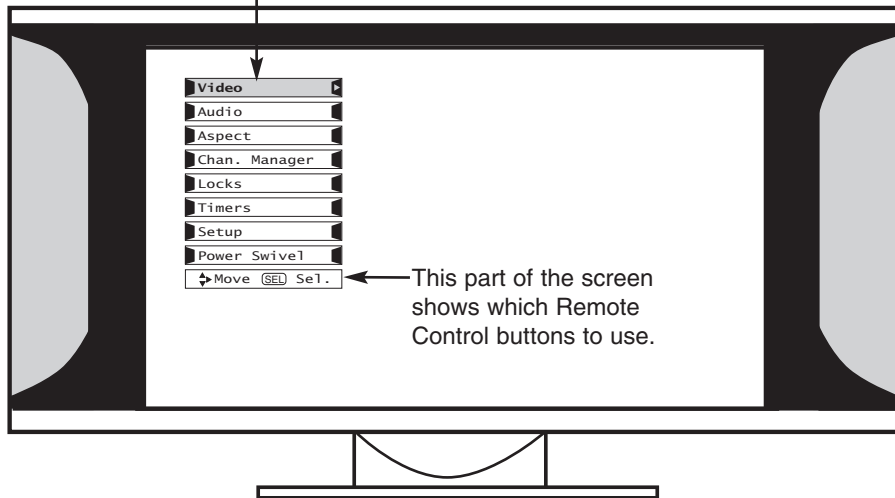

OSD (On-Screen Display)

Video	Picture Mode	Select between the two picture modes; Day and Night.
	Contrast	Adjust contrast.
	Brightness	Adjust brightness.
	Color	Adjust color.
	Tint	Adjust tint.
	Sharpness	Adjust sharpness.
	Color Temperature	Set this to High for less intense color with more blue, set to Medium for natural color, set to Standard for standard colors or Black and White for more reddish color.
	Black Enhancement	Adjust shadow detail in dark screens.
	Contrast Mode	Adjust Contrast automatically.
	Back Light	Adjust the Back Light.
	Reset Video Settings	Choose the Reset Video settings.
	Color Management	Adjust and balance individual colors to make either deeper or more pure according to preference.
	Color Decoding	Adjust the percentage of Red, Green and Color according to preference.
	Auto Color	The AUTO COLOR function automatically monitors and adjusts the color to maintain constant color levels even after a program or channel changes. It also maintains natural flesh tones while preserving fidelity of background colors.
Noise Reduction	Reduces conspicuous noise in the picture.	
Auto Movie Mode	Turn ON/OFF the 3:2 Pulldown detection feature.	
Audio	Treble	Adjust the treble.
	Bass	Adjust the bass.
	Balance	Adjust the balance.
	Dynamic Bass	Select settings (Off, Low, Medium, High).
	Matrix Surround	Select Matrix Surround (On, Off).
	Audio Source	Select between three Audio Sources.
	Internal Speakers	Select internal or external speakers.
	Auto Noise Cancel	Eliminates the noise between stations.
	Perfect Volume	Adjust volume in fixed setting.
	Language	Select Language options if available.
	Digital Output	Select Optical Output options.
DRC	Select Dynamic Range Compression to ON or OFF.	
Aspect	4:3 Standard	Choose the picture format aspect ratio.
	4:3 Expanded	
	4:3 Zoom 1	
	4:3 Zoom 2	
	16:9 Standard	
	16:9 Zoom	

NOTE: The Language, Digital Output, and the Dynamic Range Compression feature of the Audio OSD are only available for Digital channels.

Channel Manager	Set the Antenna	Set Antenna settings.
	Auto Channel Scan	Set Auto Channel Scan.
	Signal Meter	Access Signal Meter.
	Channel List	Set Channel List.
Locks	Change Access Code	Change Lock access code.
	Engage Lock	Choose to lock channel, video input, and/or front panel.
	Movie Ratings	Block various types of movies and video types based on motion picture ratings.
	TV Ratings	Block various types of movies and television programming based on a parental guide ratings.
	Canadian Ratings (ENG)	Block various types of movies and television programming based on the Canadian ratings system.
Locks	Canadian Ratings (FRN)	Block various types of movies and television programming based on the Canadian French ratings system.
	Timers	
Timers	Set the Clock	Set Clock Settings.
	Set Sleep Timer	Set Sleep Timer intervals (30 min. intervals, 00:30-3:00).
	Set Day/Night Timer	Set Day/Night picture mode settings.
	Set Event Timer	Set viewing reservation for TV programs.
	Set Timer Recording	Set Timer Recording for IEEE 1394 devices.
Setup	Menu Preference	Choose English, French, or Spanish text.
	Screen Saver	Set Screen Saver to prevent screen burn.
	Set The Inputs	Label Video Inputs , VCR, DVD, etc.
	Set Black Side Panel	Set the gray side bars on/off when watching 4:3 signals in standard mode.
	Set Closed Captions	Feature to display dialogue/text.
	Set Monitor Out	Set Monitor Out source.
	CableCARD Info	Select to access CableCARD information.
	Set AV Control	Select to set RS232C feature.
	Upgrades	Select to upgrade TV software.
	Set Stand-By Mode	Set the IEEE 1394 function in stand by.
Power Swivel	Unlocked	Power Swivel enabled. Control the motorized stand.
	Locked	Power Swivel disabled.

- NOTES:**
1. The Signal Meter feature of the Channel Manager OSD is only available for Digital signals.
 2. The CableCARD information feature of the Setup OSD is only available when a CableCARD from your cable operator is installed in the rear panel of the Audio Video Control Center (AVC).

VIDEO

Video

Select VIDEO to adjust picture settings and improve picture quality. You can independently customize each of the Video Inputs to your preference to increase viewing performance and pleasure depending upon the video program being viewed. If RESET is selected, only the selected input will reset to initial conditions.

Picture Mode

Use this function to choose from automatic picture settings to optimize your TV's performance.

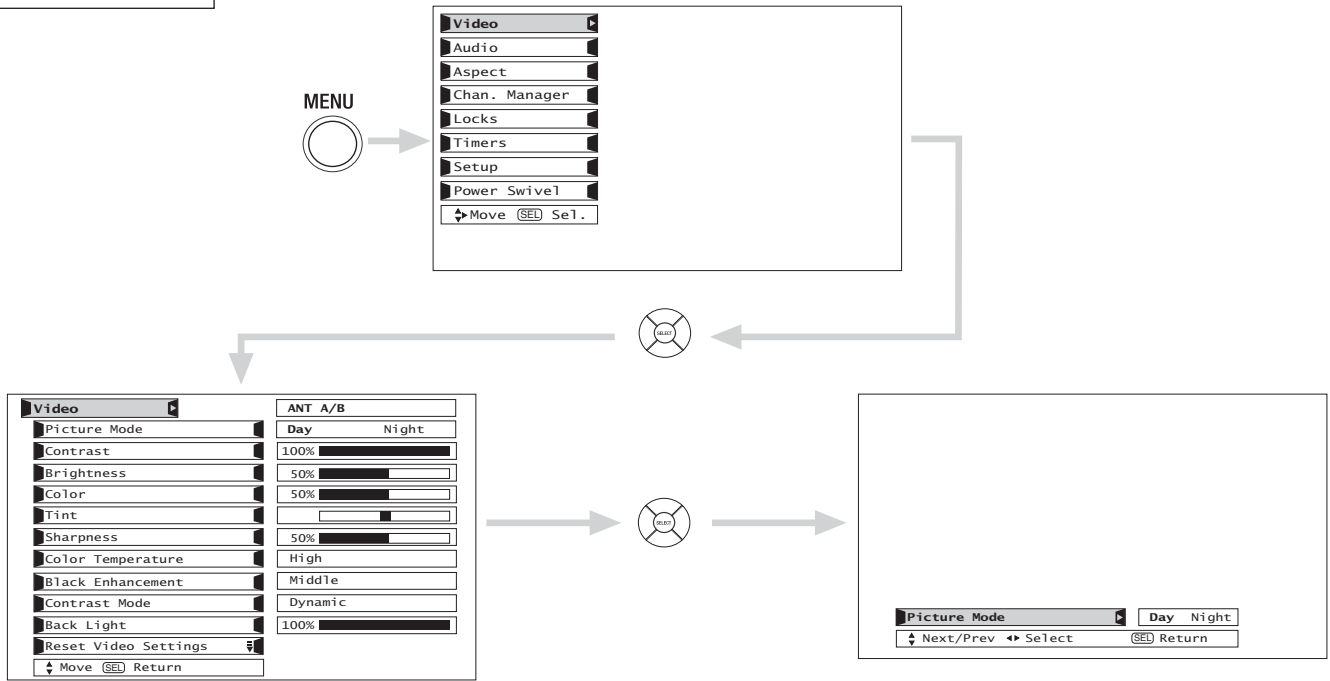

Use CURSOR PAD ◀ or ▶ to highlight and select Picture Mode settings.

Function	Day	Night	Reset
Contrast	100%	91%	Reset the video menu settings on current input to the Day or Night conditions depending on the selected VIDEO mode.
Brightness	50%	53%	
Color	50%	25%	
Tint	50%	50%	
Sharpness	50%	40%	
Color Temperature	High	Standard	
Black Enhancement	Low	Off	
Contrast Mode	Dynamic	Normal	
Back Light	100%	50%	
Auto Color	Off	Off	
Noise Reduction	Low	Off	
Color Management (Set User Colors)	Off	Off	
Auto Movie Mode (TV/Cinema Detection)	Off	On	

Press EXIT to quit menu or select PICTURE MODE to return to previous menu.

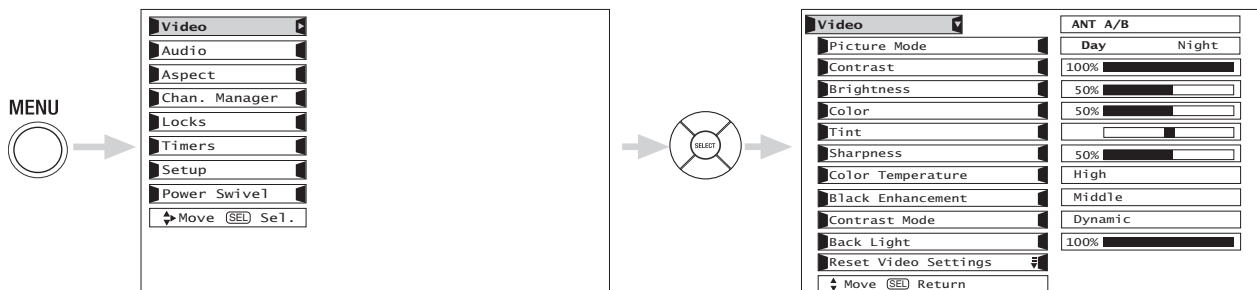

Use the CURSOR PAD ▲ or ▼ to highlight the function to be adjusted.
 Press down on CURSOR PAD to select the function settings.
 Press the CURSOR PAD ◀ or ▶ to adjust the function.
 Press MENU to return to main menu.
 Press EXIT to quit menu.

- Contrast** Use this function to change the contrast between black and white levels in the picture.
- Brightness** Use this function to adjust overall picture brightness.
- Color** Use this function to adjust the level of color in the picture.
- Tint** Use this function to adjust flesh tones so they appear natural.
- Sharpness** Use this function to adjust the amount of fine detail in the picture.
- Color Temperature** Set this to High for cooler color with more blue, set to Medium for more natural color, set to Standard for accurate color or set to Black/White for more reddish color.
- Black Enhancement** Use this function to enhance the shadow detail in dark scenes using the settings off, low, middle and high.

NOTES: 1. If CONTRAST is selected, you are adjusting CONTRAST. The additional menu items BRIGHTNESS, COLOR, TINT, and SHARPNESS can be selected and adjusted in the same manner.
 2. It may be necessary to adjust TINT to obtain optimum picture quality when using the COMPONENT VIDEO Y-P_BP_R input jacks.

- Contrast Mode** Use this function to choose between 3 Contrast Mode settings. Set to Dynamic for darker images more in the level of Black, set to Normal for a balanced White to Black level, and set to Auto for automatic Contrast selection.
- Back Light** Use this function to adjust the amount of Back Light.

VIDEO

Reset Video Settings

This function allows you to Reset the Video Menu Settings of the present input and return it to the Day VIDEO mode.

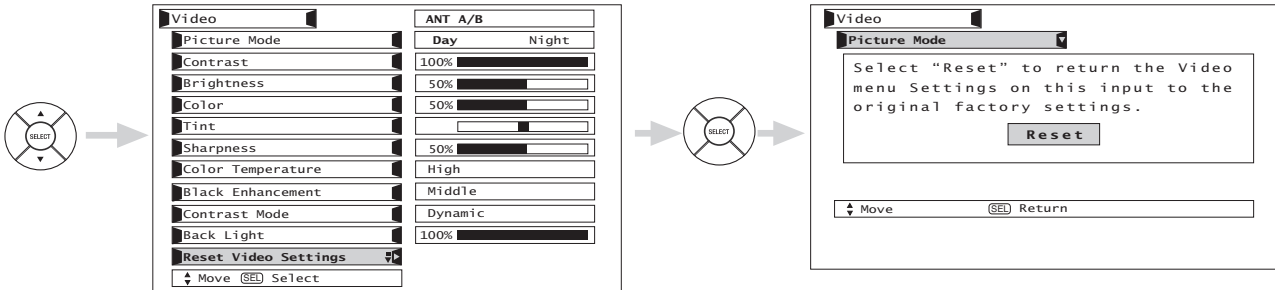

Use CURSOR PAD to highlight functions.
Press the SELECT button to select Reset Video Settings.

Use the CURSOR PAD ▼ to access other video settings.

You can customize each of the Video Inputs to your preference to increase viewing performance and pleasure, depending upon the video program being viewed. If RESET is selected, only the selected Input will reset to the initial conditions as explained above.

If RESET is selected in Video:1 Input, only Video:1 Input will return to factory conditions.

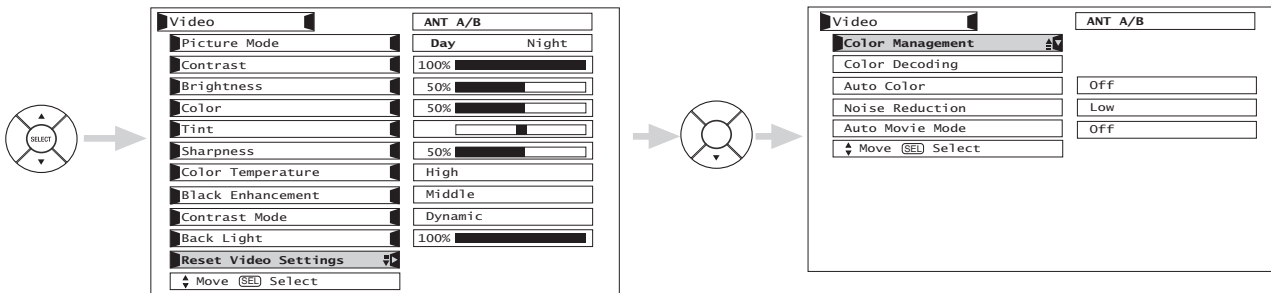

Color Management

Use this function to adjust and balance the listed individual colors to make them either deeper or more pure depending on the user's preference. Adjust the GAIN settings to make the color brighter (+) or darker (-). Adjust the PHASE settings to make the colors deeper (+) or normal (-) to match real life colors.

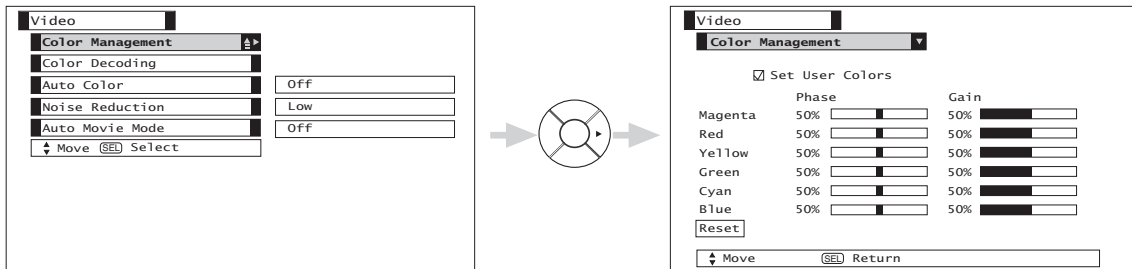

Use the CURSOR PAD to highlight function.
Press the SELECT button to select User Colors setting. When the function has a "✓" in the box, it is ON.
Press the CURSOR PAD ◀, ▶, ▼, ▲, to highlight and adjust individual colors.
Use the CURSOR PAD to highlight and select "Reset" to return all colors to default settings.

NOTE: When the Set User Colors box is not checked, the listed colors will be grayed out.

Color Decoding

Use this function to adjust and balance the percentage of Red, Green and Blue according to the user's preference in each of the four color temperature settings. Use TINT to adjust flesh tones so they appear natural.

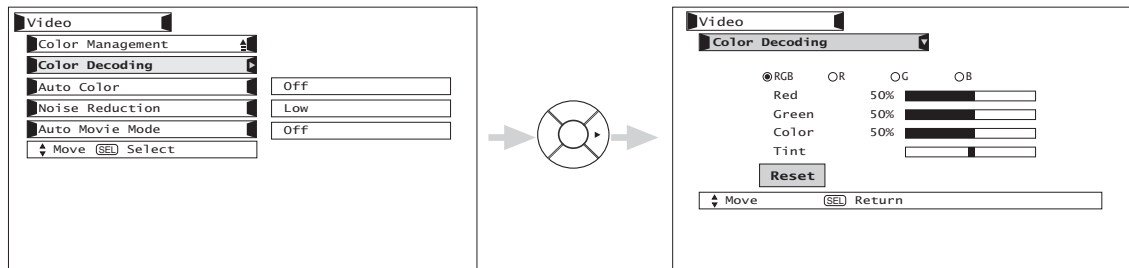

Use CURSOR PAD to highlight function.
 Press down to select from 4 menu items.
 Press CURSOR PAD ◀, ▶, ▼, ▲, to highlight and adjust Red, Green, Color and Tint.
 Use CURSOR PAD to highlight and select "Reset" to return all settings to default.

NOTE: Color Decoding settings are independently stored in each of the 4 Color Temperature settings.

Auto Color

The AUTO COLOR function automatically monitors and adjusts the color to maintain constant color levels even after a program or channel changes. It also maintains natural flesh tones while preserving fidelity of background colors.

NOTE: When using Component or DVI-HDTV input, Auto Color will not be available (grayed out).

Noise Reduction

The NOISE REDUCTION function automatically reduces conspicuous noise in the picture without degrading picture quality. Set NOISE REDUCTION to OFF if the TV experiences picture blocking.

Auto Movie Mode

The Auto Movie Mode function turns ON or OFF the 3:2 PULLDOWN DETECTION SPECIAL FEATURE. Theatrical movies are shot on film at 24 frames or still pictures per second, instead of 30 frames or 60 fields like video. When film is transferred to video for television viewing, the disparity between the two frame rates must be reconciled. This involves a process known as 3:2 pulldown.

When Auto Movie Mode is turned ON from the VIDEO menu, your Hitachi LCD Television will activate the circuitry for this special feature to improve video performance when watching film based sources.

NOTES: 1. When using Progressive Scan Component or HDMI OR DVI input (Ex. 480p, 720p), Auto Movie Mode will not be available (grayed out). Please see table below for additional information.

	ANT A/B, VIDEO, 480i	480p/720p/1080i
32"	AVAILABLE	GRAYED OUT

2. All Video settings are independent of each other based on it's input (ANT A/B, Input 1~5, Photo Input).

AUDIO

Audio

Select AUDIO to adjust the TV to your preference and to improve the sound quality.

MENU

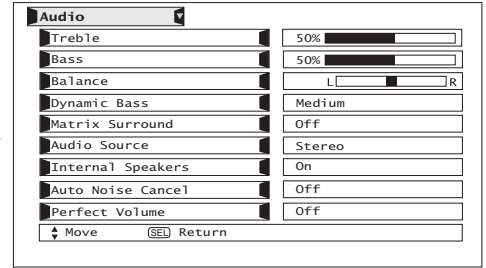
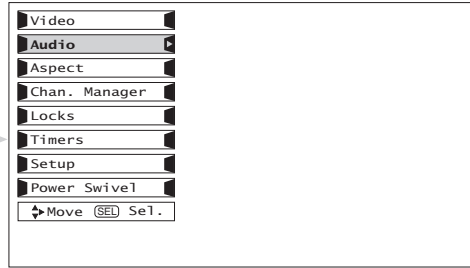

Press CURSOR PAD ▲, ▼, to select menu item.
 Press CURSOR PAD ◀ or ▶ to adjust the function.
 Press EXIT to quit the MENU, or select Audio to return to the main menu.

NOTE: If TREBLE is selected you are adjusting treble. The additional menu items Bass and Balance can be selected and adjusted in the same manner.

Treble

This function controls the high frequency audio to all speakers.

Bass

This function controls the low frequency audio to all speakers.

Balance

This function will control the left to right balance of the LCD TV internal speakers.

Dynamic Bass

This function complements and enhances bass performance.

Matrix Surround

The Matrix Surround features the spacious sound effects of a stadium that can be turned ON or OFF.

Audio Source

Multi-Channel Television Sound will allow you to select STEREO (a stereo broadcast), MONO (monaural sound) used when receiving a weak stereo broadcast or 2nd Audio Prog (SAP) which may be a secondary language, weather report, etc. The sources received will be displayed at the top right edge of the TV. The source you select will be displayed above the sources received. See example below for each selection when both stereo and second audio are received (monaural is always received).

STEREO SELECTED

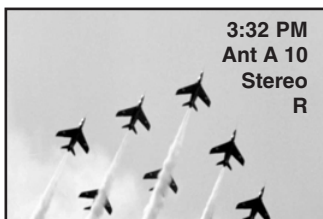

SAP SELECTED

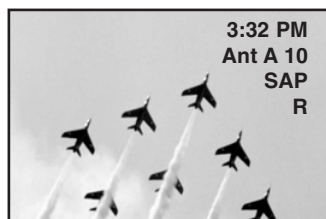

MONO SELECTED

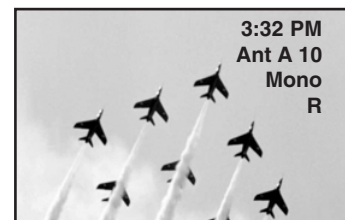

Internal Speakers

This function is useful when setting up the external speakers. If you prefer to use only speakers from a separate stereo system, turn this feature OFF. When set to OFF, the LCD TV speakers and the sub-woofer output are OFF. Also, set to OFF, if you prefer to use only your head-phones.

Auto Noise Cancel

This function eliminates the noise between stations. If a channel is tuned and is noisy, this function will automatically eliminate the audio for that channel.

Perfect Volume

This function will automatically adjust volume so each channel and input has the same average volume level.

ON-SCREEN DISPLAY

Use the functions below if your TV is connected to an amplifier/receiver with optical digital input with Dolby Digital or PCM decoder capabilities.

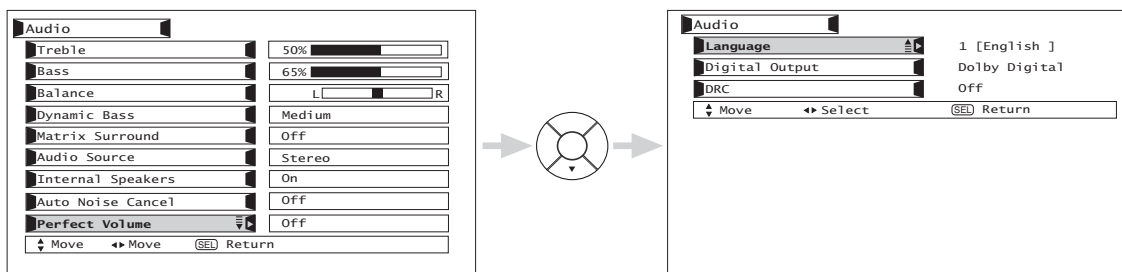

Language

Some programs transmit more than one DTV language option. Most will have English as a default language. The language function will allow you to select up to 4 language options (if available).

Digital Output

This function allows you to select between Dolby® Digital and PCM.

Dolby® Digital - Select this feature if the TV is connected to an amplifier/receiver with a Dolby® Digital only decoder; it will provide six independent soundtrack channels through the optical output jack (Digital Audio).

PCM - Select this feature if the TV is connected to an amplifier/receiver with a PCM only decoder; it will provide two independent soundtrack channels through the optical output jack (Digital Audio).

*Manufactured under license from Dolby Laboratories. “Dolby” and the double-D symbol are trademarks of Dolby Laboratories.

DRC

Dynamic Range Compression - Use this function to compress the range of sound volume. By compressing the range of sound volume, it is possible not only to suppress the output of loud sound at night but also to raise the volume of low sound. This is only effective when the TV is connected via the optical out (digital audio) to an amplifier/receiver with a Dolby® Digital decoder. The default setting is ON.

Use the CURSOR PAD ◀, ▶ to select the chosen options.

NOTE: These functions are only available when viewing digital programs.

ASPECT

Aspect

Use this function to select the Picture Format Aspect Ratio.

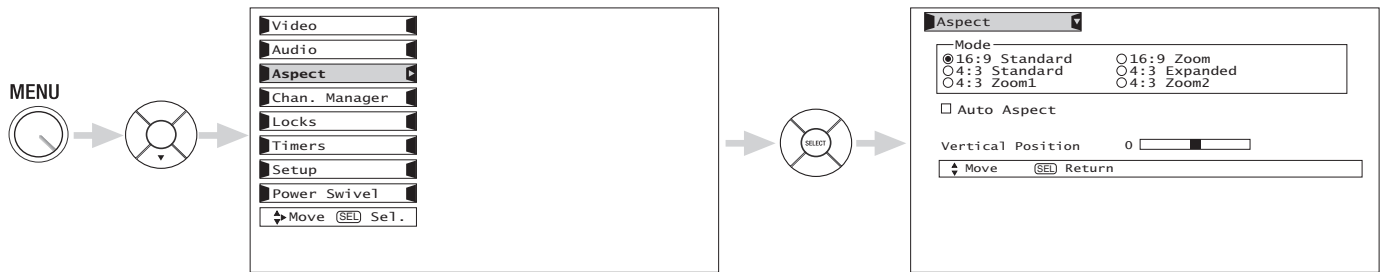

Auto Aspect

Automatically adjust the Aspect Ratio depending on the input signal to fill the screen.

Press CURSOR PAD ▲, ▼, to select menu item.

Press the Select button to select. A “√” in the box indicates that the feature is ON.

- NOTES:**
1. The Auto Aspect function is recommended on an input signal with VIDEO ID.
 2. The Auto Aspect function is best used on composite video, S-Video, and 480i component signals.
 3. See page 29 for Aspect Mode availability.

Vertical Position

This function allows you to select when aspect style is either 4:3 EXPANDED/ZOOM1/ZOOM2 or 16:9 ZOOM. Vertical position can be changed with these modes. For example, it will be useful for centering the picture area at both the top and bottom of the picture with 480i/480P signal. Adjustable range is -10 (video center is toward bottom of screen) to +10 (video center is toward top of screen).

Press CURSOR PAD ▲, ▼, to select menu item.

Press CURSOR PAD ◀ or ▶ to adjust the function.

Press EXIT to quit the MENU, or select Aspect to return to the main menu.

NOTE: Vertical Position will not be available in 4:3 Standard and 16:9 Standard modes.

Chan. Manager

Select Channel Manager to set your Antenna options, run Auto Channel Scan, Check Signal Meter and Set Channel List.

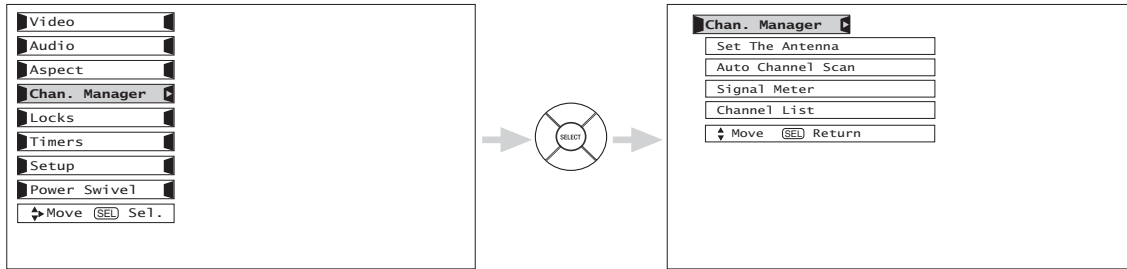

Press CURSOR PAD ▲, ▼ to highlight function, the press the SELECT button to select.

Set The Antenna

This feature will select Antenna options.

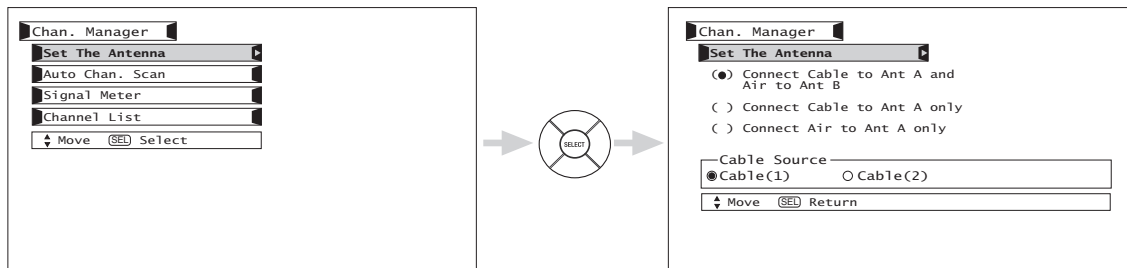

Press CURSOR PAD ▲, ▼ to highlight function, the press the SELECT button to select.

NOTE: When a CableCARD is installed, antenna settings will be set automatically to “Connect Cable to Ant A only”.

Auto Channel Scan

This feature will automatically store active Analog and Digital channels in Auto Channel Scan memory.

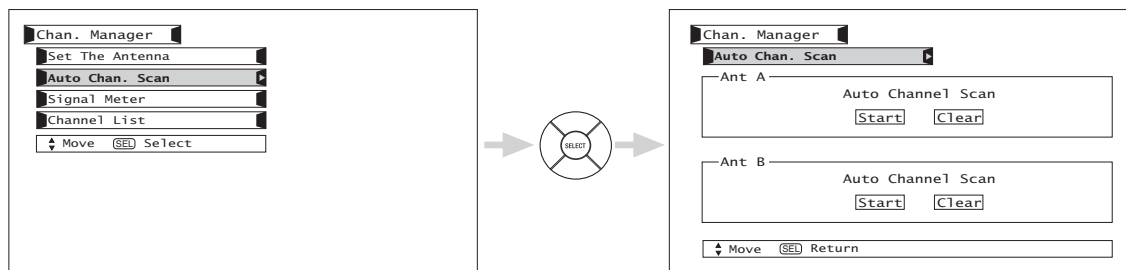

Press CURSOR PAD ▲, ▼, ◀, ▶ to highlight Ant A or Ant B.
Press CURSOR PAD ◀, ▶ to highlight the Start or Clear option.
Press the SELECT button to start Auto Channel Scan.

NOTE: When a CableCARD is installed, Auto Channel Scan will not be available since channels will be fixed based on what was agreed upon by you and your cable operator.

CHANNEL MANAGER

Signal Meter

Select Signal Meter when using an indoor or outdoor antenna. This feature will show the signal strength and peak values of the Antenna signal to help you adjust your antenna to optimize signal reception.

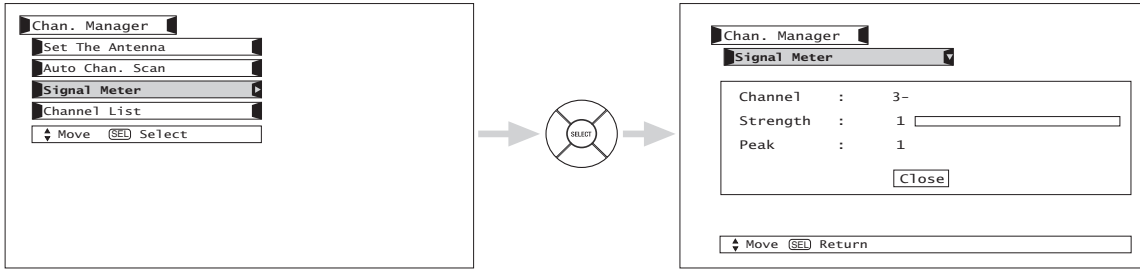

Use the CURSOR PAD and the SELECT button to highlight and select “close” to exit.

NOTE: The Signal Meter will not be available (grayed out) when watching analog channels.

Channel List

This function allows you to review which channels are labeled (CH ID), which have been added to Channel Memory (SCAN), which are protected by LOCK and which are your Favorite (FAV) Channels.

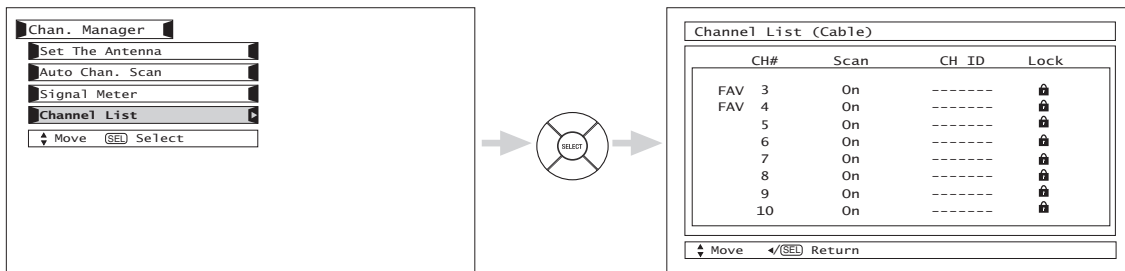

Use the CURSOR PAD to navigate the Channel List.
Press the CURSOR PAD (▲, ▼) to select On or Off on the Scan column.
Press the EXIT button to return to normal viewing.

NOTE: When a CableCARD is installed, the Channel List will be dependent on channels agreed upon by you and your cable operator.

Locks

This function will block out the picture and sound of the selected channel or video input. It can also be used to keep the TV from being viewed for a scheduled time period that you set.

The code to enter the Locks feature is a four digit access code number. The factory preset code is 0000. Use the number buttons to enter the access code.

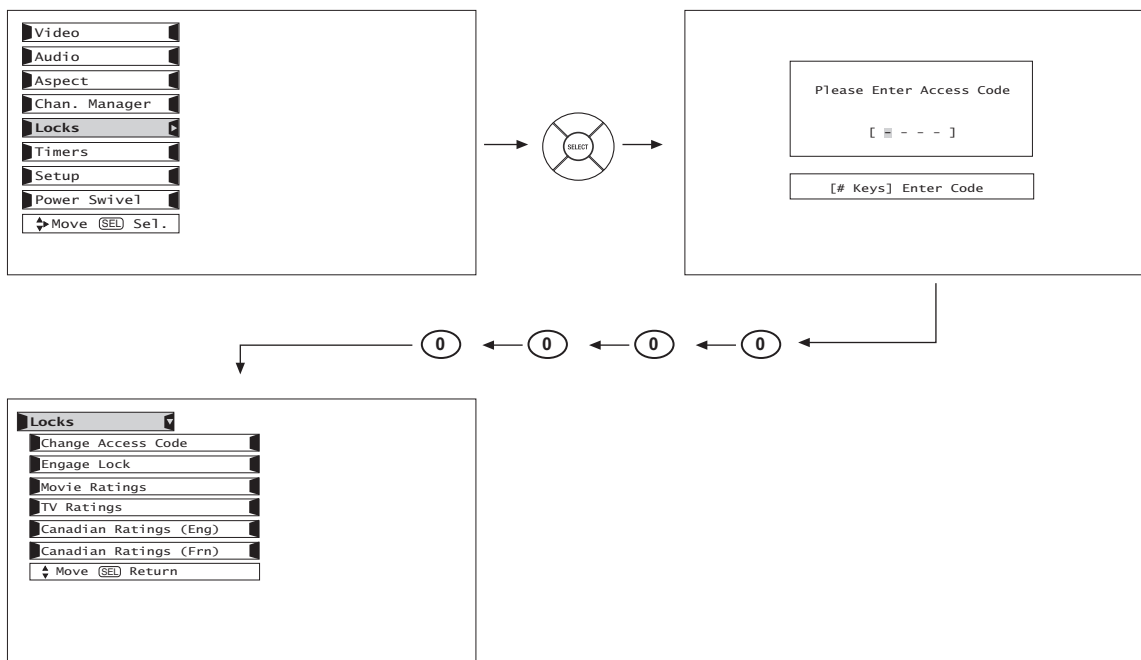

Use the CURSOR PAD ▲ or ▼ to highlight function and then press the SELECT button. To change the access code number, select Change Access Code. Enter a new four digit number.

Select CHANGE ACCESS CODE to change the factory preset code (0000) to your preference.

When ENGAGE LOCK is selected, SET CHANNEL LOCK, SET INPUT LOCK, and SET FRONT PANEL LOCK can be set individually.

When SET CHANNEL LOCK is turned on, the picture and sound for the chosen channel will be blocked out.

When SET INPUT LOCK is turned on, the picture and sound for all video inputs and the picture and sound for channels 3, 4 will be blocked out.

When FRONT PANEL LOCK is turned on, all buttons on the Front Panel will be deactivated, except the Power button.

When MOVIE RATINGS is selected, you can block various types of movies and video tapes based on motion picture ratings. Picture-in-Picture will also be blocked automatically (see page 63).

When TV RATINGS is selected, various types of television programming based on a parental guide ratings will be blocked. Picture-in-Picture will also be blocked automatically (see page 64).

Use CANADIAN RATINGS to block various types of movies and television programs based on the two rating systems used in Canada that you feel may be inappropriate due to its content (see pages 65-66).

If you forget your access code, use the factory code 7777 to erase your key number. This will reset the access code number back to the factory preset 0000.

Press EXIT to quit the menu.

NOTE: If MOVIE/TV Ratings Lock function settings are ON, SURF will be deactivated.

LOCKS

Movie Ratings

Use MOVIE RATINGS to prevent viewing of any movie that you feel may be inappropriate due to its content.

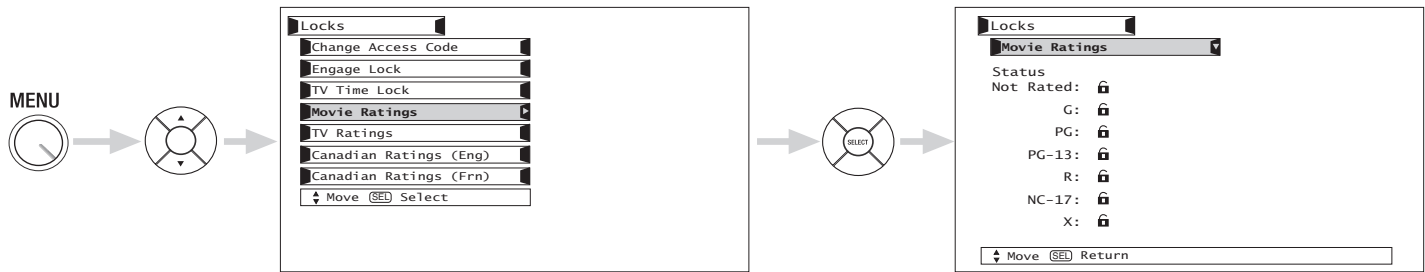

Use the CURSOR PAD ▲ or ▼ to select the MOVIE RATING category that you want to block. Press SELECT to block the MOVIE RATING that you have selected. Once rating is selected, for example PG-13, all movies rated PG-13 and higher (R, NC-17, and X) will be blocked. Press EXIT to quit the menu or select MOVIE RATING to return to the previous menu.

Motion Picture Ratings Chart

G	General audiences. All ages admitted.
PG	Parental guidance suggested. Some material may not be suitable for children.
PG-13	Parents strongly cautioned. Some material may be inappropriate for children under 13.
R	Restricted. Under 17 requires accompanying parent or adult guardian.
NC-17	No one 17 and under admitted.
X	Adults only
NOT RATED (NR)	Contains no rating. Not Rated (NR) and Not Applicable (NA) programs. Movie has not been rated or ratings do not apply.

- NOTES:**
1. A movie rating is dependent upon the movie that is viewed. If the movie does not carry a rating, the TV will not block it.
 2. Blocking "NOT RATED (NR)" programs may block emergency programming, sports, news, public service announcements, religious programs and weather.
 3. If a CableCARD is installed, your cable operator may provide an Emergency Alert System (EAS) message in the event of a local or national emergency with the purpose of alerting the general public. When you receive such messages, the LCD Television will immediately tune to an EAS channel as directed by the EAS message. Please be advised that if the EAS channel is blocked using the Locks feature, you will not be able to tune to that channel.

ON-SCREEN DISPLAY

TV Ratings

Use TV RATINGS to prevent the viewing of any TV program that you feel may be inappropriate due to its content.

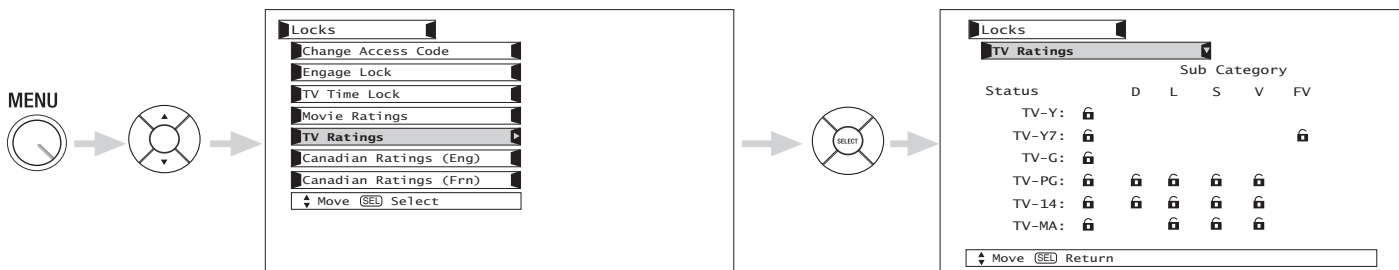

Use the CURSOR PAD ▲ or ▼ to highlight the category that you want to block. Press select to block the TV RATINGS that you have selected. Press EXIT to quit the menu or select TV RATINGS to return to the previous menu.

TV Parental Guide Ratings Chart

N/A	None.
TV-Y	All children. The themes and elements in this program are specifically designed for a very young audience, including children from ages 2-6.
TV-Y7	Directed to older children. Themes and elements in this program may include mild physical or comedic violence, or may frighten children under the age of 7.
TV-G	General audience. It contains little or no violence, no strong language, and little or no sexual dialogue or situations.
TV-PG	Parental guidance suggested. The program may contain infrequent coarse language, limited violence, some suggestive sexual dialogue and situations.
TV-14	Parents strongly cautioned. This program may contain sophisticated themes, intense sexual situation, more intense violence and intensely suggestive dialogue.
TV-MA	Mature audiences only. This program may contain mature themes, indecent language, graphic violence, and explicit sexual content.
FV	Fantasy Violence
V	Violence
S	Sexual Situation
L	Adult Language
D	Sexually Suggestive Dialogue.

NOTES:

1. If you Block TV-14D, you will still permit TV MA programs; If you block TV-14DV, you will automatically block TV-MAV programs, but you will still permit TV-MALS programs. This means that the TV will block violence in TV-14 and higher (TV-MA), but not language and sex.
2. TV program ratings are dependent on the broadcaster. If the program is not rated, the TV will not block it.
3. If a CableCARD is installed, your cable operator may provide an Emergency Alert System (EAS) message in the event of a local or national emergency with the purpose of alerting the general public. When you receive such messages, the LCD Television will immediately tune to an EAS channel as directed by the EAS message. Please be advised that if the EAS channel is blocked using the Locks feature, you will not be able to tune to that channel.

LOCKS

Canadian Ratings (Eng)

Use Canadian Ratings (Eng) to block any type of movie and television program in Canada that you feel might be inappropriate in its content.

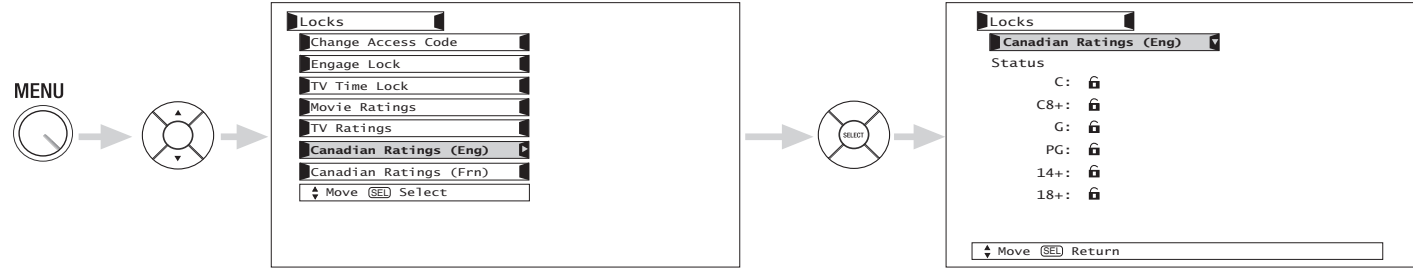

Use the CURSOR PAD ▲ or ▼ to select the CANADIAN RATINGS (Eng) category that you want to block. Press SELECT to set the CANADIAN RATINGS (Eng) that you have selected. Once rating is selected, for example C8+, all movies and television programs rated C8+ and higher (G, PG, 14+ and 18+) will be blocked automatically. Press EXIT to quit menu.

Canadian Ratings English Chart

C	Programming intended for children under age 8 - Violence Guidelines: Careful attention is paid to themes, which could threaten children's sense of security and well-being. There will be no realistic scenes of violence. Depictions of aggressive behaviour will be infrequent and limited to portrayals that are clearly imaginary, comedic or unrealistic in nature. Other Content Guidelines: There will be no offensive language, nudity or sexual content.
C8+	Programming generally considered acceptable for children 8 years and over to watch on their own - Violence Guidelines: Violence will not be portrayed as the preferred, acceptable, or only way to resolve conflict; or encourage children to imitate dangerous acts which they may see on television. Any realistic depictions of violence will be infrequent, discreet, of low intensity and will show the consequences of the acts. Other Content Guidelines: There will be no profanity, nudity or sexual content.
G	General Audience - Violence Guidelines: Will contain very little violence, either physical or verbal or emotional. Will be sensitive to themes which could frighten a younger child, will not depict realistic scenes of violence which minimize or gloss over the effects of violent acts. Other Content Guidelines: There may be some inoffensive slang, no profanity and no nudity.
PG	Parental Guidance - Programming intended for a general audience but which may not be suitable for younger children. Parents may consider some content inappropriate for unsupervised viewing by children ages 8-13. Violence Guidelines: Depictions of conflict and/or aggression will be limited and moderate; may include physical, fantasy, or supernatural violence. Other Content Guidelines: May contain infrequent mild profanity, or mildly suggestive language. Could also contain brief scenes of nudity.
14+	Programming contains themes or content which may not be suitable for viewers under the age of 14 - Parents are strongly cautioned to exercise discretion in permitting viewing by pre-teens and early teens. Violence Guidelines: May contain intense scenes of violence. Could deal with mature themes and societal issues in a realistic fashion. Other Content Guidelines: May contain scenes of nudity and/or sexual activity. There could be frequent use of profanity.
18+	Adult - Violence Guidelines: May contain violence integral to the development of the plot, character or theme, intended for adult audiences. Other Content Guidelines: May contain graphic language and explicit portrayals of nudity and/or sex.

ON-SCREEN DISPLAY

Canadian Ratings (Frn)

Use CANADIAN RATINGS (FRN) to block Canadian French programs according to various program ratings that you feel might be inappropriate in its content.

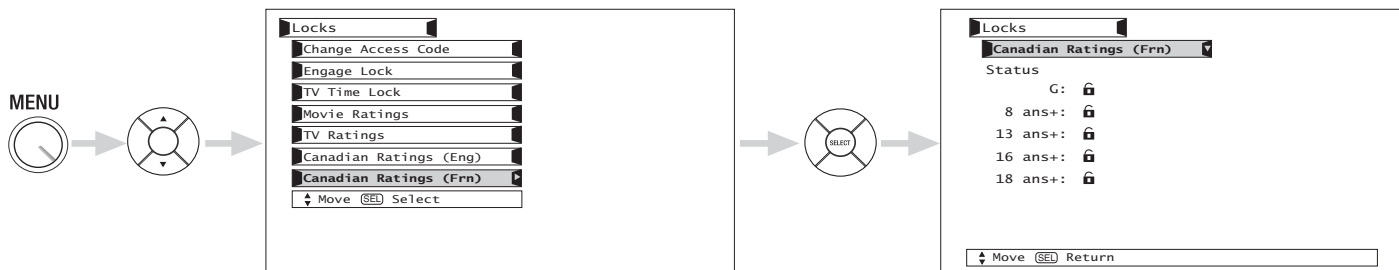

Use the CURSOR PAD ▲ or ▼ to highlight the category that you want to block. Press SELECT to set the CANADIAN RATINGS (FRN) that you have selected. Once rating is selected, for example 8 ans+, all movies and television programs rated 8 ans+ and higher will be automatically blocked. Press EXIT to quit menu or select the CURSOR PAD ◀ to return to the previous menu.

Canadian Ratings French Chart

G	General - Programming intended for audiences of all ages. Contains no violence, or the violence content is minimal or is depicted appropriately with humor or caricature or in an unrealistic manner.
8 ans +	8 + General - Not recommended for young children - Programming intended for a broad audience but contains light or occasional violence that could disturb young children. Viewing with an adult is therefore recommended for young children (under the age of 8) who cannot differentiate between real and imaginary portrayals.
13 ans +	Programming may not be suitable for children under the age of 13 - Contains either a few violent scenes or one or more sufficiently violent scenes to affect them. Viewing with an adult is therefore strongly recommended for children under 13.
16 ans +	Programming is not suitable for children under the age of 16 - Contains frequent scenes of violence or intense violence.
18 ans +	Programming restricted to adults - Contains constant violence or scenes of extreme violence.

TIMERS

Timers

Select Timers to set your Clock, Sleep Timer, Event Timer and Day/Night Timer Recordings.

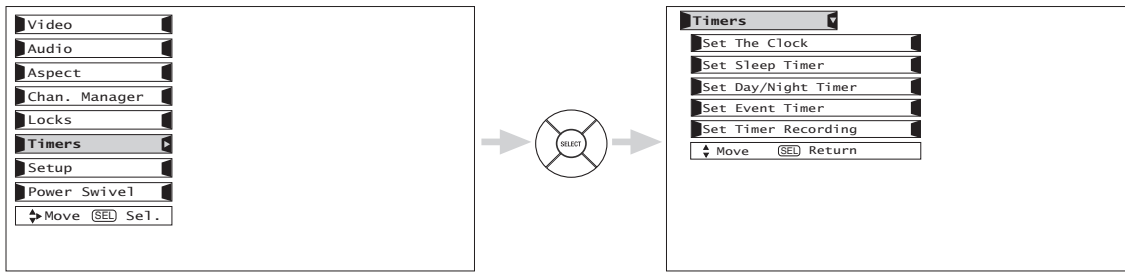

Set The Clock

The Clock must be adjusted before you can use the “Set Event Timer” or Day/Night Timer” feature.

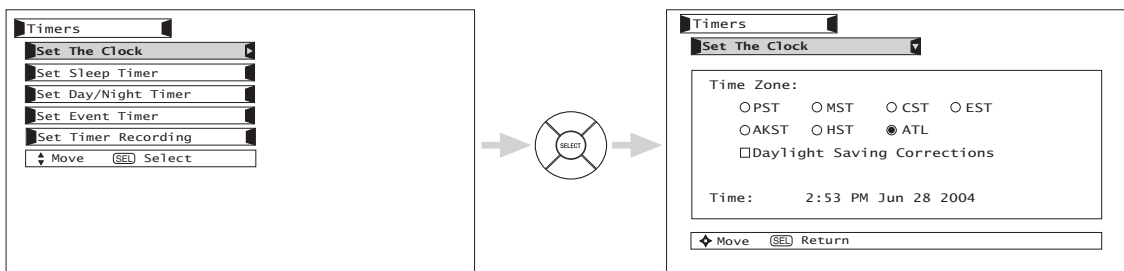

Use the CURSOR PAD ▲, ▼, ◀, ▶ to highlight the chosen Time Zone settings.

Press the SELECT button to select.

If you observe daylight savings, use CURSOR PAD to highlight “Daylight Saving Correction” and press the SELECT button to select.

Use the CURSOR PAD ▲, ▼, ◀, ▶ to highlight the current time (hour and minute), AM or PM, Month, Day, and Year.

Use the CURSOR PAD ▲, ▼ to adjust settings.

Press the SELECT button to set the Time and Date.

Press EXIT to quit the menu.

NOTES: When “Daylight Saving Correction” is checked “✓”, the TV will automatically calculate the clock adjustment for Daylight Saving.

Set Sleep Timer

Select this feature to set your Sleep Timer from 30 minutes to 3 hours (30 minute increments).

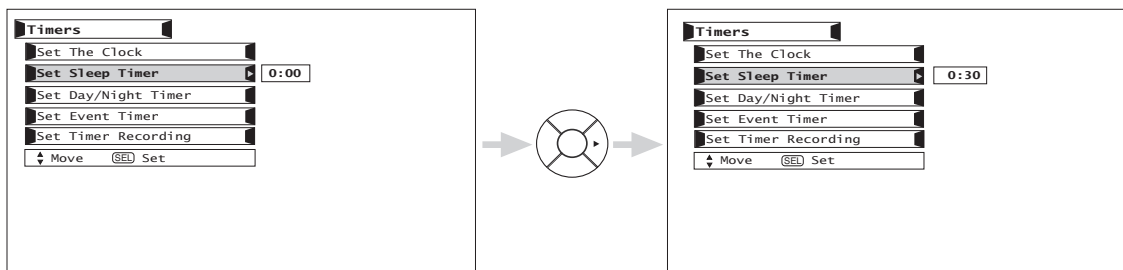

Press the CURSOR PAD ► repeatedly to set your Timer from 0:00, 0:30, 1:00, 1:30, 2:00, 2:30 and 3:00.

Set Day/Night Timer

Select this feature to activate and set your TV's Day/Night Picture Mode automatically.

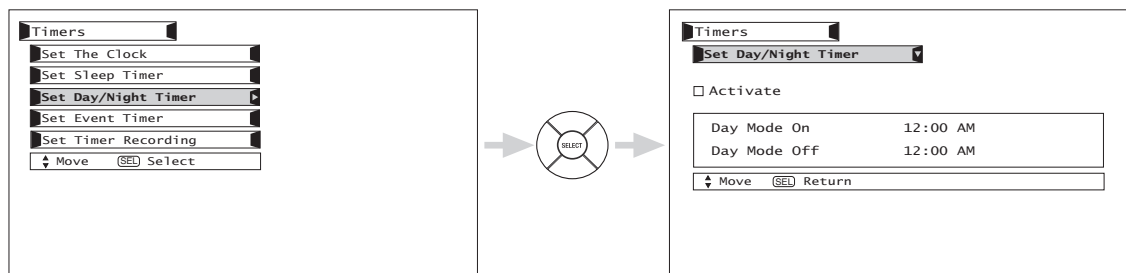

Use the CURSOR PADS and the SELECT button to activate the Day/Night Timer.
 Use the CURSOR PADS to select Day Mode On and to set its timer.
 Use the CURSOR PADS to select Day Mode Off and to set its timer.

TIMERS

Set Event Timer

This function will automatically operate the TV viewing reservation of a program. If the clock is not set, you can not use this function and the screen below will appear. The message on the screen will disappear after 3 seconds, then the screen automatically goes to the clock setup mode (see page 67).

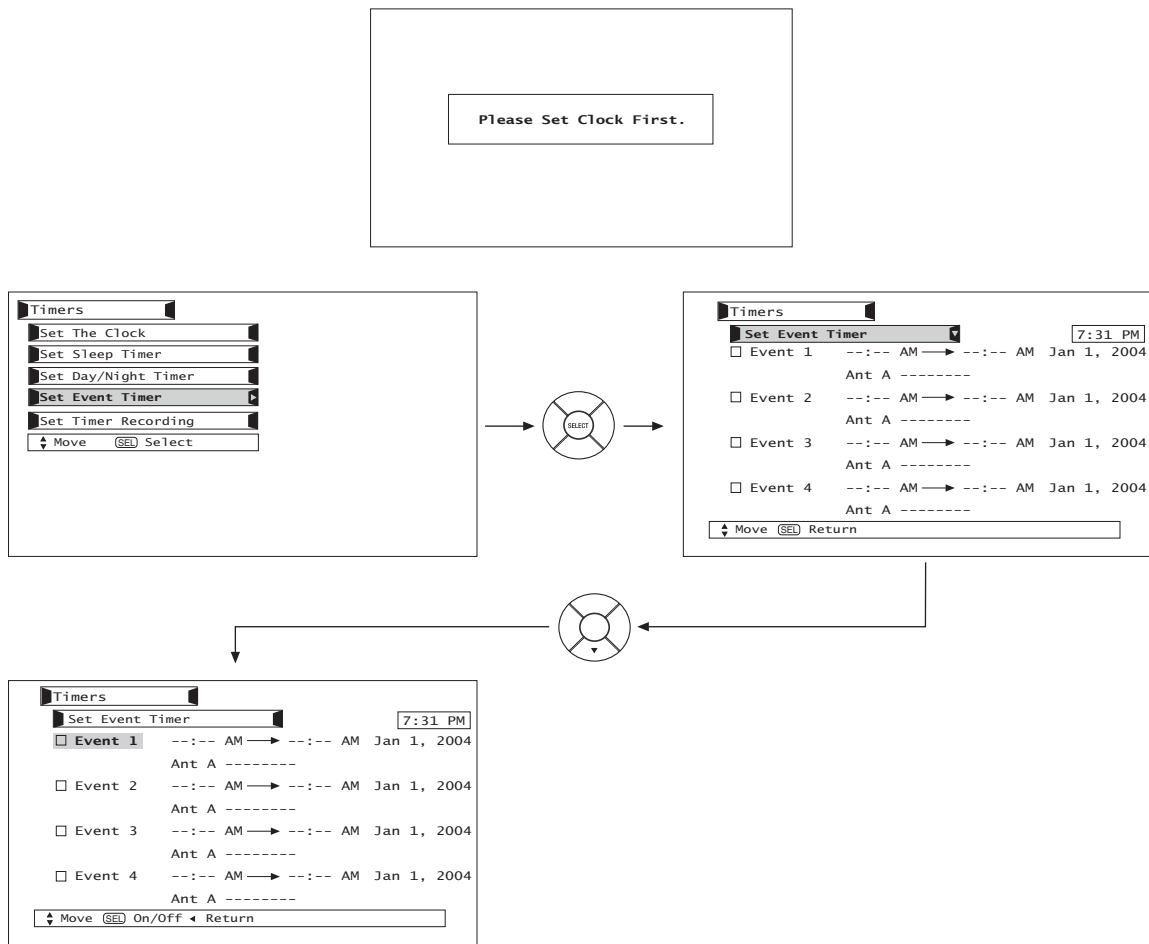

- Use CURSOR PAD ▲, ▼ to highlight Event 1, Event 2, Event 3, Event 4 and then press the SELECT button to select.
 - Use CURSOR PAD ►, ▲, ▼ to highlight and select START TIME Hour/Minute.
 - Use CURSOR PAD ►, ▲, ▼ to highlight and select START TIME AM/PM.
 - Use CURSOR PAD ►, ▲, ▼ to highlight and select FINISH TIME Hour/Minute.
 - Use CURSOR PAD ►, ▲, ▼ to highlight and select FINISH TIME AM/PM.
 - Use CURSOR PAD ► to highlight the MONTH.
 - Use CURSOR PAD ▲ to select a MONTH or CURSOR PAD ▼ to select Daily, Weekly - Sunday to Monday. Use CURSOR PAD ◀ to return to MONTH.
 - Use CURSOR PAD ►, ▲, ▼ to highlight and select the DAY of the MONTH.
 - Use CURSOR PAD ►, ▲, ▼ to highlight and select the YEAR.
 - Use CURSOR PAD ►, ▲, ▼ to highlight and select Ant A or Ant B.
 - Use CURSOR PAD ►, ▲, ▼ or NUMBER buttons to set the channel the TV will tune into.
- A "✓" in the box means it is enabled.

NOTE:

1. When the INFO button is pressed, the Event Timer Icon will only display the current date ON/OFF timer.
2. The Off Timer will only activate if the TV was turned on by the On Timer and no channel selection was made after this time. If you change the channel after the On Timer has been activated, the Off Timer will deactivate.
3. If no remote control button is pressed after viewing reservation is activated, the TV will automatically turn off after three hours. Therefore, do not Set Event Timer for more than three hours if you do not plan to control your television with the remote control.

CAUTION: Do not use your TV as a deterrent when away from home by using the On and Off Timers. For safety, the TV should be turned off when you are away from home.

Set Timer Recording

Select this feature to set and record digital channels using your device connected to the IEEE 1394 jacks (ex. D-VHS).

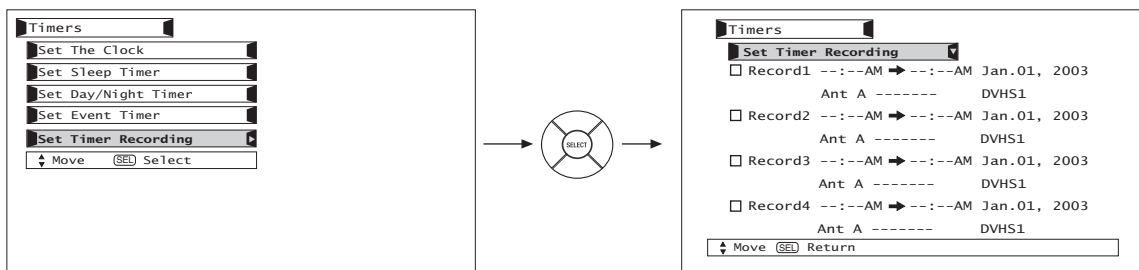

Use CURSOR PAD ▲, ▼ to highlight Record 1, Record 2, Record 3 and then press CURSOR PAD to select.

Use CURSOR PAD ►, ▲, ▼ to highlight and select START TIME Hour/Minute.

Use CURSOR PAD ►, ▲, ▼ to highlight and select START TIME AM/PM.

Use CURSOR PAD ►, ▲, ▼ to highlight and select FINISH TIME Hour/Minute.

Use CURSOR PAD ►, ▲, ▼ to highlight and select FINISH TIME AM/PM.

Use CURSOR PAD ► to highlight the MONTH.

Use CURSOR PAD ▲ to select a MONTH or CURSOR PAD ▼ to select Daily, Weekly - Sunday to Monday. Use CURSOR PAD ▲ to return to MONTH.

Use CURSOR PAD ►, ▲, ▼ to highlight and select the DAY of the MONTH.

Use CURSOR PAD ►, ▲, ▼ to highlight and select the YEAR.

Use CURSOR PAD ►, ▲, ▼ to highlight and select ANT C channel # to be recorded.

Use CURSOR PAD ►, ▲, ▼ to highlight and select 1394 Device to be used.

Press the SELECT button to return and highlight Record 1.

A "✓" in the box means it is enabled.

- NOTES:**
1. Set the Time and connect the IEEE1394 devices before using this feature.
 2. The Timer Recording has priority over the Event Timer. If the Timer Recording is set at the same time as the Event Timer or overlaps with each other, the TV will only perform the function of the Timer Recording.

SETUP

Setup

Select SETUP when setting up your TV for the first time. Use the CURSOR PAD ▲ or ▼ on the remote to highlight the function desired.

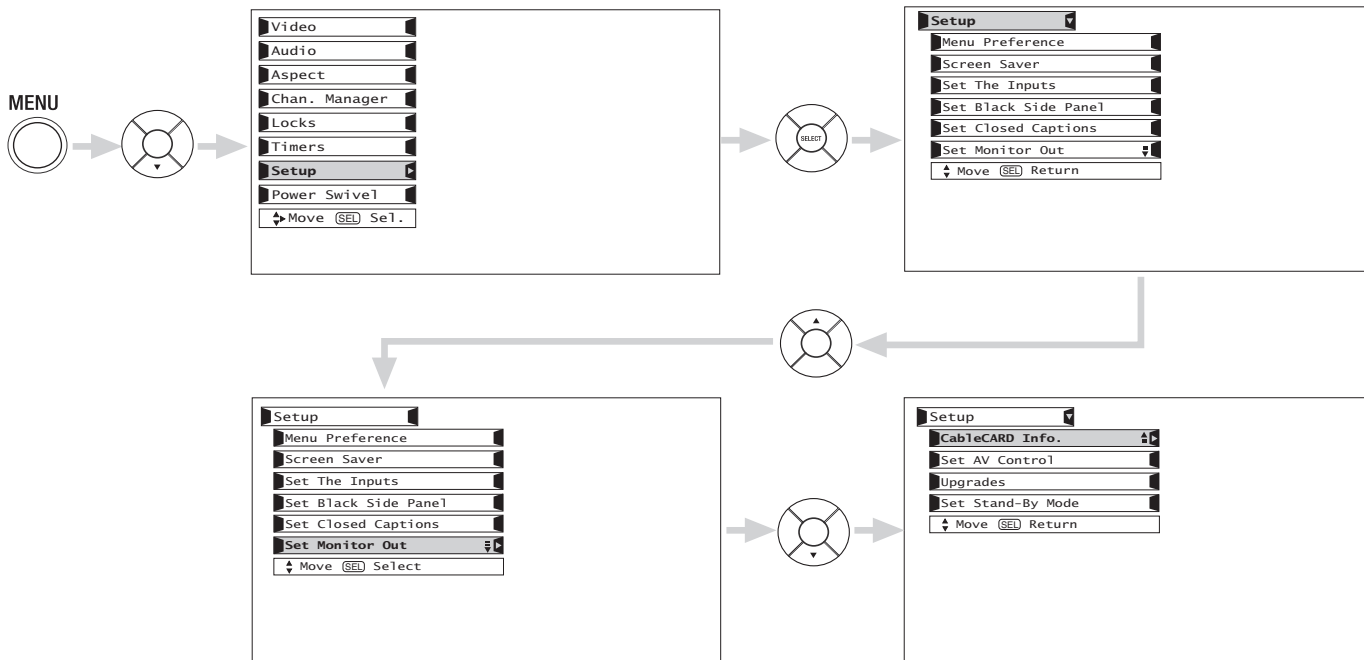

Use CURSOR PAD (▲,▼,◀,▶) to select the sub-menu of your choice. Press the SELECT button to select.

Menu Preference

This feature will allow you to select any one of three different languages for all on-screen displays.

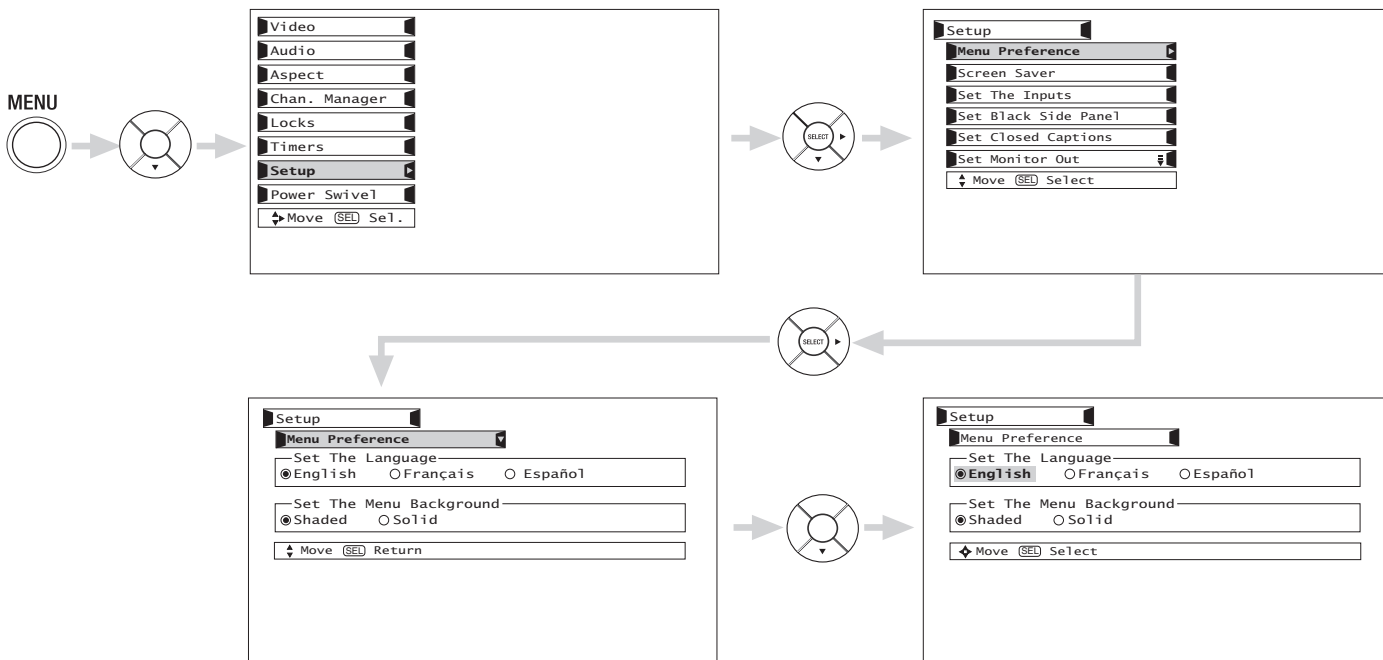

Use CURSOR PAD ◀, ▶ to highlight the language of your choice. Press SELECT to select the highlighted language. Press EXIT to quit the menu.

ON-SCREEN DISPLAY

Menu Background

This function allows you to choose from two menu backgrounds.

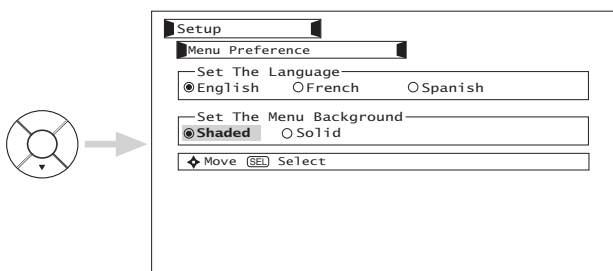

Use CURSOR PAD ◀, ▶ to highlight SET THE MENU BACKGROUND (shaded or solid), and the SELECT button to select the setting. Press EXIT to quit the menu.

Select SOLID and background is visible (no picture can be seen behind menu screen), select SHADED and a light background is visible.

Screen Saver

Continuous on-screen displays such as video games, stock market quotations, computer generated graphics, and other fixed (non-moving) patterns can cause permanent damage to the LCD Television. Use the SCREEN SAVER feature to hide screen burn.

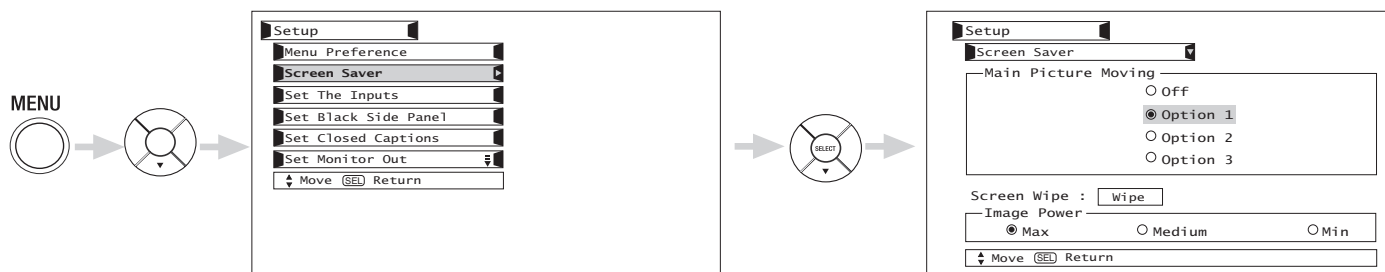

Use CURSOR PAD ▲, ▼ to highlight Screen Saver's Main Picture Moving options. Press down on CURSOR PAD to select and EXIT to quit.

Option 1

The whole picture will shift every 20 minutes by two pixels.

Option 2

The whole picture will shift every 40 minutes by two pixels.

Option 3

The whole picture will shift every 60 minutes by two pixels.

Screen Wipe

If pattern mark occurs, use Screen Wipe (White Field Signal) for at least 10 minutes to refresh any damage that may have occurred from a pattern mark. Screen Wipe can resolve pattern mark to a certain degree, if caution is not used, permanent damage may occur. Press the EXIT button to return to normal viewing.

Screen Saver Picture's Movement

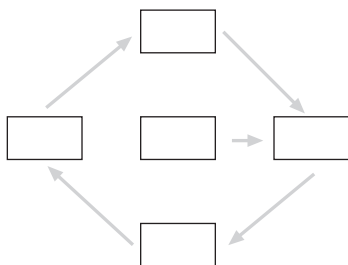

Image Power

This function allows you to choose Power Consumption reduction.

SETUP

Set The Inputs

Use this feature to give a name to any of the five video inputs.

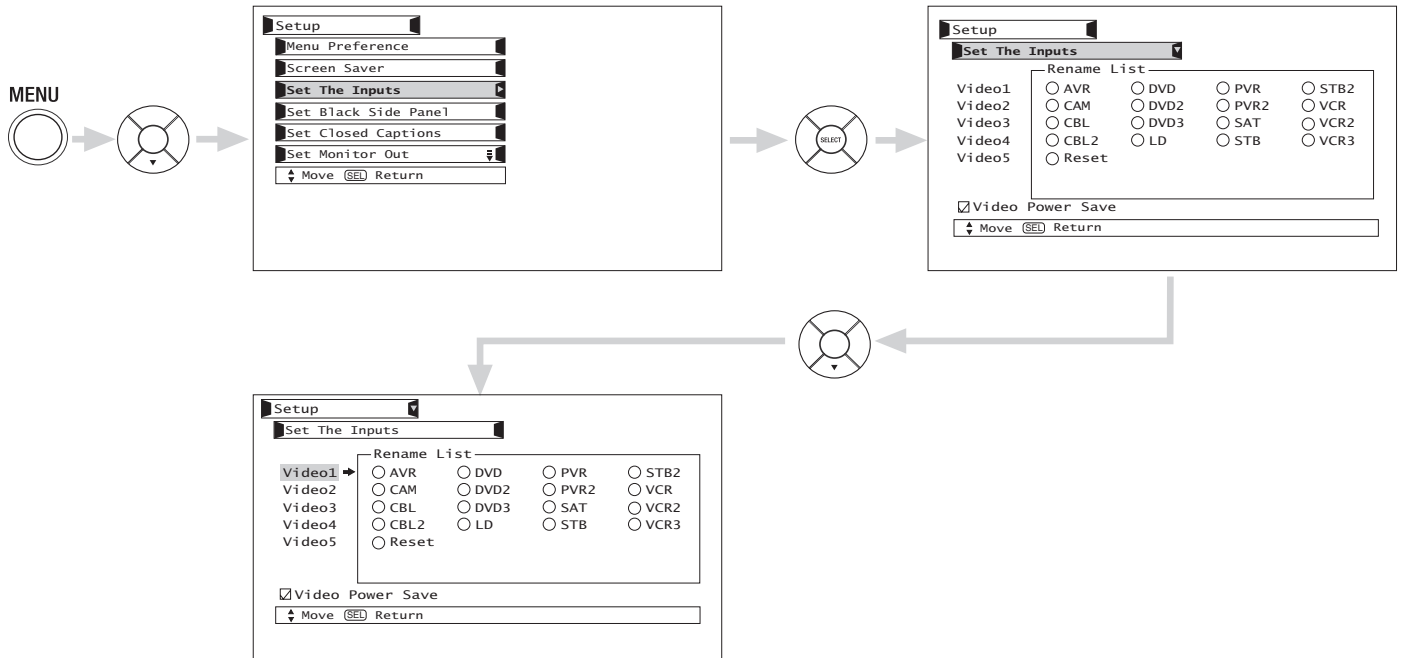

Press CURSOR PAD ▲, ▼ to highlight the name of the video inputs.
Press the SELECT button to select desired input name.

Select RESET to set video names to original factory preset condition.

NOTE: The video input name will be displayed only when video input is displayed as main picture.

Video Power Save

Use this feature to reduce power consumption for video input when there is no video input signal. In RGB mode, this feature will always be on.

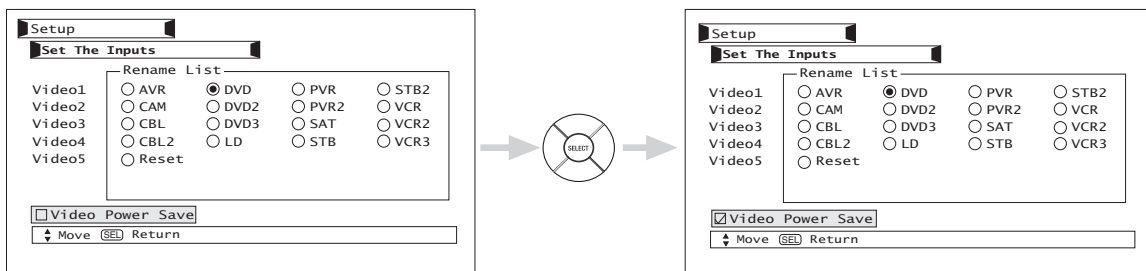

Press CURSOR PAD ▼ to highlight VIDEO POWER SAVE.
Press the SELECT button to select.

Video 2 Auto Link

Use this function to automatically turn the TV on and tune to Video 2 when it detects a video signal to input 2.

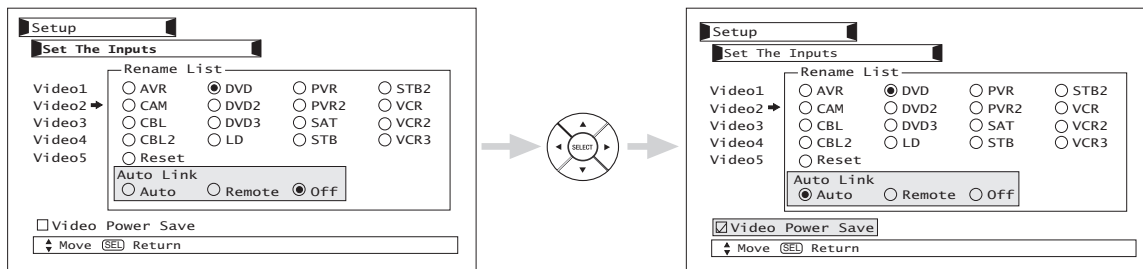

Use CURSOR PAD ▲, ▼, ◀, ▶ then press the SELECT button to change AUTO LINK setting.

When AUTO is selected, the TV will turn on and switch to Video2 automatically, when the Video2 input device is turned on. This is convenient when you want to watch a movie with your VCR, laserdisc player, or DVD player.

When REMOTE is selected, the TV will turn on and switch to Video2 automatically when the Video2 input device is turned on (VCR, laserdisc, or DVD) and any of the buttons on your remote control is pressed.

Select Off to disable this function.

Press EXIT to quit the menu.

- NOTES:**
- Once the TV has been turned on using the AUTO LINK feature, it must be reset before AUTO LINK is used again. To do this, turn your VCR, laserdisc, or DVD player OFF. This feature is now reset and will turn on your TV as described above.
 - When using REMOTE mode, any remote control button will substitute for your video input device play button. However, intended operation is for use with your VCR, laserdisc, or DVD play button.
 - If no remote control button is pressed after the TV is turned on by AUTO LINK, the TV will automatically turn off after three hours.

Set Black Side Panel

The BLACK SIDE PANEL function turns the gray side bars on/off when watching 4:3 signals in Standard mode.

Signal \ Setting	Off	On	Auto 1	Auto 2	Recommended Aspect
NTSC/480i/480p Aspect: 4:3 standard	Gray	Black	Gray	Gray	4x3 Expanded
1080i (4x3 source) Aspect: 16:9 standard	Black	Black	Gray	Gray	4x3 Expanded
1080i (4x3 source with logo on corner) Aspect: 16:9 standard	Black	Black	Black	Gray	4x3 Expanded

- NOTES:**
- To prevent screen burn when watching 4:3 signal, turn off the BLACK SIDE PANEL. It is recommended to watch 4:3 signal with gray side bar.
 - Depending on received signals, some images and Closed Caption displays may be missing when the Black Side Panel is set to Auto 1 or Auto 2.

SETUP

Set Closed Caption

Closed Captions are the dialogue, narration, and/or sound effects of a television program or home video which are displayed on the TV screen. Your local TV program guide denotes these programs as **CC** or

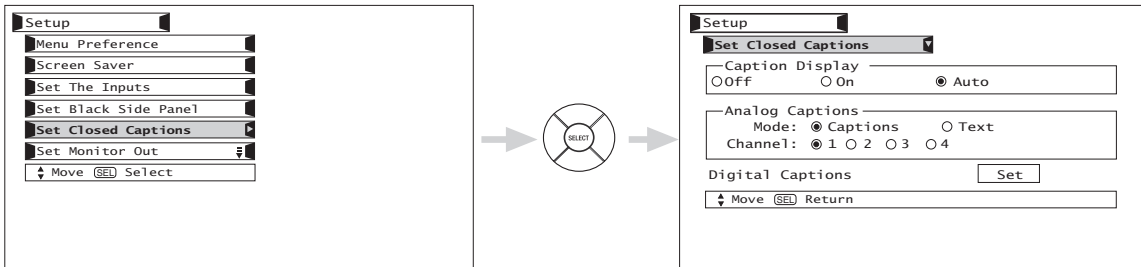

Caption Display: On/Off will turn the **CC** display on or off.

Auto will turn the **CC** display on when Mute/Soft Mute is on.

Caption Mode: **Captions** is for the program you are viewing.

Text is for additional information such as news reports or a TV program guide. This information covers the entire screen and viewing the TV program is not possible. Text may not be available with every **CC** program.

- CHANNEL:**
- 1 is used for the primary language (usually English).
 - 2 is sometimes used for a second language (may vary by region).
 - 3 is sometimes used for a third language (may vary by region).
 - 4 is sometimes used for a fourth language (may vary by region).

Use the CURSOR PAD **▲**, **▼**, **◀**, **▶** to highlight the function to change then press the SELECT button to select the function. Press EXIT to quit menu or the CURSOR PAD **◀** to return to previous menu.

Digital Captions: Set captions for digital programs. This function will help choose and set available language, font, size and style of digital captions.

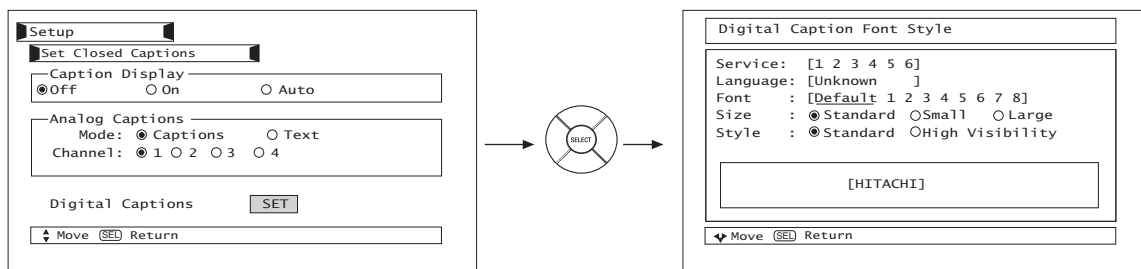

Use the CURSOR PAD **▲**, **▼**, **◀**, **▶** to highlight desired Digital Captions feature. Press the SELECT button to select desired feature. Press EXIT to quit menu or the CURSOR PAD **◀** to return to previous menu.

- NOTES:**
1. Depending on the source, some types of digital closed captions may not work with this TV.
 2. CAPTION DISPLAY will not work when viewing a 480p, 720p, or 1080i input via the COMPONENT: Y-P_BP_R inputs.
 3. When PIP Surf is on, Closed Caption will not work.
 4. Digital Captions Font Style are sometimes different from the Font Style of Analog Captions.
 5. Closed Caption and Digital Captions availability and content depends on the broadcaster. Closed Caption is available when Closed Caption icon is displayed on screen.
 6. Digital Captions will not be available (grayed out) when using analog channels.

Set Monitor Out

This feature will select the source of the Monitor Output.

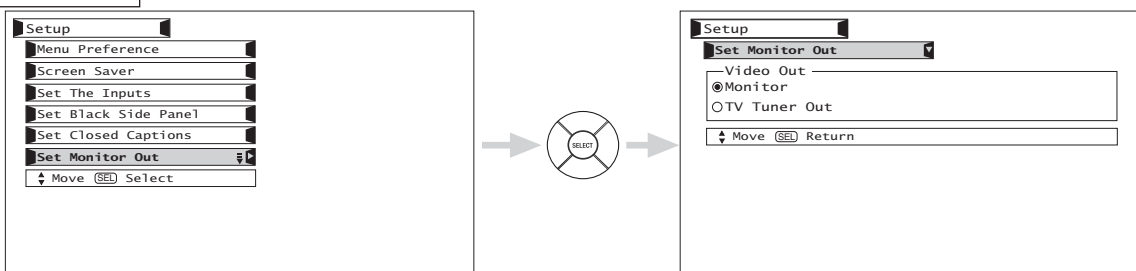

Monitor- Select Monitor to output the audio and video signals of the chosen input source (ANT A, ANT B, VID1-VID5) to a VCR or other A/V device.

TV Tuner Out- Select TV Tuner Out to output the audio and video signals of the last watched Antenna Source (ANT A, ANT B).

Use CURSOR PAD ▲, ▼ to highlight the function to change then press the SELECT button to select the function.

Press EXIT to quit menu or CURSOR PAD ◀ to return to previous menu.

CableCARD Info

Select this feature to access your CableCARD ID and HOST ID. Please have this information ready when you call your cable operator (see also page 13).

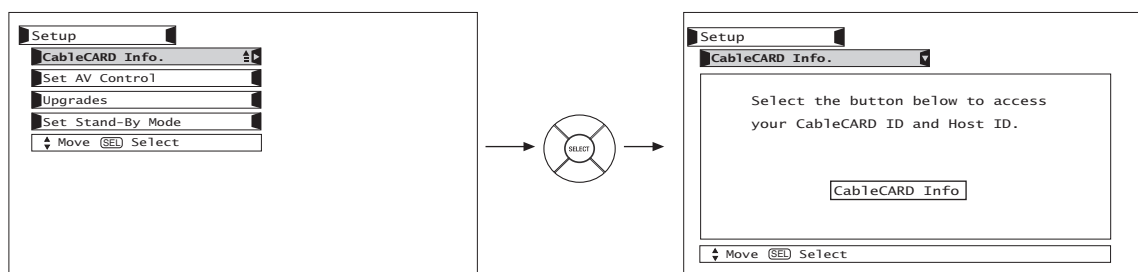

Set AV Control

This feature will select the AV Control feature. Set this feature if you want to control some of the TV functions from an external home control system.

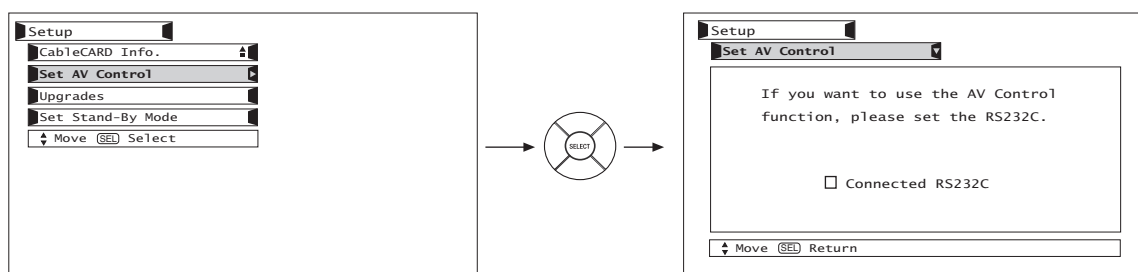

Use the CURSOR PADS and the SELECT button to check the Connected RS232C box.

NOTE: For use with third party home Audio/Video control systems which are commercially available. Please see your dealer regarding these “non Hitachi” home control systems.

SETUP

Upgrades

It shows software information and easy upgrade procedure. This function allows the TV software to be upgraded by using a flash card (MMC Card). If a future software upgrade is required for your TV, Hitachi will notify and provide you with a flash card. In order to receive written notification and the flash card, please complete and return the warranty card.

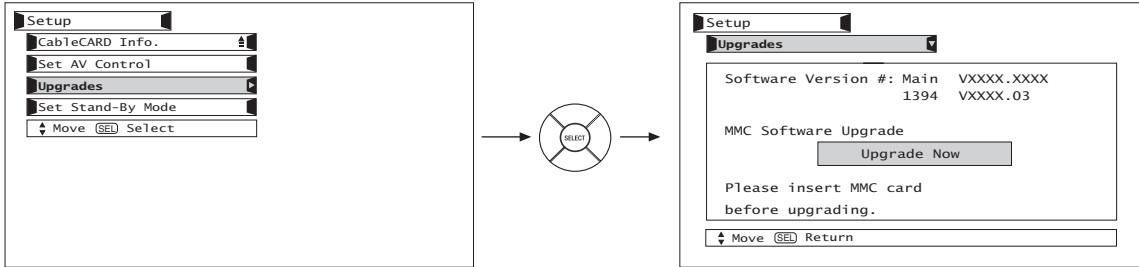

Insert MMC card, then press the CURSOR PAD ▲, ▼ to highlight “Upgrade Now”. Press the SELECT button to select and start upgrading.

NOTE: Any power interruption during the upgrade process will cancel the upgrade. When this happens, repeat the upgrade procedure.

Set Stand-By Mode

This function sets the IEEE1394 in Stand-By Mode to ON or OFF. Certain digital devices have a power save feature, in which the device automatically powers OFF when not in use (sleep mode). Only by setting the IEEE1394 function in Stand-By mode to ON, will the TV be able to control a device that is in sleep mode.

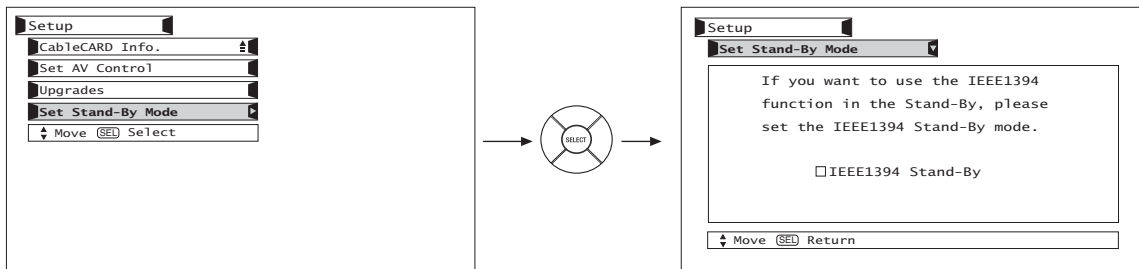

NOTE: By turning ON the IEEE1394 function, your TV set will no longer be set for power saving Stand-By mode. The IEEE1394 Stand-By function must be set to OFF to return your TV set to the power saving Stand-By mode.

Power Swivel

This feature controls the motorized stand. It allows the customer to turn the LCD display left or right using the remote control.

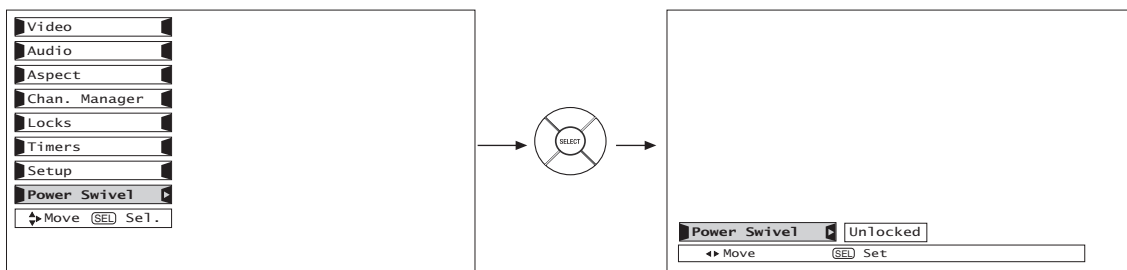

Exit OSD menu system before controlling the motorized stand.

Use CURSOR PAD ► to rotate the TV to the right.

Use CURSOR PAD ◀ to rotate the TV to the left.

Release the CURSOR PAD to stop rotation.

- NOTES:**
1. The Power Swivel has a maximum turning radius of 30° (left and right).
 2. Do not place any objects on the path of the monitor when using the power swivel feature.
 3. Before using the power swivel feature, please make sure that the path of the monitor is clear of any fingers, hands or any other body parts to avoid causing injury.
 4. When the Picture-in-Picture (PIP) or Freeze mode is ON, the Power Swivel is disabled.

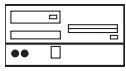

RGB ON SCREEN DISPLAY

IMPORTANT: TURN OFF THE AVC BOX, THE DISPLAY MONITOR AND THE EXTERNAL COMPONENT BEFORE CONNECTING OR DISCONNECTING ANY CABLES.

1. AVC rear panel connection to an external component with an analog RGB output.

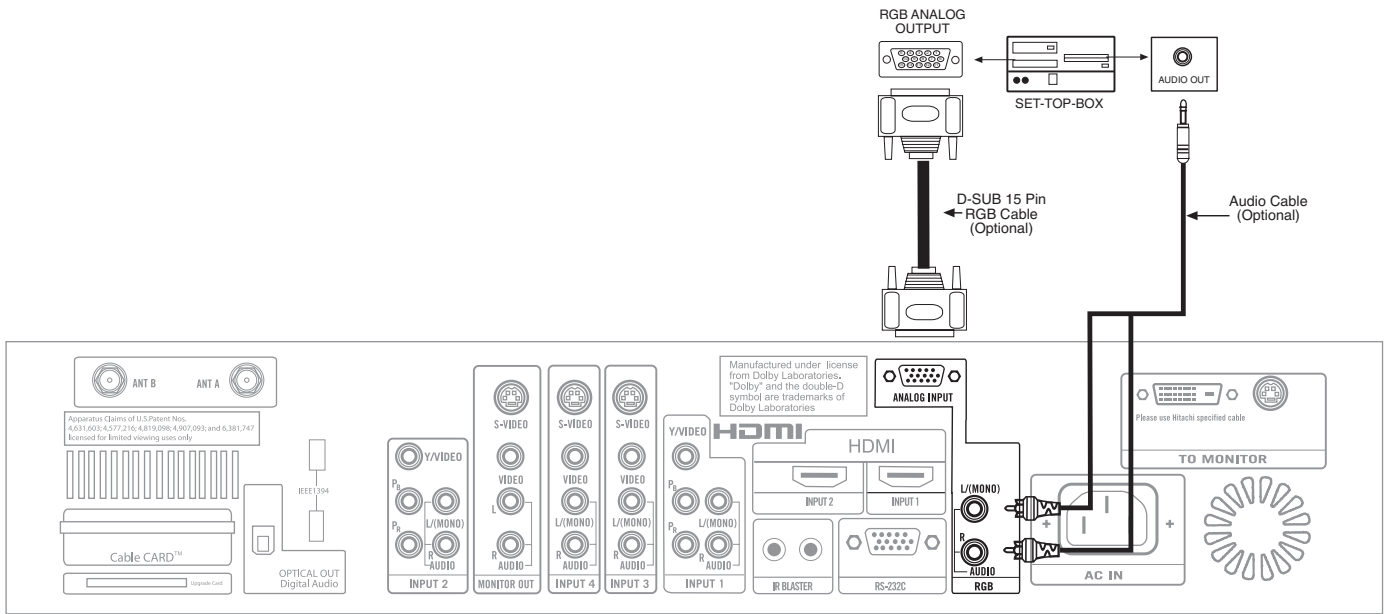

This LCD Television can automatically detect and display the signal format below.

1. RGB input signal.
This LCD Television can accept the following signal formats.

Recommended Signal List

No.	Signal Mode			Horizontal Frequency (kHz)
	Signal Name	Resolution	Vertical Frequency (Hz)	
1	VESA	640 x 400	70.09	31.47
2	VGA	640 x 480	59.94	31.47
3	VESA	640 x 480	72.81	37.86
4		640 x 480	75.00	37.50
5		800 x 600	56.25	35.16
6		800 x 600	60.32	37.88
7		800 x 600	72.19	48.08
8		800 x 600	75.00	46.88
9		1024 x 768	60.00	48.36
10		1024 x 768	70.07	56.48
11		1024 x 768	75.03	60.02
12		1280 x 1024	60.02	63.98
13	1280 x 1024	75.03	79.98	
14	1080i	1080	59.94	33.72
15	720p	720	59.94	44.96
16	480p	480	59.94	31.47

NOTE: 1. Dots correspond to the true resolution in Real Mode of aspect ratio, when you select VGA 640 x 480 signal from the table above. (One dot corresponds to one pixel).
2. Always reset AUTO ADJUST feature when setting new display setting or when changing to a new computer (see page 85).

RGB ON SCREEN DISPLAY

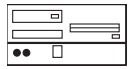

2. The new setting (horizontal position, vertical position, clock, and phase) of the signal will be stored. The monitor can store up to 13 settings in addition to the 15 pre-set signal timing. Any additional new settings (more than 15) will over-write the first user's setting, second setting and so on.
3. Operation in RGB mode in relation to TV functions are shown below.

No.	Item	Operation
1	Video Control	Contrast and brightness work separately, however, other picture controls are not available.
2	AV Net	Available.
3	Audio Settings	Not available.
4	Closed Caption	Not available.
5	Clock	Clock indication is shown.
6	Monitor Out	Both picture and audio are not available.
7	Lock	Not available.
8	Auto Link	Not Available.

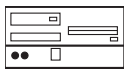

4. Other signal formats may not be displayed correctly. Use AUTO ADJUST to automatically adjust the horizontal position, vertical position, clock, and phase. We recommend you use a signal, which has more than 50% of amplitude of white area at each corner of the picture, when performing Auto Adjustment. It may not work correctly with dark picture (see page 85).

5. Input signal level.

SYNC	TTL level H/V separate signal
RGB INPUT	0.7Vpp/1.0Vpp

NOTE: Interlaced signal is not available.

6. RGB input signal will not appear at all when receiving a signal which is not supported by this product. If the setting is wrong, the Display Monitor will display:

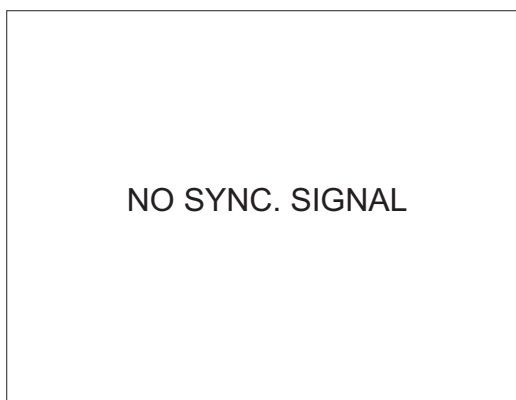

NO SYNC. SIGNAL

Without sync

POWER SAVING mode will come on after 10 seconds.

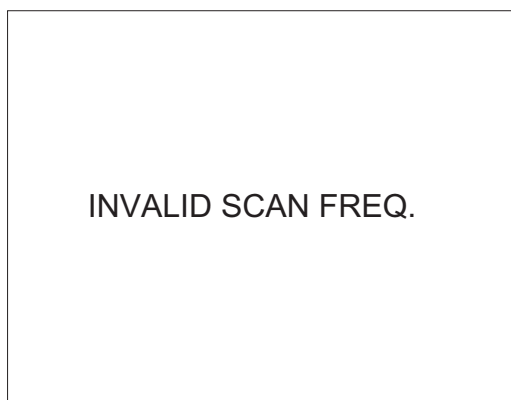

INVALID SCAN FREQ.

Either horizontal or vertical frequency is inappropriate or out of range.

INVALID SCAN FREQ. will disappear after 60 seconds.

NOTE: 1. If the Display Monitor cannot display a signal, please try AUTO ADJUST to display the signal. This is used to initialize the MultiScan Converter.
2. Not all signals have AUTO ADJUST feature (see page 85).
3. Set-Top-Box and DVD player input signal does not have AUTO ADJUST feature.

RGB ON SCREEN DISPLAY

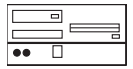

1. Press the INPUTS button, then use the CURSOR PAD and SELECT button on the remote control to display the different features in RGB MODE.
2. Press EXIT on the remote control to quickly exit from a menu.

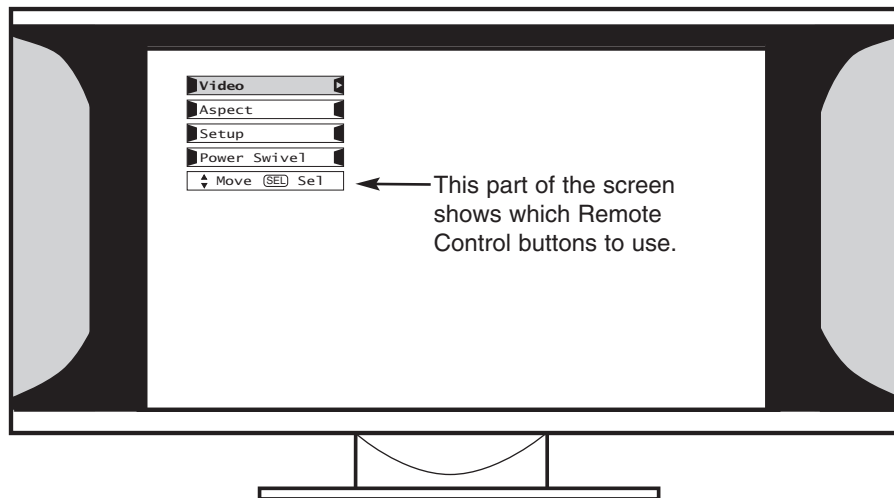
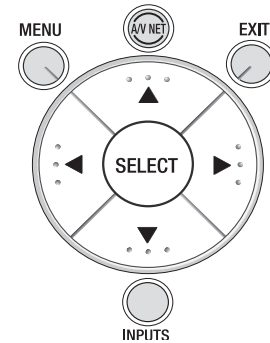

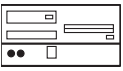

Video	Contrast	Change the contrast between black and white levels in the picture.
	Brightness	Adjust overall picture brightness.
	Color Temperature	Select between HIGH (9,300K), MEDIUM (7,500K), STANDARD (6,500K), or Black/White (5,400K).
	Enhancer	Enhance picture details (Off, Low, Medium or High).
	Reset	Recall the factory preset data of the RGB Video Settings.
Aspect	Real	Aspect as it is presented in its true resolution.
	Normal	Aspect in 4:3 standard.
	Full	Aspect in 16:9 standard.
	WXGA Mode	Select WXGA Settings
Setup	Auto Adjust	Automatically adjust the geometry to fit the screen.
	Horizontal Position	Adjust horizontal position.
	Vertical Position	Adjust vertical position.
	Horizontal Clock	Adjusts the dot clock frequency to reduce the vertical stripe.
	Clock Phase	Adjusts the phase to correct blurred or unstable images.
	Reset	Recall the factory preset data of the RGB setup settings.
	Input Level	Set the preferred input signal level.
Black Side Panel	Turns the gray side bars ON/OFF when watching Aspect in Real and Normal signals in standard mode.	
Power Swivel	Unlock	Power Swivel enabled. Controls motorized stand.
	Lock	Power Swivel disabled.

RGB ON SCREEN DISPLAY

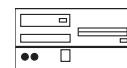

VIDEO ADJUSTMENTS

The following adjustments are independent of the TV mode:

- Press MENU in RGB mode for on screen display.
- Press CURSOR PAD ▲ or ▼ to highlight the item to be adjusted.
- Press SELECT to select the highlighted item.

CONTRAST

This feature allows you to adjust the contrast in RGB mode.

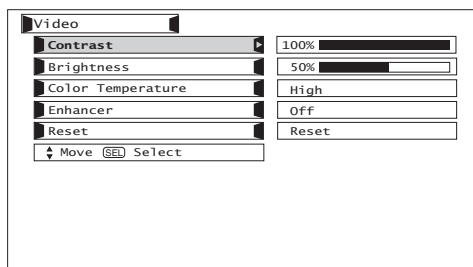

Use CURSOR PAD ◀ or ▶ to adjust contrast. Press MENU button to return to RGB MODE MENU and EXIT to quit.

- NOTES:**
1. Contrast can be set up to 110% if CURSOR PAD ▶ is pressed and held for more than 3 seconds.
 2. See TV contrast feature for additional information regarding contrast.

BRIGHTNESS

This feature allows you to adjust brightness in RGB Mode.

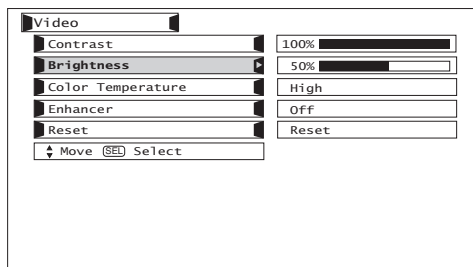

Use CURSOR PAD ◀ or ▶ to adjust brightness. Press MENU button to return to RGB MODE MENU and EXIT to quit.

COLOR TEMPERATURE

Use the CURSOR PAD ◀ or ▶ to change the COLOR TEMPERATURE. Set to HIGH for a cooler picture with more blue (1,200K), set to MEDIUM for more natural color (9,300K), or set to STANDARD for accurate color (6,500K), or Black/White (5,400K).

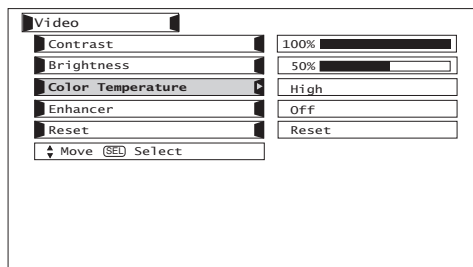

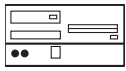

ENHANCER

Enhances the picture detail.

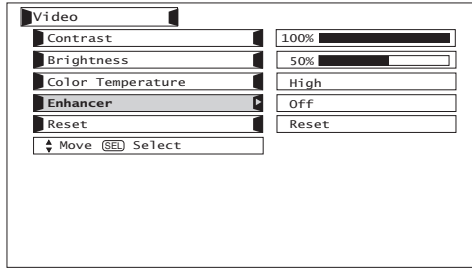

Use CURSOR PAD ◀ or ▶ to set ENHANCER Off, Low, Medium or High. Press SELECT button to ACCEPT and EXIT to quit.

RESET

Set CONTRAST, BRIGHTNESS, COLOR TEMPERATURE, and ENHANCER to factory preset condition.

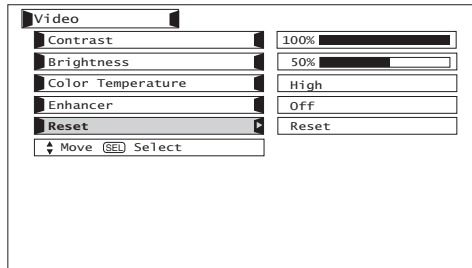

Use CURSOR PAD ◀ or ▶ to highlight Reset. Press the SELECT button to RESET to factory preset settings.

ASPECT

Use this function to select the picture format aspect ratio while using RGB input.

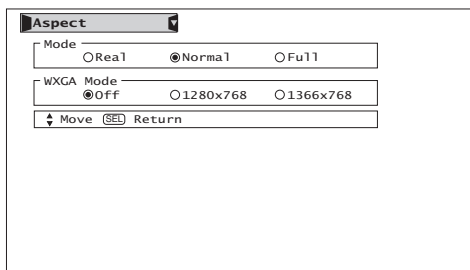

Use CURSOR PAD to highlight chosen selections. Press SELECT button to set and EXIT button to quit.

Recommendation

Input Signal	Mode	WXGA Mode
XGA	Normal	Off
WXGA (1280x768)	Full	1280x768
WXGA (1366x768)	Full	1366x768

RGB ASPECT DISPLAY MODE.

		RGB (Analog) INPUT SIGNAL					
		Others	SVGA/XGA	VGA	480p	720p	1080i
ASPECT MODE AVAILABILITY	X		REAL	REAL	REAL(1)	X	X
	NORMAL		NORMAL	NORMAL	NORMAL(1)	X	X
	FULL		FULL	FULL	FULL(1)	FULL(2,3)	FULL(2,3)

For numbers in (), please see corresponding note below.

- NOTES:**
- Lack of raster can be seen in RGB when a 480p signal is input.
 - AUTO ADJUST function (see page 85) is not available in 720p, 1080i, and 480p input signal.
 - FULL aspect mode, only 95% of information can be displayed (5% is treated as overscan).

RGB ON SCREEN DISPLAY

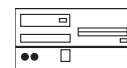

AUTO ADJUST

HORIZONTAL POSITION, VERTICAL POSITION, HORIZONTAL CLOCK and CLOCK PHASE for current RGB format are adjusted automatically.

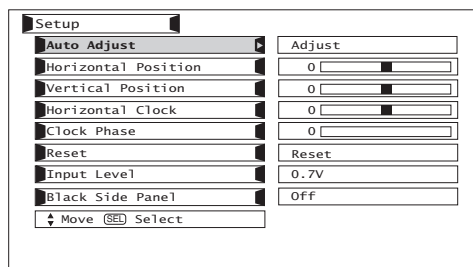

Use CURSOR PAD ◀, ▶ cursors to highlight adjust. Press SELECT to select AUTO ADJUST.

NOTES:

- Press SELECT to AUTO ADJUST the RGB mode.
- The other functions do not operate while AUTO ADJUST is in progress.
- Allow the LCD TV to warm up for 20 minutes before performing AUTO ADJUST.
- Select a bright image for display while AUTO ADJUST takes place.
- If AUTO ADJUST terminates unsuccessfully, try AUTO ADJUST again. If AUTO ADJUST fails several times in succession, try using manual adjustment to adjust Vertical Frequency, Aspect Ratio, Timing Frequency and Picture.
- Always reset AUTO ADJUST when setting new display setting or when changing to a new external component.

H POSITION

This feature allows you to adjust the horizontal position of the display.

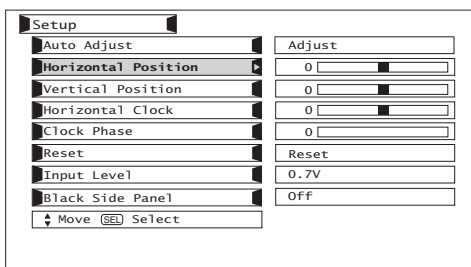

Use CURSOR PAD ◀, ▶ to adjust the horizontal position. Press the MENU button to return to previous menu item. Press EXIT to quit.

V POSITION

This feature allows you to adjust the vertical position in RGB mode.

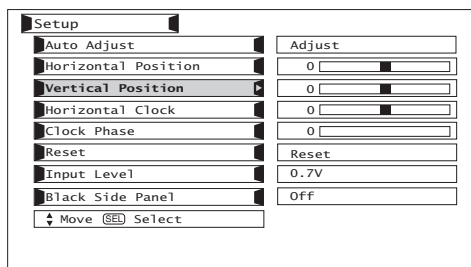

Use CURSOR PAD ◀, ▶ to adjust the vertical position. Press MENU button to return to previous menu item. Press EXIT to quit.

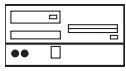

HORIZONTAL CLOCK

Adjusts the pixel clock frequency to reduce the vertical stripe.

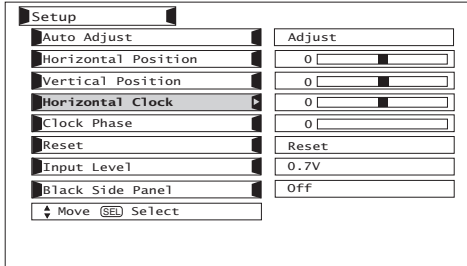

Use CURSOR PAD ◀, ▶ to adjust the horizontal clock. Press the MENU button to return to previous menu. Press EXIT to quit.

NOTE: Due to varying signal content, you may see vertical or horizontal lines bend occasionally in RGB mode. However, this phenomenon is not a defect. It's caused by a lack of picture content due to under-scanning in RGB mode.

CLOCK PHASE

Adjusts the phase to correct blurred or unstable images.

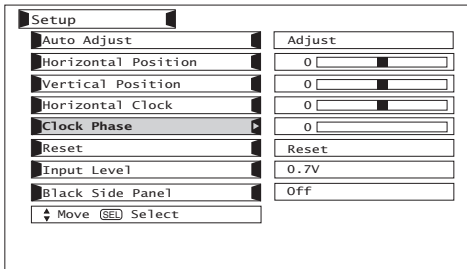

Use CURSOR PAD ◀, ▶ to adjust the clock phase. Press the MENU button to return to previous menu item. Press EXIT to quit.

RESET

Set HORIZONTAL POSITION, VERTICAL POSITION, HORIZONTAL CLOCK and CLOCK PHASE to factory preset, for current RGB format.

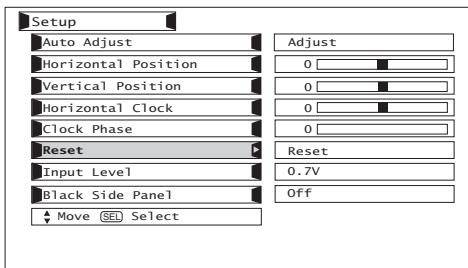

Use CURSOR PAD ◀, ▶ to highlight Reset. Press the SELECT button to RESET to factory preset settings.

RGB ON SCREEN DISPLAY

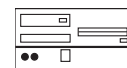

INPUT LEVEL

Select the Input Level voltage between 0.7V and 1.0V.

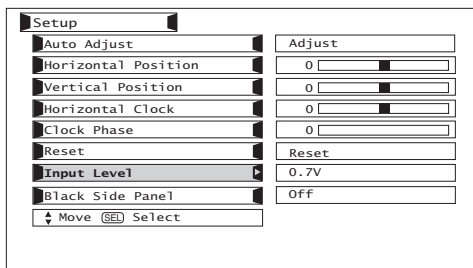

Use CURSOR PAD ◀, ▶ to select between 0.7V and 1.0V depending on the amount of brightness in the picture.

BLACK SIDE PANEL

The BLACK SIDE PANEL function turns the gray side bars ON/OFF when watching Aspect in Real and Normal signals in Standard Mode.

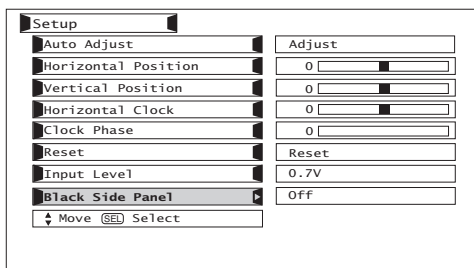

Press the SELECT button to select BLACK SIDE PANEL ON/OFF.

POWER SWIVEL

This feature controls the motorized stand. It allows the customer to turn the LCD display left or right using the remote control.

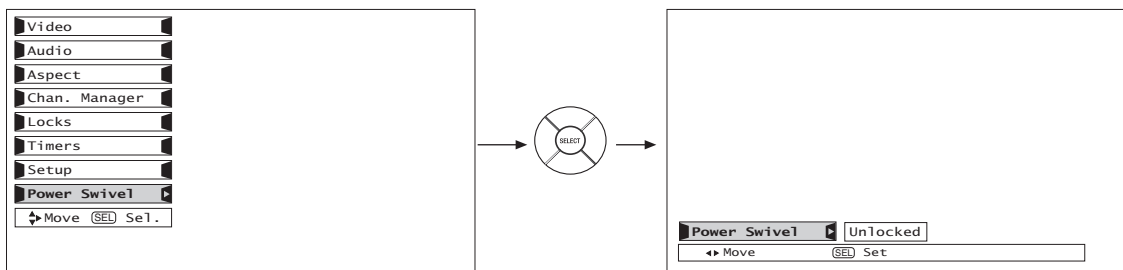

Exit OSD menu system before controlling the motorized stand.

Use CURSOR PAD ▶ to rotate the TV to the right.

Use CURSOR PAD ◀ to rotate the TV to the left.

Release the CURSOR PAD to stop rotation.

- NOTES:**
1. The Power Swivel has a maximum turning radius of 30° (left and right).
 2. Do not place any objects on the path of the monitor when using the power swivel feature.
 3. Before using the power swivel feature, please make sure that the path of the monitor is clear of any fingers, hands or any other body parts to avoid causing injury.
 4. When the Picture-in-Picture (PIP) or Freeze mode is ON, the Power Swivel is disabled.



CARE OF YOUR HITACHI LCD DISPLAY AND YOUR REMOTE CONTROL

DO

Dust the screen and frame with a cleaning cloth from the accessories pack.

Clean the screen and frame with a soft cloth moistened in warm water and dry with a soft cloth. A mild soap may be used if the screen is extremely dirty.

Place your LCD Television away from extreme heat, humidity, and extremely dusty places.

Remove the plug (AVC Center/Display Monitor) from the wall outlet if your LCD Television will not be used for a long period of time, for instance, when you go on vacation.

DO NOT

Do not clean your screen with strong cleaners, polishes or a chemically treated cloth.

Do not place rubber or vinyl products or cellophane tape on your LCD Television.

Avoid repeatedly touching the screen.

Do not subject the remote control to shocks such as dropping it on the floor, etc. This may cause physical damage to the precision parts.





Avoid placing the remote control in a high humidity place or getting it wet. Do not leave it on or near a heater. Excessive heat or moisture may cause the remote control unit to fail.

When the batteries run down, remote control operation will become erratic or become unresponsive. Replace the old batteries with two new "AA" size batteries. Do not use an old battery with a new battery.

Exposing the screen to direct sunlight for a long period of time or heat may cause damage to the LCD screen.

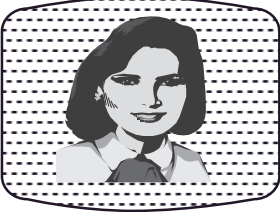
RECEPTION PROBLEMS



	<ul style="list-style-type: none">• IGNITION NOISE: Black spots or horizontal streaks may appear, picture may flutter or drift. Usually caused by interference from automobile ignition systems, neon lamps, electrical drills, and other electrical appliances.
	<ul style="list-style-type: none">• GHOSTS: Ghosts are caused by the television signal following two paths. One is the direct path and the other is reflected from tall buildings, hills or some other objects. Changing the direction or position of the antenna may improve reception. Ghosting may also be caused by defects in the antenna system such as unshielded leads or connecting several sets to the same antenna without using multiple antenna couplers.
	<ul style="list-style-type: none">• SNOW: If your receiver is located in the fringe area of a television station where the signal is weak, your picture may be marred by the appearance of small dots. When the signal is extremely weak, it may be necessary to install a special antenna to improve the picture.
	<ul style="list-style-type: none">• RADIO FREQUENCY INTERFERENCE: The interference produces moving ripples or diagonal streaks, and in some cases, causes loss of contrast in the picture.

NOTE: The TV set can generate sound distortion in external devices such as a radio. Please separate radio equipment from the TV set to a considerable distance.



SYMPTOMS	CHECK THESE ITEMS AND TRY THESE ADJUSTMENTS												
	Be sure external connection is correct	Be sure power cord is plugged in	Be sure TV is switched "ON"	Try another channel (station trouble)	Check antenna connections (back of TV)	Check antenna for broken lead-in wire	Check outside antenna	Adjust Contrast control	Adjust Brightness control	Adjust Color control	Adjust Tint control	Adjust Volume control	Replace Lamp
No Picture, no sound	●	●	●	●	●	●							
Sound OK, picture poor	●			●	●	●	●	●	●				
Picture OK, sound poor	●			●	●	●	●	●				●	
Picture blurred	●			●	●	●	●	●					
Lines or streaks in picture				●	●	●	●	●					
Poor reception on some channels				●	●	●	●	●					
Picture rolls vertically				●				●					
No color	●			●	●	●	●			●			
Poor color	●			●	●	●	●			●	●		
Dark Picture								●	●				●

HITACHI Liquid Crystal Display incorporates advanced power surge protection technology designed to protect against component or circuit damage due to external or internal voltage power surges.

IF YOUR TELEVISION SHOULD APPEAR TO HAVE A LOSS OF POWER, PLEASE FOLLOW THIS PROCEDURE:

1. Press the power switch (ON/OFF switch) once.
2. If there is still no power, wait 30 seconds and press the power switch again.
3. If there is still no power, unplug the power cord from the wall. Wait 30 seconds and plug the power cord back in. Press the power switch again.

This protective technology should provide for years of lasting entertainment from your HITACHI Liquid Crystal Display.

PLUG and PLAY



This LCD Television complies with VESA DDC2B specifications, Plug & Play is a system with computer, peripherals (including monitors) and operating system. It works when the monitor is connected to a DDC ready computer that is running an operating system software that is capable for the plug & play.

When a Plug and Play PC is powered on, it sends a command to the Monitor requesting identification. The Monitor sends back a string of data including its characteristics.



TRADEMARK ACKNOWLEDGMENT

DDC™ is a trademark of Video Electronics Standard Association.

IBM PC/AT and VGA are registered trademarks of International Business Machines Corporation of the U.S.A.

Apple and Macintosh are registered trademarks of Apple Computer, Inc.

VESA is a trademark of a nonprofit organization, Video Electronics Standard Association.



This Class B digital apparatus meets all requirements of the Canadian Interference-Causing Equipment Regulations.

This Class B digital apparatus complies with Canadian ICES-003.

Cet appareil numérique de la classe B est conforme à la norme NMB-003 du Canada.

Cable Compatible Television Apparatus- Télévision câblocompatible, Canada.

Notes on Closed Caption:

This LCD Television receiver will display television closed captioning, ( or ), in accordance with paragraph 15.119 of the FCC rules.



AGENCY REGULATORY INFORMATION

Federal Communications Commission Notice

This equipment has been tested and found to comply with the limits for a Class B digital device, pursuant to Part 15 of the FCC Rules. These limits are designed to provide reasonable protection against harmful interference in a residential installation. This equipment generates, uses and can radiate radio frequency energy and if not installed and used in accordance with the instructions, may cause harmful interference to radio communications. However, there is no guarantee that interference will not occur in a particular installation. If this equipment does cause harmful interference to radio or television reception, which can be determined by turning the equipment off and on, the user is encouraged to try to correct the interference by one or more of the following measures:

- Reorient or relocate the receiving antenna.
- Increase the separation between the equipment and the receiver.
- Connect the equipment into an outlet on a circuit different from that to which the receiver is connected.
- Consult the dealer or an experienced radio/television technician for help.

Modifications

The FCC requires the user to be notified that any changes or modifications made to this device that are not expressly approved by Hitachi Home Electronics (America), Inc. may void the user's warranty.

Cables

Connections to this device must be made with shielded cables with metallic RFI/EMI connector hoods to maintain compliance with FCC Rules and Regulations.

Any cables that are supplied with the system must be replaced with identical cables in order to assure compliance with FCC rules. Order Hitachi spares as replacement cables.

Declaration of Conformity

This device complies with Part 15 of the FCC Rules. Operation is subject to the following two conditions: (1) this device may not cause harmful interference and (2) this device must accept any interference received, including interference that may cause undesired operation.

For questions regarding this declaration, contact:

Hitachi America, LTD.
Home Electronics Division
900 Hitachi Way
Chula Vista, CA 91914-3556
Tel. 1-800-448-2244 (1-800-HITACHI)
ATTN: CUSTOMER RELATIONS



USEFUL INFO

Features:

- New Easy-to-Use On-Screen Menu Control (3 Language)
- New AV Network System Control
 - Control up to 4 components with one remote
 - 2 IR Mouse cables included
 - Control Codes Stored in AV Control Center
- Two Tuner Split Screen except RGB modes.
- Illuminated and Preprogrammed Remote Control
- Power Management: ON/OFF via signal detection
- Menu Control Keys accessible from AV Control Center
- Picture Enhancement
- Input Signal Identification
- CableCARD compatible - Contact your local cable operator for more information
- HDMI (High Definition Multimedia Interface)(High Bandwidth Digital Content Protection V1.1 Compatible)
- Photo Input (for your digital camera)

Video:

- 1366 x 768 Display Resolution (32")
- High-Contrast Pure-Color Glass Shield
- Wide Viewing Angle: More than 170°
- 4 Color Temperature Presets: Black/White-5400K, Standard-6500K, Medium-9300K, High-1200K.
- Multiple Screen Fill Modes (4:3 Standard/Expanded/Zoom1/Zoom2/16:9 Standard/Zoom)¹
- 4MB 10-bit 3D Y/C Comb Filter
- Picture Modes (Day and Night)
- Computer Display: VGA, (SVGA, XGA, SXGA-scaled) (32")

Inputs:

- Power InputAC 120V, 60Hz
- Power Consumption
 - Refer to rear panel at the back of the LCD Monitor and AVC Center
- Antenna input impedance75 Ohm
- Channel coverage191ch.
 - VHF-Band2 ~ 13
 - UHF-Band14 ~ 69
 - CATV Mid BandA-5 ~ A-1
 -A-I
 - Super BandJ-W
 - Hyper BandW+1 - W+28
 - Ultra BandW+29 - W+94
- Video1.0Vp-p, 75 Ohm
- S-Video
 - Luminance (Y)1.0Vp-p, 75 Ohm
 - Chrominance (C)0.286Vp-p, 75 Ohm
- Component Video
 - Luminance (Y)1.0Vp-p, 75 Ohm
 - Chrominance (P_B/P_R)0.7Vp-p, 75 Ohm
- Audio input Impedance47k Ohm
- Average input level470mVrms
- RGB0.7Vp-p, 75 Ohm
- HDMI(19 PIN)

Outputs:

- Video1.0Vp-p. 75 Ohm
- Audio470mVrms, 1k Ohm
- Optical Out (Digital Audio)1 Optical Connector

Audio:

- MTS Stereo/SAP
- Dynamic Bass and Matrix Surround
- 10W+10W
- Soft Mute (50% and 100%)

Supplied Accessories:

- Remote Control
- Batteries
- 9' Monitor Connection Cable
- 6' AC Cable (2)
- Subwoofer Cable
- IR Mouse Cable (2)

INPUTS/OUTPUTS

- Inputs:RGB, VIDEO 1-5
- Wideband Component Y, Pb,Pr2
- RGB: Analog Input1
- Composite Video.....5
- S-Video3
- Antenna (RF) Inputs.....2
- Audio Output1
- Monitor Output1
- Headphone Output.....1
- Subwoofer Output1
- HDMI2
- Photo Input.....1
- IEEE 13942

SPECIFICATIONS

- Multi-Scanning:24-109kHz (h), 50-85Hz (v)
- Pixel Pitch0.51(horiz.) x 0.51(vert.) mm (32")
- FCC class:B for Consumer Use
- Power Requirements:108-132V, 60Hz

DIMENSIONS

- Width 32"
- Height 30 3/4"
- Depth 17 3/4"
- Weight 2 1/16"
- Weight 86 lbs.

Audio Video Control Center

- Width16 15/16"
- Height.....3 3/8"
- Depth.....9 1/2"
- Weight.....9.5 lbs.

¹ Screen mode availability varies by input format
 HDTV Monitors display HDTV when combined with an HDTV Tuner and Source.
 All specifications, weights, and dimensions are subject to change without prior notice. Please access www.hitachi.com/tv for detailed specifications and dimensions for custom installations.
 UltraVision Digital is a registered trademark of Hitachi Home Electronics (America), Inc.

HDMI™ HDMI, the HDMI logo and High-Definition Multimedia Interface are trademarks or registered trademarks of HDMI Licensing LLC.



HITACHI

*Service
hotline*

To locate an authorized
HITACHI service facility
in the continental U.S.A.
and Canada,

DIAL TOLL FREE

7 days a week, 24 hours a day

800 HITACHI

(1-800-448-2244)

Hitachi America, LTD. Home Electronics Division

Hitachi has made every effort to assure you hours of trouble free operation from your unit. However, should you require service, a network of Hitachi Authorized Service Facilities has been established in all 50 states and Puerto Rico. Each facility will provide you with convenient and expedient assistance. Our service hotline operator will direct you to the Hitachi Authorized Service Facility nearest you. Just present proof of purchase and/or delivery receipts to the Hitachi Authorized Service Facility, and service will be rendered in accordance with the terms of the limited warranty as stated on your warranty card or operating guide.

Should you have any questions regarding warranty, service, operation, or technical assistance, please contact:

**Hitachi America, LTD.
Home Electronics Division
900 Hitachi Way
Chula Vista, CA 91914-3556**

USEFUL INFO



Hitachi Canada, LTD. Digital Media Division

Should you have any questions regarding warranty, service, operation, or technical assistance, please contact:

**In Canada:
1-800-HITACHI
(1-800-448-2244)**

**Monday - Friday EST 9:00am - 7:00pm
Saturday EST 9:00am - 5:00pm**

*Look for your French Manual on the outside of the box.
If the manual is missing, call*

**1-800-HITACHI
(1-800-448-2244)**

for a copy.

Pour de plus amples renseignements sur le service durant la période couverte par la garantie, sur le fonctionnement ou pour de l'assistance technique communiquez avec:

**Au Canada:
1-800-HITACHI
(1-800-448-2244)**

**Lundi - Vendredi L'EST 9:00am - 7:00pm
Samedi L'EST 9:00am - 5:00pm**

*La version française de votre manual se trouve à l'extérieur de la boîte.
Si le manuel est manquant, coposez le*

**1-800-HITACHI
(1-800-448-2244)**

pour obtenir votre copie.

**HITACHI CANADA, LTD.
2495 Meadowpine Blvd.
Mississauga, ON L5N 6C3**



A	
Accessories	4
Antennas (Connecting)	8
Antenna Setup	60
Aspect Ratio	29, 59
Audio (Sound Enhancement)	
Audio Settings	57
Audio Source	57
Auto Adjust (RGB Input)	85
Auto Noise Cancel	57
A/V Network	22-24, 31-32
B	
Balance	57
Bass	57
Black Enhancement	54
Black Side Panel	74
Brightness	54
C	
Caution and Safety Tips	2-3
Channel Manager	60-61
Auto Channel Scan	60
Clock	
Phase	86
Time	67
Closed Captions	
Captions	75
Color Management	55
Color Decoding	56
Color Temperature	54
Color	54
Contrast	54
Contrast Mode	54
E	
Event Timer	69
External Video Source	14-22
F	
Favorite Channel	38
Freeze	28
H	
HDMI	18
I	
Input Setup	73-74
IEEE 1394	20, 36
L	
Language	
Menu Language	71
Locks	
Change Access Code	62
Channel Lock	62
Front Panel Lock	62
Input Lock	62
Movie Ratings	63
TV Ratings	64
TV Ratings (Canadian - English)	65
TV Ratings (Canadian - French)	66
M	
Matrix Surround	57
Menu Preference	
Language	71
Background	72
Monitor Out	76
N	
Noise Reduction	56
P	
Perfect Volume	57
Photo Input	33-35
Picture Mode	53
Picture-in-Picture (PIP)	39-41
Position (RGB Input)	
Horizontal	85
Vertical	85
R	
Remote Control	
Functions	27-49
Programming Codes	48-49
Installing Batteries	4
R/G/B	25, 78-87
S	
Screen Saver	72
Sharpness	54
Speakers	57
Connecting External Speakers	21
Internal Speakers	57
Split Mode	40
T	
Timers	67-70
Time	67
Tint	54
Treble	57
V	
Video Settings	53-56

END USER LICENSE AGREEMENT FOR HITACHI DTV SOFTWARE

IMPORTANT – READ CAREFULLY: This License Agreement is a legal agreement between you and Hitachi America, Ltd., Home Electronics Division ("HAL-HED"). By using this Hitachi digital television (the "DTV") and its software (the "Software"), you agree to be bound by the terms of this License Agreement. IF YOU DO NOT AGREE TO BE BOUND BY THIS LICENSE AGREEMENT, DO NOT USE THIS DTV AND ITS SOFTWARE.

The Software is protected by copyright laws and international copyright treaties, as well as other intellectual property laws and treaties. The Software is licensed, not sold.

1. LICENSE GRANT. Subject to all of the terms, conditions and restrictions of this License Agreement, HAL-HED grants to you a limited, revocable, non-exclusive right to use one copy of the Software only on one Hitachi labeled DTV owned by you.

2. RIGHTS AND LIMITATIONS. Software Not for Resale. You may not resell or otherwise transfer for value the Software, except that you may transfer the Software as part of a resale of the entire DTV product only. Prohibition on Reverse Engineering, Decompilation, Disassembly and/or Modification. You may not reverse engineer, decompile, disassemble or modify the Software. Separation of Components. The Software is licensed as single product. Its component parts may not be separated for use on more than one DTV. No Transfers. You may not transfer, assign, rent, lease, lend or in any way sublicense the Software. Trademarks. This License Agreement does not grant you any rights to any trademarks. Third Party Software. You shall not use the Software in combination with any third party software.

3. VIOLATIONS; INDEMNITY. You understand that any use, copying or transfer of the Software, except as permitted pursuant to this License Agreement, constitutes a violation of legal rights and may subject you to damages and an award to HAL-HED of attorneys' fees in connection with any violation of this License. You further understand that you may be held legally responsible for any copyright infringement or other violation of intellectual property rights that is caused or encouraged by your failure to abide by the terms of this License Agreement. You agree to defend, indemnify and hold HAL-HED and its parent and affiliate companies harmless from and against any and all liability resulting from any breach by you of this License Agreement and/or any use by you of the Software in combination with third party software.

4. COPYRIGHT. All title and intellectual property rights in and to the Software (including but not limited to any images, photographs, animation, video, audio, music, text, and "applets" incorporated into the Software), and any accompanying printed materials are owned by HAL-HED. All title and intellectual property rights in and to the content which may be accessed through use of the Software is the property of the respective content owner and may be protected by applicable copyright or other intellectual property laws and treaties. This License Agreement grants you no rights to use such content. All rights not expressly granted are reserved by HAL-HED. This provision applies to U.S. Government end-users, who are granted only those rights expressly set forth herein.

5. EXPORT RESTRICTIONS. HAL-HED is licensing the Software for use within the United States only. You agree that you will not export or re-export the Software. You specifically agree not to export or re-export the Software: (i) to any country to which the U.S. has embargoed or restricted the export of goods or services, which currently include, but are not necessarily limited to Cuba, Iran, Iraq, Libya, North Korea, Sudan, and Syria, or to any national of any such country, wherever located, who intends to transmit or transport the Software back to such country; (ii) to any person or entity who you know or have reason to know will utilize the Software in the design, development, or production of nuclear, chemical, or biological weapons; or (iii) to any person or entity who has been prohibited from participating in U.S. export transactions by any federal agency of the U.S. government. You warrant and represent that neither the Bureau of Export Administration (BXA) nor any other U.S. Federal Agency has suspended, revoked, or denied your export privileges.

6. NO WARRANTIES. THE SOFTWARE IS PROVIDED "AS-IS, WHERE-IS." HAL-HED MAKES NO WARRANTIES OF ANY KIND WHATSOEVER REGARDING THE SOFTWARE AND, TO THE MAXIMUM EXTENT PERMITTED BY LAW, HEREBY EXPRESSLY DISCLAIMS ALL WARRANTIES OF ANY KIND WHATSOEVER, EXPRESS OR IMPLIED, WITH RESPECT TO THE SOFTWARE. ALL IMPLIED WARRANTIES, INCLUDING WITHOUT LIMITATION, THE IMPLIED WARRANTIES OF NON-INFRINGEMENT, MERCHANTABILITY AND FITNESS FOR A PARTICULAR PURPOSE ARE HEREBY EXPRESSLY DISCLAIMED TO THE MAXIMUM EXTENT PERMITTED BY LAW.

END USER LICENSE AGREEMENT FOR HITACHI DTV SOFTWARE

7. LIMITATION OF LIABILITY. IN NO EVENT SHALL HAL-HED OR ANY OF ITS PARENT OR AFFILIATE COMPANIES BE LIABLE TO YOU OR ANY THIRD PARTY FOR ANY DIRECT, INDIRECT, INCIDENTAL, SPECIAL, EXEMPLARY, OR CONSEQUENTIAL DAMAGES (INCLUDING, BUT NOT LIMITED TO, PROCUREMENT OF SUBSTITUTE GOODS OR SERVICES; LOSS OF USE, DATA, OR PROFITS; LOSS OF GOODWILL, EXPENDITURES MADE OR COMMITTED FOR IN RELIANCE ON THE CONTINUATION OF THIS LICENSE AGREEMENT OR BUSINESS INTERRUPTION) HOWEVER CAUSED AND ON ANY THEORY OF LIABILITY, WHETHER IN CONTRACT, STRICT LIABILITY, OR TORT (INCLUDING NEGLIGENCE OR OTHERWISE) ARISING IN ANY WAY OUT OF THE USE OF THE SOFTWARE, EVEN IF ADVISED OF THE POSSIBILITY OF SUCH DAMAGE.

8. NO FAILURE OF ESSENTIAL PURPOSE. YOU AGREE THAT NO FAILURE TO REPAIR A DEFECT, ERROR OR BUG IN THE SOFTWARE SHALL CONSTITUTE A FAILURE OF THE ESSENTIAL PURPOSE OF THIS LICENSE AGREEMENT.

9. CRYPTOGRAPHIC SOFTWARE. THIS PRODUCT CONTAINS SOFTWARE DEVELOPED BY THE OpenSSL PROJECT INCLUDING CRYPTOGRAPHIC SOFTWARE WRITTEN BY ERIC YOUNG (THE "CRYPTOGRAPHIC SOFTWARE"). THE CRYPTOGRAPHIC SOFTWARE IS PROVIDED BY THE OpenSSL PROJECT "AS IS" AND ANY EXPRESSED OR IMPLIED WARRANTIES, INCLUDING BUT NOT LIMITED TO, THE IMPLIED WARRANTIES OF MERCHANTABILITY AND FITNESS FOR A PARTICULAR PURPOSE ARE HEREBY EXPRESSLY DISCLAIMED TO THE MAXIMUM EXTENT PERMITTED BY LAW. IN NO EVENT SHALL THE OpenSSL PROJECT, ITS CONTRIBUTORS, HAL-HED OR ANY OF ITS PARENT OR AFFILIATE COMPANIES BE LIABLE FOR ANY DIRECT, INDIRECT, INCIDENTAL, SPECIAL, EXEMPLARY, OR CONSEQUENTIAL DAMAGES (INCLUDING, BUT NOT LIMITED TO, PROCUREMENT OF SUBSTITUTE GOODS OR SERVICES; LOSS OF USE, DATA, OR PROFITS; OR BUSINESS INTERRUPTION) HOWEVER CAUSED AND ON ANY THEORY OF LIABILITY, WHETHER IN CONTRACT, STRICT LIABILITY, OR TORT (INCLUDING NEGLIGENCE OR OTHERWISE) ARISING IN ANY WAY OUT OF THE USE OF THE SOFTWARE OR THE CRYPTOGRAPHIC SOFTWARE, EVEN IF ADVISED OF THE POSSIBILITY OF SUCH DAMAGE.

10. TERMINATION. This License Agreement may be terminated at any time by HAL-HED effective immediately upon notice to you.

11. GOVERNING LAW; SEVERABILITY. This Agreement shall be governed and construed in accordance with the laws of the State of California, without regard to its conflict of laws rules, and any disputes hereunder shall be subject to the exclusive jurisdiction and venue of the U.S. Federal Courts in the Southern District of California. If any part of this License Agreement is unenforceable, the remainder shall be valid and binding to the maximum extent permitted by applicable law.



HITACHI