

Register your product and get support at
www.philips.com/support

32PFL3506



EN User Manual

FR Manuel d'Utilisation

ES Manual del Usuario

EN: For further assistance, call the customer support service in your country.

- To obtain assistance in the U.S.A., Canada, Puerto Rico, or the U.S. Virgin Islands, contact Philips Customer Care Center at **1-866-309-0841**
- To obtain assistance in Mexico, contact Philips Customer Care Center at **01 800 504 62 00**

Enter below the model and serial numbers located on the back and right side of the TV cabinet.

FR: Pour obtenir de l'aide supplémentaire, communiquez avec le centre de service à la clientèle de votre pays.

- Pour obtenir de l'aide aux États-Unis, au Canada, à Puerto Rico ou aux Îles Vierges américaines, communiquez avec le centre de service à la clientèle Philips au : **1-866-309-0841**
- Pour obtenir l'aide au Mexique, entrez en contact avec le centre de soin de client de Philips à **01 800 504 62 00**

Entrer ci dessous le modèle et le numéro de série situés derrière à droite sur le dos du téléviseur.

ES: Para obtener más información, llame al servicio de soporte al cliente de su país.

- Para obtener asistencia en los Estados Unidos, en Canadá, Puerto Rico o en las Islas Vírgenes de los Estados Unidos, comuníquese con Centro de atención al cliente de Philips al **1-866-309-0841**
- Solo para México CENTRO DE ATENCIÓN A CLIENTES LADA. **01 800 504 62 00** Solo Para México.

Escriba a continuación el modelo y número de serie que están localizados en lado derecho y parte posterior de el gabinete de el televisor.

Lea esta manual antes de usar el producto

MODEL NUMBER

SERIAL NUMBER

PHILIPS

Contents

1 Notice	4	9 Connect devices	27
		Connection overview	27
2 Important	5	Selecting your connection quality	28
Product information	5	Connecting your devices	29
Screen care	5		
Environmental care	5	10 Troubleshooting	31
Regulatory notices	5	Downloading an electronic copy	31
		Contact us	31
3 Your TV	6		
Side controls and indicators	6	11 Notes for the use of USB devices	32
Remote control	6		
		12 Specifications	32
4 Get started	8		
Supplied accessories	8	13 Warranty	33
Mounting stand onto TV	8		
Positioning the TV	8		
Installing the remote control batteries	8	14 Index	34
Connecting the antenna or cable	9		
Managing cables	10		
Plugging in the AC power cord	10		
Switching on and initial setup	11		
5 Use your TV	12		
Switching on your TV and putting it in standby mode	12		
Switching channels	12		
Adjusting volume	13		
Still mode	13		
Watching channels from a set-top box	13		
Watching connected devices	13		
Watching a Blu-ray disc	14		
Switching audio mode	14		
6 Use more of your TV	15		
Changing picture and sound settings	15		
Sleeptimer	18		
Child and rating locks	18		
Closed caption	20		
EasyLink	21		
ECO	21		
Set your location to home	21		
View photos, play music and watch videos on a USB storage device	22		
7 Install channels	24		
Selecting your menu language	24		
Autoprogram	24		
Channel list	25		
Add channels	25		
Optimizing the signal quality from your antenna	25		
8 Upgrade your TV software	26		
Checking your current software version	26		
Preparing for the software upgrade	26		
Upgrading software	26		

Return your Product Registration Card or register online at www.philips.com/support today to get the very most from your purchase.

Registering your model with Philips makes you eligible for all of the valuable benefits listed below, so don't miss out. Complete and return your Product Registration Card at once, **or register online at www.philips.com/support** to ensure:

*Product Safety Notification

By registering your product, you'll receive notification - directly from the manufacturer - in the rare case of a product recall or safety defect.

*Additional Benefits

Registering your product guarantees that you'll receive all of the privileges to which you're entitled, including special money-saving offers.

Know these **safety symbols**



This "bolt of lightning" indicates uninsulated material within your unit may cause an electrical shock. For the safety of everyone in your household, please do not remove product covering.



The "exclamation point" calls attention to features for which you should read the enclosed literature closely to prevent operating and maintenance problems.

WARNING: To reduce the risk of fire or electric shock, this apparatus should not be exposed to rain or moisture and objects filled with liquids, such as vases, should not be placed on this apparatus.

CAUTION: To prevent electric shock, match wide blade of plug to wide slot, fully insert.

ATTENTION: Pour éviter les choc électriques, introduire la lame la plus large de la fiche dans la borne correspondante de la prise et pousser jusqu'au fond.

PHILIPS

Visit our World Wide Web Site at <http://www.philips.com/support>

CHILD SAFETY:

It Makes A Difference How and Where You Use Your Flat Panel Display

Congratulations on your purchase! As you enjoy your new product, please keep these safety tips in mind:

THE ISSUE

- The home theater entertainment experience is a growing trend and larger flat panel displays are popular purchases. However, flat panel displays are not always supported on the proper stands or installed according to the manufacturer's recommendations.
- Flat panel displays that are inappropriately situated on dressers, bookcases, shelves, desks, speakers, chests or carts may fall over and cause injury.

THIS MANUFACTURER CARES!

- The consumer electronics industry is committed to making home entertainment enjoyable and safe.



TUNE INTO SAFETY

- One size does NOT fit all. Follow the manufacturer's recommendations for the safe installation and use of your flat panel display.
- Carefully read and understand all enclosed instructions for proper use of this product.
- Don't allow children to climb on or play with furniture and television sets.
- Don't place flat panel displays on furniture that can easily be used as steps, such as a chest of drawers.
- Remember that children can become excited while watching a program, especially on a "larger than life" flat panel display. Care should be taken to place or install the display where it cannot be pushed, pulled over, or knocked down.
- Care should be taken to route all cords and cables connected to the flat panel display so that they cannot be pulled or grabbed by curious children.



WALL MOUNTING: IF YOU DECIDE TO WALL MOUNT YOUR FLAT PANEL DISPLAY, ALWAYS:

- Use a mount that has been recommended by the display manufacturer and/or listed by an independent laboratory (such as UL, CSA, ETL).
- Follow all instructions supplied by the display and wall mount manufacturers.
- If you have any doubts about your ability to safely install your flat panel display, contact your retailer about professional installation.
- Make sure that the wall where you are mounting the display is appropriate. Some wall mounts are not designed to be mounted to walls with steel studs or old cinder block construction. If you are unsure, contact a professional installer.
- A minimum of two people are required for installation. Flat panel displays can be heavy.

 **CEA**
Consumer Electronics Association
www.CE.org/safety

IMPORTANT SAFETY INSTRUCTIONS

Read before operating equipment

1. Read these instructions.
2. Keep these instructions.
3. Heed all warnings.
4. Follow all instructions.
5. Do not use this apparatus near water.
6. Clean only with a dry cloth.
7. Do not block any of the ventilation openings. Install in accordance with the manufacturer's instructions.
8. Do not install near any heat sources such as radiators, heat registers, stoves, or other apparatus (including amplifiers) that produce heat.
9. Do not defeat the safety purpose of the polarized or grounding-type plug. A polarized plug has two blades with one wider than the other. A grounding type plug has two blades and third grounding prong. The wide blade or third prong are provided for your safety. When the provided plug does not fit into your outlet, consult an electrician for replacement of the obsolete outlet.
10. Protect the power cord from being walked on or pinched particularly at plugs, convenience receptacles, and the point where they exit from the apparatus.
11. Only use attachments/accessories specified by the manufacturer.
12.  Use only with a cart, stand, tripod, bracket, or table specified by the manufacturer, or sold with the apparatus. When a cart is used, use caution when moving the cart/apparatus combination to avoid injury from tip-over.
13. Unplug this apparatus during lightning storms or when unused for long periods of time.
14. Refer all servicing to qualified service personnel. Servicing is required when the apparatus has been damaged in any way, such as power-supply cord or plug is damaged, liquid has been spilled or objects have fallen into apparatus, the apparatus has been exposed to rain or moisture, does not operate normally, or has been dropped.
15. This product may contain lead or mercury. Disposal of these materials may be regulated due to environmental considerations. For disposal or recycling information, please contact your local authorities or the Electronic Industries Alliance: www.eiae.org.
16. **Damage Requiring Service** - The appliance should be serviced by qualified service personnel when:
 - A. The power supply cord or the plug has been damaged; or
 - B. Objects have fallen, or liquid has been spilled into the appliance; or
 - C. The appliance has been exposed to rain; or
 - D. The appliance does not appear to operate normally or exhibits a marked change in performance; or
 - E. The appliance has been dropped, or the enclosure damaged.
17. **Tilt/Stability** - All televisions must comply with recommended international global safety standards for tilt and stability properties of its cabinets design.
 - Do not compromise these design standards by applying excessive pull force to the front, or top, of the cabinet which could ultimately overturn the product.
 - Also, do not endanger yourself, or children, by placing electronic equipment/toys on the top of the cabinet. Such items could unsuspectingly fall from the top of the set and cause product damage and/or personal injury.
18. **Wall or Ceiling Mounting** - The appliance should be mounted to a wall or ceiling only as recommended by the manufacturer.
19. **Power Lines** - An outdoor antenna should be located away from power lines.
20. **Outdoor Antenna Grounding** - If an outside antenna is connected to the receiver, be sure the antenna system is grounded so as to provide some protection against voltage surges and built up static charges. Section 810 of the National Electric Code, ANSI/NFPA No. 70-1984, provides information with respect to proper grounding of the mats and supporting structure grounding of the lead-in wire to an antenna-discharge unit, size of grounding connectors, location of antenna-discharge unit, connection to grounding electrodes and requirements for the grounding electrode. See Figure below.
21. **Objects and Liquid Entry** - Care should be taken so that objects do not fall and liquids are not spilled into the enclosure through openings.
 - a) Warning: To reduce the risk of fire or electric shock, this apparatus should not be exposed to rain or moisture and objects filled with liquids, such as vases should not be placed on this apparatus.
22. **Battery Usage CAUTION** - To prevent battery leakage that may result in bodily injury, property damage, or damage to the unit:
 - Install all batteries correctly, with + and - alignment as marked on the unit.
 - Do not mix batteries (old and new or carbon and alkaline, etc.)
 - Remove batteries when the unit is not used for a long time.

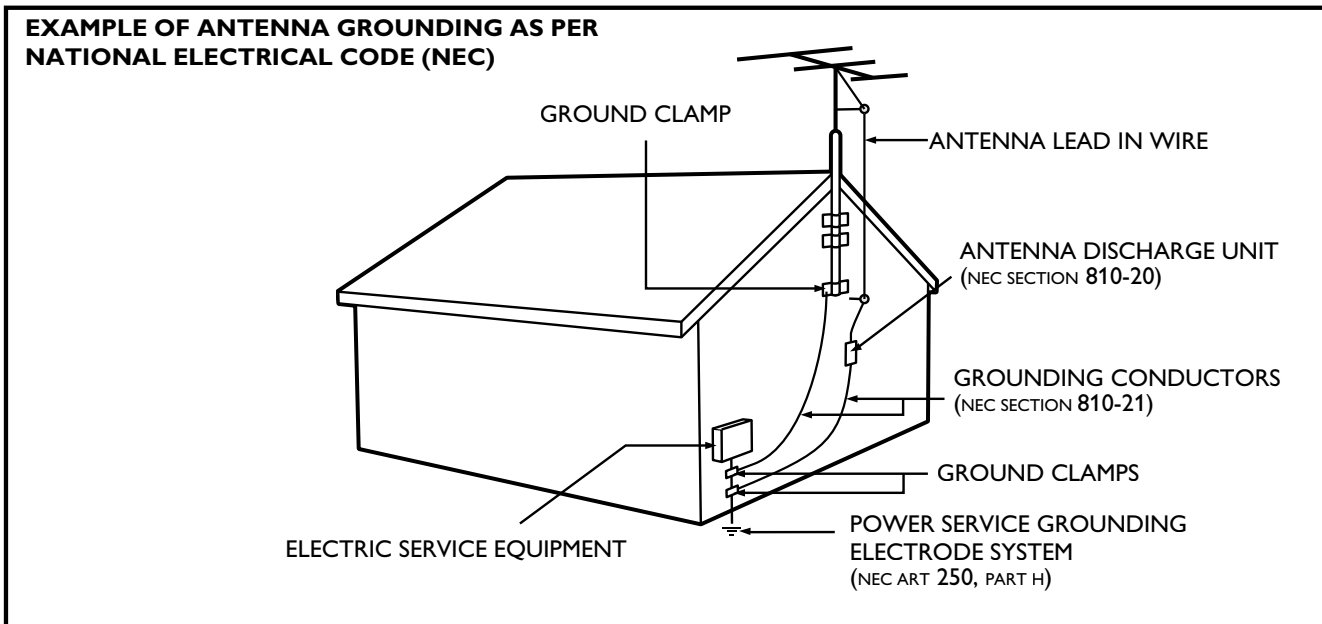

Note to the CATV system installer: this reminder is provided to call the CATV system installer's attention to Article 820-40 of the NEC that provides guidelines for proper grounding and, in particular, specifies that the cable ground shall be connected to the grounding system of the building, as close to the point of cable entry as practical.

1 Notice

Specifications are subject to change without notice. Trademarks are the property of Koninklijke Philips Electronics N.V. or their respective owners. P&F USA reserves the right to change products at any time without being obliged to adjust earlier supplies accordingly.

The material in this manual is believed adequate for the intended use of the system. If the product, or its individual modules or procedures, are used for purposes other than those specified herein, confirmation of their validity and suitability must be obtained. P&F USA warrants that the material itself does not infringe any United States patents. No further warranty is expressed or implied.

P&F USA cannot be held responsible neither for any errors in the content of this document nor for any problems as a result of the content in this document. Errors reported to P&F USA will be adapted and published on the P&F USA support website as soon as possible.

Pixel characteristics

This LCD product has a high number of color pixels. Although it has effective pixels of 99.999% or more, black dots or bright points of light (red, green or blue) may appear constantly on the screen. This is a structural property of the display (within common industry standards) and is not a malfunction.

Warranty

No components are user serviceable. Do not open or remove covers to the inside of the product. Repairs may only be done by Service Centers and official repair shops. Failure to do so shall void any warranty, stated or implied.

Any operation expressly prohibited in this manual, any adjustments, or assembly procedures not recommended or authorized in this manual shall void the warranty.

Federal Communications Commission Notice

This equipment has been tested and found to comply with the limits for a Class B digital device, pursuant to part 15 of the FCC Rules. These limits are designed to provide reasonable protection against harmful interference in a residential installation. This equipment generates, uses, and can radiate radio frequency energy and, if not installed and used in accordance with the instructions, may cause harmful interference to radio communications. However, there is no guarantee that interference will not occur in a particular installation. If this equipment does cause harmful interference to radio or television reception, which can be determined by turning the equipment off and on, the user is encouraged to try to correct the interference by one or more of the following measures:

- Reorient or relocate the receiving antenna.
- Increase the separation between the equipment and the receiver.
- Connect the equipment into an outlet on a circuit different from that to which the receiver is connected.
- Consult the dealer or an experienced radio or television technician for help.

Declaration of Conformity

Trade Name: PHILIPS
Responsible Party: P&F USA, Inc.
Model: 32PFL3506
Address: PO Box 430 Daleville, IN 47334-0430 U.S.A.
Telephone Number: 1-866-309-0841

Modifications

The FCC requires the user to be notified that any changes or modifications made to this device that are not expressly approved by Philips Consumer Electronics may void the user's authority to operate the equipment.

Cables

Connections to this device must be made with shielded cables with metallic RFI/EMI connector hoods to maintain compliance with FCC Rules and Regulations.

Canadian notice

Standard Television Receiving Apparatus, Canada BETS-7/NTMR-7. This Class B digital apparatus meets all requirements of the Canadian Interference-Causing Equipment Regulations.

Copyright

All other registered and unregistered trademarks are the property of their respective owners.



HDMI, the HDMI Logo, and High-Definition Multimedia Interface are trademarks or registered trademarks of HDMI Licensing LLC in the United States and other countries.



Manufactured under license from Dolby Laboratories. Dolby and the double-D symbol are trademarks of Dolby Laboratories.



©Kensington and Micro Saver are registered US trademarks of ACCO World corporation with issued registrations and pending applications in other countries throughout the world.

Portions of this software are copyright © The FreeType Project (www.freetype.org).

The American Academy of Pediatrics discourages television viewing for children younger than two years of age.

2 Important

Registering your model with Philips makes you eligible for all of the valuable benefits listed below, so don't miss out. Complete and return your Product Registration Card at once, or register online at www.philips.com/support to ensure:

- **Product Safety Notification**
By registering your product you receive notification - directly from the manufacturer - in the rare case of a product recall or safety defect.
- **Additional Benefits of Product Ownership**
Registering your product guarantees that you receive all of the privileges to which you're entitled, including special money-saving offers.

For further assistance

For further assistance, call the customer support service in your country.

- To obtain assistance in the U.S.A., Canada, Puerto Rico, or the U.S. Virgin Islands, contact Philips Customer Care Center at **1-866-309-0841**

Product information

This TV consumes minimal energy in standby mode to minimize environmental impact. The active power consumption is given on the type plate at the back of the TV. The model and serial numbers of your TV can be found on the back and right side of the TV as well as on the packaging.

Screen care

- Avoid stationary images as much as possible. Stationary images are images that remain on-screen for extended periods of time. Examples include: on-screen menus, black bars and time displays. If you must use stationary images, reduce screen contrast and brightness to avoid screen damage.
- Unplug the TV before cleaning.
- Clean the TV screen and frame with a soft cloth. Never use substances such as alcohol, chemicals or household cleaners on the TV screen.
- Risk of damage to the TV screen! Never touch, push, rub or strike the screen with any object.
- To avoid deformations and color fading, wipe off water drops as soon as possible.

Environmental care

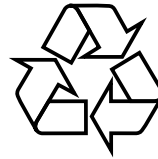

The packaging of this product is intended to be recycled. Contact your local authorities for information about how to recycle the packaging.

For product recycling information, please visit - www.recycle.philips.com

End of life directives



This LCD TV contains a lamp with Mercury, please dispose of according to all local, state and federal laws.

Philips pays a lot of attention to produce environment-friendly products in green focal areas. Your new TV contains materials which can be recycled and reused. At the end of its life, specialized companies can dismantle the discarded TV to concentrate the reusable materials and to minimize the amount of materials to be disposed of. Please ensure you dispose of your old TV according to local regulations.

Disposal of used batteries

The batteries supplied do not contain the heavy metals mercury and cadmium. Nevertheless, in many areas batteries may not be disposed of with your household waste. Please ensure you dispose of batteries according to local regulations.

Regulatory notices

Warning

To reduce the risk of fire or electric shock, this apparatus should not be exposed to rain or moisture. Objects filled with liquids, such as vases, should not be placed on this apparatus.

Caution

To prevent electric shock, match the wide blade of the plug to the wide slot, fully inserted.

Do not place the unit on the furniture that is capable of being tilted by a child and an adult leaning, pulling, standing or climbing on it. A falling unit can cause serious injury or even death.

This apparatus should not be placed in a built-in installation such as a bookcase or rack unless proper ventilation is provided. Make sure to leave a space of 4 inches (10cm) or more around this apparatus.

3 Your TV

Congratulations on your purchase, and welcome to Philips! To fully benefit from the support that Philips offers, register your product at www.philips.com/support

Side controls and indicators

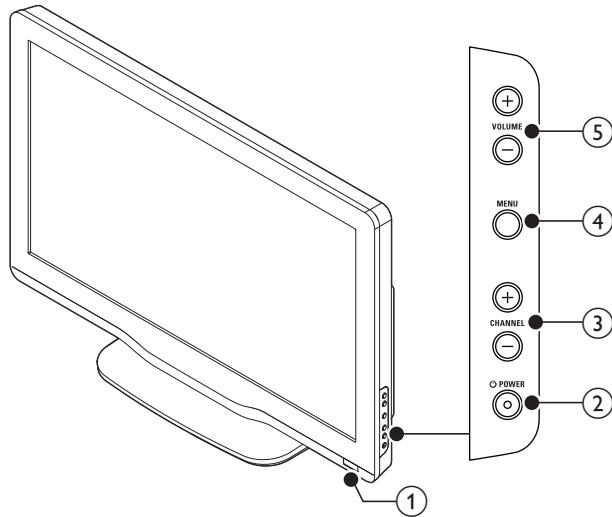

- ① Standby indicator/remote control sensor
- ② **POWER**
Switches the TV on or puts it in standby mode. The TV is not powered off completely unless it is physically unplugged.
- ③ **CHANNEL +/-**
Switches to the next or previous channel.
- ④ **MENU**
Toggles the main menu on or off.
- ⑤ **VOLUME +/-**
Increases or decreases volume.

Remote control

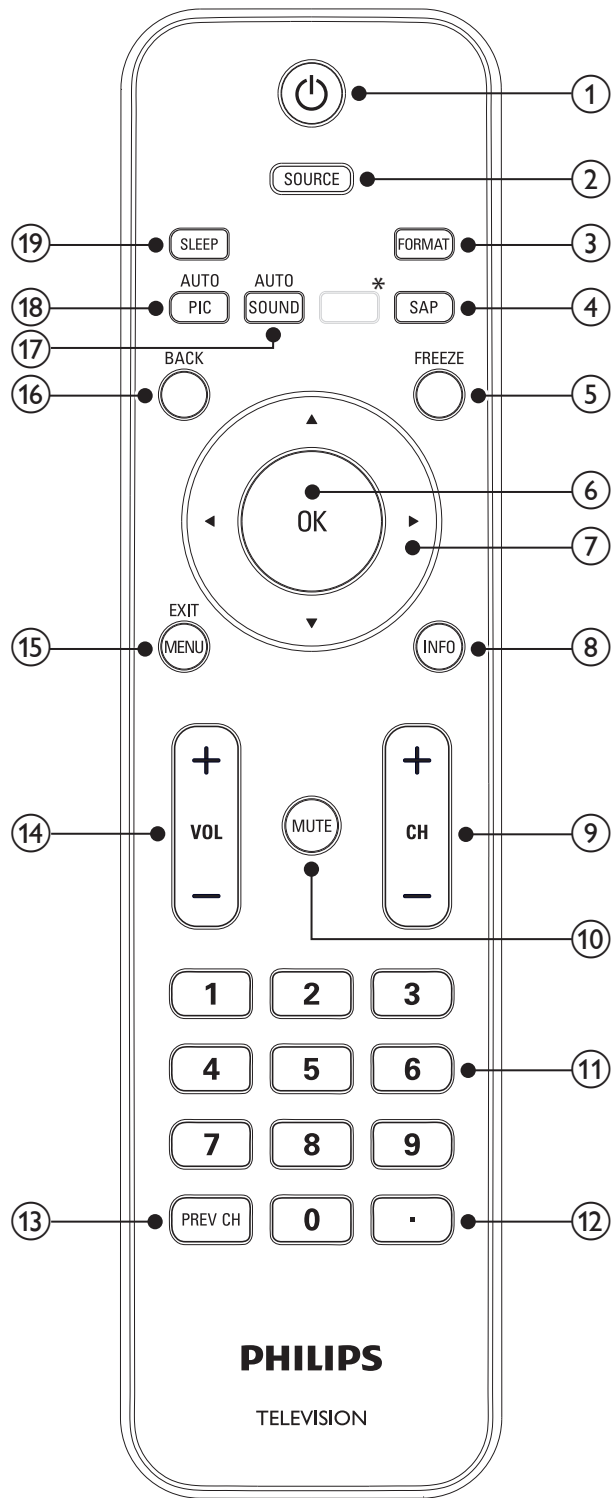

*This button does not function on this unit.

- ① **⏻ (Standby-On)**
Switches the TV on or puts it in standby mode. The TV is not powered off completely unless it is physically unplugged.
- ② **SOURCE**
Selects connected devices.
- ③ **FORMAT**
Selects a picture format (see 'Changing picture format' on page 16).
- ④ **SAP**
Digital Mode (DTV)
 - Press to select the audio language.**Analog Mode (TV)**
 - Press to select the audio mode.
- ⑤ **FREEZE**
Press to pause screen image.
- ⑥ **OK**
Activates a selection or accesses the menu.
- ⑦ **▲▼◀▶ (Navigation buttons)**
Navigates through the menus.
- ⑧ **INFO**
Displays information about the TV channel or accessory device.
The quality and accuracy of the information depends on the broadcaster. You might see a difference in broadcast time if the broadcast is from a different time zone.
- ⑨ **CH +/-**
Switches to the next or previous channel.
- ⑩ **MUTE**
Mutes or unmutes audio.
- ⑪ **Number buttons**
Select a channel, page or setting.
- ⑫ **• (Dot)**
Press the dot (•) for digital channels.
- ⑬ **PREV CH**
Returns to the previously viewed channel.
- ⑭ **VOL +/-**
Increases or decreases volume.
- ⑮ **MENU/EXIT**
Turns the menu on or off.
- ⑯ **BACK**
Returns to a previous screen.
- ⑰ **AUTO SOUND**
Cycles through preset sound settings
(see 'Changing auto sound mode' on page 17).
- ⑱ **AUTO PIC**
Cycles through preset picture settings
(see 'Changing auto picture mode' on page 15).
- ⑲ **SLEEP**
Sets a delay after which the TV switches to standby.

4 Get started

Supplied accessories

- Remote Control
- 2 x AAA, 1.5V Batteries
- M4 x 14 double sems screw x 3
- Cable management tie
- User Manual
- Quick Start Guide

Mounting stand onto TV

Applicable to TVs without mounted stands.

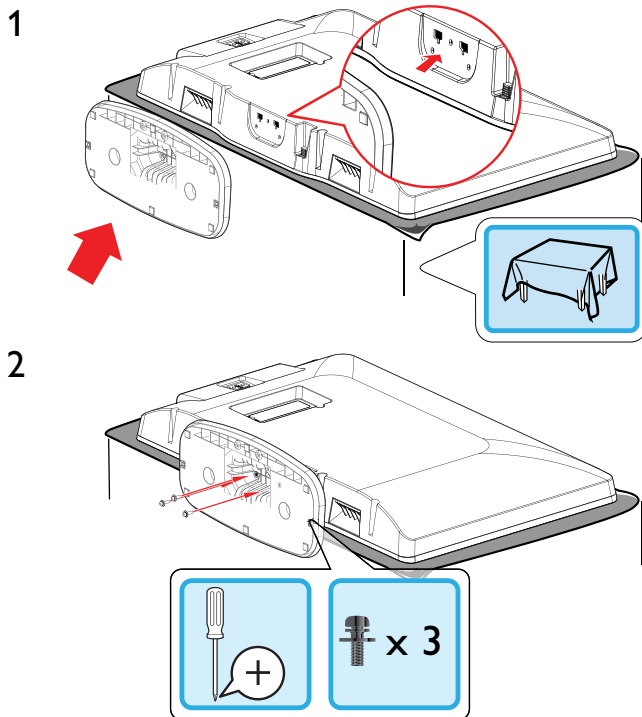

Note

- To wall mount the TV, refer to the Quick Start Guide.
- If you lose the stand mounting screws, please purchase 3 Phillips head screws (M4 x 14) at your local store.

Positioning the TV

Warning

- Do not insert the AC power cord into the power socket outlet before all the connections are made.
- Large screen TVs are heavy. 2 people are required to carry and handle a large screen TV.
- Before you move the TV, disconnect attached cables to prevent damage to connectors.

In addition to reading and understanding safety instructions, consider the following before positioning your TV:

- Ensure that you always have easy access to the AC power cord or plug to disconnect the TV from the power.
- If the TV is mounted on a swivel base, ensure that no strain is placed on the AC power cord when the TV is swiveled. Strain on the AC power cord can loosen connections.
- The ideal viewing distance for watching TV is three times its screen size.
- Position the TV where light does not fall on the screen.
- Connect your devices before you position the TV.

Using a Kensington lock

There is a Kensington security slot on the back of the TV. Prevent theft by looping a Kensington lock between the slot and a permanent object, such as a heavy table.

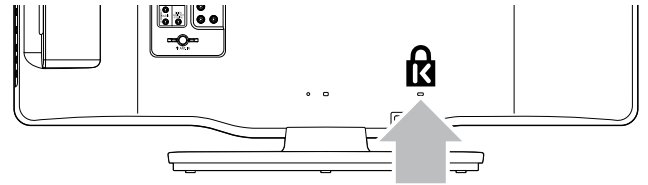

Installing the remote control batteries

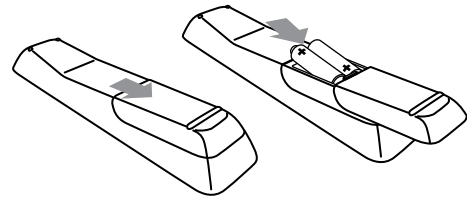

- 1 Slide the battery cover off the back of the remote control.
- 2 Insert the 2 supplied batteries (AAA, 1.5V). Be sure the + and - ends of the batteries line up with the markings inside the case.
- 3 Slide the cover back into position.

Note

- Remove the batteries if not using the remote control for an extended period of time.

Connecting the antenna or cable

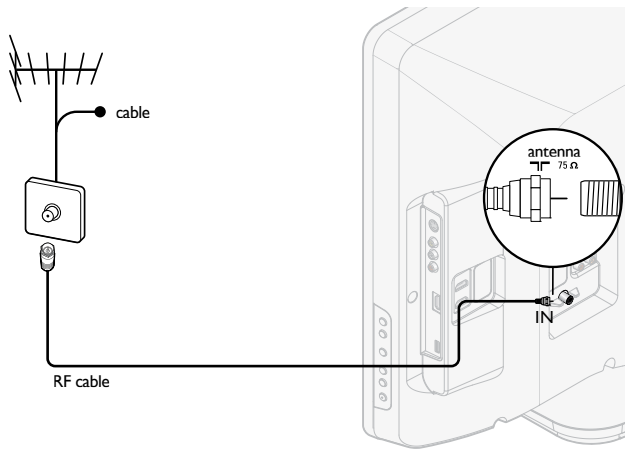

If you connect a set-top box through RF IN/OUT

If the TV is connected to a cable box or satellite set-top box via a coaxial connection, set the TV to channel 3 or 4, or to the channel specified by the service provider.

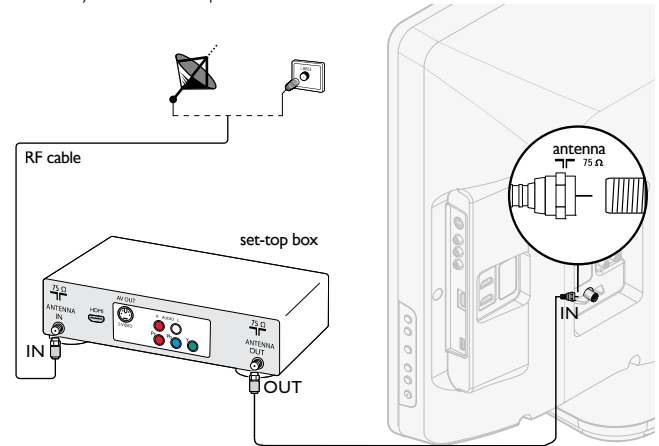

If you connect to an antenna

Any DTV programs that are broadcast in your area can be received for free through an antenna connection.

Contact your local content provider or your local electronics retailer if you are unsure about what HDTV programs are available in your area.

Broadcasters are transitioning from analog to digital TV. This means that a given broadcaster can have channels available either in analog or in digital, or both analog and digital at the same time.

The TV produces stereo sound only if a stereo signal is broadcast.

If you connect to a cable

When your TV is connected to the cable socket, you might receive free digital and high definition programs (depending on your cable provider). The channel number for digital and high definition channels includes a dot ".". For example, 11.1, 46.30, 108.201. Contact your cable provider for more information.

If you connect to a DBS (Direct Broadcast Satellite)

There are two main DBS systems: DirecTV and DishNetwork. These systems require a separate, proprietary set-top box to decode signals and send them to the TV. The set-top box contains a digital TV tuner for receiving off-air digital broadcasts.

Contact your local DBS provider for more information about the connections and the TV channels.

If you connect to a set-top box

A cable box or satellite set-top box can be connected to the TV through the following connections:

- ANT
- A/V (Composite Video and Audio)
- S-Video
- YPbPr (Component Video Input)
- HDMI

For information about how to connect a set-top box, see the Quick Start Guide provided.

If you connect a set-top box through HDMI

If the TV is connected to a cable box or satellite set-top box via HDMI, make sure you select the correct HDMI source by using **SOURCE** on this unit's remote control.

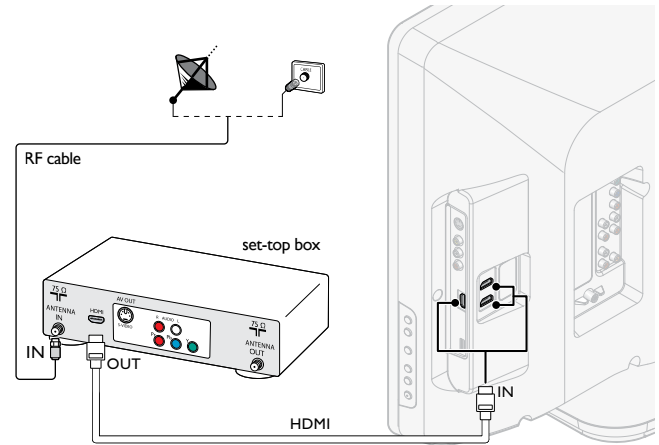

If you connect a set-top box through component video input

If the TV is connected to a cable box or satellite set-top box via component video input, make sure you select the correct component video source by using **SOURCE** on this unit's remote control.

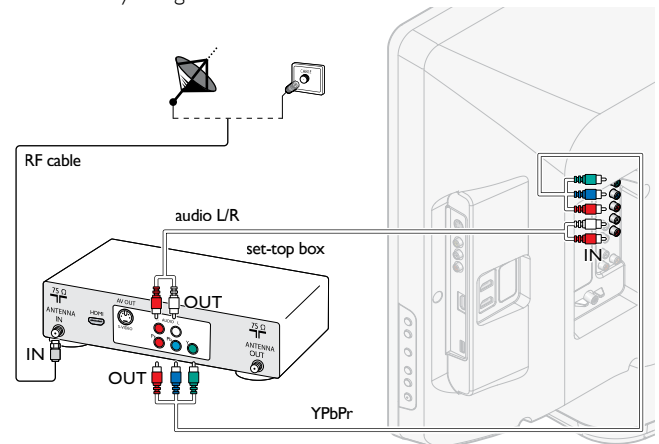

Managing cables

Route your antenna cable and all other cables through the cable management tie at the back of the TV. The holder helps keep your cables tidy and easily manageable.

- 1 Attach the cable management tie as illustrated below.

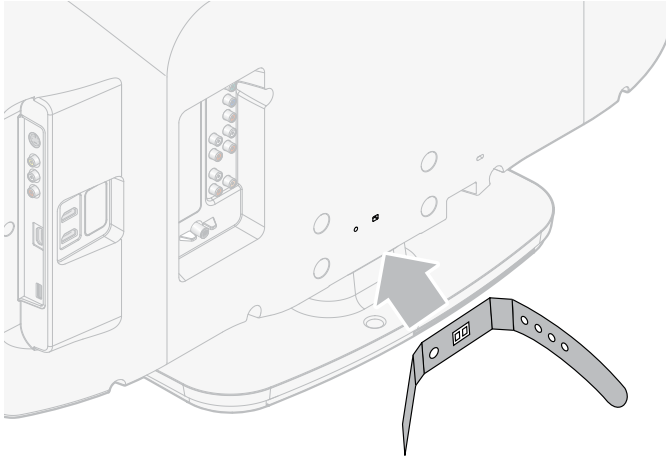

- 2 Pass cables through the cable management tie to avoid tangles.

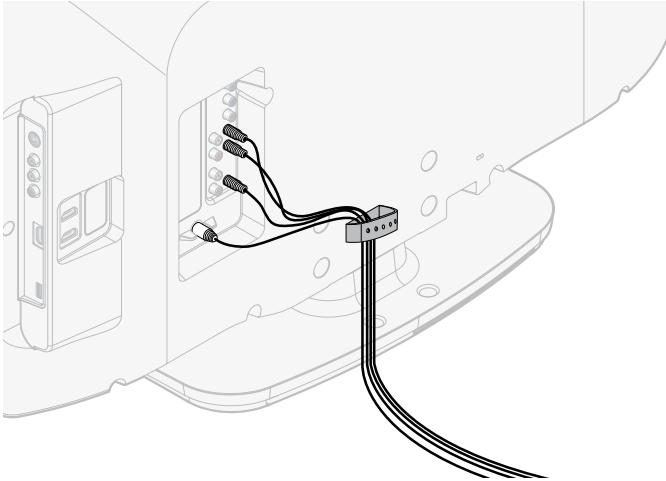

Plugging in the AC power cord

Warning

- Verify that your power voltage corresponds with the voltage printed at the back of the TV. Do not insert the AC power cord if the voltage is different.

Connect the AC power cord plug to the power outlet. Ensure that the cord is tightly secured.

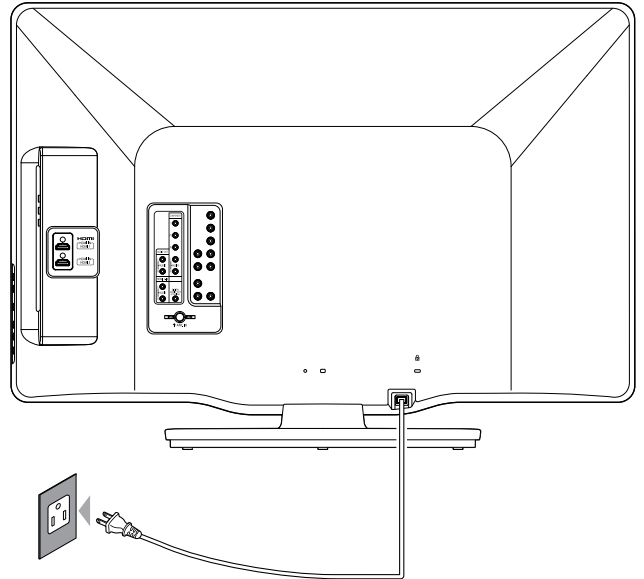

Switching on and initial setup

Before you switch on the TV, check that the AC power cord is properly connected. Press **POWER** at the right side of the TV, or press **POWER** on the remote control. The TV normally takes 25-30 seconds to start up and the following screen appears the first time you turn on the TV.

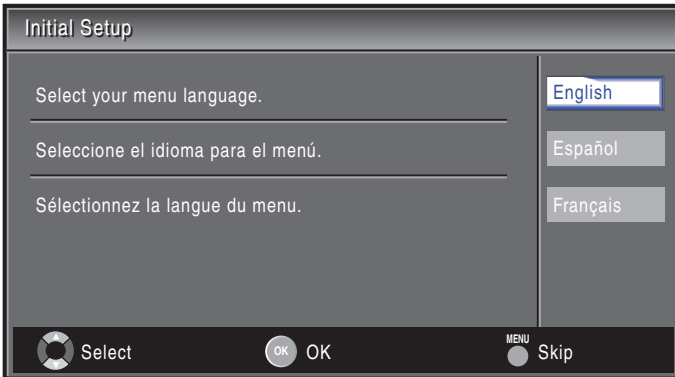

Follow the on-screen instructions to select your language and complete your TV setup. Installation takes approximately 10 minutes.

Press **Left** or **Right** to select the desired mode for energy saving, then press **OK**.

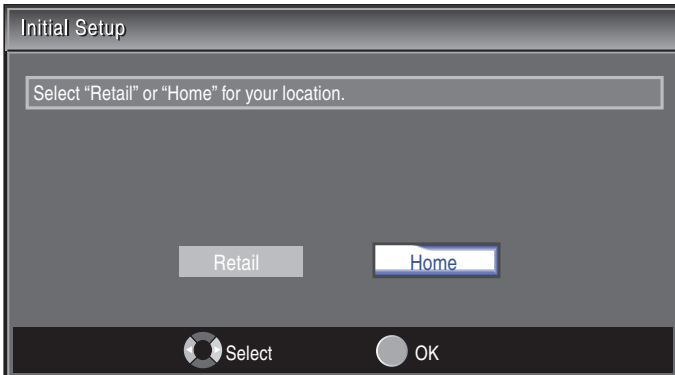

Select **[Retail]** if you want backlight to be brighter.

Select **[Home]** to reduce power consumption.

You must set **[Home]**. Otherwise, personalized picture and sound settings will not be memorized after the unit goes to standby mode.

- Select **[Retail]**, the unit will be set up with predefined setting for retail displays.
- Select **[Home]**, the unit will be set to maximize energy efficiency. Picture and sound settings can be adjusted and saved as per your personal preferences.

Press **OK** to begin **[Settings assistant]**.

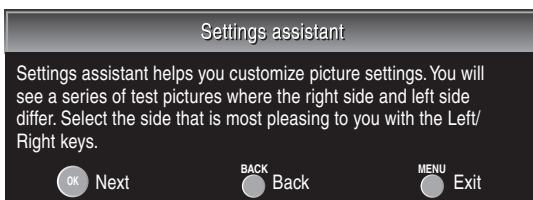

Press **Left** or **Right** 5 times to select the side of the pictures that is the most pleasing to you, then press **OK**.

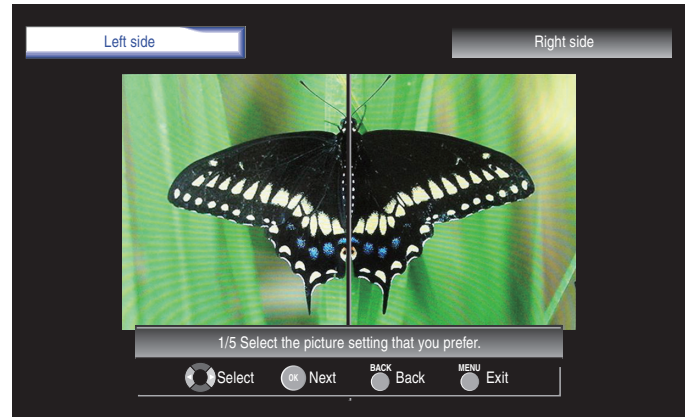

Press **OK** to finish **[Settings assistant]**.

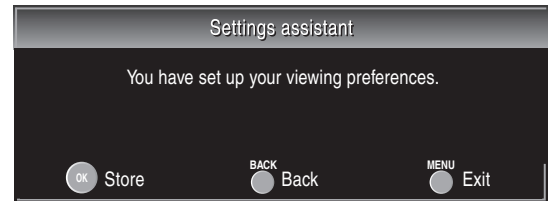

Finish the Setup.

Note

- If you are not receiving a signal from your cable service, contact the CATV provider.
- If you press **POWER** or **MENU** during autoprogram, this setting will be canceled.
- The initial autoprogram function can be executed for either **[Antenna]** or **[Cable]** only once. When you change the connection (Antenna/Cable), set autoprogram again. (Refer to page 24.)
- If there is no signal input from the antenna terminal and no operation for several seconds after you turn on the TV, **[Helpful Hints]** appears. Follow the instructions listed on the TV screen.

5 Use your TV

This section helps you perform basic TV operations.

Switching on your TV and putting it in standby mode

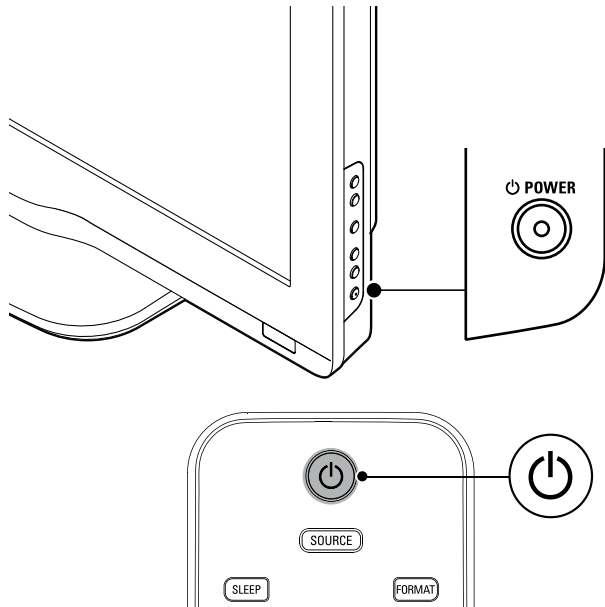

To switch on

- Press **POWER** at the side of the TV or press **Standby-On** on the remote control.

To switch to standby

- Press **POWER** at the side of the TV or press **Standby-On** on the remote control again.

Note

- Energy consumption contributes to air and water pollution. When the AC power cord is plugged in, your TV consumes energy. Your TV has very low standby power consumption.

Switching channels

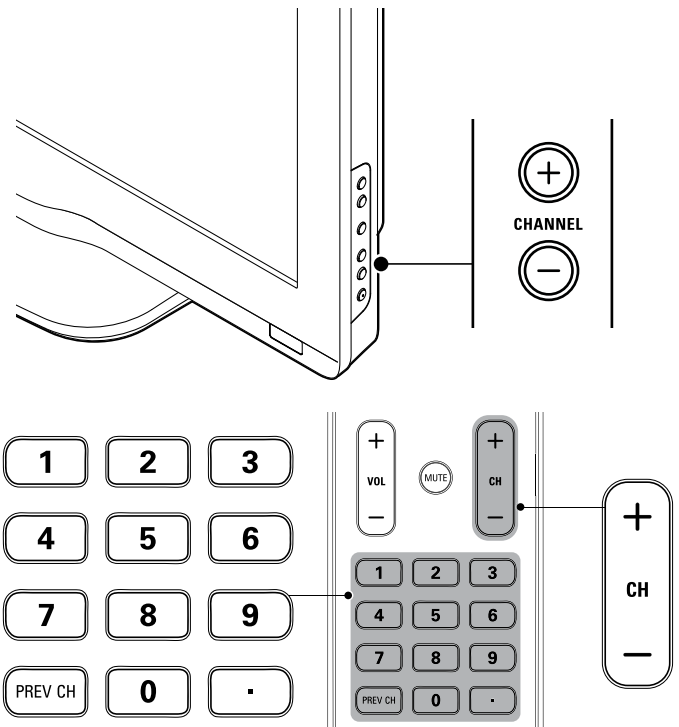

Press **CHANNEL +/-** on the side of the TV. For digital channels, press a number (1 to 135) followed by a dot "." and then the corresponding sub channel number (1 to 135). e.g. 108.30.

- Press **CH +/-** or enter a number on the remote control.
- Press **PREV CH** to return to the previously viewed channel.

Adjusting volume

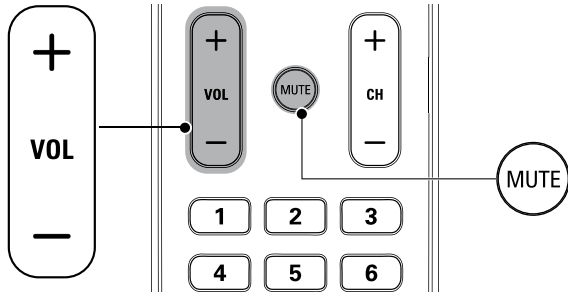
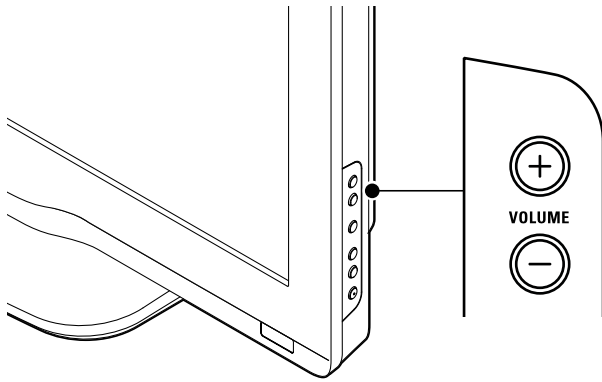

To increase or decrease volume

- Press **VOL +/-** on the remote control or press **VOLUME +/-** on the side of the TV.

To mute or unmute sound

- Press **MUTE** on the remote control to mute the sound.
- Press **MUTE** again or **VOL +/-** to recover the original sound.

Still mode

You can pause the image shown on the TV screen.

Press **FREEZE** to pause the image shown on the TV screen.



- The sound output will not be paused.
- If no signal is detected or protected signal is received during still mode, the image remains paused and the sound output will be muted.
- The still function will be released after 5 minutes.

To cancel still mode, press any button except **⏻ (standby-On)**.

Watching channels from a set-top box

To watch channels from a set-top box

- 1 Switch on the set-top box.
 - ↳ The picture from your set-top box might appear automatically on the TV screen.
- 2 Use the remote control of your set-top box to select channels.

If the picture does not appear

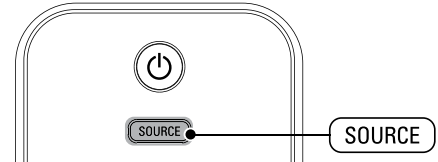

- 1 Press **SOURCE** repeatedly to select the set-top box and wait a few seconds for the picture to appear.
- 2 Use the remote control of your set-top box to select channels.

Watching connected devices

To watch connected devices

- 1 Switch on the connected device.
 - ↳ The picture from your connected device might appear automatically on the TV screen.
- 2 Use the remote control of the device to select channels.

If the picture does not appear

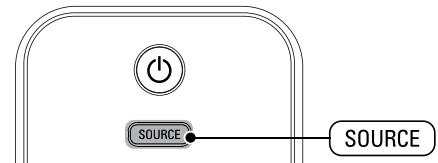

- 1 Press **SOURCE** repeatedly to select the connected device and wait a few seconds for the picture to appear.
- 2 Use the remote control of the device to select channels.

Automatic Power Shut Off

If there is no input signal and no operation for 15 minutes, the unit will turn off automatically.

Watching a Blu-ray disc

To watch a Blu-ray Disc

- 1 Insert a Blu-ray Disc into your player.
- 2 Press **▶ (play)** on the remote control of the Blu-ray Disc player.
↳ The Blu-ray Disc might automatically play on the TV.

If the picture does not appear

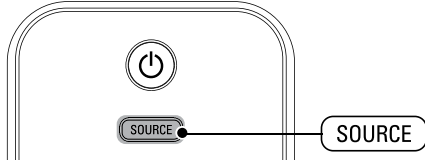

- 1 Press **SOURCE** repeatedly to select the Blu-ray Disc player and wait a few seconds for the picture to appear.
- 2 Use the remote control of the Blu-ray Disc player to play the disc.

Switching audio mode

This section describes how to switch audio language in digital mode and how to switch audio in analog mode.

DTV

- 1 Press **SAP** to display the currently selected language and the number of available languages.



- 2 Press **SAP** repeatedly to cycle through the available audio languages.
 - Available languages differ depending on the broadcast. **[Other]** is displayed when the audio language cannot be acquired, or the acquired languages are other than English, Spanish or French.

Note

- **SAP** does not control external audio devices.
- The information display will automatically disappear in a few seconds.

TV

Press **SAP** to display the currently selected audio mode. While receiving an MTS broadcast, press repeatedly to cycle through the available audio channel.



When all audio are available



When stereo and monaural audio are available



When SAP and monaural audio are available



When only monaural audio is available



- STEREO** : Outputs stereo-audio
SAP : Outputs second audio program
MONO : Outputs mono-audio

6 Use more of your TV

Changing picture and sound settings

You must set **[Home]** in **[Location]** (refer to page 21). Otherwise, personalized picture and sound settings will not be memorized after the unit goes to standby mode.

Changing picture settings

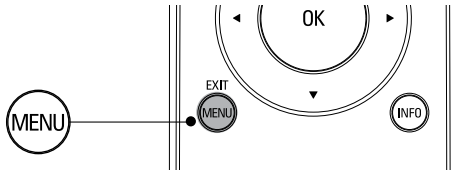

- 1 Press **MENU** on the remote control.
- 2 Press **OK** to enter the **[Picture]**.

PHILIPS	
Picture	Settings assistant
Sound	Auto Picture
Setup	Brightness
Features	Contrast
Language	Color
USB	Tint
	Sharpness
	Color Temperature
	Noise Reduction
	Personal
	30
	60
	36
	0
	0
	Normal
	On

- 3 Press **▲** or **▼** to select one of the picture settings, and press **OK** to enter the setting.

- 4 Adjust the picture quality.

[Auto Picture]

Press **▲** or **▼** to select the desired setting, then press **OK**. (**[Personal]**, **[Standard]**, **[Sports]**, **[Movie]** and **[Game]**)

[Brightness], **[Contrast]**, **[Color]**, **[Tint]**, **[Sharpness]**, **[Color Temperature]**

Press **▲** or **▼** to select the desired setting, then Press **◀** or **▶** to adjust.

[Noise Reduction]

Reduces the noise of the picture.

Press **▲** or **▼** to select the desired option, then press **OK**.

On	Reduces noise in an image.
Off	Sets noise reduction to off.

Note

- This function is disabled when PC input is selected. (Setting will be in gray.)

- 5 Press **MENU** to exit.

Note

- To cancel picture adjustment, press **MENU**.

Summary of picture settings

The following picture settings can be configured. Depending on the format of the picture source, some picture settings are not available.

- **[Auto Picture]**: Sets all picture settings to the factory default.
- **[Brightness]**: Adjusts the intensity and details of dark areas.
- **[Contrast]**: Adjusts the intensity of bright areas, keeping dark areas unchanged.
- **[Color]**: Adjusts color saturation.
- **[Tint]**: Adjusts the color balance in an image.
- **[Sharpness]**: Adjusts the level of sharpness in image details.
- **[Color Temperature]**: To set the color temperature to **[Normal]**, **[Warm]** or **[Cool]**.

Changing auto picture mode

- 1 Press **AUTO PIC** to set your TV to a predefined picture setting.
- 2 Press **▲** or **▼** to select one of the following settings:
 - **[Personal]**: The customized settings you defined by using the **[Picture]** menu.
 - **[Standard]**: For normal TV viewing.
 - **[Sports]**: Vivid picture settings for high action.
 - **[Movie]**: Brilliant picture settings for a cinematic experience.
 - **[Game]**: Optimized for PCs, games consoles and playstations.

Changing picture format

1 Press **FORMAT** on the remote control.

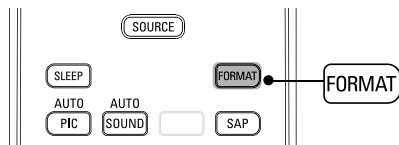

2 Press **▲** or **▼** to select a picture format and press **OK** to confirm your choice.

Summary of picture formats

Display modes can be selected when the broadcasting station is sending 16:9 or 4:3 video signal. And 3 types of display modes can be selected for PC input signal.

For 16:9 video signal

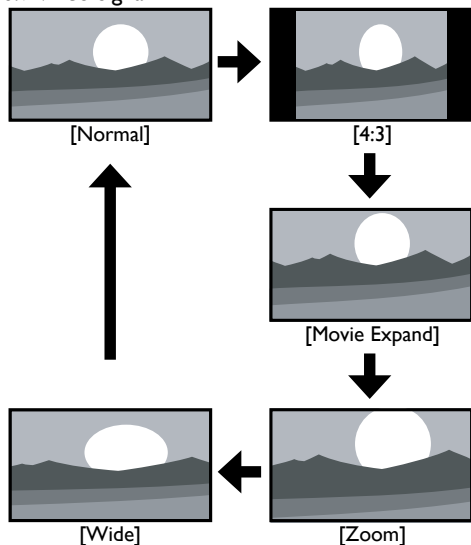

Normal

Display a 16:9 picture at its original size.

4:3

Display a 16:9 picture at a 4:3 size; the picture is shortened horizontally. Sidebars appear on both edges of the screen.

Movie Expand

Display a 16:9 picture that is vertically stretched to fill the screen. This only crops out the top of the picture.

Zoom

Display a 16:9 picture at its maximum size without changing its horizontal and vertical ratio.

Wide

Display a horizontally stretched picture. This crops out the left and right sides of the picture.

For 4:3 video signal

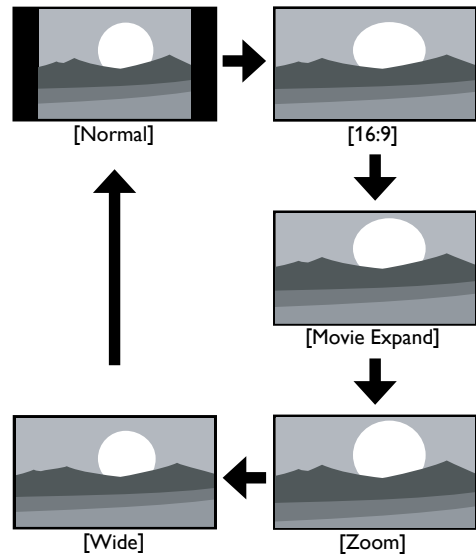

Normal

Display a 4:3 picture at its original size. Sidebars appear on both edges of the screen.

16:9

Display a 4:3 picture at a 16:9 size; the picture is stretched horizontally to fill the screen.

Movie Expand

Display a 4:3 picture at a 16:9 size; the picture is stretched more vertically at the top of the screen. This crops out the top of the picture.

Zoom

Display a 4:3 picture at a 16:9 size; at its maximum size that is more vertically stretched to fill the screen. This crops out the top and bottom of the picture.

Wide

Display the picture with its center at the original size and the edges stretched horizontally to fill the screen.

For PC input signal through **HDMI1** input mode

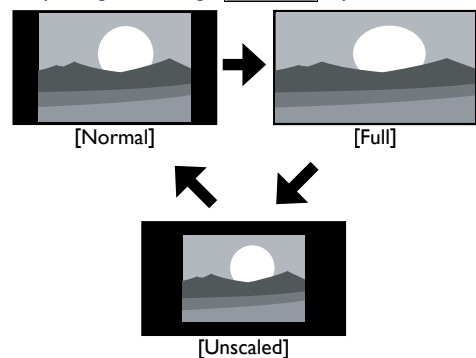

Normal

Display a proportionately stretched picture. Sidebars appear on both edges of the screen.

Full

Display a picture that is stretched out of proportion to fill the screen.

Unscaled

Display a picture in its original size.

Using your TV as a PC monitor

Use an HDMI-DVI cable or an HDMI-DVI adaptor to connect a PC to your TV. For sound, add an audio cable with a stereo mini jack.

Caution

- Before you connect your PC, set the PC monitor refresh rate to 60Hz.

Supported screen resolutions

The following screen resolutions are supported in PC mode:

Resolution	Refresh rate
640 × 480	60Hz
800 × 600	60Hz
1024 × 768	60Hz
1280 × 768	60Hz
1360 × 768	60Hz
1920 × 1080	60Hz

Changing sound settings

- 1 Press **MENU** on the remote control and select **[Sound]**.

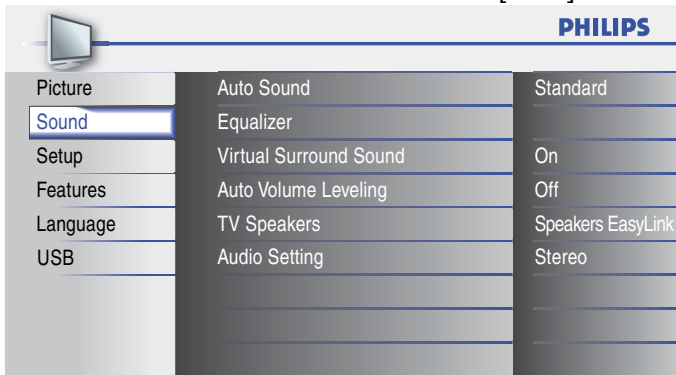

- 2 Press **▲** or **▼** to highlight a sound setting and press **OK** to select the setting.

- 3 Adjust the following items.

[Auto Sound]

Press **▲** or **▼** to select the desired setting, then press **OK**. (**[Personal]**, **[Standard]**, **[Movie]**, **[Music]** and **[News]**)

[Equalizer]

Adjust tone quality for each frequency.

Press **◀** or **▶** to select the specific frequency, then press **▲** or **▼** to adjust the level.

[Virtual Surround Sound]

Sound mode for more spatial or surround sound reproduction.

Press **▲** or **▼** to select the desired option, then press **OK**.

On	The Virtual Surround Sound will be effective.
Off	The original sound will be output.

[Auto Volume Leveling]

Reduces sudden changes in volume, for example, during commercials or when switching channels.

Press **▲** or **▼** to select the desired option, then press **OK**.

On	Select if you want to reduce volume differences between the TV commercials and the programs.
Off	Select if you want to turn off the Auto Volume Leveling.

[TV Speakers]

This option will allow you to select the audio output from the unit's speakers. If you connect this TV to an external amplifier which is compatible with HDMI CEC, you can use volume controls on this TV to control volume on the external amplifier.

Press **▲** or **▼** to select the desired option, then press **OK**.

On	The sound will be output from the unit's speakers.
Off	The sound will not be output from the unit's speakers.
Speakers EasyLink	You can control audio output from your connected EasyLink Compliant Devices with VOL +/- by using this unit's remote control.

[Audio Setting]

You can set the output mode as a default for the sound mode (NTSC only).

This setting is not interlocked when you change the output mode by pressing **SAP**. (see 'Switching audio mode' on page 14).

Press **▲** or **▼** to select the desired option, then press **OK**.

Stereo	Outputs stereo-audio
Mono	Outputs mono-audio
SAP	Outputs second audio program

- 4 Press **MENU** to exit.

Summary of sound settings

The following sound settings can be configured. Depending on the sound source, some sound settings are not available.

- **[Auto Sound]**: Sets all sound settings to the factory default.
- **[Equalizer]**: Adjusts individual sound frequencies.
- **[Virtual Surround Sound]**: Sound mode for more spatial or surround sound reproduction.
- **[Auto Volume Leveling]**: Reduces sudden changes in volume, for example, during commercials or when switching channels. Select **[On]** or **[Off]**.
- **[TV Speakers]**: Select **[On]** or **[Off]**, or output sound to an EasyLink compliant device. When **[Speakers EasyLink]** is selected, the TV speakers are disabled and TV sound outputs to the speakers of the compatible EasyLink compliant device. Adjust the volume using the unit's remote control.

Note

- If the TV is connected to a non-EasyLink compliant device and **[Speakers EasyLink]** is selected, the TV speakers will not be disabled and continue to output sound.

Changing auto sound mode

- 1 Press **AUTO SOUND** to set your TV to a predefined sound setting.
- 2 Press **▲** or **▼** to select one of the following settings:
 - **[Personal]**: The customized settings you defined by using the **[Sound]** menu.
 - **[Standard]**: For normal TV viewing.
 - **[Movie]**: Realistic sound settings for a cinematic experience.
 - **[Music]**: Emphasize high and low freq. for instrument sound.
 - **[News]**: Clear sound settings for human voice.

Sleeptimer

You can always put your TV in standby mode earlier or reset the sleeptimer during the countdown.

Press **SLEEP** to set the sleep timer:



Sleep timer display appears on the TV screen.

Press **SLEEP** repeatedly to change the amount of time (in increments of 30 minutes up to 120 minutes).



- Each press of **SLEEP** will increase the time by 30 minutes.
- After setup, the sleep timer display can be called up for checking by pressing **SLEEP**.



Tip

To Cancel the Sleep Timer

- Press **SLEEP** repeatedly until "Sleep Off" is displayed on the TV screen.

Child and rating locks

You can prevent your children from watching certain programs or certain channels by locking the TV controls and by using ratings.

Setting your PIN

- 1 Press **MENU** on the remote control and select **[Features] > [Child Lock]**.
- 2 Enter a 4-digit **PIN** on the **Number buttons**, of the remote control.
 - If you have not set up your **PIN**, enter **0000**.

Changing your PIN

- 1 Press **MENU** on the remote control and select **[Features] > [Child Lock] > [Change PIN]**.
- 2 Enter a 4-digit **PIN** on the **Number buttons** of the remote control.
 - If you have a **PIN**, enter your current **PIN**.
 - If you do not have a **PIN**, enter **0000**.
 - If you have forgotten your **PIN**, unplug the AC power cord for 10 seconds to restore the **PIN** to **0000**.
- 3 Enter your **PIN** again to confirm.
- 4 Press **MENU** to exit.

Locking a channel or input source

This section describes how to lock input sources or specified channels. The channels can be selected but the screen is blanked out and the audio is muted.

- 1 Press **MENU** on the remote control and select **[Features] > [Child Lock] > [Channel Lock]**.
- 2 Enter your **PIN** (see 'Setting your PIN' on page 18).

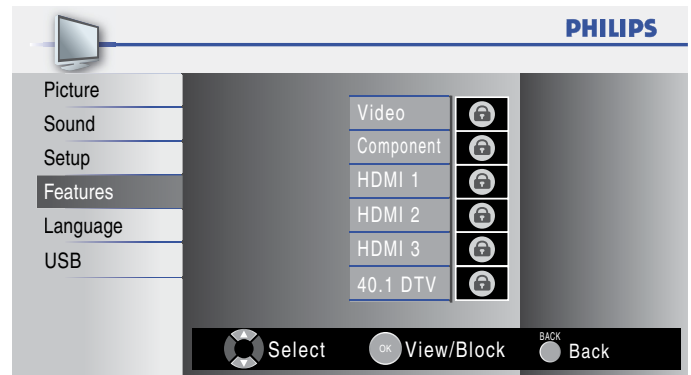

- 3 Press **▲** or **▼** and then press **OK** repeatedly to switch between blocked and not blocked.
 - A box with indicates that the channel or input source is blocked.
 - An empty box indicates that the channel or input source is not blocked.
- 4 Press **MENU** to exit.

Using the TV ratings lock

Your TV is equipped with a V-chip that allows you to control access to individual programs based on their age rating and content rating. The program content advisory data are sent by the broadcaster or by the program provider.

If you receive channels through a set-top box or cable box connected by HDMI, you cannot use the TV ratings lock. Your set-top box or cable box must be connected through RF or AV connectors.

- 1 Press **MENU** on the remote control and select **[Features] > [Child Lock] > [US TV ratings lock]**.
- 2 Press **▲** or **▼** or **◀** or **▶** and then press **OK** repeatedly to switch between blocked and not blocked. Each rating has a box-graphic in front of it to indicate whether programs carrying that rating are locked:
 - A box with indicates that all items in the content ratings list are blocked.
 - An empty box indicates that no items in the content ratings list are blocked.
 - An empty box indicates that some content ratings are deselected. For example, for rating TV-14, you can deselect one or more of the following content ratings: **[D]** (Dialog), **[L]** (Language), **[S]** (Sex), or **[V]** (Violence).

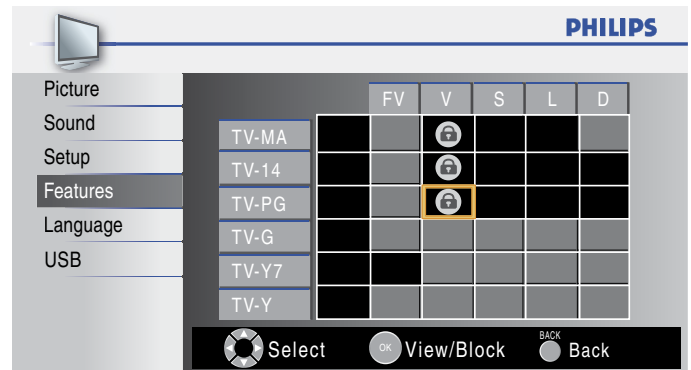

- When you block a rating, all ratings in the younger age categories are automatically blocked.
- 3 Press **MENU** to exit.

Summary of TV ratings

Age rating	Content rating
TV-Y : Appropriate for children of all ages with themes and elements suitable for children aged 2-6.	None
TV-Y7 : Programs designed for children age 7 and older.	[FV] (Fantasy Violence)
TV-G : Programs suitable for all ages. These programs contain little or no violence, no strong language and little or no sexual dialog or situations.	None
TV-PG : Programs contain elements that some parents may find unsuitable for younger children and which may need parental guidance. The program may contain moderate violence, sexual dialog and/or situations and some strong language.	[D] (Dialog) [L] (Language) [S] (Sex) [V] (Violence)
TV-14 : Programs contain elements that may not be suitable for children under 14 years of age. These programs include one or more of the following: intense violence, intense sexual situations, suggestive dialog and strong language.	[D] (Dialog) [L] (Language) [S] (Sex) [V] (Violence)
TV-MA : Programs are designed to be viewed by adults and may be unsuitable for children under the age of 17. These programs may contain graphical violence, explicit sexual activity and/or crude or indecent language.	[L] (Language) [S] (Sex) [V] (Violence)

Using the movie ratings lock

You can control viewing of movies based on their MPA (Motion Picture Association of America) rating.

- 1 Press **MENU** on the remote control and select **[Features]** > **[Child Lock]**.
- 2 Select one of the menus for movie ratings lock.
 - In the USA, select **[US Movie ratings lock]**.
 - In Canada, select **[Canadian English Rating]** or **[Canadian French Rating]**.
- 3 Enter your **PIN** (see 'Setting your PIN' on page 18).
 - ↳ The following screen shows the ratings in **[US Movie ratings lock]**.

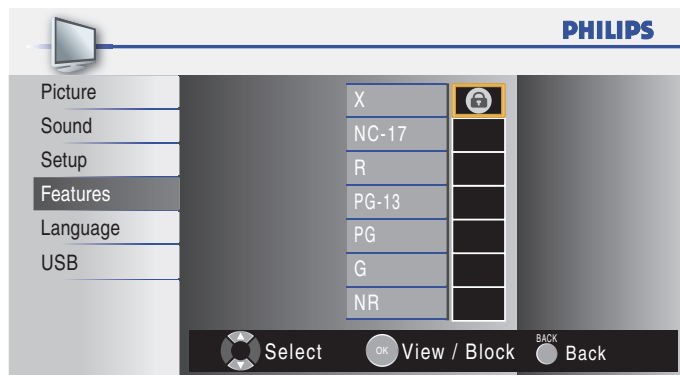

- 4 Press **▲** or **▼** and then press **OK** repeatedly to switch between blocked and not blocked.
 - A box with  indicates that all items in the rating are blocked.
 - An empty box indicates that no items in the rating are blocked.
- 5 Press **MENU** to exit.

Summary of US movie ratings

Rating	Description
NR	Not rated.
G	Movies with a mild content, suitable for all ages.
PG	Movies for which parental guidance is recommended. They may contain a few racy or violent scenes or maybe some bad language.
PG-13	Movies for which parental guidance may be recommended if under age 13.
R	Restricted. The movies usually contain offensive sex or bad language and may be unsuitable for children under the age of 17. Parental guidance or permission needed.
NC-17	Even with parental permission, forbidden under age 17. More offensive sex, violence or bad language.
X	Movies which generally focus on sex, violence and/or bad language. Also known as pornography.

Summary of Canadian English rating

Rating	Description
E	Exempt program.
C	Programming suitable for children under the age of 8 years. No profanity or sexual content of any level allowed. Minimal comedic violence.
C8+	Suitable for children ages 8 and over. Low intensity violence and fantasy horror allowed.
G	Movies with a mild content, suitable for all ages.
PG	Movies for which parental guidance is recommended. They may contain a few racy or violent scenes or maybe some bad language.
14+	Programming intended for children ages 14 and over. May contain intense scenes of violence, strong profanity, and depictions of sexual activity within the context of a story.
18+	Programming intended for viewers ages 18 and over. May contain strong violence, language, and sexual activity.

Summary of Canadian French rating

Rating	Description
E	Exempt program.
G	Appropriate for all ages with little or no violence and little to no sexual content.
8ans+	Appropriate for children 8 and up which may contain little violence, some foul language and/or little to no sexual content.
13ans+	Appropriate for children 13 and up, with moderate violence, language, and some sexual situations. Persons under 13 should be accompanied by an adult.
16ans+	Appropriate for children 16 and up, with strong violence, strong language, and strong sexual content.
18ans+	Only to be viewed by adults and contains extreme violence and graphic sexual content/pornography.

Closed caption

Closed captioning is an assistive technology that allows persons with hearing disabilities to access television programming. Closed captioning displays the audio portion of programming as text superimposed over the video.

Note

- Closed captioning service may not be controlled by this unit's menu options if you are watching television through an external cable or satellite set top box. In which case you will need to use the menu options on the external set top box to control Closed Captioning.
- The captions do not always use correct spelling and grammar. Not all TV programs and product commercials include closed caption information. Refer to your area TV program listings for the TV channels and times of closed caption shows. The captioned programs are usually noted in the TV listings with service marks such as **[CC]**.

DTV

Selecting DTV caption services

- 1 Select a caption service for digital channels:
 - Press **MENU** on the remote control and select **[Features]** > **[Closed Caption]** > **[Digital Caption Service]**.
 - Press **▲** or **▼** to select one of the listed caption services, and press **OK** to confirm your choice.

Off	Select if you do not want Digital Caption Service. This is the default.
CS-1 to CS-6	Select one of these before changing any other item in [Closed Caption] menu. Choose [CS-1] under normal circumstances.

- 2 Press **MENU** to exit.

Selecting how captions are displayed

You can choose the size, font, color, background and other characteristics of the caption text.

- 1 Press **MENU** on the remote control and select **[Features]** > **[Closed Caption]** > **[Caption Style]** > **[User Setting]**. Press **▲** or **▼** to select **[On]**, then press **OK**.
- 2 Press **▲** or **▼** to highlight an option for digital captions, and press **OK** to select the option.
- 3 Press **▲** or **▼** to highlight a setting for the option, and press **OK** to confirm your choice.
- 4 Press **MENU** to exit.

Difficulties viewing closed captions on DTV programming

If you have difficulties viewing closed captions on DTV programming, including HDTV, received from your subscription television provider, you should:

- consult any consumer information and manuals/guides on closed captions for DTV programming provided by your subscription television provider;
 - ensure that the captioning function on your set-top box, if applicable, is turned on; and,
 - ensure that the captioning function on your DTV is turned on.
- If you are still unable to view closed captions on DTV programming, you should contact your subscription television provider for assistance.

TV

Selecting caption services

- 1 Select a caption service for analog channels:
 - Press **MENU** on the remote control and select **[Features]** > **[Closed Caption]** > **[Caption Service]**.
 - Press **▲** or **▼** to select one of the listed caption services, and press **OK** to confirm your choice.
- 2 Press **MENU** to exit.

Note

- Not all caption services are used by a TV channel during the transmission of a closed caption program.

Summary of caption services

Service	Description
CC-1 and T-1;	are the primary caption and text services. The captioning or text is displayed in the same language as the program's dialogue (up to 4 lines of script on the TV screen, where it does not obstruct relevant parts of the picture).
CC-3 and T-3;	serve as the preferred data channels. The captioning or text is often a secondary language.
CC-2, CC-4, T-2 and T-4;	are rarely available and broadcasters use them only in special conditions, such as when [CC-1] and [CC-3] or [T-1] and [T-3] are not available. <ul style="list-style-type: none">• There are 3 display modes according to programs: Paint-on mode: Displays input characters on the TV screen immediately. Pop-on mode: Once characters are stored in memory, they are displayed all at once. Roll-up mode: Displays the characters continuously by scrolling (max. 4 lines).

EasyLink

This function allows you to operate the linked functions between our brand devices with EasyLink capabilities and this unit connected via a HDMI cable.

- 1 Press **MENU** on the remote control and select **[Features]** > **[EasyLink]**.

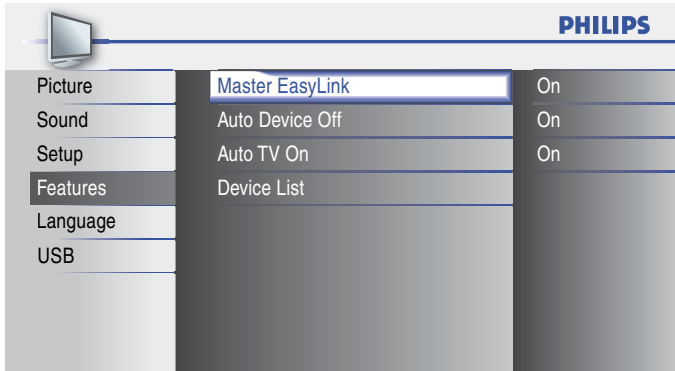

- 2 Press **▲** or **▼** to highlight the desired setting and press **OK** to select the setting.

- 3 Adjust the following items.

[Master EasyLink]

Set the EasyLink **[On]** or **[Off]**.

The following additional settings will be grayed out when you set to **[Off]**.

Press **▲** or **▼** to select the desired option, then press **OK**.

On	Select if you have connected an external device that is compatible with the EasyLink function.
Off	Disable all EasyLink function.

[Auto Device Off]

Press **▲** or **▼** to select the desired option, then press **OK**.

On	Your connected EasyLink device goes into standby mode automatically when you put this unit into standby mode.
Off	Your connected EasyLink device stays on even if unit goes into standby mode.

[Auto TV On]

Press **▲** or **▼** to select the desired option, then press **OK**.

On	This unit turns on automatically when you turn on your connected EasyLink device.
Off	This unit remains in standby mode even if you turn on your connected EasyLink device.

[Device List]

This function lets you see the product name of connected devices.

Press **▲** or **▼** to select the desired HDMI device listed on the TV screen, then press **OK**.

- 4 Press **MENU** to exit.

ECO

You can set whether the power consumption is saved or not.

- 1 Press **MENU** on the remote control and select **[Features]** > **[ECO]**.

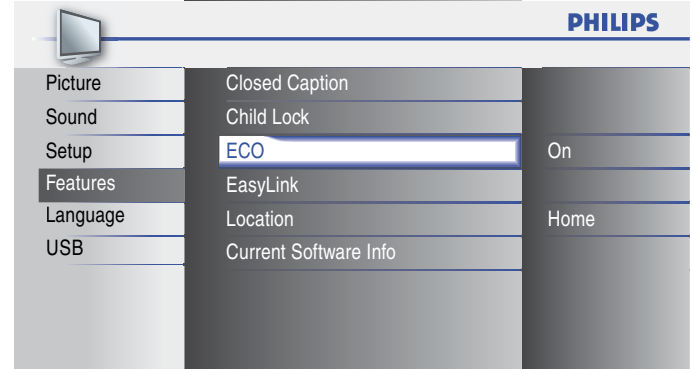

- 2 Press **▲** or **▼** to select the desired mode, then press **OK**.

On	Select if you want to reduce power consumption.
Off	Sets the backlight brighter.

- 3 Press **MENU** to exit.

Set your location to home

You can set the location of your TV to **[Home]** or **[Retail]**.

Choosing **[Home]** gives you full flexibility to change predefined settings for picture and sound.

- 1 Press **MENU** on the remote control and select **[Features]** > **[Location]**.

- 2 Select **[Home]** and press **OK** to confirm your choice.

- 3 Press **MENU** to exit.

Note

- You must set **[Home]**. Otherwise, personalized picture and sound settings will not be memorized after the unit goes to standby mode.

View photos, play music and watch videos on a USB storage device

Your TV is fitted with a USB connection that enables you to view photos or listen to music stored on a USB storage device.

Supported formats	Not-supported formats
JPEG	Progressive JPEG files
MP3	File name exceeding 128 characters
FAT/DOS-formatted memory devices	File names containing a dot character

It is recommended that files to be played back in this unit are recorded under the following specifications:

<MP3>

- Sampling frequency : 32kHz or 44.1kHz or 48kHz
- Constant bit rate : 32kbps - 320kbps

<JPEG>

- Upper limit : 24Mpixel

<Motion JPEG>

- Size : 320×240 (QVGA)
- Frame rate : 30fps
- Audio type : LPCM - Sampling frequency (32 kHz, 44.1 kHz or 48 kHz)
- Quantization bit rate (16 bit)

Note

- Philips can not be held responsible if your USB storage device is not supported, nor will Philips accept any liability for damage or loss of stored data.
- The USB storage device is not supplied with the TV.
- Motion JPEG file with an extension of ".avi" can only be recognized. An extension of ".mov" is not supported.
- This unit doesn't support "pause", "forward" or "reverse" during video (Motion JPEG) playback.

Connect a USB storage device

- 1 Turn on the TV.
- 2 Connect the USB storage device to the USB port on the side of your TV.
↳ The main menu appears automatically.
- 3 Press ▲ or ▼ select [USB].

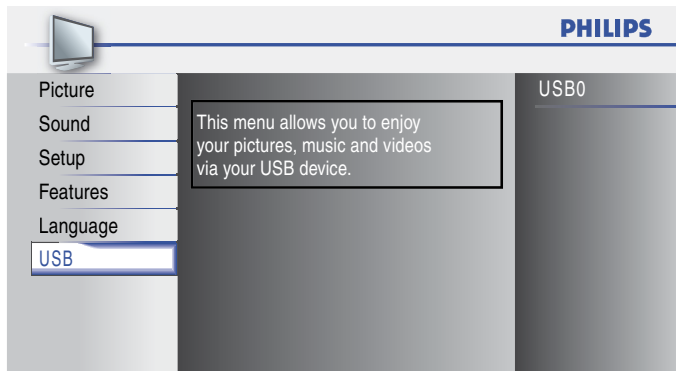

Disconnect a USB storage device

Caution

- To avoid damaging the USB storage device always exit the on-screen menu and wait five seconds before you remove the USB storage device.

- 1 Press **MENU** to exit the on-screen menu.
- 2 Wait five seconds then remove the USB storage device.

View your pictures on a USB storage device

- 1 After connecting your USB storage device to the TV, press **OK** to enter the [USB] menu.

↳ [Picture] is highlighted.

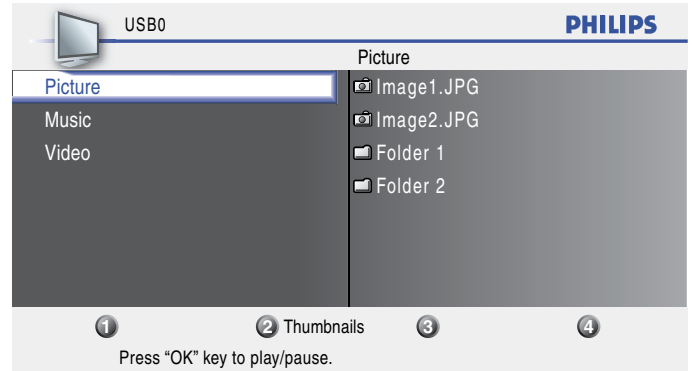

- 2 Press **OK** to enter the [Picture] folder.
- 3 Press ▲ or ▼ to select a picture or an album on the USB storage device.
↳ The pictures appear in a list or as thumbnails.
- 4 Press a number 2 (Number buttons) to toggle between [List] and [Thumbnails].

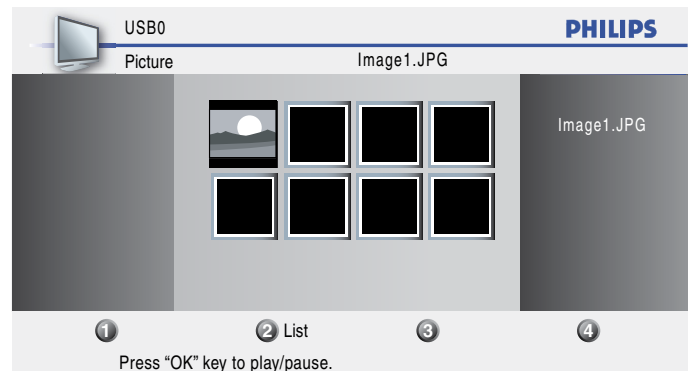

- 5 Press **OK** to view the picture or to start a slideshow of pictures in the album.
 - Press the **Number buttons** on the remote control to perform the function shown at the bottom of the screen.
 - If the function bar at the bottom disappears, press any **Number buttons** to make it reappear.
 During slideshow, you can skip forward or backward picture by pressing **CH +/-**.
- 6 Press **◀** and select another picture or another album.

Configure how the slideshow is played

You can configure the following features of your slideshow.

Feature	Description
[More details]	Displays the picture name, date, size and next picture in the slide show.
[Transitions]	Displays a list of available transition styles of the pictures.
[Slide time]	Sets the amount of time that a picture is shown.
[Rotate]	Rotates a picture.
[Zoom]	Displays a list of available magnifications.
[Start show]/ [Stop show]	Starts or stops a slide show.

Listen to music on a USB storage device

- 1 Connect your USB storage device to the TV.
- 2 Press **OK** to enter the **[USB]** menu.
- 3 Select **[Music]**.
- 4 Press **OK** to enter the music folder.

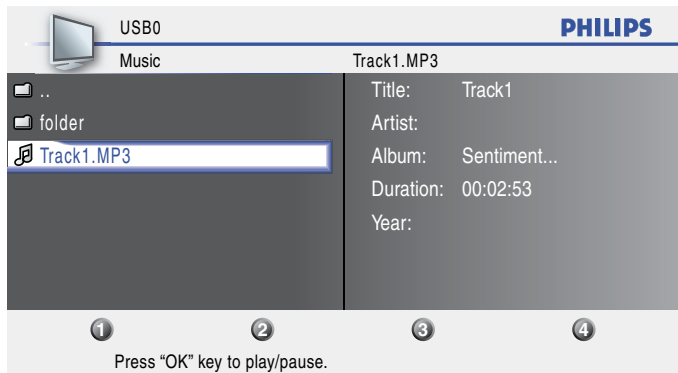

- 5 Press **▲** or **▼** to select a music.
 - Press the **Number buttons** on the remote control to repeat, shuffle, or change settings.
 - Press **OK** to pause, press **OK** again to restart.
 - If the Number buttons disappear from the screen, press **OK** to make them reappear.
 During playback, you can skip forward or backward music by pressing **CH +/-**.
- 6 Press **◀** to select another song.

Watch your Video on a USB storage device

- 1 Connect your USB storage device to the TV.
- 2 Press **OK** to enter the **[USB]** menu.
- 3 Select **[Video]**.
- 4 Press **OK** to enter the video folder.

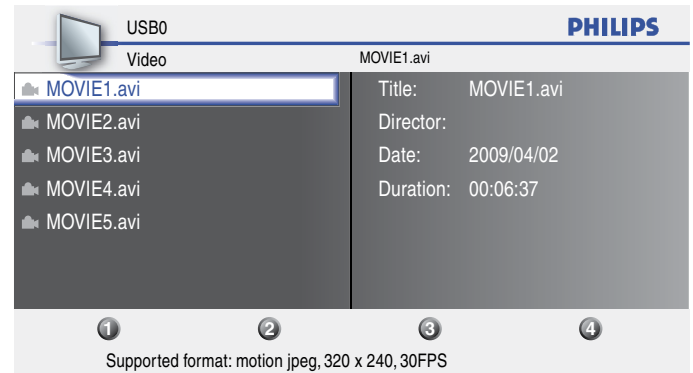

- 5 Press **▲** or **▼** to select a video.
 - To stop playback and return to the file list, press **BACK**, **OK** or **CH+**.
 - Press **CH-** to play back from the beginning.
 - Press **1** to display file details below. Press **1** again to remove file details.
- 6 Press **◀** to select another video.

Note

- Motion JPEG file with an extension of ".avi" can only be recognized. An extension of ".mov" is not supported.
- This unit doesn't support "pause", "forward" or "reverse" during video (Motion JPEG) playback.

7 Install channels

The first time you set up your TV, you are prompted to select a menu language and to install TV and digital radio channels (if available). This chapter provides instructions on how to reinstall and fine-tune channels.

Selecting your menu language

- 1 Press **MENU** on the remote control and select **[Language]**.

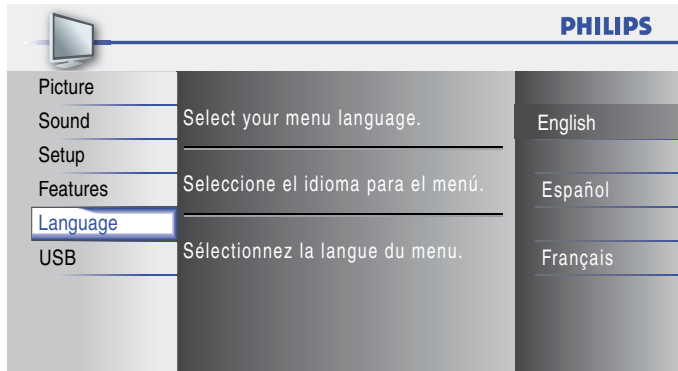

- 2 Select a language and press **OK** to confirm your choice.
- 3 Press **MENU** to exit.

Autoprogram

Before you install channels, ensure that you are registered with your cable TV provider and that your equipment is correctly connected.

- 1 Press **MENU** on the remote control and select **[Setup] > [Autoprogram]**.

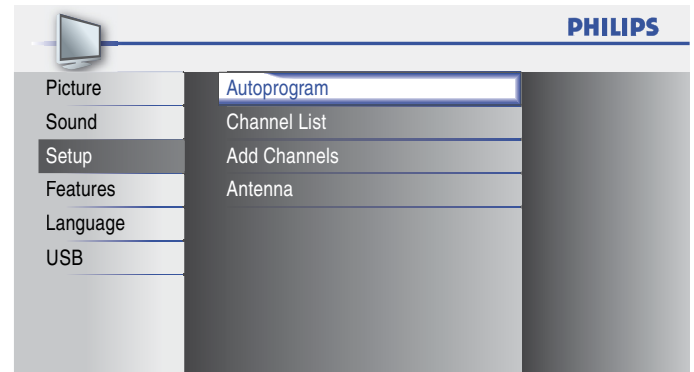

- 2 Press **OK** to start the installation.
If you run **[Autoprogram]** when you have locked channels, a message appears asking to enter your **PIN**. Enter your **PIN** in order to complete the installation.
If you have forgotten your **PIN**, reset it as described in 'Changing your PIN' on page 18.

- 3 Select **[Antenna]** or **[Cable]** and press **OK**.
 - When **[Antenna]** is selected, the TV detects antenna signals. It searches for NTSC and ATSC channels available in your area.
 - When **[Cable]** is selected, the TV detects signals supplied by cable. It searches for NTSC, ATSC, and Cable channels available in your area.

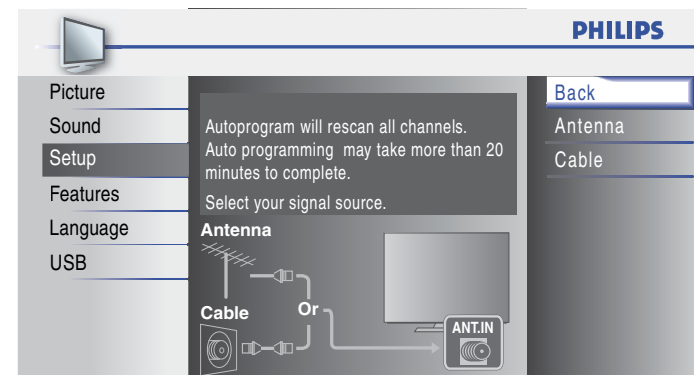

- When autoprogramming is complete, the lowest memorized channel will be displayed.

- 4 Follow the on-screen instructions to complete the installation.

Channel list

The channels selected here can be skipped when selecting the channels using **CH +/–**.

Those channels can still be selected with **the Number buttons**.

- 1 Press **MENU** on the remote control and select **[Setup] > [Channel List]**.

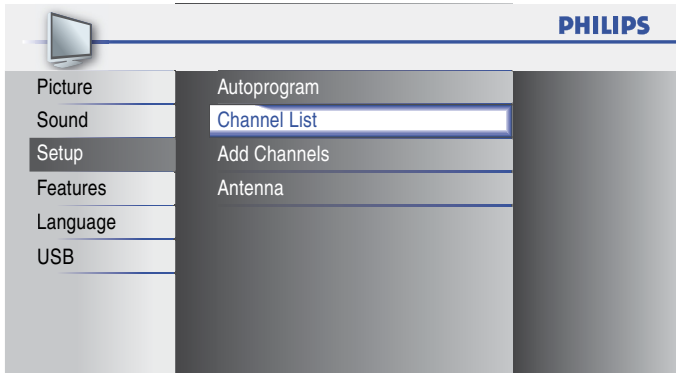

- 2 Press **▲** or **▼** to select the channel you want to remove, then press **OK**.

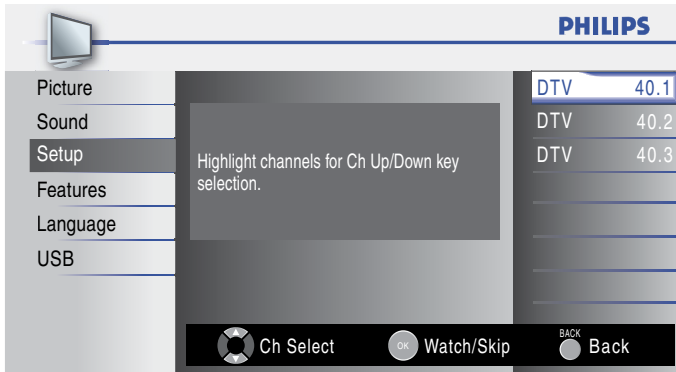

- The channel display for the removed channel darkens. You will not be able to select the channel again using **CH +/–**.
- To reactivate a removed channel, press **▲** or **▼** and press **OK**. The registered channels are highlighted.
- When you remove a major channel, its minor channels are removed as well.

Note

- The channel with the **[DTV]** indicated on the display is ATSC. Otherwise the channel is NTSC.

- 3 Press **MENU** to exit.

Add channels

This function lets you add the channels that were not added by the autoprogram due to the receptive condition at the initial setup.

- 1 Press **MENU** on the remote control and **[Setup] > [Add Channels]**.

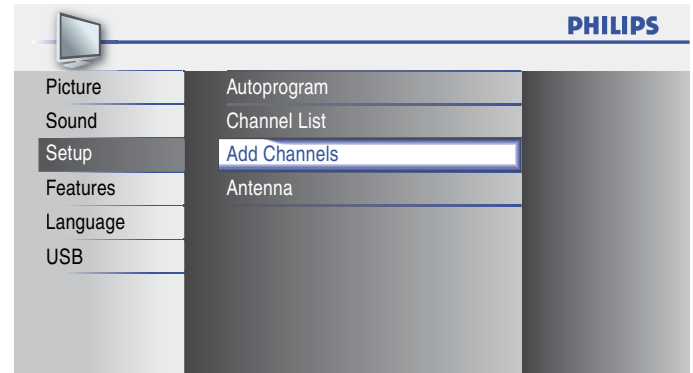

- 2 Press a number (1 to 135) to enter the number of the channel you want to add, then press **OK**.

11

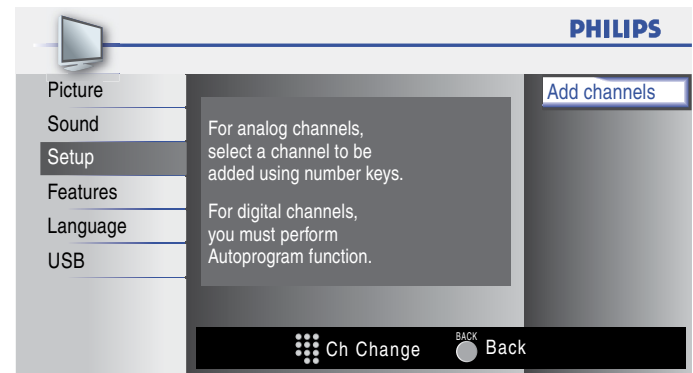

- 3 Press **MENU** to exit.

Note

- If setup completes successfully, **[Added to the channel list]** is displayed.
- If external input is used, it is not possible to register the channel and **[Unavailable]** will be displayed on the TV screen.
- By pressing **▲** or **▼** you can select the memorized channels only.
- In most cases, digital channels are not broadcast on the RF channel on which they appear on your TV. To add digital channels you need to know the RF channel on which the digital channel is being broadcast. E.g. If there is a digital channel 9.1 which is being broadcast on RF channel 25, you need to enter 25 while performing a weak channel installation. To find out the RF channel on which a particular digital channel is being broadcast, please contact your local service provider. Installing digital channels using **[Add channels]** might not work for direct cable connections and if the digital signal is too weak for the TV to process.

Optimizing the signal quality from your antenna

You can optimize your signal quality by tuning in ATSC channels with weak signals, and adjusting the antenna.

- 1 Press **MENU** on the remote control and select **[Setup] > [Antenna]**.
- 2 Press **OK** to confirm your choice.
- 3 Press a number (1 to 135) or press **CH +** or **CH –** to select the channel for which you want to check the digital signal strength.
- 4 Press **MENU** to exit.

8 Upgrade your TV software

Philips continuously tries to improve its products and we strongly recommend that you upgrade the TV software when upgrades are available. New software can be downloaded from our website at www.philips.com/support using the model number of your TV (e.g. 32PFL3506) to find information.

Checking your current software version

- 1 Press **MENU** on the remote control and select **[Features] > [Current Software Info]**.
↳ The version and a description of the current software is displayed, then press **OK**.

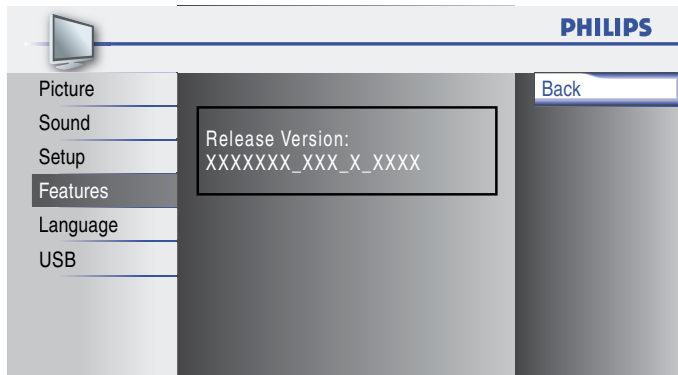

- 2 Press **MENU** to exit.

Preparing for the software upgrade

You require the following equipment:

- A PC with web browsing capability.
- An archive utility that supports the ZIP-format (e.g. WinZip for Windows or Stuffit for Mac OS).
- An empty clean formatted USB stick.

Note

- Only FAT/DOS-formatted portable memory is supported.
- New software can be downloaded from www.philips.com/support
- Use only software upgrades that can be found on the Philips web site.

Warning

- When the software upgrade is running, don't press any buttons.
- Do not remove the USB storage device during the software upgrade.
- If an error occurs during the upgrade, retry the procedure or contact your dealer.

Downloading the software

- 1 On your PC, open a web browser and go to www.philips.com/support
- 2 Find information and software related to your TV and download the latest software upgrade file to your PC.
- 3 Decompress the ZIP-file.
- 4 Copy the upgrade file to the root directory of the USB storage device.

Upgrading software

- 1 Prepare the software upgrade (see 'Preparing for the software upgrade' on page 26).
- 2 If the TV is on, press **POWER** at the side of the TV.
- 3 Connect your USB storage device to the service terminal on the side of your TV.

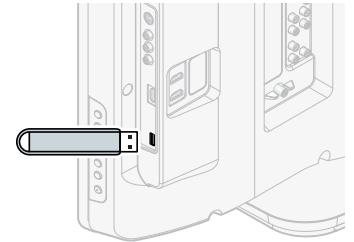

- 4 Switch on the TV.
↳ The TV scans the USB storage device for the upgraded software and automatically enters upgrade mode.
- 5 Read the on-screen instructions and confirm that you want to continue with the installation.

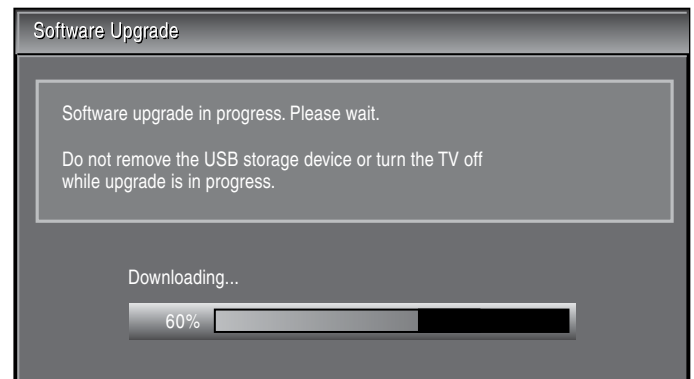

- 6 When the software upgrade is complete, remove the USB storage device.
- 7 Press **POWER** at the side of the TV to make sure the unit goes to standby mode.
- 8 Switch on the TV.
↳ The TV starts up with the new software.
 - The following messages are displayed without starting software upgrade when it doesn't fulfill the upgrade conditions.

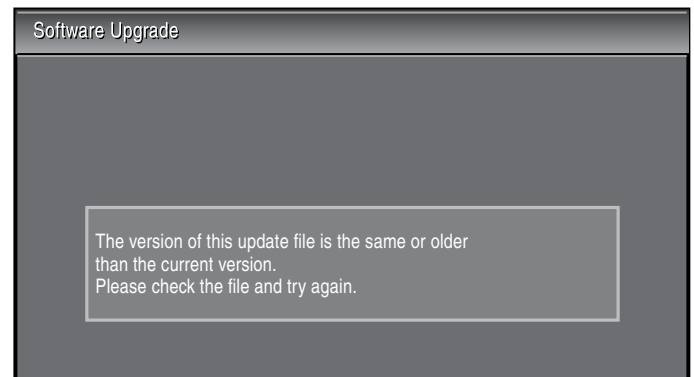

9 Connect devices

This section describes how to connect various devices with different connectors and supplements examples provided in the Quick Start Guide.

Connection overview

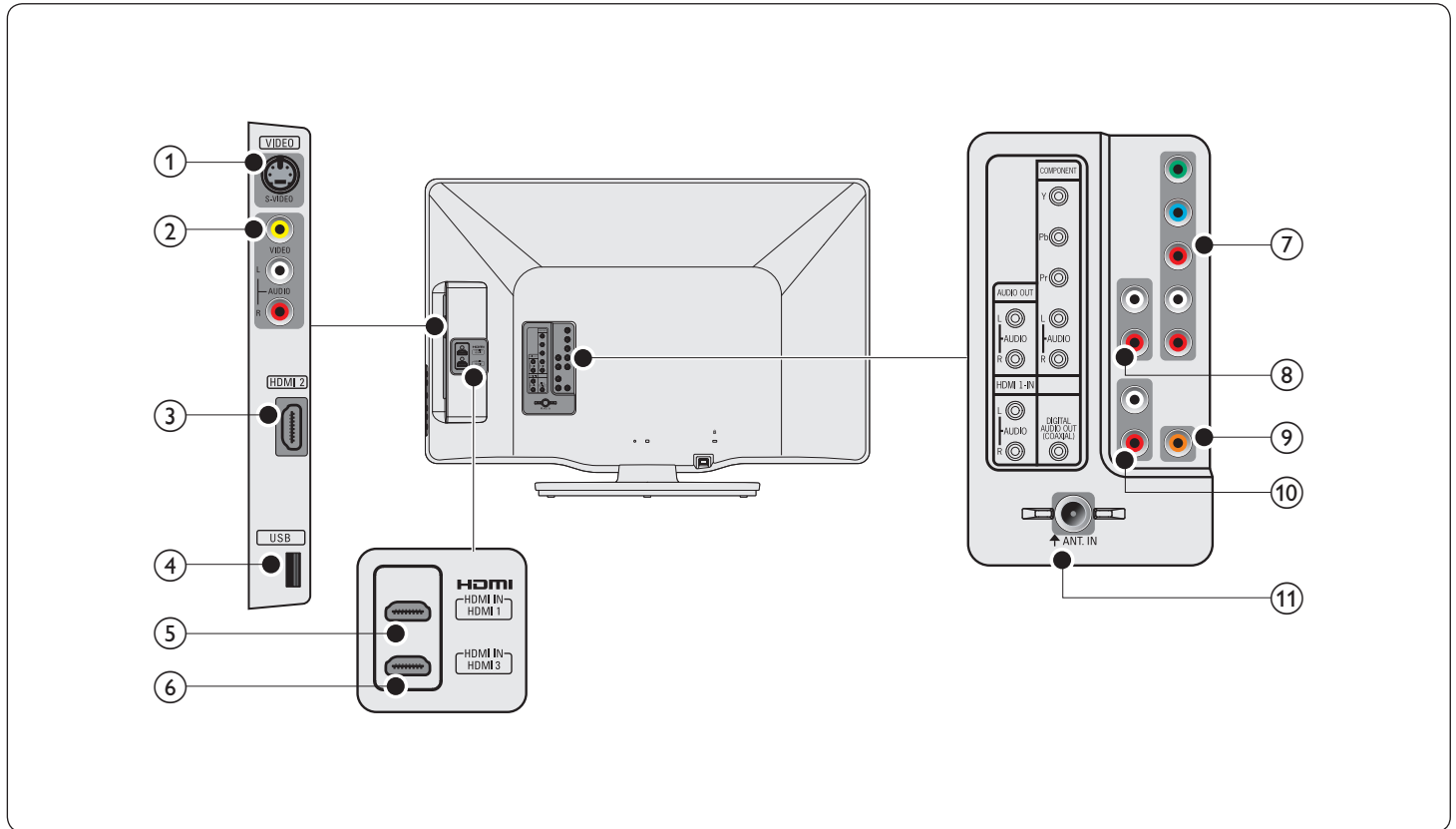

- 1 S-Video input jack**
S-Video input connector to be used with Audio L/R connectors for camcorder, game console, etc. When you use the S-Video for video signals, do not use Composite video for video signals.
- 2 Composite video and audio input jack**
Video input for analog devices such as DVD, camcorder, game console, etc. To be used with audio input.
- 3 HDMI 2 input jack**
Second HDMI in connector:
Digital audio and video input from high definition digital devices such as Blu-ray players.
- 4 USB terminal**
Data input from USB storage devices only. Do not connect any device to this terminal such as; digital camera, keyboard, mouse, etc.
- 5 HDMI 1 input jack**
First HDMI in connector.
- 6 HDMI 3 input jack**
Third HDMI in connector.
- 7 Component video and audio input jack**
Video input from analog devices such as DVD, receiver, game console, etc. This connector is used with audio input.

- 8 Analog audio output jack**
Audio cable connection for an external device.
- 9 Digital audio output jack**
Digital audio output to home theaters and other digital audio systems.
- 10 Audio input jack for HDMI 1 and PC**
- 11 Antenna input jack**
Signal input from an antenna, cable or satellite.

Caution

- Disconnect the AC power cord before connecting devices.

Note

- Different types of connectors may be used to connect a device to your TV, depending on availability and your needs.

Selecting your connection quality

HDMI - Highest quality

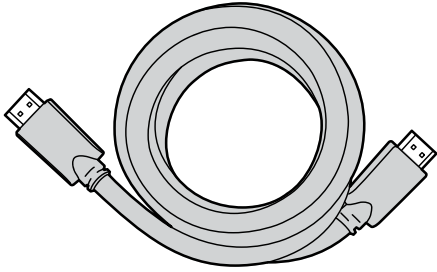

Supports high-definition signals and gives highest picture and sound quality. Video and audio signals are combined in one cable. You must use HDMI for full high-definition video and to enable Philips EasyLink.

Tip

- To connect to a PC without an HDMI connector, use a HDMI-DVI adaptor and a separate audio cable.

Note

- Philips HDMI supports HDCP (High-bandwidth Digital Contents Protection). HDCP is a form of Digital Rights Management that protects high definition content in DVD or Blu-ray Discs.

Component (Y Pb Pr) - High quality

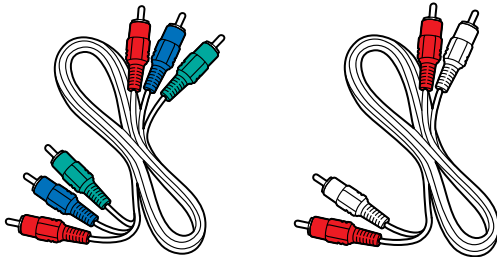

Component video cable (red/green/blue) and audio L/R cable (red/white). Supports high-definition signals but gives lower picture quality than HDMI. Component cables combine a red/green/blue video cable with a red/white audio L/R cable. Match the cable colors when you connect to the TV.

S-Video - Good quality

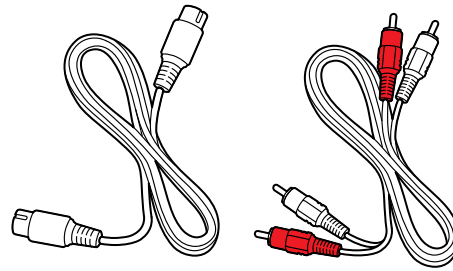

S-Video cable and audio L/R cable (red/white)

For analog connections. Use an S-Video cable together with an audio L/R cable.

Composite - Basic quality

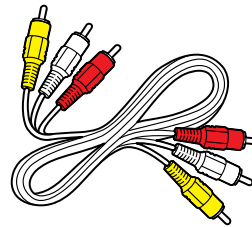

Composite video/audio cable (yellow/red/white)

For analog connections. Composite cables usually combine a yellow video cable with a red/white audio L/R cable. Match the audio cable colors when you connect to the TV.

Connecting your devices

This section describes how to connect a selection of devices with different connectors. Different types of connectors can be used to connect a device to your TV. The following sections describe examples only, other configurations are possible.

Connecting a set-top box, Blu-ray Disc player and HD game console via HDMI

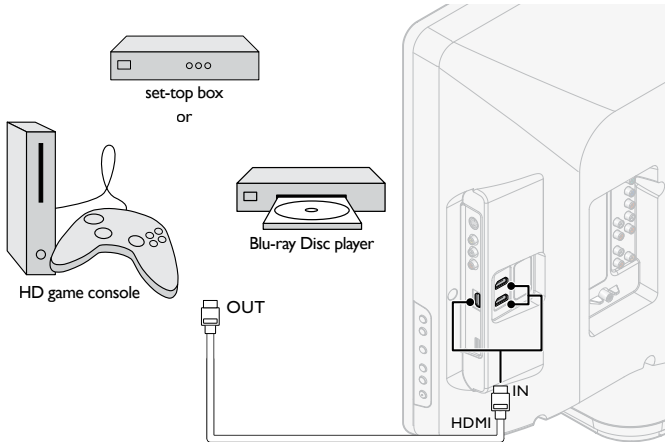

Connecting a set-top box, DVD player/recorder via component video connectors (YPbPr) and analog audio

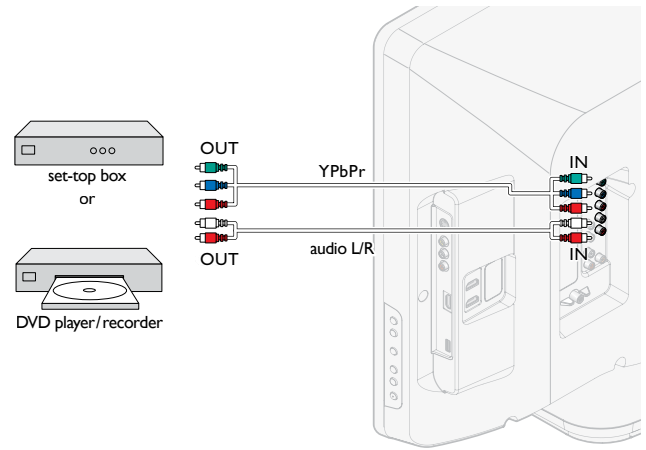

Note

- When you connect cables, match the cable colors to the connectors on the TV.

Connecting a set-top box, DVD recorder via composite connectors and analog audio

Connecting a DVD player/recorder via HDMI-DVI and analog audio

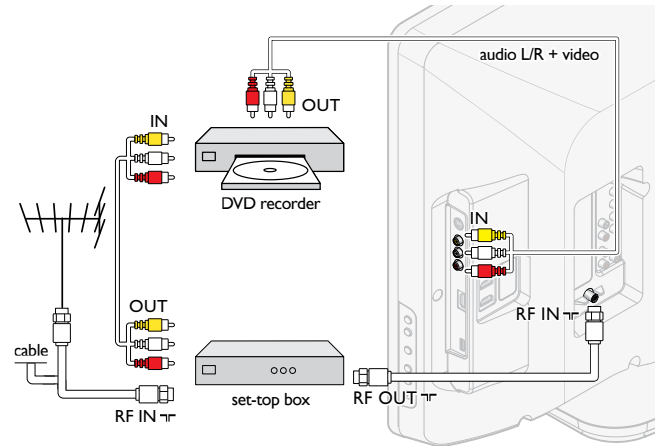
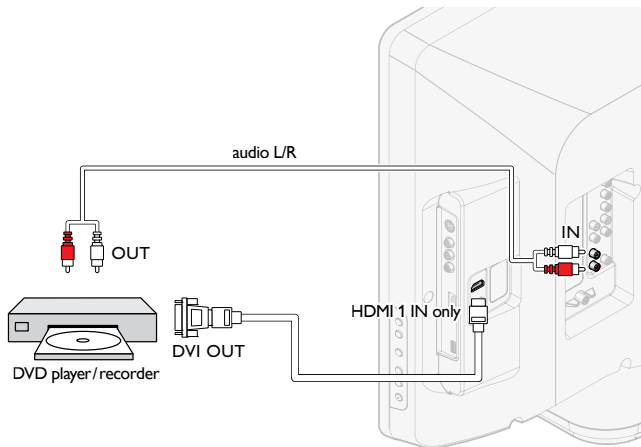

Do not place your recorder too close to the screen because some recorders can be susceptible to signals.

Note

- Only the left loudspeaker reproduces sound for mono equipment. Use a mono to stereo adapter (not supplied) for sound reproduction via all internal loudspeakers.
- When you connect cables, match the cable colors to the connectors on the TV.

Connecting a set-top box via an S-Video connector and analog audio

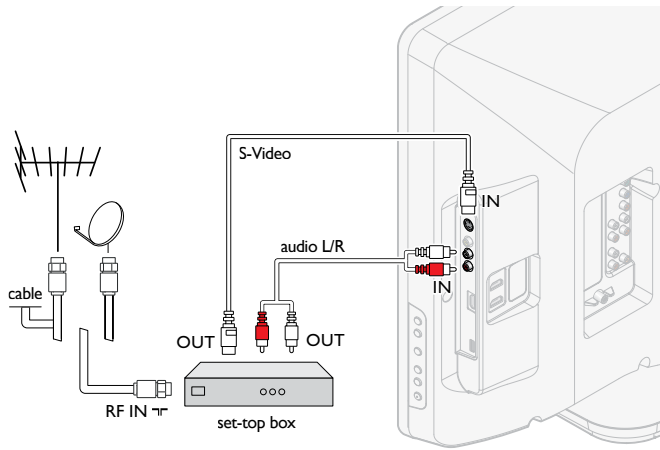

Connecting a PC

If you connect a PC with an S-Video connector at the side

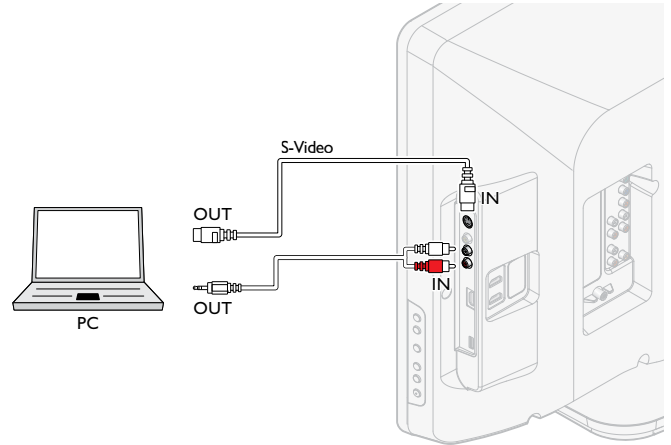

If you connect a PC with a HDMI-DVI connector:

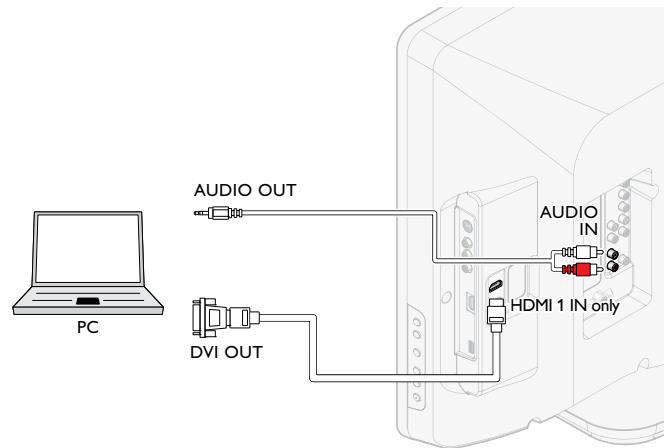

If you connect a PC with an HDMI or Display Port (HDMI-Display Port conversion cable) connector:

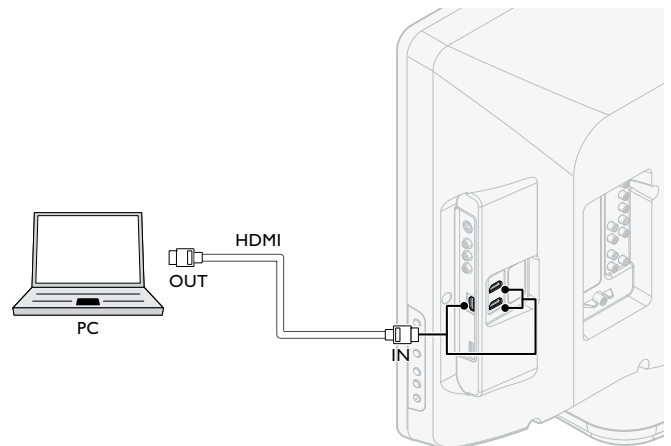

Note

- Only the left loudspeaker reproduces sound for mono equipment. Use a mono to stereo adapter (not supplied) for sound reproduction via all internal loudspeakers.
- When you connect cables, match the cable colors to the connectors on the TV.

Connecting a digital home theater amplifier using a digital audio coaxial cable

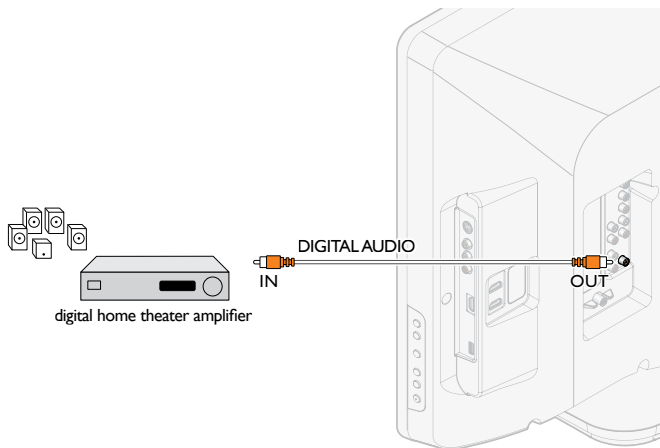

Note

- Due to Copyright restrictions, the broadcaster may choose to mute PCM audio over Digital Audio Output for certain channels, shows or segments during the broadcast.

10 Troubleshooting

Problem	Possible cause and solution
No power or indicator light.	<p>The TV is not connected to the power. Press POWER at the side of the TV or on the remote control.</p> <p>Ensure that the AC power cord is connected tightly to the TV power connector and to the power socket outlet. Remove the AC power cord from the power socket outlet, wait 60 seconds and reconnect the AC power cord. Connect the TV to a different power socket outlet.</p>
Error message on the screen with HDMI connection.	<p>HDCP authentication fail. Ensure that your HDMI cable is certified. Press SOURCE on the remote control to switch to another source and then switch back to the HDMI source. Reset the accessory device and the TV. Turn on the TV. Select the HDMI channel. Turn on the accessory device. While the TV and the accessory device are powered on, unplug either end of the HDMI cable and then reinsert the cable.</p>
No picture or sound is detected from the PC.	<p>An incorrect HDMI input jack is connected or an audio cable is not connected. Connect a HDMI-DVI cable to the HDMI 1 input jack on the TV. Connect an audio cable to the HDMI 1-IN on the TV. Press SOURCE on the remote control, and select the HDMI 1 source.</p>
TV does not respond to the remote control.	<p>Batteries are installed incorrectly, or low battery power. Ensure the indicator light on the TV blinks when you press the remote control buttons. Ensure that you are using the TV remote control. Ensure that the batteries are inserted correctly and do not need to be replaced. Remove the AC power cord from the power socket outlet, wait 60 seconds and reconnect the AC power cord.</p>
The picture is distorted, stretched out, or has black bars on the side or top.	<p>Broadcast video format. Press FORMAT on the remote control to select the best picture format. For some accessory devices, the picture format must be set in the accessory device.</p>
The picture is mostly red and green, or the picture misses red when connected to an accessory device via component cables.	<p>Insecure/incorrect connection. Ensure all the connections are made according to the color code. Push the component cables all the way into the YPbPr sockets on the TV.</p>
No picture or sound.	<p>No picture or sound - ensure you have selected the correct channel. Incomplete channel installation. If the TV receives channels via an AV connection, set the TV to the correct source input. If the TV is connected directly to the wall via a coaxial connection, perform the auto-installation again.</p>

No sound on the TV loudspeaker:	<p>Volume level is set to zero - increase the volume. Sound is muted - press MUTE on the remote control. Audio cable is not connected - for AV connection, ensure that the Audio L/R cable is connected as described in Connecting your devices (see 'Connecting your devices' on page 29). If you use a component cable, ensure that you have not crossed the red audio cable with the red video cable. Audio output setting for the accessory device is incorrect. For HDMI connections, some accessory devices have an HDMI audio output setting that must be turned on for HDMI to HDMI connections. Check if [Sound] > [TV Speakers] > [Off] is set to [On]. No sound will be output when [TV Speakers] is set to [Off].</p>
Bad picture quality with a coaxial connection.	<p>Standard definition channels are not as clear as high definition channels - connect the devices via component or HDMI cables.</p>
Cannot control your TV and connected devices with one remote control.	<p>Confirm that the connected devices are EasyLink compliant and are connected to your TV via an HDMI cable. Not all brands of devices such as Blu-ray Disc players use the same system as Philips EasyLink. Other brands might not work with Philips EasyLink.</p>

Downloading an electronic copy

To obtain a more elaborate and complete electronic copy of this manual:

- 1 Point your browser to www.philips.com/support
- 2 Choose your country of location.
- 3 Enter the model number or a keyword in the "Find your product" field. Alternatively, you can browse the catalog.
- 4 Click the description or model.
- 5 Under Product support, click "User manuals".

Contact us

If you cannot resolve your problem, refer to the FAQ for this TV at www.philips.com/support

If the problem remains unresolved, contact the Customer Support Center in your country.



Warning

- Do not attempt to repair the TV yourself. This may cause severe injury, irreparable damage to your TV or void your warranty.



Note

- Please have available your TV model and serial number before contacting us. These numbers are available on the back and side of your TV, as well as on the packaging.

11 Notes for the use of USB devices

Digital Content Issues

- Only FAT (DOS) formatted (initialized) portable memory is supported. Errors in this formatting can result in unreadable content. If such problems appear try to re-format the card. Be aware that formatting the card will also delete all the content on it (pictures, music, ...).
- Only linear JPEG picture formats are supported. Progressive JPEG and JPEG2000 encodings are not supported.
- The length of a filename or directory name is limited to the length specified by the FAT16/32 file systems.
- Max. levels of nested directories is 19.
- Never use the supported file type extensions (.jpg, .jpeg, .mp3) as extensions for directories as these directories will be treated as corrupted files.
- The MP3 decoder does not support MPEG1 Layer 1 or Layer 2 playback.
- MP3 Pro files can be played with normal MP3 quality.
- The access and response time of the content on a device can differ depending on the type or brand of the device.
- The access and response time of the content on a device will increase the more unsupported or corrupted files are on the device.

Digital Camera Issues

- If a USB connection between your digital camera and the TV isn't working, you can try the solutions below to resolve your problem.
- Make sure your digital camera is switched on and verify if the configuration of your digital camera is correct (see the manual of your digital camera for more information).
- Some digital cameras allow you to switch off the USB interface. Make sure that the USB interface is switched on before connecting to the TV.
- If you have a digital camera with only internal memory (no removable memory) you can try to copy the content manually to a USB memory device (e.g. Philips KEY product) using a personal computer.
- Some digital cameras allow you to switch between PTP (Picture Transfer Protocol) or "PC Link" and USB Mass Storage or "PC Drive". Make sure that you select USB Mass Storage or "PC Drive" on your digital camera.
- If your camera supports different interface settings be sure to try them one by one or contact the reseller of your camera to find out the correct setting.

USB Memory Device Issues

- Devices connected to the USB port of your TV must be "Mass Storage Class" compliant. If your device (digital camera, MP3 player, portable hard disk, ...) is not "Mass Storage Class" compliant it will not be detected by the content browser of the TV.
- The following subsets of the Mass Storage Class specification are supported.
- The implementation of the TV is based on the "Universal Serial Bus Mass Storage Class Specification Overview" (v1.2, June 23, 2003) including all documents referenced by the document. The document can be found on the USB standardization website (www.usb.org).
- Full support of the USB Mass Storage Class Bulk-Only Transport (bInterfaceProtocol = 50h).
- Full support of SubClass Code = 05h; SFF-8070i spec.
- Full support of SubClass Code = 06h; SCSI transparent command set.
- For large USB memory devices, when you are in the Content Browser; it may take a long time before you can access your files.
- When using a USB portable hard disk, and due to the high power consumption of the hard disk, it is advised to use the external power supply of the portable hard disk to guarantee proper working under all conditions.

12 Specifications

Note

- Specifications are subject to change without prior notice.

Picture enhancement

Type:	WXGA (1366 × 768 pixels 60Hz)
Aspect ratio:	16:9
Viewing angles:	170° (V) by 170° (H)
Built-in digital tuner:	ATSC

Sound enhancement

Mono/Stereo:	Mono, Stereo, Virtual Surround Sound
Power output (RMS watts):	20W
Equalizer:	5 band

Ease of use

Video modes:	For 16:9 video signal / Normal, 4:3, Movie Expand, Zoom, Wide For 4:3 video signal / Normal, 16:9, Movie Expand, Zoom, Wide For PC input signal / Normal, Full, Unscaled
PC input:	via HDMI
Photo slide show:	Yes (jpeg files only)
MP3 playback:	Yes (mp3 files only)
Video playback:	Yes (Motion JPEG 320×240, 30fps only)

Connections

Component video input with audio L/R:	1, supporting video signals / 480i/p, 720p, 1080i, 1080p 60Hz
Composite video input with audio L/R and S-Video:	1
HDMI:	3 HDMI supporting video signals / 480i/p, 720p, 1080i, 1080p 24Hz-60Hz For HDMI 1 / PC-input signal up to WXGA
Audio L/R integrated with HDMI 1:	1
Digital audio output :	1, supporting Dolby Digital
Analog audio output :	1
USB:	1 (on the side of TV)

Power

Power requirements:	120V~ AC +/- 10%, 60Hz +/- 0.5%
---------------------	---------------------------------

LIMITED WARRANTY ONE (1) YEAR

WARRANTY COVERAGE:

This warranty obligation is limited to the terms as set forth below.

WHO IS COVERED:

This product warranty is issued to the original purchaser or the person receiving the product as a gift against defects in materials and workmanship as based on the date of original purchase ("Warranty Period") from an Authorized Dealer. The original sales receipt showing the product name and the purchase date from an authorized retailer is considered such proof.

WHAT IS COVERED:

This warranty covers new products if a defect in material or workmanship occurs and a valid claim is received within the Warranty Period. At its option, the company will either (1) repair the product at no charge, using new or refurbished replacement parts, or (2) exchange the product with a product that is new or which has been manufactured from new, or serviceable used parts and is at least functionally equivalent or most comparable to the original product in current inventory, or (3) refund the original purchase price of the product.

Replacement products or parts provided under this warranty are covered against defects in materials and workmanship from the date of the replacement or repair for ninety (90) days or for the remaining portion of the original product's warranty, whichever provides longer coverage for you. When a product or part is exchanged, any replacement item becomes your property and the replaced item becomes company property. When a refund is given, your product becomes company property.

Note: Any product sold and identified as refurbished or renewed carries a ninety (90) day limited warranty.

Replacement product can only be sent if all warranty requirements are met. Failure to follow all requirements can result in delay.

WHAT IS NOT COVERED - EXCLUSIONS AND LIMITATIONS:

This Limited Warranty applies only to new company manufactured products that can be identified by the trademark, trade name, or logo affixed to it. This Limited Warranty does not apply to any hardware product or any software, even if packaged or sold with the product, as manufacturers, suppliers, or publishers may provide a separate warranty for their own products packaged with the bundled product.

The company is not liable for any damage to or loss of any programs, data, or other information stored on any media contained within the product, or other additional product or part not covered by this warranty. Recovery or reinstallation of programs, data or other information is not covered under this Limited Warranty.

This warranty does not apply (a) to damage caused by accident, abuse, misuse, neglect, misapplication, or non-supplied product, (b) to damage caused by service performed by anyone other than company approved Authorized Service Location, (c) to a product

or a part that has been modified without written company permission, or (d) if any serial number has been removed or defaced, or (e) product, accessories or consumables sold "AS IS" without warranty of any kind by including refurbished product sold "AS IS" by some retailers.

This Limited Warranty does not cover:

- Shipping charges to return defective product.
- Labor charges for installation or setup of the product, adjustment of customer controls on the product, and installation or repair of antenna/signal source systems outside of the product.
- Product repair and/or part replacement because of improper installation or maintenance, connections to improper voltage supply, power line surge, lightning damage, retained images or screen markings resulting from viewing fixed stationary content for extended periods, product cosmetic appearance items due to normal wear and tear, unauthorized repair or other cause not within the control of the company.
- Damage or claims for products not being available for use, or for lost data or lost software.
- Damage from mishandled shipments or transit accidents when returning product.
- A product that requires modification or adaptation to enable it to operate in any country other than the country for which it was designed, manufactured, approved and/or authorized, or repair of products damaged by these modifications.
- A product used for commercial or institutional purposes (including but not limited to rental purposes).
- Product lost in shipment and no signature verification receipt can be provided.
- Failure to operate per Owner's Manual.

TO OBTAIN ASSISTANCE...

Contact the Customer Care Center at:
1-866-309-0841

REPAIR OR REPLACEMENT AS PROVIDED UNDER THIS WARRANTY IS THE EXCLUSIVE REMEDY FOR THE CONSUMER, WITH THE ISSUING COMPANY NOT LIABLE FOR ANY INCIDENTAL OR CONSEQUENTIAL DAMAGES FOR BREACH OF ANY EXPRESS OR IMPLIED WARRANTY ON THIS PRODUCT. EXCEPT TO THE EXTENT PROHIBITED BY APPLICABLE LAW, ANY IMPLIED WARRANTY OF MERCHANTABILITY OR FITNESS FOR A PARTICULAR PURPOSE ON THIS PRODUCT IS LIMITED IN DURATION TO THE DURATION OF THIS WARRANTY.

Some states do not allow the exclusions or limitation of incidental or consequential damages, or allow limitations on how long an implied warranty lasts, so the above limitations or exclusions may not apply to you.

This warranty gives you specific legal rights. You may have other rights which vary from state/province to state/province.

14 Index

A

Antenna, connect	9
Audio	17
Audio setting	17
Auto device off	21
Auto picture mode	15
Auto sound mode	17
Auto TV on	21
Auto volume leveling	17

C

Cables	
component	28
composite	28
connection quality	28
HDMI	28
manage cables	10
S-Video	28
YPbPr	28
Channels	
install	24
list	25
lock	18
Child lock	
channel lock	18
PIN	18
ratings lock	18, 19
Closed caption	20
Connections	9, 27, 29
Controls	6
Customer support service	5

D

Device List	21
--------------------	----

E

EasyLink	21
Eco	21
Environmental care	5
Equalizer	17

H

Home mode	11, 21
------------------	--------

I

Initial setup	11
----------------------	----

L

Location (retail or home)	11, 21
----------------------------------	--------

M

Master EasyLink	21
Mounting stand onto TV	8

P

PC	30
Picture format	16, 17
Picture settings	15

R

Ratings	18, 19
Remote control	
insert batteries	8
overview	6, 7
Retail mode	11, 21

S

Settings assistant	11
Signal quality	28
Sleeptimer	18
Software	
update	26
version	26
Sound settings	17
Speakers EasyLink	17
Specifications	32
Standby	6, 12
Subtitles	20

T

Troubleshooting	31
TV	
as PC monitor	16, 17, 30
connections	9, 27, 29
controls	6
menu	15
position	8
remote control	6, 7, 8
screen care	5
software	26
switch channels	12
switch on	11, 12
TV Speakers	17

U

USB	22, 32
------------	--------

V

Volume	
adjust	13
auto volume leveling	17
mute	13

W

Warranty	33
-----------------	----

Y

YPbPr	28
-------	----



P&F USA, Inc.
PO Box 430 Daleville, IN 47334-0430

P&F Mexicana, S.A. de C.V.
Av. La Palma No. 6, Col. San Fernando La Herradura,
Huixquilucan Edo. de México C.P. 52787

TELEVISOR A COLOR DE CRISTAL LIQUIDO (LCD)

MODELO	LCD	IMAGEN VISIBLE	ENERGIA
32PFL3506/F7	32"(81,28cm)	80,00cm	120V ~ 60Hz 130W

Comercializado por : **P&F MEXICANA, S.A. DE C.V.**
IMPORTADOR : **SOJITZ MEXICANA, S.A. DE C.V.**
Av. Paseo de las Palmas No. 239-302
Col. Lomas de Chapultepec, C.P. 11000
México, D.F. Tel. 52 (55) 5202 - 7222

EXPORTADOR : **FUNAI ELECTRIC CO.,LTD.**

ENSAMBLADO EN : **MEXICO**

GARANTIA INCLUIDA EN EL INSTRUCTIVO DE USO



**LEA CUIDADOSAMENTE ESTE INSTRUCTIVO
ANTES DE USAR SU APARATO.**

TELEVISOR A COLOR DE CRISTAL LIQUIDO (LCD)

MODELO	LCD	IMAGEN VISIBLE	ENERGIA
32PFL3506/F7	32"(81,28cm)	80,00cm	120V ~ 60Hz 130W

Comercializado por : **P&F MEXICANA, S.A. DE C.V.**
IMPORTADOR : **SOJITZ MEXICANA, S.A. DE C.V.**
Av. Paseo de las Palmas No. 239-302
Col. Lomas de Chapultepec, C.P. 11000
México, D.F. Tel. 52 (55) 5202 - 7222

PAIS DE ORIGEN : **CHINA**

GARANTIA INCLUIDA EN EL INSTRUCTIVO DE USO



**LEA CUIDADOSAMENTE ESTE INSTRUCTIVO
ANTES DE USAR SU APARATO.**