

ÖLEVIA™

User's Manual

LCD TV
HDTV Ready
3-Series

ÖLEVIA™

Syntax-Brilliant Corporation
20480 East Business Parkway
City of Industry, California 91789 USA
1-866-9-OLEVIA

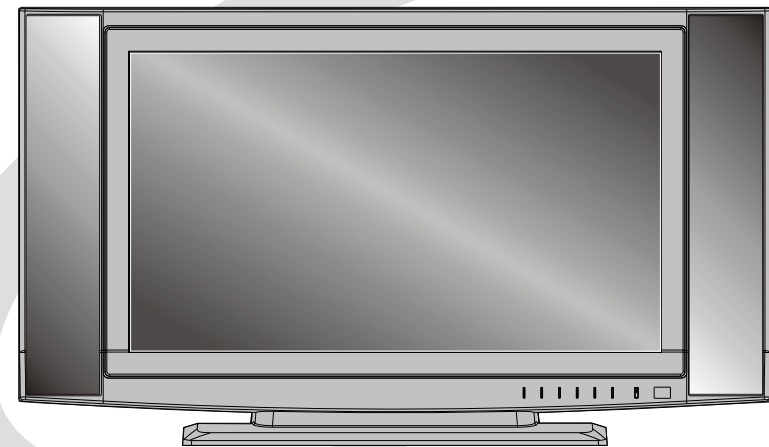

Table of Contents

Important Information	1
Important Safety Precautions	2
Introducing the Syntax-Brilliant OLEVIA TV	5
Accessories	9
TV Installation and Connection Guide	
Identifying Front Controls and Rear Panels	11
- Descriptions of Connector Types	12
- Connecting the Power Cord	13
Installation	14
- Connecting to an Antenna or Video Equipment with Antenna Outlet	15
- Connecting to a Set-Top-Box with HDMI Cables	16
- Connecting to a Satellite Receiver or Cable Box with Component Connectors	17
- Connecting to a DVD Player with A/V or S Video Cables	18
- Connecting to a DVD Player with Component Cables	19
- Connecting to a DVD Player with HDMI Cables	20
- Connecting to a Satellite Receiver or Cable Box with A/V Cables	21
- Connecting to a VCR, PVR, or DV with A/V Cables	22
- Connecting to a Blue-Ray DVD Player or HD-Receiver with HDMI Cables and a PC with VGA Cables	23
- Connecting to a D-VHS with HDMI Cables	24
- Connecting to a D-VHS with Component Cables	25
- Connecting to an Audio Receiver/Home Theater System	26
- Other Audio Connections	27
- Instruction for Uploading New Firmware	28
Remote Control Guide	
- Regular Buttons	29
- Battery Installation	30
On Screen Display (OSD)	31
Introduction	31
Operating in the OSD	31
PICTURE OSD Adjusting TV Picture Settings	32
- Description of Settings	32
- Initial Screen	32
- Selecting the Picture Mode	33
- Adjusting the Picture Quality	34
AUDIO OSD Adjusting Sound Quality	36
- Description of Settings	36
- Adjusting the Audio Settings	36
- MTS System for Stereo TV	37
SCREEN OSD Adjusting Screen Modes	38
- Description of Settings	38
- Changing the Screen Mode	38
- Selecting the Picture/Video Source	39
SETUP OSD Adjusting Personal TV Settings	40
- Description of Settings	41
- Searching the TV Channels	41
- Editing Channels	42
- Closed Caption Options	43
- Setting up Parental Control Password	44
- Activating the Parental Control Feature	44
- Resetting the Password	52
- Setting the Date and Time	53
- Setting the TV Timer	54
- Timeout Settings for OSD Menu	54
- TV OSD Languages	55
- Setting DPMS	55
- Factory Default Option	55
- Displaying the Firmware Version	55
Specifications	56
Timing Mode for VGA	58
Pixels Policy	59
Glossary	60

Important Information



Caution
Risk of electronic shock
Do not open



To reduce the risk of electronic shock, do not remove cover (or back).
No user-serviceable parts inside.
Refer service to qualified Repair Technician or Repair Center.



Read the following context indicated by the following symbol to the left. It indicates important literature in operating the product.



Read the following context indicated by the following symbol to the left. It indicates a potential high voltage hazard that may compromise your safety.



Caution

Take caution when moving the product on a cart. Quick stops, excessive force, and uneven surfaces may cause the display unit and cart combination to overturn.

Caution

To prevent electric shock, match wide blade of plug to wide slot, fully insert.

Caution

This product satisfies FCC regulations when shielded cables and connectors are used to connect the unit to other equipment. Prevent electromagnetic interference from electrical appliances such as radios and televisions. Please use shielded cables and connectors for connections.

Warning

FCC Regulations state that any unauthorized changes or modifications to this equipment not expressly approved by the manufacturer could void the user's authority to operate this equipment.

Important Safety Precautions

Cleaning

Remember to unplug the AC cord from the AC outlet before cleaning the display unit.

Then spray small amount original WINDEX window clearer (blue stuff), not Ammonia-added clearer, on cloth to clean the display.

Remember to use only soft cotton cloth such as an old 100% cotton T-shirt, not sponges brillo abrasive material, to clean the display.

No drips allowed.

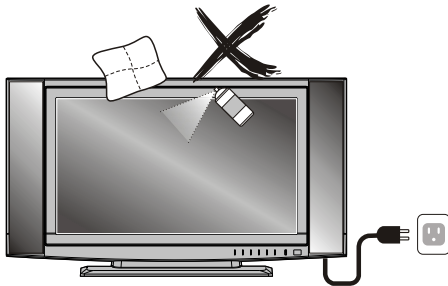

Ventilation

Do not cover or block these vents and openings located on the top and back of the display. Inadequate ventilation may cause overheating and shorten the lifespan of the display.

Do not place in an enclosed area such as a built-in shelf, unless proper ventilation is provided or the manufacturer's instructions are followed. Keep the distance of 10cm minimum between the display unit and wall. Never install the display unit as indicated in the picture below.

Stand

Do not place the display unit on an unstable place.

The TV may fall resulting in serious personal injuries to nearby people as well as damage to the display unit.

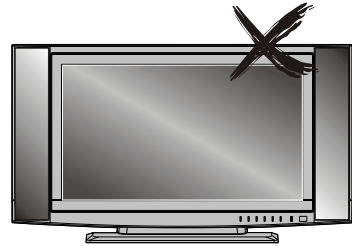

Air circulation is blocked

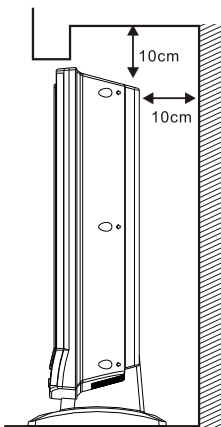

Air circulation is blocked

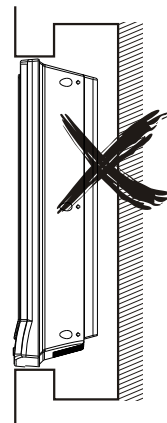

Never insert objects or spill liquid into the display unit

Never insert any object into the display unit through openings or spill liquid on the display unit. High voltage flows in the display unit, and inserting an object can cause electric shock and/or short internal parts.

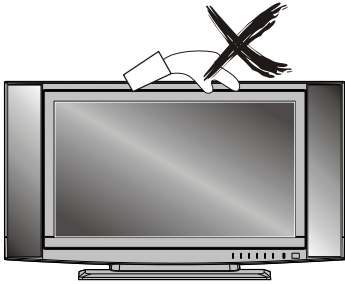

Keep away from water and moisture

Do not place the display in areas where moisture is present or where the unit may get wet such as bathrooms, kitchen, pool area or in a wet basement.

Keep away from heat sources

Keep the display unit away from heat sources such as radiators, heaters, stoves and other heat-generating products.

The liquid crystal panel used in this product is made of glass

Do not hit the panel. Be careful to prevent from getting hurt by broken glass pieces in case the panel breaks.

Follow operating instructions

All operating instructions must be followed.

Servicing

Do not attempt to service the display unit yourself. Removing covers expose you to high voltage and other dangerous conditions. Request a qualified service technician to perform the service.

Precautions when transporting the display

Carrying the display requires two or more people.

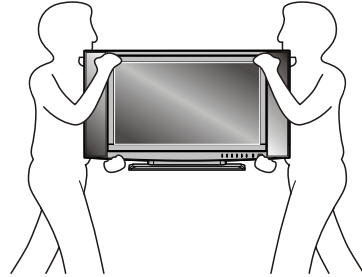

Attachments

Do not use attachments not recommended by the manufacturer. Use of inadequate attachments may result in accidents to nearby people or to the unit.

Power source

This product must operate on a power source specified on the specification label. If you are not sure of the type of power supply used in your home, consult your dealer or local power company. For units designed to operate on batteries or another power source, refer to the operating instructions.

AC cord protection

The AC cords must be routed properly to prevent people from stepping on them or objects from resting on them. Check the cords at the plugs and product.

Wall mounting

Be sure to install the display unit according to the method recommended by the manufacturer. Use only the mounting hardware recommended by the manufacturer.

Overloading

Do not overload AC outlets or extension cords. It may result in electric shock or start a fire.

Replacement parts

In case the display unit needs replacement parts, make sure that the service technician uses replacement parts specified by the manufacturer, or those with the same characteristics and performance as the original parts. Use of unauthorized parts can result in fire, electric shock and/or other danger.

Safety checks

Upon completion of service or maintenance, request the service technician to perform safety checks to ensure that the display unit is in proper operating condition.

Repair

When the display unit displays an abnormal condition, any noticeable abnormality in the display unit indicates that the display unit needs servicing. If any of the following conditions occurs, unplug the AC cord from the AC outlet, and request a qualified service person to perform repairs.

1. A liquid was spilled on the display unit or objects have fallen into the display unit.
2. The display unit has been exposed to rain or water.
3. The display unit has been dropped or damaged.

Environment

The display unit only operates within the temperature 0°C to 40°C. Operation outside of the recommended may cause damage to your product.

Warning



When installing or realigning an outside antenna system, extreme care should be taken to keep from touching such power lines or circuits. Contact with them could be fatal.

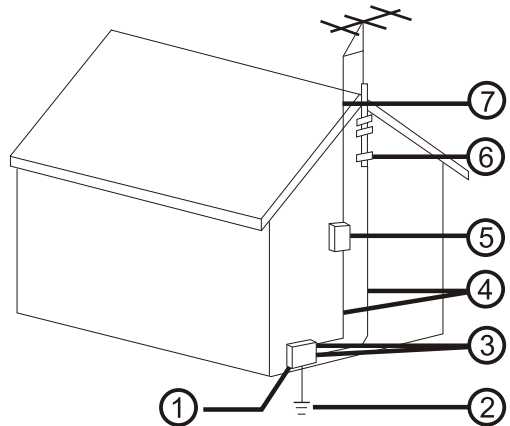

Antenna and satellite grounding

Reference	Grounding component
1	Electric service equipment
2	Power service grounding electrode system (NEC Art 250. Part H)
3	Ground clamps
4	Grounding conductors (NEC Section 810-21)
5	Antenna discharge unit (NEC Section 810-20)
6	Grounding clamp
7	Antenna lead-in wire

Introducing the Syntax-Brilliant™ OLEVIA TV

Welcome!

Thank you for purchasing a Syntax-Brilliant™ OLEVIA HDTV Ready. This manual is to be used with the following model:

OLEVIA 3 Series

This manual is designed to help you through setting up and operating your HDTV Ready as quickly as possible. The model and serial numbers are on the back cover of your TV. Write these numbers in the space provided in this manual for your records. Please read all the safety and operating instructions carefully, and keep this manual for future reference.

Owner's Record

The model and serial numbers are located at the rear of the display unit, or on the side of the media receiver unit on the cartons (white label). Record these numbers in the spaces provided below. Refer to them whenever you call Syntax-Brilliant™ Groups Corporation or local dealer regarding this product.

Model No. _____

Serial No. _____

Package Contents

- Syntax-Brilliant™ OLEVIA display unit
- Remote Control
- 1 AC power cord
- Quick Start Guide
- Warranty Card

These items are all you need to set up and operate the TV in its basic configuration.

Note: Most components (VCRs, DVD players, etc.) come with the necessary cables to connect them. If you want to set up a complex system, you may need to buy extra cables, connectors, etc. Be sure to have these on hand before you start to connect your system.

Syntax-Brilliant™ OLEVIA HDTV Ready includes many features, you will enjoy throughout the usage of your TV. These highlighted features include:

Fully Integrated HDTV (High Definition TV):

HDTV delivers a stunning picture far beyond the quality of standard televisions. These programs offer crystal clear video with amazing detail played with enhanced audio quality of digital television programs. You can enjoy better sound and picture in movies, prime time TV shows, and other HD broadcasts in dynamic television settings through cable, satellite or even free broadcasts over the air.



HDMI (High Definition Multimedia Interface):

The next generation of DVI, HDMI provides the best interface between a DVD player and compatible products such as digital set top box for uncompressed digital audio/video connections. When matched with a Syntax-Brilliant™ OLEVIA HDTV Ready, multi-channel digital audio signals, uncompressed DVI digital video and intercommunication between high multimedia interfaces are combined through a single interconnecting cable.



DNX™ Video Technology Feature Overview

Pixelworks offers a suite of technologies designed for the advanced television market which we call DNX Digital Natural Expression™. Pixelworks' DNX video processing technology dramatically improves the quality of video images by combining multiple enhancement techniques to deliver clear, natural-looking standard and high-definition video images. DNX technology utilizes sophisticated digital video processing to deliver a lifelike picture through a combination of techniques.



©DNX Motion-Adaptive De-Interlacing with LAI Technology.

A proprietary video processing technology to convert interlaced content into progressive content that virtually eliminates image artifacts such as stair-stepping -- or 'jaggies' -- that can occur with less sophisticated techniques. Our motion-adaptive de-interlacing analyzes the content and applies the most appropriate methods for both standard and high-definition television formats. In addition, DNX Motion-Adaptive De-Interlacing automatically recognizes when incoming signals were originally captured on film so that special methods are employed to display the content.

LAI technology uses video processing algorithms, including advanced motion-adaptive deinterlacing for both standard television formats and also high-definition television formats, automatic film mode detection with 3:2 and 2:2 pull-down, per pixel noise reduction, and low-angle edge detection to virtually eliminate 'jaggies' and other image artifacts.

©DNX Rich Color Processing.

A technology that renders more than one billion colors with 10-bit color processing, it also optimizes content appearance for various display technologies. While several companies have developed and sold 10-bit processing using expensive proprietary solutions, we believe Pixelworks currently has the only commercially available true 10-bit processing solution.

©DNX Video Enhancement Processing.

Most content has been encoded in order to enhance its appearance on CRT-based televisions which makes it appear unnatural when displayed on LCDs, DMDs and PDPs. Our DNX Video Enhancement Processing enables manufacturers to apply filters that compensate for the signals in order to produce sharp, rich picture quality.

©DNX CleanScreen™ Digital Noise Reduction.

Digital displays often appear to create movement where none exists, because pixels flicker in areas where there is no motion and that creates a distracting shimmering effect referred to as 'noise.' We have developed proprietary per-pixel technology that minimizes noise for a stable, accurate video image.

©DNX Advanced Image Scaling.

Since advanced displays typically use digital fixed-pixel panels, it is a constant challenge to reconfigure incoming content (video or PC) that do not match the display resolution. Pixelworks has developed innovative, industry leading image scaling technologies that intelligently enlarge or compress images for displaying different resolutions or aspect ratios i.e., the ratio of width to height of display screens. This technology is essential for interfacing fixed resolution digital displays to the wide range of inputs present in today's marketplace, including high-definition television, or HDTV. Our image processing technology incorporates programmable image scaling capable of resizing images to fit a wide variety of aspect ratios.

©Adaptive Image Optimization.

Our products must translate a broad range of signals in standard and non-standard formats. We use a proprietary image processing technique to identify the characteristics of an incoming signal and configure the system to produce the best possible image.

©**Color Compensation Technology.**

Our custom color compensation technology makes it possible to display consistent color images from video and computer graphics, which use very different color palettes, on different display devices. Our color processing technology compensates for variations in the color performance of a display. Using our approach, any color can be addressed independently and adjusted without impacting other colors.



©**Fully Customizable On-Screen Display.**

By coupling an integrated on-screen display controller with an industry-first development tool, we allow customers to quickly develop and implement their own unique user interfaces with up to 256 colors and can incorporate graphics and colorful icons in start-up displays and menus.

©**Intelligent Windowing.**

Intelligent windowing offers consumers control over how they view multiple content simultaneously. Our ImageProcessor ICs are capable of displaying video and computer content in various, user-controlled formats such as side-by-side, Picture-In-Picture (PIP), and Picture-On-Picture (POP). As many as 12 images from various other sources or channels can be monitored while watching a primary viewing window. Our Intelligent Windowing delivers additional flexibility with adjustable transparency and user-controlled resizing of windows.

Accessories

Supplied Accessories

Remote control & batteries (AAA x 2)

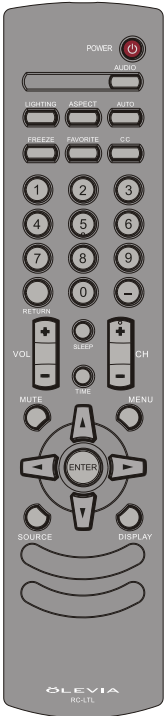

Power cord x 1



User manual
(CD-ROM) x 1



QSG x 1



Warranty Card x 1



Optional Accessories

Wall Mount Set

Model # WM10D : available
for 20" ~23" Models



Model # WM30D : available

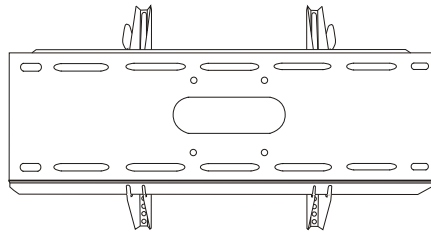

1. Before using the wall mount, please read its Quick Start Guide and follow assembly guide.
2. For safety purpose, please purchase wall mount that will support the HDTV Ready weight.
3. Following installation instruction is only for your reference.
4. Please consult authorized service personnel for the installation of wall mount.

TV Installation and Connection Guide

Identifying Front and Rear Panels

Front Panel

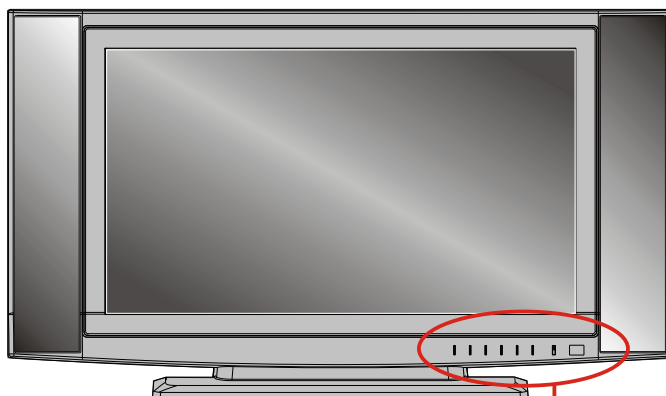

POWER Turns display on/off

MENU Displays the On Screen Display(OSD) menu. In OSD menu, press it to return to the previous screen or to exit.

CH▲ / CH▼ Adjusts Channel. In the OSD menu, both keys are used to navigate within menu.

VOL+/VOL- Adjusts Volume. In the OSD menu, both keys are used to navigate within menu. Vol+ is used to select the highlighted option.

SOURCE Press to switch the input sources.



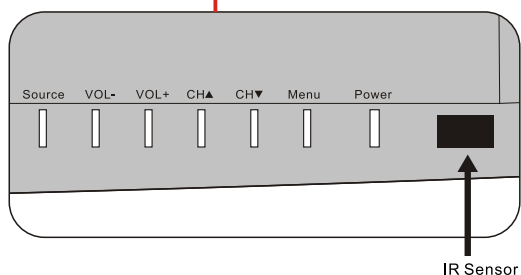





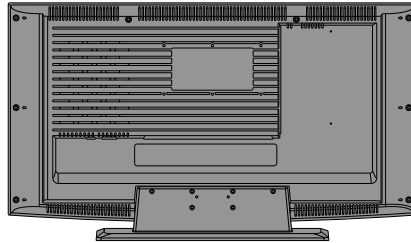

IR SENSOR Contains Infra-red light for digital data transmission by the remote control. Please point remote control at IR Sensor for function.

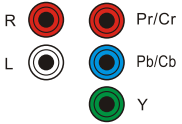

Identifying Front and Rear Panels





Rear Panel



1 Power Connections	
AC In 	The power cord connects here.
2 Computer / TV Signal Connections	
RF Terminal 	To receive signals from VHF / UHF antennas or a cable system (For TV Models Only)
Component 	(5 RCA jacks) Used to connect A/V equipment with component video outputs, such as a DVD player, Digital Satellite Receiver, or compatible Video Game System. NOTE: The component inputs have a superior quality of picture than the S-Video or AV (composite video) inputs.
Video 	AV (Composite Video: 3 RCA jacks): Used to connect a VCR, Super VHS (S-VHS), DVD player, or other video devices to the TV. OR S-Video : (1 DIN and 2 RCA jacks) Used to connect video devices to the TV. However, they have a better quality of picture than a composite video signal.
HDMI/DVI 	Used to connect digital video equipment with a HDMI/DVI output. NOTE: Preferred connection for HDMI/DVI Satellite or Set-Top-Box equipment.
VGA/Audio Input (PC) Port 	Used for analog RGB signals from a personal computer. VGA has 1 Audio input. OR As a computer input with VGA to RCA Adapter.
Audio Input 	To send an AV receiver or other equipment to the TV's connected audio signals
USB Service Port 	To download some information from website to TV for user
RS232 Service Port 	Only for Service Technician use, not an interface for other devices. Warning ! This RS232 control port is for service purpose only, and should be used by trained serviceman only. Any random connection may cause damage to this unit.
Earphone 	Used for audio output to earphone.

Descriptions of Connector Types

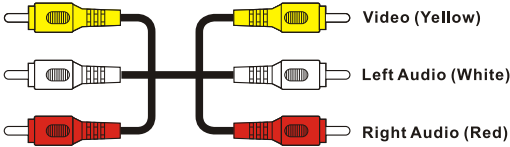
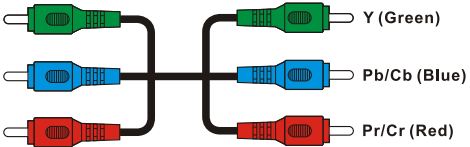
You may find it necessary to use some of the following cable types during setup.

<p><u>75-ohm Coaxial Cable</u></p> 	<p>For TV/cable connection (For TV Models Only)</p>
<p><u>S-Video Cable</u></p> 	<p>Used for transferring video signal, which is split into two signals, brightness and color.</p> <p>Through this connection, you can view a better picture than AV (Composite Video) connection.</p>
<p><u>Audio/Video Cable</u></p>  <p>Video (Yellow)</p> <p>Left Audio (White)</p> <p>Right Audio (Red)</p>	<p>Used for transferring audio and video signal.</p> <p>This connection is the most commonly found on A/V equipment.</p>
<p><u>Component Cable</u></p>  <p>Y (Green)</p> <p>Pb/Cb (Blue)</p> <p>Pr/Cr (Red)</p>	<p>Used for transferring video signal, which is split into three signals, one brightness and two color.</p> <p>Through this connection, you can view a better high definition picture than S-Video or AV (Composite Video) connection.</p>
<p><u>HDMI Cable</u></p> 	<p>Used for transferring digital uncompressed video and audio signals to the TV.</p> <p>HDMI signal is purely digital and provides a crystal clear technology better than component, S-Video or Video connections. It is strongly recommended to use this connection if you have this function on your equipment.</p>

Connecting the Power Cord

Complete other connections prior to connecting the power cord:

1. Connect the power cord to the AC IN connector of the TV.

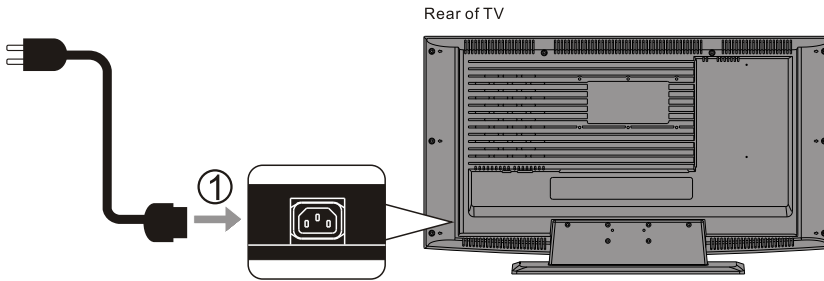

2. Connect the other end of the power cord to the wall outlet.

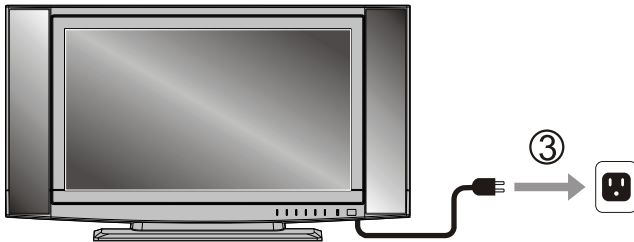

Installation

In the following pages, you will find directions on how to install your tv and choice of video equipment.

- **Connecting to an Antenna or Video Equipment with Antenna outlet**
- **Connecting to a Set-Top-Box with HDMI Cables (Preferred TV connection)**
- **Connecting to a Satellite Receiver or Cable Box with Component Connectors (Secondary Preferred after HDMI)**
- **Connecting to a DVD Player with A/V or S Video Cables**
- **Connecting to a DVD Player with Component Cables**
- **Connecting to a DVD Player with HDMI Cables**
- **Connecting to a Satellite Receiver or Cable Box with A/V Cables**
- **Connecting to a VCR, PVR, or DV with A/V Cables**
- **Connecting to a Blue-Ray DVD Player or HD-Receiver with HDMI Cables and a PC with VGA Cables**
- **Connecting to a D-VHS with HDMI Cables**
- **Connecting to a D-VHS with Component Cables**
- **Connecting to an Audio Receiver/Home Theater System**
- **Other Audio Connections**
- **Instruction for Uploading New Firmware**

Connecting to an Antenna or Video Equipment with Antenna outlet (For Analog TV Source, and TV Model Only)

⚠ Disconnect all power sources before making any connection.

1. Connect a 75-ohm coaxial cable (or choice of Antenna Cable) from your cable or antenna to the TV's Antenna jack (RF Terminal).

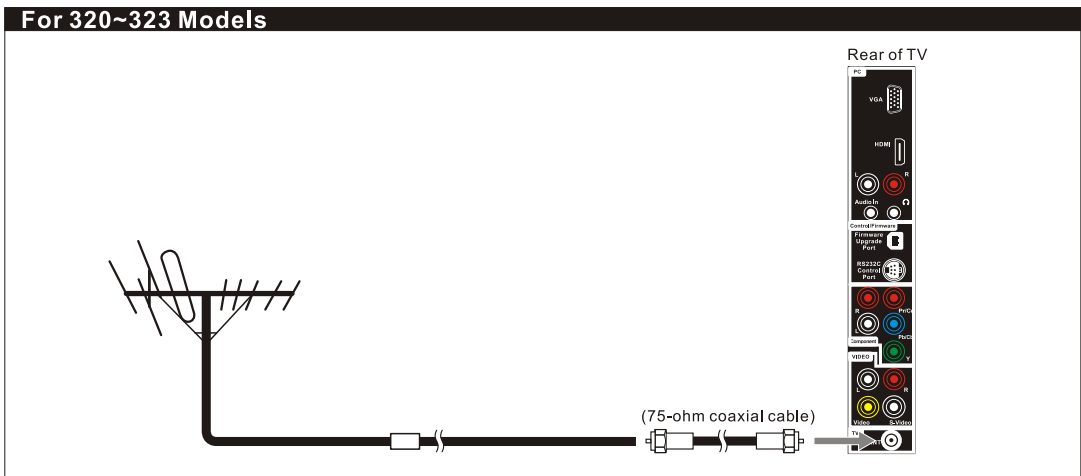

If connecting to Video Equipment with Antenna outlet

1. Connect a 75-ohm coaxial cable (or choice of Antenna Cable) from your cable or antenna to the Video Equipment's IN jack.
2. Connect another 75-ohm coaxial cable from the Video Equipment's OUT jacks to the TV's Antenna jacks (RF Terminal).

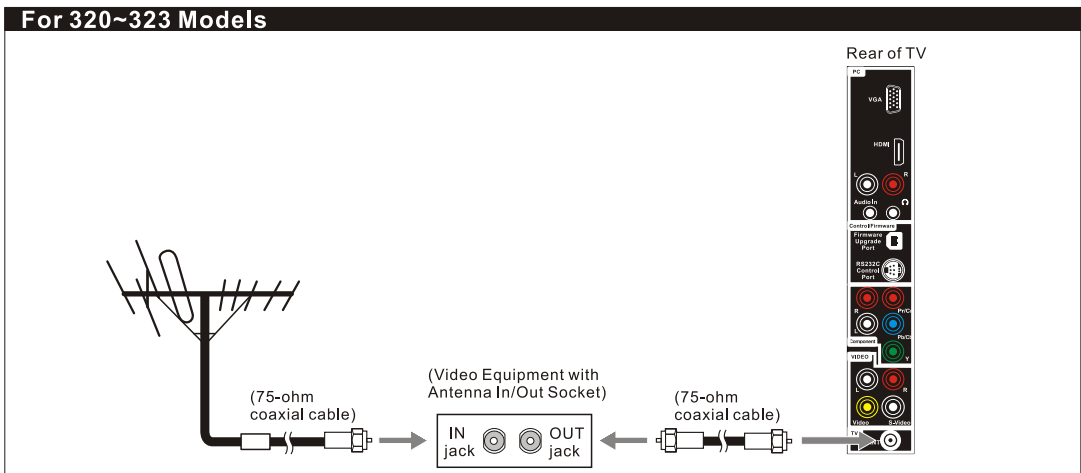

Connecting to a Set-Top-Box with HDMI Cables (Preferred TV connection)

⚠ Disconnect all power sources before making any connection.

1. Connect a 75-ohm coaxial cable (or choice of Antenna Cable) from your cable or antenna to the Set-Top-Box's Antenna jack (RF Terminal).
2. Connect a HDMI cable from the Set-Top-Box's HDMI OUT jacks to the TV's HDMI IN jacks.

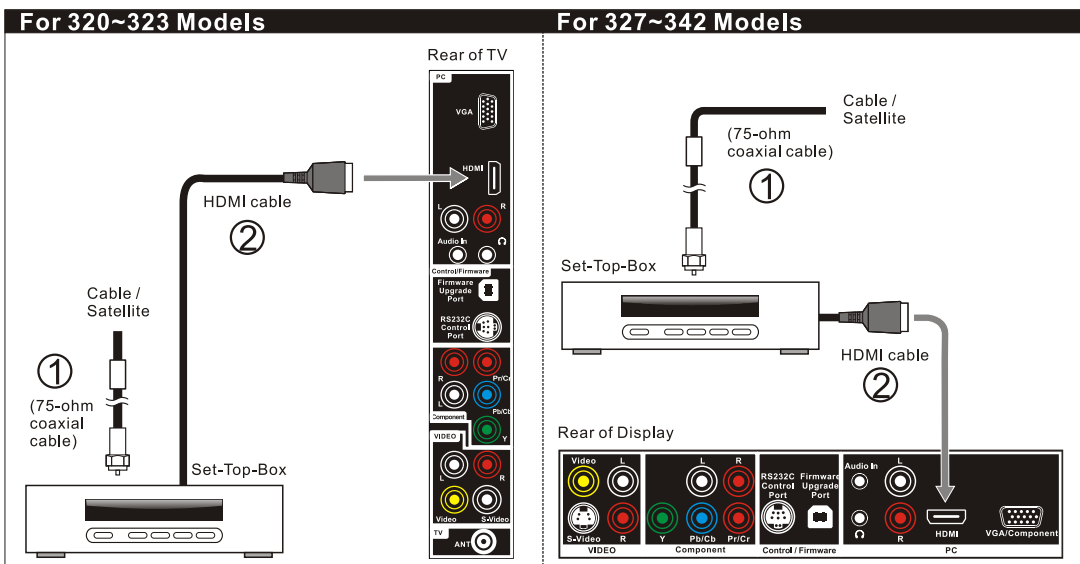

Note: HDCP is a copy protected digital connection that receives analog or digital video and audio signals from equipment with a HDMI output that features the HDCP function. HDMI allows the transfer of digital uncompressed data to the TV. This connection is superior when compared to the Component, S Video or AV (composite) connections.

Note: HDMI signal is purely digital and provides a better picture, it is better than component, S-Video or Video connections. It is strongly recommended to use this connection if you have this function on your equipment.

Connecting to a Satellite Receiver or Cable Box with Component Connectors (Secondary Preferred after HDMI)

⚠ Disconnect all power sources before making any connections.

Use this method of connection if your Satellite Receiver or Cable Box has component (Y, Pb, Pr) jacks.

1. Using a component video cable, connect the Satellite Receiver or Cable Boxes' Y, Pb and Pr jacks to the Y, Pb and Pr jacks on the TV.

Colors on Component Video connectors:

Y: Green

Pb (also identified as Cb, CB or B-Y): Blue

Pr (also identified as Cr, CR or R-Y): Red

Note: The Y, Pb and Pr jacks on your Satellite Receiver or Cable Box are sometimes labeled as Y, Cb and Cr, or B-Y and R-Y. If so, connect the cables to the matching colors.

2. Using an Audio cable, connect the Satellite Receiver or Cable Boxes' Audio OUT jacks to the TV's Audio in jacks.

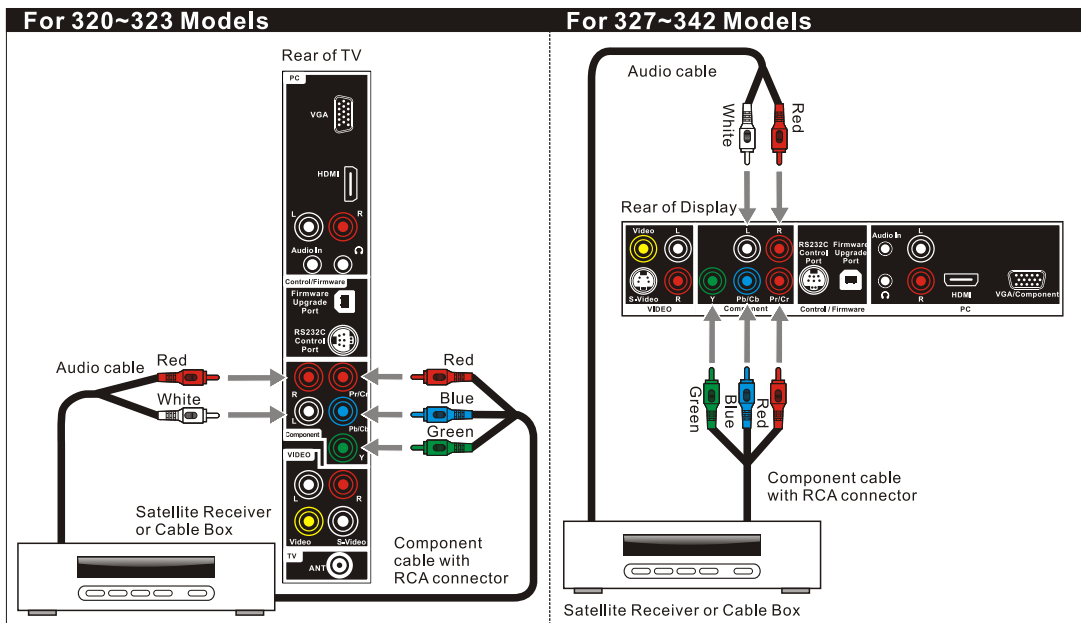

Note: The Y, Pb and Pr jacks do not provide audio, so audio cables must be connected to provide sound.

Note: The YPbPr connection provides the best quality of video signal compared to AV (composite) and S-Video connection.

Note: YPbPr is set at default to best perform with HD 720p and 1080i content, set Input to "Interlace DVD" for best performance with regular 480i and 480p content.
(Menu - Picture - Mode - Input = "Interlace DVD")

Connecting to a DVD Player with A/V or S Video Cables

⚠ Disconnect all power sources before making any connections.

Use this method of connection if your DVD player does not have component (Y, Pb, Pr) jacks.

Note: If your DVD player has component video output connectors, for best picture quality, use the connection described for *Connecting to a DVD Player with Component Connectors.* (See page. 19)

1. Using an A/V cable, connect the DVD player's Audio OUT jacks to the TV's Audio IN jacks.
2. Using an S-Video Cable, connect the DVD player's S Video OUT jack to the TV's S Video IN jack.

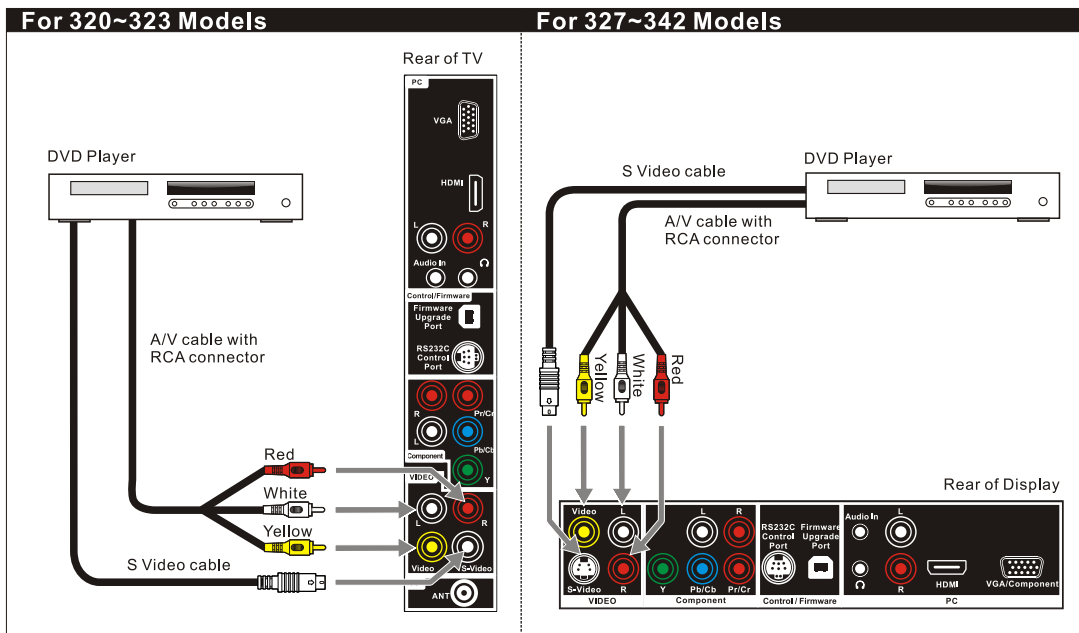

Note:

S-Video is strongly recommended for use if your VCR or video equipment has the option. S-Video input has better quality of picture than a composite Video signal.

Connecting to a DVD Player with Component Cables

⚠ Disconnect all power sources before making any connections.

Use this method of connection if your DVD Player has component (Y, Pb, Pr) jacks.

1. Using a component video cable, connect the DVD Player's Y, Pb and Pr jacks to the Y, Pb and Pr jacks on the TV.

Colors on Component Video connectors:

Y: Green

Pb (also identified as Cb, CB or B-Y): Blue

Pr (also identified as Cr, CR or R-Y): Red

Note: The Y, Pb and Pr jacks on your DVD player are sometimes labeled as Y, Cb and Cr, or B-Y and R-Y. If so, connect the cables to the matching colors.

2. Using an Audio cable, connect the DVD player's Audio OUT jacks to the TV's Audio in jacks.

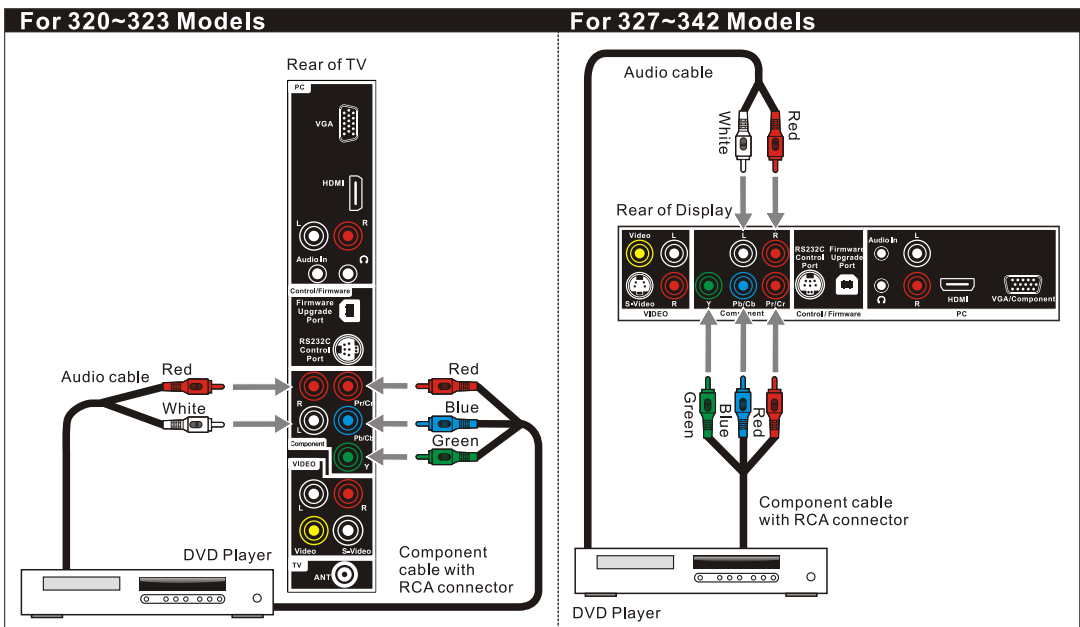

Note: The Y, Pb and Pr jacks do not provide audio, so audio cables must be connected to provide sound.

Note: The YPbPr connection provides the best quality of video signal compared to AV (Composite) and S-Video connection.

Note: YPbPr is set at default to best perform with HD 720p and 1080i content, set Input to "Interlace DVD" for best performance with regular 480i and 480p content. (Menu - Picture - Mode - Input = "Interlace DVD")

Connecting to a DVD Player with HDMI Cables

⚠ Disconnect all power sources before making any connections.

Use this method of connection if your DVD Player has HDMI jacks.

1. Using a HDMI cable, connect the DVD Player's HDMI output terminal to the TV's HDMI-HDCP input terminal.

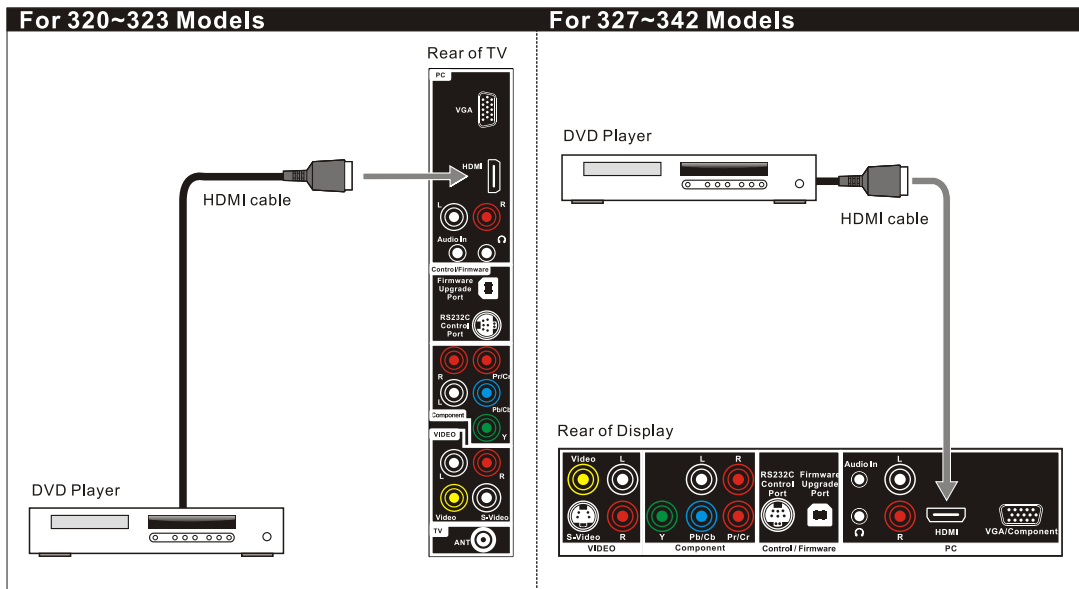

Note : HDCP is a copy protected digital connection that receives analog or digital video and audio signals from equipment with a HDMI output that features the HDCP function. HDMI allows the transfer of digital uncompressed data to the TV. This connection is superior when compared to the Component, S Video or AV (composite) connections.

Note : HDMI signal is purely digital and provides a better picture, it is better than component, S-Video or Video connections. It is strongly recommended to use this connection if you have this function on your equipment.

Connecting to a Satellite Receiver or Cable Box with A/V Connectors

⚠ Disconnect all power sources before making any connections.

1. Connect a 75-ohm coaxial cable from your Cable TV to the Satellite Receiver's or Cable Box's Ant (Antenna) jack.
2. Using Audio and S Video cables, connect the satellite receiver's Audio and S-Video OUT jacks to the TV Audio and S Video IN jacks.

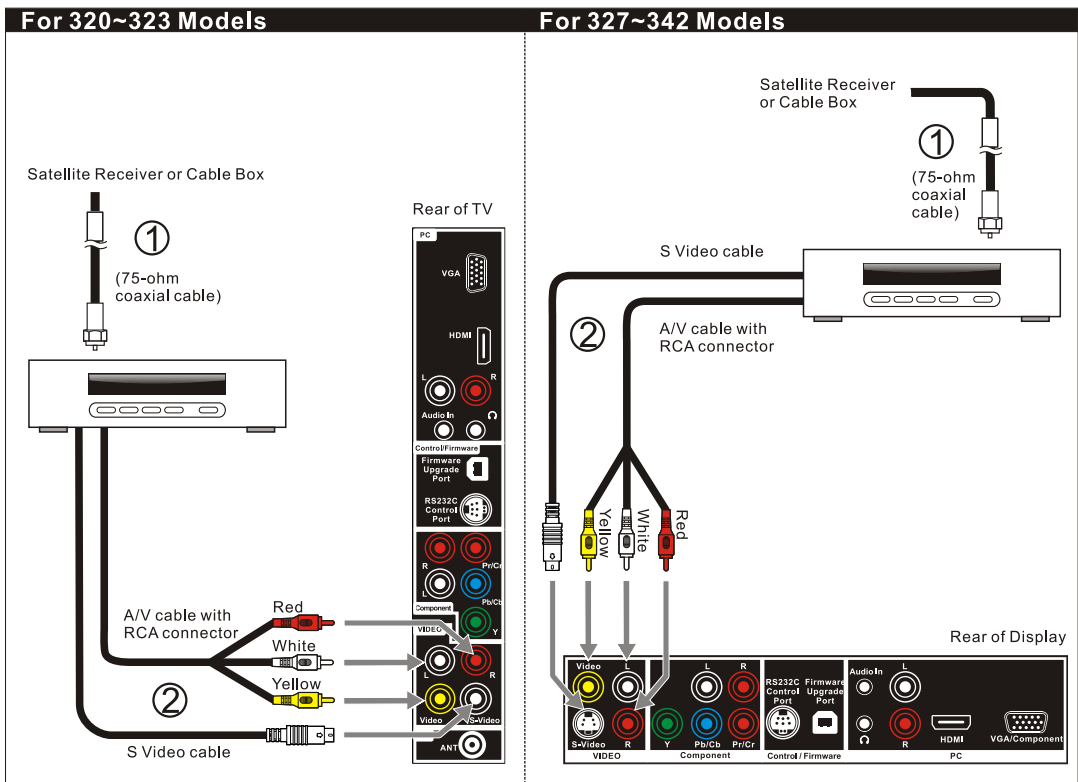

Note:

S-Video is strongly recommended for use if your VCR or video equipment has it because S-Video input has better quality of picture than a composite Video signal.

Connecting to a VCR, PVR, or DV with A/V Cables

⚠ Disconnect all power sources before making any connections.

1. Using A/V cable and S-Video cables, connect the video equipment's Audio and S-Video OUT jacks to the TV's Audio and S-Video In jacks.

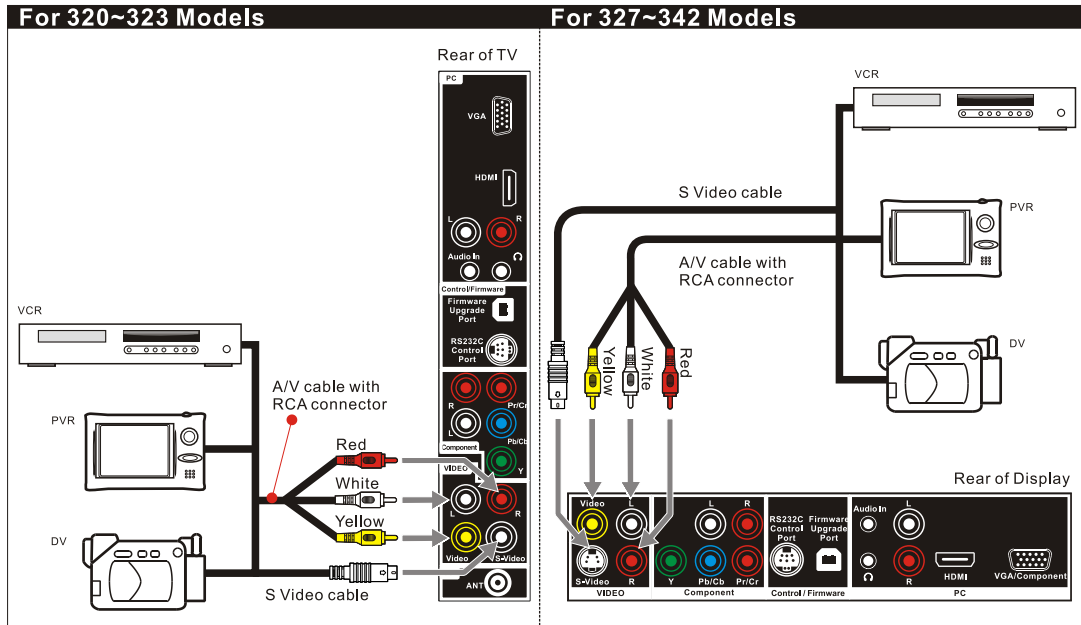

Note:

S-Video is strongly recommended for use if your VCR or video equipment has it. S-Video input has a better quality of picture than a composite Video signal.

Connecting to a Blue-Ray DVD Player or HD-Receiver with HDMI Cables

⚠ Disconnect all power sources before making any connections.

1. Using a HDMI cable, connect the DVD's HDMI output terminal to the TV's HDMI-HDCP input terminal.

Note: HDCP is a copy protected digital connection that receives analog or digital video and audio signals from equipment with a HDMI output that features the HDCP function. HDMI allows the transfer of digital uncompressed data to the TV. This connection is superior when compared to the Component, S Video or AV (composite) connections.

Note: HDMI signal is purely digital and provides a better picture, it is better than component, S-Video or Video connections. It is strongly recommended to use this connection if you have this function on your equipment.

Connecting to a PC with VGA Connector

⚠ Disconnect all power sources before making any connections.

1. Using a D-Sub 15 pin cable, connect the VGA output terminal of the PC to the TV's VGA signal input terminal.
2. You may need to use a Stereo mini jack to Audio in connectors to receive audio.

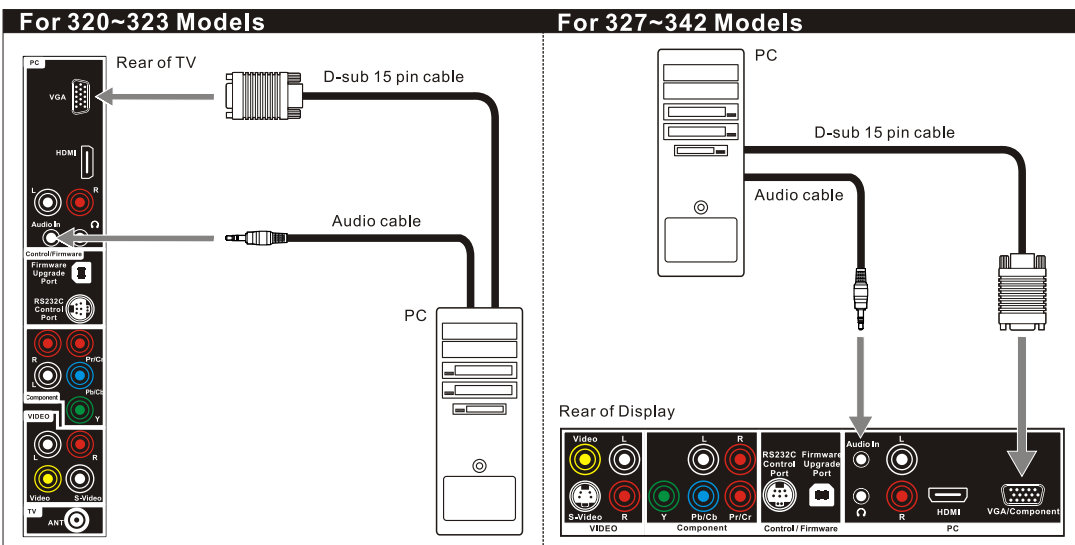
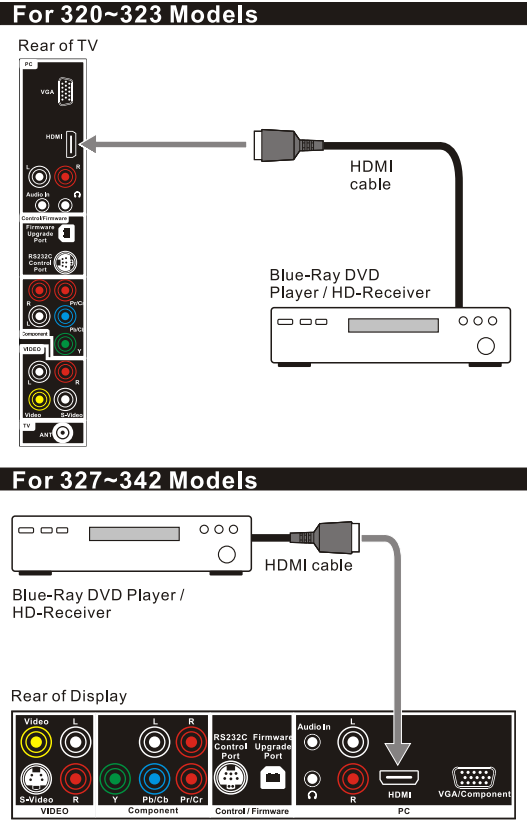

Connecting to a D-VHS with HDMI Cables

⚠ Disconnect all power sources before making any connections.

1. Connect a 75-ohm coaxial cable from your cable or antenna to the Set-Top-Box's Antenna jack.
2. Using Audio and S-Video (YPbPr, or HDMI is strongly recommended) cables, connect the Set-Top-Box's Audio and S-Video OUT jacks to the TV's Audio and S-Video IN jacks.
3. Connect an I-Link cable from the Set-Top-Box to the D-VHS equipment for video transmission and record.
4. Using a HDMI cable, connect the D-VHS's HDMI OUT jack to the TV's HDMI IN jacks for watching the recorded videos.

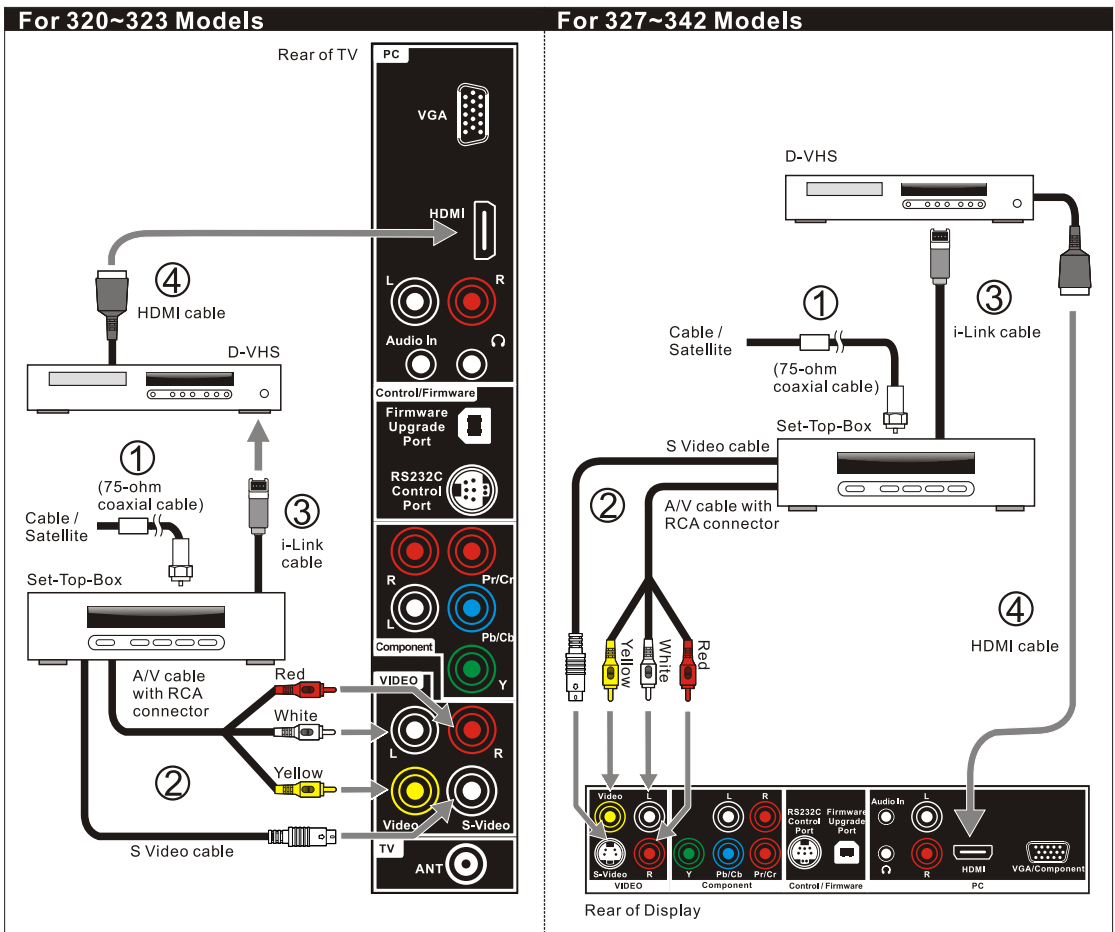

Note: HDCP is a copy protected digital connection that receives analog or digital video and audio signals from equipment with a HDMI output that features the HDCP function. HDMI allows the transfer of digital uncompressed data to the TV. This connection is superior when compared to the Component, S Video or AV (composite) connections.

Note: HDMI signal is purely digital and provides a better picture, it is better than component, S-Video or Video connections. It is strongly recommended to use this connection if you have this function on your equipment.

Connecting to a D-VHS with Component Cables

⚠️ Disconnect all power sources before making any connections.

Use this method of connection if your D-VHS has component (Y, Pb, Pr) jacks.

1. Connect a 75-ohm coaxial cable from your cable or antenna to the Set-Top-Box's Antenna jack.
2. Using Audio and S-Video (YPbPr, or HDMI is strongly recommended) cables, connect the Set-Top-Box's Audio and S-Video OUT jacks to the TV's Audio and S-Video IN jacks.
3. Connect an I-Link cable from the Set-Top-Box to the D-VHS equipment for video transmission and record.
4. Using Audio and Component video cables, connect the D-VHS's Audio and Y, Pb and Pr OUT jacks to the TV's Audio and Y, Pb and Pr IN jacks for watching the recorded videos.

Colors on Component Video connectors:

Y: Green

Pb (also identified as Cb, CB or B-Y): Blue

Pr (also identified as Cr, CR or R-Y): Red

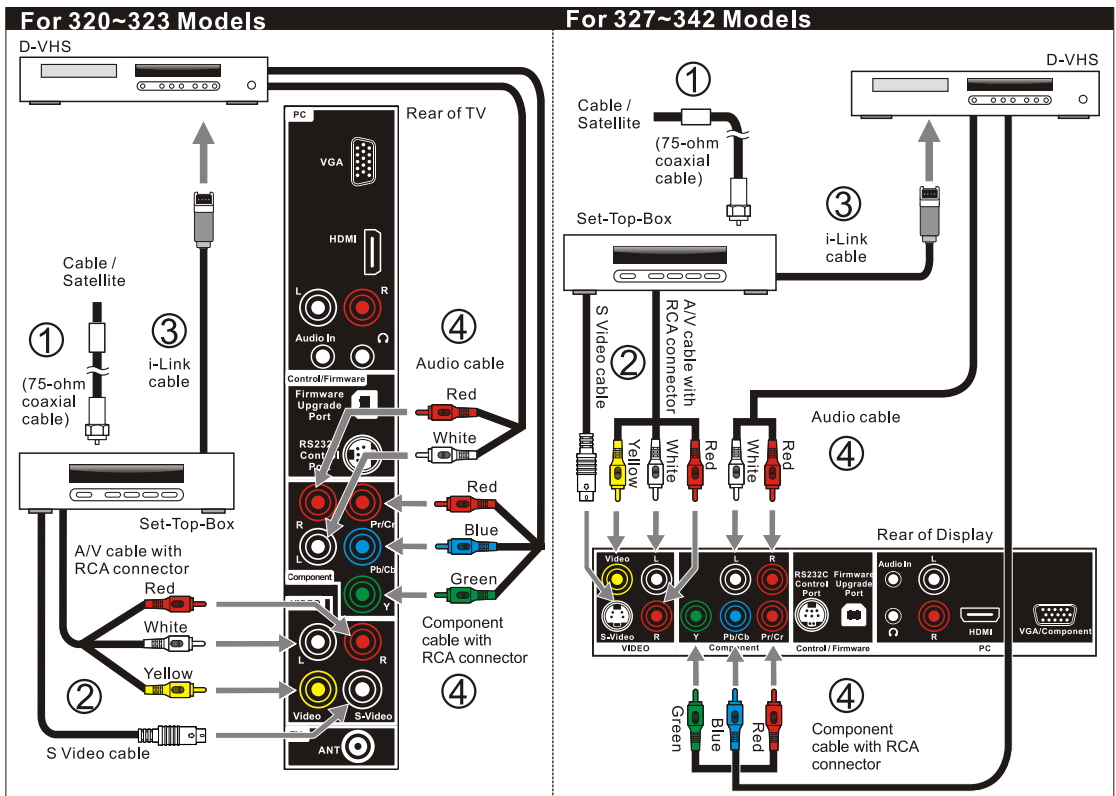

Note: The Y, Pb and Pr jacks do not provide audio, so audio cables must be connected to provide sound.

Note: The YPbPr connection provides the best quality of video signal compared to AV (Composite) and S-Video connection.

Note: YPbPr is set at default to best perform with HD 720p and 1080i content, set Input to "Interlace DVD" for best performance with regular 480i and 480p content. (Menu - Picture - Mode - Input = "Interlace DVD")

Connecting to an Audio Receiver / Home Theater System

⚠ Disconnect all power sources before making any connections.

1. Using the audio cable, connect the TV's audio OUT jack to the audio receiver's or Home Theater System's audio IN or AUX IN jacks.

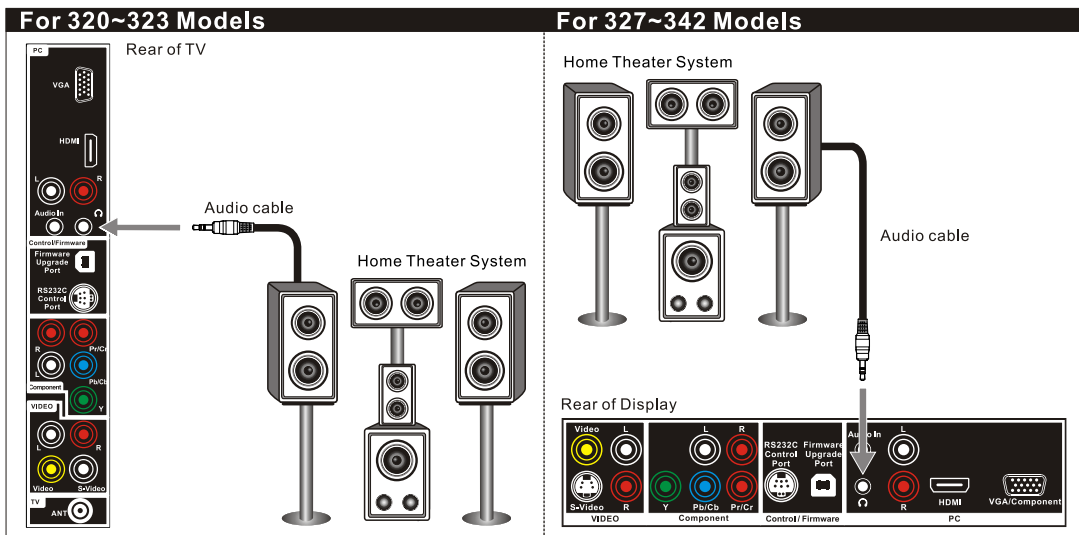
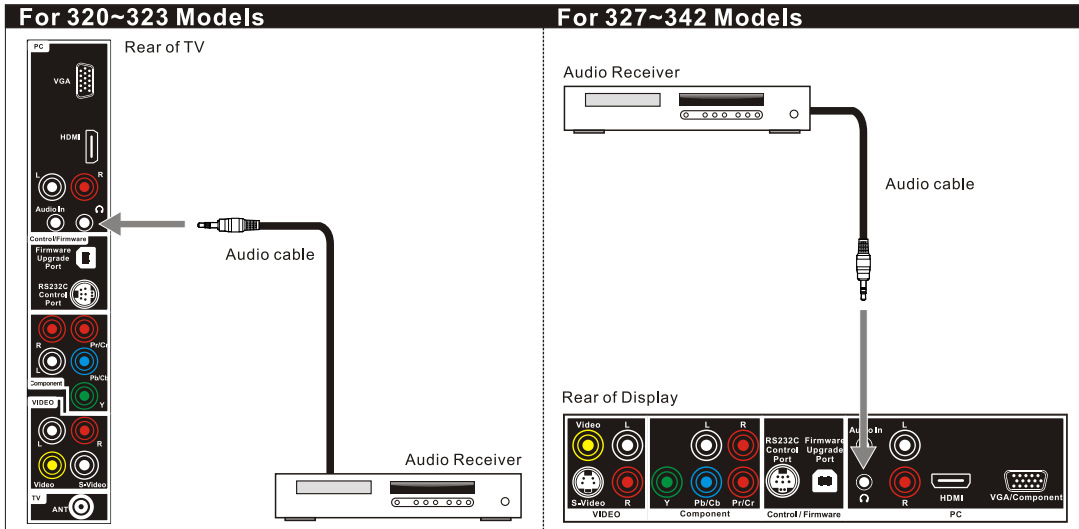

Note: When connecting an Audio output signal, an external Audio amplifier is necessary to amplify the signal for external speakers.

Note: If you connect a Home Theater Sound System, please disable the TV's speakers in the OSD by selecting off in audio section. Volume adjustment must be made on the Home Theater Receiver. By not disabling the TV's speakers it may cause the speakers or the TV itself damage.

Other Audio Connections

⚠ Disconnect all power sources before making any connections.

See setup instructions for: Connecting to an Audio Receiver on page 26.

Note: Speakers must be amplified using an audio receiver such as a Home Theater System to amplify the audio from the TV.

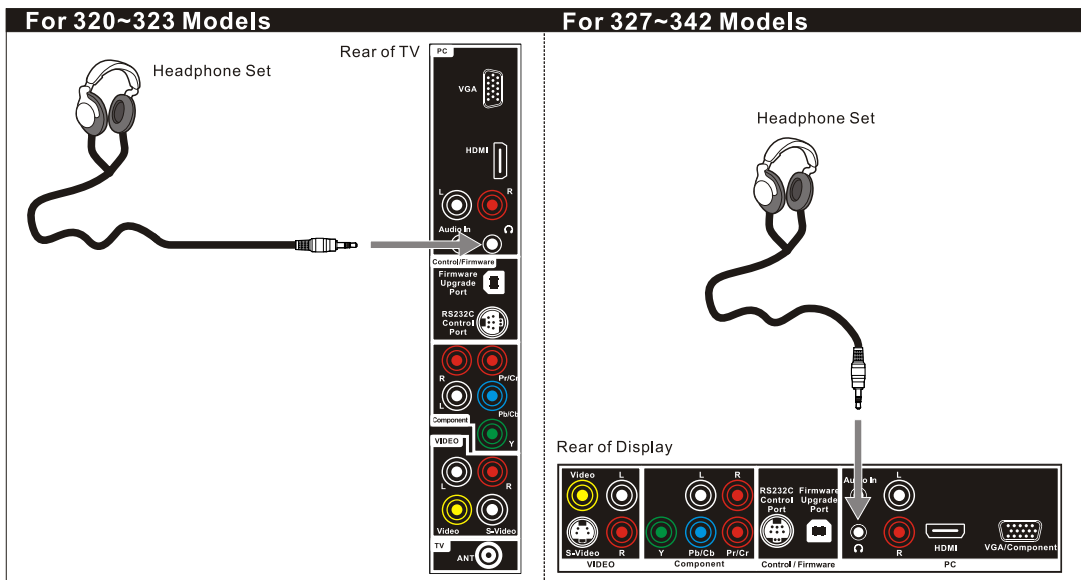
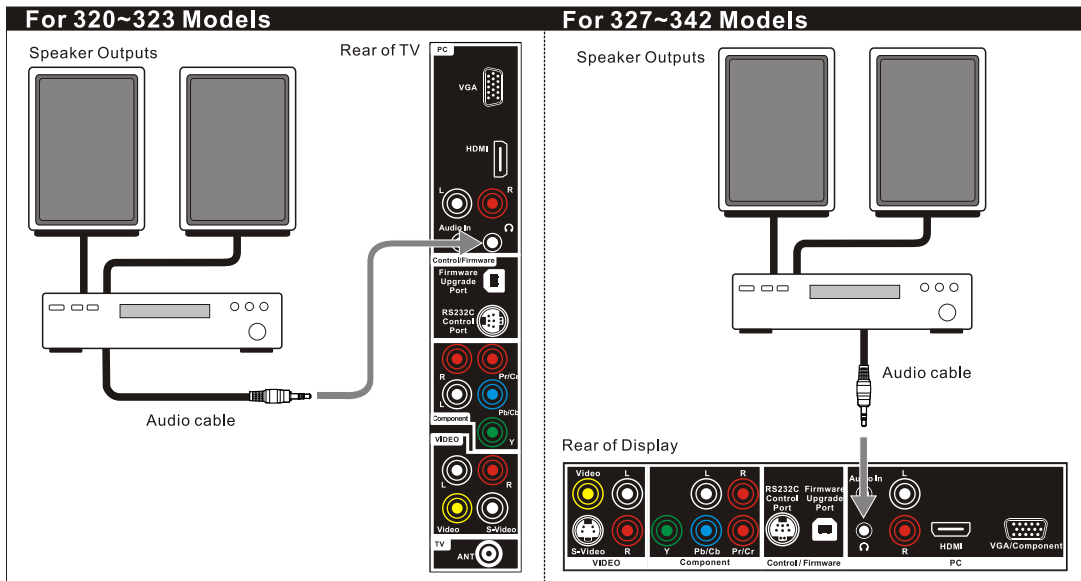
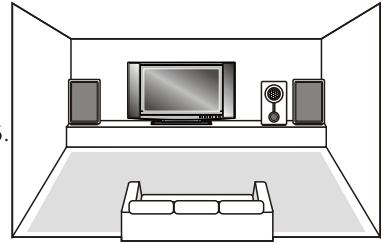

Note: When headphone is plugged in the speaker, it will turn into mute mode.

Instruction for Uploading New Firmware

1. Please visit our website for the detail information.
2. Please register LCD TV on our website.
3. Please log on to the firmware download section by following the instructions.
4. Please review the available downloads, the bugs fixed, and the new features added.
5. Please follow the instructions on the website for their specific model for downloading the new firmware and for loading the firmware into the TV.

Remote Control Guide

Remote Function Keys & Description

Regular Buttons

- 1 POWER** Press to turn display on/off.
- 2 LIGHTING** Press to switch the lighting mode between Dark, Medium, Bright Room.
- 3 ASPECT** Press to switch the aspect ratio between Aspect, Full, Panoramic, Zoom, 1:1 mode.
- 4 FREEZE** Press to freeze the picture. Press again to unfreeze the picture.
- 5 NUMBER BUTTONS** Press to select channels on the display. *(For TV Model Only)*
- 6 RETURN** Press to return the previous-channel. *(For TV Model Only)*
- 7 VOL+ / VOL-** Press to adjust the volume.
- 8 MUTE** Press to mute the sound.
- 9 DIRECTION BUTTONS :**
 - ▲ / ▼ Press to select between four main sections or select the function item.
 - ◀ / ▶ Press to enter to Sub-Menu, select the function item or adjust the value bar.
- 10 SOURCE** Press to switch the source input between Tuner *(For TV Model Only)*, Composite, S-Video, Component, HDMI, VGA, and VGA Component.
- 11 AUDIO** Press to switch the TV Audio System between SAP, Mono or Stereo mode.
- 12 AUTO** Press to adjust screen position automatically when the screen image is not centered under VGA mode.
- 13 C.C.** Press to call up the Closed Caption (CC) and Caption Service (CS) list. *(For TV Model Only)*
- 14 FAVORITE** Press to select favorite channels. Can be preset in OSD Menu. *(For TV Model Only)*
- 15 SLEEP** Press to automatically shut off the TV after a preset period of time has passed.
- 16 CH+ / CH-** Press to adjust channel up and channel down. *(For TV Model Only)*
- 17 TIME** Press to set the display to automatically turn off at the set time.

- 18 MENU** Press to activate or close the On Screen Display menu.
- 19 ENTER** Press to enter to Sub-Menu, or highlight and set up menu.
- 20 DISPLAY** Press to display the information of current channel number and time.

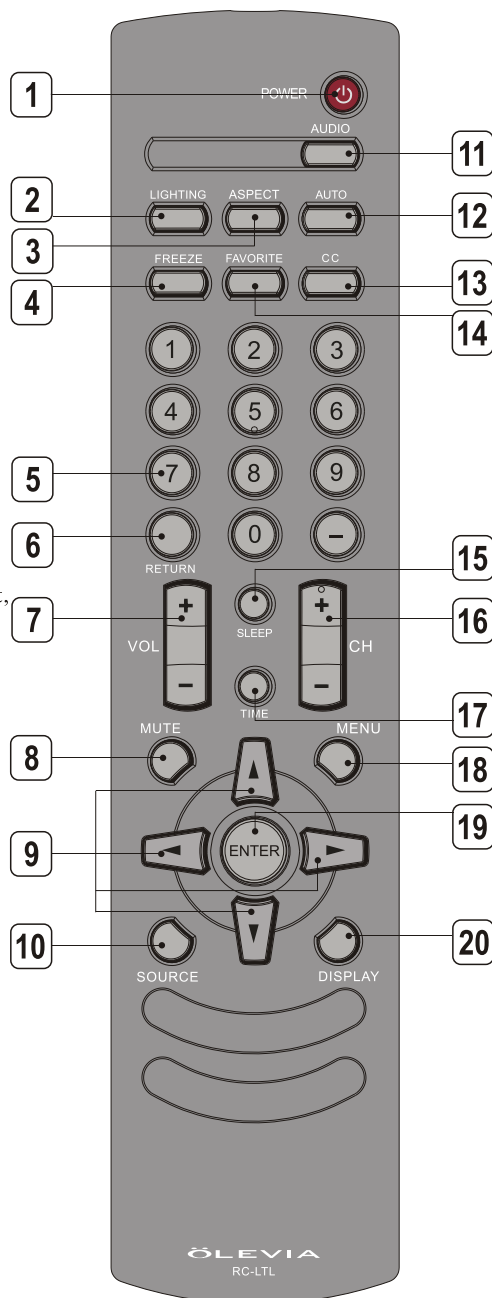

Battery Installation

1. Push the tab and pull it out as illustrated below.
2. Insert two size AAA batteries (supplied) by matching the (+) and (-) on the batteries to the diagram inside the remote control's battery department.
3. Replace the cover back and make sure the cover "snaps" into the remote control.

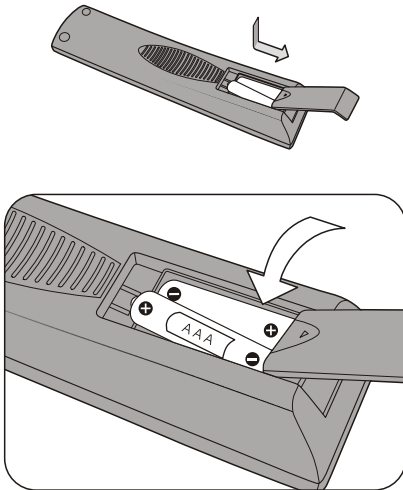

Note:

1. The display unit comes with two new AAA batteries as accessories. However, due to uncontrollable causes, the electricity of the accessorized batteries may be partially or completely drained. We do not warrant the quality of the batteries in any case since many factors are considered. If replacement is needed, please purchase two AAA batteries.
2. Handle remote with care. Avoid dropping it, placing in direct sunlight, near a heater, high areas of humidity or getting it wet. If the remote gets wet, please wipe it dry immediately. In the event of the remote not working properly or is in operational, a replacement of remote control may be required.
3. If you do not use the remote control for a long period of time, please remove the batteries and store in a cool place to preserve battery life.
4. Do not mix new and used or with different types of batteries for operation.

On Screen Displays (OSD)



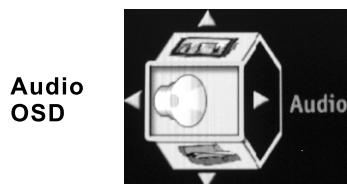
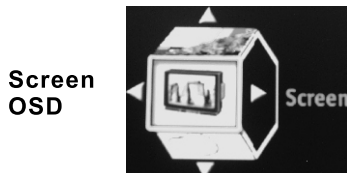

Introduction

After you have finished connecting your TV (Display), you are now ready to choose and personalize your TV (Display) settings in the OSD (On Screen Display) menu.

There are four main sections in the OSD Menu:



Operating in the OSD

1. Press "  " button to enter OSD menu mode.
2. To select between four main sections, press the keys "▲" and "▼".
3. To enter to Sub-Menu, press the keys "◀", "▶" or "  ".
4. To select the function item, press the keys "▲", "▼", "◀", or "▶".
5. To adjust the value bar, press the keys "◀" and "▶".
6. To select and set up, press "  ".
7. To go back to last OSD Menu or exit the OSD menu, press "  " again or without action for 12 seconds of inactivity.

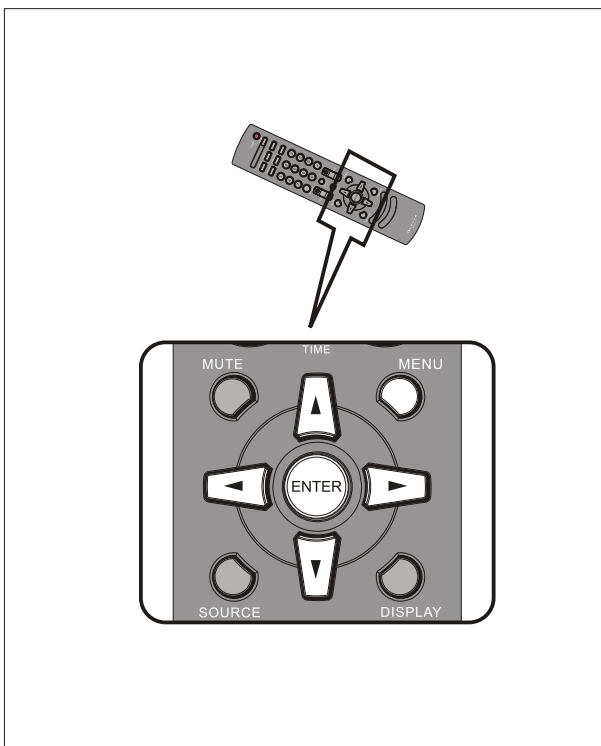

Picture OSD Adjusting Picture Settings

Description of Settings

Item	Adjustment	Function
Brightness		To adjust brightness contrast of the picture
Contrast		To adjust color contrast of the picture
Color temp		To adjust image color intensity
6500		
6500 User	Red Gain / Green Gain Blue Gain / Red Offset Green Offset / Blue Offset	To allow User to adjust RGB value
9300		
9300 User	Red Gain / Green Gain Blue Gain / Red Offset Green Offset / Blue Offset	To allow User to adjust RGB value
Color		To adjust the color intensity
Tint		To decrease or increase red or green tones of the picture
Sharpness		To adjust sharpness or softness of the picture
Mode		
Lighting	Dark / Medium / Bright Room	To adjust darkness or lightness of the screen
Input	VCR / Interlaced DVD / Progressive DVD / Standard Def TV / High Def TV / User	To select the video input source with varied qualities
NR (Noise Reduction)	Low / Medium / High / Off	To reduce high frequency noise dynamically Low/Medium/High -Set "NR" function in low/medium/ high degree. Off - Dynamic Noise Reduction is disabled.

Initial Screen

➤ Power Up

The first time you power on the TV, the options below will appear for your selection.

Show Room :

You may select it when watching in the show room.

Home :

You may select it when watching at home.

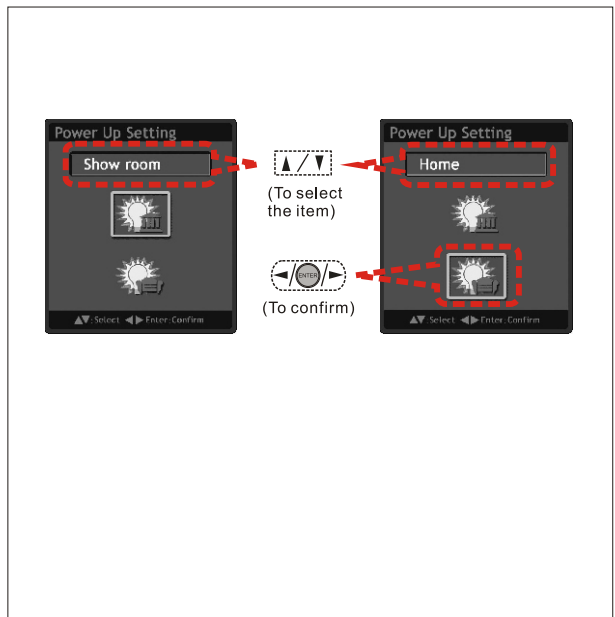

Selecting the Picture Mode

➤ Mode

In this "Mode" Index, you can select one of the picture modes which is suitable for the program you are watching.

Lighting :

To adjust darkness or lightness of the screen

- * **Dark Room** : To darken the screen
- * **Medium Room**
- * **Bright Room** : To brighten the screen

Input :

To select the video input source with varied qualities

- * **VCR**
- * **Interlaced DVD**
- * **Progressive DVD**
- * **Standard Def TV (For TV Model Only)**
- * **High Def TV (For TV Model Only)**
- * **User**

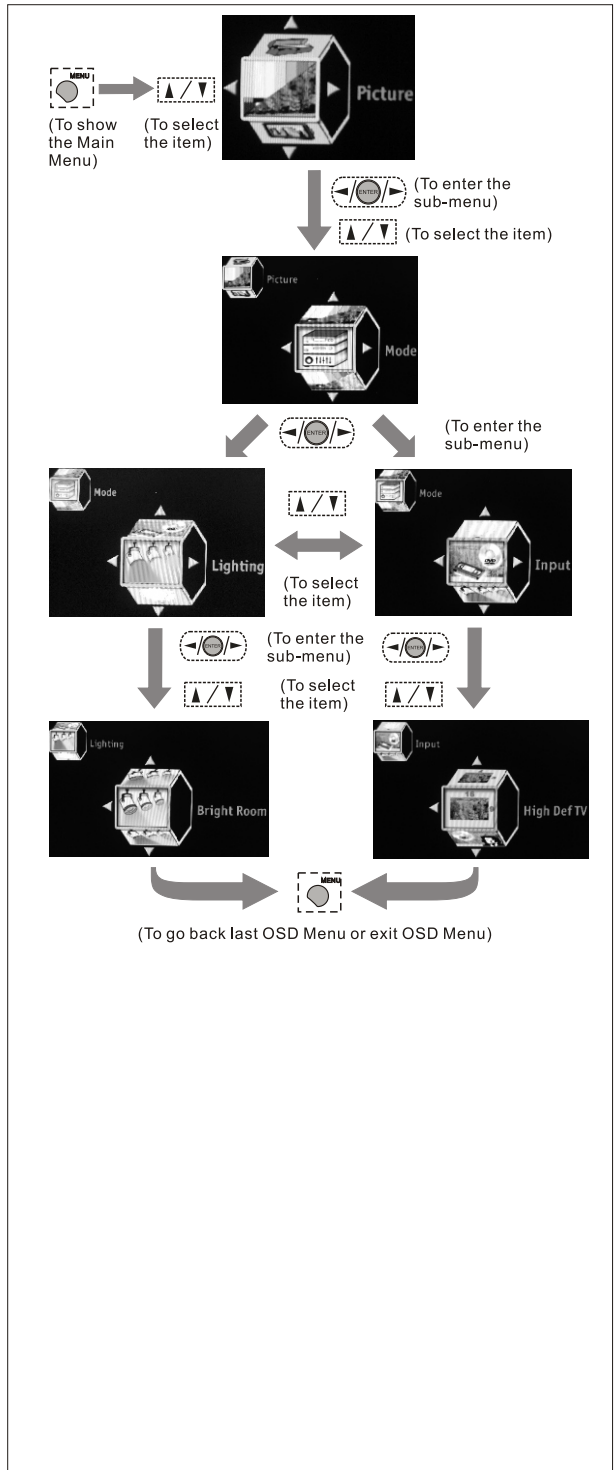

Adjusting the Video or Picture Quality

In this Setup Index, you can adjust the video and picture settings to suit your personal preferences.

- **Brightness**
To darken or brighten the picture
 - **Contrast**
To reduce(soften) or enhance(deepen) color contrast of the picture
 - **Color**
To decrease or increase color intensity of the picture
 - **Tint**
It allows you to decrease or increase red or green tones of the picture.
 - **Sharpness**
To soften or sharpen the picture
 - **Color Temp**
To customize the RGB settings
- 6500**
- 6500 User :**
- * **Red Gain-** To increase red tones of the picture
 - * **Green Gain-** To increase green tones of the picture
 - * **Blue Gain-** To increase blue tones of the picture
 - * **Red Offset-** To decrease red tones of the picture
 - * **Green Offset-** To decrease green tones of the picture
 - * **Blue Offset-** To decrease blue tones of the picture

9300

9300 User :

The settings are as the same as the "6500 User" option.

Native :

To select the nature color tones of the picture

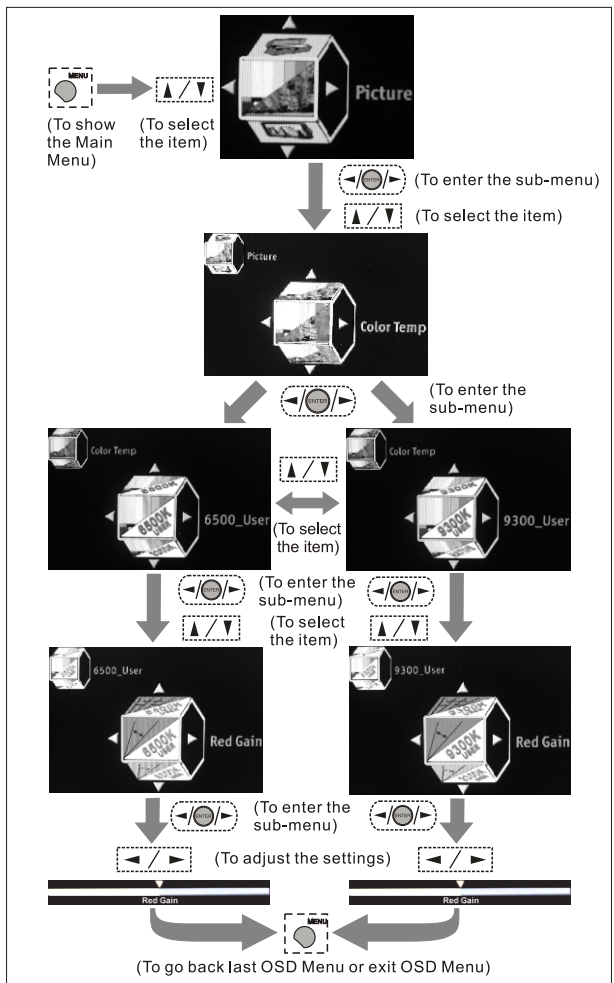
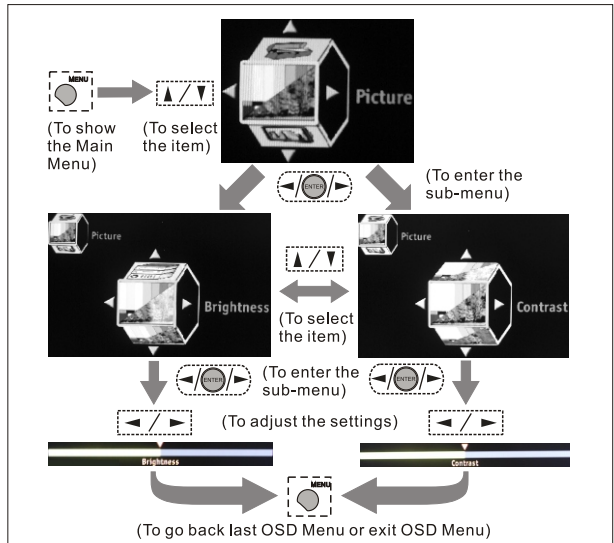

➤ **NR (Noise Reduction)**

Select Low/Medium/High to reduce noise.

Low : To reduce parts of noise

Medium : To reduce half of noise

High : To reduce most of noise

Off : Dynamic Noise Reduction is disable.

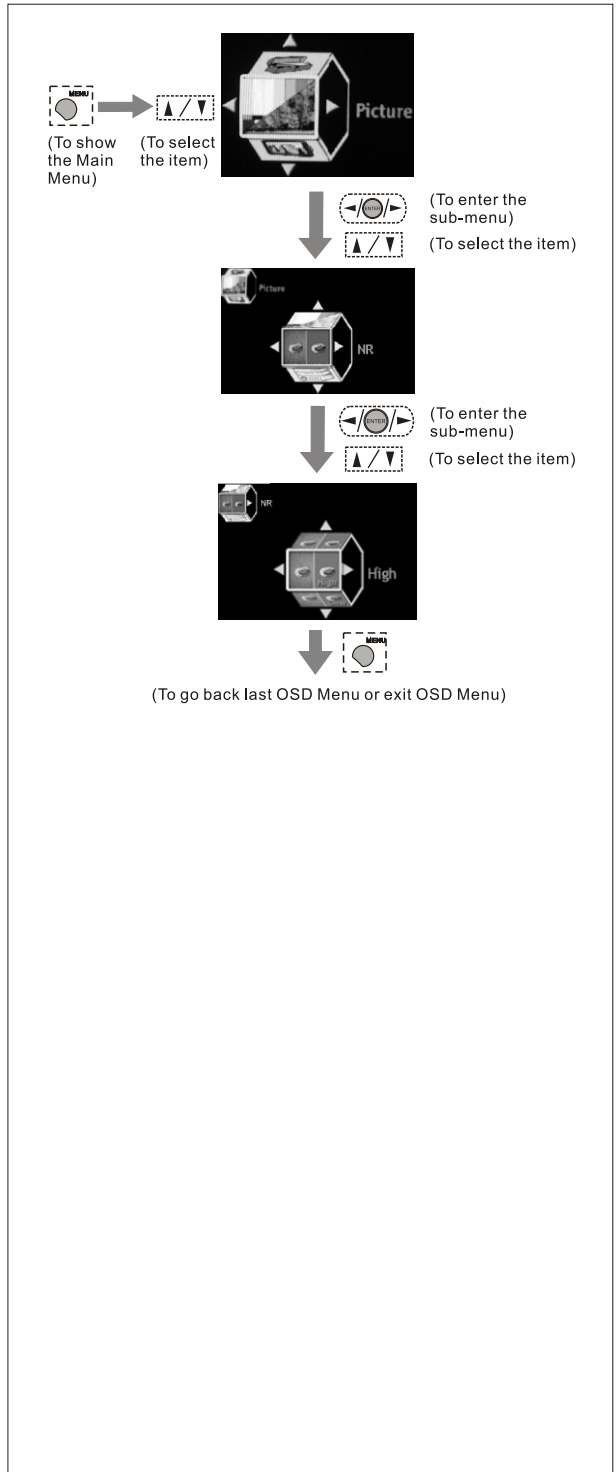

Audio OSD Adjusting Sound Quality

Description of Settings

Item	Adjustment	Function
Treble		It allows to adjust higher pitched sounds.
Bass		It allows to adjust lower pitched sounds.
Balance		It allows to adjust volume balance of the R/L speakers for the best stereo reproduction.
MTS (Multi-channel Television Sound)	Mono, SAP, Stereo	It allows to select the sound reception of stereo, bilingual and mono programs between the TV Audio System.
Mute	On, Off	It allows to mute the sound.
Speaker	On, Off	It allows to turn On/Off the speakers of the TV when using a Receiver or Home Theater System.

Adjusting the Audio Settings

In this Setup Index, you can adjust the audio settings to suit your personal preferences.

- **Treble**
Decreases/Increases high pitch sounds.
- **Bass**
Decreases/Increases low pitch sounds.
- **Balance**
Adjusts volume to R/L speakers for the best stereo reproduction.
- **Mute**
Mutes sounds.
- **Speaker**
Turns TV speakers On/Off when using Home Theater System.

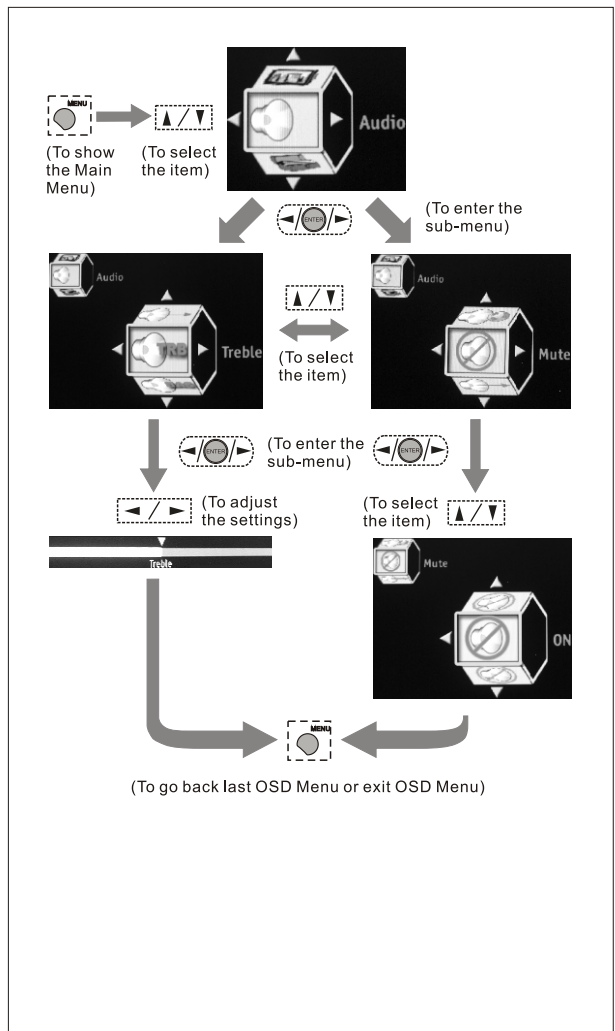

MTS System for Stereo TV

In this Setup Index, you can adjust the audio settings to suit your personal preferences.

➤ MTS

Toggles audio through Stereo, SAP and Mono.

Mono :

Selects Mono reception. (Uses to reduce noise during weak stereo broadcasts)

SAP :

Selects audio to Secondary Analog Program. (If no SAP signal is present, the TV remains in Stereo Mode)

Stereo :

Selects Stereo reception when viewing a program.

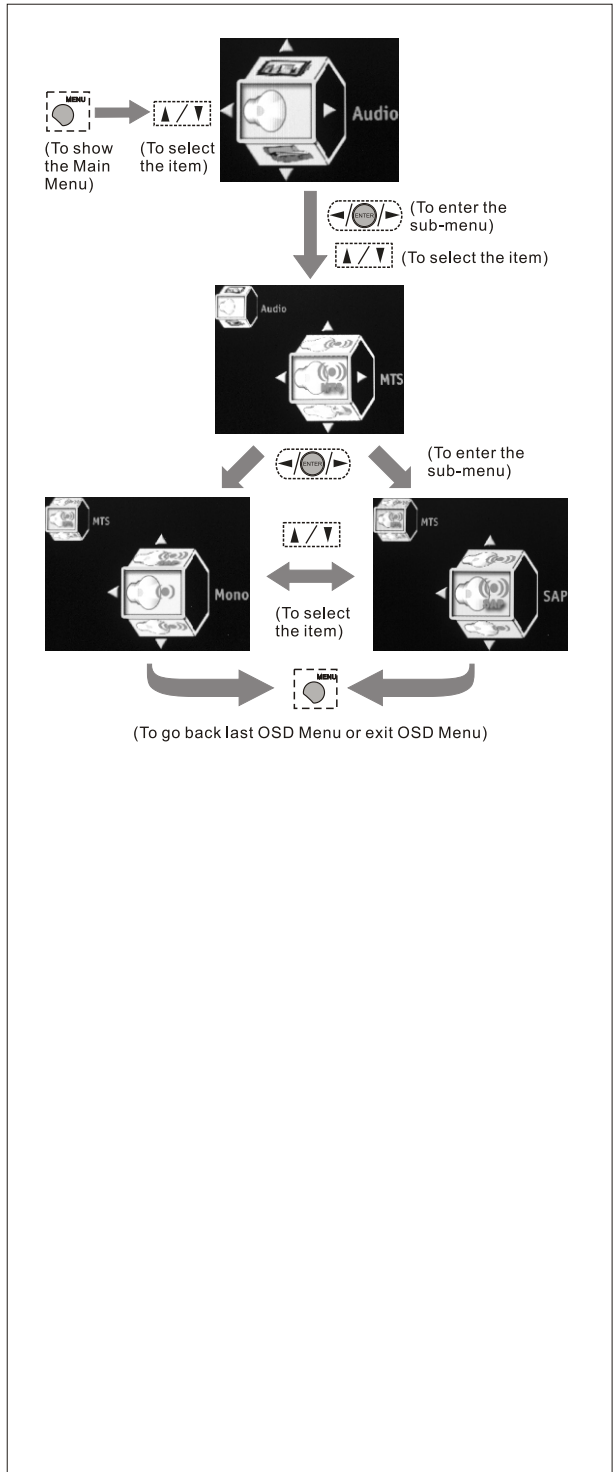

Screen OSD Adjusting Screen Modes

Description of Settings

Item	Adjustment	Function
Adjustment		
H.Position		It allows you to adjust the picture position horizontally.
V.Position		It allows you to adjust the picture position vertically.
Fine Tune		
Aspect Ratio	Aspect, Full Screen, Panoramic, Zoom 1, Zoom 2, 1:1 Mode	It allows you to select the aspect ratio of the picture you are watching.
Cropping	On, Off	Once activating this function, the picture you are watching will be enlarged. Then its edges will be cropped automatically.
Source	Tuner, Composite, S-Video, Component, HDMI, VGA, VGA-Component	It allows you to select one of the picture or video sources you want to view.

Changing the Screen Mode

In this Setup Index, you can adjust the screen settings to suit your personal preferences.

➤ Adjustment (Analog Source Only)

Adjusts the picture position and its quality.

H.Position :

Moves the picture left and right in the "Full Screen, Panoramic, and Zoom" modes.

V.Position :

Moves the picture up and down in the "Full Screen, Panoramic, and Zoom" modes.

Fine Tune :

Enhances picture quality by reducing horizontal flickering.

Auto Sync :

Adjusts the image to its best position and automatically displays on the screen.

➤ Aspect Ratio

It allows you to select the aspect ratio of the picture you are watching.

Aspect :

Toggles picture between 16:9 / 4:3 aspect ratio.

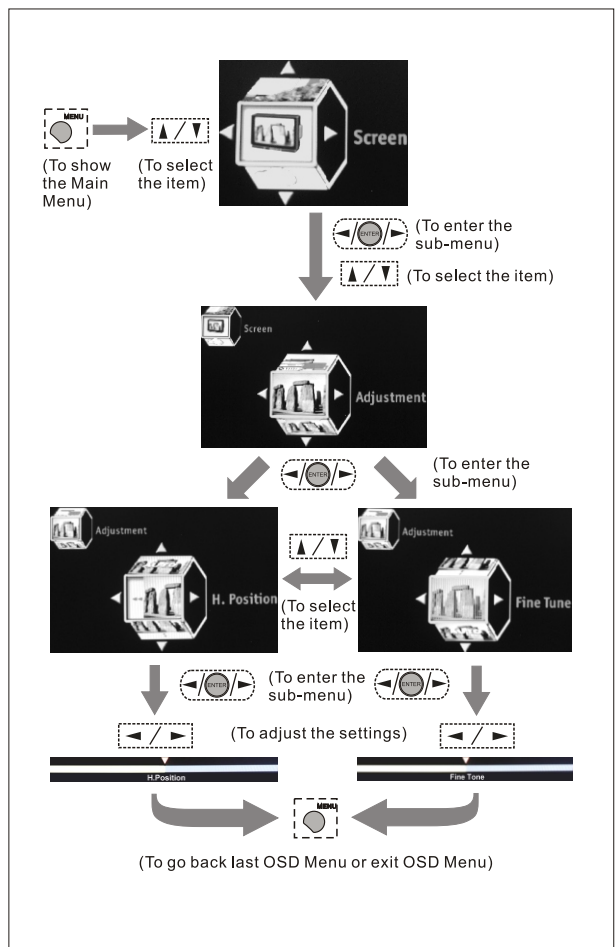

Full Screen :

Enlarges a 4:3 picture to fill the 16:9 screen.

Panoramic :

Enlarges a picture from 4:3 to 16:9 by stretching it horizontally.

Zoom 1 :

Stretches the image both horizontally and vertically, which will lose part of the image on both ends.

Zoom 2 :

Stretches the image both horizontally and vertically, which will lose part of the image on both ends.

1:1 Mode :

Returns the image to its original mode.

➤ **Cropping**

Crops image and then enlarges it to fill the screen.

(Note: This feature helps remove any noise visible under both vertical and horizontal edges of the image)

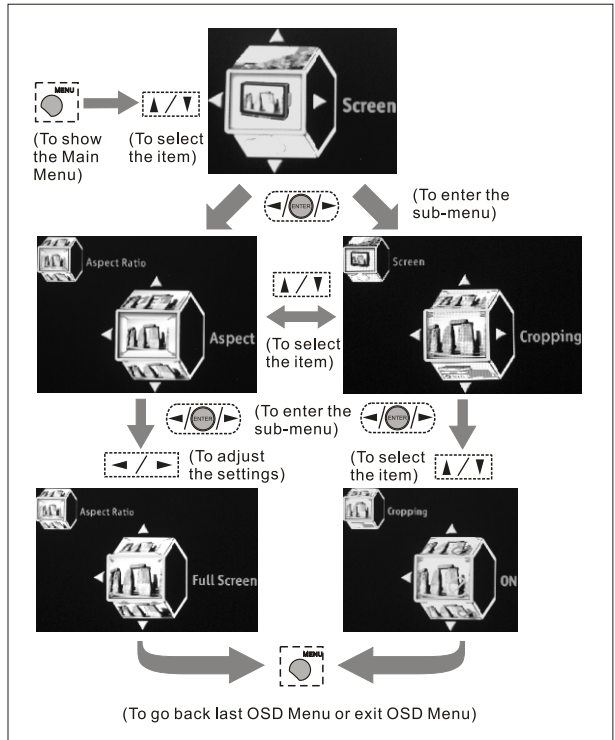

Selecting the Picture or Video Source

In this Setup Index, you can select the input source of the picture or video you want to view.

➤ **Source**

It allows you to view images from optional video equipment connected to this unit by selecting the appropriate input source.

Tuner : (For TV Model Only)

Composite :

S-Video :

Component :

HDMI :

VGA :

VGA Component :

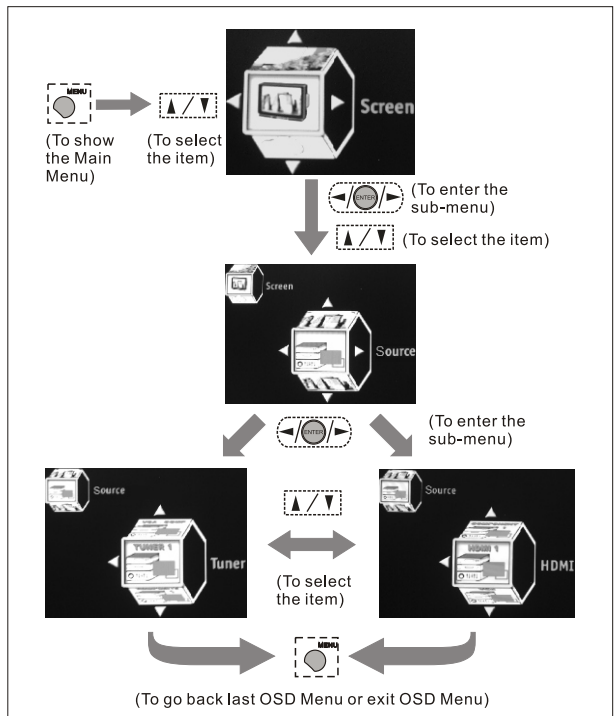

Setup OSD Adjusting Personal TV Settings

Description of Settings

Item	Adjustment	Function
TV (For TV Model Only)		
Channel Setup	Favorite, Skip	It allows you to set up Channel functions.
Auto Channel Search	Cable Standard, Air	It can auto scan the available channels of the TV or CATV.
Channel Add		It allows you to add channels to your favorite channel list.
Closed Caption (For TV Model Only)		It allows you to select the Closed Caption type shown on the TV program.
Analog Type	Off, CC1~4, T1~4	
Parental Control		
Enter Password		
Rating	On, Off	
MPAA Rating	G/PG/PG-13/R/NC-17/X	
Block Unrating	On, Off	
TV Rating	TV-Y/ TV-Y7/ TV-Y7-FV TV-G/ TV-PG(V,S,L,D)/ TV-14(V,S,L,D) / TV-MA (V,S,L)	
Canada English Rating		
Canada French Rating		
Channel Block		
Change Password		
Timers	Sleep, Timer # 1, Timer # 2	It can be set to turn on / off the TV automatically at the set time.
Date and Time		It allows you to set the information of "Date and Time".
Menu Timeout	10, 20, 30	It can be set to shut off the TV automatically after a preset period of time has passed.
Language	English, Français, Español	It allows you to set the OSD Menu language.
DPMS	On, Off	TV and Backlight will shut off automatically when no video source is detected when DPMS is active.
Factory Settings		It can reset all parameters in OSD Menu Mode for all input sources.
Factory Settings by Input		It can reset all parameters in OSD Menu Mode for the source you select currently.
Firmware Version		You can see the firmware version here that installed in the HDTV unit.

Searching the TV Channels

In this Setup Index, you can pre-search all channels before watching the programs.
(For TV Model Only)

➤ Auto Channel Search

Will scan and preset all receivable channels automatically.
(For TV Model Only)

Cable :

Selects cable if using tuner as the input.
(For TV Model Only)

- * Auto
- * Standard

Air :

Selects air if using antenna.
(For TV Model Only)

(NOTE: The Auto Scan is set to scan cable TV channels by default. You cannot receive and set the cable TV channels and VHF/ UHF channels at the same time.)

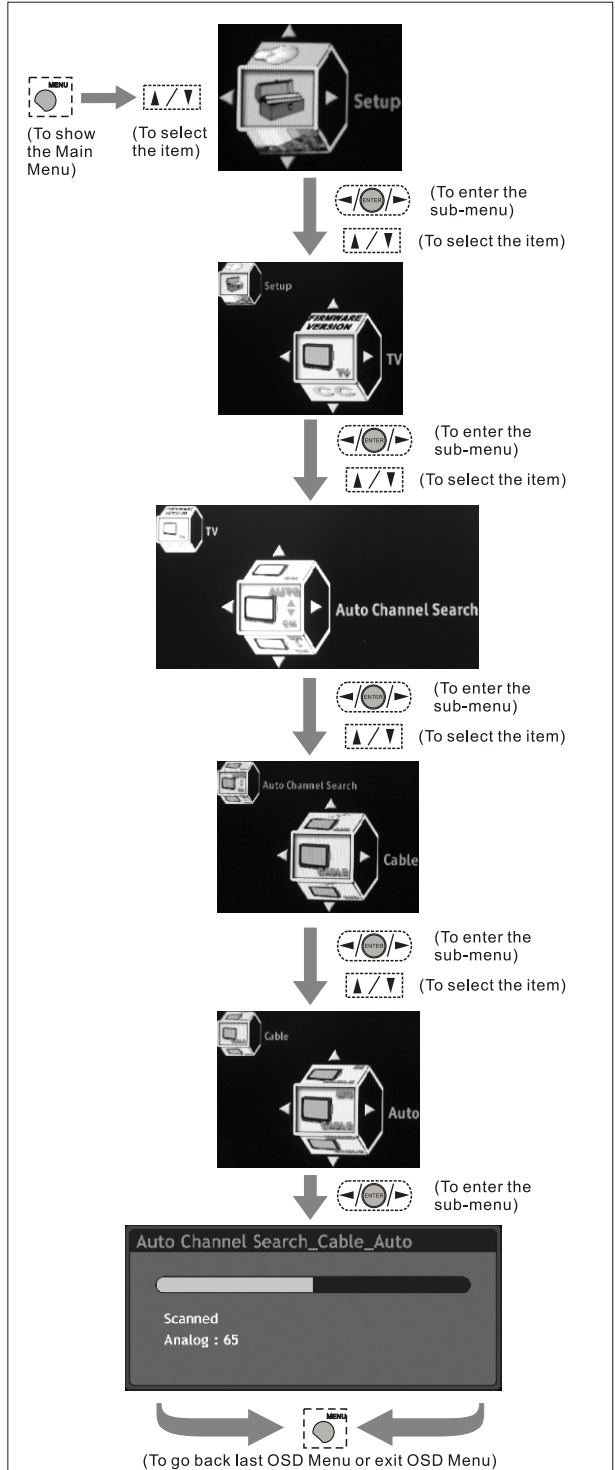

Editing Channels

In this Setup Index, you can edit channels to suit your personal preferences.
(For TV Model Only)

➤ Channel Setup

Will scan and preset all receivable channels automatically.
(For TV Model Only)

Favorite :

Selects and stores a list of favorite channels.
(For TV Model Only)

Browses through favorite channels by pressing Hotkey "FAVORITE".

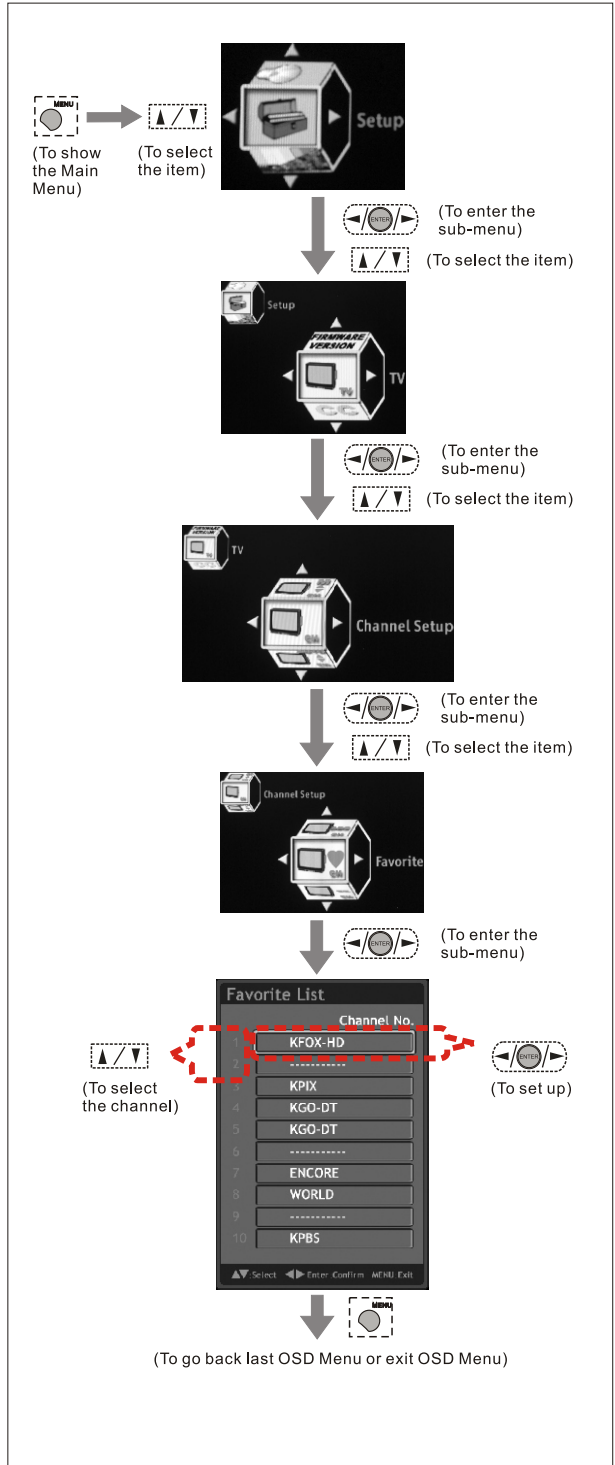

Skip :

Skips channels from viewing.
(For TV Model Only)

(NOTE: Once this function is set, the skipped channels will not be displayed after searching. If you wish to view later, enter the channel number by pressing the numeric keys on the remote control.)

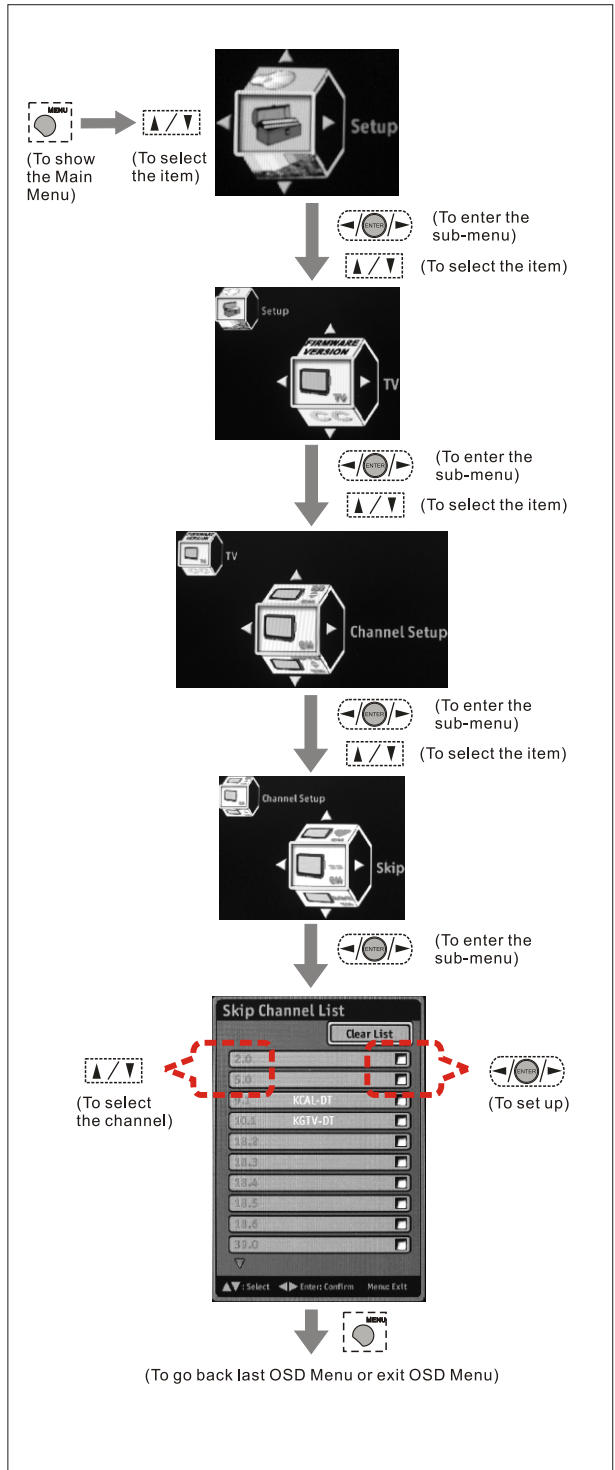

➤ **Channel Add :**

Adds channel currently on display to the FAVORITE channel list.
(For TV Model Only)

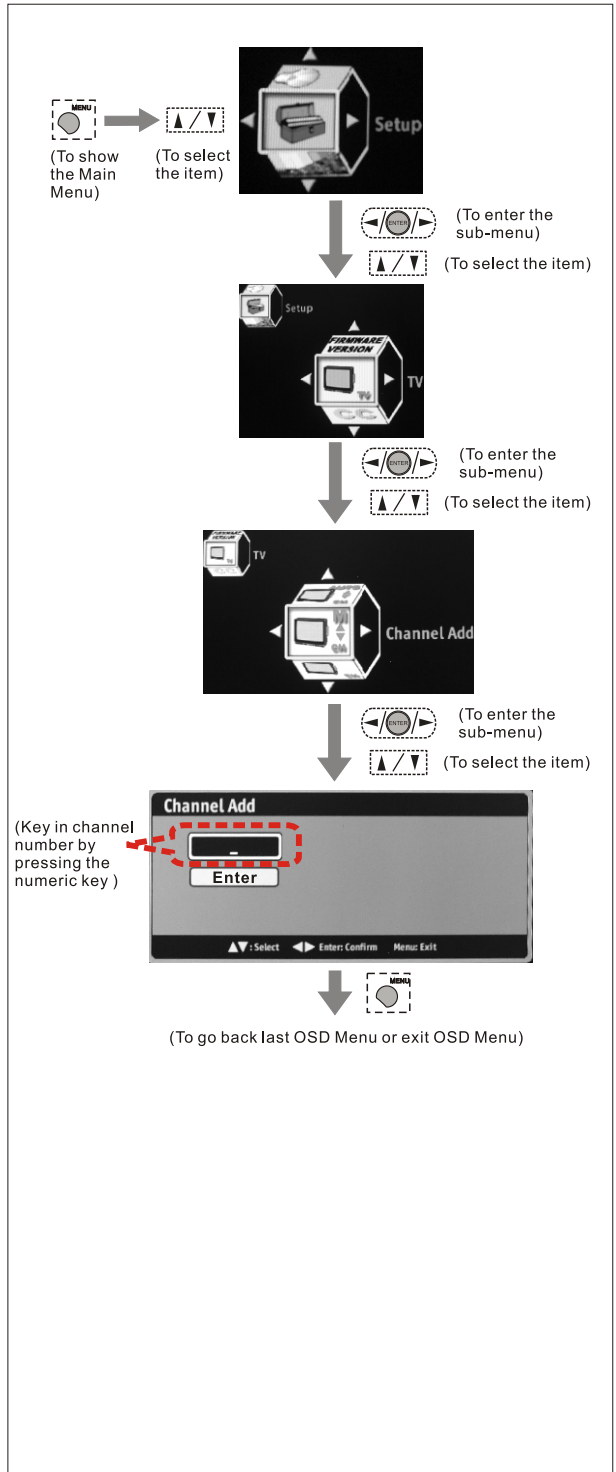

Closed Caption Options

Displays the audio portion of a television signal as text on the television screen.

(For TV Model Only)

➤ Analog Type

If there is Closed Caption data shown on the analog TV channel, you can select your preferred Closed Caption type by scrolling through CC1~4, T1~4.

(For TV Model Only)

CC1 : is used for most programs

CC2 : may be used for alternate languages

Text : is used for network and station information, such as channel guides, schedules, or bulletin board, for Closed Caption programs.

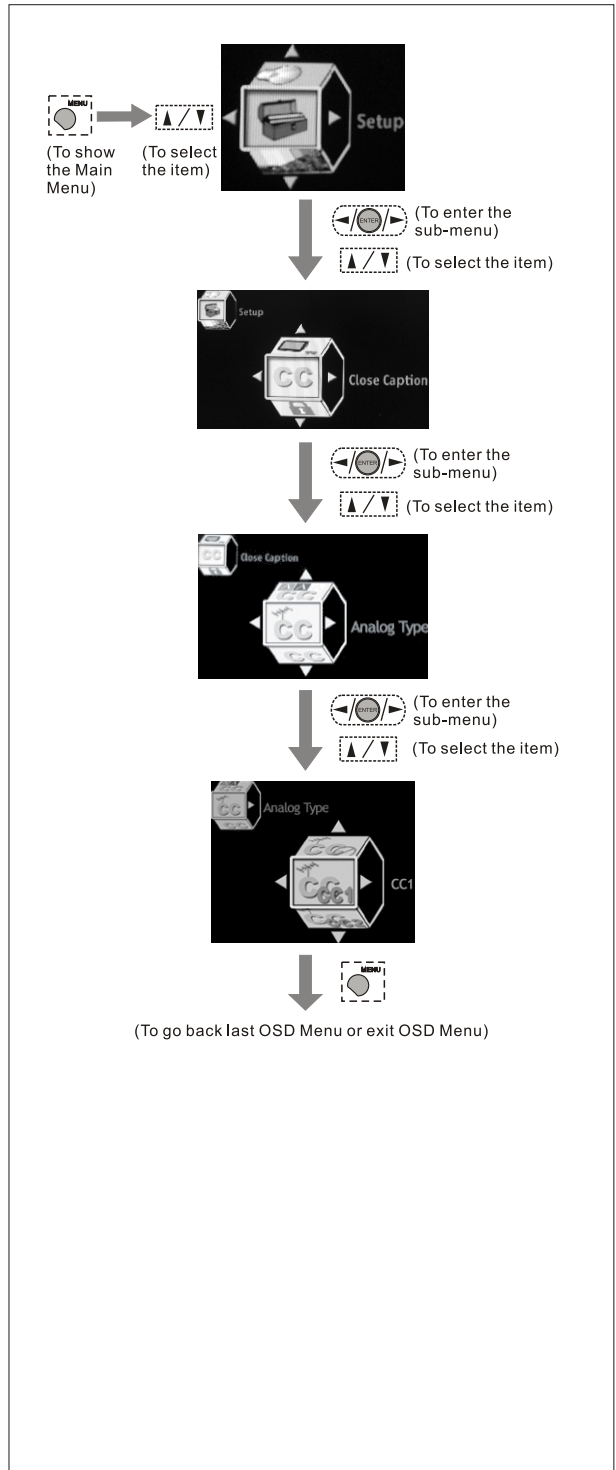

Setting up Parental Control Password

This function allows programs to be restricted and controlled by parents.

➤ Enter Password

Password is necessary to enter and re-enter the Parental Control Menu screen.

(NOTE: The Factory Default password is "999999".)

(NOTE: please contact with the serviceman if you forget the password you set.)

Activating the Parental Control Feature

Blocks programs based on programming rating system.

The TV Parental Control features by receiving the rating signal from your local broadcasting station or cable service provider.

➤ Rating

- * **On**- To activate rating function
- * **Off**- To disable all of rating functions

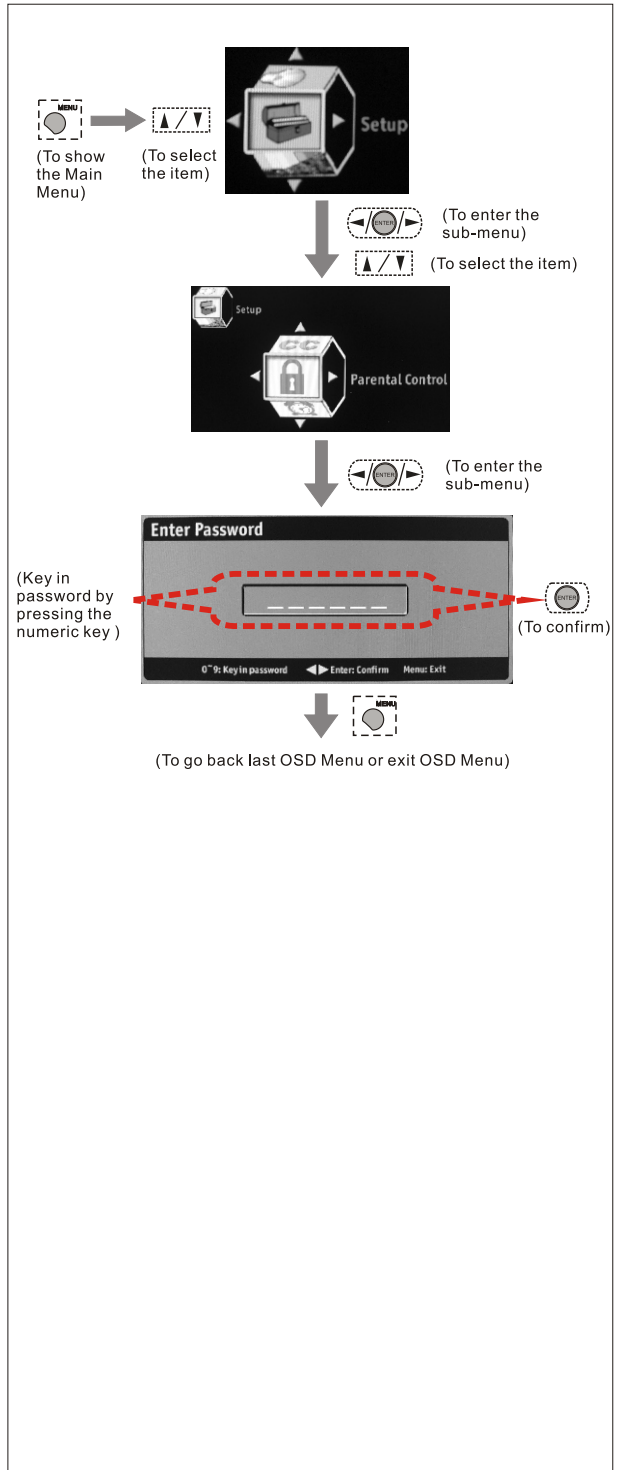

➤ **MPAA Rating**

Motion Picture Association of America provide movie ratings, including those shown on TV.

G : (General Audience) No restriction.

PG : (Parental guidance suggestion)
Children under 13 should be accompanied by an adult.

PG-13 : (Parents strongly cautioned)
Children under 13 should be accompanied by an adult.

R : (Restricted) Viewers should be 17 or older.

NC-17 : (Not classified) Viewers should be 17 or older.

X : (Adults only)

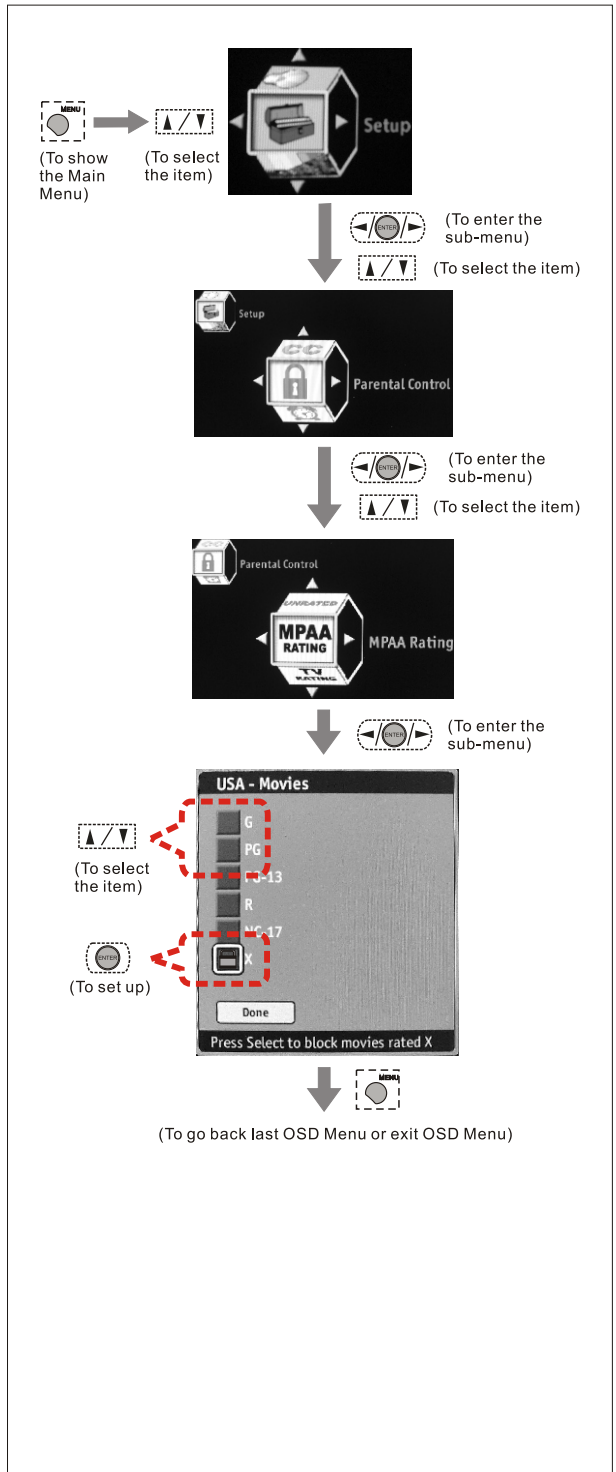

➤ **TV Rating**

U.S. TV ratings are for TV programs rated according to the U.S. Television Parental Guidelines.

TV-MA/V/S/L : (Mature audiences only)

TV-14/V/S/L/D : (Parents strongly cautioned)

TV-PG/V/S/L/D : (Parental guidance suggested)

TV-G : (General audience)

TV-Y7/FV : (Directed to children under 7 or older)

TV-Y : (All children)

(NOTE: When you block the lower rating, the higher age-based ratings are blocked automatically.)

➤ **Block Unrating**

You may select "On" for MPAA Unrated and TV Unrating. This allows you to block programs or movies that are broadcast without a rating.

To watch unrated channels, re-activate MPAA Unrated and TV Unrating to "Off".

(NOTE: The unrated option is available only when you have selected U.S.A. as your country/region.)

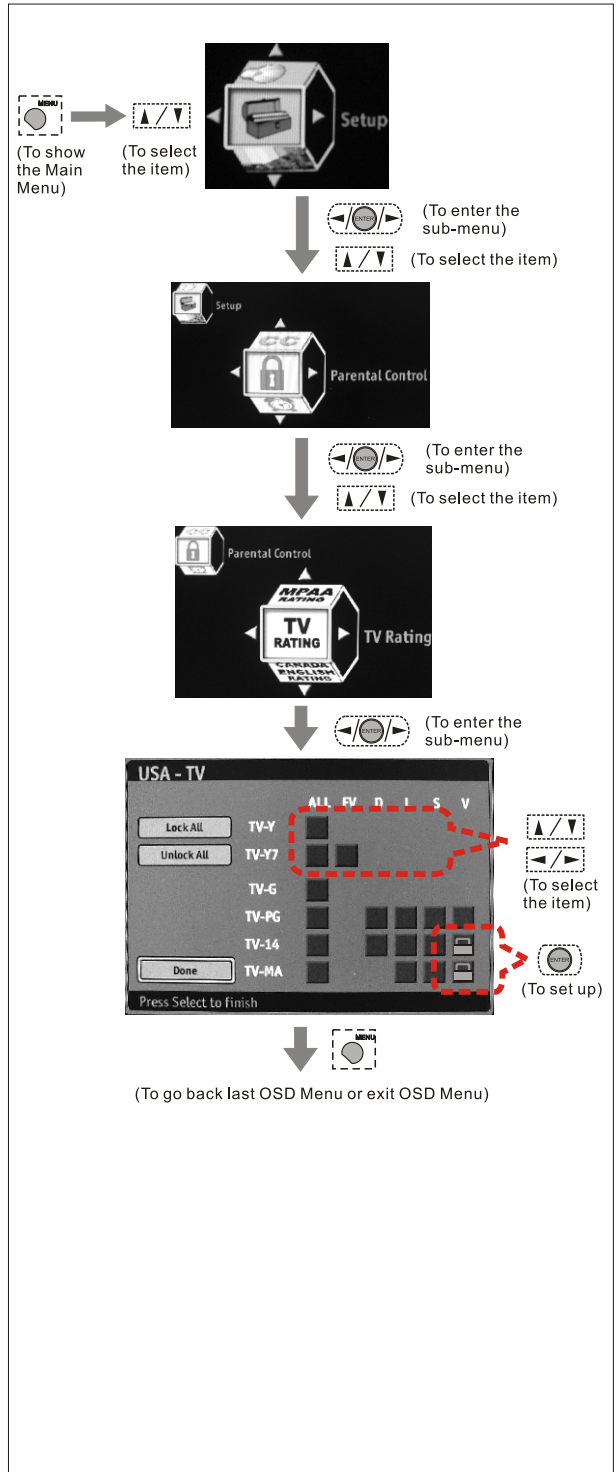

➤ Canada English Rating

It is available for TV programs in English broadcast in Canada.

C : (Intended for children under 8)

CB+ : (Generally considered acceptable for children aged 8 and older to watch on their own)

G : (General Audience)

PG : (Parental Guidance) Parents may consider some content inappropriate for unsupervised viewing by children aged 8-13.

14+ : (Not suitable for viewers under the age of 14)

18+ : (Adult)

NOTE: When you block the lower rating, the higher age-based ratings are blocked automatically.

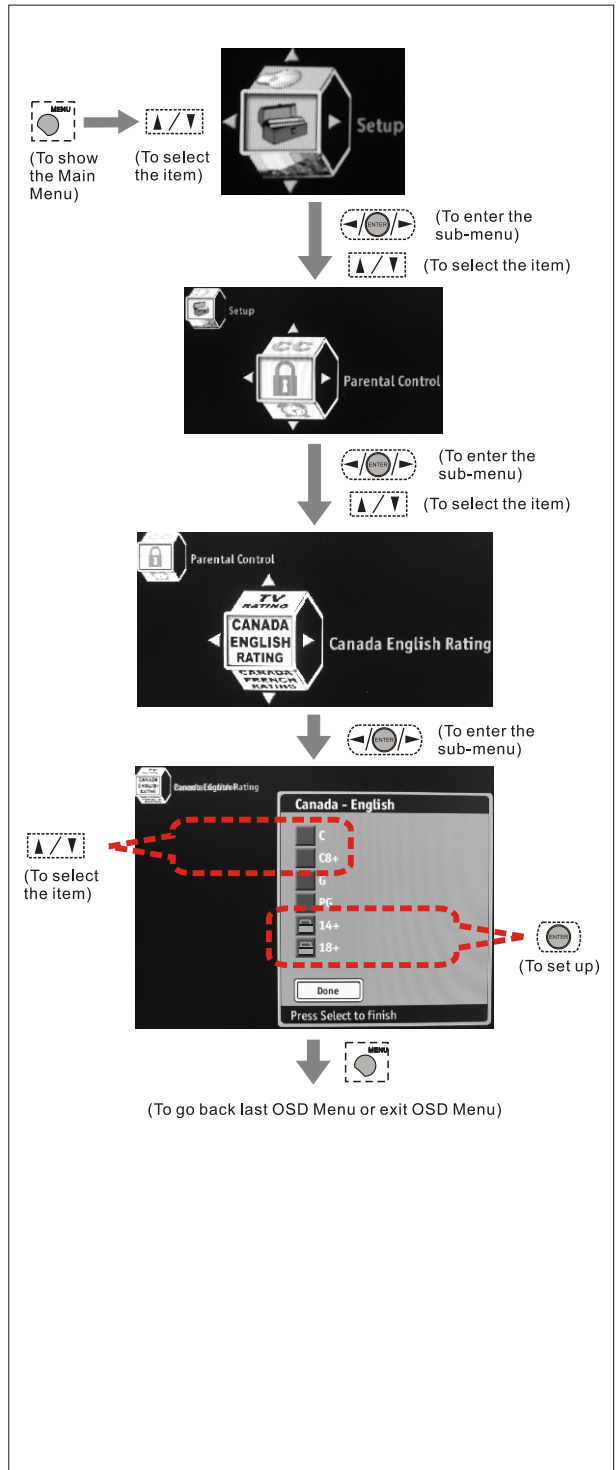

➤ **Canada French Rating**

It is available for TV programs in French broadcast in Canada.

G : (General Audience)

8 ans+: (8+ General--Not recommended for young children under the age of 8)

13 ans+ : (Not suitable for children under the age of 13)

16 ans+ : (Not suitable for children under the age of 16)

18 ans+ : (Restricted to adults)

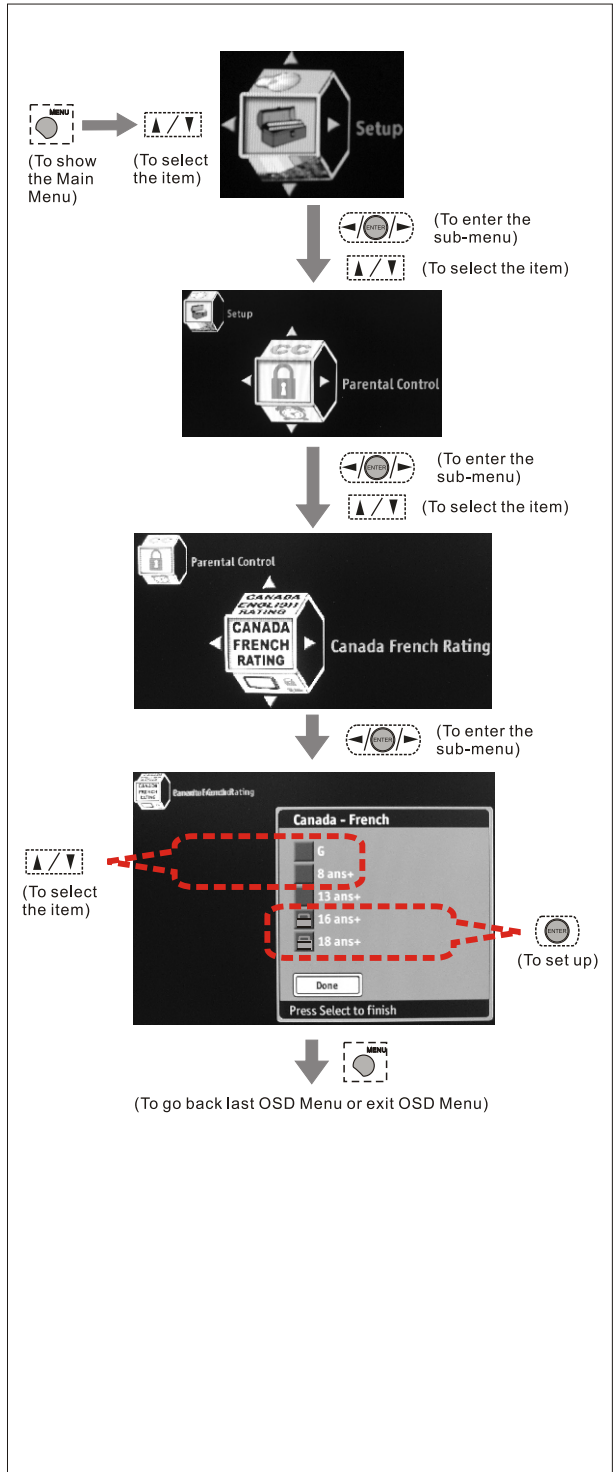

➤ Channel Block

In this Setup Index, you may select the blocked ratings to suit your personal preferences.

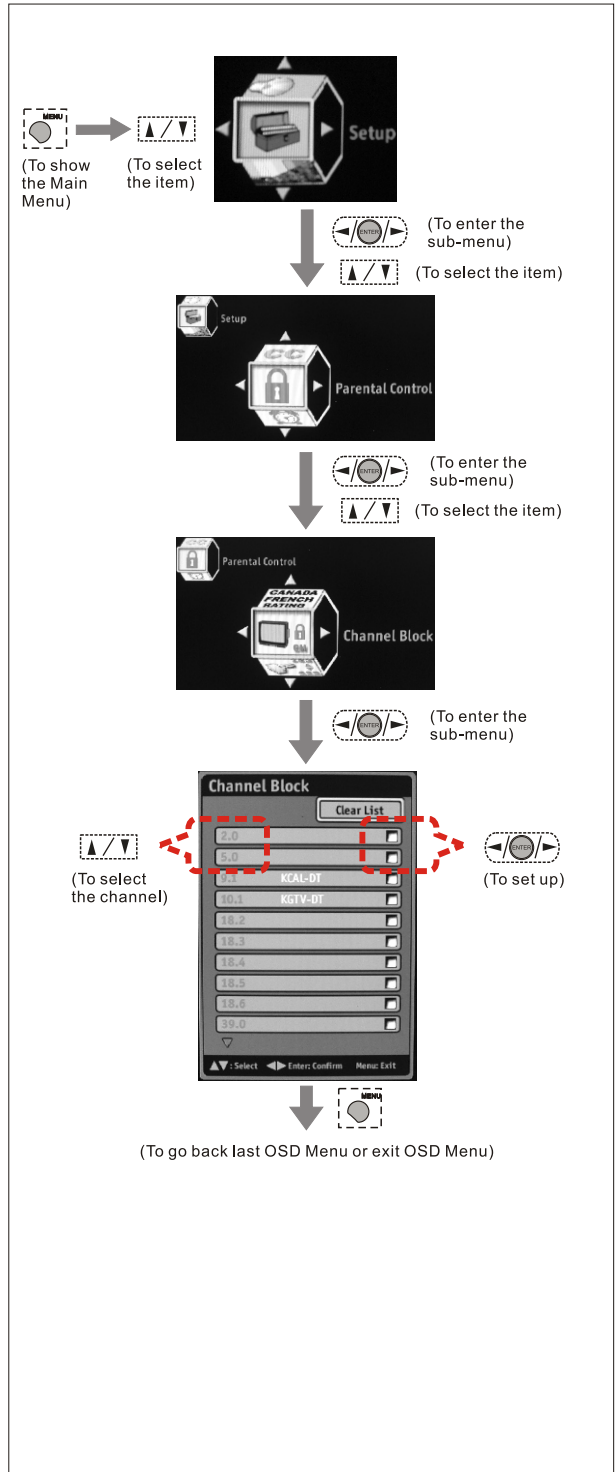

Resetting the Password

➤ Change Password

You may change to a new preferred password by pressing the numeric key within 6 numbers.

(NOTE: The Factory Default password is "999999".)

(NOTE: please contact with the serviceman if you forget the password you set.)

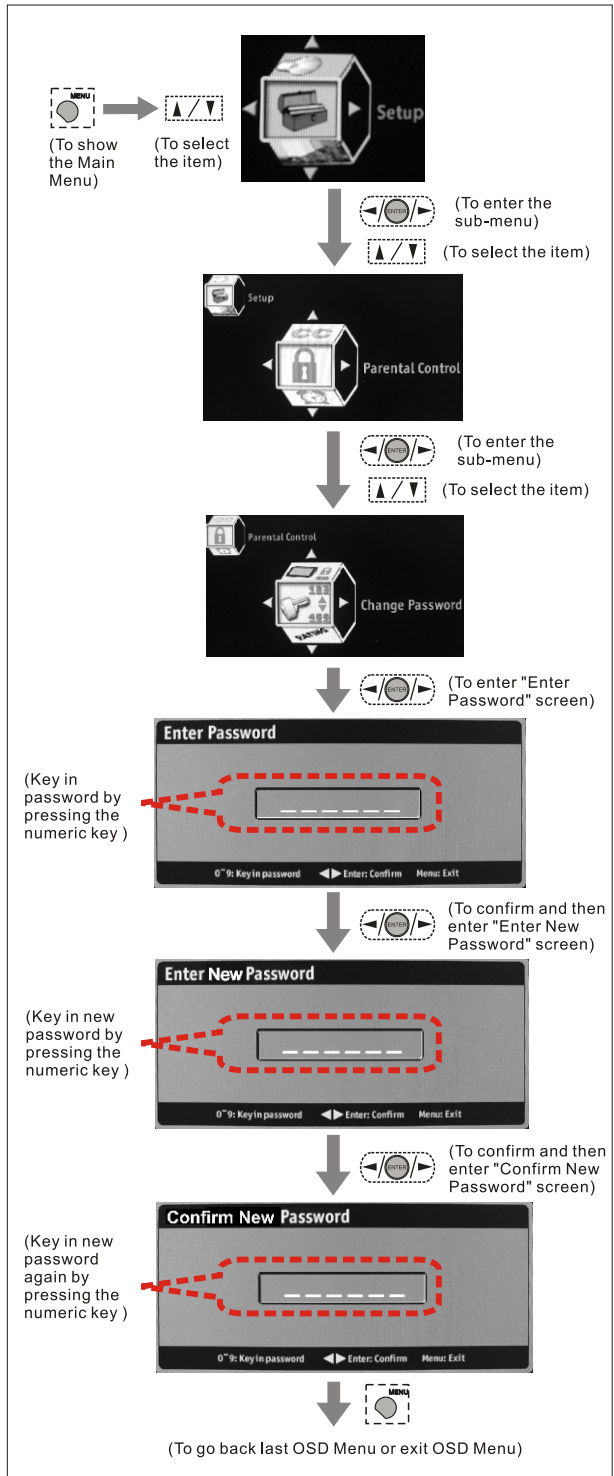

Setting the Date and Time

➤ Date and Time

In this Setup Index, you can setup the Date, Week, Time Zone, and Current Time on the TV.

Date :

Date is set automatically when NTSC source is used. (Manual adjustment is necessary however, if not used)

Week :

It will be automatically displayed according to the Date setting.

Time Zone :

You can select available time zone where you live.

Current Time :

Time is set automatically when NTSC source is used. (Manual adjustment is necessary however, if not used)

Daylight Savings :

Option will be selected automatically based on settings above.

Auto Calibration :

Once activating this function, the information of "Date and Time" will be corrected automatically based on accurate time.

NOTE: Once marking the "Auto Calibration" setting, all settings shown on the "Date and Time" screen will be invalid.

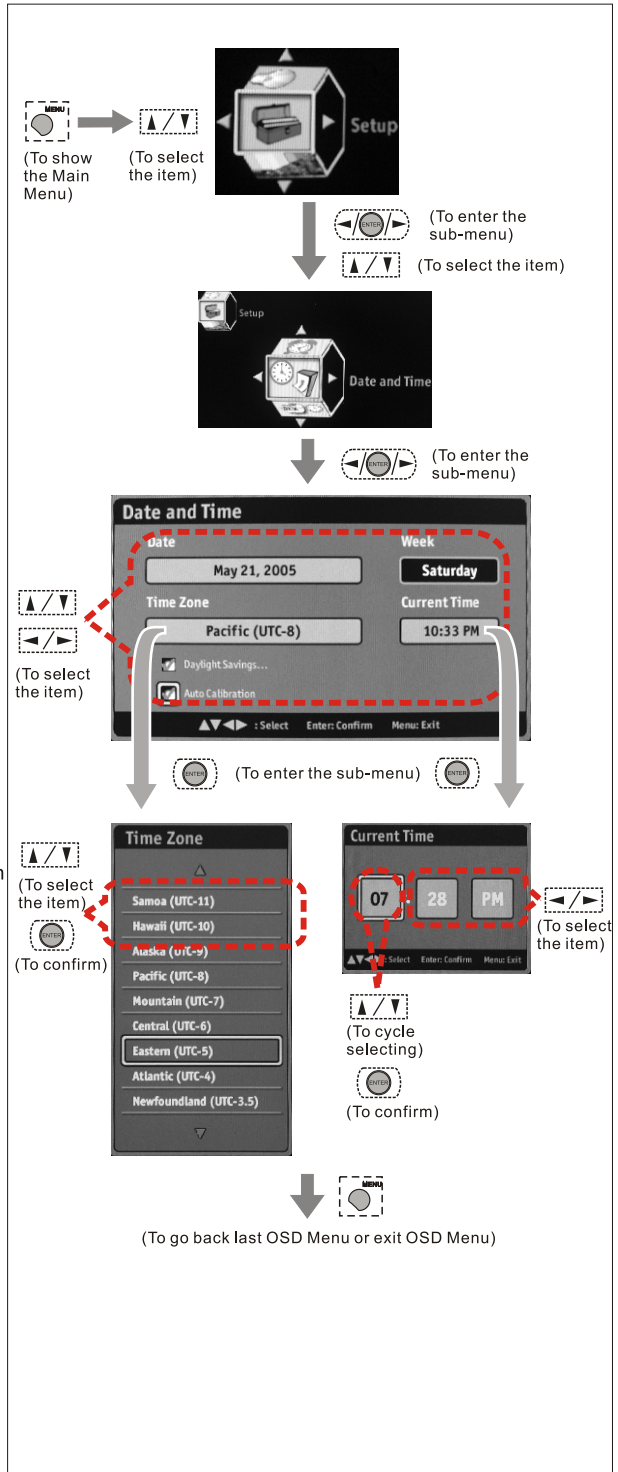

Setting the TV Timer

Timers

In this Setup Index, you can setup the Sleep Time, Start Time, and Stop Time on the TV.

Sleep :

Shuts off TV after a preset period of time has passed by scrolling through 30, 60, 90, 120 minutes.

Timer # 1 :

Turns display on/off at a set time by entering Week, Start time and Stop time.

Timer # 2 :

You can set another unit of timer.

(NOTE: Please preset the "Date and Time" before setting the "Timer # 1 and 2" functions.)

(NOTE: If the "Timer # 1" and "Timer # 2" settings are overlap, they will be combined to be one.)

(NOTE: If the "Stop Time" is less than the "Start Time", the setting will be carried over to the next day.)

Timeout Settings for OSD Menu

Menu Timeout

In this Setup Index, you can setup the OSD Menu display time before disappeared when no action is taken.

1. Press the ▲▼ button to select 10, 20, or 30 second.
2. Press the "ENTER" button to confirm.

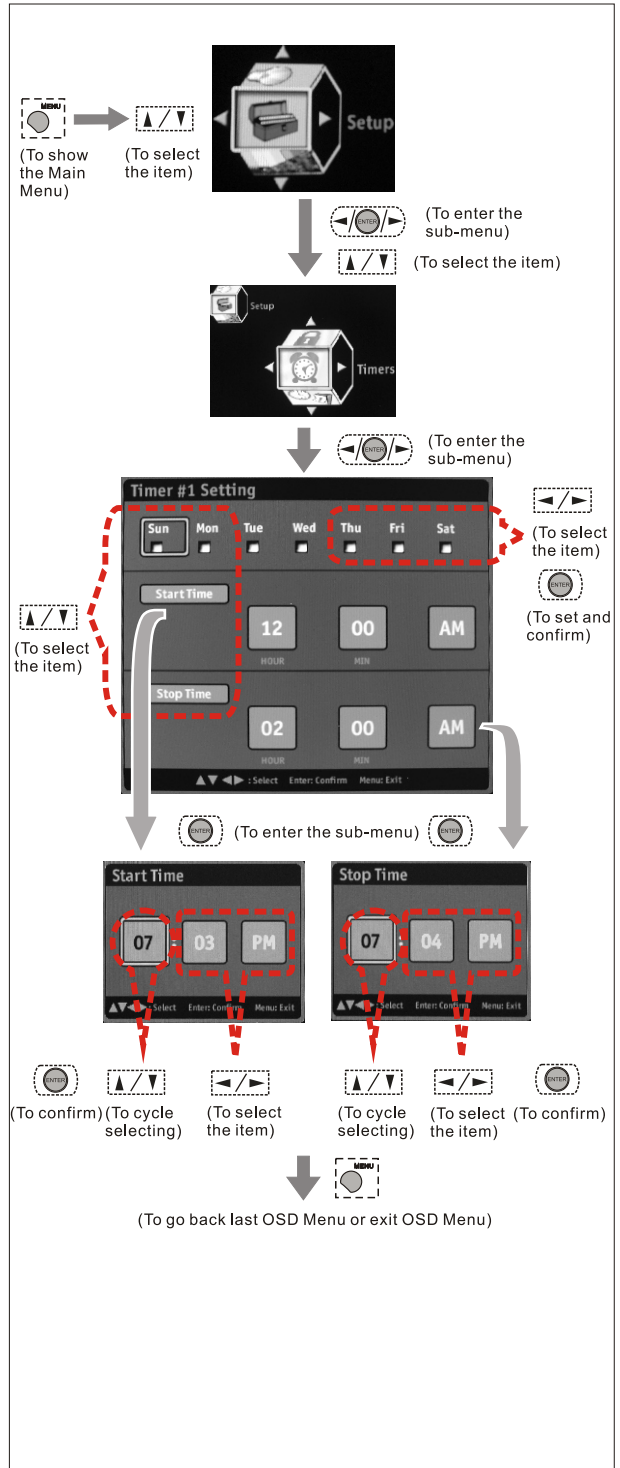

TV OSD Languages

➤ Languages

There are three language formats available for the OSD Menu. You may select it doing the following: English, Français, Español.

Setting DPMS

➤ DPMS

TV and Backlight will shut off automatically when no video source is detected when DPMS is active.

- * **On-** To activate this function
- * **Off-** To disable this function

Factory Default Option

➤ Factory Settings

You can reset all OSD settings to original manufacture settings for all input sources.

➤ Factory Settings by Input

You can reset all OSD settings to original manufacture settings for the source you select currently.

Displaying the Firmware Version

➤ Firmware Version

You can see the firmware version here that installed in the HDTV unit.

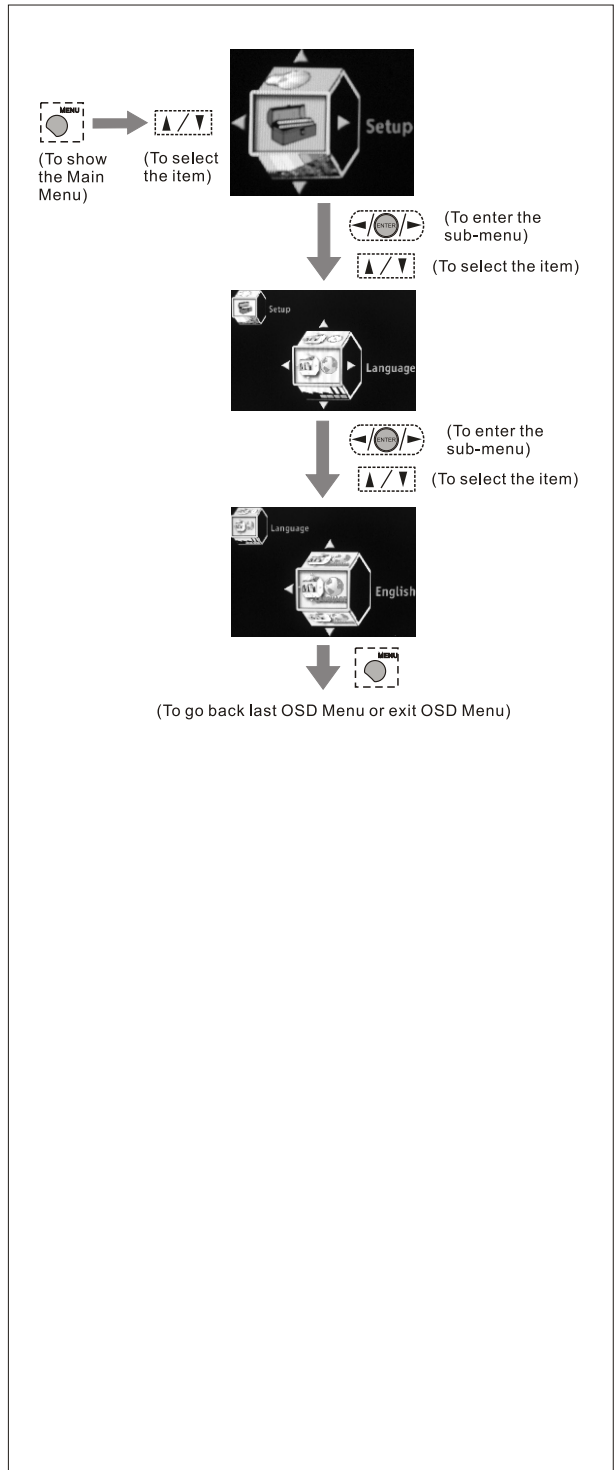

Specifications

TFT LCD Panel

Specifications								
Panel Size	20"	23"	27"	32" (Bottom)	32" (Side)	37"	40"	42"
Aspect Ratio	4:3	16:9	16:9	16:9	16:9	16:9	16:9	16:9
Pixels	640 X 480	1366 X 768	1366 X 768	1366 X 768	1366 X 768	1366 X 768	1366 X 768	1366 X 768
Dynamic Contrast Ratio	500:1	1600:1	1600:1	1600:1	1600:1	1600:1	1600:1	1600:1
H/V(View Angle)	178(H)/178(V)	178(H)/178(V)	178(H)/178(V)	178(H)/178(V)	178(H)/178(V)	178(H)/178(V)	178(H)/178(V)	178(H)/178(V)
Gray to Gray Response Time	8 ms	8 ms	8 ms	8 ms	8 ms	8 ms	8 ms	8 ms
			8 ms					
PC Compatible Frequency								
PC Compatible Frequency	640x480 @60Hz	56~75Hz Max. 1360x768 @60Hz						
Video Compatibility								
Video Compatibility	NTSC		—					
DTV & HDTV Compatibility								
DTV & HDTV Compatibility	480i, 480p, 576i, 576p, 720p, 1080i							
Aspect Ratio Adjustment								
Aspect Ratio Adjustment	Zoom1, Zoom2, Full Screen, 4:3, 1:1, Panoramic							
3D Comb Filter								
3D Comb Filter	Y							
3 : 2 / 2 : 2 Pull Down								
3 : 2 / 2 : 2 Pull Down	Y							
Digital Noise Reduction								
Digital Noise Reduction	Y							
Adjustable Color								
Adjustable Color	Native, 6500, 6500-User, 9300, 9300-User							
Temperature								
Temperature								
De-interlacer								
De-interlacer	Y							
VGA Auto Frequency								
VGA Auto Frequency	Y							
Correction								
Correction	Y							
TV Auto Frequency								
TV Auto Frequency	Y							
Detection								
Detection	Y							
Audio Processing								
Auto Sound Level Control								
Auto Sound Level Control	Y							
Output Watt								
Output Watt	2 (10W + 10W)							
Sound Effect								
Sound Effect	MTS (Mono / Stereo / SAP)							
Input Terminals								
TV Tuner								
TV Tuner	NTSC RF tunerx1	—						
Video Input								
Video Input	AV x1, S-Video x1, Y/Pb/Pr, Y/Cb/Cr x1, R/L x2							
Graphic Input								
Graphic Input	Input 1: RGB D-Sub 15 pin x1 Input 2: HDMI (DVI-D) x1, R/L x1							
Service Port								
Service Port	RS-232 Control Port (Mini DIN 8 Pins) x 1 USB Service Port (B Type) x 1							
Output Terminals								
Audio Output								
Audio Output	Output 1: Earphone							

* NOTE : Product Specification is Subject to Change without Notice.

TFT LCD Panel

Others	20"	23"	27"	32" (Bottom Speaker)
Power (Voltage)	AC 100-240V ~ 50/60 Hz 2.5A (Max)			
(Power Consumption)	75W	130W	130W	164W
Stand-by	< 1W			
Dimensions (W x H x D)	22.84" x 16.97" x 7.87"	27.1" x 16.5" x 8.3"	33.5" x 19.5" x 7.48"	31.89" x 24.6" x 9.37"
Carton Dimensions (W x H x D)	25.79" x 20.87" x 8.86"	30.31" x 19.48" x 8.86"	35.82" x 23.42" x 8.66"	35.43" x 27.36" x 11.02"
Weight w/ stand	15 lbs	15.4 lbs	25.36 lbs	33.1 lbs
Gross Weight	19.85 lbs	21 lbs	34.14 lbs	38.8 lbs

Others	32" (Side Speaker)	37"	40"	42"
Power (Voltage)	AC 100-240V ~ 50/60 Hz 2.5A (Max)			
(Power Consumption)	164W	271W	271W	271W
Stand-by	< 1W			
Dimensions (W x H x D)	37.76" x 22.20" x 9.37"	36.73" x 29.33" x 10.24"	39.36" x 32.08" x 13.8"	43.3" x 34.65" x 14.17"
Carton Dimensions (W x H x D)	42.80" x 25.35" x 12.40"	40.82" x 32" x 12"	43.7" x 36.3" x 15"	47.4" x 37.8" x 14.4"
Weight w/ stand	35.5 lbs	52.9 lbs	86 lbs	96 lbs
Gross Weight	45.4 lbs	62.84 lbs	104.7 lbs	107 lbs

Dimensional Drawing

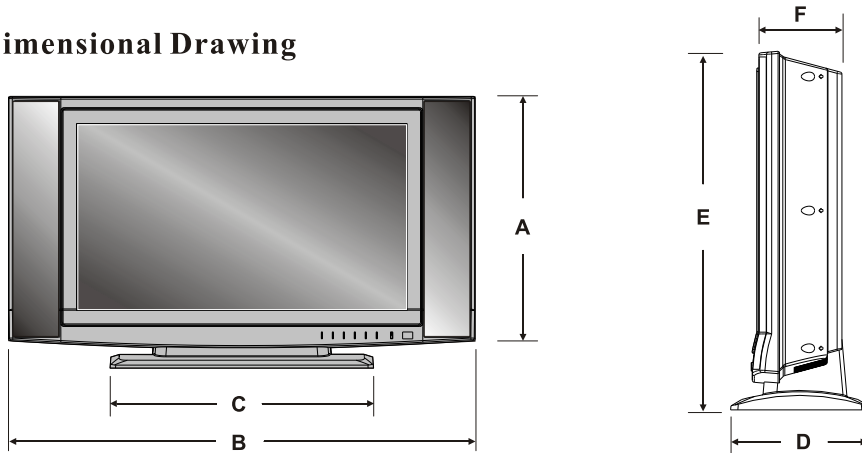

Size	A	B	C	D	E	F
Model						
20"	15.71 in	22.84 in	16.02 in	7.87 in	16.97 in	3.47 in
23"	14.96 in	27.10 in	13.70 in	8.30 in	16.50 in	4.19 in
27"	17.48 in	33.46 in	18.90 in	7.48 in	19.50 in	4.63 in
32" (Bottom)	23.60 in	31.89 in	23.58 in	9.37 in	24.60 in	4.92 in
32" (Side)	20.67 in	37.76 in	23.58 in	9.37 in	22.20 in	4.92 in
37"	27.36 in	36.73 in	28.31 in	10.24 in	29.33 in	5.59 in
40"	30.67 in	39.36 in	37.64 in	13.80 in	32.08 in	5.55 in
42"	32.82 in	43.30 in	37.64 in	13.80 in	34.65 in	6.05 in

Timing Mode for VGA

Source	Resolution	Vertical frequency (Hz)
YPbPr	480p	59.94
	720p	60
	1080i	30
VGA	640x480	60
		75
	800 x 600	60
		75
	1024 x 768	60
		75
	1280 x 768	60
	1360 x 768	60

Pixels Policy

Syntax-Brilliant's D.O.A. Policy for HDTV Readys for Defective Pixels on LCD Panels

(Applicable to the HDTV Ready sold within USA & Canada only)

Syntax-Brilliant™ HDTV Readys are evaluated at a distance of approximately 50 centimeters (approximately 20 inches) between the LCD panel and the eyes of the user at a 90 degrees viewing angle. All LCD panels have been tested to ensure they comply with our factory standards. Our evaluation is based on the number of defective pixels and the distance between any two defective pixels. Bright dots are dots that appear bright and unchanged in size when a HDTV Ready screen displays under a black pattern; dark dots are dots that appear dark and unchanged in size when a HDTV Ready screen is displayed under pure red, green, or blue patterns ("defective pixels"). Adjacent dots are dots located directly next to each other.

Customers are required to check their LCD panel immediately after purchase. To identify defective pixels, the LCD panel should be examined under normal operating conditions as mentioned above, preferably in its native display resolution, and with a 90 degrees viewing angle.

A HDTV Ready will be considered dead on arrival (D.O.A.) with regards to defective pixels on the LCD panel when any one of the following criteria is met:

- A total of 7 defective pixels including both bright dots and dark dots are present (the typical 30" LCD Television screen has 1 million pixels), or
- 2 or more pairs of adjacent bright dots are present, or
- 3 adjacent bright dots are present, or
- 3 adjacent dark dots are present.

In view of customers' concerns about dead pixels, Syntax-Brilliant™ would like to address that defective pixels are not ultimately avoidable with the current LCD industry standard panel manufacturing processes. We always strive to improve our technology and minimize the chance of occurrence of defective pixels by applying strict screening processes in our factory production processes. However, Syntax-Brilliant™ cannot guarantee that a return unit to our customers will be 100% free of defective pixels.

For questions, please call our toll free service number in the USA at 888-Syntax-Brilliant-8.

"At Syntax-Brilliant™ Groups, a satisfied customer is our most important focus."

Glossary

3:2 pull down - Process of converting 24 frames per second film to video by repeating one film frame as three fields, then the next film frame as two fields.

1	1	1	2	2	1	1	1	2	2
---	---	---	---	---	---	---	---	---	---

480I - 480 lines of display every 1/60 of a second; image is displayed by interlace scanning. See also Interlaced

480P - 480 lines of display every 1/60 of a second; image is displayed by progressive scanning. See also Progressive.

720P - 720 lines of display every 1/60 of a second; image is displayed by progressive scanning. See also Progressive.

1080I - 540 lines of display x 2 every 1/30 of a second; image is displayed by interlace scanning. See also Interlaced

16:9 - Aspect ratio under Hi Def. and theater movie formats. Also known as widescreen; see Aspect Ratio

4:3 - Aspect ratio under SDTV; see Aspect Ratio

Active Matrix TFT (Thin Film Transfer) - A type of display technology where the three primary colors are modulated. Results in better contrast ratios suitable for video.

Alarm - Feature on the Syntax-Brilliant Olevia models. Allows the unit to power on from the stand by mode.

Alarm Time - Time specified as to when the unit will power on. See Alarm.

Aspect Ratio - The ratio of an image according to the width and height of a picture.

ATSC - Advanced Television Systems Committee; international, non-profit organization that is committed to developing standards for digital television.

Reference: <http://www.atsc.org>

Bezel - Refers to the plastic or metal frame that acts like a shell around the LCD glass.

Backlight - Refers to the component, that lights up the LCD display.

Balance - Feature on the OSD for the Syntax-Brilliant Olevia models that adjust the left and right sound output from the speakers.

Background - Feature on the OSD for the Syntax-Brilliant Olevia models, which allows the user to change the OSD background, display to transparent or opaque.

Brightness - The measurement of color that is illuminated. Colors range from black to white.

CATV - Community Antenna Television (Cable Television)

Channel Favorite - Feature on the OSD for the Syntax-Brilliant Olevia models that allows the user to scroll through a defined list of channels that the user sets up.

Channel Edit - Feature on the OSD for the Syntax-Brilliant Olevia models that allows the user add or delete a channel.

Channel Source - Feature on the OSD for the Syntax-Brilliant Olevia models that lets the user select the source of their channels. Select TV for antennae or CATV for cable television.

Channel Auto Scan - Feature on the OSD for the Syntax-Brilliant Olevia models that when initiated, will determine which channels are available and which are not. If a desired channel is not accessible, you can add the channel in manually. See Channel Edit.

Channel Fine Tune - Feature on the OSD for the Syntax-Brilliant Olevia models that enables the user to tune the channel for better reception.

Chroma - (Chrominance) Refers to the color characteristics of a video signal.

CC - Closed Caption

Color - The term refers to the amount of color present. This varies between each user, as each person perceives colors differently.

Color Temperature - Feature on the OSD for the Syntax-Brilliant Olevia models that enables warm, normal or cool color settings. Warm emphasizes red, cool emphasizes blue, and normal doesn't emphasize any of the primary colors. This setting may affect each person individually depending on how color is perceived.

Comb Filter - A filtering system designed to removal unwanted artifacts by rejecting certain frequencies while permitting others.

Component - A three RCA type input that uses high quality cables (one for brightness, and two for color). Process increases bandwidth resulting in more color information to be carried to the TV producing a more accurate picture.

Composite - Also known as CVBS, Technology that permits the combination of color information and brightness under one wire. A single video signal that carries both brightness and color information are contained in a single wire.

Contrast - Difference in luminance between the white and black colors.

CRT - Cathode Ray Tube.

DB15 - Also referred to as VGA; See VGA

De-Interlace - Process of converting an interlaced video signal.

Display Area - The perimeter of the LCD glass the image is displayed on. See Video Resolution

Dual Link - See Single Link; Supports a maximum bandwidth of 2 x 165 MHz (1920 x 1080 @ 60 Hz, 1280 x 1024 @ 85 Hz).

DVI - Digital Video Interface Describes the technology that is used to take full advantage of a signal when paired with a high-end video card and flat panel displays

DVI-A - Digital Video Hi-Resolution Analog

DVI-D - Digital Video Interface Digital; Cable is used for direct connection from one digital source to the TV; See DVI

DVI-I - Digital Video Interface Integrated; Cable that supports analog and digital signals; See DVI

DTV - Digital Television

Factory Default - Feature on the OSD for the Syntax-Brilliant Olevia models that resets all menu options to factory default.

F-Connector - The standard connector found on video equipments that coaxial cables connect to.

Flat-Panel Display - ultra thin displays, usually found in notebooks are now entering the TV appliances sector as new technology enables wider/larger screens.

Frame - A complete picture that includes both even and odd lines. 30 video frames are present in 1 second.

Gain - Describes the amplification level of a particular signal.

HDCP - High bandwidth Digital Content Protection

HDTV - 1.High Definition Television 2. Designates as the unit having a built in ATSC tuner to decode High Definition signals (720P/1080I).

HD-Ready - A unit that supports the High Definition displays (720P/1080I) with the help of a Set-Top Box.

Horizontal Resolution - Refers to the number of vertical black and white lines defined along a horizontal line.

IR - Infrared

Input - term used in the On Screen Display

- Interlaced** - Images are the result of lines of data reassembled. Interlaced refers to the process of an image's odd lines reassembled from top to bottom taking about 1/60 of a second, before reassembling the even lines which results in a full picture. Antonym: Progressive
- Language** - Feature on the OSD for the Syntax-Brilliant Olevia models that enables the OSD to be read in different languages.
- LCD** - Liquid Crystal Display
- LCoS** - Liquid Crystal on Silicon
- LED** - Light Emitting Diode
- Luminance** - refers to the brightness of an image.
- Lux** - 1 Lux = 1 footcandle; measurement of brightness
- Moire** - A visual illusion in which a succession of parallel curved lines produces a pattern to the naked eye, but does not really exist. Otherwise known as the moire effect.
- NCTA** - National Cable Television Association
- Noise reduction** - Feature on the OSD for the Syntax-Brilliant Olevia models that enables channels from the tuner box to reduce noise displayed on the LCD unit.
- NTSC** - National Television systems Committee
- OSD** - On Screen Display; brought up by pressing the menu button on the TV or the Remote.
- Over Scanning** - An image displayed is larger than the display area
- PAL** - Phase Alternating Line
- Parental Control** - The ability to block access to specified content from an unsuitable audience.
- PIP** - Picture in Picture; feature that enables one source to be displayed on top of another source.
- Pixel Resolution** - Refers to the number of rows horizontal and vertical that produces the image.
- PIP** - Picture in Picture; Allows an image to be displayed in front of another image.
- Plug and Play** - Describes the hardware or software that is installed and does not require any configuration before using.
- Progressive** - An image or lines of data that is reassembled from top to bottom sequentially.
- Antonym:** Interlaced
- RGB** - Red, green & blue These primary colors provide the basis for many different colors.
- Refresh Rate** - Refers to the maximum number of frames that the monitor can display per second. Usually measured in hertz.
- Saturation** - The amount of a particular color present in an image.
- SCART** - An industry standard for interconnecting audio-video equipment developed by Peritel. Usually associated with PAL video equipment.
- SDTV** - Standard Definition Television usually in 480I/P format.
- SECAM** - Sequential Color with Memory or Sequential Couleur Avec Memoire
- Set-Top-Box** - box that is capable of receiving and decoding digital transmissions (i.e. High Definition Cable Box, Digital Cable box).
- Sharpness** - Tries to artificially enhance the edges of a picture.
- Single Link** - supports a maximum bandwidth of 165 MHz (1920 x 1080 @ 60 Hz, 1280 x 1024 @ 85 Hz).
- Split screen** - Feature that places two images side by side.

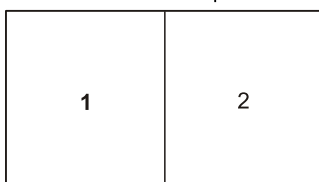

Swap - Button featured on the Olevia remote. Used in the POP3 or PIP12 views to swap the sub viewable boxes with the main viewable box.

Tint - Adjusts the whiteness level within the color. Similar to Hue.

Under- scanning Term used where the image displayed is smaller than the display area.

Up convert - Process of converting a 480P/I signals to 720P or 1080I.

V-Chip - Chip that controls access to forbidden content specified by an adult.

VGA - 1. Video Graphics Array (DB15) 2.

Video Display - Refers to the display resolution

Video Resolution

Aspect Ratio 4:3		Aspect Ratio 16:9	
VGA	640 x 480	WXGA	1280 X 800
SVGA	800 x 600	SXGA	1280 X 1024
XGA	1024 x 768	WXGA+	1400 X 1050
QVGA	1280 x 960	WSXGA	1680 X 1050
SXGA+	1400 x 1050	WUXGA	1920 X 1200
UXGA	1600 x 1200	QSXGA	2560 X 2048
QXGA	2048 x 1536		
QSXGA+	2800 x 2100		
QUXGA	3200 x 2400		

Viewable Angle - Angle at which the screen is still viewable.

Widescreen - See 16:9

YCbCr - Used often with standard interlaced video equipment. See Component

YPbPr - Used often with progressive video equipment. See Component