

Return your Warranty Registration card today to ensure you receive all the benefits you're entitled to

Registering your model with PHILIPS makes you eligible for all of the valuable benefits listed below, so don't miss out. Complete and return your Product Registration Card at once to ensure:

* Proof of Purchase

Returning the enclosed card guarantees that your date of purchase will be on file, so no additional paperwork will be required from you to obtain warranty service.

* Product Safety Notification

By registering your product you'll receive notification - directly from the manufacturer - in the rare case of a product recall or safety defect.

* Additional Benefits of Product Ownership

Registering your product guarantees that you'll receive all of the privileges to which you're entitled, including special money-saving offers.

PHILIPS

Congratulations on your purchase, and welcome to the "family!"

Dear PHILIPS product owner:

Thank you for your confidence in PHILIPS. You've selected one of the best-built, best-backed products available today. We'll do everything in our power to keep you happy with your purchase for many years to come.

As a member of the PHILIPS "family," you're entitled to protection by one of the most comprehensive warranties and outstanding service networks in the industry.

What's more, your purchase guarantees you'll receive all the information and special offers for which you qualify, plus easy access to accessories from our convenient home shopping network.

Most importantly, you can count on our uncompromising commitment to your total satisfaction.

All of this is our way of saying welcome - and thanks for investing in a PHILIPS product.

P.S. To get the most from your PHILIPS purchase, be sure to complete and return your Product Registration Card at once.

Know these **safety** symbols



 This "bolt of lightning" indicates uninsulated material within your unit may cause an electrical shock. For the safety of everyone in your household, please do not remove product covering.

 The "exclamation point" calls attention to features for which you should read the enclosed literature closely to prevent operating and maintenance problems.

WARNING: To reduce the risk of fire or electric shock, this apparatus should not be exposed to rain or moisture and objects filled with liquids, such as vases, should not be placed on this apparatus.

CAUTION: To prevent electric shock, match wide blade of plug to wide slot, fully insert.

ATTENTION : Pour éviter les chocs électriques, introduire la lame la plus large de la fiche dans la borne correspondante de la prise et pousser jusqu'au fond.

For Customer Use

Enter below the Serial No., which is located on the rear of the cabinet. Retain this information for future reference.

Model No. _____

Serial No. _____



PHILIPS

Visit our World Wide Web Site at www.usasupport.philips.com

IMPORTANT SAFETY INSTRUCTIONS

Read before operating equipment

1. Read these instructions.
2. Keep these instructions.
3. Heed all warnings.
4. Follow all instructions.
5. Do not use this apparatus near water.
6. Clean only with a dry cloth.
7. Do not block any of the ventilation openings. Install in accordance with the manufacturers instructions.
8. Do not install near any heat sources such as radiators, heat registers, stoves, or other apparatus (including amplifiers) that produce heat.
9. Do not defeat the safety purpose of the polarized or grounding-type plug. A polarized plug has two blades with one wider than the other. A grounding type plug has two blades and a third grounding prong. The wide blade or third prong are provided for your safety. When the provided plug does not fit into your outlet, consult an electrician for replacement of the obsolete outlet.
10. Protect the power cord from being walked on or pinched particularly at plugs, convenience receptacles, and the point where they exit from the apparatus.
11. Only use attachments/accessories specified by the manufacturer.
12.  Use only with a cart, stand, tripod, bracket, or table specified by the manufacturer, or sold with the apparatus. When a cart is used, use caution when moving the cart/apparatus combination to avoid injury from tip-over.
13. Unplug this apparatus during lightning storms or when unused for long periods of time.
14. Refer all servicing to qualified service personnel. Servicing is required when the apparatus has been damaged in any way, such as power-supply cord or plug is damaged, liquid has been spilled or objects have fallen into apparatus, the apparatus has been exposed to rain or moisture, does not operate normally, or has been dropped.
15. This product may contain lead or mercury. Disposal of these materials may be regulated due to environmental considerations. For disposal or recycling information, please contact your local authorities or the Electronic Industries Alliance: www.eiae.org.
16. **Damage Requiring Service** - The appliance should be serviced by qualified service personnel when:
 - A. The power supply cord or the plug has been damaged; or
 - B. Objects have fallen, or liquid has been spilled into the appliance; or
 - C. The appliance has been exposed to rain; or
 - D. The appliance does not appear to operate normally or exhibits a marked change in performance; or
 - E. The appliance has been dropped, or the enclosure damaged.
17. **Tilt/Stability** - All televisions must comply with recommended international global safety standards for tilt and stability properties of its cabinets design.
 - Do not compromise these design standards by applying excessive pull force to the front, or top, of the cabinet which could ultimately overturn the product.
 - Also, do not endanger yourself, or children, by placing electronic equipment/toys on the top of the cabinet. Such items could unsuspectingly fall from the top of the set and cause product damage and/or personal injury.
18. **Wall or Ceiling Mounting** - The appliance should be mounted to a wall or ceiling only as recommended by the manufacturer.
19. **Power Lines** - An outdoor antenna should be located away from power lines.
20. **Outdoor Antenna Grounding** - If an outside antenna is connected to the receiver, be sure the antenna system is grounded so as to provide some protection against voltage surges and built up static charges. Section 810 of the National Electric Code, ANSI/NFPA No. 70-1984, provides information with respect to proper grounding of the mats and supporting structure grounding of the lead-in wire to an antenna-discharge unit, size of grounding connectors, location of antenna-discharge unit, connection to grounding electrodes and requirements for the grounding electrode. See Figure below.
21. **Objects and Liquid Entry** - Care should be taken so that objects do not fall and liquids are not spilled into the enclosure through openings.
 - a) **Warning:** To reduce the risk of fire or electric shock, this apparatus should not be exposed to rain or moisture and objects filled with liquids, such as vases should not be placed on this apparatus.
22. **Battery Usage CAUTION** - To prevent battery leakage that may result in bodily injury, property damage, or damage to the unit:
 - Install all batteries correctly, with + and - alignment as marked on the unit.
 - Do not mix batteries (old and new or carbon and alkaline, etc.)
 - Remove batteries when the unit is not used for a long time.

EXAMPLE OF ANTENNA GROUNDING AS PER NATIONAL ELECTRICAL CODE (NEC)

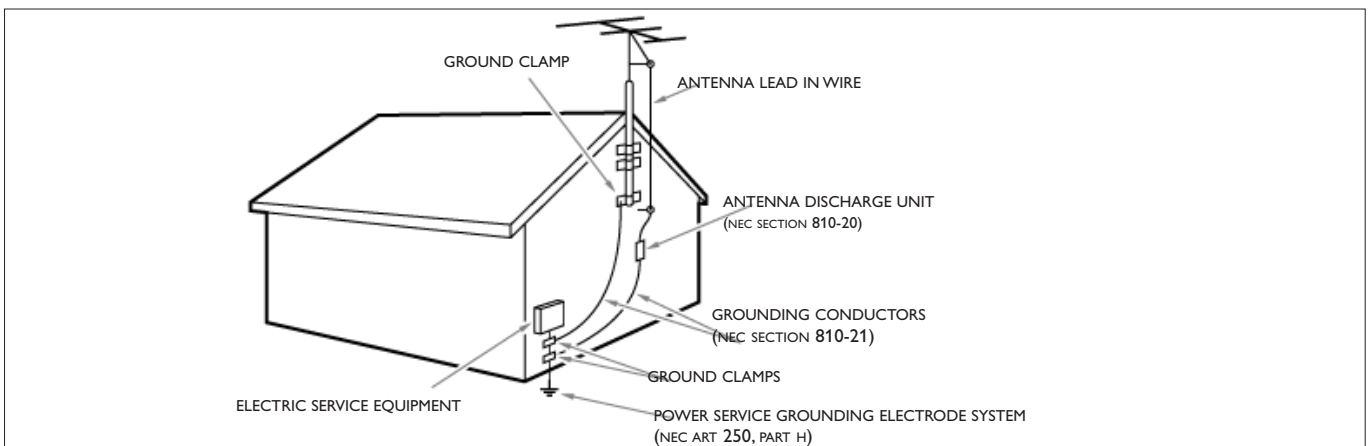

Note to the CATV system installer: this reminder is provided to call the CATV system installer's attention to Article 820-40 of the NEC that provides guidelines for proper grounding and, in particular, specifies that the cable ground shall be connected to the grounding system of the building, as close to the point of cable entry as practical.

Contents

Help?

If this instruction manual does not give an answer or if 'Before Calling Service' does not solve your TV problem, you can call your Local Philips Customer or Service Centre. See the supplied World-wide guarantee booklet.

Please, have the Model and Serial number which you can find at the back of your television set or on the packaging ready, before calling the Philips helpline 1-888-PHILIPS (744-5477).

Model: 37PF7320A/37
42PF7320A/37
50PF7320A/37
42PF7220A/37
50PF7220A/37

Serial No:

Care of the screen

See Tips, p. 39.

End of life directives

Philips is paying a lot of attention to producing environmentally-friendly in green focal areas. Your new TV contains materials which can be recycled and reused. At the end of its life specialized companies can dismantle the discarded TV to concentrate the reusable materials and to minimize the amount of materials to be disposed of. Please ensure you dispose of your old TV according to local regulations.

Digital Cable TV	2
Preparation	2
Use of the remote control RC4345	5
Buttons on the right of the TV	8
My Content	8
To use the menus	9
Introduction	9
How to navigate through the Settings menus	9
Demo	9
Installation	10
Select the menu language	10
Store TV channels	10
Weak channel installation	11
Software upgrade	11
Setup menu	12
Preferences	12
Source	16
Clock	17
CableCARD applications	18
TV menu	19
Picture menu	19
Sound menu	21
Features menu	22
Channels menu	23
Multimedia browser	26
Viewing content from a USB device	26
Multimedia Browser menu	27
Connect Accessory Devices	28
Recorder (vcr-dvd+rw)	29
Recorder and other A/V devices	30
Recorder and cable box with RF output	31
Satellite Receiver / cable box with AV outputs	32
Recorder and Satellite Receiver / cable box with AV outputs	32
DVD Player or other accessory digital source devices	33
HDMI (High Definition Multimedia Interface) connectors	34
Digital Surround receiver	34
Side connections	35
Record with your recorder	36
Record a TV program	36
Record a program from monitor out	36
To select connected devices	36
Audio- and video equipment buttons	37
Before Calling Service	38
Tips	39
Annex 1 - Philips TV software upgrade with portable memory	40
Annex 2: Philips TV Slideshow Format with background music	42
Annex 3 - Philips TV - USB	44



Digital Cable TV

Your new TV is provided with a special slot called a CableCARD™ which means that you do not need a separate set top box to receive digital cable SDTV and HDTV programs. However it is still possible to connect a set top box to your TV.

The CableCARD, which will be available from your cable system operator, is designed only for that particular digital cable TV system. If you need to get digital cable TV from a different system, simply swap your old CableCARD for a new one.

Cable systems can provide a wide range of digital TV programs and even specialized digital audio channels.

Cable TV systems can offer many local-interest channels you won't see off-air or from a satellite broadcast.

Examples include local school and community access channels.

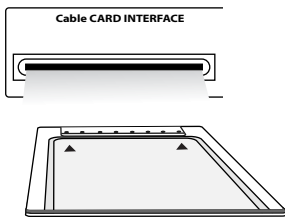

CableCARD™ *

A CableCARD is a removable card distributed by cable companies, that is inserted into the CableCARD slot at the bottom of your television. CableCARD allows you to tune digital and high definition scrambled or encrypted cable channels through the cable antenna. Consult your cable company on the availability of CableCARD. The CableCARD is required to receive premium digital TV channels and services (where available) through the cable.

A CableCARD functionality includes conditional access and copy protection. See settings menu, CableCARD applications, p. 18.

Note: Do not insert a PCMCIA card into the CableCARD slot.

* CableCARD™ is a trademark of Cable Television Laboratories, Inc.

Preparation

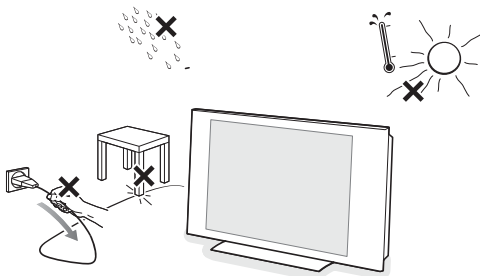

Do not insert the power plug in a wall socket before all connections are made.

Place the TV on a solid surface or place the TV on the supplied stand. For the mounting instructions of the stand, see the Quick Start Guide leaflet supplied.

For ventilation, leave at least 4" to 6" free all around the TV. Do not place the TV on a carpet. To prevent any unsafe situations, no naked flame sources, such as lighted candles, should be placed in the vicinity.

Avoid heat, direct sunlight and exposure to rain or water. The equipment shall not be exposed to dripping or splashing.

Mounting the TV on the wall

This TV provides the VESA mounting interface (not supplied) and is VESA compatible with the 4 supplied VESA studs to be inserted in the back of the TV.

Caution: Installing the TV requires special skill that should only be performed by qualified personnel. You should not attempt to do the work yourself. Philips bears no responsibility for improper mounting or mounting that results in accident or injury.

Make sure that the wall mount is being fixed securely enough so that it meets safety standards.

1 Basic connections to the TV

Your integrated digital TV automatically decodes and displays the four basic DTV picture resolution standards.

- SDTV (Standard Definition TV) are broadcast as 480i (480-line interlaced) or 480p (480-line progressive scan) video.
- HDTV (High-Definition TV) are broadcast either in the 1080i or 720p formats, always with a widescreen picture.

Note: Progressive scan video (p) is more like that you see in a movie theater. Images are much more distinct and free of flicker, and motion is smoother.

Next to analog NTSC broadcast reception, your TV has an integrated High Definition TV tuner which receives, decodes and displays terrestrial ATSC and unscrambled cable (QAM) signals.

HDTV quality is only reproduced when a broadcaster or cable provider broadcasts HDTV signals.

Note: Ask your broadcaster or cable box provider to transmit/enable HD content to your home, and possibly upgrade to a CableCard for the decryption of HD signals.

There are 2 ways to get HDTV content:

- via cable,
- via antenna.

Note: This drawing is used wherever you can connect cable or antenna.

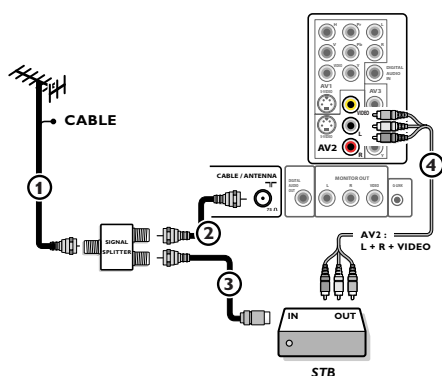
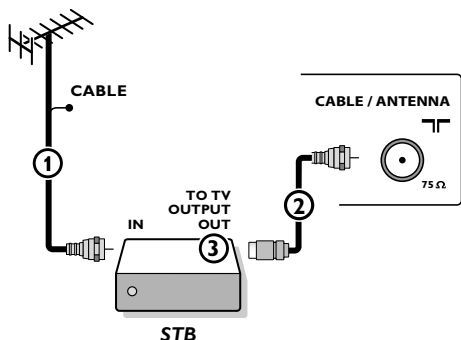
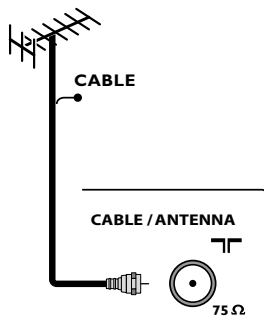

Watching Cable TV programs that don't require the cable box

Since you've connected the cable TV signal directly to the TV's tuner, you can also watch the unscrambled programs by simply tuning to the desired channel. You must first use Autoprogram, however, to store channels in the TV's memory. See page 10.

Note: This connection will supply stereo sound to the TV if it is being broadcast by the station you are watching.

- Cable TV

Connect the cable TV signal to the **CABLE/ANTENNA 75 Ω** jack at the bottom of the TV. See page 10 for details on using Autoprogram to store channels in the TV's memory.

Note: this connection will supply stereo sound to the TV if it is being broadcast by the station you are watching.

- Cable box with RF IN/OUT

- Connect the incoming cable TV signal to the cable **IN** jack ① on the back of the cable box.
- Connect a coaxial cable (not supplied) from the **TO TV** jack on the back of the cable box to the **CABLE/ANTENNA 75 Ω** jack ② at the bottom of the TV.
- Set the **OUTPUT CH** switch ③ of the cable box to **CH 3** or **4** (whichever is correct for your cable box), then tune the TV to the corresponding channel.

Once tuned, change channels at the cable box, not the TV.

*Note: This connection will not supply stereo sound to the TV. The reason is that the RF output on a cable box - labeled **TO TV**, **OUT** or **OUTPUT** for example - will not send a stereo signal to the tuner (VHF/UHF) input on a TV.*

- Cable box with A/V outputs

- Connect the incoming cable TV signal ① to a signal splitter (not supplied). The signal splitter enables you to avoid having to use the **TO TV** jack on the back of the cable box. This jack will not supply stereo sound to the TV.
- *Note: Your cable box may have a different label for the **TO TV** jack, such as **OUTPUT** or **OUT**.*
- Connect a coaxial cable (not supplied) to a connector on the signal splitter and to the **CABLE/ANTENNA 75 Ω** jack ② on the TV.
- Connect another coaxial cable (not supplied) to a connector on the signal splitter and to the cable **IN** jack ③ on the back of the cable box.
- Connect A/V cables (not supplied) to the **VIDEO** and **AUDIO L** and **R** outputs on the back of the cable box and to the **AV2** video (labeled **VIDEO**) and **AUDIO** (labeled **L** and **R**) jacks ④ on the back of the TV.
- To view programs from your cable box, first press the **AV+** button on the remote control.
- Press the cursor down or up buttons until the **AV2** signal source is selected.
- Press the **OK** button to confirm your selection. The **AV2** input source becomes current for the viewing of cable TV programs through your cable box.

*Note: If your cable box Audio/Video outputs will not supply video and stereo audio to the TV, you will need to make the connection shown above in the example "Cable box with **RF IN/OUT**".*

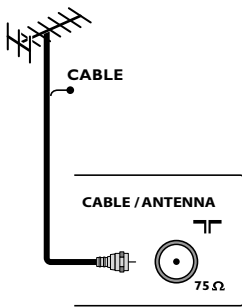

- **Cable box with S-Video, component video (YPbPr) or HDMI connectors**

See Connect Accessory Devices, p. 31-32.

- **Antenna**

Via antenna you can watch whatever DTV programs being broadcast in your area for free.

If you're not sure what HDTV programming is available in your area, contact your local content provider or your local electronics store retailer.

Broadcasters are in the middle of a transition from analog to digital TV.

This means that a given broadcaster will have two channels on the air, one analog and one digital.

Connect the incoming antenna signal to the **CABLE/ANTENNA 75 Ω** port jack at the bottom of the TV. See page 10 for details on using Autoprogram to store channels in the TV's memory.

Note: This connection will supply stereo sound to the TV if it is being broadcast by the station you are watching.

- **Direct Broadcast Satellite (DBS)**

Satellite systems offer many of the same premium channels as cable systems, and often at a lower price. To get these channels, you'll need to install a small dish antenna outside.

There are 2 main DBS systems: DirecTV & DishNetwork. These systems require separate, proprietary set top receiver boxes to decode their signals and send them to your digital TV set. These boxes may include a digital TV tuner for off-air DTV broadcasts.

Satellite broadcasters also provide major local channels, depending on the market in which you live.

DBS also provides service in areas not covered by cable because they are in rural areas or other areas not passed by a cable line.

DBS also allows you to watch pay-per-view events.

- 2 Before installing your TV or before hanging it on the wall, connect all your accessory devices. See p. 28.
- 3 Refer to the bottom of the set for the correct operation voltage. Insert the power cord in the wall socket. Consult your local dealer if your mains supply is different. To prevent damaging the mains (AC) cord which could cause a fire or electric shock, do not place the TV on the cord.

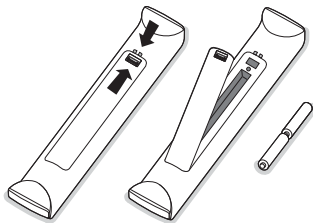

- 4 **Remote control:** Insert the 2 batteries supplied (Type R6-1,5V). Be sure the (+) and (-) ends of the batteries line up correctly (inside of case is marked.)

The batteries supplied do not contain the heavy metals mercury and cadmium. Please check on how to dispose of exhausted batteries according to local regulations.

- 5 **Turn the TV on:** Press the power switch  at the right side of the TV. An indicator on the front of the TV lights up. Press the **+CH/PAGE-** buttons or the **POWER** button on the remote control.

First time installation

*Note: The first time (and only the first time) you turn on your set you see an installation introduction screen. The **Installation procedure** consists of a series of screens that guide you through the process.*

- 1 After an introduction screen, you are asked to select a language of the TV's on-screen-menus. (The text of the header and the info on screen continuously change language.)
- 2 Press the cursor up/down to highlight your language.
- 3 Press the **OK** button.
- 4 Follow the on-screen instructions to proceed.

Note: Once you completed the initial installation procedure you can access the screens from the Settings menu. See p. 10.

Use of the remote control RC4345

Note: For most buttons pressing a button once will activate the function. Pressing a second time will de-activate it.

When a button enables multiple options, a small list will be shown. Press repeatedly to select the next item in the list. The list will be removed automatically after 6 seconds or press **OK** to remove immediately.

Attention: This remote control can not be programmed to work accessory devices.

DVD/R CBL TV VCR AUX

Press the **SELECT** button repeatedly to select one of the system modes in which the remote control can be used. If no action is being undertaken within 60 seconds, the remote control returns to TV mode.

After an action in the selected system mode the remote control will remain in this mode for 60 seconds and will then return to TV mode.

DEMO Demo menu on/off

See p. 9.

CLOCK on/off

Time display (for max. 10 minutes)

Color buttons

When functions attached to the color buttons, the color buttons are shown on screen.

MY CONTENT

Press to display the My Content menu on or off, see p. 8.

- OK**
- to activate a setting
 - to display the list of channels stored (according to the selection made in the Installation mode (Antenna or Cable), p. 10.
 - starts playing content in the Home Multimedia Browser application, p. 27.

MENU Settings menu on/off, see p. 10.

VOL Volume

Press + or - to adjust the volume.

MUTE

Interrupt the sound or restore it.

A/CH

Press to alternate between the currently viewed channel and the previously viewed channel.

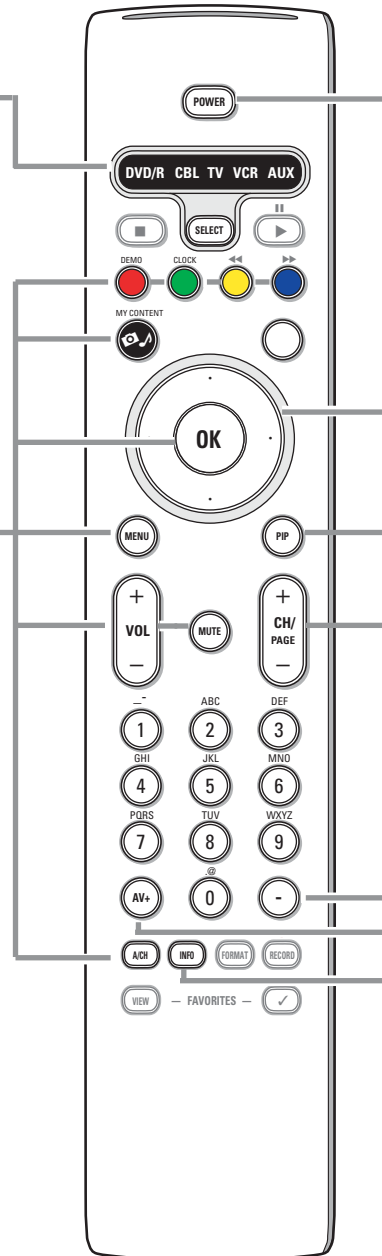

POWER

Press to turn on/off the TV from or to standby mode.

The TV is never powered off completely unless it is physically unplugged.

○ no function

Cursor buttons

Press the cursor buttons up/down, left/right to navigate through the menus.

Note: If necessary, you can adjust the picture position to the center of the screen with the cursor keys.

PIP HDMI Dual screen/PIP See p. 12.
To watch a broadcast and a HDMI source simultaneously.

CH/PAGE Channel selection

- To browse through the TV channels or sources stored in the preferred channel list (see p. 25).
- To select between Antenna or Cable TV channels, first make your selection in the Settings menu, see, p. 10.

Note: You don't have to start the installation again once you have searched for and stored the available TV channels.

AV+ Press this button repeatedly to select **AV1, AV2, AV3, HDMI1, HDMI2, SIDE** or **TV** when in TV mode, according to where you connected the accessory devices (p. 33).

- Type the dash (-) for digital channels.

INFO

- **Display information:** Press to display (when available) information about the selected TV channel and program or accessory device.



FORMAT

Press this button to summon a list of available display formats (depending on the receiving signal). This lets you choose the display format of your preference.

Press this button repeatedly to select another picture format: Automatic, Super Zoom, 4:3, Movie expand 14:9, Movie expand 16:9, 16:9 subtitle, Wide screen.

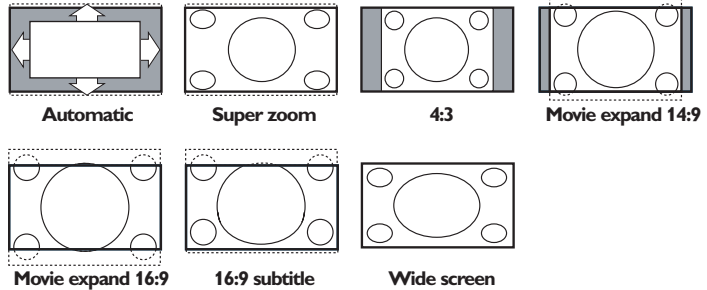

Automatic makes the picture fill the screen as much as possible.

Super zoom removes the black bars on the sides of 4:3 programs with minimal distortion.

When in Movie expand 14:9, Movie expand 16:9 or Super zoom picture format, you can make subtitles visible with the cursor up/down.

Note: With HD sources not all screen formats will be available.

FAVORITES

- **VIEW** To display a list of all channels marked as favorite (incl. subchannels).
- ✓ To add or remove a channel in the favorite list of TV channels.



- Audio and Video equipment buttons. See p. 34.
- Multimedia browser functional buttons. See p. 27.

- no function

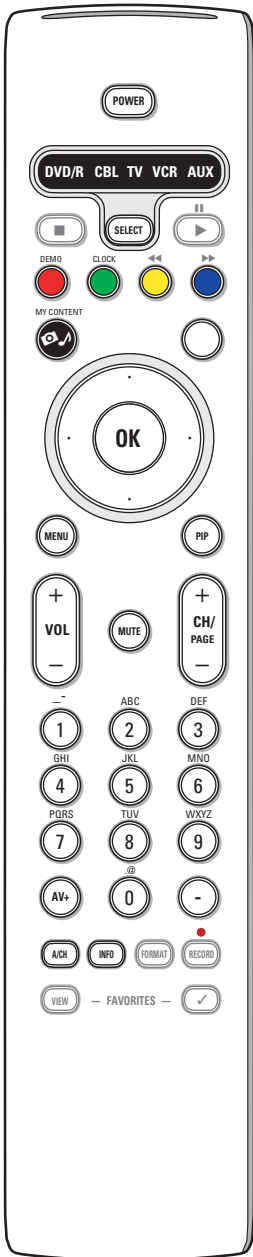

Alphanumeric buttons on the remote control

The alphanumeric buttons on the remote control can be used to enter digits and text.

Multi-tap entry can be used to enter alphanumeric information when necessary.

The characters displayed are dependent on the language selected in the Installation menu. See p. 10.

Text is entered similar to the method used for entering text messages on a cellular phone.

When a letter or number has been entered, the cursor automatically advances to the next character position after the specified time out or by pressing the cursor right.

RC button	Default Multi-tap Alphanumeric entry order
1	<space> _ - 1 <space> _ - 1 (etc.)
2	a b c A B C 2 a b c (etc.)
3	d e f D E F 3 d e f (etc.)
4	g h i G H I 4 g h i (etc.)
5	j k l J K L 5 j k l (etc.)
6	m n o M N O 6 m n o (etc.)
7	p q r s P Q R S 7 p q r s (etc.)
8	t u v T U V 8 t u v (etc.)
9	w x y z W X Y Z 9 w x y z (etc.)
0	. @ 0 . @ 0 (etc.)

Also the cursor up/down can be used to enter alphanumeric information.

When finished, press the **OK** button to confirm the entry.

Move to the left panel.

Button	Default RC_CURSOR_UP/RC_CURSOR_DOWN Alphanumeric Entry Order
RC_CURSOR_UP	a b c d ...A B C D ...1 2 3 ...0 <space> _ - . @
RC_CURSOR_DOWN	@ . - _ <space> 0 9 8 7 ... Z Y X ... z y x ... c b a

Buttons on the right of the TV

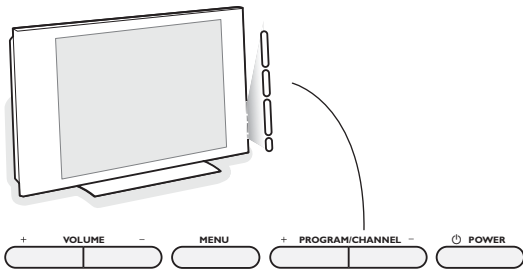

Should your remote be lost or broken you can still change some of the basic settings with the buttons on the right side of your TV. Press the power switch  to switch the TV on.

Press:

- the **+ VOLUME -** button to adjust the volume;
- the **+ PROGRAM/CHANNEL -** buttons to select the TV channels or sources.

The **MENU** button can be used to summon the Settings menu without the remote control.

Use:

- the **+ VOLUME -** buttons and the **+ PROGRAM/CHANNEL -** buttons to select menu items in the directions as shown;
- the **MENU** button to confirm your selection.

Note:

When activated via the **MENU** button on the right side of the TV, only **Exit** lets you dismiss the menu.

Navigate to **Exit** and press the **MENU** button.

My Content



The My Content menu (and the underlying Multimedia browser) is intended to contain all content, services, applications you are interested to consume.

- 1 Press the  button to activate.
- 2 Press the cursor up/down to move the highlight up and down in the list of menu items.
- 3 Press the cursor right to go deeper into the structure.

• Television:

TV channels leading to the list of TV channels; the left panel will contain the analog channel numbers, the one-part channel numbers and the major channel numbers in case of two-part digital channels. The right panel will contain the available subchannels associated with the major channel that is currently highlighted on the left panel. If there are no subchannels associated with the currently selected channel in the left panel, the right panel will remain empty.

• Multimedia

Contains the locally connected devices on which content (pictures, audio files) is stored. See Multimedia browser, p. 26.

To use the menus

Introduction

A lot of guiding instructions, help texts and messages will be displayed on your TV when using the menus or when trying to execute an action.

Please, follow the instructions and read the help text which are being displayed on the specific item highlighted.

The color buttons refer to different actions which may be executed depending on the activated device. Press the corresponding color button on the remote control to perform the required action.

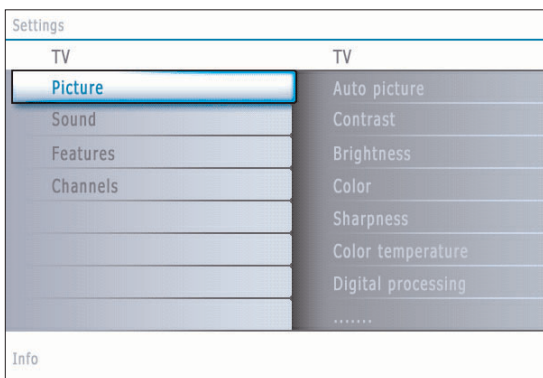
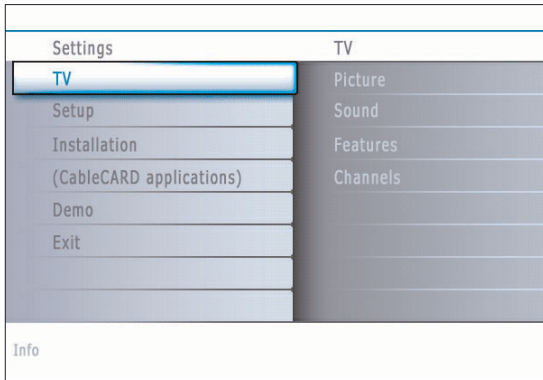

How to navigate through the Settings menus

The Settings menu allows you to access and change settings and preferences.

- Press the **MENU** button on the remote control to summon the Settings menu.
- On the left panel the highlight can be set on a menu item with the cursor up/down. The right panel shows the content of the highlighted menu item in the left panel.

Note: Sometimes not all the menu items are visible on the screen. Use the cursor down to reveal all items.

- Use the cursor right to enter the right panel.

The content of the right panel is moved to the left panel and the right panel shows the content of the newly highlighted item in the left panel.

Note: In some cases it is important that the picture can be watched while adjusting the settings. This means that when the highlight is on the right side panel, the other menu items hide away. When the cursor left is pressed again, the hidden menu items re-appear and the highlight moves to the left panel.

- Press the cursor left to go one menu level up again.
- Press the **OK** button on the highlighted item to activate and to dismiss the menu.

- Press the **MENU** button again to exit the Settings menu.

Note: The menu is also dismissed by pressing one of the color buttons (if present) referring to certain actions which may be executed.

Demo

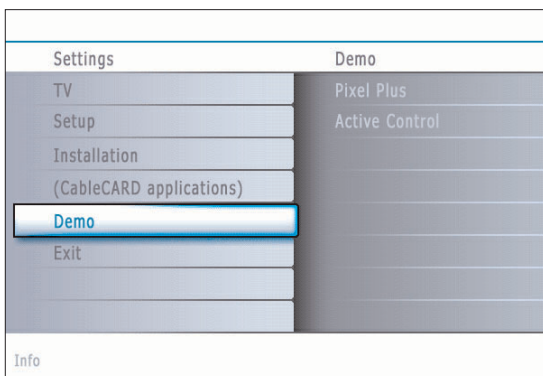

The **Demo** menu allows the user to get an idea of the features that are part of the television.

- 1 Select **Demo** in the Settings menu and press the cursor right.
- 2 Highlight a desired demo with the cursor up/down.
- 3 Press **OK** to start playing the highlighted demo. Press the green color button to automatically run all demos in sequence. Press the red color button to stop the auto run function. Press the red color button again to exit the demo and to return to TV mode.

Note: The selected demo is played once.

The demos require no user interaction except for starting the demo.

Installation

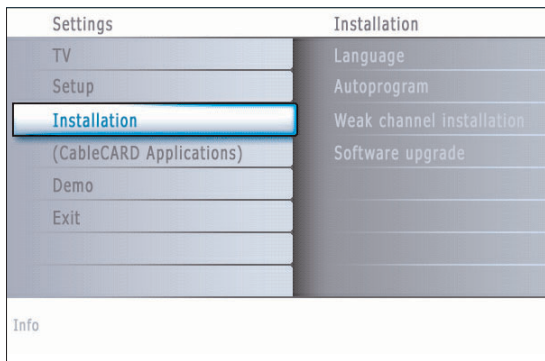

Select the menu language

- ❶ Press the **MENU** button on the remote control.
- ❷ Use the cursor down to select **Installation** in the Settings menu.
- ❸ Use the cursor right to enter the Installation menu.
- ❹ Select **Language** and enter the list of available languages with the cursor right.
- ❺ Select your language with the cursor up/down and press the **OK** button to confirm your selection.
- ❻ Proceed with the Installation menu.

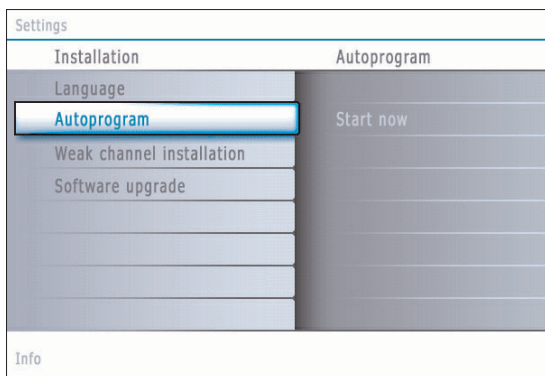

Store TV channels

- ❶ Select **Autoprogram** in the Installation menu.
- ❷ Use the cursor right to enter the Autoprogram menu.
- ❸ Press the **OK** button.
- ❹ Select **Cable** or **Antenna** in the Installation mode.

When **Antenna** is selected, the TV will detect antenna signals and will search for antenna TV (NTSC and ATSC) channels available in your local area.

When **Cable** is selected, the TV will detect cable company supplied signals and will search for cable TV (NTSC, ATSC, QAM modulated) channels available in your area.

Make sure that registration with your cable TV provider and connection of equipment are completed.

- ❺ Press the green button "**Next**" on the remote control.
Note: All channels must be unlocked in order to autoprogram. If requested, enter your PIN code to unlock all channels. See Menu preferences in the Settings, TV menu, p. 15.
- ❻ Press the green button "**Start**" to start autoprogramming. The menu screen disappears and the progress of autoprogramming is displayed. The progress bar indicates the number of analog and digital TV channels found. (Also digital channels via CableCARD are being programmed. First refer to the CableCARD settings, see p. 18).

When Autoprogramming is complete, a message appears confirming the completion and the TV switches to the first installed TV channel.

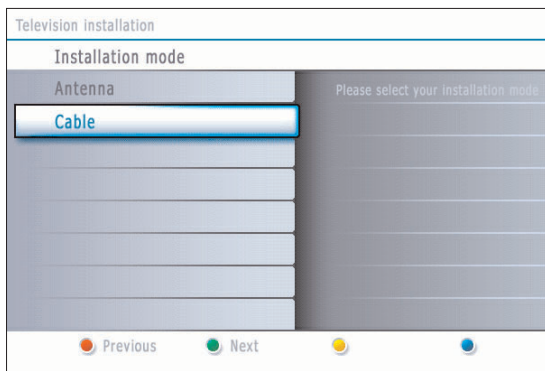

Notes:

- When you have locked TV channels while initiating autoprogram, a message appears asking to enter your PIN code in order to complete autoprogramming.
- ATSC channel information is updated automatically when the TV is in standby (after 3 minutes and every 3 hours thereafter).
- When interrupted, the updated channel information is retained as well as the not yet updated old channel information.
- Background autoprogramming occurs only when the TV is turned on.
- Channel information of an ATSC channel is updated only for the ATSC channel currently tuned.
- If an NTSC channel is tuned, then in Background Autoprogramming the TV shall scan all the possible ATSC frequencies and update information.
- Weak channel installation
This allows you to manually tune weak ATSC channels in order to adjust the antenna and thus optimize signal quality for that channel. (See Installation menu, Weak channel installation, p. 11.)
- Once you have searched for as well the available Antenna as well as the Cable TV channels, they are stored in the memory.

Channel tuning

Available channels:

- Cable (analog NTSC or digital QAM): max. from 1 to 135
- Terrestrial (analog NTSC or digital ATSC): max. from 2 to 69

If a tuned channel is not yet in the master channel map, the TV will attempt to tune the channel and it will be added to the map.

If the channel is not acquired, a message will appear that the channel is not available.

When you tune an audio-only digital subchannel, a display appears with the message **Audio only**.

Note: Digital Channel selection delay

Due to the tuning complexity of subchannel digital programming, the time to select and view a digital channel may take slightly longer than what the viewer is normally accustomed to (as compared to analog channel programs).

Digital channel broadcasts contain program and system data information that must be processed before the channel selection can be displayed.

Note: Subchannel selections

The new standards employed with digital broadcasting make it possible to receive multiple program channels under a single major channel number which can be selected by pressing the digit remote control direct-access channel number entry.

Important:

After the installation of the TV channels has been done, always make a selection in the Installation menu between Antenna or Cable whether you want to watch Antenna TV channels or Cable TV channels.

If you make use of a signal splitter do not forget to put the switch in the corresponding position.

Weak channel installation

This enables you to do a weak ATSC digital channel installation. This is only available for TV channels installed via an antenna connection (see p. 4).

- 1 Select a channel in the displayed list of TV channels (in the antenna mode).
- 2 The signal strength is displayed and updated continuously as you rotate the antenna.

Software upgrade

This menu allows you to upgrade your TV software using a USB device.

USB upgrade

It is possible to initiate an upgrade procedure from a USB portable memory. The memory device must be filled with the appropriate upgrade image (and structure) which can be found on the www.philips.com/support website.

How to upload a new software version on your portable memory device, see Annex 1, p. 37.

Settings	Installation
TV	Language
Setup	Autoprogram
Installation	Weak channel installation
(CableCARD applications)	Software upgrade
Demo	
Exit	
Info	

Setup menu

Settings	Setup
TV	Preferences
Setup	Source
Installation	Clock
(CableCARD applications)	
Demo	
Exit	
Info	

Settings	Setup	Preferences
	Preferences	Picture/sound preferences
	Source	Features preferences
	Clock	Menu preferences
		Reset AV settings
Info		

Settings/Setup	Preferences	Picture/sound preferences
	Picture/sound preferences	PIP format
	Features preferences	Auto surround
	Menu preferences	
	Reset AV settings	
Info		

Notes: PIP format:
PC formats via HDMI will always be displayed full screen.

This menu is used to control the settings of special TV functions, features and accessory devices.

The **Preferences** menu allows you to change settings that will typically be accessed only occasionally.

The **Source** menu allows you to select a source.

The **Clock** menu allows you to use your TV as a clock. This setup is necessary for the correct working of the Lock after feature.

Preferences

- 1 Press the **MENU** button.
- 2 Select **Setup** with the cursor down and press the cursor right to select the **Preferences** menu.
- 3 Press the cursor right again to select **Picture/sound preferences**.
- 4 Press the cursor right once more to enter the Picture/sound preferences menu.

Picture/sound preferences

PIP format

This menu allows you to select the preferred format (PIP or Dual screen) which can then be displayed toggling the **PIP** button on the remote control **On** or **Off**.

- 1 Select **PIP format**.
- 2 Press the cursor right.
- 3 Select **PIP** or **Dual screen** with the cursor up/down.
 - **PIP** is selected, the TV shows a full screen of video with a pip window of video on top of it.
 - **Dual screen** is selected, the TV splits the screen into two equally sized screens.
- 4 Press the cursor left/right to highlight the PIP window or the left/right screen in Dual screen.
- 5 Press the **-CH/PAGE+** button to change the broadcast channel or the **AV+** button to change the HDMI source in the highlighted screen.

Note: Audio only plays from the main, when PIP has been selected, or the left screen, when Dual screen has been selected.

Define the position of the PIP screen

- 1 Press the cursor right to highlight the PIP screen.
- 2 Press the red color button on the remote control to select **Position**.
 - Note: If no action has been undertaken, the function buttons at the bottom of the screen will disappear after a few seconds.
- 3 Use the cursor keys to define the position of the PIP screen.

Auto surround

Sometimes the broadcaster transmits special signals for Surround sound encoded programs. The TV automatically switches to the best surround sound mode when **Auto surround** is switched **On**.

Settings/Setup	
Preferences	Features preferences
Picture/sound preferences	Caption service
Features preferences	Digital caption service
Menu preferences	Digital caption options
Reset AV settings	
Info	

Note: The captions do not always use correct spelling and grammar. Not all TV programs and product commercials are made for broadcast with Closed Caption informations included. Refer to your area's TV program listings for the TV channels and times of Closed Caption shows. The captioned programs are usually noted in the TV listings with service marks such as 'CC'.

Features preferences

Caption service

This allows you to select the Closed Captions service levels of analog broadcasting to be displayed.

Closed Captioning allows you to read the voice content of television programs on the TV screen. Designed to help the hearing impaired, this feature uses on-screen 'text boxes' to show dialogue and conversations while the TV program is in progress. Captions will appear on the screen during captioned broadcasts.

- ❶ Select **Captions service**.
- ❷ Press the cursor right.
- ❸ Select the desired Caption service:
 - **CC 1, 2, 3 or 4**
Dialogue (and descriptions) for the action on the captioned TV program shows on screen. Usually **CC 1** is the most used. **CC 2** may be used for alternate languages if they are being transmitted.
 - **T 1, 2, 3 or 4**
Often used for channel guide, schedules, bulletin board information for Closed Captions programs, news, weather informations or stock market reports.
Not all Caption services are necessarily being used by a TV channel during the transmission of a Closed Caption program.
- ❹ See Closed Caption in the TV, Features menu, see p. 22, to turn the Caption service On or Off.

Note: This television provides display of television closed captioning conforming with the EIA-608 standard and in accordance with Sections 15.119 of the FCC rules.

Digital caption service

This allows you to configure the way you choose to view the digital captioning.

Select one of the digital service channels made available by the caption provider.

There are 6 standard services. Service 1 is designated as the Primary Caption Service. This service contains the verbatim, or near-verbatim captions for the primary language being spoken in the accompanying program audio.

Service 2 is designated as the Secondary Language Service. This service contains captions in a secondary language which are translations of the captions in the primary Caption Service. The other service subchannels are not pre-assigned. It is up to the discretion of the individual caption provider to utilize the remaining service channels.

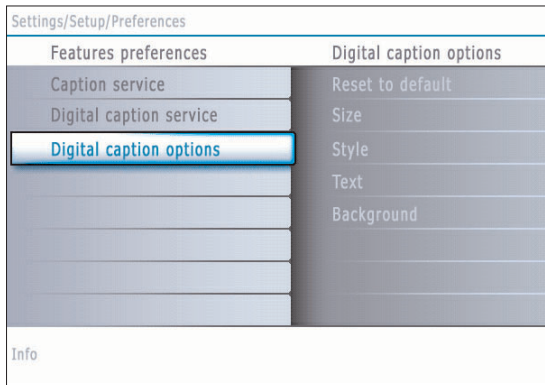

Digital caption options

This allows you to modify how digital captions are displayed on your TV. Select from the following options to change the visual characteristics of your TV's digital captioning.

- **Reset to default**
Select this option to reset the digital caption options back to the captions provider default settings.
Press the **OK** button to confirm.
- **Size**
Select this option to select the size of caption display according to your own preference.
Select **Default (Automatic)**, **Small**, **Standard** or **Large** and press the **OK** button to confirm.
- **Style**
Select this option to select the font style of caption display according to your own preference.
Select **Default**, **Monospaced serif**, **Serif**, **Monospaced sans serif**, **Sans serif**, **Casual**, **Cursive** or **Small caps...**
- **Text**
Select this option to select the text color or the opacity of the text box of caption display according to your own preference.
Select a color and one of the opacity options.
- **Background**
Select this option to select the character background color or one of the background opacity options of caption display according to your own preference.
Select a color and one of the opacity options.

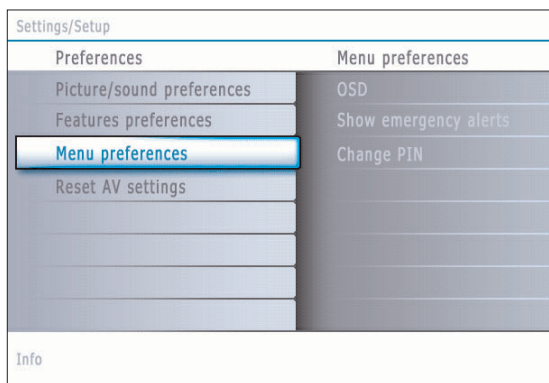

Note: Emergency Alert Signalling is not possible:
 - when content browsing;
 - with analogue video sources.

Notes:
 - You always have the possibility to remove the message from the screen.
 - The message display will overlap whatever menu element or other message is on the screen.

Important: you have forgotten your PIN!

- 1 Select **Change PIN** in the Menu preferences menu and press the cursor right.
- 2 Press the cursor right to enter the overriding PIN code **0-7-1-1**.
- 3 Press the cursor again and enter a new personal 4-digit PIN code. The previous code is erased and the new PIN-code is stored.

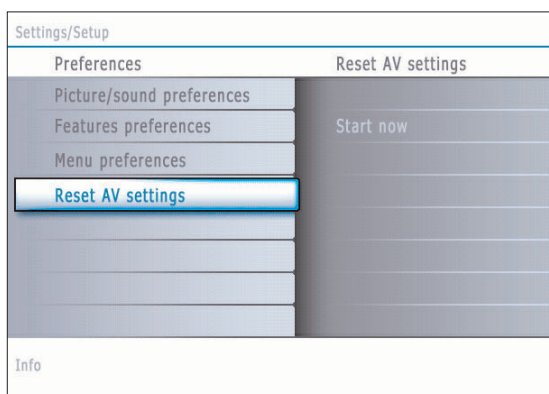

Menu preferences

OSD

- 1 Select **OSD**.
- 2 Press the cursor right to select **Normal** or **Minimum**.
Normal to activate the continuous display of the channel number (for max. 10 minutes) and extended display of TV channel and program information on screen. E.g. information on the main or auxiliary program, input signal quality of connected accessory devices, the display format, sound mode, availability of Closed Caption service, the audio language, the rating, sleptimer setup.
Minimum to activate the display of reduced channel information.
 Note: When Closed Captions is switched on, continuous display of the channel number and clock is not possible.

Show emergency alerts (EAS)

This allows you to select the alert priority level of the information disseminated by the cable operator. The standard SCTE18 defines an Emergency Alert signalling method for use by cable TV systems to signal emergencies to digital devices such as digital set-top boxes, digital TVs and digital VCRs.

The Emergency alert signalling scheme defined in the standard allows a cable operator to disseminate emergency alert information related to state and local-level emergencies and warnings in a cost-effective and efficient way, while minimizing disruption of programming.

An Emergency alert message will have one of the following priorities: **Low, Medium, High** or **Maximum**.

The Emergency alert message with priority **High** or **Maximum** will always be presented. **Low** or **Medium** will be present or ignored depending on the selected setting.

Important: When the TV clock is undefined (See Setup menu, Clock, p. 18), the Emergency Alerts will be ignored.

The Emergency Alert message display will contain following information:

- The Emergency Alert text
- The start time + date
- The end time + date.

- 1 Select **Show Emergency Alerts** in the Menu preferences menu.
- 2 Press the cursor right and select one of the Emergency alerts options:
 - Always, when you always want the Emergency alert messages to be displayed when available;
 - Skip low priority, when you want the messages with low level to be ignored;
 - Skip low/medium priority, when you only want the messages with high priority to be displayed.

Set/Change PIN

- 1 Select **Set** or **Change PIN** with the cursor down.
- 2 If no PIN-code exists yet, the menu item is set to **Set PIN**. Follow the instructions on screen.
 If a PIN-code has previously been entered, the menu item is set to **Change PIN**. Follow the instructions on screen.
 All number combinations from 0000 tot 9999 are valid numbers.
- 3 The **Menu preferences menu** reappears with a message confirming that the PIN has been created.

Reset AV settings

This function allows you to reset most of the picture and sound settings to their predefined factory states.

- 1 Select **Reset AV settings** with the cursor down.
- 2 Press the cursor right.
- 3 Press the **OK** button to erase settings and reset them to their default values.



Source

This menu allows you to identify the accessory devices you have connected to the external inputs/outputs.

- ❶ Select **Source** in the Setup menu.
- ❷ Press the cursor right to enter the list of types of devices connected to the selected input.
- ❸ Select the accessory device with the cursor up/down.

When you select **AV1**, **AV2**, **AV3**, **HDMI1**, **HDMI2**, **Side** or **Digital Audio In**, a list appears allowing you to identify which type of accessory device is attached to this input. The TV detects the presence of the connected device and the signal is routed appropriately.

Once you have selected the source type, e.g. DVD, this source will automatically be selected when your remote control is in DVD mode, see p. 6, and when you press the **AV+** button on the remote control.

Digital Audio

Select **Digital Audio In** when the TV expects digital audio for a connected device to come from a Digital audio input.

Make your selection of the source to which the device with digital audio input has been connected.

In addition to accepting audio input via Digital Audio In, the TV can output Digital audio via the **DIGITAL AUDIO OUT** connector to an external amplifier or receiver.

If your amplifier or receiver has a matching connector for Digital Audio In, you can connect it with a single cable to the TV's **DIGITAL AUDIO OUT**. See Connect Accessory Devices, Digital Surround Receiver, p. 30.

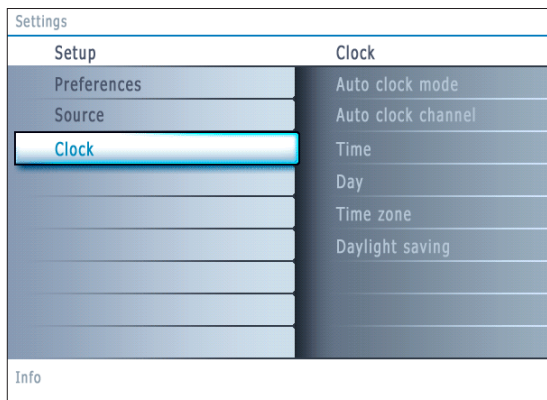

Most of the TV channels are not transmitting clock information. There are few cable channels but they are at the end of the channel ring. There is no clock transmission in antenna channels. In such cases either clock extraction is taking a long time or there is no clock.

Clock

This allows you to use your TV as a clock.

Note: Adjusting the clock is necessary for the correct working of Lock after (See TV settings, Channels, p. 23) features.

Auto clock mode

- ❶ Select **Clock** in the Setup menu.
- ❷ Press the cursor right to select the **Auto clock mode**.
- ❸ Press the cursor right to instruct the TV to get the time automatically or manually.

Auto clock channel *(only available when Auto clock mode is set to Automatic)*

With the cursor buttons, select the channel number where time can be found by the TV. Typically time can be found on PBS as well as some other channels.

Note: If Manual has been selected in the Auto clock mode, the Auto clock channel menu item can not be selected.

Time - Day *(only available when Auto clock mode is set to Manual)*

With the cursor buttons, select and enter the correct time and day.

If **Auto clock mode Manual** has been selected, and no clock search has been done, the system will keep the entered time and day.

Time zone *(only available when Auto clock mode is set to Automatic)*

This function allows you to select your local time zone. Broadcasted time information will correct the clock display for your local time.

- ❶ Select **Time zone** with the cursor down.
- ❷ Press the cursor right to select your local time zone.

Daylight saving *(only available when Auto clock mode is set to Automatic)*

Daylight saving time is automatically set by specially broadcasted signals.

This menu item allows you to disable the automatic setting of daylight saving time. This is useful if you live in an area or state where daylight saving is not applied, but you receive channels from other areas where daylight saving signals are broadcasted.

- ❶ Select **Daylight saving** with the cursor down.
- ❷ Press the cursor right to select **Automatic** for automatic clock correction for daylight saving time, based on specially broadcasted signals.
- ❸ Select **Off** to disable automatic clock correction based on the specially broadcasted signals.

CableCARD applications

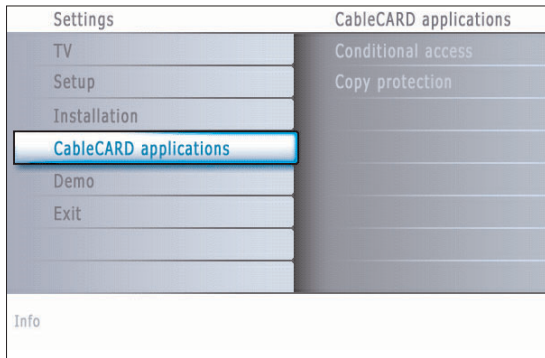

Inserting your CableCARD

- 1 Gently push the card, the bottom side facing the front of your TV, into the slot with one hand.
- 2 Push the card with your two thumbs until it locks into place.

Removing your CableCARD

- 1 Turn off the TV.
- 2 Pull the CableCARD straight out of the slot with both hands.

A CableCARD is a removable card distributed by cable companies, that is inserted into the CableCARD slot at the bottom of your television. See CableCARD, p. 2.

It enables you to decode digitally encrypted, or scrambled content delivered from the cable system.

CableCARD functionality includes conditional access and copy protection.

To receive the features/applications offered by your cable company, you may have to subscribe to those services. Contact your cable company regarding availability of the CableCARD.

You may also be able to order call-ahead pay per view events.

Note: do not insert a PCMCIA card into the CableCARD interface slot.

- 1 Insert your CableCARD.
- 2 Select **CableCARD applications** in the Settings menu.
- 3 Press the cursor right to enter the list of available CableCARD applications offered by the cable provider.
- 4 A CableCARD application is initiated when you select an application item and when you press the **OK** button to activate it.
- 5 Follow the messages displayed on screen. The messages will remain on screen until the **OK** button or the corresponding color button is pressed.

Conditional access

When having selected **Conditional access**, the TV will display messages related to the conditional access functionality of CableCARD. They will indicate the status (possible or not) of descrambling of the selected program.

Copy protection

The displayed messages will be related to Copy control information.

Remark: When a CableCARD is inserted, the channel list might be different.

TV menu

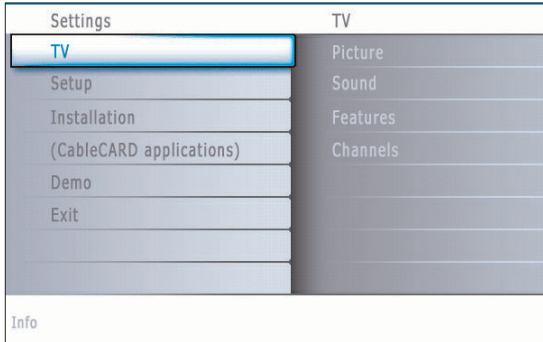

Press the **MENU** button on the remote control to summon the Settings menu. The TV menu gives you an overview of the menus you can select.

Note: Depending on the input signal, one or more menu items may not be selectable.

Picture menu

Note: Some menu items are not available in case of HD sources.

- 1 Press the cursor right to select **Picture**.
- 2 Press the cursor right again to enter the Picture menu.
- 3 Select the menu items with the cursor up/down.
- 4 Adjust the settings with the cursor left/right or enter the list of submenu items with the cursor right. Select a submenu item with the cursor up/down.

Auto picture

Select **Auto picture** to display a list of predefined picture settings, each corresponding with specific factory settings.

Personal refers to the personal preference settings of picture in the picture menu.

*Note: This Philips TV has been set at the factory to look best in bright store environments which typically use fluorescent lighting. As your home will likely not be as well lit as a store, we recommend that you cycle through the various auto picture modes to find the one that best suits your own viewing conditions. Most consumers will find that **Natural** is the correct choice.*

Contrast

This will adjust the intensity of bright parts in the picture but keep the dark parts unchanged.

Brightness

This will adjust the light output of the complete picture, which will mainly affect the darker areas of the picture.

Color

This will adjust the saturation level of the colors to suit your personal preference.

Sharpness

This will adjust the sharpness of fine details in the picture.

Color temperature

This will increase or decrease **Warm** (red) and **Cool** (blue) colors to suit personal preferences.

Select **Cool** to give the white colors a blue, **Normal** to give the white colors a neutral, **Warm** to give the white colors a red tint.

Digital processing

- **Standard** = line doubling eliminates the flicker.
 - **Pixel Plus** = for everyday viewing, Pixel Plus is the most ideal setting, as it fully processes the image to make every single pixel the best it can be, improving contrast, sharpness, picture depth, and color reproduction and brilliance from every source, including High Definition.
- Standard** mode is recommended only for very noisy or poorly mastered sources or for those who find the smoothness of Pixel Plus (which eliminates judder in the picture) unsettling.

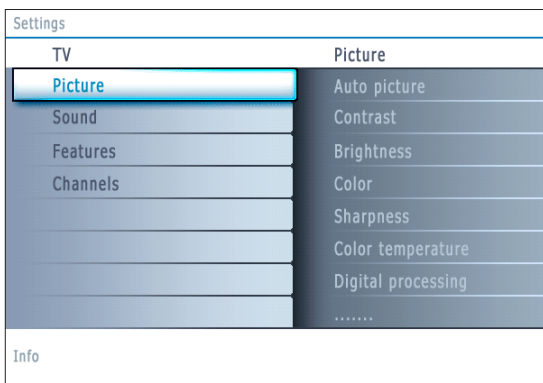

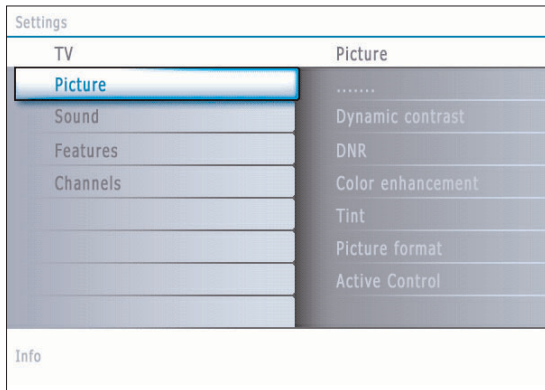

Dynamic contrast

Automatically makes the contrast in the darker and the brighter picture areas more noticeable as the image on the screen changes. Normally select **Medium**. It may be preferred to select **Minimum**, **Maximum** or **Off**.

- ❶ Press the cursor right to enter the list.
- ❷ Select one of the settings with the cursor up/down.
- ❸ Press the cursor left to return to the picture menu.

DNR (Digital Noise Reduction)

Automatically filters out and reduces the image noise and improves picture quality when receiving weak video signals.

- ❶ Press the cursor right to enter the list.
- ❷ Select **Off**, **Minimum**, **Medium** or **Maximum** according to the image noise.
- ❸ Press the cursor left to return to the picture menu.

Color enhancement

When activated, this feature automatically controls green enhancement and blue stretch. It makes the colors more vivid.

- ❶ Press the cursor right.
- ❷ Select **On** or **Off** in order to activate/de-activate Color enhancement with the cursor right.

Tint

Allows you to select the color mix (hue) of the picture.

Picture format

This menu item performs the same as the **FORMAT** button on the remote control. See Use of the remote control, p. 6.

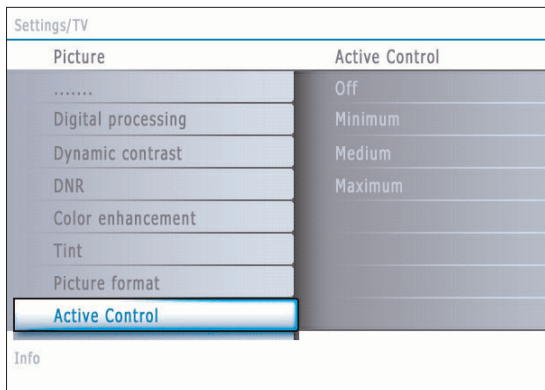

Active Control

The TV continuously measures and corrects all incoming signals in order to provide the best picture possible.

It also uses a sensor which monitors the ambient light conditions in the room and adjusts key picture settings for best viewing. When Active Control is set to **Maximum**, the brightness of the Ambient light shall be influenced by the light sensor.

- ❶ Select **Active Control**.
- ❷ Press the cursor right to enter the list of Active Control values.
- ❸ Press the cursor right repeatedly to select the Active Control values **Off**, **Minimum**, **Medium** or **Maximum**.
The picture settings are being optimized continuously. Those menu items can not be selected.
- ❹ Press the **OK** button or wait for the time out to dismiss the Active Control display.

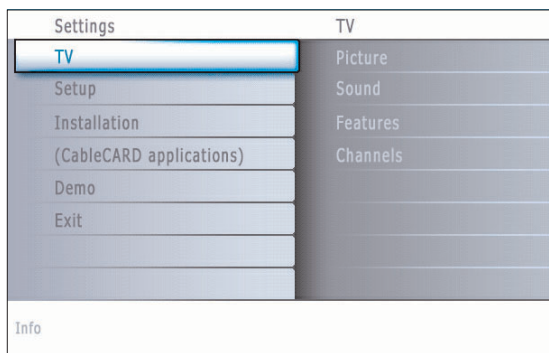

Sound menu

- ❶ Select **Sound** in the TV Settings menu.
- ❷ Press the cursor right to enter the sound menu.
- ❸ Select the menu items with the cursor up/down and adjust the settings with the cursor left/right.
Remember, control settings are at normal mid-range levels when the bar scale is entered.

Auto sound

Select **Auto sound** to display a list of predefined sound settings, each corresponding with specific factory settings of Treble and Bass.

- ❶ Press the cursor right to enter the list.
- ❷ Press the cursor up/down to select a predefined sound setting.
Personal refers to the personal preference settings of sound in the sound menu.

Note: The moment you are in a predefined Auto sound setting and you modify a setting in the Sound menu, all values of the menu will overwrite the previously made personal setting.

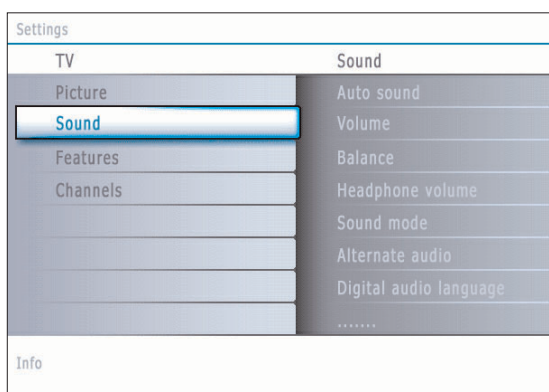

Volume

This will adjust the sound output level.

Balance

This will adjust the output of the right and left speakers to obtain the best stereo reproduction for your listening position.

Headphone volume

This controls the level of sound through the headphones.

Sound mode

This selects the modes for more spatial or surround sound reproduction dependent on the broadcast signals or signals from external inputs received.

Alternate audio *(only selectable with analog broadcast signals)*

This gives you the possibility to swap between the Main and Second audio Program (SAP) when it is available.

Digital Audio language *(only selectable with digital broadcast signals)*

This allows you to select your language preference in case of multilingual audio track programs if available with digital broadcast signal.

Note: The default language for the digital channels is the installed menu language.

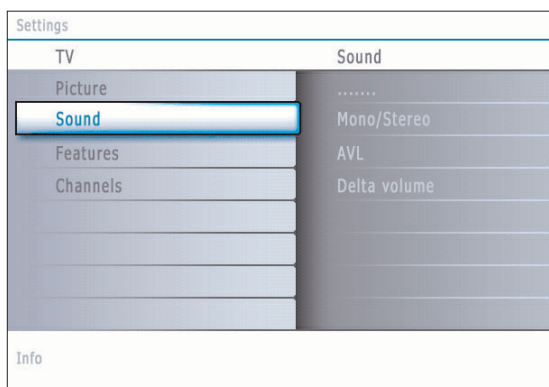

Mono/Stereo

This selects, per TV channel, Mono or Stereo sound when analog stereo broadcasts are available.

AVL (Automatic Volume Leveler) *(only available with analog broadcast and non-Digital signals)*

This automatically reduces the volume differences between channels and programs, providing a more constant overall level. This will also reduce the dynamics of sound.

Delta volume

This allows you to correct for any permanent volume differences between TV channels or external sources.



Manufactured under license from Dolby Laboratories.
'Dolby' 'Pro Logic' and the double-D symbol are trademarks of Dolby Laboratories.

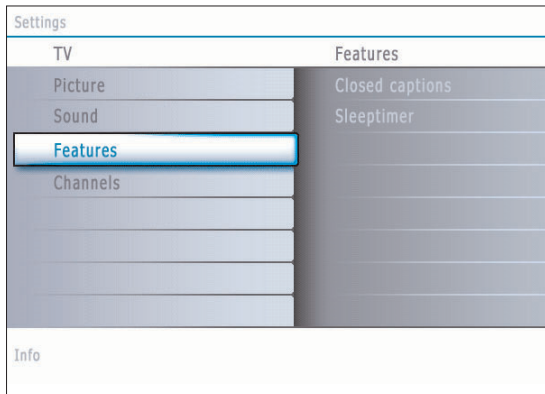

Features menu

- 1 Select **Features** in the TV Settings menu.
- 2 Press the cursor right to enter the features menu.
- 3 Select the menu items with the cursor up/down and adjust the settings with the cursor left/right.

Closed captions

This displays the transmitted CC- or CS-text on the screen according to your chosen CC or CS service in the Setup, Features preferences menu, p. 14. This text can either be permanently displayed (assuming that the service is available in the broadcast) or only when mute is active.

- 1 Press the cursor right after having selected **Closed captions**.
- 2 Select **On**, **Off** or **On during mute**.

Sleeptimer

This sets a time period after which the TV automatically turns to standby.

- 1 Select **Sleeptimer**.
- 2 Press the cursor right.
- 3 Select a value with the cursor up/down. The list will have values from **Off** to **180 minutes**.
When **Off** is selected, the sleeptimer is turned off.
You can always turn off your TV earlier or select another time set.

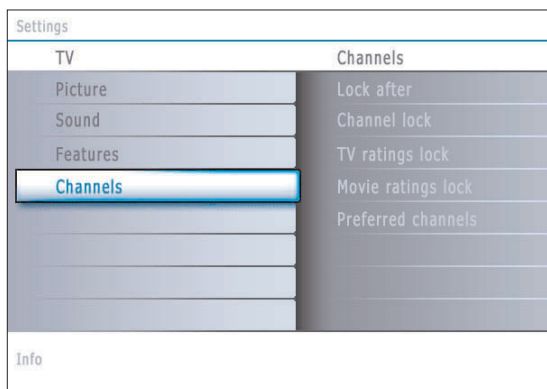

Channels menu

This menu can control special functions for the TV channels.

- ❶ Select **Channels** in the TV settings menu with the cursor up/down.
- ❷ Press the cursor right to enter the channels menu.
- ❸ Press the cursor up/down to select a channels menu item.

Lock after

Note: Lock after is only selectable if time and date are known. See Setup, Clock menu, p. 17.

This allows you to prevent the viewing of the channels after a selectable time delay. Locked channels can still be tuned, but the picture is blanked and the audio is muted.

- ❶ Press the cursor right and select **Timer On** or **Off**. When set to **On** this allows you to set the clock. When having selected **Timer On**, you will be summoned to enter your PIN (See Set/Change PIN, p. 15). Follow the instructions on screen.
- ❷ Select **Time** and press the cursor right. This allows you to set the time after which the lock is set.
- ❸ Select **AM** or **PM** to select the correct period of the day.
- ❹ Enter the time with the digit or the cursor buttons and press **OK** to confirm.

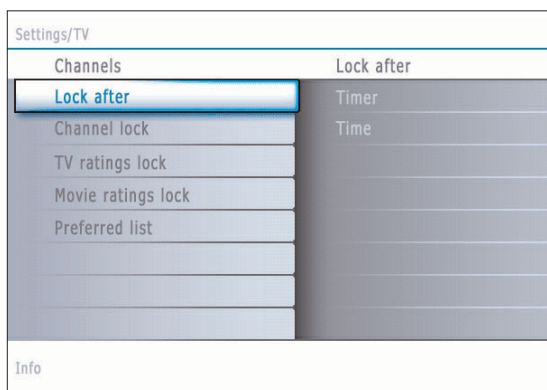

Channel lock

This allows you to completely lock a certain TV channel or external source. Select the channels or subchannels you want to lock and press **OK** to confirm.

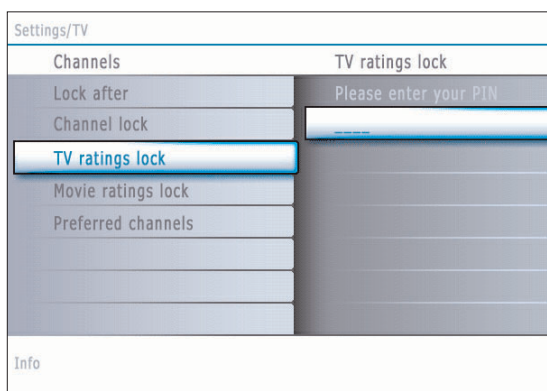

TV ratings lock

Your TV is equipped with a V-chip. This allows you to control access to individual programs based on their movie and TV ratings. All settings apply to all AV inputs, except HDMI. The program content advisory data are sent by the broadcaster or program provider.

- ❶ Select **TV ratings lock** with the cursor down. A list appears, showing the age-based TV ratings and a corresponding content-based ratings list.
- ❷ Press the cursor right to enter the list.
- ❸ Select an age-based TV rating with the cursor up/down, and enter, if present, the list with content-based ratings with the cursor right, and select one content-based rating.
- ❹ Press **OK** to activate/de-activate the selected rating. You are asked to enter your PIN-code (see Set/Change PIN, p. 15). If the code is correct, the TV ratings lock menu reappears.
- ❺ Select another content-based rating if you like and press **OK** again.

You need only enter your PIN-code once while the menu is active.

You can lock/unlock any number of ratings on the list without re-entering your code.

Each ratings item has a box-graphic in front of it to indicate whether or not programs carrying that rating are currently locked:

- a yellow-colored box: all items in the contents-based list are locked as well;
- a blue-colored box: the item is unselected;
- a half blue, half yellow-colored box: some content-based ratings are selected/unselected.

When **All** has been selected, all items in the age-based and in the contents-based lists are locked.

If, while **All** is selected, any other item, either an age-based or content-based item, is unselected, then All is automatically unselected.

None is the selection for items that either have no rating information or have a rating of None. Both will be locked.

When an item on the age-based list is selected, all items below that item of the same group are locked as well.

When you select a content-based rating, all identical content-based ratings in the younger age-based categories are also selected.

Age-based Rating	Content-based Rating
All	none
None	none
TV-Y	none
TV-Y7	(FV) Fantasy Violence
TV-G	none
TV-PG	(D) Dialog (L) Language (S) Sex (V) Violence
TV-14	(D) Dialog (L) Language (S) Sex (V) Violence
TV-MA	(L) Language (S) Sex (V) Violence

- TV-Y** appropriate for children of all ages with themes and elements suitable for children aged 2-6
- TV-Y7** programs designed for children age 7 and older
- TV-Y7-FV** programs include fantasy violence more intense than other programs in the TV-Y7 category
- TV-G** programs suitable for all ages. These programs contain little or no violence, no strong language and little or no sexual dialogue or situations
- TV-PG** programs contain elements that some parents may find unsuitable for younger children and which may need parental guidance. The program may contain moderate violence, sexual dialogue and/or situations and some strong language.
- TV-14** programs contain elements that may not be suitable for children under 14 years of age. These programs include one or more of the following: intense violence, intense sexual situations, suggestive dialogue and strong language.
- TV-MA** programs are designed to be viewed by adults and may be unsuitable for children under the age of 17. These programs may contain graphic violence, explicit sexual activity and/or crude or indecent language.

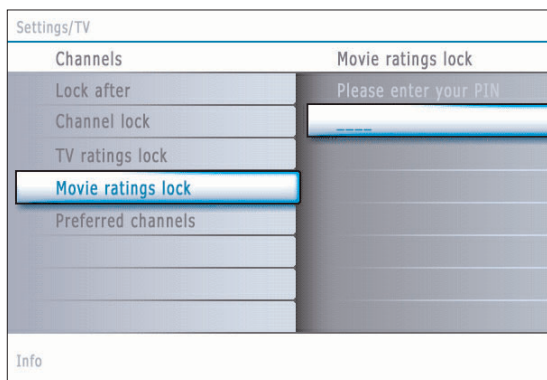

Movie Ratings Lock

This function allows you to control access to individual movies based on their MPAA ratings (Motion Picture Association of America).

- ❶ Select **Movie ratings lock** with the cursor down. A list appears, showing all valid MPAA content ratings.
- ❷ Press the cursor right to enter the list. You are asked to enter your code. (See Set/Change PIN, p. 15.) If the code is correct, the Movie ratings lock menu reappears.
- ❸ Select a movie rating with the cursor up/down.
- ❹ Press **OK** to activate/de-activate the selected rating.

Each rating item has a box-graphic in front of it to indicate whether or not programs carrying that rating are currently locked:

- a yellow-colored box: movies with this rating are locked;
- a blue-colored box: movies with this rating are unlocked.

When **All** has been selected, all items on the movie ratings list become selected. (All movies are locked.)

If, while **All** is selected, any other item is unselected, then **All** is automatically unselected.

When **NR** has been selected, no other item is selected.

When any other item has been selected, all ratings below are selected as well, thus all movies with those ratings will be locked.

- NR** not rated
- G** movies with a mild content, suitable for all ages
- PG** movies for which parental guidance is recommended. They may contain a few racy or violent scenes or maybe some bad language
- PG-13** movies for which parental guidance may be recommended if under age 13
- R** restricted. The movies usually contain offensive sex or bad language and may be unsuitable for children under the age of 17. Parental guidance or permission needed.
- NC-17** even with parental permission, forbidden under age 17. More offensive sex, violence or bad language.
- X** movies which generally focus on sex, violence and/or bad language. Also known as pornography.

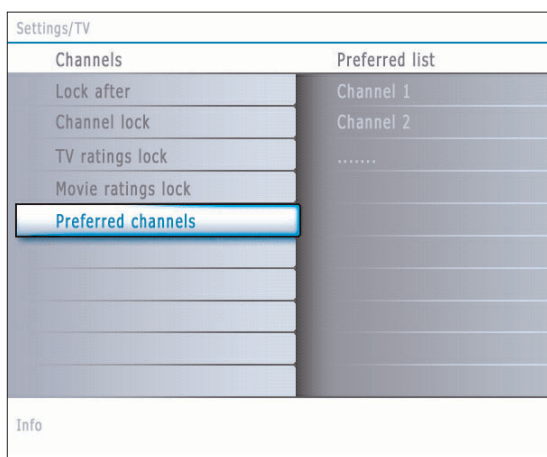

Preferred channels

A channel, when installed, is marked as preferred by default and added to the channel list. This feature provides the ability to remove a channel number from the channel list.

- ❶ Select **Preferred channels** with the cursor down.
- ❷ Press the cursor right to enter a list with all stored channel numbers.
- ❸ Select the channel you want to remove with the cursor down.
- ❹ Press **OK**.
- ❺ Repeat to remove other channels.

Multimedia browser



Multimedia browser lets you display pictures or play audio files stored on a USB device.

The Multimedia browser application is invoked from the My Content menu (press the  button) by selecting the USB device and pressing the cursor right.

Notes:

- Following file formats can be reproduced:
 - For pictures: JPEG
 - For audio: MP3, MP3 Pro
- Only FAT/DOS-formatted memory devices are supported.
- If your digital camera is not supported, make sure your camera is switched on and verify if its configuration settings are correct (see the manual of your camera).
- Philips cannot be responsible if your USB device is not supported.

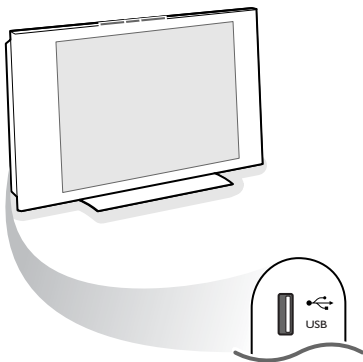

Viewing content from a USB device

Inserting a USB device

Note: USB devices are not supplied with this TV.

Insert a USB device in the **USB** connector at the left side of the TV.

When a USB device is inserted, the Multimedia browser menu is displayed automatically, see further.

If your USB device does not fit into the USB connector at the side, use an USB extend cable to connect the USB device to the USB port. Ask your dealer.

Removing the USB device

- 1 First switch off the My Content menu. To do so, navigate to the Multimedia browser menu and press the  button to exit the menu.
- 2 Remove the USB device.

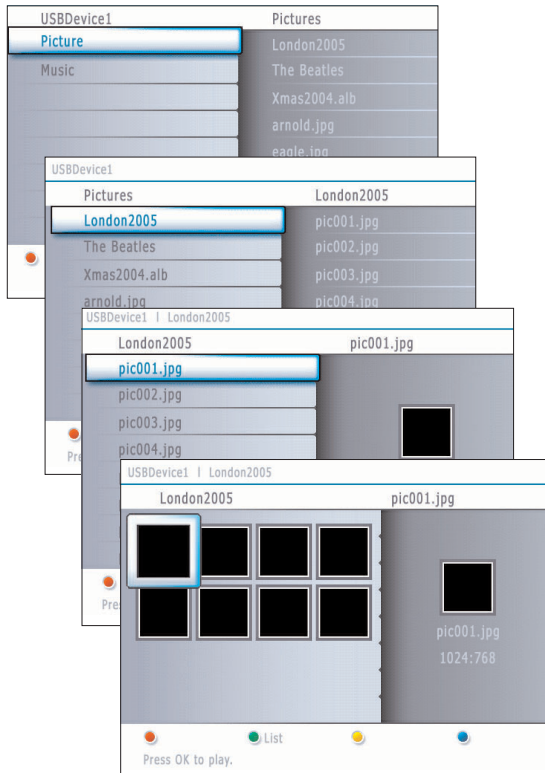





Multimedia Browser menu

- 1 Insert a USB device.
- 2 Select the USB device under Multimedia with the cursor up/down. The Multimedia browser will allow the user to browse content stored on the inserted USB device. Press the cursor right.
- 3 The 2-panel browser will be shown with the left panel containing the content types (Music, Picture). The right panel will display the content that is available of the selected content type.
- 4 Press the cursor up/down to select a content type and press the cursor right to enter the content.
- 5 Press the cursor up/down to select a file or a directory.
Note: Press the green color button to display all the image files in the current directory as thumbnails when browsing pictures. Press the green button again to display the image files in a list.
- 6 In case a file is selected, press the **OK** button to display a picture file or to play an audio file. In case a directory, album or playlist is selected, press the cursor right to enter the content or press the **OK** button to start a slide show or a playback of the files present in the directory, album or playlist.
- 7 Press the cursor left to keep music playing and switch back to the Multimedia menu.
- 8 Press one of the color buttons on the remote control to perform the corresponding function mentioned at the bottom of the screen. The blue color button can be used to let the color re-appear.
- 9 To stop playing content, press the **■** button on the remote control.

Notes:

- **Your TV supports slide shows with background music.** See Annex 2, p. 39.
- The playback will continue to play even if temporarily switched to browser screens. The audio will be stopped when another song starts playing, or when the end has been reached.
- Progressive JPEG files are not supported.
- The length of the files should not exceed 128 characters.
- Do not use a dot "." in folder naming.
- More technical remarks can be found in Annex 3, p. 41.

Following icons may appear:

-  folder
-  pictures
-  music
-  self made playlist/album

Function buttons at the bottom of the screen

- | | |
|-----------------------|---|
| Details | to display a description of the selected file or directory; |
| Transitions | to select if a transition during a slide show should be applied; |
| Slide time | to select the duration a picture will be displayed in a slide show; |
| Rotate | to rotate a picture; |
| Repeat one/all | to repeat the playback of a music file; |
| Shuffle | to shuffle music collections in a random way; |

Other function buttons on the remote control

- to stop displaying content;
- ||** to pause displaying content;
- ▶** to play a single file, start a slide show, playback of a folder or other collection.

Connect Accessory Devices

There is a wide range of audio and video devices that can be connected to your TV. The following connection diagrams show you how to connect them to the TV.

AV1 can handle YPbPr, S-VIDEO, RGB + HV or VIDEO and L/R Audio,

AV2 VIDEO or S-VIDEO and L/R Audio,

AV3 YPbPr and Digital Audio,

Side VIDEO or S-VIDEO and L/R Audio.

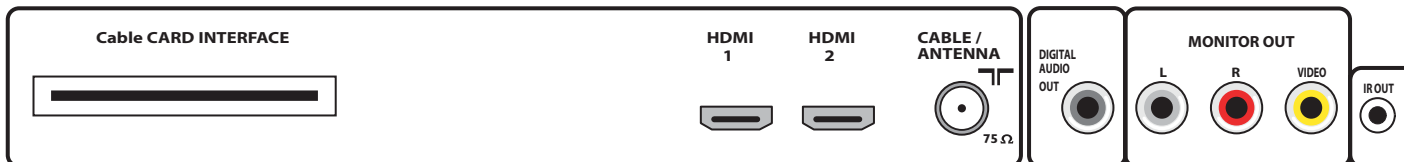
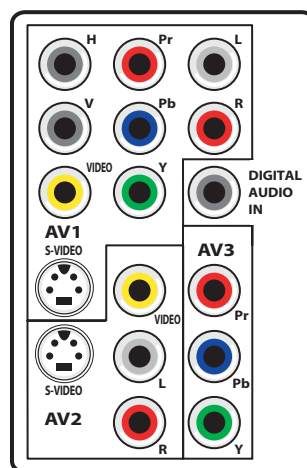
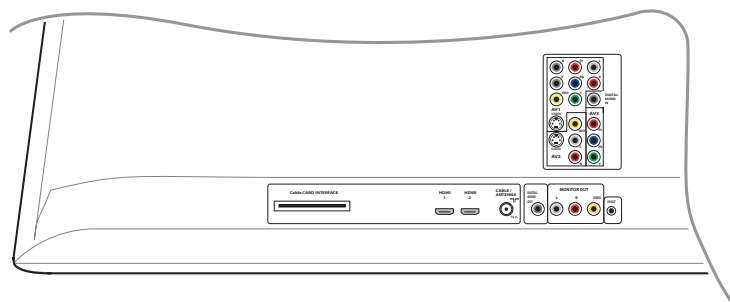

Recorder (vcr-dvd+rw)

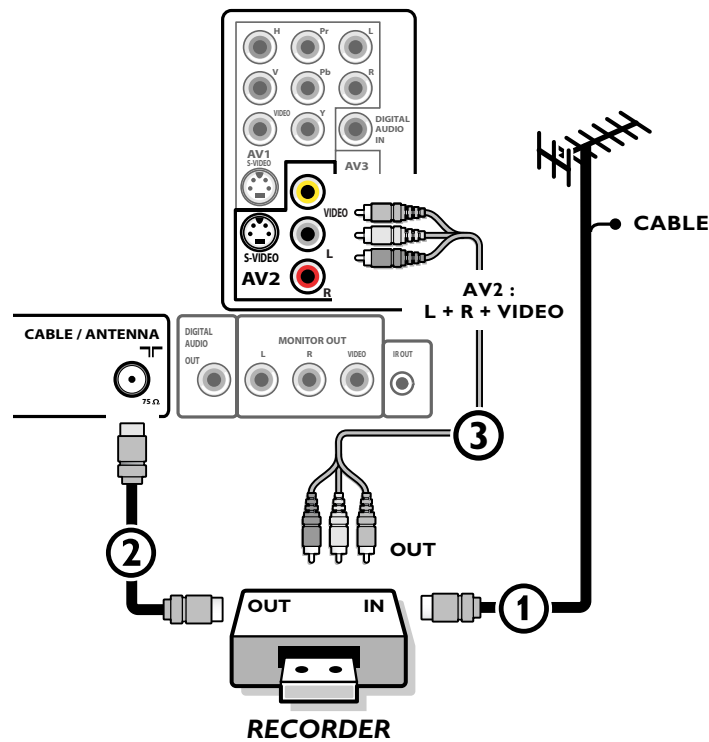

Note: Do not place your recorder too close to the screen as some recorders may be susceptible for signals from the display. Keep a minimum distance of 20" from the screen.

- 1 Connect the RF Antenna or Cable TV cable (eventually via an optional two-way signal splitter and/or Cable TV converter box) ① to the **RF IN** socket of your recorder.
- 2 Connect another RF cable ② from the output **OUT** of your recorder to the TV's **CABLE/ANTENNA 75 Ω** jack.
- 3 Better playback quality can be obtained if you also connect the Video, Audio Left and Right (only for stereo devices) AV cables ③ to the **VIDEO, AUDIO L** and **R** input jacks of **AV2**.

If your recorder has an S-VHS video jack:

For improved picture quality, connect an S-video cable with the **S-VIDEO** input instead of connecting the recorder to the **VIDEO** jack of **AV2**.

S-Video does not provide audio, so audio cables must still be connected to provide sound.

Recorder and other A/V devices

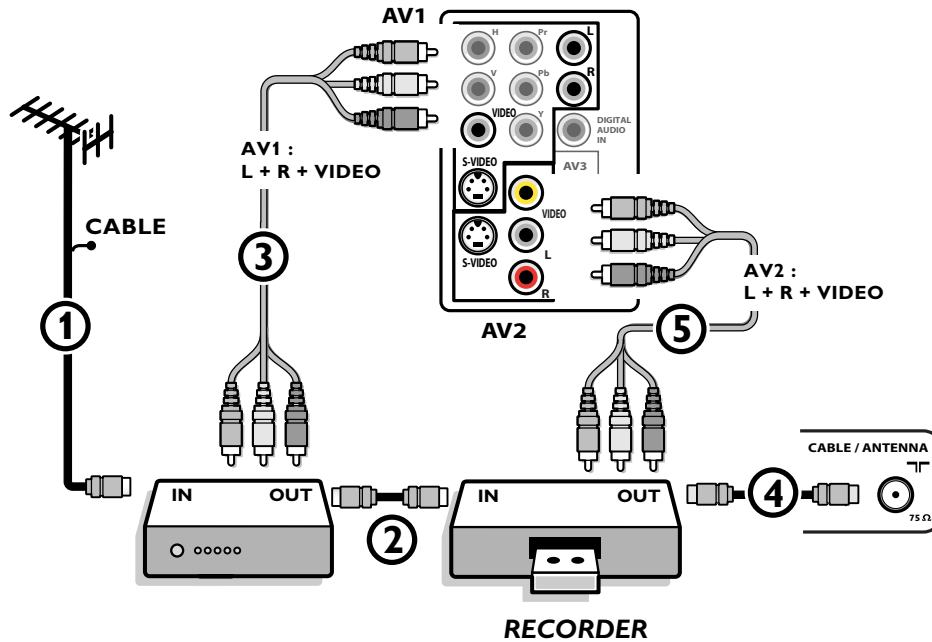

- ① Connect the RF antenna cable ① of the **RF IN** socket of your other AV device.
- ② Connect the RF output of the AV device to the RF input of the recorder ②.
- ③ Connect another RF cable ④ from the output **OUT** of your recorder to the TV's input **CABLE/ANTENNA 75 Ω** jack.
- ④ To obtain better quality, also connect the Video or S-Video, Audio left and Audio right cables of both devices to **AV1 (VIDEO or S-VIDEO, AUDIO L and R)** ③ and to **AV2 (VIDEO or S-VIDEO, AUDIO L and R)** ⑤.

Notes:

- In case of mono equipment, only the left loudspeaker reproduces sound.
- Use a mono to stereo adapter (not supplied) for sound reproduction via all internal loudspeakers.
- When using the **S-VIDEO** connector do not connect any device to the **AV2 VIDEO** or **AV1 VIDEO** input.

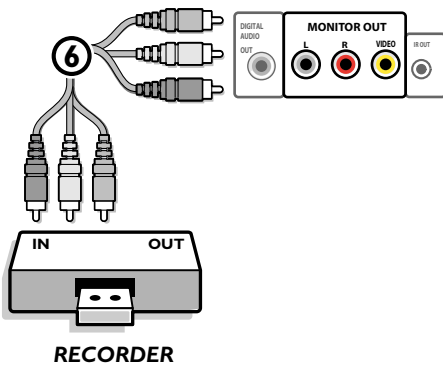

The **MONITOR OUT** connector can be used for a daisy chaining or to record programs from your TV ⑥.
Only when a recorder is connected to **MONITOR OUT** it is possible to record an analog program from your TV.
See Record with your recorder, p. 33.

Recorder and cable box with RF output

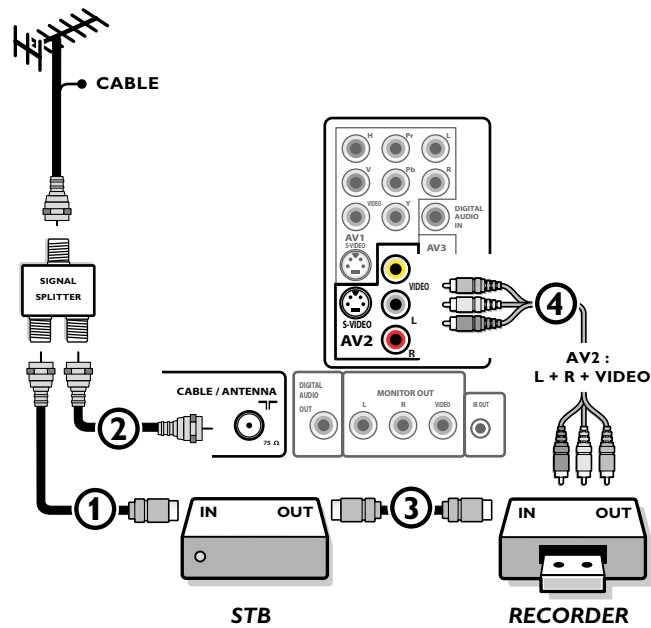

- 1 Use an optional signal splitter.
- 2 Connect one of the cable TV signal splitter outputs ① to the cable box's **IN** jack.
- 3 Connect the other cable TV signal splitter output ② to the **CABLE/ANTENNA 75 Ω** plug on the bottom of the TV.
- 4 Connect the cable box's **OUT** jack ③ to the recorder's **RF IN** socket.
- 5 Connect the Video, Audio Left and Right (only for stereo sound) recorder AV cables ④ to the **VIDEO**, audio **L** and **R** input **AV2** jacks on the TV.

Satellite Receiver / cable box with AV outputs

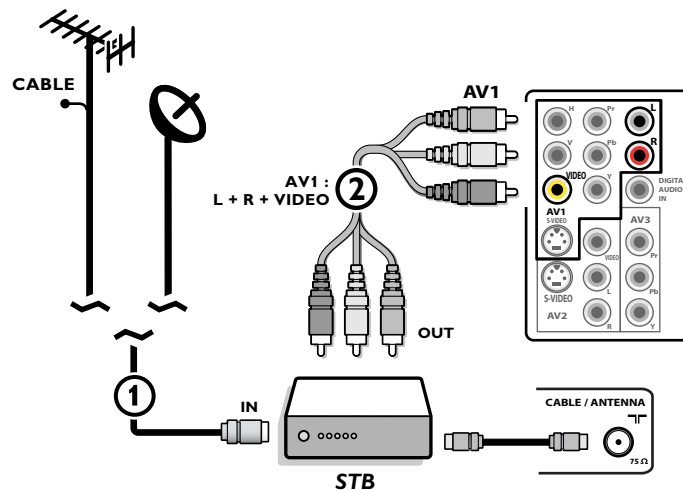

- ❶ Connect the satellite antenna cable or the Cable TV cable ❶ to the satellite receiver's or cable box's **IN** jack.
- ❷ Connect the Video, Audio left and right AV cables ❷ to the **VIDEO**, **L** and **R** audio input jacks of **AV1**.

If your satellite receiver or cable box has an S-Video jack:

For improved picture quality, connect an S-Video cable to the **S-VIDEO** input **instead** of connecting the satellite receiver or cable box to the **VIDEO** jack.

Connect the audio cables to the device's **AUDIO L** and **R** jacks and to the **L** and **R** audio **AV1** jacks on the TV.

Recorder and Satellite Receiver / cable box with AV outputs

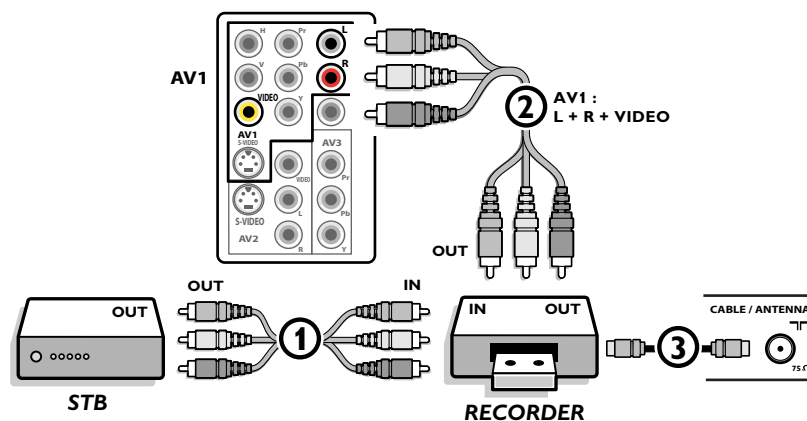

- ❶ Connect the RF Antenna or Cable TV cable as described above.
- ❷ Connect the AV cables ❶ to the satellite receiver's or cable box's **AV OUT** jacks and to the recorder's **AV IN** jacks.
- ❸ Connect the recorder's **AV OUT** jacks ❷ to the TV's **AV1** jacks as described above.
- ❹ Connect another RF cable ❸ from the output out of your recorder to the TV's input **CABLE/ANTENNA** Γ jack.

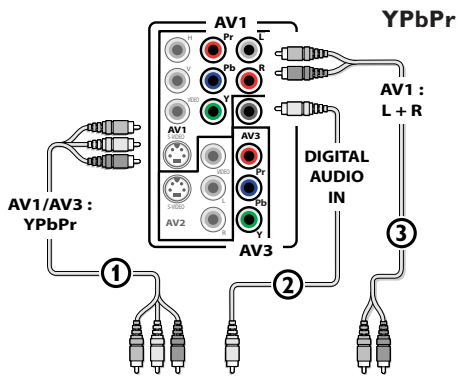

DVD Player or other accessory digital source devices

Devices with Component Video Output Connectors (YPbPr)

This TV is capable of displaying 1080i, 720p and 480p DTV signals when connected to a DTV tuner Set Top Box. Select the output of the Set Top Box to either 1080i, 720p or 480p. A DTV signal must be available in your area.

- 1 Connect the three separate component video cables ① to the device having component video outputs (YPbPr), such as Set Top Boxes, DVD-players, laser-disc players, videogame players, satellite receivers or other equipment, and to the **Y**, **Pb** and **Pr** jacks of **AV1** or **AV3** on the TV.
 - Connect to the **Y**, **Pb** and **Pr** jacks of **AV1** in case of devices with analog audio signals.
 - Connect to the **Y**, **Pb** and **Pr** jacks of **AV3** in case of devices with digital audio signals.
- 2 In case of a device with digital audio, connect the audio cable ② to the **DIGITAL AUDIO OUT** of the device and to the **DIG.AUDIO IN** of the TV or to your Home Cinema system.
In case of a device with analog audio, connect the audio cable to the device's **AUDIO L** and **R** ③ jacks and the **L** and **R** audio jacks of **AV1**.

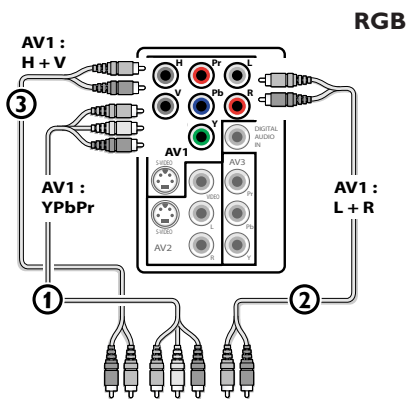

Devices with RGB output

- 1 Connect the device with RGB output with separate Horizontal and Vertical sync to the **Pr/R Pb/B Y/G** input ① jacks and to the **H** and **V** jacks of **AV1** ②.
- 2 Connect the audio cables to the **L** and **R AUDIO** jacks of **AV1** ③.

Devices with an S-Video connector

- 1 Connect an S-Video cable to the **AV1** or **AV2 S-VIDEO** input ①.
Note: When using the S-VIDEO connector do not connect any device to the AV VIDEO input that you are using.
- 2 Connect the audio cables to the device's **AUDIO L** and **R** jacks and to the **L** and **R** audio **AV1** or **AV2** jacks ② on the TV accordingly to where you connected the S-Video cable.

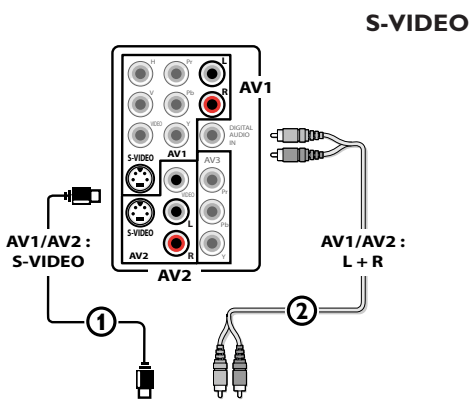

Notes

- If necessary, you can adjust the picture position to the center of the screen with the cursor keys.
- The labels for the component video sockets may differ depending on the DVD player or the device connected. Although the abbreviations may vary, the letters B and R stand for the blue and red component signals, respectively, and Y indicates the luminance signal. Refer to the DVD player's or devices instructions for use for definitions and connection details.
- This television is designed to accept high definition signal standards 720p and 1080i as specified by the Electronic Industries Association standard EIA770.3. Digital devices from different manufacturers have the possibility of differing output standards which may cause difficulties for the television to properly display.
- Due to possible digital image distortion when displaying signals from connected digital equipment, automatically the Auto picture setting **Soft** is selected. See Picture menu, Auto picture, p. 19.
Changing this setting during reviewing will not be stored as **Personal** setting after switch off.

Warning: in case you notice scrolling images, wrong colors or no color, no picture, or even combinations of these on your screen, check if the connections are done in the correct way or move your digital device further away from your TV.

HDMI (High Definition Multimedia Interface) connectors

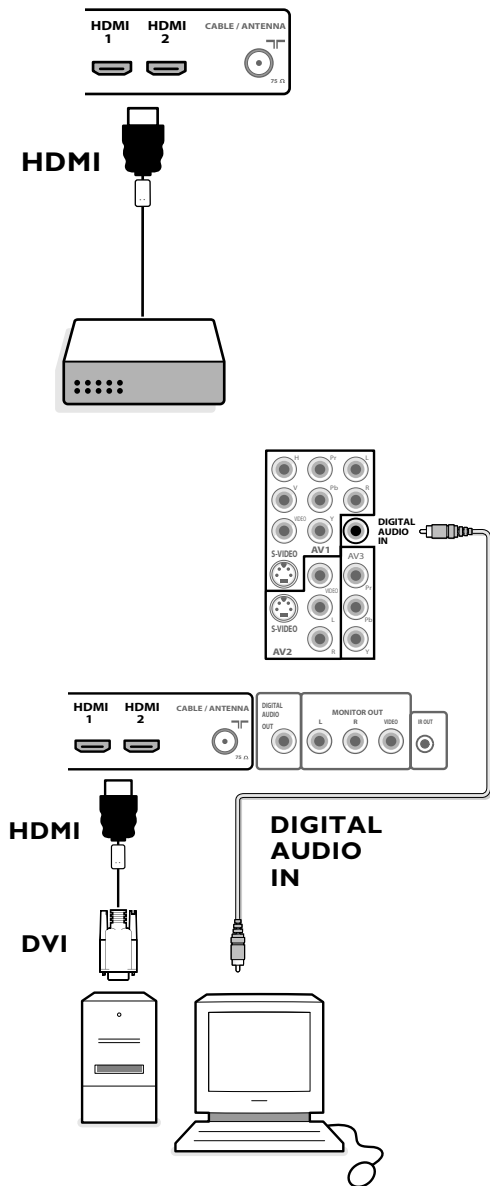

HDMI is the leading new standard for Digital video and audio interconnection. To the **HDMI** connector you can connect HDMI devices such as a Set Top Box or compatible DVD-R or DVD player with HDMI, or DVI-equipped devices like a computer.

So you can display high-definition pictures on this TV in the digital form.

*Note: If the accessory device has DVI output only, use a DVI to HDMI adapter cable to connect to the **HDMI** connector. (Then also connect the audio cable to **DIGITAL AUDIO IN**.)*

- ❶ Connect your HDMI device with one of the **HDMI** connectors.
- ❷ Select the connected digital device in the Setup, Source menu, p. 16.

The **HDMI IN** connectors allow the following TV and monitor display modes:

HD	Standard Definition TV (SDTV)	640/720 x 480i
	Enhanced Definition TV (EDTV)	640/720 x 480p
	High Definition TV (HDTV)	1920x1080i 1280x720p
PC	VGA	640x480 60 Hz
	SVGA	800x600 60 Hz
	XGA	1280x768 60 Hz

Notes:

- If necessary, you can adjust the picture position to the center of the screen with the cursor keys.
 - Due to legal requirements, it is possible that with certain copy protected PCM audio qualities from a device connected to the **HDMI** input, the **DIGITAL AUDIO OUTPUT** signal is muted.
 - Your TV supports HDCP (High-bandwidth Digital Content Protection). This is a system for protecting DVD content outputted via DVI from being copied. It provides a secure digital link between a video source (DVD, PC, etc.) and your TV. Content is encrypted at the source device to prevent unauthorized copies from being made.
 - Proper working is only guaranteed with HDMI compliant consumer products.
 - Digital devices from different manufacturers have the possibility of differing output standards which may cause difficulties for the television to properly display.
 - In case no signal is detected from your HDMI device, turn off the HDMI device and then on again.
- To get an optimal viewing, it is advised to turn your DVD player to one of the following TV display standards: 1920x1080i, 1280x720p, 720x480i or 720x480p.

Digital Surround receiver

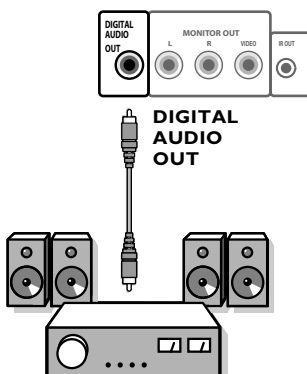

Connect a Digital MultiChannel Surround receiver to the **DIGITAL AUDIO OUT** connector at the bottom of the TV.

Side connections

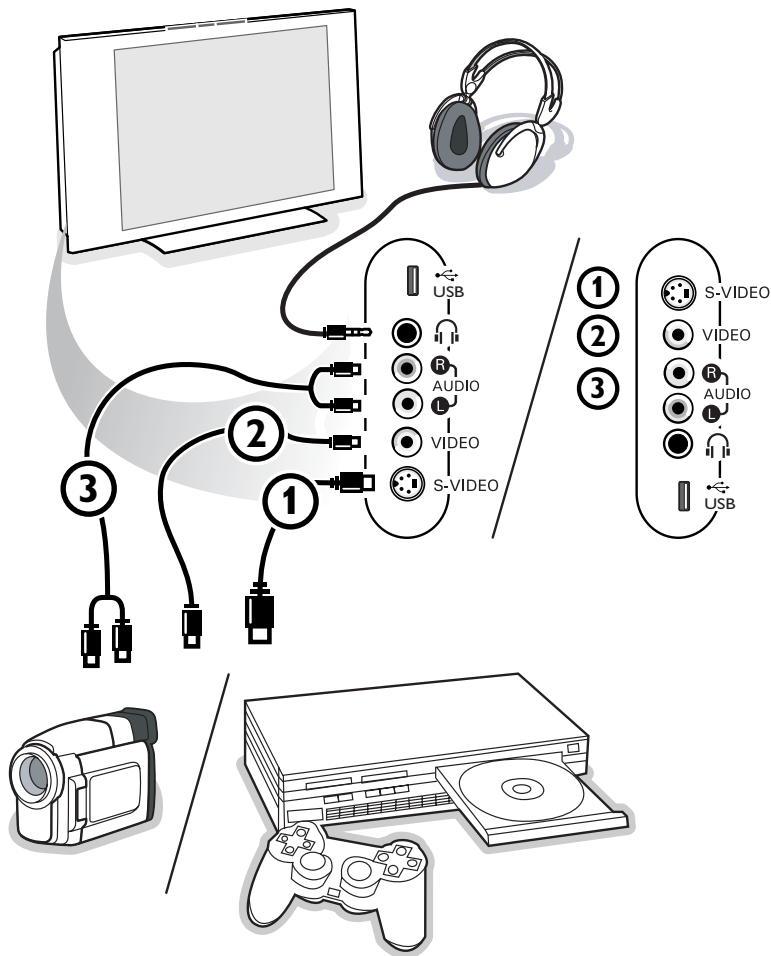

Camera, Camcorder, Game

- ❶ Connect your camera, camcorder or game as shown.
- ❷ Connect to **VIDEO** ❷ and **AUDIO L** ❸ for mono equipment. For stereo equipment also connect **AUDIO R** ❸.
S-VHS quality with an S-VHS camcorder is obtained by connecting the S-VHS cables with the **S-VIDEO** input ❶ and **AUDIO** inputs ❸.
Do not connect cable ❶ and ❷ at the same time. This may cause picture distortion !

Headphone

- ❶ Insert the plug into the headphone socket  as shown.
- ❷ Press the **MUTE** button on the remote control to switch off the internal loudspeakers of the TV.
The headphone impedance must be between 8 and 4000 Ohm. The headphone socket has a 3.5 mm jack.
In the Sound menu select **Headphone volume** to adjust the headphone volume.

Record with your recorder

Record a TV program

You can record a TV program using your recorder's tuner without affecting your TV.

- 1 Select the channel number on your recorder.
- 2 Set your recorder to record.
See the handbook for your recorder.

Switching channel numbers on your TV does not disturb recording!

Record a program from monitor out

You can record a program on your recorder from the TV tuner via **MONITOR OUT**.

- 1 Select the correct channel on your TV and the correct input on your recorder.
- 2 Set your recorder to record.

*Do not switch channels or turn off your TV when you are recording through **MONITOR OUT**.*

Notes:

- When a TV channel or AV source is blocked because of a rating set via the Channels menu (see p. 24), also the record output picture and sound are muted.
- In case of an analog copy protected recording the audio outputs are **not** muted.

To select connected devices



- 1 Press the **AV+** button repeatedly or select **Source** in the Settings menu (see p. 16) to select **AV1**, **AV2**, **AV3**, **HDMI1**, **HDMI2**, **Side** or **TV**, according to where you connected your devices.
- 2 Press the cursor up/down.
- 3 Press **OK**.

Regulatory Notices - Federal Communications Commission Notice

This equipment has been tested and found to comply with the limits for a Class B digital device, pursuant to part 15 of the FCC Rules. These limits are designed to provide reasonable protection against harmful interference in a residential installation. This equipment generates, uses, and can radiate radio frequency energy and, if not installed and used in accordance with the instructions, may cause harmful interference to radio communications. However, there is no guarantee that interference will not occur in a particular installation. If this equipment does cause harmful interference to radio or television reception, which can be determined by turning the equipment off and on, the user is encouraged to try to correct the interference by one or more of the following measures:
Reorient or relocate the receiving antenna.
Increase the separation between the equipment and the receiver.
Connect the equipment into an outlet on a circuit different from that to which the receiver is connected.
Consult the dealer or an experienced radio or television technician for help.

Modifications -

The FCC requires the user to be notified that any changes or modifications made to this device that are not expressly approved by Philips Consumer Electronics may void the user's authority to operate the equipment.

Cables -

Connections to this device must be made with shielded cables with metallic RFI/EMI connector hoods to maintain compliance with FCC Rules and Regulations.

Canadian notice -

This Class B digital apparatus meets all requirements of the Canadian Interference-Causing Equipment Regulations.

Avis Canadien -

Cet appareil numérique de la classe B respecte toutes les exigences du Règlement sur le matériel brouilleur du Canada.

Audio- and video equipment buttons



Most of the audio and video equipment from our range of products can be operated with the remote control of your TV.

Press one of the buttons after you pressed the **SELECT** button repeatedly according to the equipment you want to operate with this remote control. See Use of the remote control, p. 5.

When no action is taken within 60 seconds, the remote control goes back to TV mode.

POWER to switch to standby

|| for pause,

● for record,

◀◀ for rewind (**VCR, CD**);
search down (**DVD, AMP**)

■ for stop,

▶ for play,

▶▶ for fast forward (**VCR, CD**);
search up (**DVD/AMP**)

INFO display information

MENU to switch the menu on or off

- **CH +** for chapter, channel, track
selection

0 to 9 digit entry,

— tape index (**VCR**),
select a DVD chapter,
select a frequency (**AMP**)

cursor up/down
to select the next or the
previous disc (**CD**)

cursor left/right
to select the previous or
following track (**CD**)

Notes:

- If no action is being undertaken within 60 seconds, the remote control returns to TV mode.

- After an action in the selected system mode, the remote control will remain in this mode for 60 seconds and will then return to TV mode or press the **SELECT** button to return to TV mode immediately.



Kensington Security Slot (if present)

Your TV is equipped with a Kensington Security Slot, to prevent it from getting stolen.

An anti-theft Kensington lock has to be purchased separately.

The Kensington lock is a plastic-coated steel cable with a lock. One end has to be fixed to the opening of the TV and locked with a special key. The other end is attached to a fixed point.

® Kensington and MicroSaver are registered US trademarks of ACCO World Corporation with issued registrations and pending applications in other countries throughout the world. All other registered and unregistered trademarks are the property of their respective owners.

Before Calling Service

Symptoms	Items to Check and Actions to follow
“Ghost” or double images	<ul style="list-style-type: none"> This may be caused by obstruction to the antenna due to high rise buildings or hills. Using a highly directional antenna may improve the picture.
No power	<ul style="list-style-type: none"> Check that the TV's AC power cord is plugged into the mains socket. Unplug the television, wait for 60 seconds. Then re-insert plug into the mains socket and turn on the television again.
No picture	<ul style="list-style-type: none"> Check antenna connections at the bottom of the TV to see if they are properly connected to the TV. Possible broadcast station trouble. Try another channel. Adjust the contrast and brightness settings. Try another auto picture setting. Check the Closed Captions control. Some TEXT modes could block the screen. Check if you selected the correct AV source.
No picture and power switched on	<ul style="list-style-type: none"> Your TV has a protective mode in case there is too much heat build-up. Check the clearance around the vents of the device to be certain there are no blocking walls or cabinets which would limit the air flow.
Picture position adjustment	<p>When displaying a High Definition signal from the YPbPr inputs or HDMI input, if necessary, you can adjust the picture position to the center of the screen with the cursor left/right or up/down buttons on the remote control. This may be needed due to slight differences in output signals from different brands and types of HD sources boxes.</p> <p><i>Notes: Most High Definition receiver boxes also have picture-positioning controls in their menu systems. If the TV cursor controls run out of range before the picture is correctly positioned, the receiver box controls will need to be adjusted.</i></p>
No photo, music or video play or in poor quality only	<ul style="list-style-type: none"> Check if the source complies with a supported code.
No sound	<ul style="list-style-type: none"> Increase the VOLUME. Check that the TV is not muted, press the MUTE button on the remote control. When no signal is detected, the TV automatically switches off the sound. This is proper operation and does not indicate a malfunction.
Good sound but poor color or no picture	<ul style="list-style-type: none"> Adjust the contrast, color, tint and brightness setting. Try another auto picture setting.
Snowish picture and noise	<ul style="list-style-type: none"> Check the antenna connection.
Television not responding to remote control	<ul style="list-style-type: none"> Check whether the batteries are working. Replace if necessary. Clean the remote control sensor lens on the monitor. Operating range between TV and the remote control should not be > 240”. You can still use the buttons on the right side of your TV. Check if the remote control is in the correct mode.
Control of accessory devices	<ul style="list-style-type: none"> The infrared signals of the screen may influence the reception sensibility of other peripherals. Solution: replace the batteries of the remote control of other devices. E.g. keep away a wireless headphone from within a radius of 50”.
The software will not install	<p>Possibly the operating system is wrong. Go to www.philips.com/support to see which operating systems are supported.</p>

Standby	Your TV consumes energy in the standby mode. Energy consumption contributes to air and water pollution.
Energy Star Compliance	No CableCARD installed: 1 W. With CableCARD installed: 15 W.
After improper shutdown	If your TV has been shutdown in an improper way (e.g. power drop, power cord plug out), starting up the TV again will take a longer time than usual.
Miscellaneous	See Extras, Specifications on this CD.

If your problem is not solved

Turn your TV off and then on again once.

Never attempt to repair a defective TV yourself.

Check with your dealer or call a TV technician.

Telephone number Philips Customer

Care Center: 1-888-PHILIPS (744-5477)

Please, have the Model and Product number which you can find at the back of your television set ready, before calling.

Tips

Care of the screen

Do not touch, push or rub or strike the screen with anything hard as this may scratch, mar or damage the screen permanently. And please do not rub with dust clothes with chemical treatment.

Do not touch the surface with bare hands or greasy cloth (some cosmetics are detrimental to the screen). Unplug the TV before cleaning the screen.

When the surface becomes dusty, please wipe gently with absorbent cotton or other soft materials like chamois soaks.

Do not use acetone, toluene and alcohol because they cause chemical damage. Do not use liquid cleaners or aerosol cleaners. Wipe off saliva or water drops as soon as possible. Their long time contact with the screen causes deformations and color fading.

Plasma display characteristics

This Plasma display is designed to be used at altitudes up to 6562 ft above sea level (and/or local air pressure equal or above 800 hPa). Operating this set at higher altitude (lower air pressure) is possible. However, at high altitudes (or local air pressure equal or below 800 hPa) the picture on this display may become unstable and picture performance can deteriorate. In addition, the plasma display may produce a humming sound in these conditions.

These possible adverse effects relate to the altitude and are common of all plasma displays. Once the set is brought below approx 6562 ft (and/or local air pressure equal or above 800 hPa) its function will most likely return to normal.

Note: Transportation at high altitudes has no negative effect on the set or picture performance.

How to dispose of batteries?

The batteries supplied do not contain the heavy metals mercury and cadmium. Nevertheless in many areas batteries may not be disposed of with your household waste. Please ensure you dispose of batteries according to local regulations.

Warning concerning stationary images on the TV screen *(only for PDP Displays)*

A characteristic of Plasma Display Panels is that displaying the same image for a long time can cause a permanent after-image to remain on the screen. This is called phosphor burn in.

Normal use of the TV should involve the showing of pictures that contain constantly moving and changing images that fill the screen.

Examples of stationary images (this is not an all-inclusive list, you may encounter others in your viewing):

- **TV and DVD menus:** listings of DVD disk content;
- **Black bars:** when black bars appear at the left and right side of the screen, it is recommended to change to a picture format so that the picture fills the entire screen;
- **PIP and Multipip:** do not view for long periods of time using the PIP function or Multipip function;
- **TV channel logo:** present a problem if they are bright and stationary. Moving or low-contrast graphics are less likely to cause uneven aging of the screen;
- **Stock market stickers:** presented at the bottom of the TV screen;
- **Shopping channel logos and pricing displays:** bright and shown constantly or repeatedly in the same location on the TV screen.

Examples of still pictures also include logos, computer images, time display, teletext and images displayed in 4:3 mode, static images or characters, etc.

Notes:

- reduce contrast and brightness when viewing

- **once burn-in occurs it will never disappear completely.**

Annex 1 - Philips TV software upgrade with portable memory

Introduction

Philips offers software upgrade capability for your TV using USB portable memory.

After you have completed a software upgrade, your TV will typically perform better.

What improvements are made depends on the upgrade software you are using as well as the software your TV contained before the upgrade.

You can execute the software upgrade procedure yourself.

Be aware that the content of this document is addressing technical or software skilled users.

Preparing a portable memory for software upgrade

For the procedure you will require:

- A personal computer with web browsing capability.
- An archive utility that supports the ZIP-format (e.g. WinZip for Windows or StuffIt for Mac OS).
- A preferably empty USB memory stick.

Note: Only FAT/DOS-formatted portable memory is supported.

New software can be obtained from your dealer or can be downloaded from the www.philips.com/support website:

- 1 Go to www.philips.com/support using the web browser on your PC.
- 2 Follow the procedure to find the information and the software related to your TV.
- 3 Select the latest software upgrade file and download it to your PC.
- 4 Decompress the ZIP-file and copy the file "autorun.upg" to the root directory of the USB portable memory.

Note: Only use software upgrades that can be found on the www.philips.com/support web site.

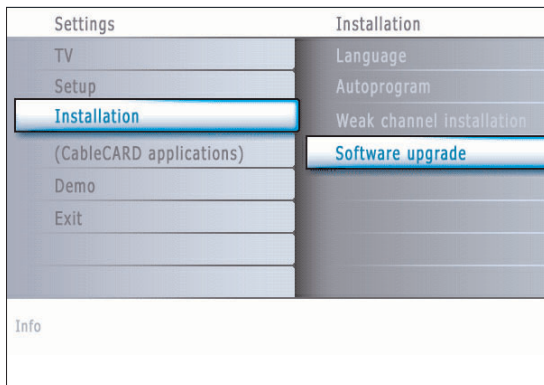

Verifying the version of the TV software

Before starting the software upgrade procedure, it is advised to check what the current TV software is.

- 1 Select **Software Upgrade** in the Installation menu.
- 2 Press the cursor right.
The Software Upgrade menu moves to the left panel.
- 3 Select **Current Software Info** to observe the version and the description of the current software.

Automatic software upgrade procedure

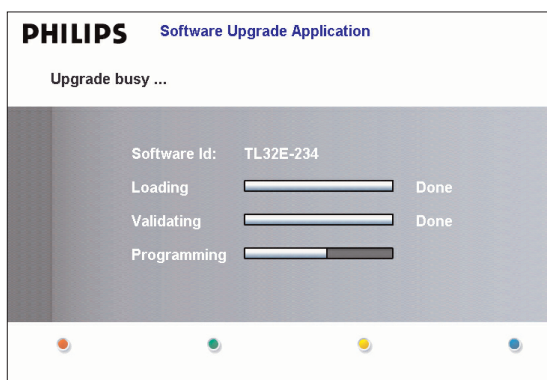

- 1 Power off your TV and remove all memory devices.
- 2 Insert the USB portable memory that contains the downloaded software upgrade.
- 3 Switch on your TV with the **POWER** button on your remote control.
- 4 At startup the TV will scan the USB portable memory until it finds the update content. The TV will automatically go to the upgrade mode. After a few seconds it will display the status of the upgrade procedure.

Warning:

- You are not allowed to remove the USB portable memory during the software upgrade procedure!
 - In case of a power drop during the upgrade procedure, don't remove the USB portable memory from the TV. The TV will continue the upgrade as soon as the power comes back.
 - If you try to upgrade to a software version lower than the current version, a confirmation will be asked. Downgrading to older software should only be done in case of real necessity.
 - If an error occurs during the upgrade you should retry the procedure or contact your dealer.
- 5 When the software upgrade was successful, remove the USB portable memory and restart your TV with the **POWER** button on your remote control.
Your TV will start up with the new software.
Note: Once the upgrade is finished use your PC to remove the TV software from your USB portable memory.

Manual software upgrade procedure

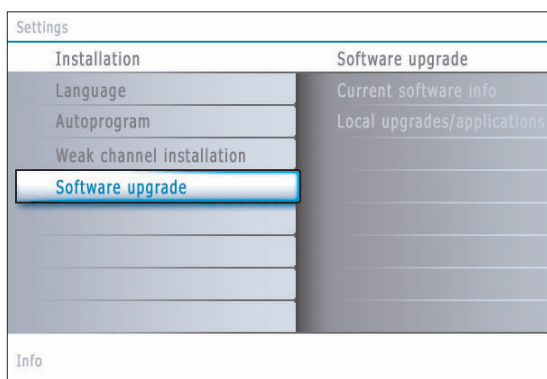

For a manual software upgrade copy the “autorun.upg” file in a directory called “Upgrades” located in the root of the USB portable memory.

- 1 Insert the portable memory that contains the downloaded software upgrade.
- 2 Select **Software Upgrade** in the Installation menu. Go to **Local upgrades/applications**. The TV will list all compatible images available on the USB portable memory and display the data for each selected upgrade image.
- 3 Select the correct upgrade image and press the red color button to start the upgrade.
Your TV will restart and will automatically go to the upgrade mode. After a few seconds it will display the status of the upgrade procedure.

Warning:

If you try to upgrade to a software version equal or lower than the current version, a confirmation will be asked. Downgrading to older software should only be done in case of real necessity.

- 4 When the software upgrade was successful, remove the USB portable memory and restart your TV with the **POWER** button on your remote control.
Your TV will start up with the new software.



Annex 2: Philips TV Slideshow Format with background music

Notes:

- The latest version of this document can be found on the Philips support website (www.philips.com/support).
- Use the type number of your TV (e.g. 42PF7320A/37) to find this documentation and other related files.
- Philips can't be held responsible for any problems that may occur as a result of the content in this document. Errors reported to Philips will be adapted and published on the Philips support website as soon as possible.

Introduction

This document explains how to make a Philips slideshow file with background audio.
Be aware that the content of this document is addressing technical or software skilled users.
To start the slideshow open the slideshow file in the Home network Browser of your TV.

- 1 Press the  button on the remote control after having inserted a USB device and switched on the TV.
- 2 Go to where you stored the slideshow file (.alb) on your portable memory.
- 3 Select the slideshow file and press the **OK** button to start the slide show.
- 4 To stop a slide show, press the  button.

General Rules

- The slideshow will use plain ASCII XML syntax to allow the creation and editing of the slideshow files using simple tools.
- All references to network content must be based on the global address of the content.
- Content on a Portable Memory (PM) doesn't have a global address; as a result content from a PM can never be referenced from a slideshow not stored on the PM itself.
- To maintain portability, a slideshow stored on a PM should **ONLY** reference content on the same PM. Referencing global addresses can result in inconsistencies if the PM is used on a non-networked CE device. The latter is however not forbidden, it is only a recommendation.
- It is preferable that URL's referencing PM content are based on a relative path starting from the directory where the slideshow is stored. This path includes the device or drive name of the PM.
An absolute path to content will also be supported.
 - relative path: pictures\test1.jpg, tamper.jpg, ..\new\bird.jpg, ...
 - absolute path: USB1:\pictures1\foo_bar.jpg, C:\f1.jpg, \organization.jpg, ...

General Format

The format and syntax below will be used to create the slideshow file (simple ascii text) with the extension .alb (.ALB)
Examples: slshow1.alb, summer_holiday_2004.ALB, test.alb, ...
The following syntax should be used to create the text file:

```
<?xml version="1.0" encoding="ISO-885h9-1" ?>
<philips-slideshow version="1.0" >
  <title>Title of the slideshow</title>
  <audio>audio_url</audio>
  <slide-duration>30</slide-duration>
  <slides>
    <slide>slide_1_url</slide>
    <slide>slide_2_url</slide>
    <slide>slide_3_url</slide>
    <slide>slide_4_url</slide>
    <slide>slide_5_url</slide>
    <slide>slide_6_url</slide>
    ...
    <slide>slide_N-1_url</slide>
    <slide>slide_N_url</slide>
  </slides>
</philips-slideshow>
```

Supported XML-tags

The following table gives a description of the XML syntax.

Tag Name	Use	Description
philips-slideshow	mandatory	Philips slideshow signature including the version.
title	optional	The title of the playlist.
audio	optional	The audio-URL following this tag will define the music playing in the background during the slideshow. A single song or playlist (.m3u & .pls) are the only valid audio references. Other reference will not result in any audio playback. If a single song is referenced the song will be repeated forever. If a playlist is referenced the playlist will be played in sequence with a repeat at the end of the playlist.
slide-duration	optional	The default display time (in 0,1 second) of a slide. The TV application isn't obliged to support this tag. The TV application can force the use of one or multiple predefined display times.
slides	mandatory	Identifies the slides to show.
slide	optional	Identifies the URL of the individual slide.

Examples:

See on this CD in the directory Files/Slideshow/....

Copy the directory with the slideshow files to your portable memory.

```
<?xml version="1.0" encoding="ISO-885h9-1" ?>
<philips-slideshow version="1.0" >
  <title>Philips AlbumFile</title>
  <audio>Music\Nature.mp3</audio>
  <slide-duration>50</slide-duration>
  <slides>
    <slide>Images\Image01.jpg</slide>
    <slide>Images\Image02.jpg</slide>
    <slide>Images\Image03.jpg</slide>
    <slide>Images\Image04.jpg</slide>
    <slide>Images\Image05.jpg</slide>
    <slide>Images\Image06.jpg</slide>
    <slide>Images\Image07.jpg</slide>
    <slide>Images\Image08.jpg</slide>
    <slide>Images\Image09.jpg</slide>
    <slide>Images\Image10.jpg</slide>
    <slide>Images\Image11.jpg</slide>
    <slide>Images\Image12.jpg</slide>
  </slides>
</philips-slideshow>
```

Annex 3 - Philips TV - USB

Notes:

- The latest version of this document can be found on the Philips support website (www.philips.com/support).
- The software of your TV is upgradeable. If you have problems first check if you have the latest software installed on your TV. The latest software, together with instructions, can be found on the Philips support website.
Use the type number of your TV (e.g. 42PF7320A/37) to find this documentation and other related files.
- Philips can't be held responsible neither for any errors in the content of this document nor for any problems as a result of the content in this document. Errors reported to Philips will be adapted and published on the Philips support website as soon as possible.

Digital Content Issues

- Only FAT (DOS) formatted (initialized) portable memory is supported. Errors in this formatting can result in unreadable content. If such problems appear try to re-format the card. Be aware that formatting the card will also delete all the content on it (pictures, music, ...).
- The following file types are supported: .jpg, .jpeg, .mp3, .alb, .m3u and .pls.
- Only linear JPEG picture formats are supported. Progressive JPEG encodings are not supported.
- The length of a filename or directory name is limited to the length specified by the FAT12/16/32 file systems.
- Max. levels of nested directories is 19.
- Never use the supported file type extensions (.jpg, .jpeg, .mp3, .alb, .m3u and .pls) as extensions for directories as these directories will be treated as corrupted files.
- The MP3 decoder does not support MPEG1 Layer 1 or Layer 2 playback.
- MP3 Pro files can be played with normal MP3 quality.
- The access and response time of the content on a device can differ depending on the type or brand of the device.
- The access and response time of the content on a device will decrease the more unsupported or corrupted files are on the device.

Digital Camera Issues

If a USB connection between your digital camera and the TV isn't working, you can try the solutions below to resolve your problem.

- Make sure your digital camera is switched on and verify if the configuration of your digital camera is correct (see the manual of your digital camera for more information).
- Some digital cameras allow you to switch off the USB interface. Make sure that the USB interface is switched on before connecting to the TV.
- If you have a digital camera with only internal memory (no removable memory) you can try to copy the content manually to a USB memory device (e.g. Philips KEY product) using a personal computer.
- Some digital cameras allow you to switch between PTP (Picture Transfer Protocol) or "PC Link" and USB Mass Storage or "PC Drive". Make sure that you select USB Mass Storage or "PC Drive" on your digital camera.
- If your camera supports different interface settings be sure to try them one by one or contact the reseller of your camera to find out the correct setting.

USB Memory Device Issues

- Devices connected to the USB port of your TV must be "Mass Storage Class" compliant. If your device (digital camera, MP3 player, portable harddisk, ...) is not "Mass Storage Class" compliant it will not be detected by the content browser of the TV.
- The following subsets of the Mass Storage Class specification are supported:
 - The implementation of the TV is based on the "Universal Serial Bus Mass Storage Class Specification Overview" (v1.2, June 23, 2003) including all documents referenced by the document. The document can be found on the USB standardisation website (www.usb.org).
 - Full support of the USB Mass Storage Class Bulk-Only Transport (bInterfaceProtocol = 50h).
 - Full support of SubClass Code = 05h; SFF-8070i spec.
 - Full support of SubClass Code = 06h; SCSI transparent command set.
- For large USB memory devices, when you are in the Content Browser, it may take a long time before you can access your files.
- When using a USB portable harddisk: Due to the high power consumption of the harddisk, it is advised to use the external power supply of the portable harddisk to guarantee proper working under all conditions.

PHILIPS LIMITED WARRANTY

One (1) Year Labor & One (1) Year Parts & One (1) Year Display Repair

PHILIPS warrants this product against defect in material or workmanship, subject to any conditions set forth as follows:

PROOF OF PURCHASE:

You must have proof of the date of purchase to receive warranted repair on the product. A sales receipt or other document showing the product and the date that you purchased the product as well as the authorized retailer included, is considered such proof.

COVERAGE:

(If this product is determined to be defective)

LABOR: For a period of one (1) year from the date of purchase, Philips will repair or replace the product, as its option, at no charge, or pay the labor charges to any Philips authorized service center. After the period of one (1) year, Philips will no longer be responsible for charges incurred.

PARTS: For a period of one (1) year from the date of purchase, Philips will supply, at no charge, new or rebuilt replacement parts in exchange for defective parts. Philips authorized service centers will provide removal and installation of the parts for one (1) year.

DISPLAY: For a period of one (1) year from the date of purchase, Philips will supply, at no charge, a new or rebuilt active display device in exchange for the defective display. Philips authorized service centers will provide removal and installation of the parts under the specified labor warranty.

EXCLUDED FROM WARRANTY COVERAGE

Your warranty does not cover:

- Labor charges for installation or setup of the product, adjustment of customer controls on the product, and installation or repair of antenna systems outside of the product.
- Product repair and/or part replacement because of improper installation, connections to improper voltage supply, abuse, neglect, misuse, accident, unauthorized repair or other cause not within the control of Philips.
- A product that requires modification or adaptation to enable it to operate in any country other than the country for which it was designed, manufactured, approved and/or authorized, or repair of products damaged by these modifications.
- Damage occurring to product during shipping when improperly packaged or cost associated with packaging.
- Product lost in shipment and no signature verification of receipt can be provided.
- A product used for commercial or institutional purposes (including but not limited to rental purposes).
- Product sold AS IS or RENEWED.

TO OBTAIN WARRANTY SERVICE IN THE U.S.A., PUERTO RICO, OR U.S. VIRGIN ISLANDS.....

Contact Philips Customer Care Center at
1-888-PHILIPS (1-888-744-5477).

TO OBTAIN WARRANTY SERVICE IN CANADA...

1-800-661-6162 (French speaking)
1-888-PHILIPS (1-888-744-5477) (English or Spanish speaking)

REPAIR OR REPLACEMENT AS PROVIDED UNDER THIS WARRANTY IS THE EXCLUSIVE REMEDY FOR THE CONSUMER. PHILIPS SHALL NOT BE LIABLE FOR ANY INCIDENTAL OR CONSEQUENTIAL DAMAGES FOR BREACH OF ANY EXPRESS OR IMPLIED WARRANTY ON THIS PRODUCT. EXCEPT TO THE EXTENT PROHIBITED BY APPLICABLE LAW, ANY IMPLIED WARRANTY OF MERCHANTABILITY OR FITNESS FOR A PARTICULAR PURPOSE ON THIS PRODUCT IS LIMITED IN DURATION TO THE DURATION OF THIS WARRANTY.

Some states do not allow the exclusions or limitation of incidental or consequential damages, or allow limitations on how long an implied warranty lasts, so the above limitations or exclusions may not apply to you. In addition, if you enter into a service contract agreement with the PHILIPS partnership within ninety (90) days of the date of sale, the limitation on how long an implied warranty lasts does not apply.

This warranty gives you specific legal rights. You may have other rights which vary from state/province to state/province.

Philips, P.O. Box 671539, Marietta, GA. 3006-0026

