

# HITACHI

## Inspire the Next

### PLASMA TELEVISION

## Operating Guide for 42HDS52, 42HDS52A and 55HDS52

IMPORTANT SAFETY INSTRUCTIONS.....	2-3
FIRST TIME USE .....	4-20
THE REMOTE CONTROL.....	21-38
ON-SCREEN DISPLAY .....	39-71
USEFUL INFORMATION.....	72-78
END USER LICENSE AGREEMENT FOR HITACHI DTV SOFTWARE.....	79
APPENDIXES .....	80-81
INDEX .....	82



*As an Energy Star® Partner,  
Hitachi, Ltd. has determined  
that this product meets the  
Energy Star® guidelines for  
energy efficiency.*

**ULTRAVISION**

# Important Safety Instructions



## SAFETY POINTS YOU SHOULD KNOW ABOUT YOUR HITACHI PLASMA TELEVISION

Our reputation has been built on the quality, performance, and ease of service of **HITACHI** plasma televisions.

Safety is also foremost in our minds in the design of these units. To help you operate these products properly, this section illustrates safety tips which will be of benefit to you. Please read it carefully and apply the knowledge you obtain from it to the proper operation of your **HITACHI** plasma television.

Please fill out your warranty card and mail it to **HITACHI**. This will enable **HITACHI** to notify you promptly in the improbable event that a safety problem should be discovered in your product model.

**Follow all warnings and instructions marked on this plasma television.**



 The lightning flash with arrowhead symbol, within an equilateral triangle, is intended to alert the user to the presence of uninsulated "dangerous voltage" within the product's enclosure that may be of a sufficient magnitude to constitute a risk of electric shock to a person.

 The exclamation point within an equilateral triangle, is intended to alert the user to the presence of important operating and maintenance (servicing) instructions in the literature accompanying the appliance.

## READ BEFORE OPERATING EQUIPMENT

Follow all warnings and instructions marked on this plasma television.

1. Read these instructions.
2. Keep these instructions.
3. Heed all warnings.
4. Follow all instructions.
5. Do not use this apparatus near water.
6. Clean only with a dry cloth.
7. Do not block any ventilation openings. Install in accordance with the manufacturer's instructions.
8. Do not install near any heat sources such as radiators, heat registers, stoves, or other apparatus (including amplifiers) that produce heat.
9. Do not defeat the safety purpose of the polarized or grounding-type plug. A polarized plug has two blades with one wider than the other. A grounding type plug has two blades and a third grounding

prong. The wide blade or the third prong are provided for your safety. If the provided plug does not fit into your outlet, consult an electrician for replacement of the obsolete outlet.

10. Protect the power cord from being walked on or pinched particularly at plugs, convenience receptacles, and the point where they exit from the apparatus.
11. Only use the attachments/accessories specified by the manufacturer.

12.  Use only with the cart, stand, tripod, bracket, or table specified by the manufacturer, or sold with the apparatus. When a cart is used, use caution when moving the cart/apparatus combination to avoid injury from tip-over.
13. Unplug this apparatus during lightning storms or when unused for long periods of time.
14. Refer all servicing to qualified service personnel. Servicing is required when the apparatus has been damaged in any way, such as power-supply cord or plug is damaged, liquid has been spilled or objects have fallen into apparatus, the apparatus has been exposed to rain or moisture, does not operate normally, or has been dropped.

15. Televisions are designed to comply with the recommended safety standards for tilt and stability. Do not apply excessive pulling force to the front, or top, of the cabinet which could cause the product to overturn resulting in product damage and/or personal injury.
16. Follow instructions for wall, shelf or ceiling mounting as recommended by the manufacturer.
17. An outdoor antenna should not be located in the vicinity of overhead power lines or other electrical circuits.
18. If an outside antenna is connected to the receiver be sure the antenna system is grounded so as to provide some protection against voltage surges and built up static charges. Section 810 of the National Electric Code, ANSI/NFPA No. 70-1984, provides information with respect to proper grounding for the mast and supporting structure, grounding of the lead-in wire to an antenna discharge unit, size of grounding connectors, location of antenna-discharge unit, connection to grounding electrodes and requirements for the grounding electrode.

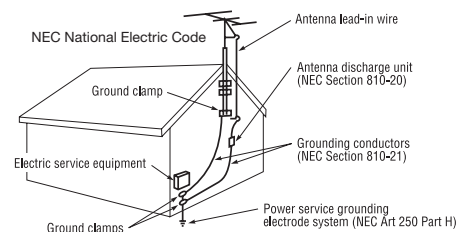

Note to the CATV system installer: This reminder is provided to call the CATV system installer's attention to Article 820-44 of the NEC that provides guidelines for proper grounding and, in particular, specifies that the cable ground shall be connected to the grounding system of the building, as close to the point of cable entry as practical.

# Important Safety Instructions



## Power source

This plasma television is designed to operate on 120 volts 60 Hz, AC current. Insert the power cord into a 120 volt 60 Hz outlet.

To prevent electric shock, do not use the plasma television's (polarized) plug with an extension cord, receptacle, or other outlet unless the blades and ground terminal can be fully inserted to prevent blade exposure.

Never connect the plasma television to 50 Hz, direct current, or anything other than the specified voltage.

## Caution



Never remove the back cover of the plasma television as this can expose you to very high voltages and other hazards. If the television does not operate properly, unplug the plasma television and call your authorized dealer or service center.

## Caution

Adjust only those controls that are covered in the instructions, as improper changes or modifications not expressly approved by **HITACHI** could void the user's warranty.



## Warning

- To reduce the risk of fire or electric shock, do not expose this apparatus to rain or moisture.
- The plasma television should not be exposed to dripping or splashing and objects filled with liquids, such as vases, should not be placed on the television.

## Modifications

The FCC requires the user to be notified that any changes or modifications made to this device that are not expressly approved by Hitachi America, Ltd. Home Electronics Division may void the user's authority to operate the equipment.

## Note

This plasma television will display television closed captioning, ( or ), in accordance with paragraph 15.119 and 15.122 of the FCC rules.

## Public viewing of copyrighted material

Public viewing of programs broadcast by TV stations and cable companies, as well as programs from other sources, may require prior authorization from the broadcaster or owner of the video program material.

This product incorporates copyright protection technology that is protected by U.S. patents and other intellectual property rights. Use of this copyright protection technology must be authorized by Macrovision Corporation, and is intended for home and other limited consumer uses only unless otherwise

authorized by Macrovision. Reverse engineering or disassembly is prohibited.

## Note

This digital television is capable of receiving analog basic, digital basic and digital premium cable television programming by direct connection to a cable system providing such programming. A CableCARD provided by your cable operator is required to view encrypted digital programming. Certain advanced and interactive digital cable services such as video-on-demand, a cable operator's enhanced program guide and data-enhanced television services may require the use of a set-top box. For more information call your local cable company.

## Note

- There are no user serviceable parts inside the plasma television.
- Model and serial numbers are indicated on back side of the plasma television.

## Prevention of screen damages

Continuous on-screen displays such as video games, stock market quotations, computer generated graphics, and other fixed (non-moving) patterns can be permanently imprinted onto your TV screen. Such "**SCREEN DAMAGES**" constitute misuse and are **NOT COVERED** by your **HITACHI** Factory Warranty.

## Lead Notice

This product contains lead. Dispose of this product in accordance with applicable environmental laws. For product recycling and disposal information, contact your local government agency or the Electronic Industries Alliance at [www.eiae.org](http://www.eiae.org) (in the US) or the Electronic Product Stewardship Canada at [www.epsc.ca](http://www.epsc.ca) (in Canada).

**FOR MORE INFORMATION, CALL 1-800-HITACHI.**

# Accessories

**Check to make sure you have the following accessories before disposing of the packing material.**

- 1** Remote Control

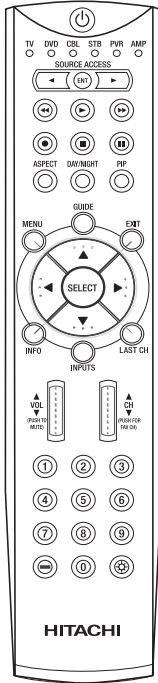

- 2** Two "AA" size, 1.5V batteries

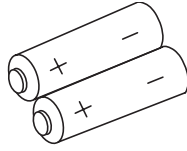

- 3** Power Cord



- 4** 2 IR Mouse Cable

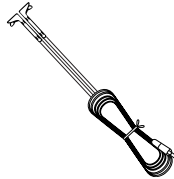

- 5** Table Top Stand (42" models only)

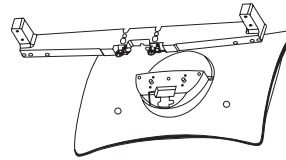

- 6** Cleaning Cloth

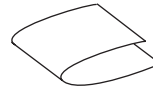

- 7** Power Swivel Cable (42" models only)



- 8** 1 Ferrite Core (see page 13)

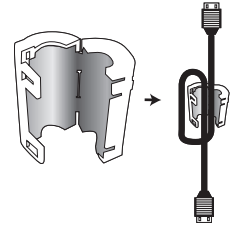

Note: Please visit our website for optional accessories for the 55" models.

**For U.S. models:**  
For optional accessories, please access our web site at: [www.hitachi.us/tv](http://www.hitachi.us/tv)



**CAUTION:**

1. Ceiling mounting is not recommended. Mounting the panel on the ceiling does not provide adequate ventilation for the electronics or proper support for the front glass panel. This plasma television product is designed for a maximum tilting angle of 45 degrees from vertical.
2. This stand for use only with Hitachi 42HDS52 and 42HDS52A. Use with other apparatus is capable of resulting in instability causing possible injury. See important marking located on bottom of stand.

- |   |   |
|---|---|
| <b>1</b> Remote Control Unit CLU-3852WL (Part No. HL02066). | <b>5</b> Table Top Stand (P# QJ01831K).   |
| <b>2</b> Two "AA" size, 1.5V batteries (P# FQ00021).        | <b>6</b> Cleaning Cloth (P# MS00931).     |
| <b>3</b> Power Cord (P# EV01841).                           | <b>7</b> Power Swivel Cable (P# EW08431). |
| <b>4</b> Two IR Mouse cables (P# EY01641).                  | <b>8</b> Ferrite Core (P# 2169513).       |

**REMOTE CONTROL BATTERY INSTALLATION AND REPLACEMENT**

1. Open the battery cover of the remote control by pushing down and sliding the back cover off.
2. Insert two new "AA" size batteries for the remote control. When replacing old batteries, push them towards the springs and lift them out.
3. Match the batteries to the (+) and (-) marks in the battery compartment.
4. Replace the cover.

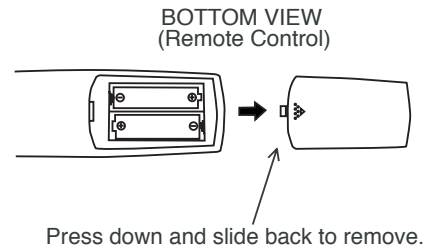

**CAUTION:** Do not insert batteries with '+' and '-' polarities reversed as this may cause the batteries to swell or rupture resulting in leakage.

# How To Set Up Your New Hitachi Plasma Television

To take measures to prevent the Plasma Television from tipping over and prevent possible injury it is important to mount the unit in a stable and flat surface.

## Securing to a table-top

- Using wood screws (two) fasten the set to the clamping screw holes on the rear of the Plasma Display stand as shown below.
- Using commercially available wood screws, secure the set firmly in position.

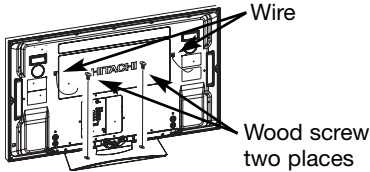

## Securing to a Wall

- Keep the Plasma television 4 inches away from the wall except when mounted using the wall mount bracket.
- Secure the television to the wall as shown in fig. (a) or (b).

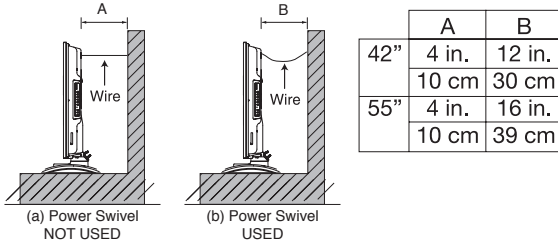

- NOTES:**
- Do not block the ventilation holes of the Plasma Television. Blocking the ventilation holes might cause fire or defect.
  - In case of an abnormal symptom, unplug the AC cord.
  - If you purchased the wall mount bracket option, please ask for professional installer. Do not install by yourself.
  - If the Power Swivel feature will not be used, the Plasma television should be secured to the wall as shown in fig. (a).
  - If the Power Swivel feature will be used, the Plasma television should be secured to the wall as shown in fig. (b). The wires need to be long enough to allow the television to turn 30° to the left and right.

## Caution when moving the main unit

As this product is heavy, whenever it is moved, two people are required to transport it safely. Whenever the unit is moved it should be lifted forward using the top and base on both sides of the Television for stability. When moving the Television, lift the handles (42" models), support the top frame (55" models) and the bottom frame as shown below. Do not grab the speakers or the back cover when lifting.

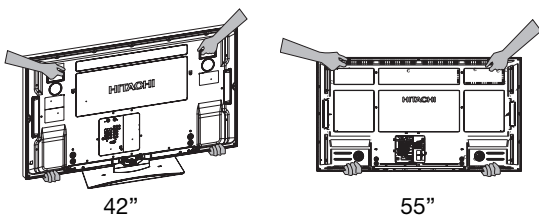

## ANTENNA

Unless your Plasma Television is connected to a cable TV system or to a centralized antenna system, a good outdoor color TV antenna is recommended for best performance. However, if you are located in an exceptionally good signal area that is free from interference and multiple image ghosts, an indoor antenna may be sufficient.

## LOCATION

Select an area where sunlight or bright indoor illumination will not fall directly on the picture screen. Also, be sure that the location selected allows a free flow of air to and from the perforated back cover of the set. In order to prevent an internal temperature increase, maintain a space of 10 cm (4 inches) from the sides/back of the Television, and 30 cm (12 inches) from the top of the television to the wall. To avoid cabinet warping, cabinet color changes, and increased chance of set failure, do not place the TV where temperatures can become excessively hot, for example, in direct sunlight or near a heating appliance, etc.

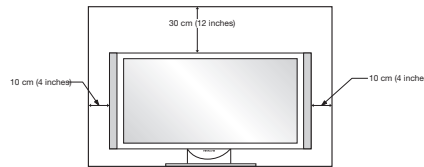

## CONNECT POWER SWIVEL CABLE

Connect one end of cable (Arrow mark facing left) to the swivel slot of the Plasma Rear Panel. Connect the other end (Arrow mark facing front) to the swivel slot of the Table Top Stand.

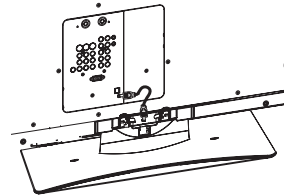

## TURNING RADIUS

The maximum turning radius is 30° (left and right). Do not place any objects on the path of the monitor when using the power swivel feature.

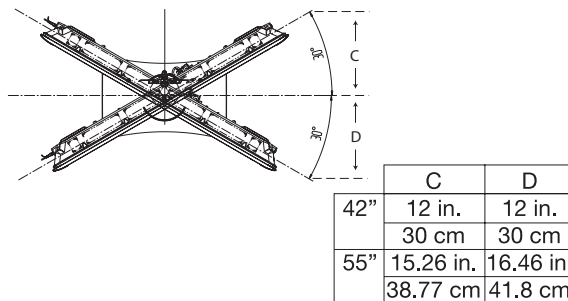

**NOTE:** The Table Top Stand and Power Swivel cable for model 55HDS52 are not included (Optional).

# How to set up your new HITACHI Plasma Television

First time use

## VIEWING

The best picture is seen by sitting directly in front of the TV and about 10 to 18 feet from the screen.

During daylight hours, reflections from outside light may appear on the screen. If so, drapes or screens can be used to reduce the reflection or the TV can be located in a different section of the room.

If the TV's audio output will be connected to a Hi-Fi system's external speakers, the best audio performance will be obtained by placing the speakers equidistant from each side of the receiver cabinet and as close as possible to the height of the picture screen center. For best stereo separation, place the external speakers at least four feet from the side of the TV, place the surround speakers to the side or behind the viewing area. Differences in room sizes and acoustical environments will require some experimentation with speaker placement for best performance.

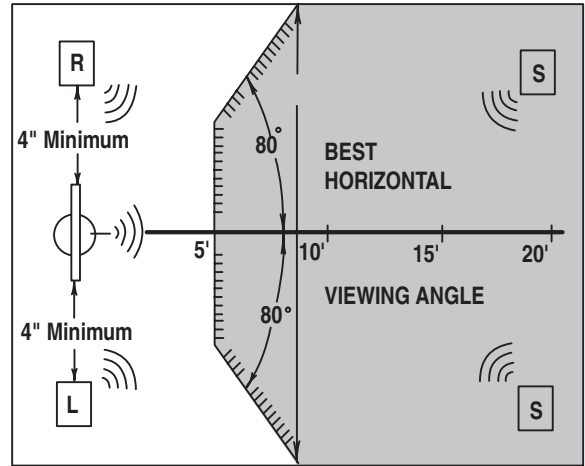
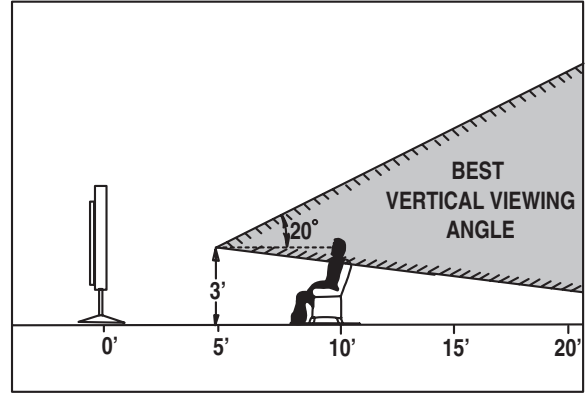

## ANTENNA CONNECTIONS TO REAR JACK PANEL

### VHF (75-Ohm) antenna/CATV (Cable TV)

When using a 75-Ohm coaxial cable system, connect **CATV** coaxial cable to the **CABLE** (75-Ohm) terminal. If you have an antenna, connect the coaxial cable to the **AIR** terminal.

### VHF (300-Ohm) antenna/UHF antenna

When using a 300-Ohm twin lead from an outdoor antenna, connect the **VHF** or **UHF** antenna leads to screws of the **VHF** or **UHF** adapter. Plug the adapter into the antenna terminal on the TV.

### When both VHF and UHF antennas are connected

Attach an optional antenna cable mixer to the TV antenna terminal, and connect the cables to the antenna mixer. Consult your dealer or service store for the antenna mixer.

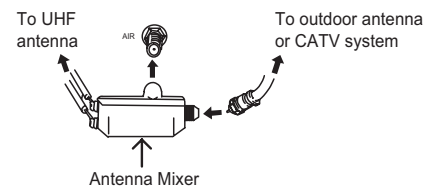
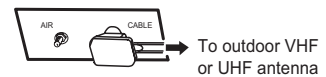
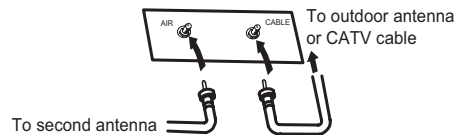

**NOTE:** Connecting a 300-Ohm twin lead connector may cause interference. Using a 75-Ohm coaxial cable is recommended.

# Hook-up Cables and Connectors

Most video/audio connections between components can be made with shielded video and audio cables that have phono connectors. For best performance, video cables should use 75-Ohm coaxial shielded wire. Cables can be purchased from most stores that sell audio/video products. Below are illustrations and names of common connectors. Before purchasing any cables, be sure of the output and input connector types required by the various components and the length of each cable.

## 300-Ohm Twin Lead Cable

This outdoor antenna cable must be connected to an antenna adapter (300-Ohm to 75-Ohm).

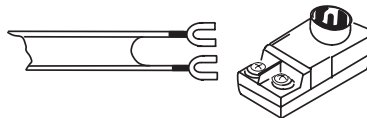

## Phono Connector

Used on all standard video and audio cables which connect to inputs and outputs located on the television's rear jack panel and front control panel.



## "F" Type 75-Ohm Coaxial Antenna Connector

For connecting RF signals (antenna or cable TV) to the antenna jack on the television.



## S-Video (Super Video) Cable

This cable is used on camcorders, VCRs and laser-disc players with an S-Video feature in place of the standard video cable to produce a high quality picture.



## Optical Cable

This cable is used to connect to an audio amplifier with an Optical Audio In jack. Use this cable for the best sound quality.

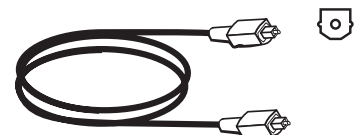

## HDMI Cable

This cable is used to connect your external devices such as Set-Top-Boxes or DVD players equipped with an HDMI output connection to the TV's HDMI input.

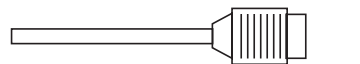

## Stereo Cable (3.8mm plug to 3.5mm plug)

Used on all standard video and audio cable which connect to inputs and outputs located on the rear jack panel and front control panel.

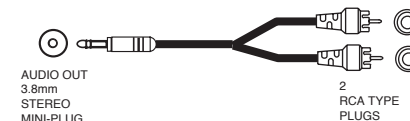

## USB Cable

This cable is used to connect your digital camera to the Photo Input in the side of the Plasma television.



## IR Mouse Cable (Provided)

Connect the IR Mouse to the IR output of your Plasma Television when A/V Network is used. You must place the IR mouse in front of the corresponding IR window of your cable box and VCR. This connection allows your TV to control your cable box and VCR.

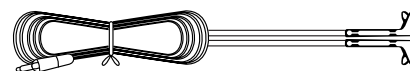

## Power Swivel Cable (Provided in 42" models)

This cable is used to connect the swivel stand to the rear panel of the Plasma Television.



# Quick Reference Remote Control Buttons and Functions

In addition to controlling all of the functions on your HITACHI Plasma Television, the new remote control is designed to operate different types of devices, such as, DVD Players, CBL (Cable Boxes), set-top-boxes, satellite receivers, and VCRs. The remote control must be programmed to control the chosen device. Please see pages 21-38 for a complete description of all features and programming of the Remote Control.

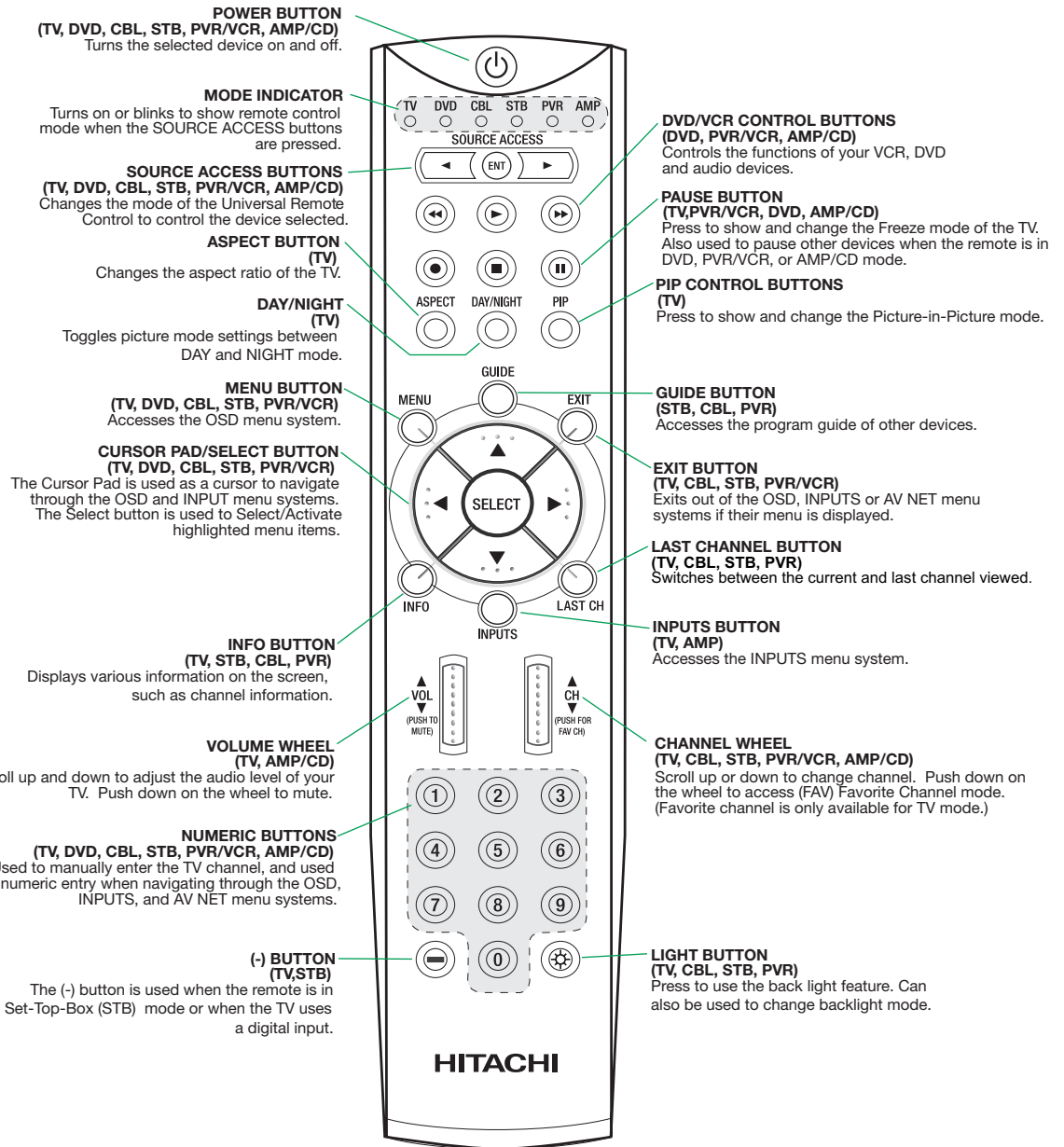

## LEGEND

**TV** – Television      **VCR** – Video Cassette Recorder/Player  
**CBL** – Cable Box      **DVD** – Digital Video Disc Player  
**STB** – Set-Top-Box      **SAT** – Satellite Receiver

- NOTES:**
1. The TV's remote control sensor is located on the right bottom portion of the TV screen. To control TV functions, please point the remote control directly at the remote control sensor for best results.
  2. VCR precode is included in the PVR mode.
  3. CD precode is included in the AMP mode.
  4. Pressing any button will illuminate the backlight for 4 seconds.



# Front/Rear/Side Panel Controls

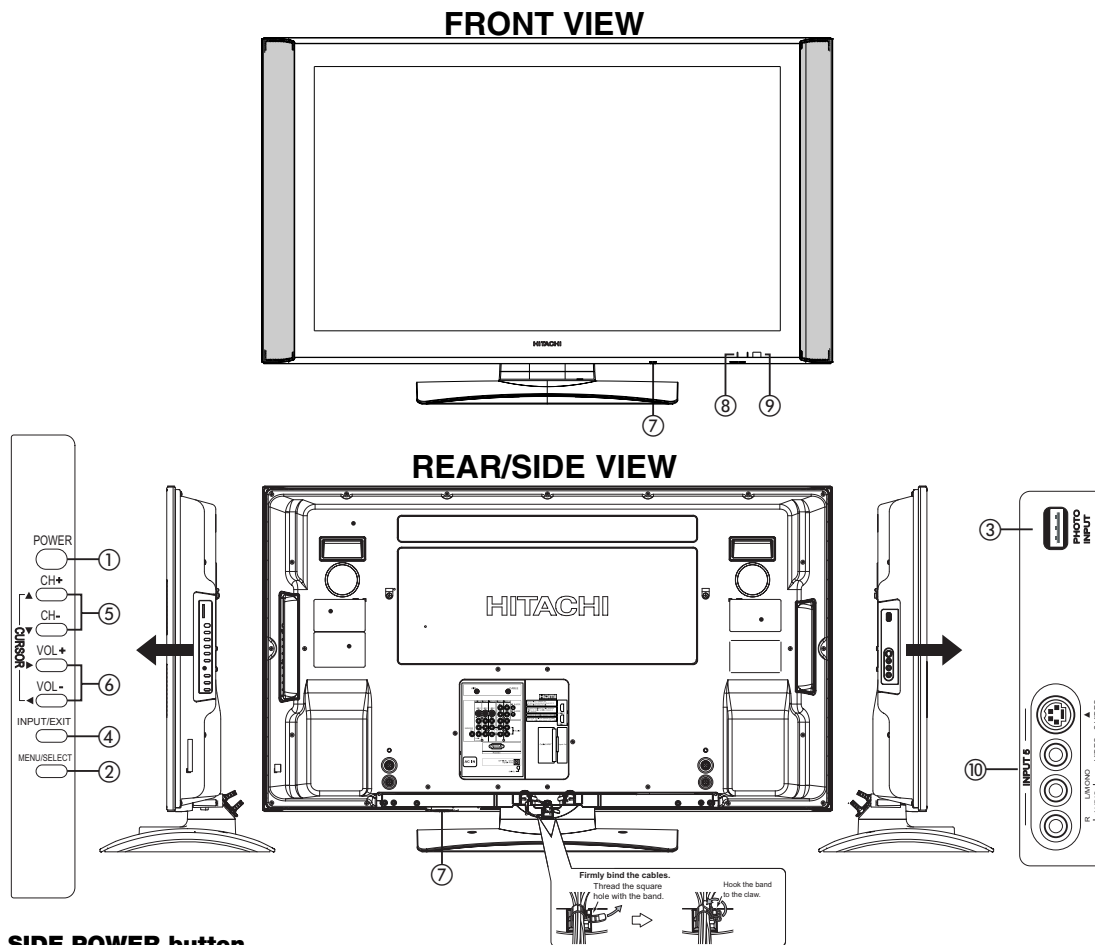

**① SIDE POWER button**

Press this button to turn the Plasma Television ON/OFF. It can also be turned ON/OFF by remote control. The “MAIN POWER” button must be at stand-by mode.

**② MENU/SELECT button**

This button allows you to enter the MENU, making it possible to set TV features to your preference without using the remote. This button also serves as the SELECT button when in MENU mode.

**③ PHOTO INPUT**

Insert USB cable from your Digital Camera, USB memory or memory card USB drive to view your digital still pictures (see pages 24-26).

**④ INPUT/EXIT button**

Press this button to access the INPUT menu. Press again to exit the MENU mode.

**⑤ CHANNEL selector**

Press these buttons until the desired channel appears in the top right corner of the TV screen. These buttons also serve as the cursor down (▼) and up (▲) buttons when in MENU mode.

**⑥ VOLUME level**

Press these buttons to adjust the sound level. The volume level will be displayed on the TV screen. These buttons also serve as the cursor left (◀) and right (▶) buttons when in MENU mode.

**NOTE:** The Rear View of the 55” model is slightly different from the 42” models. One of the differences are the handles that are only present on the 42” models.

**⑦ POWER button**  
**Display Monitor MAIN POWER button**  
 This power button is for the complete system, and must be turned ON/OFF manually. It is recommended to leave the “MAIN POWER” to ON condition (lights red) for stand-by mode.

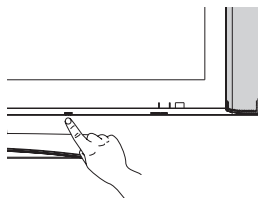

The Main Power button is located on the broadside bottom, under the label “MAIN POWER”.

**NOTE:** When the “MAIN POWER” button is set to OFF or the TV is unplugged, the clock will stop and may eventually reset itself.

## Front/Rear/Side Panel Controls

### ⑧ **POWER light indicator**

To turn the monitor ON, press the main power switch located on the lower right side of the monitor. A red stand-by indicator lamp located on the lower right corner of the front bezel will illuminate. The Plasma TV is now ready for remote ON/OFF operation.

Indicating Lamp	Power Status	Operating
Off	Off	When the main power switch is set to OFF.
Lights Red	Off (Stand-by)	When the main power switch on the display monitor is ON.
Lights Green	On	Display monitor MAIN POWER is ON.
Lights Orange	Off (Power Saving)	Display monitor MAIN POWER is ON with no signal input except antenna (no sync. signal).

### ⑨ **REMOTE CONTROL sensor**

Point your remote at this area when selecting channels, adjusting volume, etc.

### ⑨ **LEARNING AV NET sensor**

Point your equipment's remote control at this area while using the AV NET Learning Wizard.

### ⑩ **SIDE INPUT JACKS (for VIDEO: 5)**

Use these audio/video jacks for a quick hook-up from a camcorder or VCR to instantly view your favorite show or new recording. Press the INPUTS button then use the CURSOR PAD and the SELECT button on the remote control to select INPUT 5. If you have mono sound, insert the audio cable into the left audio jack.

- NOTES:**
1. Your HITACHI Plasma TV will appear to be turned OFF (lights orange) if there is no video input when VIDEO: 1, 2, 3, 4 and 5. Check the Power Light to make sure the Display Monitor is turned off or in Stand-by mode (lights red) when not in use.
  2. Remote Control can not turn ON/OFF the "MAIN POWER" of the display monitor.

# Rear Panel Connections

## ① Antenna Input

The remote control allows you to switch between two separate 75-Ohm RF antenna inputs, CABLE and AIR.

## ② Audio/Video INPUTS 1, 2, 3 and 4

By using the INPUTS button, the CURSOR PAD (▲ and ▼), and the SELECT button or CURSOR PAD ► of the remote control, you can select each video source. Use the audio and video inputs to connect external devices, such as VCRs, camcorders, laserdisc players, DVD players etc. (if you have mono sound, insert the audio cable into the left audio jack).

## ③ MONITOR OUT & HI-FI AUDIO OUT

These jacks provide fixed and variable audio and video signals (CABLE/AIR, INPUT 1, 2 and 5) which are used for recording. Use the S-VIDEO Output for high quality video output. Component signal to INPUT 3 and 4, and HDMI inputs will not have monitor output.

## ④ Optical Out (Digital Audio)

This jack provides Digital Audio Output for your audio device that is Dolby® Digital and PCM compatible, such as an audio amplifier.

**NOTE:** \*Manufactured under license from Dolby Laboratories. "Dolby" and the double-D symbol are trademarks of Dolby Laboratories.

## ⑤ S-VIDEO INPUTS 1 and 2

INPUTS 1 and 2 provide S-VIDEO (Super Video) jacks for connecting equipment with S-VIDEO output capability.

**NOTE:** 1. You may use HDMI, VIDEO or S-VIDEO inputs to connect to INPUT 1 and 2, but only one of these inputs may be used at a time.  
2. S-VIDEO output may be used for recording, only when the input is of S-VIDEO type.

## ⑥ HDMI INPUTS 1 and 2 (High Definition Multimedia Interface)

**ABOUT HDMI – HDMI** is the next-generation all digital interface for consumer electronics. **HDMI** enables the secure distribution of high-definition video and multi-channel audio in a single cable. Because digital television (DTV) signals remain in digital format, **HDMI** assures that pristine high-definition images retain the highest video quality from the source all the way to your television screen.

Use the **HDMI** input for your external devices such as Set-Top-Boxes or DVD players equipped with an **HDMI** output connection.

**HDMI**, the **HDMI** logo and High-Definition Multimedia Interface are trademarks or registered trademarks of **HDMI** Licensing LLC.

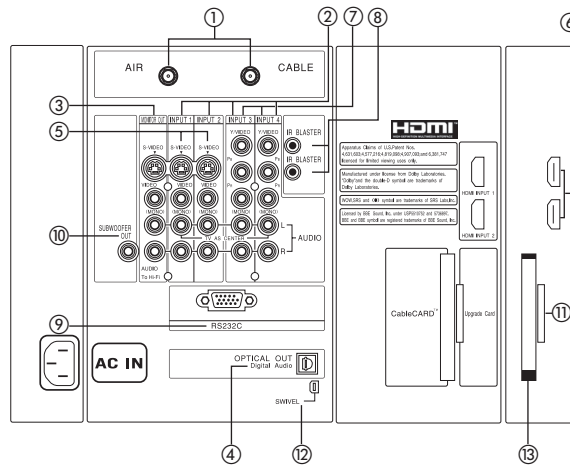

**NOTE:** 1. The HDMI input is not intended for use with personal computers.  
2. Only DTV formats such as 1080i, 720p, 480i and 480p are available for HDMI input.

## ⑦ Component: Y-PbPr Inputs

INPUTS 3 and 4 provide Y-PbPr jacks for connecting equipment with this capability, such as a DVD player or Set Top Box. You may use composite video signal for both inputs.

**NOTE:** 1. Do not connect composite VIDEO and S-VIDEO to INPUT 1, 2 or 5 at the same time. S-VIDEO has priority over VIDEO input.  
2. Your component outputs may be labeled Y, B-Y, and R-Y. In this case, connect the components B-Y output to the TV's Pb input and the components R-Y output to the TV's Pr input.  
3. Your component outputs may be labeled Y-CbCr. In this case, connect the component Cb output to the TV's Pb input and the component Cr output to the TV's Pr input.  
4. It may be necessary to adjust TINT to obtain optimum picture quality when using the Y-PbPr inputs (see page 41).  
5. To ensure no copyright infringement, the MONITOR OUT output will be abnormal, when using the Y-PbPr jacks.  
6. INPUT 3 and INPUT 4 (Y/VIDEO) can be used for composite video and component video input.

## ⑧ IR Blaster

This jack provides IR output to your external components (VCR, Cable box, DVD player, etc.). With this connection, your external components can automatically be controlled by the A/V network feature. This connection will allow you to control the external components with your Plasma Television's remote control in TV mode.

## ⑨ For Service Use Only

Do not connect anything to this terminal. Specifically for Service use only.

First time use

# Rear Panel Connections

- ⑩ **Subwoofer Out**  
Connect this SUB WOOFER OUT output to the external audio component input using the sub woofer cable provided.
- ⑪ **Upgrade Card**  
This card slot is for future software upgrades. HITACHI will notify you if a software upgrade is required for your TV. In order to receive written notification, please complete and return your warranty card.
- ⑫ **To Power Swivel Connector**  
Connects to the Power Swivel Table Top Stand.
- ⑬ **CableCARD Slot**  
This slot is for the CableCARD that will be provided by your local cable operator to gain access to chosen cable channels. Please call your local cable operator if this service is available before requesting a CableCARD (also known as Point of Deployment (POD) module).
  1. Connect a coaxial cable to cable terminal of the Rear Panel Jacks.
  2. Insert the CableCARD into the slot (Top of card should be facing towards you as shown below).

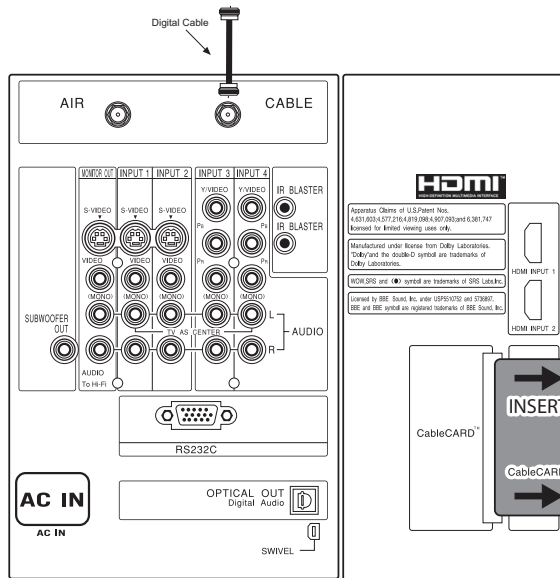

**NOTE:** 1. A digital cable subscription is required.  
2. Do not insert a PCMCIA card into the CableCARD slot.

If the CableCARD is properly installed or removed, the TV will display the following respective screens.

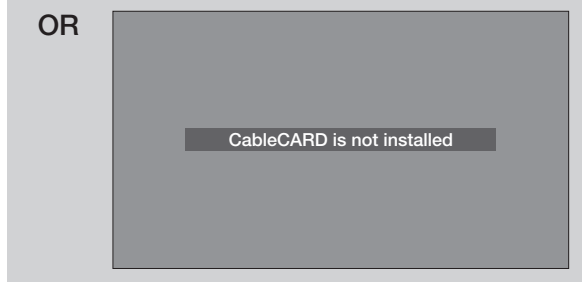
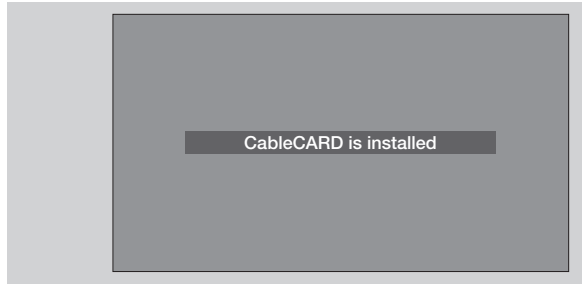

After the CableCARD is installed, wait until the second screen below appears. The third screen below will appear if a channel is not authorized for viewing. Press the **EXIT** button to exit the second screen.

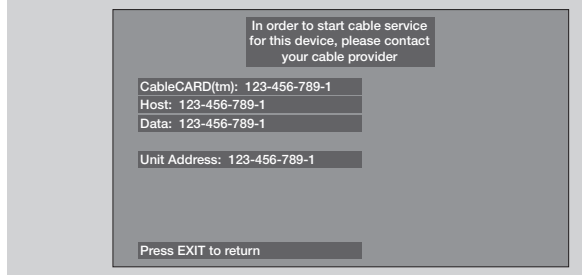
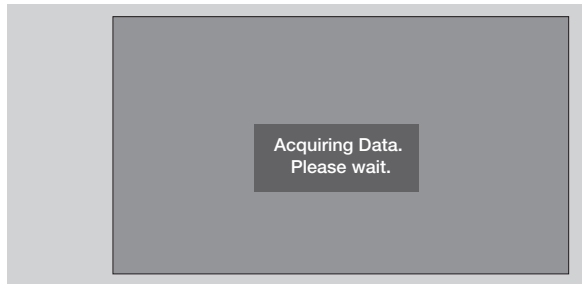

Please take note of all information on the screen (you will provide this information to your cable operator). Call your cable operator and give them the information from the card to start your cable service.

**NOTE:** Please see Appendix E on page 80 for additional CableCARD information.

# Connecting External Video Sources

The front panel jacks are provided as a convenience to allow you to easily connect a camcorder or VCR as shown in the following examples:

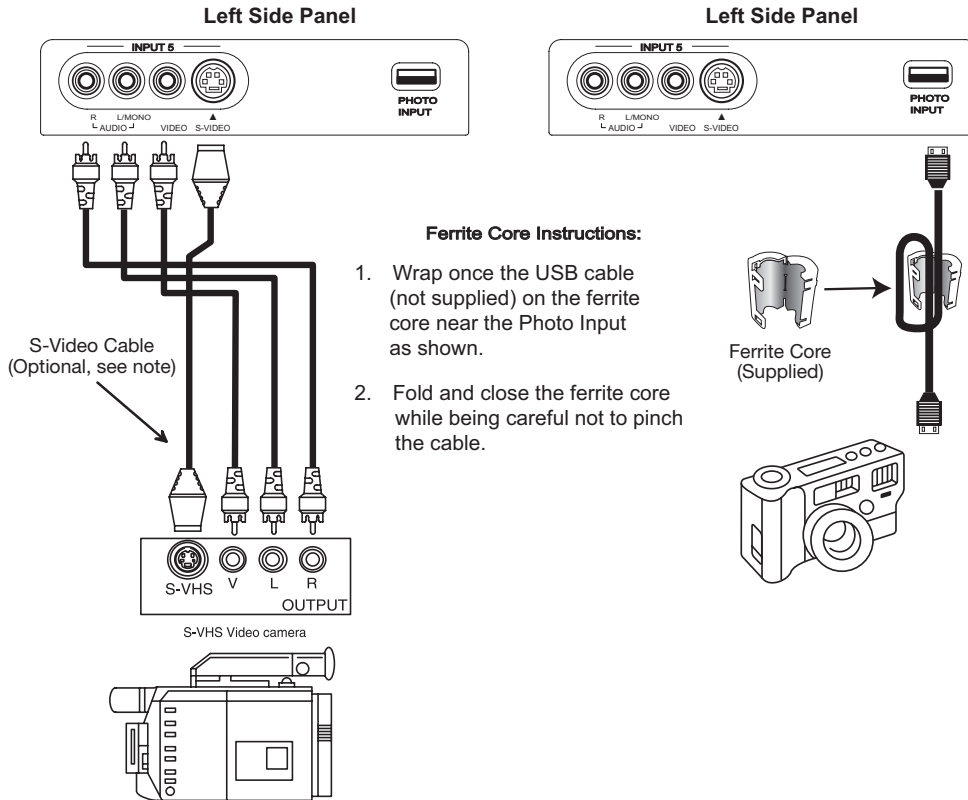

- NOTE:**
1. Completely insert connection cord plugs when connecting to left side panel jacks. If you do not, the played back picture may be abnormal.
  2. If you have a S-VHS VCR, use the S-Video cable in place of the standard video cable.
  3. If you have a mono VCR, insert the audio cable into the left audio jack of your TV.
  4. S-VIDEO input takes priority over VIDEO input.
  5. If you have a VHS or 8mm camcorder, use the S-VIDEO cable in place of the VIDEO cable.

The exact arrangement you use to connect the VCR, camcorder, laserdisc player, DVD player, or HDTV Set Top Box to your Plasma TV is dependent on the model and features of each component. Check the owner's manual of each component for the location of video and audio inputs and outputs.

The following connection diagrams are offered as suggestions. However, you may need to modify them to accommodate your particular assortment of components and features. For best performance, video and audio cables should be made from coaxial shielded wire.

## Before Operating External Video Source

Connect an external source to one of the INPUT terminals, then press the INPUTS button to show the INPUTS menu. Use the CURSOR PAD (▲ and ▼) to select the Antenna or Input of your choice. Then press the SELECT button or the CURSOR PAD ► to confirm your choice (see page 24).

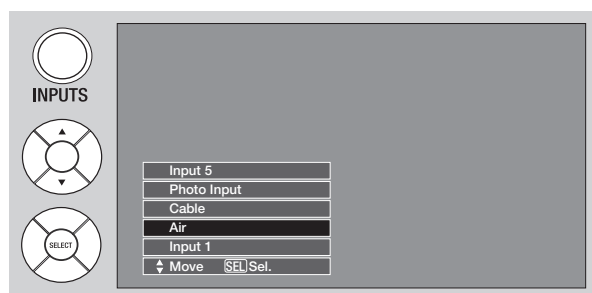

# Rear Panel Connections

First time use

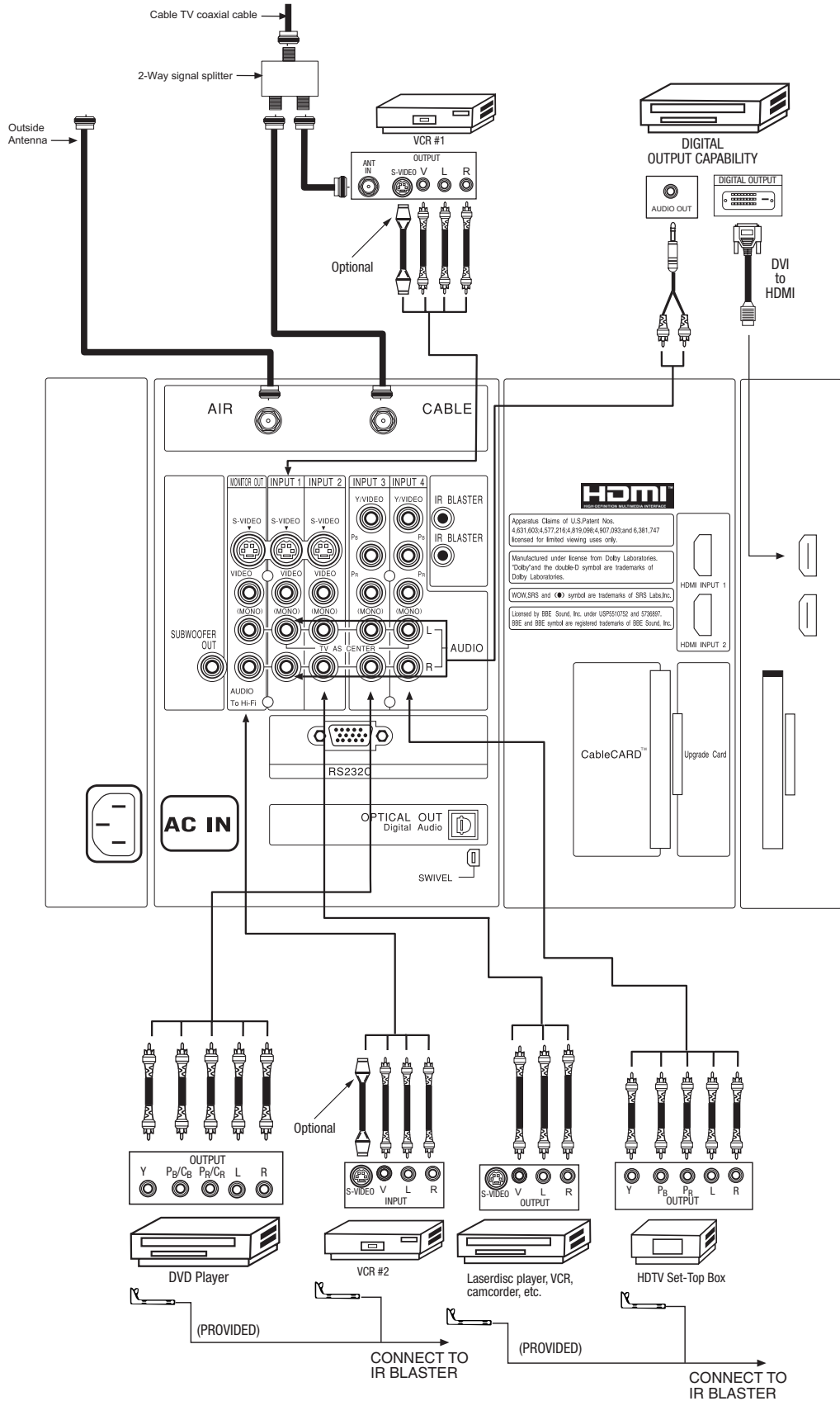

## Tips on Rear Panel Connections

- S-VIDEO, YPbPR, or HDMI connections are provided for high performance laserdisc players, VCRs etc. that have this feature. Use these connections in place of the standard video connection if your device has this feature.
- If your device has only one audio output (mono sound), connect it to the left audio jack on (L/(MONO)) the Rear Panel.
- Refer to the operating guide of your other electronic equipment for additional information on connecting your hook-up cables.
- A single VCR can be used for VCR #1 and VCR #2, but note that a VCR cannot record its own video or line output (INPUT: 1 in the example on page 14). Refer to your VCR operating guide for more information on line input-output connections.
- Connect only 1 component (VCR, DVD player, camcorder, etc.) to each input jack.
- COMPONENT: Y-P<sub>B</sub>P<sub>R</sub> (Input 3 & 4) connections are provided for high performance components, such as DVD players and set-top-boxes. Use these connections in place of the standard video connection if your device has this feature.
- Your component outputs may be labeled Y, B-Y, and R-Y. In this case, connect the components B-Y output to the TV's P<sub>B</sub> input and the components R-Y output to the TV's P<sub>R</sub> input.
- Your component outputs may be labeled Y-C<sub>B</sub>C<sub>R</sub>. In this case, connect the components C<sub>B</sub> output to the TV's P<sub>B</sub> input and the components C<sub>R</sub> output to the TV's P<sub>R</sub> input.
- It may be necessary to adjust TINT to obtain optimum picture quality when using the Y-P<sub>B</sub>P<sub>R</sub> inputs. (See page 41)
- To ensure no copyright infringement, the MONITOR OUT output will be abnormal, when using the Y-P<sub>B</sub>P<sub>R</sub>, and HDMI input jacks.
- Input 1 or 2 can accept HDMI signal.
- S-VIDEO monitor output may be used for recording only when the input is of S-VIDEO type.
- When using a HDMI input from a Set-Top-Box, it is recommended to use a 1080i or 720p input signal.

### MACROVISION NOTES:

1. Video signals fed through a VCR may be affected by copyright protection systems and the picture will be distorted on the television.
2. Connecting the television directly to the Audio /Video output of a Set-Top-Box will assure a more normal picture.

# Connecting External Video Sources

## CONNECTING A VIDEO AND STEREO AUDIO SOURCE TO INPUT1 - INPUT5

1. Connect the cable from the VIDEO OUT of the VCR or the laserdisc player to the INPUT (VIDEO) jack, as shown on the Rear Panel to the right.
2. Connect the cable from the AUDIO OUT R of the VCR or the laserdisc player to the INPUT (AUDIO/R) jack.
3. Connect the cable from the AUDIO OUT L of the VCR or the laserdisc player to the INPUT (AUDIO/L) jack.
4. Press the INPUTS button, then select INPUT 2 from the INPUTS menu to view the program from the VCR or laserdisc player.
5. Select CABLE or AIR from the INPUTS menu to return to the last channel tuned.

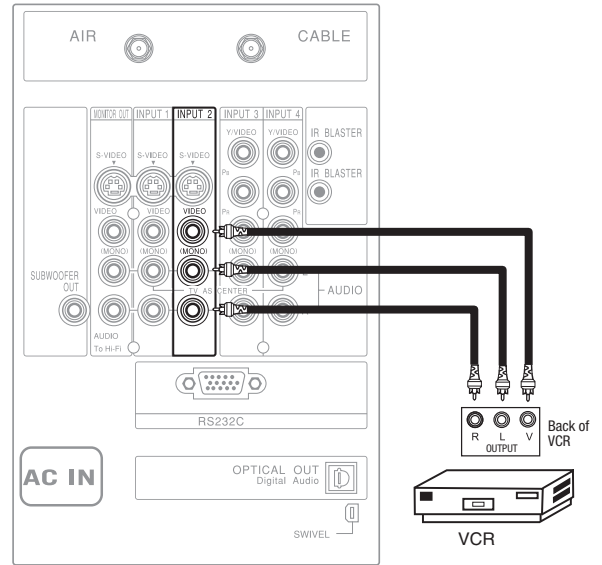

**NOTE:** 1. Completely insert the connection cord plugs when connecting to rear panel jacks. The picture and sound that is played back will be abnormal if the connection is loose.  
 2. A single VCR can be used for VCR #1 and VCR #2 (see page 14) but note that a VCR cannot record its own video or line output. Refer to your VCR operating guide for more information on line input-output connections.  
 3. When INPUT 3 or 4 are used, it is necessary to connect the video output of the device to the Y/VIDEO input jack of the TV.

## CONNECTING AN S-VIDEO AND STEREO AUDIO SOURCE TO INPUT 1, 2 AND 5

1. Connect the cable from the S-VIDEO OUT of the S-VHS VCR or the laserdisc player to the INPUT (S-VIDEO) jack, as shown on the Rear Panel to the right.
2. Connect the cable from the AUDIO OUT R of the VCR or the laserdisc player to the INPUT (AUDIO/R) jack.
3. Connect the cable from the AUDIO OUT L of the VCR or the laserdisc player to the INPUT (AUDIO/L) jack.
4. Press the INPUTS button, then select INPUT 1 from the INPUTS menu to view the program from the VCR or laserdisc player.
5. Select CABLE or AIR from the INPUTS menu to return to the last channel tuned.

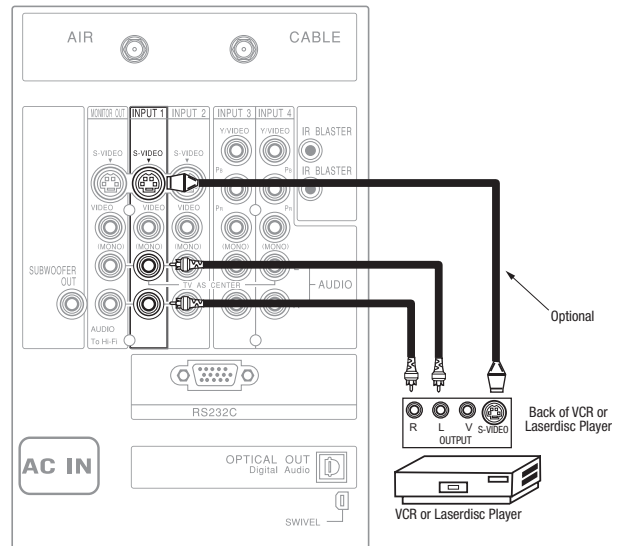

**NOTE:** 1. Completely insert the connection cord plugs when connecting to rear panel jacks. The picture and sound that is played back will be abnormal if the connection is loose.  
 2. A single VCR can be used for VCR #1 and VCR #2 (see page 14), but note that a VCR cannot record its own video or line output. Refer to your VCR operating guide for more information on line input-output connections.



# Connecting External Video Sources

## CONNECTING A COMPONENT SOURCE WITH HDMI OR DVI CAPABILITY TO INPUT 1 OR 2

1. Connect the HDMI or DVI to HDMI connection cable from the output of the HDTV set top box or DVD player to the HDMI input as shown on the Rear panel below.
2. With DVI output, connect the cable from the AUDIO OUT R of the HDTV set top box or DVD player to the INPUT (AUDIO/R) jack as shown on the Rear Panel below.
3. With DVI output, connect the cable from the AUDIO OUT L of the HDTV set top box or DVD player to the INPUT (AUDIO/L) jack as shown on the Rear Panel below.
4. Press the INPUTS button, then select INPUTS 1 or 2 to view the program from the HDTV set top box or DVD player.
5. Select CABLE or AIR from the INPUTS menu to return to the last channel viewed.

- NOTE:**
1. Completely insert the connection cord plugs when connecting to rear panel jacks. The picture and sound that is played back will be abnormal if the connection is loose.
  2. The HDMI input on INPUT 1 and 2 contains the copy protection system called High-bandwidth Digital Content Protection (HDCP). HDCP is a cryptographic system that encrypts video signals when using HDMI connections to prevent illegal copying of video contents.
  3. HDMI is not a "NETWORK" technology. It establishes a one-way point-to-point connection for delivery of uncompressed video to a display.
  4. The connected digital output device controls the HDMI interface so proper set-up of device user settings determines final video appearance.
  5. When using a DVI to HDMI cable, connect the Audio Out L and R cables at the same INPUT (1 or 2) as your HDMI INPUT (1 or 2).

### HDMI input

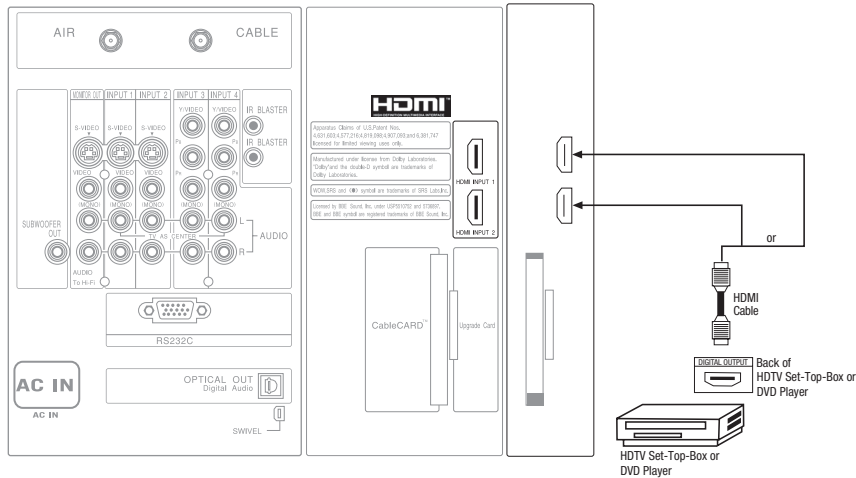

### DVI to HDMI Input

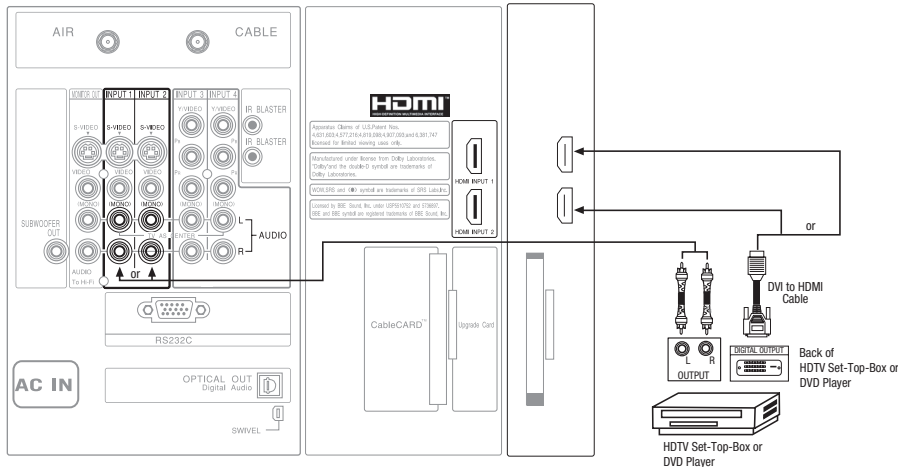

# Connecting External Video Sources

## CONNECTING A COMPONENT AND STEREO AUDIO SOURCE TO INPUT 3 OR 4: Y-PbPr.

1. Connect the cable from the Y OUT of the Laserdisc/DVD player or HDTV set top box to the INPUT (Y) jack, as shown on the Rear panel below.
2. Connect the cable from the Pb/Cb OUT or B-Y OUT of the Laserdisc/DVD player or HDTV set top box to the INPUT (Pb) jack.
3. Connect the cable from the Pr/Cr OUT or R-Y OUT of the Laserdisc/DVD player or HDTV set top box to the INPUT (Pr) jack.
4. Connect the cable from the AUDIO OUT R of the Laserdisc/DVD player or HDTV set top box to the INPUT (AUDIO/R) jack.
5. Connect the cable from the AUDIO OUT L of the Laserdisc/DVD player or HDTV set top box to the INPUT (AUDIO/L) jack.
6. Press the INPUTS button, then select INPUT 4 from the INPUTS menu to view the program from the Laserdisc/DVD player or HDTV set top box.
7. Select CABLE or AIR to return to the last channel tuned.

**NOTE:** 1. Completely insert the connection cord plugs when connecting to rear panel jacks. The picture and sound that is played back will be abnormal if the connection is loose.  
2. See page 15 for tips on REAR PANEL CONNECTIONS.

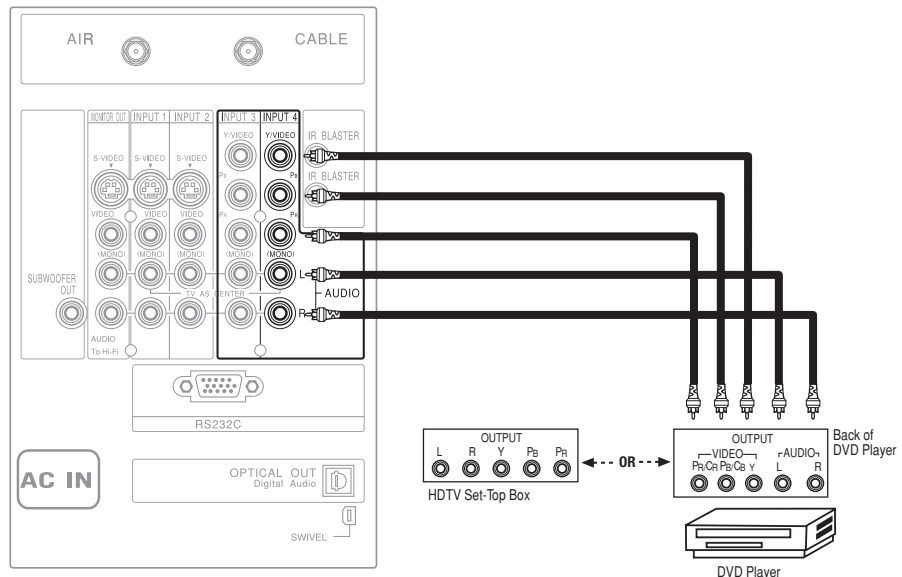

# Connecting External Audio/Video Devices

## CONNECTING A VIDEO AND MANAURAL AUDIO SOURCE TO INPUT 1, INPUT 2 OR INPUT 5

1. Connect the cable from the VIDEO OUT of the VCR or the laserdisc player to the INPUT (VIDEO) jack, as shown on the Rear Panel on the right.
2. Connect the cable from the AUDIO OUT of the VCR or the laserdisc player to the INPUT (MONO)/L(AUDIO) jack.
3. Press the INPUTS button, then select INPUT 2 from the INPUTS menu to view the program from the VCR or the laserdisc player.
4. Select CABLE or AIR from the INPUTS menu to return to the previous channel.

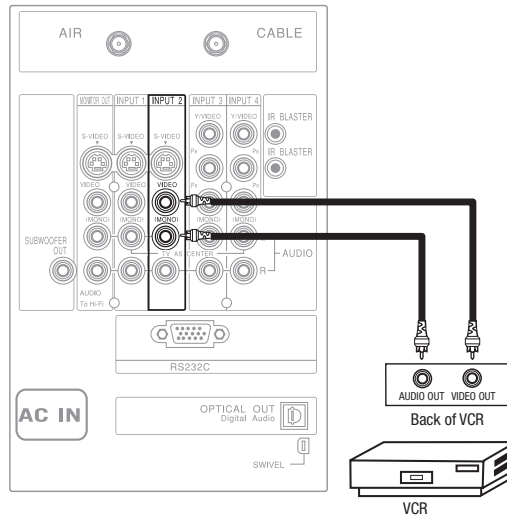

## CONNECTING AN EXTERNAL AUDIO AMPLIFIER

To monitor the audio level of the Plasma TV to an external audio amplifier, connect the system as shown on the right. The "OPTICAL OUT" from the Rear Panel is a fixed output. The Volume of the amplifier is controlled by the amplifier, not by the Plasma Television. The OPTICAL OUT terminal outputs all audio sources with Optical IN capability.

1. Connect an optical cable from the Optical out to the Optical input of a separate Stereo System Amplifier as shown on the Rear Panel on the right.

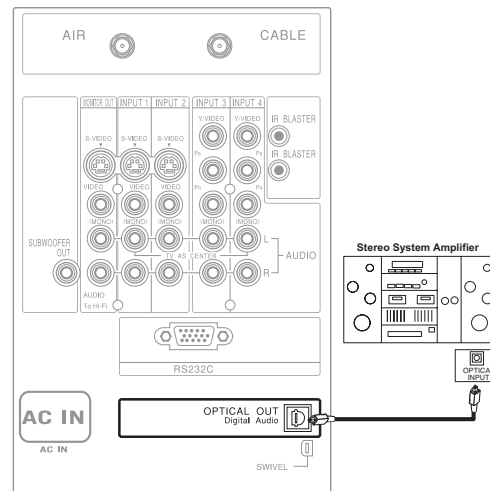

## CONNECTING MONITOR OUT

The MONITOR OUT terminal outputs video and audio of CABLE/AIR and INPUTS 1, 2, 3, 4 and 5. It does not output component video.

1. Connecting S-Video:  
Connect the cable from the S-VIDEO OUT of the Rear Panel to the INPUT (S-VIDEO) jack, of the VCR or Laserdisk player.

### Connecting Video:

Connect the cable from the VIDEO INPUT of the VCR or the laserdisc player to the VIDEO out jack on the TV Rear Panel.

2. Connect the cable from the AUDIO IN R of the VCR or the laserdisc player to the OUTPUT (AUDIO/R) jack on the TV Rear Panel.
3. Connect the cable from the AUDIO IN L of the VCR or the laserdisc player to the OUTPUT (AUDIO/L) jack on the TV Rear Panel.

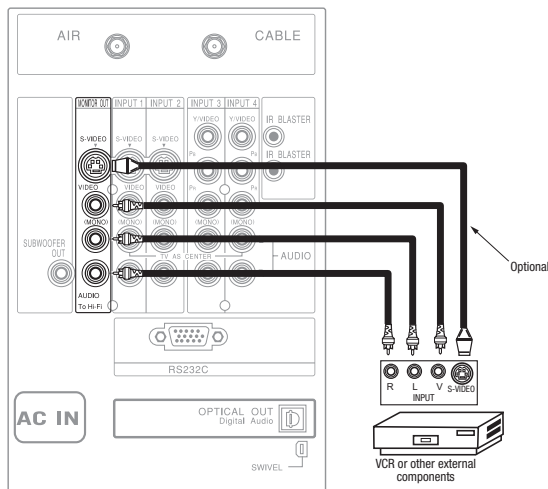

**NOTE:** When making video connections, connect S-Video only or Video only. If both are connected, S-Video takes priority.

## Rear Panel Jacks

Your Hitachi Plasma Television is equipped with an AV Network feature. This feature helps to control your external Audio/Video equipment (VCR, Set Top Box, DVD, etc.). Once this is setup, it allows your IR Mouse connector to control your equipment using your HITACHI Plasma TV Remote Control. You can use your HITACHI remote control to control the Audio/Video equipment command without the equipment's remote control.

The Plasma Television Rear Panel has 2 IR BLASTER jacks. Each IR Mouse cable can connect up to 2 external Audio/Video components. Therefore, you can connect the Plasma Television with up to four components. Please see the following example of an AV Network setup between your Hitachi Plasma Television and external Audio/Video equipment (VCR and DVD Player).

### CONNECTING EXTERNAL AUDIO/VIDEO COMPONENTS TO IR BLASTER FOR AV NETWORK

1. Connect your external Audio/Video components to the Rear Panel shown below.
2. Connect the IR Mouse cable to the IR BLASTER output of the Rear Panel.
3. Place the IR mouse in front of the infrared sensor of the external components you wish to control.

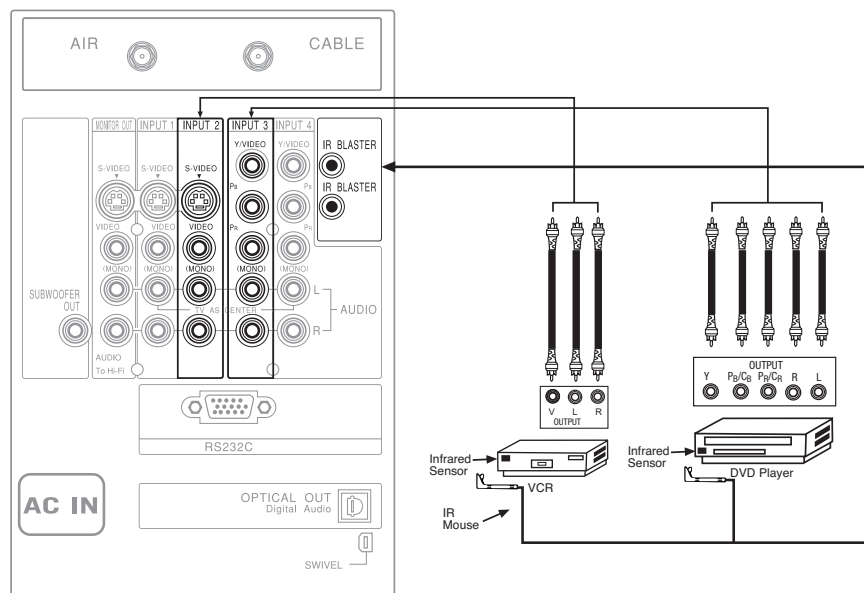

4. ACCESS THE AV NET SETUP WIZARD  
Press the MENU button.
5. Use the CURSOR PAD ▼ or channel scroll down to highlight SETUP.
6. Press the SELECT or CURSOR PAD ► button to select.
7. Use the CURSOR PAD ▼ or channel scroll to highlight the SET AV NET features then press the SELECT button.
8. Follow the Setup procedure on pages 58-67.



- NOTE:**
1. The Rear Panel has two IR BLASTER outputs which can control up to a total of four external components.
  2. The IR Mouse must be placed in front of the external components infrared sensor for the AV Network to work. Double-sided mounting tape may be used to hold the IR Mouse in place.
  3. The correct codes must be chosen for each of the Audio/Video components for the AV Network to function properly.

## The Remote Control

In addition to controlling all the functions on your HITACHI Plasma TV, the new remote control is designed to operate different types of VCRs, CATV (Cable TV) converters, set-top-box, satellite receiver, DVD players, and other audio/video equipment with one touch. Basic operation keys are grouped together in one area.

To operate your Plasma TV, point the remote control at the remote sensor of the Television and select the TV by pressing the ◀ or ▶ button of the Source Access on the remote. The TV mode indicator will blink, indicating that the remote will now control your television.

To operate your VCR, point the remote at the remote sensor of the VCR and select PVR by pressing the ◀ or ▶ button of the Source Access on the remote. The PVR mode indicator will blink, indicating that the remote will now control your VCR (see page 34 for instructions on how to program the remote to control your VCR).

To operate your PVR (Personal Video Recorder), point the remote at the remote sensor of the PVR and select PVR by pressing the ◀ or ▶ button of the Source Access on the remote. The PVR mode indicator will blink, indicating that the remote will now control your PVR (see page 34 for instruction on how to program the remote to control your PVR).

To operate your cable box, point the remote at the remote sensor of the cable box and select the CABLE (CBL) by pressing the ◀ or ▶ button of the Source Access on the remote. The CBL mode indicator will blink, indicating that the remote will now control your cable box (see page 31 for instructions on how to program the remote to control your cable box).

To operate your set-top-box or satellite receiver point the remote at the remote sensor of the set-top-box and select the SET-TOP-BOX (STB) by pressing the ◀ or ▶ button of the Source Access on the remote. If you have a satellite receiver, use this button to program your satellite receiver. The STB mode indicator will blink, indicating that the remote will now control your set-top-box (see page 32 for instructions on how to program the remote to control your set-top-box).

To operate your DVD player, point the remote at the remote sensor of the DVD player and select DVD by pressing the ◀ or ▶ button of the Source Access on the remote. The DVD mode indicator will blink, indicating that the remote will now control your DVD Player (see page 33 for instruction on how to program the remote to control your DVD player).

To operate additional audio equipment, point the remote at the remote sensor of the component you wish to control and select AMP by pressing the ◀ or ▶ button of the Source Access on the remote. The AMP mode indicator will blink, indicating that the remote will now control your audio equipment (see page 35 for instructions on how to program the remote to control additional Audio/Video equipment).

**NOTE:** When you press any remote control button, the buttons will light up. The illumination will light a few seconds during this time. The buttons will appear to light if the room is dark.

There are two modes of lighting the Remote Control buttons. They are the Automatic and Manual modes.

### **AUTOMATIC MODE (Default mode)**

In Automatic mode, if any button is pressed (including the LIGHT button), the illumination will light for 4 seconds.

### **MANUAL MODE (Optional mode)**

In Manual mode, the illumination will only work when the LIGHT button is pressed. When the LIGHT button is pressed, the illumination will light for 8 seconds. During the illumination, if the LIGHT button is pressed, the illumination will turn off.

### **CHANGING LIGHTING MODES (Automatic to Manual/Manual to Automatic)**

1. Place the Remote Control in TV Mode by using the SOURCE ACCESS ◀ and ▶ buttons. The TV mode indicator will blink 3 times to confirm the remote control mode.
2. Press and hold the LIGHT button for 10 seconds. After releasing the LIGHT button, the TV mode indicator will blink 3 times to confirm the mode switch.

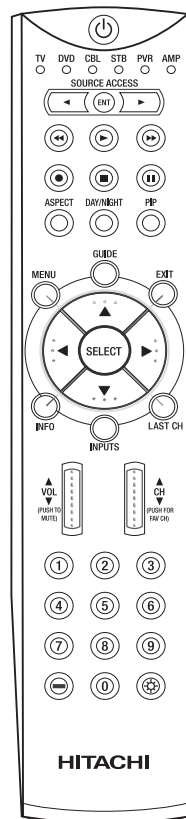

# How to Use the Remote to Control Your TV

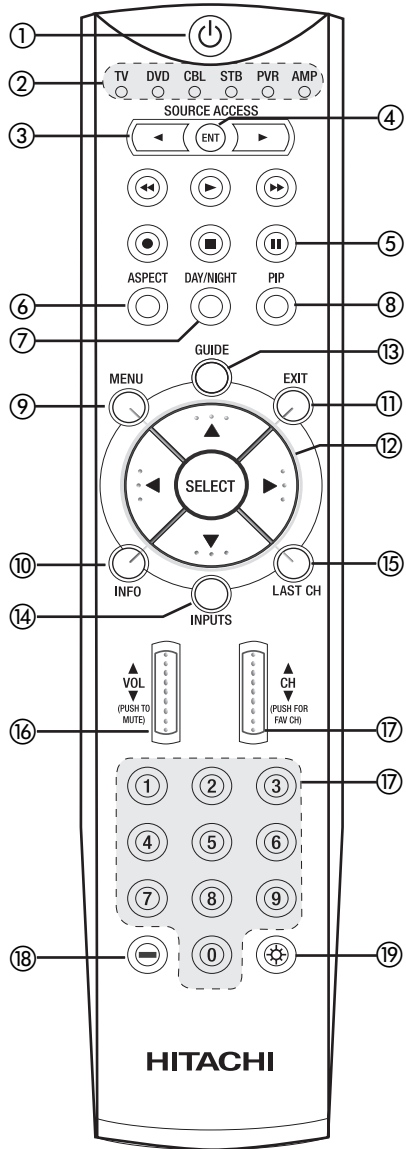

- ① **POWER button**  
Press this button to turn the TV set on or off when the remote is in TV mode. (See page 21 for instructions on how to set the remote control to TV mode.)
- ② **MODE Indicator**  
Turns on or blinks to show remote control mode.
- ③ **SOURCE ACCESS (◀ or ▶) buttons**  
Press these buttons to select remote control mode.
- ④ **SOURCE ACCESS (ENT) button**  
Hold down this button while entering your device code to program the remote (see pages 31-38). You can also use this button in an optional Input access feature (see page 36).
- ⑤ **PAUSE button**  
Press the PAUSE button to freeze the picture. Press the EXIT button to return the picture to motion. Press the PAUSE button repeatedly to cycle through the three different freeze modes (see page 30).

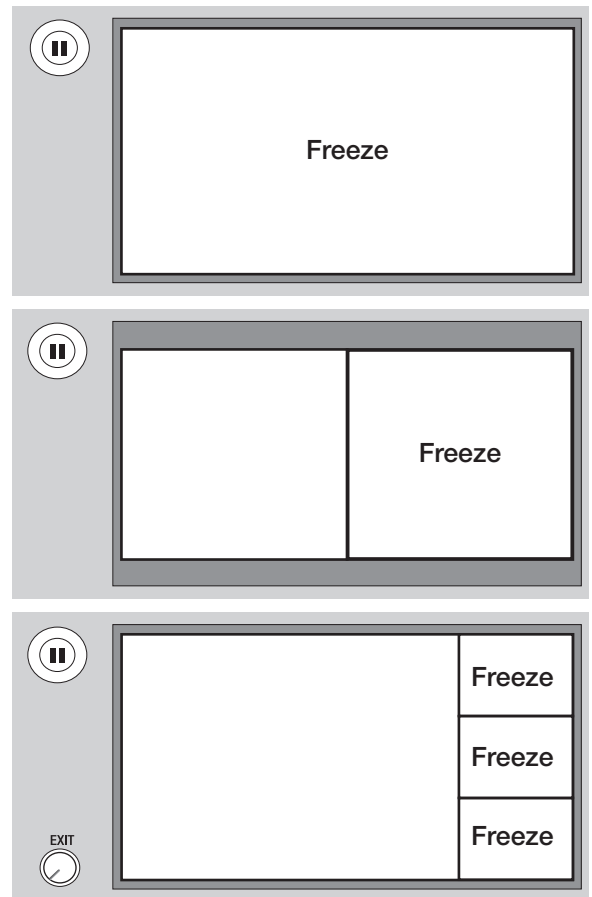

# How to Use the Remote to Control Your TV

## ⑥ ASPECT button

Press this button to quickly change the picture format ASPECT ratio. Depending on the input signal format received, the picture format ratio allows you to adjust the images through the following options.

### 4:3 STANDARD

Use this aspect mode to display conventional (4:3) images. Side panels (gray areas) are placed to the left and right of the image to preserve the original aspect ratio of the source. Note: Use this mode for only 15% of your total viewing time to prevent uneven aging of the phosphors. Phosphors in the lighted area of the picture will age more rapidly than the gray areas.

### 4:3 EXPANDED

Use this aspect mode to display conventional (4:3) sources by linearly increasing image expansion from the center towards the edges of the display area in order to fill it.

### 4:3 ZOOM1/ZOOM2

Use these aspect modes to zoom in on conventional (4:3) sources.

### 16:9 STANDARD

Use this aspect mode to display 16:9 sources like HDTV and DVD's preserving the original 16:9 aspect ratio.

### 16:9 ZOOM

Use this aspect to Zoom-in once while in 16:9 aspect.

- Antenna-Analog
- S-Video/Video Input (Auto Aspect: Off)
- HDMI-480i/480p Input (Auto Aspect: Off)
- Component-480i/480p Input (Auto Aspect: Off)

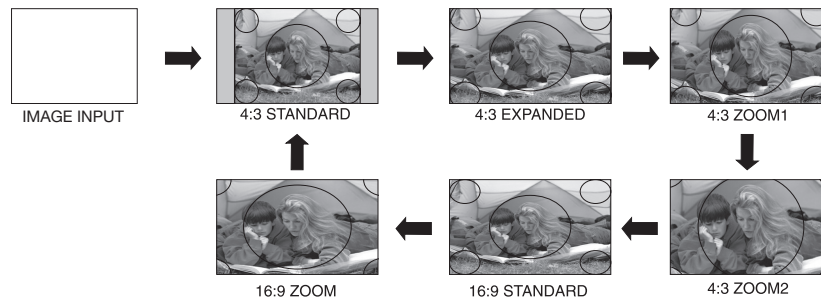

Note: Please see Appendix A on page 80.

- Antenna-Digital (4:3)
- S-Video/Video 4:3/Letter Input (Auto Aspect: On)
- HDMI-480i/480p 4:3/Letter Input (Auto Aspect: On)
- Component-480i/480p 4:3/Letter Input (Auto Aspect: On)

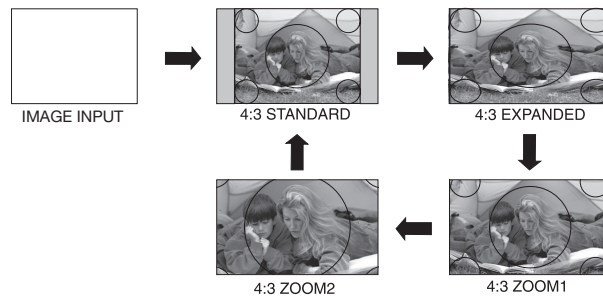

Note: Please see Appendix B on page 80.

- S-Video/Video 16:9 Input (Auto Aspect: On)
- HDMI-480i/480p 16:9 Input (Auto Aspect: On)
- Component-480i/480p 16:9 Input (Auto Aspect: On)

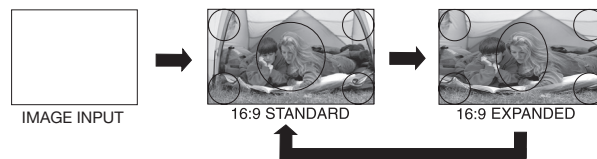

Note: Please see Appendix C on page 80.

- Antenna-Digital (16:9)
- HDMI-720p/1080i Input
- Component-720p/1080i Input

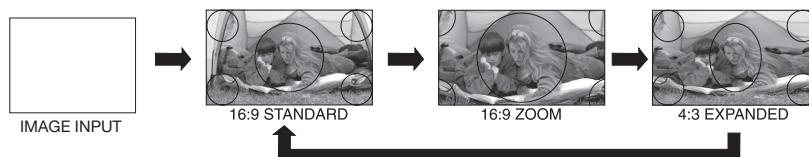

Note: Please see Appendix D on page 80.

**NOTE:** 1. The Aspect Style setting you select for an ANT input will automatically be set for the other ANT input. However, all five video inputs have independent Aspect Style settings.  
2. Vertical position adjustments are directly available when you choose 4:3 EXPANDED/ZOOM1/ZOOM2 or 16:9 ZOOM aspect style (see also page 42).

# How to Use the Remote to Control Your TV

- ⑦ **DAY/NIGHT button**  
Press this button to toggle between Day and Night picture mode settings. Select Day for day time viewing with more brightness and contrast to compete with room light. Select Night for night time viewing with less brightness and contrast for a more detailed picture (see page 41 for settings changes).

**NOTE:** For automatic DAY/NIGHT picture mode settings, see page 54.

- ⑧ **PICTURE-IN-PICTURE button**  
See separate section on pages 28-30 for a description.
- ⑨ **MENU button**  
The MENU button will start the On-Screen Display.
- ⑩ **INFO button**  
Press this button when you want to check the channel being received, the picture source, if the channel has stereo (ST) or second audio program (SAP), the time, CHANNEL ID and if the TIMER is set.

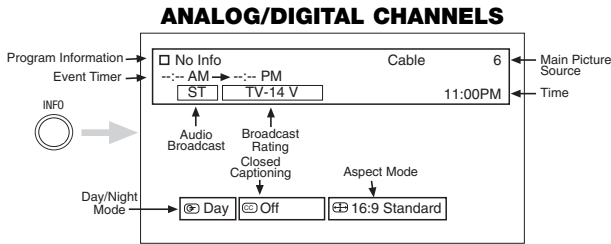

### When an S-VIDEO Input is connected to INPUT 3



### When a Component Video: Y-PbPr Input is connected to INPUT 1

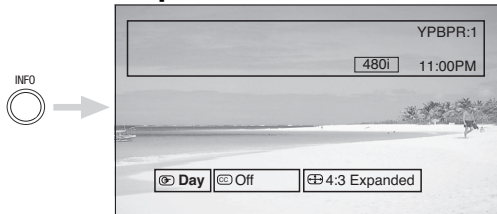

**NOTE:** 1. The Sleep Timer info will show momentarily after releasing INFO button.  
2. The Aspect setting will not be shown if the channel is locked.

- ⑪ **EXIT button**  
This button will exit all On-Screen Displays.

- ⑫ **CURSOR PAD/SELECT button**  
All the On-Screen Display features can be set or adjusted by using the CURSOR PAD, except for numeric entries. The CURSOR PAD will highlight functions or adjust and set different features. Press the CURSOR PAD toward desired direction and press the SELECT button to select.

- ⑬ **GUIDE button [Cable Box (CBL), Satellite Receiver (SAT)/Set-Top-Box (STB) mode only]**  
The use of this button is only applicable when the remote control is in (CBL) and (SAT/STB) mode. Press this button to access the Channel Guide of the (CBL), and (SAT/STB).

- ⑭ **INPUTS button**  
When the remote control is in TV mode, press this button to access the INPUTS menu. Use the CURSOR PAD and SELECT button to select the inputs that are being used. Pressing the INPUTS button repeatedly will also cycle through the Inputs

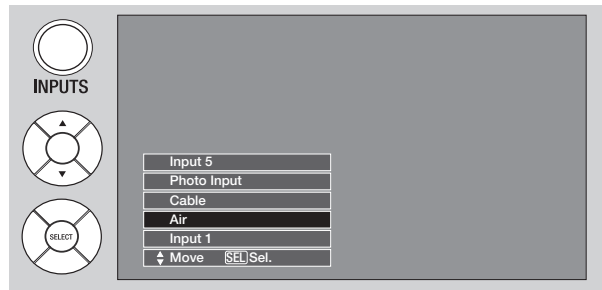

menu items. Then press the SELECT button to select.

- INPUT 1** Select to choose INPUT 1.
- INPUT 2** Select to choose INPUT 2.
- INPUT 3** Select to choose INPUT 3.
- INPUT 4** Select to choose INPUT 4.
- INPUT 5** Select to choose INPUT 5.
- CABLE** Select to choose Cable.
- AIR** Select to choose Air.
- PHOTO INPUT** Select to access your pictures from a digital camera connected to the Photo Input in the side panel of the Plasma TV.



# How to Use the Remote to Control Your TV

## PHOTO INPUT

This feature is useful for viewing digital still pictures from your digital camera, USB Drive or memory cards USB drive using the Photo Input in the left side panel of the TV.

1. Press the INPUTS button to cycle through the INPUTS selections until the PHOTO INPUT is selected. Press the SELECT button or CURSOR PAD ►.

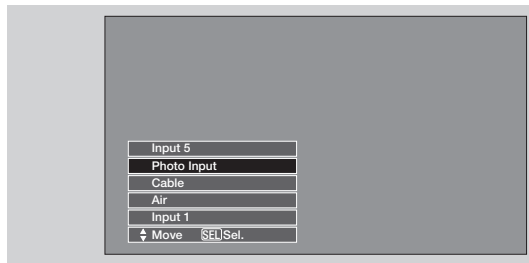

2. Press the CURSOR PAD ◀ or ▶ to access the next or previous photo.



3. Press the SELECT button to view THUMBNAIL.
4. Use the CURSOR PAD buttons ▲, ▼, ◀ or ▶ and the SELECT button to navigate and select individual chosen photos.

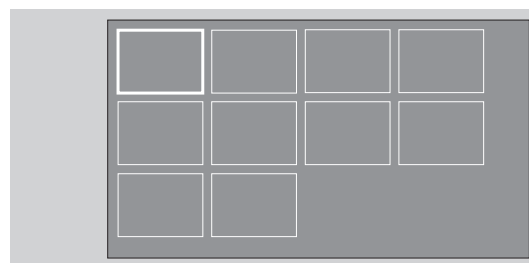

5. Press the picture number to jump from picture to picture.

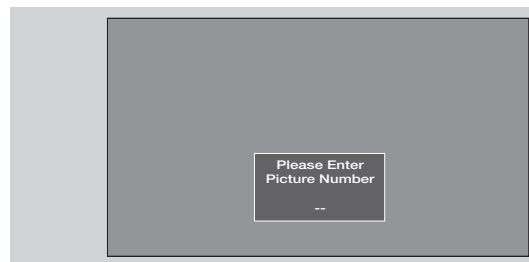

6. Press the INFO button to access PHOTO Input menu and to view Photo information.
7. Press the CURSOR PAD ▲ or ▼ and the SELECT button to navigate and select the PHOTO Input menu.

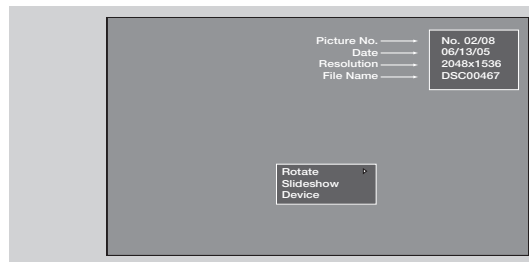

### NOTES:

1. Contrast will decrease automatically if stationary images such as digital still photos are left on the screen for more than 3 minutes.
2. The maximum number of digital Photos that can be displayed is 999.
3. Press INFO button to show Picture Numbers in Thumbnail view, plus other information in individual photos.
4. Digital photos recorded on a DVD-RAM disc may not work with this Photo Input.
5. Certain types of digital cameras may not work with this Photo Input.
6. Digital cameras with low battery power may not properly display your photos in this input.
7. The screen may show "Input device not detected" if the digital camera's large capacity memory is fully loaded, or because of slow access time on some digital cameras. Please wait 1 or 2 minutes before checking your Photo Input connections.

## How to Use the Remote to Control Your TV

### ROTATE

Select this menu item to rotate selected photos either clockwise (CURSOR PAD ►) and counterclockwise (CURSOR PAD ◀).

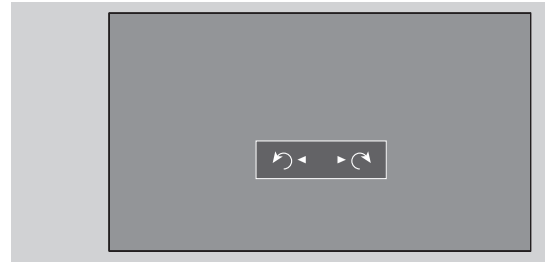

### SLIDESHOW

Select this menu item to start a slideshow of the digital photos. While the Interval sub menu is highlighted, press the SELECT button to cycle through the interval time from 5, 10 and 30 seconds. Press the SELECT button to stop on a chosen picture of the slideshow. After 30 seconds, the slideshow will resume or press the SELECT button again to continue with the slideshow.

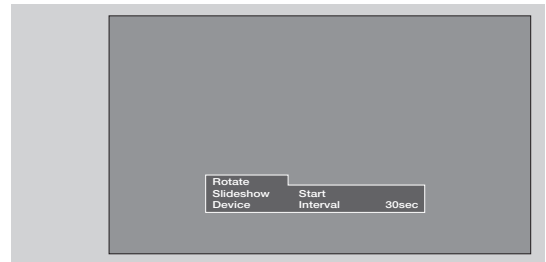

### DEVICE

Select this menu item to select the Photo Input Device Drive. Use the CURSOR PAD ◀ or ► to select Device Drive.

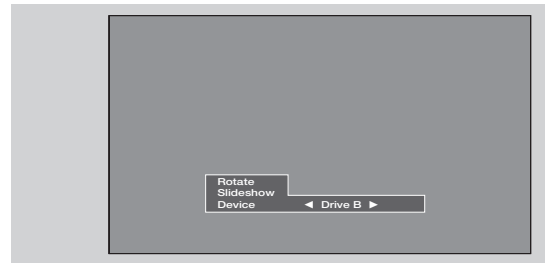

- NOTES:**
1. Automatic contrast reduction also applies during SLIDESHOW, then press any button to continue.
  2. Photo file names modified on a computer should be 8 characters (Ex. ABCD1234.jpg). 1st character: letters; 2nd to 4th: letters or numbers; 5th to 8th: numbers. Photo files should be first placed on a sub directory name with 8 characters (Ex. 123ABCDE). 1st to 3rd: number; 4th to 8th: letters. The sub directory then should be placed on a main directory with a "dcim" file name format.
  3. Supported image types are up to 3072 x 2304; JPEG format should conform with DCF Standard (Design rule for Camera File System).
  4. This TV set displays only digital pictures from digital cameras which meet DCF Standard. Pictures that were copied, edited or modified on a computer may not be displayed on the TV set.

# How to Use the Remote to Control Your TV

- ⑮ **LAST CHANNEL (LAST CH) button**  
Press this button to toggle between the current and last channel viewed.
- ⑯ **VOLUME (VOL) WHEEL, MUTE button**  
Use the VOL WHEEL (▲ or ▼) until you obtain the desired sound level.

To reduce the sound to one half of normal volume (SOFT MUTE) to answer the telephone, etc., press the VOL wheel down. Press the VOL wheel again to turn the sound off completely (MUTE). To restore the sound, press the VOL wheel one more time or VOL Up (▲).

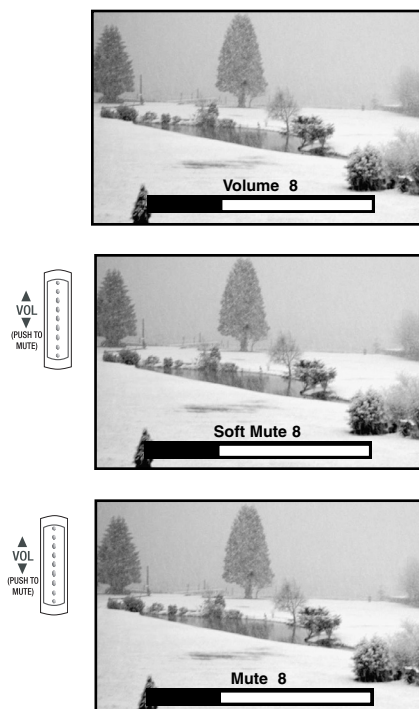

Closed Captioning will display automatically when MUTE/SOFT MUTE is on and Closed Caption is set to AUTO (see page 68).

When the TV power is turned off at a volume level 31 or greater, the volume level will default to 30 when the TV is turned on. However, if it is set to a level 30 or less, the volume level will be at the level it was set when the TV is turned ON.

- ⑰ **CHANNEL (CH) WHEEL/CHANNEL SELECTOR buttons**  
The CHANNEL wheel or the CHANNEL SELECTOR buttons are used to select channels, lock access code, etc. Use the CHANNEL WHEEL (▲ or ▼) to select the desired channel. Use the CHANNEL SELECTOR buttons to enter one, two, or three numbers to select channels. Enter "0" first for channels 1 to 9, or simply press the single digit channel you wish to tune then wait a few seconds for the TV to tune. For Digital Channels, use the CHANNEL SELECTOR buttons with the (-) DASH button. Channel selection may also be performed by CHANNEL WHEEL up (▲) or CHANNEL WHEEL down (▼).

Press the channel (CH) wheel to switch to Favorite (FAV) channel mode. You will know you are in Favorite Channel mode when (FAV) is displayed and the displayed channel is GREEN. Press it again to return to your regular tuned channels. You can add any channel to your Favorite channel list by pressing and holding down the Channel (CH) wheel until the displayed channel turns from WHITE to highlighted GREEN. You can also delete a channel from your favorite channel list by pressing and holding down the Channel (CH) wheel until the displayed channel turns highlighted GREEN to WHITE.

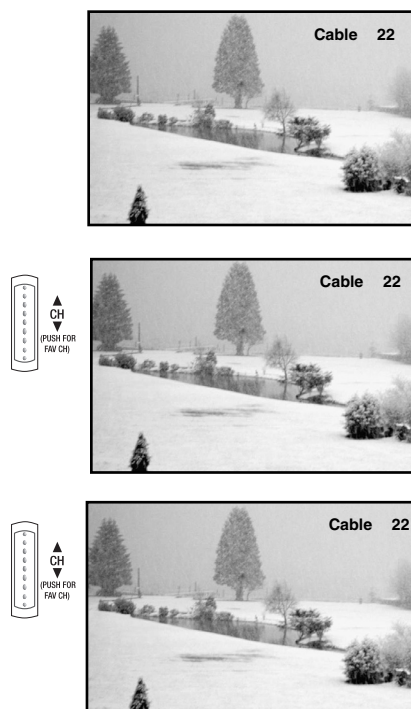

- ⑱ **(-) DASH button**  
Use the (-) DASH button with the CHANNEL SELECTOR buttons to enter Digital Channels that have subchannel numbers indicated by (-) DASH (example 15-1).
- ⑲ **BACKLIGHT button**  
Press this button to light up and illuminate the buttons of the remote control.

# Picture-in-Picture (PIP)

Your HITACHI Plasma TV incorporates Two Tuner technology designed for improved viewing enjoyment. This Two Tuner feature allows you to view antenna inputs on both the main picture and sub picture simultaneously, with separate tuning control for each. When a Digital channel is viewed in the main picture, the Digital channel can not be viewed in the sub picture. And when the Analog channel input is viewed in the main picture, the Analog channel input can not be viewed in the sub picture.

The CABLE and AIR input cannot be viewed in PIP mode at the same time. To select between main picture and PIP sub picture tuning, use the CURSOR PAD button the remote. The Green highlighted channel display will move with every press of the CURSOR PAD buttons.

The Picture-in-Picture feature is convenient when you want to watch more than one program at the same time. You can watch a TV program while viewing other programs from any of the video inputs.

Use connection at right to view VCR program as a sub-picture while viewing another program as main picture (CABLE, AIR).

When installing a CableCARD, connect your coaxial cable to CABLE (see page 12).

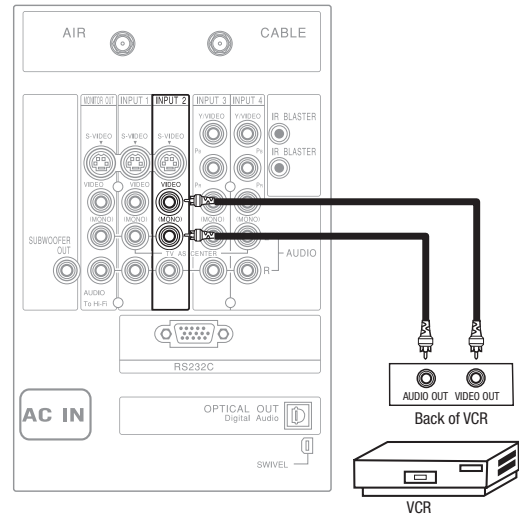

## ① PIP button

Press the PIP button and a sub-picture will appear in one of the four different modes (POP, PIP, SPLIT or SURF), depending on the INPUT signal. To change the PIP mode, use the PIP button to cycle through the four different modes.

### POP MODE PICTURE-IN-PICTURE

POP Mode PIP displays the sub-picture outside of the main picture. Use the CURSOR PAD (▲ or ▼) to move the sub-picture. This feature is not available with a 1080i signal. Please refer to the PICTURE-IN-PICTURE MODES Table (see page 29).

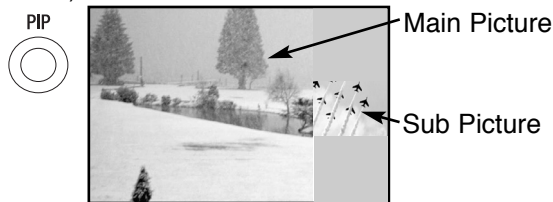

- NOTES:**
1. PIP MODE Picture-in-Picture is only available with a 1080i signal.
  2. Press the CURSOR PAD (◀ or ▶) to enable the sub-picture sound.
  3. Sub-picture channel availability depends on the channel list.

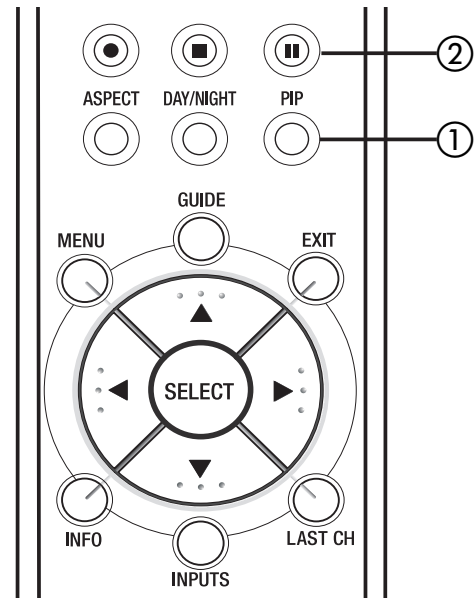

# Picture-In-Picture (PIP)

## PIP MODE PICTURE-IN-PICTURE

Select AIR from the INPUTS menu. Select a channel that has a 1080i signal. To prevent a pattern burn, occasionally move the sub-picture using the CURSOR PAD.



Main Picture

Sub Picture

## SPLIT MODE PICTURE-IN-PICTURE

Split Mode PIP displays the main picture and sub-picture evenly on the screen.



Main Picture

Sub Picture

## SURF MODE PICTURE-IN-PICTURE

Surf Mode PIP automatically scans all active channels (those set in Memory) and displays them as PIP sub-pictures or Thumbnails. Press the SELECT button to stop on a chosen channel. Use the remote CURSOR PAD ▲, ▼, ◀ or ▶ to navigate the Thumbnails. Press the SELECT button to restart channel scan or press the EXIT button to enable your chosen channel and return to normal viewing.



### Picture-in-Picture (PIP) Modes

PIP Mode	Main/ Sub	Aspect	Digital Tuner		1080i/ 720p		480p/480i/ Analog Tuner Video/S-Video	
			16:9	4:3	16:9	16:9	4:3	4:3
POP	ANT Digital	16:9	–	–	–	–	–	–
		4:3	–	–	Yes	Yes	Yes	–
	480p/480i ANT Analog S-Video/Video	16:9	Yes	Yes	–	–	–	–
		4:3	Yes	Yes	–	–	–	–
PIP 4:3	ANT Digital	16:9	–	–	–	Yes	Yes	
		1080i/720p	16:9	–	Yes	–	–	–
	480p/480i S-Video/Video	16:9	–	–	–	–	–	–
		16:9	–	–	Yes	Yes	Yes	–
PIP 16:9	ANT Digital	16:9	–	–	–	–	–	–
		1080i/720p	16:9	Yes	–	–	–	–
	480p/480i S-Video/Video	16:9	–	–	–	–	–	–
		16:9	–	–	Yes	Yes	Yes	–
SPLIT	ANT Digital	16:9	–	–	Yes	Yes	Yes	
		4:3	–	–	Yes	Yes	Yes	
	1080i/720p	16:9	Yes	Yes	–	–	–	
		16:9	Yes	Yes	–	–	–	
	ANT Analog S-Video/Video	4:3	Yes	Yes	–	–	–	
SURF 12 PIX	–	–	Yes	Yes	–	–	Yes <sup>1</sup>	

Yes<sup>1</sup> - Available only in Analog tuner.

# Picture-In-Picture (PIP)

## ② PAUSE button

If you wish to freeze the sub-picture, press the PAUSE button. This is convenient when trying to write down the address for a mail order company, recording statistics for a sporting event, etc. To return the picture to motion, press the EXIT button. Press the PAUSE button repeatedly to toggle between FREEZE modes (Main Freeze, SPLIT and STROBE).

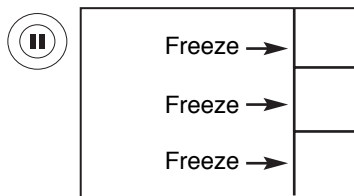

## MAIN FREEZE

Press the PAUSE button to freeze one frame of the picture you are currently viewing and the frozen frame will show in the Main Picture. Press the EXIT button to return to normal viewing. This feature is useful for freezing a picture frame with addresses.



## SPLIT FREEZE

Press the PAUSE button to freeze the picture you are currently viewing (only the right sub-picture will freeze). Press the EXIT button to return to normal viewing.

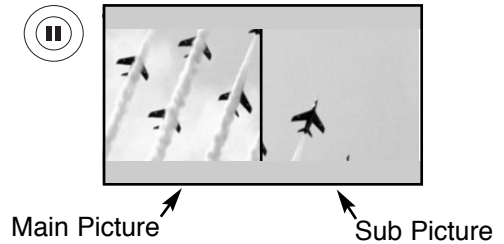

## STROBE FREEZE

Press the PAUSE button to freeze three frames of the picture you are currently viewing (only the 3 sub-pictures will freeze). Press the EXIT button to return to normal viewing. This feature is useful for viewing a moving picture that has many details, for example, a close play in a sporting event or a golf swing.



**NOTE:** 1. The default FREEZE mode is the MAIN freeze followed by the SPLIT freeze and then the STROBE freeze. The last FREEZE mode you selected before you pressed the EXIT button will be the one that comes up after pressing the PAUSE button again.  
2. Each freeze frame in Strobe Freeze is delayed about 0.1 (1/10) second.

# The Remote Control for Cable Box Functions

## Operating the precoded function for your cable box.

This remote is designed to operate different types of cable boxes. You must first program the remote to match the remote system of your cable box (refer to pages 37-38 for pre-codes).

1. Turn ON your cable box.
2. Aim the remote control at the front of your cable box.
3. To switch to Cable (CBL) pre-coded mode, use the SOURCE ACCESS buttons (◀ or ▶) on the remote control to position the LED light to the corresponding selection.
4. Hold down the ENT button on the remote and enter the four digit preset code that matches your cable box as shown on pages 37-38. Release the ENT button. The indicator light will flash 3 times if the code was accepted.
5. Aim the remote at the cable box and press the POWER button. The remote will turn off your cable box when the correct four digit preset code is entered. When this occurs, the remote control is programmed for your cable box. If the cable box does not turn off, try a different four digit preset code.
6. The remote will now control your Cable box.

**NOTE:** 1. If your cable box cannot be operated after performing the above procedures, your cable box code has not been precoded into the remote.  
 2. In the unlikely event that your cable box cannot be operated after performing the above procedures, please consult your cable box operating guide.  
 3. The remote control will remember the codes you have programmed until the batteries are removed from the remote control. After replacing the batteries repeat the entire programming procedure as stated above.

- ① **PRECODED CABLE BOX buttons**  
These buttons transmit the chosen precoded cable codes.
- ② **EXCLUSIVE TV buttons**  
These buttons are for operating the TV.

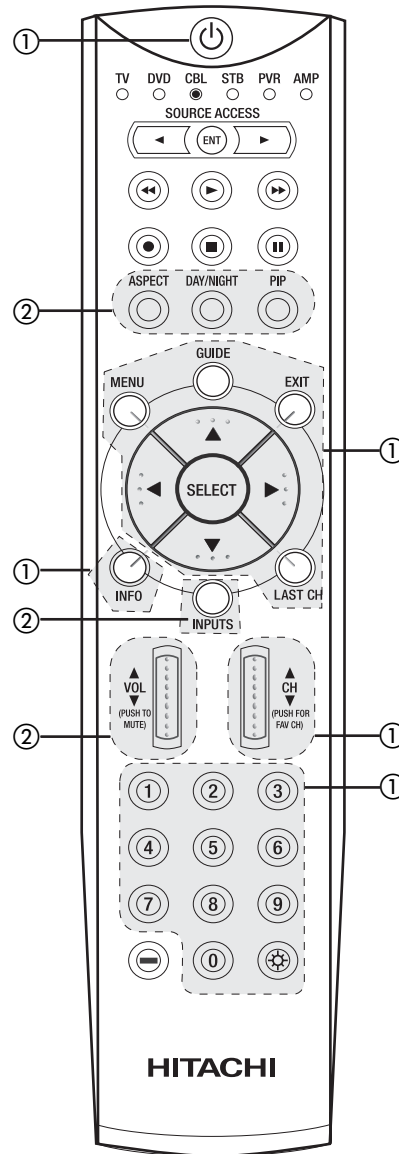

**MY CABLE BOX CODE IS:** \_\_\_\_\_

**NOTE:** Refer to instruction manual of the Cable Box for operation of the buttons exclusively for the Cable Box.

# The Remote Control for Set-Top-Box/Satellite Receiver Functions

## Operating the precoded function for your set-top-box/satellite receiver.

This remote is designed to operate different types of set-top-box/satellite systems. You must first program the remote to match the remote system of your set-top-box/satellite systems (refer to pages 37-38 for pre-codes).

1. Turn ON your set-top-box/satellite systems.
2. Aim the remote control at the front of your set-top-box/satellite systems.
3. To switch to set-top-box/satellite (STB) pre-coded mode, use the SOURCE ACCESS buttons (◀ or ▶) on the remote control to position the LED light to the corresponding selection.
4. Hold down the ENT button on the remote and enter the four digit preset code that matches your set-top-box/satellite receiver as shown on page 37-38. Release the ENT button. The indicator light will flash 3 times if the code was accepted.
5. Aim the remote at the set-top-box/satellite receiver and press the POWER button. The remote will turn off your set-top-box/satellite receiver when the correct four digit preset code is entered. When this occurs, the remote control is programmed for your set-top-box/satellite receiver. If the set-top-box/satellite receiver does not turn off, try a different four digit preset code.
6. The remote will now control your set-top-box/satellite receiver.

- NOTE:**
1. If your set-top-box/satellite receiver cannot be operated after performing the above procedures, your set-top-box/satellite receiver code has not been precoded into the remote.
  2. In the unlikely event that your set-top-box/satellite receiver cannot be operated after performing the above procedures, please consult your set-top-box/satellite receiver operating guide.
  3. The remote control will remember the codes you have programmed until the batteries are removed from the from the remote control. After replacing the batteries repeat the entire programming procedure as stated above.

- ① **PRE-CODED SET-TOP-BOX/SATELLITE RECEIVER buttons**  
These buttons transmit the chosen pre-coded set-top-box/satellite codes.
- ② **EXCLUSIVE TV buttons**  
These buttons are for operating the TV.

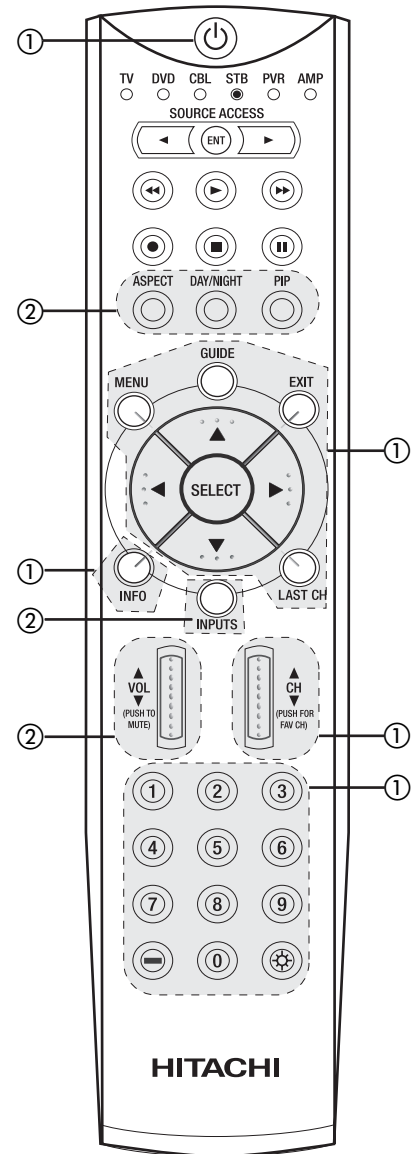

**MY Satellite RECEIVER/  
SET-TOP-BOX CODE IS:** \_\_\_\_\_

**NOTE:** Refer to instruction manual of the Set-Top-Box/Satellite Receiver for operation of the buttons exclusively for the Set-Top-Box/Satellite Receiver.



# The Remote Control for DVD Functions

## Operating the precoded function for your DVD player.

This remote is designed to operate different types of DVD players. You must first program the remote to match the remote system of your DVD player (refer to pages 37-38 for pre-codes).

1. Turn ON your DVD player.
2. Aim the remote control at the front of your DVD player.
3. To switch to DVD pre-coded mode, use the SOURCE ACCESS buttons (◀ or ▶) on the remote control to position the LED light to the corresponding selection.
4. Hold down the ENT button on the remote and enter the four digit preset code that matches your DVD player, as shown on pages 37-38. Release the ENT button. The indicator light will flash 3 times if the code was accepted.
5. Aim the remote at the DVD player and press the POWER button. The remote will turn off your DVD player when the correct four digit preset code is entered. When this occurs, the remote control is programmed for your DVD player. If the DVD player does not turn off, try a different four digit preset code.
6. The remote will now control your DVD player.
7. You will need to set the display type of your DVD player to 16:9 widescreen.

**NOTE:** 1. If your DVD player cannot be operated after performing the above procedures, your DVD player code has not been precoded into the remote.  
 2. In the unlikely event that your DVD player cannot be operated after performing the above procedures, please consult your DVD player operating guide.  
 3. The remote control will remember the codes you have programmed until the batteries are removed from the remote control. After replacing the batteries repeat the entire programming procedure as stated above.

- ① **PRECODED DVD Buttons**  
These buttons transmit the chosen precoded DVD codes.
- ② **EXCLUSIVE TV Buttons**  
These buttons are for operating the TV.

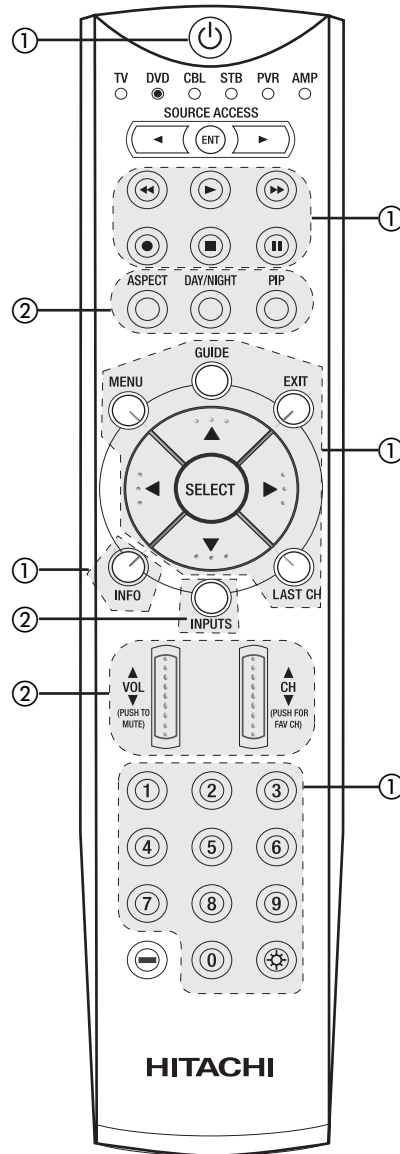

**MY DVD PLAYER CODE IS:** \_\_\_\_\_

**NOTE:** Refer to instruction manual of the DVD Player for operation of the buttons exclusively for the DVD Player.

# The Remote for VCR/PVR Functions

## Operating the precoded function for your VCR/PVR (Personal Video Recorder).

This remote is designed to operate different types of VCRs/PVRs. You must first program the remote to match the remote system of your VCR/PVR (refer to pages 37-38 for pre-codes).

1. Turn ON your VCR/PVR.
2. Aim the remote control at the front of your VCR/PVR.
3. To switch to VCR/PVR pre-coded mode, use the SOURCE ACCESS buttons (◀, ▶) on the remote control to position the LED light to the corresponding selection.
4. Hold down the ENT button on the remote and enter the four digit preset code that matches your VCR/PVR, as shown on pages 37-38. Release the ENT button. The indicator light will flash 3 times if the code was accepted.
5. Aim the remote at the VCR/PVR and press the POWER button. The remote will turn off your PVR when the correct four digit preset code is entered. When this occurs, the remote control is programmed for your VCR/PVR. If the VCR/PVR does not turn off, try a different four digit preset code.
6. The remote will now control your VCR/PVR.

- NOTE:**
1. If your VCR/PVR cannot be operated after performing the above procedures, your VCR/PVR code has not been precoded into the remote.
  2. In the unlikely event that your VCR/PVR cannot be operated after performing the above procedures, please consult your VCR/PVR operating guide.
  3. The remote control will remember the codes you have programmed until the batteries are removed from the remote control. After replacing the batteries repeat the entire programming procedure as stated above.

- ① **PRECODED VCR/PVR Buttons**  
These buttons transmit the chosen precoded VCR/PVR codes.
- ② **EXCLUSIVE TV Buttons**  
These buttons are for operating the TV.

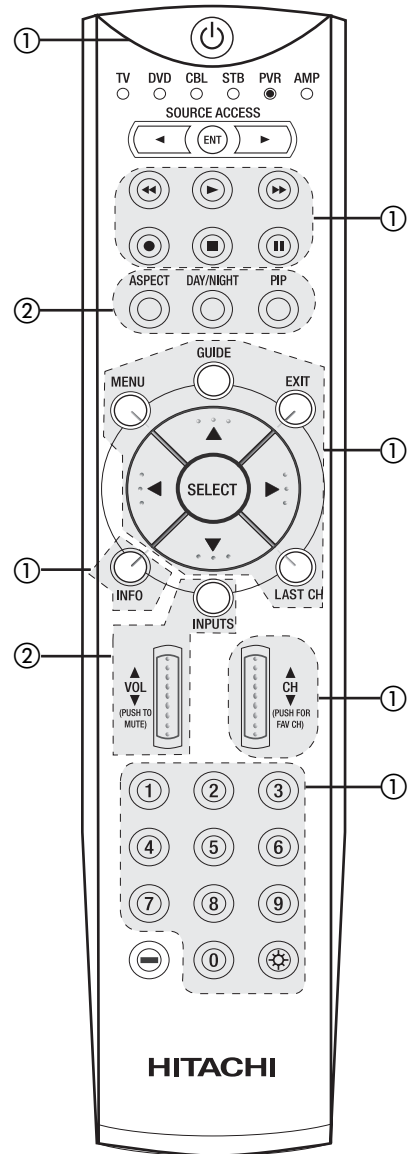

**MY VCR/PVR CODE IS:** \_\_\_\_\_

**NOTE:** Refer to instruction manual of the VCR/PVR for operation of the buttons exclusively for the VCR/PVR.

# The Remote Control for Additional Audio Equipment

## Operating the precoded function for your Audio component.

This remote is designed to operate different types of Audio component. You must first program the remote to match the remote system of your Audio component (refer to pages 37-38 for pre-codes).

1. Turn ON your Audio component you wish to control with the Remote.
2. Aim the remote control at the front of your Audio component.
3. To switch to Audio (AMP) component pre-coded mode, use the SOURCE ACCESS buttons (◀ or ▶) on the remote control to position the LED light to the corresponding selection.
4. Hold down the ENT button on the remote and enter the four digit preset code that matches your Audio component, as shown on pages 37-38. Release the ENT button. The indicator light will flash 3 times if the code was accepted.
5. Aim the remote at the Audio component and press the POWER button. The remote will turn off your Audio component when the correct four digit preset code is entered. When this occurs, the remote control is programmed for your Audio component. If the Audio component does not turn off, try a different four digit preset code.
6. The remote will now control your Audio component.
7. Repeat steps 1 - 6 if you wish to program the remote to control another Audio component.

**NOTE:** 1. If your Audio component cannot be operated after performing the above procedures, your Audio component code has not been precoded into the remote.  
 2. In the unlikely event that your Audio component cannot be operated after performing the above procedures, please consult your Audio component operating guide.  
 3. The remote control will remember the codes you have programmed until the batteries are removed from the remote control. After replacing the batteries repeat the entire programming procedure as stated above.

- ① **PRECODED AUDIO Buttons**  
These buttons transmit the chosen precoded Audio component codes.
- ② **EXCLUSIVE TV Buttons**  
These buttons are for operating the TV.

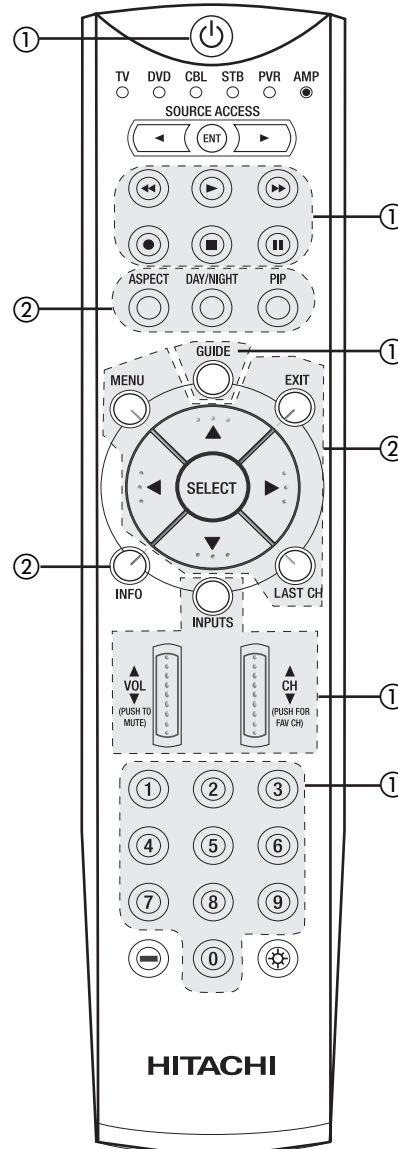

**MY AUDIO COMPONENT CODE IS:** \_\_\_\_\_

**NOTE:** Refer to instruction manual of the VCR/PVR for operation of the buttons exclusively for the VCR/PVR.

# How to Use the ENT Button

## INPUT ACCESS

This optional feature allows the user of the remote control to setup its ENTER (ENT) button to access the specified input of the TV. Setup for this feature is applicable to the remote control's normal mode only and only applies to the DVD, CBL, STB, PVR and AMP modes.

1. Select the desired device mode (DVD, CBL, STB, PVR, or AMP) by using your SOURCE ACCESS buttons (◀ or ▶) to position the LED indicator to the corresponding selection.
2. Hold down the ENTER (ENT) button and enter the four digit preset code that matches your device as shown on pages 37-38.
3. Then enter the assigned input number (1-5) that the device is related to.
4. Release ENTER (ENT) button.
5. If done correctly, the device LED indicator will flash 3 times to confirm proper setup.
6. The remote will now control the desired device.
7. Pressing the ENTER (ENT) button will now access the video input (1-5) of the desired device.

## SETUP EXAMPLE (Hitachi DVD with precode 0573 connected to INPUT 1 of the TV)

- ① Select DVD mode by using your SOURCE ACCESS buttons (◀ or ▶) to position the LED indicator to DVD.
- ② Hold down the ENTER (ENT) button and press the numbers 0, 5, 7 and 3.
- ③ Then press the number 1 for the assigned input number of the DVD player.
- ④ Release ENTER (ENT) button.
- ⑤ If done correctly, the device LED indicator will flash 3 times to confirm proper setup.
- ⑥ The remote will now control the DVD player.
- ⑦ Press the ENTER (ENT) button to instantly access the video input of your DVD on Input 1.

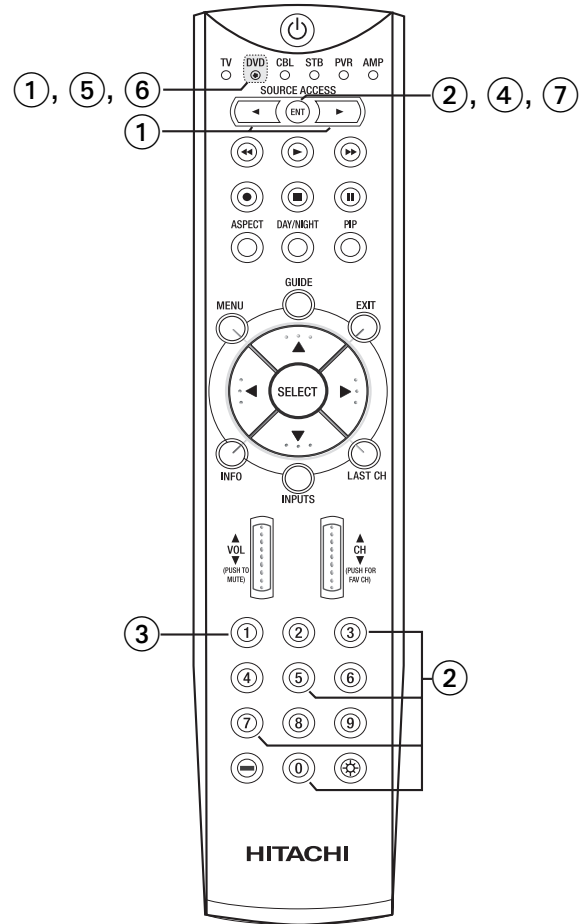

**NOTE:** 1. This feature is optional  
2. Assigned input numbers can be used more than once if applicable.

# Remote Control Codes

**VCR BRAND .....CODE**  
 ABS .....1972  
 Admiral .....0048, 0209  
 Adventura .....0000  
 Aiko .....0278  
 Aiwa .....0000, 0037, 0307  
 Akai .....0041, 0061, 0106  
 Alienware .....1972  
 America Action .....0278  
 American High .....0035  
 Asha .....0240  
 Audiovox .....0037, 0278  
 Beaumark .....0240  
 Bell & Howell .....0104  
 Broksonic .....0121, 0184,  
 .....0002, 0209, 0479  
 CCE .....0072, 0278  
 Calix .....0037  
 Canon .....0035  
 Carver .....0081  
 Cinerall .....0278  
 Citizen .....0278, 0037  
 Colt .....0072  
 Craig .....0037, 0072,  
 .....0047, 0240, 0271  
 Curtis Mathes .....0035, 0041,  
 .....0060, 0162  
 CyberPower .....1972  
 Cybernex .....0240  
 Daewoo .....0278, 0045, 0561  
 Dell .....1972  
 Denon .....0042  
 Durabrand .....0039, 0038  
 Dynatech .....0000  
 Electrohome .....0037  
 Electrophonic .....0037  
 Emerex .....0032  
 Emerson0037, 0184, 000, 0121,  
 0043, 0209, 0002, 0278, 0061,  
 ..0208, 0212, 0479, 0561, 1593  
 Fisher .....0104, 0047, 0066  
 Fuji .....0033, 0035  
 Funai .....0000, 1593  
 GE .....0035, 0060, 0240,  
 .....0202, 0761  
 Garrard .....0000  
 Gateway .....1972  
 Go Video .....0432, 0526  
 GoldStar .....0037, 0038  
 Gradiente .....0000, 0008  
 HI-Q .....0047  
 HP .....1972  
 Harley Davidson .....0000  
 Harman/Kardon .....0038, 0081  
 Harwood .....0072  
 Headquarter .....0046  
 Hewlett Packard .....1972  
 Hitachi 0000, 0041, 0042, 0105  
 Howard Computers .....1972  
 Hughes Network Systems 0042  
 iBuy Power .....1972  
 JVC .....0067, 0041, 0008  
 Jensen .....0041  
 KEC .....0037, 0278  
 KLH .....0072  
 Kenwood .....0041, 0067, 0038  
 Kodak .....0035, 0037  
 LG .....0037  
 LXI .....0037  
 Lloyd's .....0000, 0208  
 Logik .....0072  
 MEI .....0035  
 MGA .....0043, 0240, 0061  
 MGN Technology .....0240  
 MTC .....0000, 0240  
 Magnasonic .....0593  
 Magnavox .....0035, 0081, 0563,  
 0000, 0039, 0593  
 Magnin .....0240  
 Marantz .....0081, 0035

Marta .....0037  
 Matsushita .....0035, 0162, 1162  
 Media Center PC .....1972  
 Memorex .....0035, 0162, 0037,  
 .....0048, 0039, 0047, 0240,  
 .....0000, 0104, 0209, 0046,  
 ..0307, 0479, 1037, 1162, 1262  
 Microsoft .....1972  
 Mind .....1972  
 Minolta .....0042, 0105  
 Mitsubishi .....0061, 0043, 0067  
 Motorola .....0035, 0048  
 Multitech .....0000, 0072  
 NEC .....0038, 0041, 0067, 0104  
 Nikko .....0037  
 Noblex .....0240  
 Northgate .....1972  
 Olympus .....0035  
 Optimus .....0593, 1062, 0162,  
 .....0037, 0048, 0104, 0432,  
 .....1048, 1162, 1262  
 Optonica .....0062  
 Orion .....0184, 0209, 0002, 0479  
 Panasonic .....0162, 1062, 0035,  
 .....0616, 1162, 1262  
 Penney0035, 0037, 0240, 0042,  
 .....0038  
 Pentax .....0042, 0105  
 Philco .....0035, 0209, 0479, 0561  
 Philips .....0081, 0035, 0618,  
 .....1081, 1181, 0062  
 Pilot .....0037  
 Pioneer .....0067  
 Polk Audio .....0081  
 Profifronic .....0240  
 Proscan .....0060, 0202, 0761  
 Protec .....0072  
 Pulsar .....0039  
 Quarter .....0046  
 Quartz .....0046  
 Quasar .....0035, 0162, 1162  
 RCA .....0060, 0240, 0042, 0105,  
 .....0106, 0202, 0761, 0880  
 Radio Shack .....0000, 1037  
 Radix .....0037  
 Randex .....0037  
 Realistic .....0035, 0037, 0048,  
 .....0047, 0000, 0104, 0046,  
 .....0062, 0066  
 ReplayTV .....0614, 0616  
 Runco .....0039  
 STS .....0042  
 Samsung .....0045, 0240, 0432  
 Sanky .....0039, 0048  
 Sansui .....0000, 0067, 0209,  
 .....0041, 0479, 1479, 0271  
 Sanyo .....0047, 0240, 0104, 0046  
 Scott .....0184, 0045, 0121,  
 .....0043, 0210, 0212  
 Sears .....0035, 0037, 0047, 0000,  
 0042, 0104, 1237, 0046, 0066,  
 .....0105  
 Semp .....0045  
 Sharp .....0048, 0848, 0062  
 Shintom .....0072  
 Shogun .....0240  
 Singer .....0072  
 Sonic Blue .....0614, 0616  
 Sony .....0035, 0032, 0000,  
 .....0033, 0636, 1032, 1972  
 Sylvania .....0035, 0081, 0000,  
 .....0043, 0593, 1593  
 Symphonic .....0000, 0593, 1593  
 Systemax .....1972  
 TMK .....0240, 0208  
 Tagar Systems .....1972  
 Tattung .....0041  
 Teac .....0000, 0041  
 Technics .....0035, 0162  
 Teknika .....0000, 0035, 0037

Thomas .....0000  
 Tivo .....0618, 0636, 1503  
 Toshiba .....0045, 0043, 0066,  
 .....0210, 0212, 0366, 0845,  
 .....1008, 1145, 1503, 1972  
 Totevision .....0037, 0240  
 Touch .....1972  
 Unitech .....0240  
 Vector .....0045  
 Vector Research .....0038  
 Video Concepts .....0045, 0061  
 Videomagic .....0037  
 Videosonic .....0240  
 Viewsonic .....1972  
 Wards 0060, 0062, 0035, 0048,  
 .....0047, 0081, 0240, 0000,  
 .....0042, 0072, 0212  
 White Westinghouse .....  
 .....0072, 0209  
 XR-1000 .....0072, 0000, 0035  
 Yamaha .....0038  
 ZT Group .....1972  
 Zenith 0039, 0000, 0209, 0033,  
 .....0479, 1479

**DVD BRAND .....CODE**  
 AMW .....0872  
 Aiwa .....0641  
 Allegro .....0869  
 Apex Digital ..0672, 0717, 0755,  
 0794, 0796, 0797, 1004, 1020,  
 ..1056, 1061, 1100, 1915, 1937  
 Audiovox .....0790, 1072  
 Axion .....1072  
 Blaupunkt .....0717  
 Blue Parade .....0571  
 Brooksonic .....0695  
 CAVS .....1057  
 CineVision .....0876, 0869  
 Classic .....1917  
 Coby .....1086  
 Curtis Mathes .....1087  
 CyberHome ..0816, 1023, 1024  
 DVD2000 .....0521  
 Daewoo .....0784, 0705,  
 .....0833, 0869, 1918  
 Denon .....0490, 0634  
 Dual .....1068, 1085  
 Emerson .....0591, 0675  
 Enterprise .....0591  
 Fisher .....0670  
 Funai .....0675  
 GE .....0522, 0717, 0815  
 GPX .....0699, 0769  
 Gateway .....1073  
 Go Video .....0744, 0715, 0783,  
 .....0833, 0869, 1075  
 Gradiente .....0651  
 Greenhill .....0717  
 Grundig .....0705  
 Harman/Kardon .....0702  
 Hitachi .....0573, 0664, 0695  
 Hiteker .....0672  
 IRT .....0783  
 Initial .....0717  
 Integra .....0627  
 Hiteker .....0672  
 JBL .....0702  
 JVC .....0623, 0558, 0867, 1901  
 KLH .....0717, 0790, 1020  
 Kawasaki .....0790  
 Kenwood .....0490, 0534  
 Koss .....0651  
 Lasonic .....0798  
 Lite-On .....1058  
 Magnavox .....0503, 0675,  
 .....1914, 1976  
 Marantz .....0539  
 Memorex .....0695  
 Microsoft .....0522

Mintek .....0717, 0839  
 Mitsubishi .....0521, 1521  
 Nesa .....0717  
 Norcent .....1003, 0872  
 Onkyo .....0627, 0503  
 Oritron .....0651  
 Panasonic .....0490  
 Philco .....0790  
 Philips..0503, 0539, 0646, 0854  
 Pioneer .....0525, 0571, 1902  
 Polaroid .....1061, 1086  
 Polk Audio .....0539  
 Proscan .....0522  
 Qwestar .....0651  
 RCA .....0522, 0571, 0717,  
 .....0790, 0822, 1974  
 Recco .....0698  
 Rio .....0869  
 Rotel .....0623  
 Rowa .....0823  
 Sampo .....0698, 0752  
 Samsung .....0490, 0573,  
 .....0820, 0744, 1075  
 Sansui .....0695  
 Sanyo .....0670, 0695, 0873  
 Semp .....0503  
 Sharp .....0630, 0752  
 Shinsonic .....0533, 0839  
 Sonic Blue .....0869  
 Sony .....0533  
 Sylvania .....0675  
 Symphonic .....0675  
 TYT .....0705  
 Teac .....0790  
 Technics .....0490  
 Theta Digital .....0571  
 Tivo .....1996  
 Toshiba .....0503, 0695, 1045,  
 .....1988, 1996, 2006  
 Tredex .....0799, 0803  
 US Logic .....0839  
 Urban Concepts .....0503  
 Venturer .....0790  
 XBox .....0522  
 Yamaha .....0490, 0545, 0539  
 Zenith .....0591, 0503, 0869

**CABLE BRAND.....CODE**  
 ABC .....0003, 0008, 0011, 0013,  
 .....0014, 0017  
 Allegro .....0153, 0315  
 Americast .....0899  
 Antronix .....022  
 Archer .....022, 0153, 0797  
 Bell & Howel .....0014  
 Bell South .....0899  
 Cabletenna .....0022  
 Cableview .....0022  
 Century .....0153  
 Citizen .....0153, 0315  
 ClearMax .....0883  
 Clearmaster .....0883  
 Colour Voice .....0025, 0031  
 Comtronics .....0040  
 Contec .....0019  
 Coolmax .....0883  
 Digi .....0637  
 Director .....0476  
 Dumont .....0637  
 Emerson .....0797  
 Everquest .....0015, 0040  
 Focus .....0400  
 Garrard .....0153  
 Gemini .....0015, 0797  
 General Instrument 0003, 0011,  
 .....0476, 0276, 0810  
 GoldStar .....0040, 0144  
 Goodmind .....0797  
 Hamlin 0009, 0020, 0034, 0273  
 Hitachi .....0011

# Remote Control Codes

Jasco .....0015, 0153, 0315  
 Jerrold ..... 0003, 0011, 0012,  
 0014, 0015, 0024, 0276, 0476,  
 .....0810  
 Memorex .....0000  
 Motorola ..... 0276, 0476, 0810,  
 .....1106, 1254, 1376  
 Movie Time .....0063  
 Multivision.....0012  
 NSC .....0063  
 Novaplex.....0618  
 Oak .....0019  
 Optimus .....0021  
 Pace .....0237, 1877  
 Panasonic.....0000, 0021, 0107  
 Panther .....0637  
 Paragon .....0000  
 Philips.....0305, 0317  
 Pioneer0023, 0025, 0031, 0153,  
 .....0144, 0533, 0877, 1877  
 Popular Mechanics.....0400  
 Pulsar .....0000  
 Quasar .....0000  
 RCA .....0021  
 RadioShack..0015, 0315, 0797,  
 .....0883  
 Recoton .....0400  
 Regal .....0020, 0273, 0279  
 Rembrandt .....0011  
 Runco .....0000  
 SL Marx .....0040  
 Samsung .....0040, 0144  
 Scientific Atlanta .....0877, 0008,  
 .....0017, 0477, 1877  
 Signal .....0015, 0040  
 Signature .....0011  
 Sony .....1006  
 Sprucer .....0021  
 Starcom .....0003, 0015  
 Stargate .....0015, 0040, 0797  
 Starquest .....0015  
 Supercable .....0276  
 Supermax .....0883  
 TFC.....0310  
 TV86 .....0063  
 Tandy .....0258  
 TeleCaption.....0221  
 Television .....0040  
 Timeless.....0040  
 Tocom .....0012, 0013  
 Torx .....0003  
 Toshiba .....0000  
 Tristar .....0883  
 Tusa .....0015  
 Unika .....0022, 0153  
 Universal .....0022, 0153, 0191  
 V2 .....0883  
 ViewMaster .....0883  
 Viewstar .....0063, 0258  
 Vision .....0883  
 Vortex View.....0883  
 Zenith ..0000, 0054, 0525, 0899  
 Zentek .....0400

**SATELLITE BRAND (Set-Top-Box) .....CODE**  
 AlphaStar .....0772  
 Amway .....0043, 0075  
 Astro Industries.....0095  
 BSR .....0095  
 Cable Innovations.....0554  
 Capetronic .....0095  
 Century .....0856  
 Channel Master .....0018, 0212  
 Chapparral ...0053, 0209, 0216  
 Conifer .....0004  
 Crossdigital .....1109  
 Curtis Mathes .....061  
 DX Antenna .....0041  
 DirecTV .....0392, 0566, 0639,

.....1639, 1142, 0247, 0749,  
 .....1749, 0724, 0819, 1856,  
 .....1076, 1109, 0099, 1052,  
 ..1053, 1054, 1442, 1443, 1444  
 Dish Network System .....1005,  
 0775, 1170  
 DishPro.....1005, 0775  
 Drake .....0018, 0064, 0245  
 Echostar .....1005, 0775, 0148,  
 .....0269, 0280, 1170  
 Expressvu .....0775  
 GE .....0566  
 GOI .....0775  
 General Instrument .....0869,  
 .....0547, 0554  
 Gradiente .....0856  
 HTS .....0775  
 Hitachi.....0819  
 homecable .....0238  
 Hughes Network Systems 1142,  
 ..0749, 1749, 1442, 1443, 1444  
 HYTEK .....0095  
 IQ .....0210  
 IQ Prism .....0210  
 Innova .....0099  
 Intersat .....0043  
 JVC .....0775, 1170  
 Janell .....0152  
 Legend .....0269  
 Macom .....0018, 0061  
 Magnavox.....0724, 0722  
 Memorex .....0724, 0269  
 Mitsubishi .....0749  
 Motorola .....0869  
 Netsat .....0099  
 Next Level.....0869  
 Norsat .....0004  
 Pace .....0455  
 Panasonic.....0247, 0701, 0152  
 Paysat.....0724  
 Philips 1142, 0749, 0724, 1076,  
 .....0722, 1749, 0856, 0099  
 Pico.....0075  
 Proscan .....0392, 0566  
 RCA ...0392, 0566, 0855, 0143  
 Radioshack.....0869, 0554  
 Ramsey .....0075  
 Realistic .....0052  
 SKY .....0856, 1856, 0099  
 STS.....0041, 0210  
 Samsung.....1276, 1109  
 Sony .....0639, 1639  
 Star Choice.....0869  
 Star Trak.....0180, 0421, 0547  
 Strong .....0421  
 Tivo.....1142, 1442, 1443, 1444  
 Toshiba .....0749, 1749, 0790,  
 .....0061, 0082, 1052, 1053,  
 ..1054, 1285, 1286, 1287, 1289  
 Town & Country .....0547  
 Uniden0724, 0722, 0052, 0074,  
 .....0076, 0238, 0370, 0554  
 Zenith ..0856, 1856, 0061, 0064

**AMPLIFIER BRAND .....CODE**  
 Aiwa .....0406  
 Bose .....0674  
 Carver .....0269  
 Curtis Mathes .....0300  
 Denon .....0160  
 Durabrand.....1561  
 GE .....0078  
 Harman/Kardon .....0892  
 JVC .....0331  
 Left Coast .....0892  
 Lennox .....1561  
 Linn .....0269  
 Luxman .....0165  
 Magnavox .....0269  
 Marantz .....0269, 0321, 0892

NEC .....0264  
 Nakamichi.....0321  
 Optimus .....0395, 0300  
 Panasonic.....0308, 0521  
 Parasaund .....0246  
 Philips .....0269, 0892  
 Pioneer .....0013, 0300  
 Polk Audio .....0269, 0892  
 RCA .....0300  
 Realistic .....0395  
 Sansui.....0321  
 Shure .....0264  
 Sony .....0815, 0689, 0220  
 Soundesign.....0078, 0211  
 Technics .....0308, 0521  
 Toshiba .....0353  
 Victor .....0331  
 Wards .....0013, 0078, 0211  
 Yamaha .....0354, 0133

**RECEIVER BRAND (Amplifier) CODE**

ADC .....0531  
 Aiwa...1405, 0121, 0158, 0189,  
 0405  
 Anam .....1074, 1609  
 Arcam .....1120  
 Audiotronic .....1189  
 Bose .....0639, 1229, 1253  
 Capetronic .....0531  
 Carver .....1189, 0042, 0189  
 Casio .....0195  
 Clarinette .....0195  
 Coby .....1263  
 Compaq .....1136  
 Curtis Mathes .....0080  
 Dell .....1383  
 Denon .....0004, 1360  
 Fisher .....0042  
 Garrard .....0463  
 Glory Horse .....1263  
 Harman/Kardon .....0891, 0110,  
 0189  
 Hewlett Packard .....1181  
 Hitachi .....0228  
 Integra .....0135  
 JBL .....0110  
 JVC .....0074, 1263  
 KLH.....1428  
 Kenwood .....1313, 1570, 1569,  
 .....0027, 0042, 0186, 0239  
 LXI .....0181  
 Linn .....0189  
 Lloyd's.....0195  
 MCS .....0039  
 Magnavox ...1189, 1269, 0189,  
 0195, 0391, 0531  
 Marantz1189, 0039, 0189, 1269  
 Mitsubishi .....1393  
 Modulaire .....0195  
 Musicmagic.....1089  
 Nakamichi.....0097  
 Onkyo .....0135, 0842  
 Optimus .....1023, 0042, 0080,  
 .....0177, 0181, 0186, 0219,  
 ..0531, 0670, 0738, 0801, 1074  
 Panasonic ...1518, 0039, 0309,  
 0367  
 Penney .....0195  
 Philips .....1189, 1269, 0189,  
 .....0391, 1120  
 Pioneer .....1023, 0014, 0080,  
 .....0150, 0244, 0531, 0630  
 Polk Audio.....0189  
 Proscan .....1254  
 Quasar .....0039  
 RCA .....1023, 1254, 0080,  
 .....0531, 1074, 1609  
 Radio Shack .....1263  
 Realistic .....0181, 0195

Rio .....1383  
 Sansui.....0189  
 Sanyo .....0801, 1251  
 Scott .....0163, 0322  
 Sharp .....0186  
 Sharper Image .....1263  
 Sherwood .....0491, 0502  
 Sonic Blue .....1383  
 Sony ..1058, 1441, 1759, 0158,  
 .....0474, 1349, 1406, 1442  
 Soundesign.....0670  
 Stereophonics.....1023  
 Sunfire .....1313  
 Teac .....0463, 1074  
 Technics.....1308, 1518,  
 .....0039, 0309  
 Thorens.....1189  
 Toshiba .....1572  
 Victor .....0074  
 Wards .0014, 0080, 0158, 0189  
 Yamaha.....0176, 0186, 1176  
 Yorx .....0195  
 Zenith .....0857

**AUDIO BRAND .....CODE**

Aiwa .....0010, 0159  
 AudioSource .....0351  
 Cambridge Soundworks ...0351  
 Carver .....0351  
 Fisher .....0052  
 Fosgate.....0259  
 Harmon/Kardon .....0477  
 JBL .....0477  
 JVC .....0073  
 KLH.....0351  
 Magnavox .....0325  
 Nikko.....0376  
 Paramount Pictures 0317, 0351  
 RCA .....0056  
 SSI .....0317  
 Sansui .....0325  
 Schneider .....0376  
 Sony .....0010, 0576  
 Soundesign.....0376  
 Yorx.....0376

**SET TOP BOX BRAND..CODE**

Panasonic .....1120  
 Pioneer .....1010  
 Princeton.....0113, 0295  
 Samsung.....1190  
 Sensory Science .....1126  
 Sharp .....1010  
 Sony .....0639

**PERSONAL VIDEO**

**RECORDER BRAND.....CODE**

Panasonic .....0616  
 Philips .....0618  
 ReplayTV .....0614, 0616  
 SonicBlue .....0614, 0616  
 Sony .....0636  
 Tivo.....0618, 0636

# On-Screen Display

1. Press MENU on the remote control to display the different features on your HITACHI Plasma TV.
2. Use the CURSOR PAD (buttons ▲, ▼, ◀ and ▶) or CHANNEL WHEEL to navigate to a different menu item.
3. Press EXIT on the remote control to quickly exit from a menu.

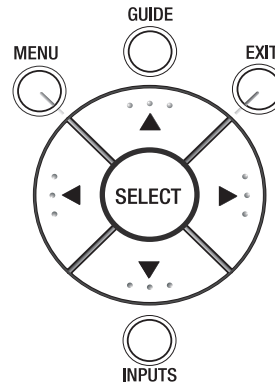

This part of the screen shows which selections are available.

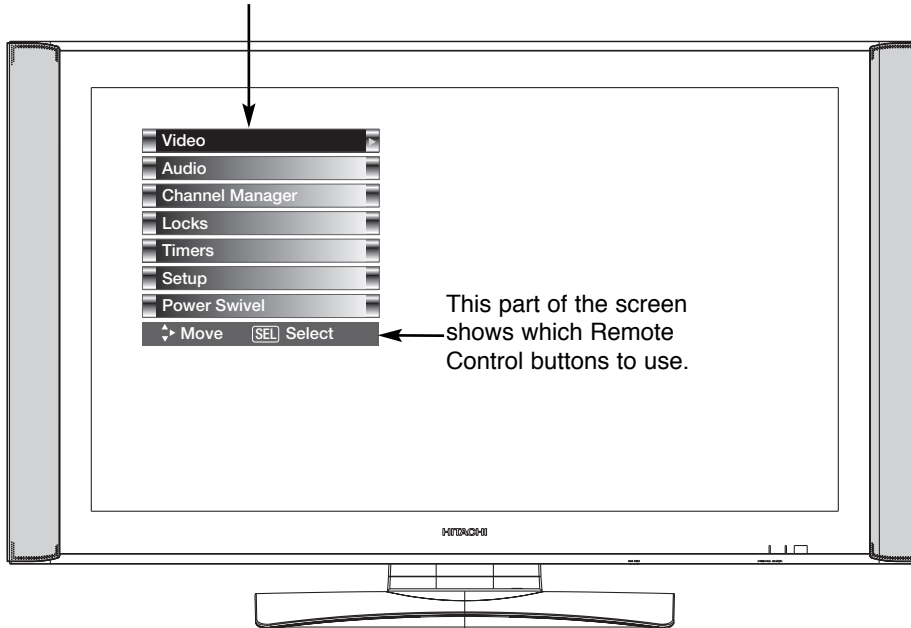

# On-Screen Display

## Video

Picture Mode	Select between the two picture modes; Day and Night.
Contrast	Adjust contrast.
Brightness	Adjust brightness.
Color	Adjust color.
Tint	Adjust tint.
Sharpness	Adjust sharpness.
Color Temperature	Set this to High for less intense color with more blue, set to Medium for natural color, set to Standard for standard colors or Black and White for more reddish color.
Black Enhancement	Enhance picture brightness in light scenes.
Contrast Mode	Use this function to choose between 3 Contrast Mode settings.
Noise Reduction	Reduces conspicuous noise in the picture.
Auto Movie Mode	Turn On/Off the 3:2 Pulldown detection feature.
Aspect	Choose the picture format aspect ratio.
Black Side Panel	Set the gray side bars On/Off when watching 4:3 signals in standard mode.
Reset Video Settings	Choose to Reset Video Settings to factory settings.

## Audio

Treble	Adjust the treble.
Bass	Adjust the bass.
Balance	Adjust the balance.
SRS	Select SRS settings (Off, Wide, Normal)
BBE	Select BBE settings (Off, Soft, Hard)
TruBass	Select TruBass settings.
Audio Source	Select between three Audio Sources.
Internal Speakers	Select internal or external speakers.
Auto Noise Cancel	Eliminates the noise between stations.
Perfect Volume	Adjust volume in fixed setting.
Loudness	Adjust Loudness.
Language	Select Language options if available.
Digital Output	Select Optical Output options.
DRC	Select Dynamic Range Compression to ON or OFF.

**NOTE:** The Language, Digital Output, and the Dynamic Range Compression feature of the Audio OSD are only available for Digital channels.

## Channel Manager

Signal Meter	Access Signal Meter.
Auto Channel Scan	Set Auto Channel Scan.
Channel List	Set Channel List.

## Locks

Change Access Code	Change Lock access code.
Engage Lock	Choose to lock channel, video input, and/or front panel.
Movie Ratings	Block various types of movies and video types based on motion picture ratings.
TV Ratings	Block various types of movies and television programming based on a parental guide ratings.
Canadian Ratings (ENG)	Block various types of movies and television programming based on the Canadian ratings system.
Canadian Ratings (FRN)	Block various types of movies and television programming based on the Canadian French ratings system.

## Timers

Set the Clock	Set Clock Settings.
Set Sleep Timer	Set Sleep Timer intervals (30 min. intervals, 00:30-3:00).
Set Day/Night Timer	Set Day/Night picture mode settings.
Set Event Timer	Set viewing reservation for TV programs.

## Setup

Menu Preference	Choose English, French, or Spanish text.
Screen Saver	Set Screen Saver to prevent screen burn.
Set The Inputs	Label Video Inputs, VCR, DVD, etc.
Set AV NET	Set AV NET Wizard
Set Closed Captions	Feature to display dialogue/text.
Set Monitor Out	Set Monitor Out source.
Upgrades	Select to upgrade TV software.
Quick Start Up	Select the TV Quick Start Up options.

## Power Swivel

Unlocked	Power Swivel enabled. Control the motorized Table Top Stand
Locked	Power Swivel disabled.

**NOTE:** 1. The Signal Meter feature of the Channel Manager OSD is only available for Digital channels.  
 2. The CableCARD information feature of the Setup OSD is only available when a CableCARD from your cable operator is installed in the rear panel of the TV.  
 3. Power Swivel feature is only available when Table Top Stand is connected.



## Video

Select VIDEO to adjust picture settings and improve picture quality. You can independently customize each of the Video Inputs to your preference to increase viewing performance and pleasure depending upon the video program being viewed. If RESET is selected, only the selected input will reset to initial conditions.

### Picture Mode

Use this function to choose from automatic picture settings to optimize your TV's performance.

1. Use the **CURSOR** buttons ◀ or ▶ to highlight and select **PICTURE MODE** settings (Day or Night).
2. Then press the **SELECT** button to set the mode and return to the Video menu or press **EXIT** to quit menu.

Function	Day	Night
Contrast	100%	90%
Brightness	50%	50%
Color	50%	30%
Tint	50%	50%
Sharpness	50%	30%
Color Temperature	High	Standard
Black Enhancement	High	Off
Contrast Mode	Dynamic	Normal
Noise Reduction	Low	Low
Auto Movie Mode (TV/Cinema Detection)	Off	Off

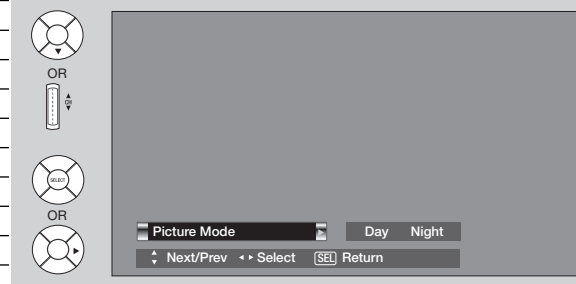
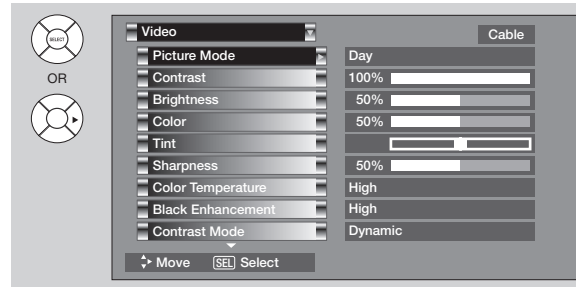
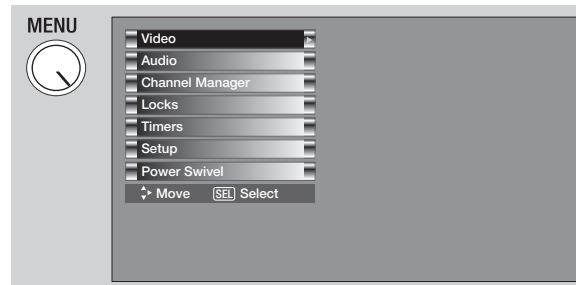

1. Use the **CURSOR PAD** ▲ or ▼ to highlight the function to be adjusted.
2. Press the **SELECT** button or the CURSOR PAD ▶ to select the function settings.
3. Press the **CURSOR PAD** ◀ or ▶ to adjust the function.
4. Press **MENU** to return to main menu.
5. Press **EXIT** to quit menu.

### Contrast

Use this function to change the contrast between black and white levels in the picture.

### Brightness

Use this function to adjust overall picture brightness.

### Color

Use this function to adjust the level of color in the picture.

### Tint

Use this function to adjust flesh tones so they appear natural.

### Sharpness

Use this function to adjust the amount of fine detail in the picture.

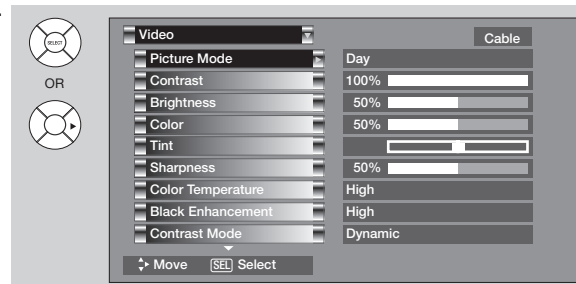
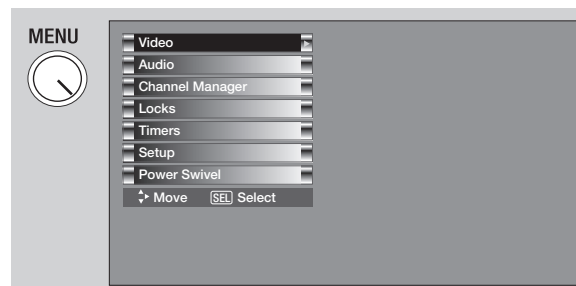

# Video

## Color Temperature

Set this to High for cooler color with more blue, set to Medium for more natural color, set to Standard for accurate color or set to Black/White for more reddish color.

## Black Enhancement

Use this function to enhance the shadow detail in dark scenes using the settings off, low, middle and high.

- NOTE:**
1. If **CONTRAST** is selected, you are adjusting **CONTRAST**. The additional menu items **BRIGHTNESS**, **COLOR**, **TINT**, and **SHARPNESS** can be selected and adjusted in the same manner.
  2. It may be necessary to adjust **TINT** to obtain optimum picture quality when using the **COMPONENT VIDEO Y-PbPr** input jacks.
  3. **CABLE** and **AIR** share a Video setting. Also, each of the video inputs have their own independent settings.

## Contrast Mode

Use this function to choose between 3 Contrast Mode settings. Set to Dynamic for darker images more in the level of Black, set to Normal for a balanced White to Black level, and set to Auto for automatic Contrast selection.

## Noise Reduction

The **NOISE REDUCTION** function automatically reduces conspicuous noise in the picture without degrading picture quality. Set **NOISE REDUCTION** to **OFF** if the TV experiences picture blocking.

## Auto Movie Mode

The **AUTO MOVIE MODE** function turn ON or OFF the 3:2 PULLDOWN DETECTION SPECIAL FEATURE. Theatrical movies are shot on film at 24 frames or still pictures per second, instead of 30 frames or 60 fields like video. When film is transferred to video for television viewing, the disparity between the two frame rates must be reconciled. This involves a process known as 3:2 pulldown.

When **AUTO MOVIE MODE** is turned ON from the VIDEO menu, your Hitachi Plasma Television will activate the circuitry for this special feature to improve video performance when watching film based sources.

- NOTE:**
1. When using Progressive Scan Component (Ex. 480p, 720p, 1080i), Auto Movie Mode will not be available (grayed out).
  2. All Video settings are independent of each other based on it's input (Cable/Air, Input 1~5, Photo Input).

## Aspect

Use this function to select the Picture Format Aspect Ratio.

### Auto Aspect

Automatically adjust the Aspect Ratio depending on the input signal to fill the screen.

### Mode

Automatically select the Aspect Ratio.

### Vertical Position

This function allows you to select when aspect style is either 4:3 EXPANDED/ZOOM1/ZOOM2 or 16:9

ZOOM. Vertical position can be changed with these modes. For example, it will be useful for centering the picture area at both the top and bottom of the picture with 480i/480p signal. Adjustable range is -10 (video center is toward bottom of screen) to +10 (video is toward top of screen).

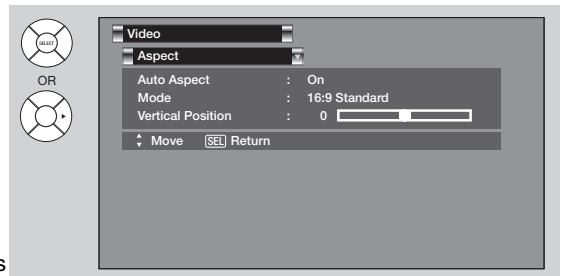

1. Use the **CURSOR PAD** ▲ or ▼ to to select menu item.
2. Press the **CURSOR PAD** ◀ or ▶ to adjust the function.
3. Press the EXIT to quit the MENU, or select ASPECT to return to the main menu.

**NOTE:** Vertical Position will not be available in 4:3 Standard and 16:9 Standard modes.

# Video

## Set Black Side Panel

The **BLACK SIDE PANEL** function turns the gray side bars on/off when watching 4:3 signals in Standard mode or use of the PIP modes.

1. Press the **CURSOR PAD** ◀ or ▶ to set to ON or OFF.
2. Press **EXIT** to quit menu or select **SET BLACK SIDE PANEL** to return to the previous menu.

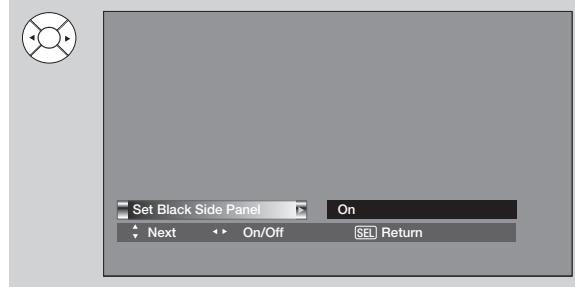
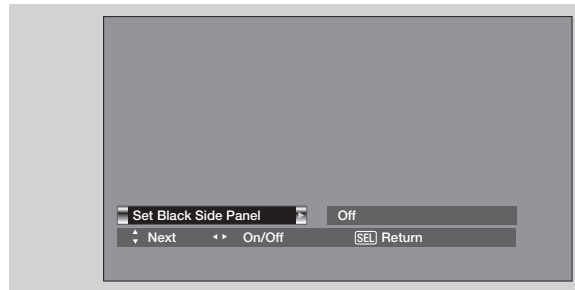

**NOTE:** To prevent screen damage when watching 4:3 signal, turn off the **BLACK SIDE PANEL**. It is recommended to watch 4:3 signal with gray side bar.

## Reset Video Settings

This function allows you to Reset the Video Menu Settings of the present input and return it to the Day VIDEO mode.

1. Use **CURSOR PAD** ▲, ▼ or **CHANNEL WHEEL** to highlight functions.
2. Press the **SELECT** button or **CURSOR PAD** ▶ to select Reset Video Settings.
3. Use the **CURSOR PAD** ▼ to access at the Reset softkey.
4. Press the **SELECT** button to Reset the Video Settings.

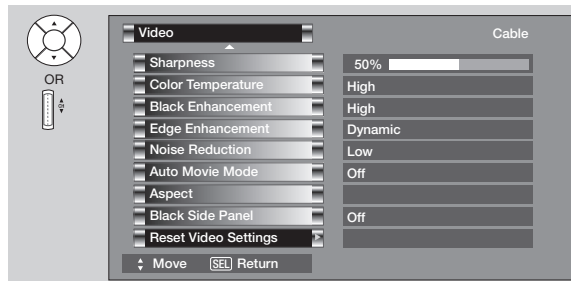

You can customize each of the Video Inputs to your preference to increase viewing performance and pleasure, depending upon the video program being viewed. If **RESET** is selected, only the selected Input will reset to the initial conditions as explained above.

If **RESET** is selected in Input 1, only Input 1 will return to factory conditions.

**NOTE:** If **YES** is selected, the **VIDEO MENU SETTINGS** will be reset to the original factory settings on all modes during the next power on/off.

# Audio

## Audio

Select AUDIO to adjust the TV to your preference and to improve the sound quality.

1. Press CURSOR PAD ▲ or ▼ to select menu item.
2. Press CURSOR PAD ◀ or ▶ to adjust the function.
3. Press EXIT to quit the MENU, or select AUDIO to return to the main menu.

**NOTE:** If **TREBLE** is selected you are adjusting treble. The additional menu items **Bass** and **Balance** can be selected and adjusted in the same manner.

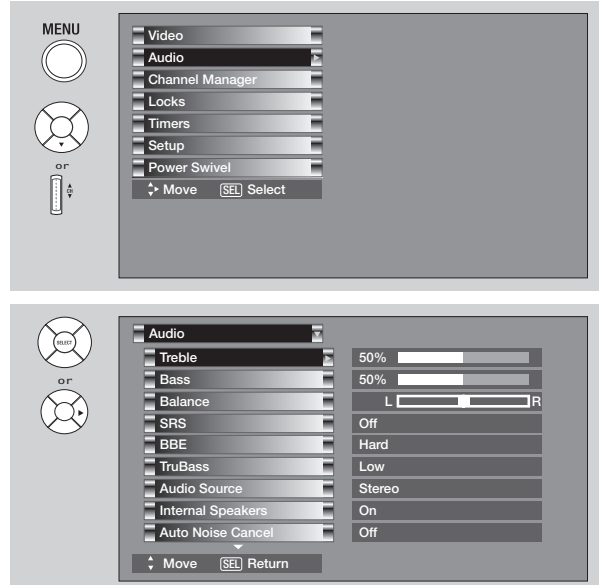

### Treble

This function controls the high frequency audio to all speakers.

### Bass

This function controls the low frequency audio to all speakers.

### Balance

This function will control the left to right balance of the Plasma TV internal speakers.

### SRS

Based on the principles of the human hearing system, **SRS** technology delivers an exciting and realistic 3D Sound experience from just two external speakers (or) the two internal speakers of your **HITACHI** Television. If your **HITACHI** Television is connected to an external audio system, **SRS** will also create an incredible 3D sound experience from two speakers and even enhance a complete multi-speaker surround sound system.



*SRS and the (SRS symbol) are trademarks of SRS Labs, Inc. SRS technology is incorporated under license from SRS Labs, Inc.*

### BBE

Sound reproduction quality enhancement system. The **BBE** technology produces sound that is natural and crisp from just two speakers or the two internal speakers found in your **HITACHI** television. If your **HITACHI** television is connected to an external audio system, **BBE** will also create an incredible crisp sound experience from two speakers. **BBE** brings to the listener's ear a more complete and accurate reproduction of the original performance. Each voice, speaking or singing, each instrument or sound effect is presented with its attendant harmonics or partials more clearly audible. The ear can then more easily recognize the unique tonal colors of each sound as though the sound was being produced live.



*Licensed by BBE Sound, Inc. under USP5510752 and 5736897. BBE and BBE symbol are registered trademarks of BBE Sound, Inc. Manufactured under license from BBE Sound, Inc.*

### SRS TruBass

TruBass is an audio enhancement technology from SRS Labs that provides deep, rich bass on any speaker system without the need for a subwoofer or additional extra physical components. For systems with a subwoofer, TruBass complements and enhances the bass performance. This feature can be set to Off, Low, Medium and High.



*TrueBass, SRS and the (SRS symbol) are trademarks of SRS Labs, Inc. TrueBass technology is incorporated under license from SRS Labs, Inc.*

# Audio

## Audio Source

Multi-Channel Television Sound will allow you to select **STEREO** (a stereo broadcast), **MONO** (monaural sound) used when receiving a weak stereo broadcast or **SECOND AUDIO PROG** (SAP) which may be a secondary language, weather report, etc.

## Internal Speakers

This function is useful when setting up the external speakers.

ON	Select this feature if using the internal speakers only.
TV as Center	Select this feature when setting up external speakers from a separate stereo system. The TV's speakers will work as the center speaker.
OFF	Select this feature if you prefer to use only speakers from a separate stereo system.

## Auto Noise Cancel

This function eliminates the noise between stations. If a channel is tuned and is noisy, this function will automatically eliminate the audio for that channel.

## Perfect Volume

This function will automatically adjust volume so each channel and input has the same average volume level.

## Loudness

Set this function to ON to emphasize bass and treble at low volume levels.

## Language

Some programs transmit more than one DTV language option. Most will have English as a default language. The language function will allow you to select up to 4 language options (if available).

## Digital Output

This function allows you to select between Dolby® Digital and PCM.

Dolby® Digital - Select this feature if the TV is connected to an amplifier/receiver with a Dolby® Digital only decoder; it will provide six independent soundtrack channels through the optical output jack (Digital Audio).

**NOTE:** \*Manufactured under license from Dolby Laboratories. "Dolby" and the double-D symbol are trademarks of Dolby Laboratories.

PCM - Select this feature if the TV is connected to an amplifier/receiver with a PCM only decoder; it will provide two independent soundtrack channels through the optical output jack (Digital Audio).

## DRC

Dynamic Range Compression - Use this function to compress the range of sound volume. By compressing the range of sound volume, it is possible not only to suppress the output of loud sound at night but also to raise the volume of low sound. This is only effective when the TV is connected via the optical out (digital audio) to an amplifier/receiver with a Dolby® Digital decoder. The default setting is ON.

Use the CURSOR PAD ◀ or ▶ to select the chosen options.

**NOTE:** The functions Language, Digital Output and DRC are only available when viewing digital programs.

Use the functions at right if your TV is connected to an amplifier/receiver with optical digital input with Dolby Digital or PCM decoder capabilities.

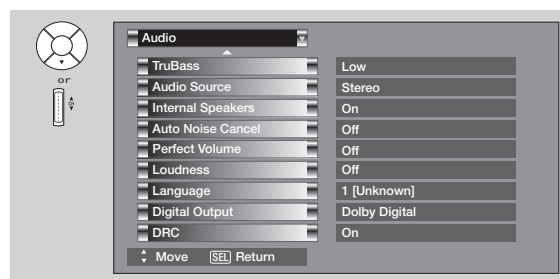
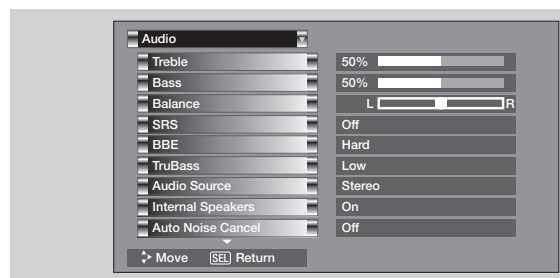

# Channel Manager

## Channel Manager

Select **CHANNEL MANAGER** to set your Antenna options, run Auto Channel Scan, Check Signal Meter and Set Channel List.

1. Press CURSOR PAD ▲, ▼ or CHANNEL WHEEL to highlight function
2. Press the SELECT button or CURSOR PAD ► to select.

### Signal Meter

Select **SIGNAL METER** when using an indoor or outdoor antenna. This feature will show the signal strength and peak values of the Antenna signal to help you adjust your antenna to optimize signal reception.

Use the **CURSOR PADS** and the **SELECT** button to highlight and select **CLOSE** to exit.

**NOTE:** The Signal Meter will not be available (grayed out) when watching analog channels.

### Auto Channel Scan

This feature will automatically store active Analog and Digital channels in Auto Channel Scan memory.

1. Use the **CURSOR PAD** ▲ or ▼ or CHANNEL WHEEL to highlight **CABLE** or **AIR**.
2. Press the **CURSOR PAD** ◀ or ▶ to highlight the **START** or **CLEAR** option.
3. Press the **SELECT** button to start **AUTO CHANNEL SCAN**.

- NOTE:**
1. When a CableCARD is installed, Auto Channel Scan will not be available since channels will be fixed based on what was agreed upon by you and your cable operator.
  2. If certain channels are poor or not possible in cable(1) mode, set cable source to cable(2) by using the CURSOR buttons ◀ or ▶.

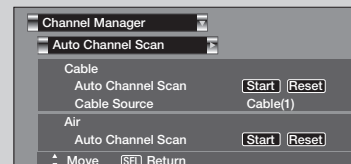
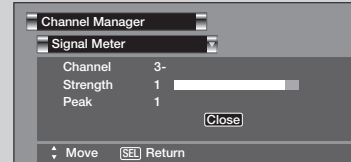
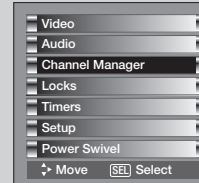

# Channel Manager

## Channel List

This function allows you to review which channels are labeled **(CH ID)**, which have been added to **CHANNEL MEMORY (SCAN)**, which are protected by **LOCK** and which are your **FAVORITE (FAV) CHANNELS**.

1. Use the **CURSOR PAD** to navigate the Channel List.
2. Press the **SELECT** button to select **ON** or **OFF** on the **SCAN** and **LOCK** columns.
3. To select **LOCK** column, input the access code.  
(Default access code: 0000)
4. Press the **FAV** button to set or remove the **FAVORITE** settings.
5. Press the **EXIT** button to return to normal viewing.

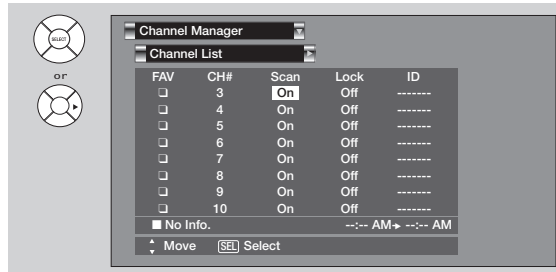
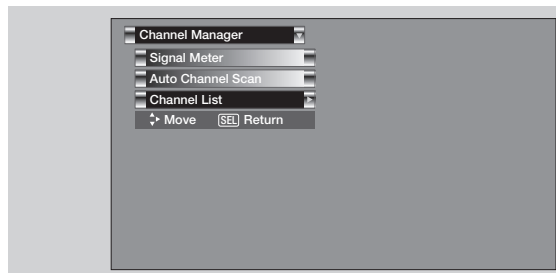

- NOTE:**
1. When a CableCARD is installed, the Channel List will be dependent on channels agreed upon by you and your cable operator.
  2. The Channel List cannot be updated by only changing the cable source. Auto Channel Scan must be performed for the Channel List to be updated.

# Locks

## Locks

This function will block out the picture and sound of the selected channel or video input. It can also be used to keep the TV from being viewed for a scheduled time period that you set.

The code to enter the Locks feature is a four digit access code number. The factory preset code is **0000**. Use the **NUMBER** buttons to enter the access code.

1. Use the **CURSOR PAD ▲, ▼** or **CHANNEL WHEEL** to highlight the desired function in the **LOCKS** menu.
2. Press the **SELECT** button to select.

### Change Access Code

1. To change the **ACCESS CODE NUMBER**, select **CHANGE ACCESS CODE** to change the factory preset code (**0000**) to your preference.

If you forget your **ACCESS CODE NUMBER**, use the factory code **7777** to erase your key number. This will reset the access code number back to the factory preset (**0000**).

2. Enter a new four digit number.
3. Press **EXIT** to quit the menu.

### Engage Lock

When **ENGAGE LOCK** is selected, **SET CHANNEL LOCK** and **SET FRONT PANEL LOCK** can be set individually.

When **SET CHANNEL LOCK** is turned on, the picture and sound for the chosen channel will be blocked out.

When **FRONT PANEL LOCK** is turned on, all buttons on the Front Panel will be deactivated, except the **POWER** button.

When **MOVIE RATINGS** is selected, you can block various types of movies and video tapes based on motion picture ratings. Picture-in-Picture will also be blocked automatically (see page 49).

When **TV RATINGS** is selected, various types of television programming based on a parental guide ratings will be blocked. Picture-in-Picture will also be blocked automatically (see page 50).

Use **CANADIAN RATINGS** to block various types of movies and television programs based on the two rating systems used in Canada that you feel may be inappropriate due to its content (see pages 51-52).

**NOTE:** If any Movie/TV Ratings are locked, Surf Mode PIP will not be available.

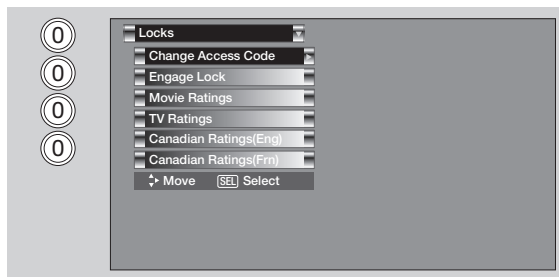
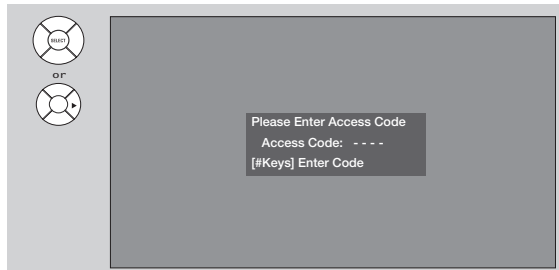
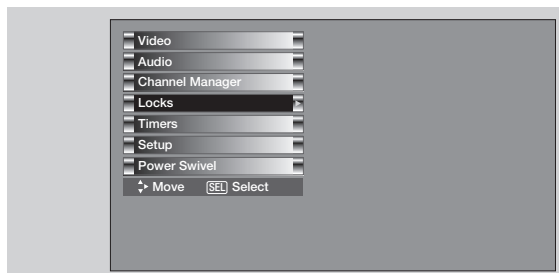



# Locks

## Movie Ratings

Use Movie Ratings to prevent viewing of any movie that you feel may be inappropriate due to its content.

1. Use the CURSOR PAD ▲, ▼ or CHANNEL WHEEL to select the **MOVIE RATING** category that you want to block.
2. Press **SELECT** to block the **MOVIE RATING** that you have selected. Once rating is selected, for example PG-13, all movies rated PG-13 and higher (R, NC-17, and X) will be blocked.
3. Press **EXIT** to quit the menu or select **MOVIE RATING** to return to the previous menu.

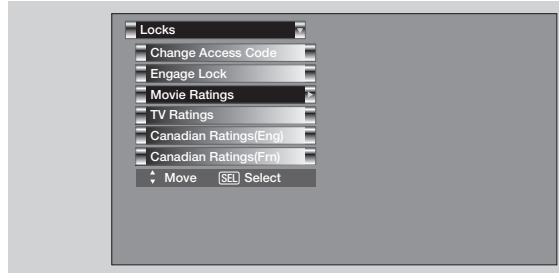

## Motion Picture Ratings Table

NOT RATED	Contains no rating. Not Rated (NR) and Not Applicable (NA) programs. Movie has not been rated or ratings do not apply.
G	General audiences. All ages admitted.
PG	Parental guidance suggested. Some material may not be suitable for children.
PG-13	Parents strongly cautioned. Some material may be inappropriate for children under 13.
R	Restricted. Under 17 requires accompanying parent or adult guardian.
NC-17	No one 17 and under admitted.
X	Adults only

- NOTE:**
1. A movie rating is dependent upon the movie that is viewed. If the movie does not carry a rating, the TV will not block it.
  2. Blocking **NOT RATED** programs may block emergency programming, sports, news, public service announcements, religious programs and weather.
  3. If a CableCARD is installed, your cable operator may provide an Emergency Alert System (EAS) message in the event of a local or national emergency with the purpose of alerting the general public. When you receive such messages, the Television will immediately tune to an EAS channel as directed by the EAS message. Please be advised that if the EAS channel is blocked using the **LOCKS** feature, you will not be able to tune to that channel.

# Locks

## TV Ratings

Use **TV RATINGS** to prevent the viewing of any TV program that you feel may be inappropriate due to its content.

1. Use the **CURSOR PAD ▲, ▼** or **CHANNEL WHEEL** to select the **TV RATING** category that you want to block.
2. Press **SELECT** to block the **TV RATING** that you have selected.
3. Press **EXIT** to quit the menu or select **TV RATING** to return to the previous menu.

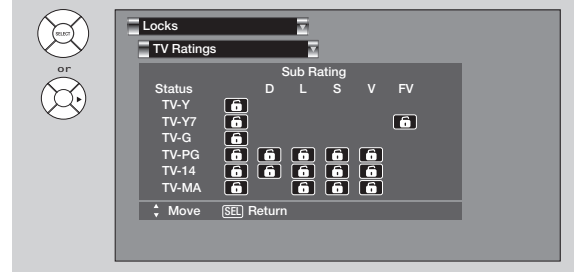
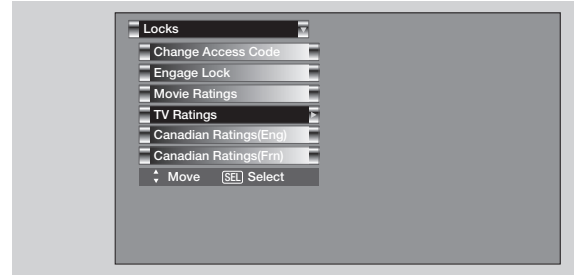

## TV Parental Guide Ratings Table

TV-Y	All children. The themes and elements in this program are specifically designed for a very young audience, including children from ages 2-6.
TV-Y7	Directed to older children. Themes and elements in this program may include mild physical or comedic violence, or may frighten children under the age of 7.
TV-G	General audience. It contains little or no violence, no strong language, and little or no sexual dialogue or situations.
TV-PG	Parental guidance suggested. The program may contain infrequent coarse language, limited violence, some suggestive sexual dialogue and situations.
TV-14	Parents strongly cautioned. This program may contain sophisticated themes, intense sexual situation, more intense violence and intensely suggestive dialogue.
TV-MA	Mature audiences only. This program may contain mature themes, indecent language, graphic violence, and explicit sexual content.
FV	Fantasy Violence
V	Violence
S	Sexual Situation
L	Adult Language
D	Sexually Suggestive Dialogue

- NOTE:**
1. If you Block **TV-14D**, you will still permit **TV-MA** programs; If you block **TV-14V**, you will automatically block **TV-MAV** programs, but you will still permit **TV-MALS** programs. This means that the TV will block violence in **TV-14** and higher (**TV-MA**), but not language and sex.
  2. TV program ratings are dependent on the broadcaster. If the program is not rated, the TV will not block it.
  3. If a CableCARD is installed, your cable operator may provide an Emergency Alert System (**EAS**) message in the event of a local or national emergency with the purpose of alerting the general public. When you receive such messages, the Television will immediately tune to an **EAS** channel as directed by the **EAS** message. Please be advised that if the **EAS** channel is blocked using the **LOCKS** feature, you will not be able to tune to that channel.

# Locks

## Canadian Ratings (Eng)

Use **CANADIAN RATINGS (ENG)** to block any type of movie and television program in Canada that you feel might be inappropriate in its content.

1. Use the **CURSOR PAD ▲, ▼** or **CHANNEL WHEEL** to select the **CANADIAN RATINGS (ENG)** category that you want to block.
2. Press **SELECT** to block the **CANADIAN RATINGS (ENG)** that you have selected. Once rating is selected, for example **C8+**, all movies and television programs rated **C8+** and higher (**G, PG, 14+** and **18+**) will be blocked automatically.
3. Press **EXIT** to quit the menu or select **CANADIAN RATINGS (ENG)** to return to the previous menu.

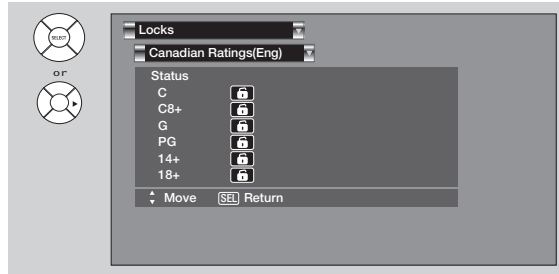
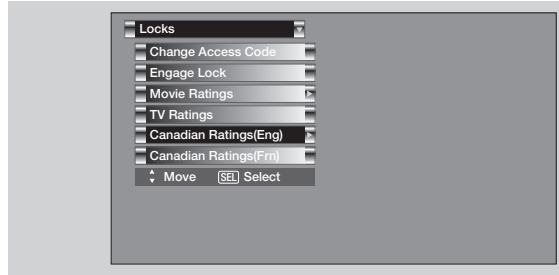

## Canadian Ratings English Table

C	Programming intended for children under age 8 - Violence Guidelines: Careful attention is paid to themes, which could threaten children's sense of security and well-being. There will be no realistic scenes of violence. Depictions of aggressive behaviour will be infrequent and limited to portrayals that are clearly imaginary, comedic or unrealistic in nature. Other Content Guidelines: There will be no offensive language, nudity or sexual content.
C8+	Programming generally considered acceptable for children 8 years and over to watch on their own - Violence Guidelines: Violence will not be portrayed as the preferred, acceptable, or only way to resolve conflict; or encourage children to imitate dangerous acts which they may see on television. Any realistic depictions of violence will be infrequent, discreet, of low intensity and will show the consequences of the acts. Other Content Guidelines: There will be no profanity, nudity or sexual content.
G	General Audience - Violence Guidelines: Will contain very little violence, either physical or verbal or emotional. Will be sensitive to themes which could frighten a younger child, will not depict realistic scenes of violence which minimize or gloss over the effects of violent acts. Other Content Guidelines: There may be some inoffensive slang, no profanity and no nudity.
PG	Parental Guidance - Programming intended for a general audience but which may not be suitable for younger children. Parents may consider some content inappropriate for unsupervised viewing by children ages 8-13. Violence Guidelines: Depictions of conflict and/or aggression will be limited and moderate; may include physical, fantasy, or supernatural violence. Other Content Guidelines: May contain infrequent mild profanity, or mildly suggestive language. Could also contain brief scenes of nudity.
14+	Programming contains themes or content which may not be suitable for viewers under the age of 14 - Parents are strongly cautioned to exercise discretion in permitting viewing by pre-teens and early teens. Violence Guidelines: May contain intense scenes of violence. Could deal with mature themes and societal issues in a realistic fashion. Other Content Guidelines: May contain scenes of nudity and/or sexual activity. There could be frequent use of profanity.
18+	Adult - Violence Guidelines: May contain violence integral to the development of the plot, character or theme, intended for adult audiences. Other Content Guidelines: May contain graphic language and explicit portrayals of nudity and/or sex.

# Locks

## Canadian Ratings (Frn)

Use **CANADIAN RATINGS (FRN)** to block Canadian French programs according to various program ratings that you feel might be inappropriate in its content.

1. Use the **CURSOR PAD ▲, ▼** or **CHANNEL WHEEL** to select the **CANADIAN RATINGS (FRN)** category that you want to block.
2. Press **SELECT** to block the **CANADIAN RATINGS (FRN)** that you have selected. Once rating is selected, for example **8 ANS+**, all movies and television programs rated **8 ANS+** and higher will be blocked automatically.
3. Press **EXIT** to quit the menu or select **CANADIAN RATINGS (FRN)** to return to the previous menu.

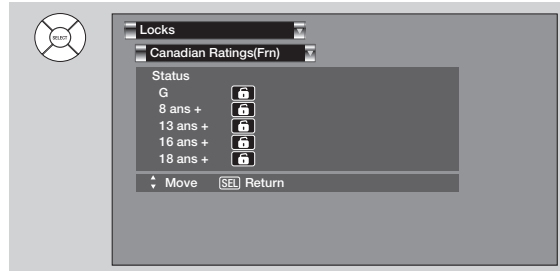

## Canadian Ratings French Chart

G	General - Programming intended for audiences of all ages. Contains no violence, or the violence content is minimal or is depicted appropriately with humor or caricature or in an unrealistic manner.
8 ans +	8 + General - Not recommended for young children - Programming intended for a broad audience but contains light or occasional violence that could disturb young children. Viewing with an adult is therefore recommended for young children (under the age of 8) who cannot differentiate between real and imaginary portrayals.
13 ans +	Programming may not be suitable for children under the age of 13 - Contains either a few violent scenes or one or more sufficiently violent scenes to affect them. Viewing with an adult is therefore strongly recommended for children under 13.
16 ans +	Programming is not suitable for children under the age of 16 - Contains frequent scenes of violence or intense violence.
18 ans +	Programming restricted to adults - Contains constant violence or scenes of extreme violence.

# Timers

## Timers

Select **TIMERS** to set your Clock, Sleep Timer, Event Timer and Day/Night Timer Recordings.

1. Use the **CURSOR** buttons ▲ or ▼ to highlight the function to be adjusted.
2. Press the **SELECT** button to select.

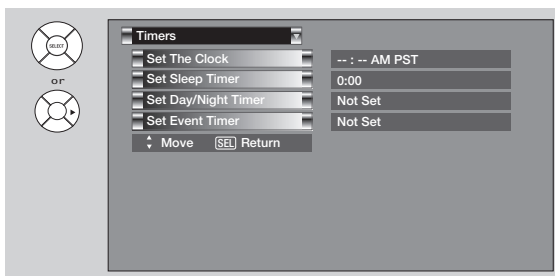
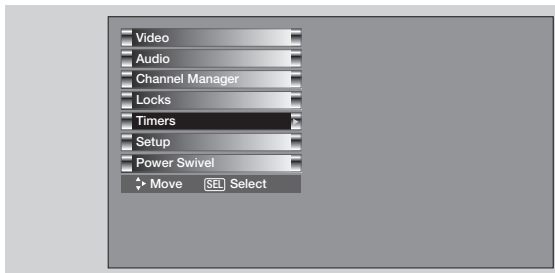

### Set The Clock

The Clock must be adjusted before you can use the **SET EVENT TIMER** or **DAY/NIGHT TIMER** feature.

1. Use the **CURSOR PAD** ◀, ▶, ▲, ▼ or **CHANNEL WHEEL** to highlight the chosen **TIME ZONE** settings.
2. Press the **SELECT** button to select. If you observe daylight savings, use **CURSOR PAD** to highlight **DAYLIGHT SAVING CORRECTION** and press the **SELECT** button to select.
3. Use the **CURSOR PAD** ◀, ▶, ▲, ▼ or **CHANNEL WHEEL** to highlight the **CURRENT TIME** (hour and minute), **AM** or **PM**, **MONTH**, **DAY**, and **YEAR**.
4. Use the **CURSOR PAD** ▲, ▼ to adjust settings.
5. Press the **SELECT** button to set the **TIME AND DATE**.
6. Press **EXIT** to quit the menu or select **SET THE CLOCK** to return to the previous menu.

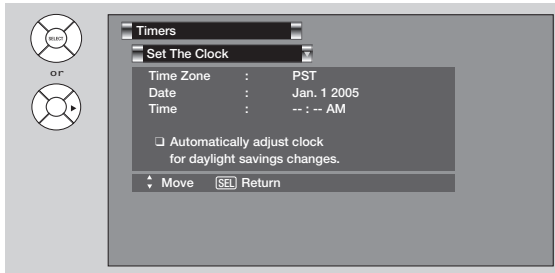
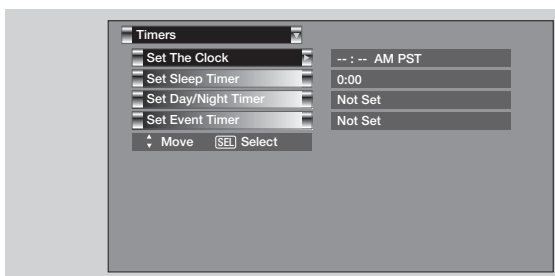

**NOTE:** 1. When **AUTOMATICALLY ADJUST CLOCK FOR DAYLIGHT SAVING CHANGES** is checked ✓, the TV will automatically calculate the clock adjustment for Daylight Saving.  
 2. When the CableCARD is used, the TV will **SET THE CLOCK** automatically.  
 3. The TV counts electrical pulses for regulating the **TIMERS**. When the power cord is unplugged then plugged in quickly, the clock is stopped momentarily and the **TIME** indication will become slow.

# Locks

## Set Sleep Timer

Select this feature to set your **SLEEP TIMER** from 30 minutes to 3 hours (30 minute increments).

1. Press the **CURSOR PAD** ► repeatedly to set your Timer from **0:00**, **0:30**, **1:00**, **1:30**, **2:00**, **2:30** and **3:00**.

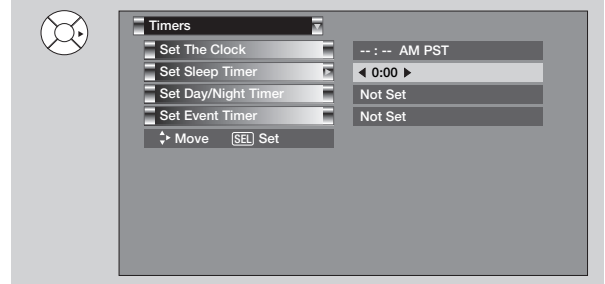
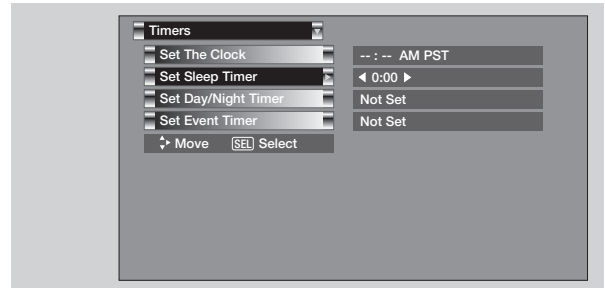

## Set Day/Night Timer

Select this feature to activate and set your TV's **DAY/NIGHT PICTURE MODE** automatically. This feature is not available until the clock is set.

1. Use the **CURSOR PADS** to highlight **SET DAY/NIGHT TIMER** settings.
2. Press the **SELECT** button to select.
3. Use the **CURSOR PADS** to select **DAY MODE ON** and to set its **TIMER**.
4. Use the **CURSOR PADS** to select **DAY MODE OFF** and to set its **TIMER**.
5. Press **EXIT** to quit the menu or select **SET DAY/NIGHT TIMER** to return to the previous menu.

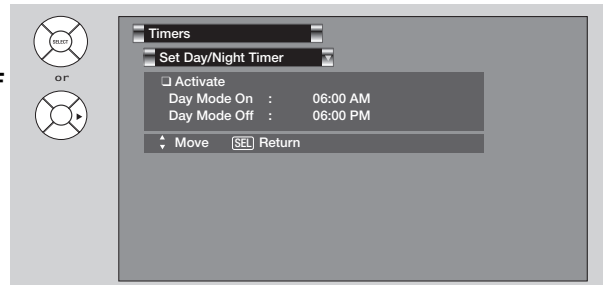

# Timers

## Set Event Timer

This function will automatically operate the Plasma TV viewing reservation of a program. If the clock is not set, you can not use this function and the screen below will appear. The message on the screen will disappear after 3 seconds, then the screen automatically goes to the clock setup mode (see page 53).



1. Use the **CURSOR PAD ▲, ▼** to highlight **EVENT 1, EVENT 2, EVENT 3, EVENT 4** and then press the **SELECT** button to select.
2. Use the **CURSOR PAD ▲, ▼** or **▼** to highlight and select **START TIME HOUR/MINUTE**.
3. Use the **CURSOR PAD ▲, ▼** or **▼** to highlight and select **START TIME AM/PM**.
4. Use the **CURSOR PAD ►, ▲** or **▼** to highlight and select **FINISH TIME HOUR/MINUTE**.
5. Use the **CURSOR PAD ►, ▲** or **▼** to highlight and select **FINISH TIME AM/PM**.
6. Use the **CURSOR PAD ►** to highlight the **MONTH**.
7. Use the **CURSOR PAD ▲** to select a **MONTH** or **CURSOR PAD ▼** to select **DAILY, WEEKLY - SUNDAY TO MONDAY**. Use the **CURSOR PAD ◀** to return to **MONTH**.
8. Use the **CURSOR PAD ►, ▲** or **▼** to highlight and select the **DAY** of the **MONTH**.
9. Use the **CURSOR PAD ►, ▲** or **▼** to highlight and select the **YEAR**.
10. Use the **CURSOR PAD ►, ▲** or **▼** to highlight and select **CABLE** or **AIR**.
11. Use the **CURSOR PAD ►, ▲** or **▼** or **NUMBER** buttons to set the channel the TV will tune into. A  in the box means it is enabled.

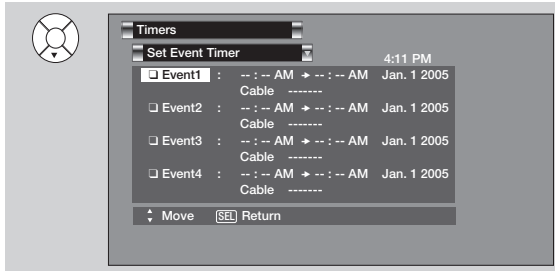
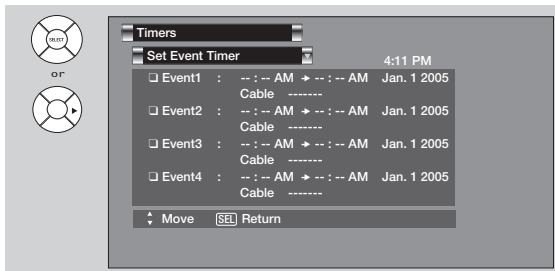
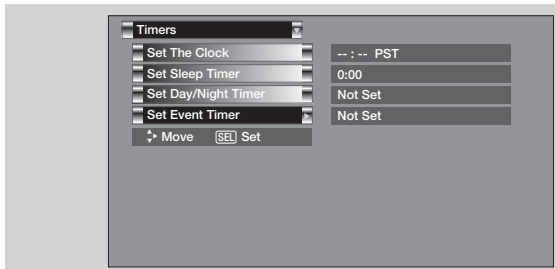

- NOTE:**
1. When the **INFO** button is pressed, the **Event Timer Icon** will only display the current date **ON/OFF** timer.
  2. The **OFF TIMER** will only activate if the TV was turned on by the **ON TIMER** and no channel selection was made after this time. If you change the channel after the **ON TIMER** has been activated, the **OFF TIMER** will deactivate.
  3. If no remote control button is pressed after viewing reservation is activated, the TV will automatically turn off after three hours. Therefore, do not **SET EVENT TIMER** for more than three hours if you do not plan to control your television with the remote control.



**CAUTION:** Do not use your TV as a deterrent when away from home by using the **ON** and **OFF TIMERS**. For safety, the TV should be turned off when you are away from home.

## Setup

Select **SETUP** when setting your TV up for the first time.

1. Use the **CURSOR PAD** ▲, ▼, ◀, ▶ to select the sub-menu of your choice.
2. Press the **SELECT** button to select.

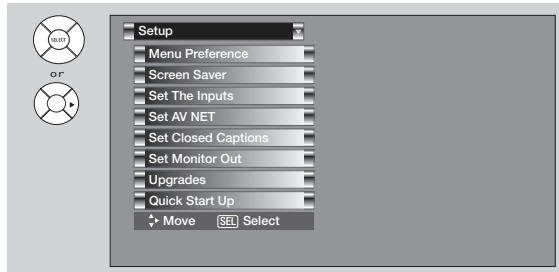
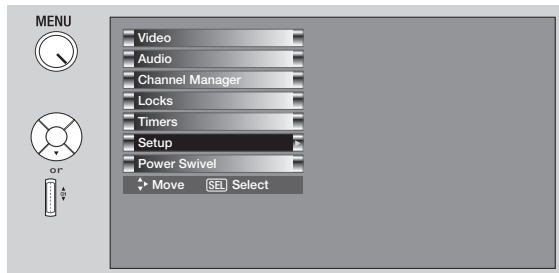

### Menu Preference

Setup the Language and background of the Menu OSD.

### Menu Language

This feature will allow you to select any one of three different languages for all on-screen displays.

1. Use the **CURSOR PAD** ◀ or ▶ to select the language of your choice.
2. Press **EXIT** to quit menu or select **MENU PREFERENCE** to return to previous menu.

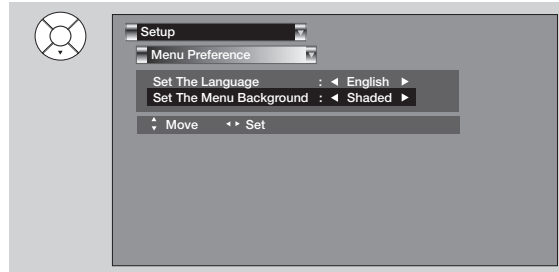
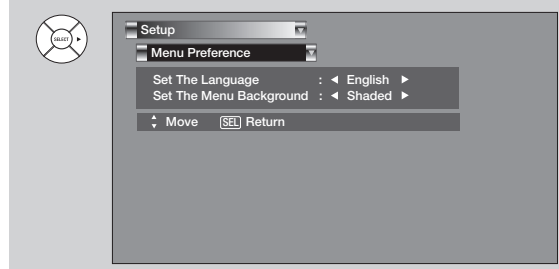
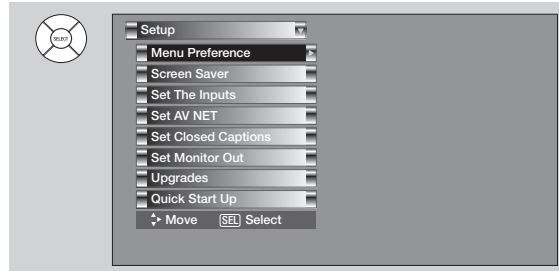
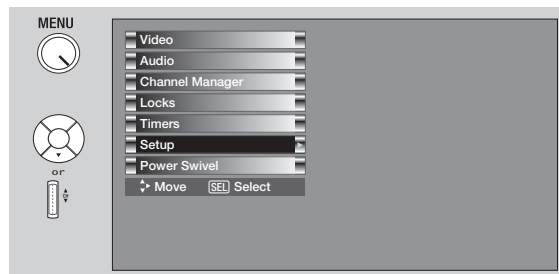



# Setup

## Menu Background

This function allows you to choose from two menu backgrounds.

1. Use the **CURSOR PAD** ◀ or ▶ to highlight **SET THE MENU BACKGROUND (SHADED OR SOLID)** of your choice. Use the **CURSOR PAD** ◀ or ▶ to select shaded or solid.
2. Select **SOLID** for a black background (no picture can be seen behind menu screen), select **SHADED** and a light background is visible.
3. Press **EXIT** to quit menu or select **MENU PREFERENCE** to return to the previous menu.

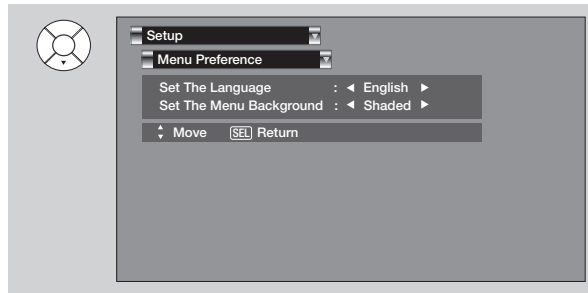

## Screen Saver

Continuous on-screen displays such as video games, stock market quotations, computer generated graphics, and other fixed (non-moving) patterns can cause permanent damage to the Plasma Television. Use the **SCREEN SAVER** feature to hide screen burn.

1. Use **CURSOR PAD** ▲ or ▼ to highlight **Screen Saver's Main Picture Moving and Image Power** options.
2. Use the **CURSOR PAD** ◀ or ▶ to select your choices.

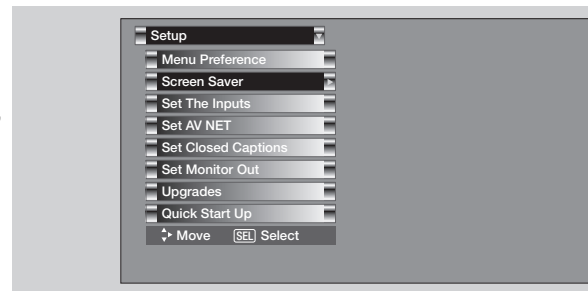

### Option 1

The whole picture will shift every 20 minutes by two pixels.

### Option 2

The whole picture will shift every 40 minutes by two pixels.

### Option 3

The whole picture will shift every 60 minutes by two pixels.

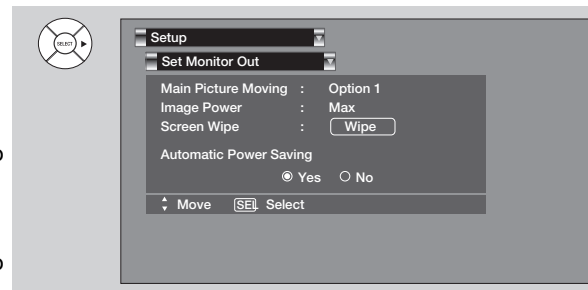

## Image Power

This function allows you to choose power consumption reduction based on 3 levels (min., medium and max).

## Screen Wipe

If pattern mark occurs, use **Screen Wipe** (White Field Signal) for at least 10 minutes to refresh any damage that may have occurred from a pattern mark. **Screen Wipe** can resolve pattern mark to a certain degree, if caution is not used, permanent damage may occur. Use the cursor pad ▲ or ▼ to highlight **Screen Wipe**.

Press the **SELECT** button to start.

Press the **EXIT** button to return to normal viewing.

## Screen Saver Picture's Movement

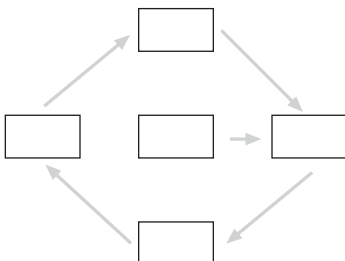

## Automatic Power Saving

Use this feature to turn power off automatically when a video input signal is not detected for 15 seconds

# Setup

## Set The Inputs

Use this feature to give a name to any of the live video inputs.

1. Press the **CURSOR PAD ▲, ▼** to highlight the video inputs.
2. Press the **CURSOR PAD ◀, ▶** to select your choices.

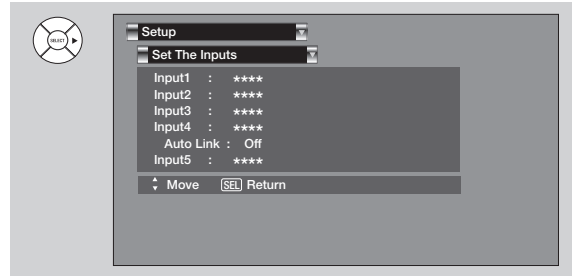
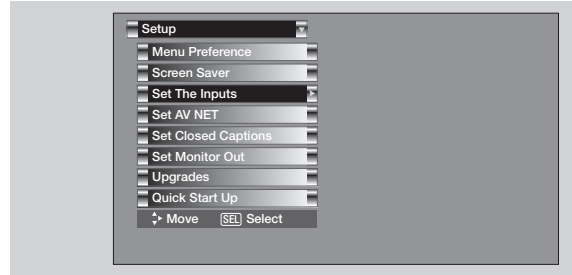

## INPUT 4 Auto Link

Use this function to automatically turn the TV on and tune to INPUT 4 when it detects a video signal to INPUT 4.

1. Use the **CURSOR PAD ▲, ▼, ◀ or ▶** to highlight and select the **AUTO LINK** setting of your choice.

### Auto

When **AUTO** is selected, the TV will turn on and switch to INPUT 4 automatically, when the INPUT 4 input device is turned on. This is convenient when you want to watch a movie with your VCR, laserdisc player, or DVD player.

### Remote

When **REMOTE** is selected, the TV will turn on and switch to INPUT 4 automatically when the INPUT 4 input device is turned on and the VCR, laserdisc, or DVD play button on your remote control is pressed. This is convenient when you want to record a movie with your VCR and watch it later.

### Off

Select **OFF** to disable this function.

2. Press **EXIT** to quit menu or select **AUTO LINK** to return to previous menu.

**NOTE:** 1. Once the TV has been turned on using the **AUTO LINK** feature, it must be reset before **AUTO LINK** is used again. To do this, turn your VCR, laserdisc, or DVD player OFF. This feature is now reset and will turn on your TV as described above.  
2. When using **REMOTE** mode, any remote control button will substitute for your video input device play button. However, intended operation is for use with your VCR, laserdisc, or DVD play button.  
3. If no remote control button is pressed after the TV is turned on by **AUTO LINK**, the TV will automatically turn off after three hours.

## Set AV Net

Use this feature to control your external Audio/Video equipment using your HITACHI Plasma TV Remote Control. The IR mouse cable must be properly connected for the AV NET feature to work.

1. Press the **MENU** button.
2. Use the **CURSOR PAD ▼** or **CHANNEL WHEEL** to highlight **SETUP**.
3. Press the **SELECT** button to select.
4. Use the **CURSOR PAD ▼** or **CHANNEL WHEEL** to highlight **SET AV NET** feature.
5. Press the **SELECT** button to select.

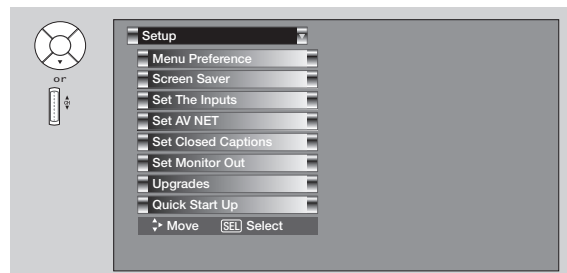
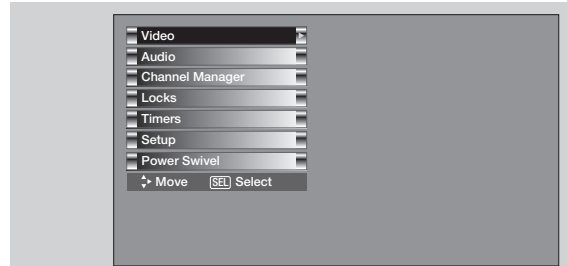

# Setup

## AV NET SETUP WIZARD ( Example: A/V RECEIVER Setup)

1. Press the SELECT button to start the SETUP WIZARD.
2. Use the CURSOR PAD ▲ or ▼ to highlight YES or NO.
3. Press the SELECT button to select "YES". (Select YES to setup an A/V Receiver or NO to setup other devices).
4. Use the CURSOR PAD ◀, ▶, ▲ and ▼ to highlight NEXT, then press the SELECT button to move on to the next SETUP screen.
5. Use the CURSOR PAD ◀ or ▶ to choose the brand name of your A/V Receiver.
6. Use the CURSOR PAD ◀, ▶, ▲ and ▼ to highlight NEXT, then press the SELECT button to move on to the next SETUP screen.
7. Use the CURSOR PAD ◀ or ▶ to choose the preset IR Code.
8. Use the CURSOR PAD ▼ to highlight the "POWER" Test button.
9. These On-screen buttons are called "Soft Keys". Press the SELECT button to pass the Power command through the IR mouse and onto the A/V Receiver ( Repeat steps 7 to 9 until finding the IR code that will power up the A/V Receiver. If the A/V Receiver turns ON, then you have found the correct preset IR code ).
10. Use the CURSOR PAD ◀, ▶, ▲ and ▼ to highlight NEXT, then press the SELECT button to move on to the next SETUP screen.
11. Use the CURSOR PAD ◀ or ▶ to select the TV Input that connects to the video and audio output of the A/V Receiver.
12. Use the CURSOR PAD ◀, ▶, ▲ and ▼ to highlight NEXT, then press the SELECT button to move on to the next SETUP screen.

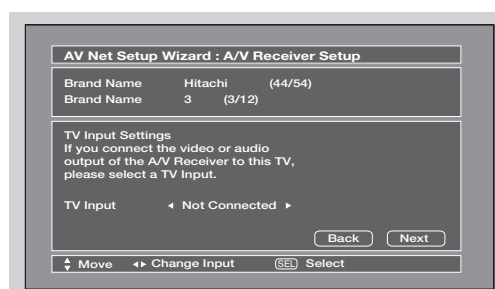
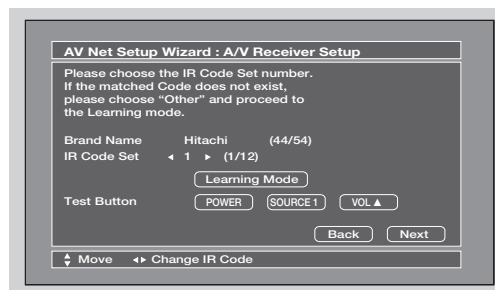
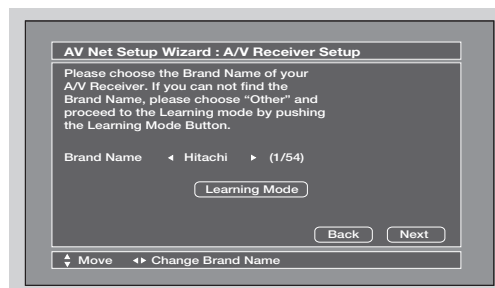
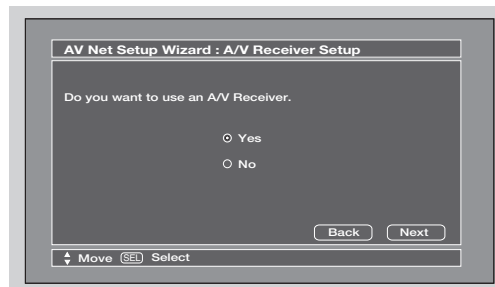

# Setup

13. Use the CURSOR PAD ◀ or ▶ to select the A/V Receiver Source if you have connected the Monitor Out and Optical Out to the A/V receiver. Select “ Not Connected “ if not used.
14. Use the CURSOR PAD ◀, ▶, ▲ and ▼ to highlight NEXT, then press the SELECT button to move on to the next SETUP screen.

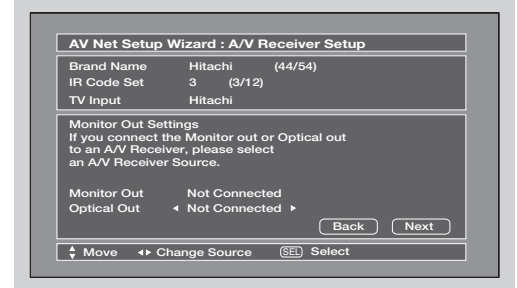

15. If you would like to label your A/V Receiver Source, use the CURSOR PAD ◀ or ▶ to highlight “ Yes “ then press the SELECT button to continue. Selecting “ No “ will bypass the Source labeling.

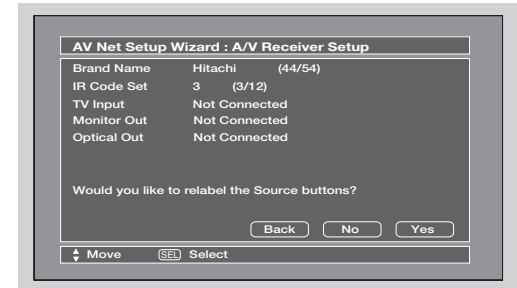

16. Use the CURSOR PAD ▲ or ▼ to select your A/V Receiver Sources.

17. Use the CURSOR PAD ◀ or ▶ to label your A/V Receiver Sources.

18. Use the CURSOR PAD ◀, ▶, ▲ and ▼ to highlight NEXT, then press the SELECT button to move on to the next SETUP screen.

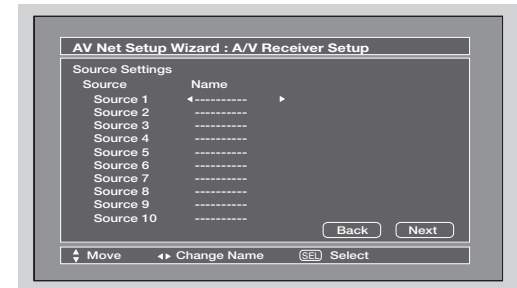

19. Confirm all settings, then press the SELECT button to move on to the next SETUP screen.



20. Press SELECT to setup another device or use the CURSOR PAD ◀ or ▶ to highlight “ No thanks, Im done “, then press the SELECT button to exit the A/V NET SETUP.



# Setup

## AV NET SETUP WIZARD ( Example: DVD Setup )

1. Press the SELECT button to start the SETUP WIZARD.
2. Use the CURSOR PAD ▲ or ▼ to highlight NO.
3. Press the SELECT button to select.  
(Select NO to setup other devices).
4. Use the CURSOR PAD ◀, ▶, ▲ and ▼ to highlight NEXT, then press the SELECT button to move on to the next SETUP screen.
5. Use the CURSOR PAD ◀, ▶, ▲ and ▼ to highlight the device.  
( Example : DVD Setup ).
6. Press the SELECT button to select.
7. Use the CURSOR PAD ◀, ▶, ▲ and ▼ to highlight NEXT, then press the SELECT button to move on to the next SETUP screen.
8. Use the CURSOR PAD ◀ or ▶ to choose the brand name of your DVD.
9. Press the CURSOR PAD ▼ to highlight the IR CODE Set, then use the CURSOR PAD ◀ or ▶ to choose the preset IR Code.
10. Use the CURSOR PAD ▼ to highlight the “ POWER ” Test button.  
These On-screen buttons are called “ Soft Keys ”.
11. Press the SELECT button to pass the Power command through the IR mouse and onto the DVD.  
( Repeat steps 9 to 11 until finding the IR code that will power up the A/V Receiver. If the DVD turns ON, then you have found the correct preset IR code ).
12. Use the CURSOR PAD ◀, ▶, ▲ and ▼ to highlight NEXT, then press the SELECT button to move on to the next SETUP screen.
13. Use the CURSOR PAD ◀ or ▶ to select the TV Input that connects to the video and audio output of the DVD.
14. Use the CURSOR PAD ◀, ▶, ▲ and ▼ to highlight NEXT, then press the SELECT button to move on to the next SETUP screen.

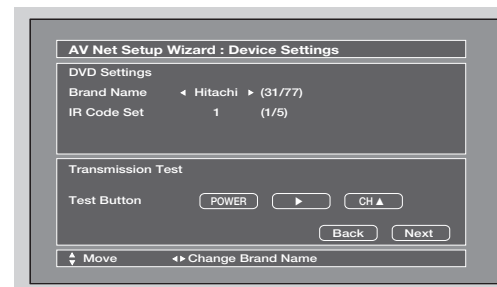
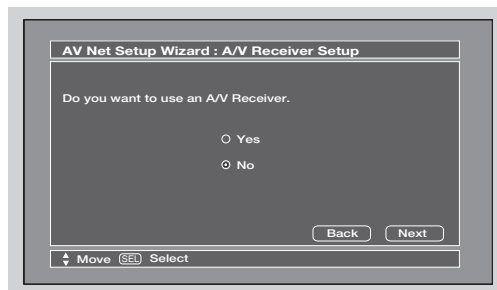

# Setup

15. Confirm all settings, then press the SELECT button to move on to the next SETUP screen.



16. Press the SELECT button to select YES to Setup another device. Press the CURSOR PAD ◀ or ▶ to highlight “ No thanks, Im done “, then press the SELECT button to exit the AV NET SETUP.

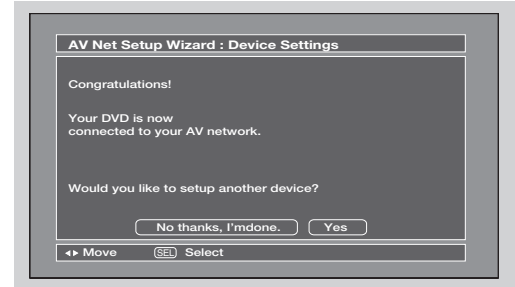

## Learning Mode

This function of the AV NET allows the user to use equipment that is not supported by the AV/NET codes. After programming your equipment to the AV NET and the Soft Keys do not work, you can manually “LEARN” each one by completing the Learning Mode. The Learning Mode will transfer any remote control button IR code of your equipment to the “Soft Keys” of your AV NET.

### Learning Mode (Example: A/V Receiver Setup)

1. Press the SELECT button to start the SETUP WIZARD.



2. Use the CURSOR PAD ▲ or ▼ to highlight YES.
3. Press the SELECT button to select.
4. Use the CURSOR PAD ◀, ▶, ▲ and ▼ to highlight NEXT, then press the SELECT button to move on to the next SETUP screen.

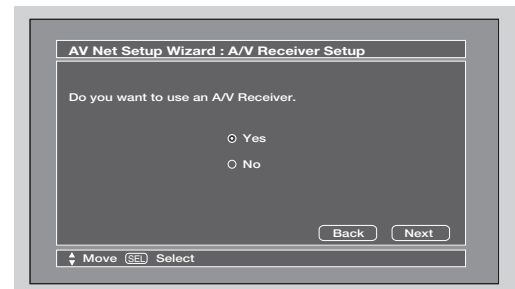

5. Use the CURSOR PAD ◀ or ▶ to select “Other” from brand name choices.
6. Use the CURSOR PAD ▲ or ▼ to highlight “Learning Mode” then press the SELECT button.

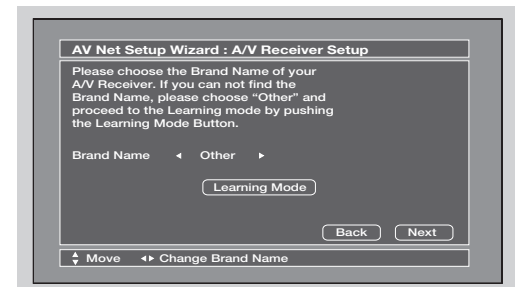

# Setup

- Use the CURSOR PAD ◀, ▶, ▲ and ▼ to select the Soft Key to learn (Ex. VOL ▲), then press the SELECT button.

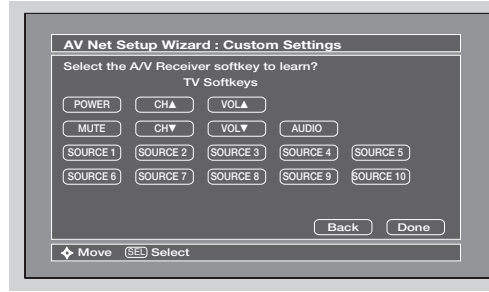

- Press and hold the VOL ▲ button of your A/V Receiver remote control while pointing directly at the learning AV NET sensor of the Plasma TV (located at the lower right corner of the screen) at a distance of 5 to 10 feet or 2 to 3 meters.

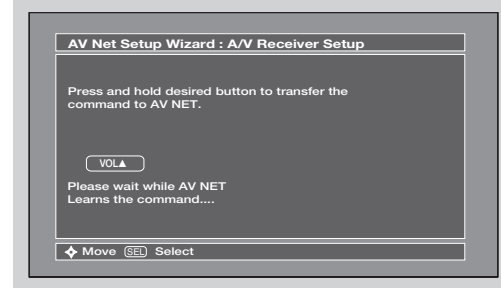

- If the IR code transfer was not completed, the screen on the right appears. Repeat step 8 to try again.



- If the IR code transfer was successful, the screen on the right appears, then select "OK" to continue setup.



- Select another Soft Key to learn or select DONE to move on to the next screen.

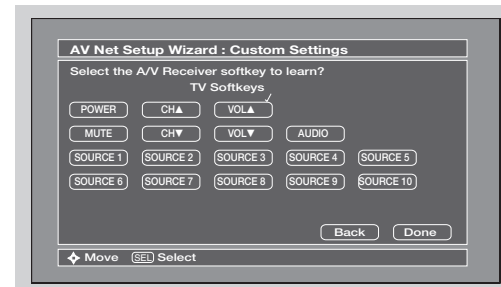

# Setup

12. Select the Test button VOL ▲ to check the response of the device to this command.
13. Use the CURSOR PAD ◀, ▶, ▲ and ▼ to highlight NEXT, then press the SELECT button to move on to the next SETUP screen.

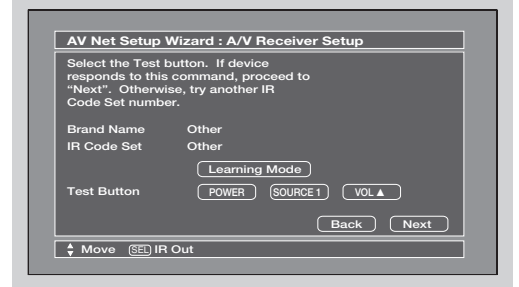

14. Use the CURSOR PAD ◀ or ▶ to select the TV Input that connects to the video and audio output of the A/V Receiver.
15. Use the CURSOR PAD ◀, ▶, ▲ and ▼ to highlight NEXT, then press the SELECT button to move on to the next SETUP screen.



16. Use the CURSOR PAD ◀ or ▶ to select the A/V Receiver Source if you have connected the Monitor Out and Optical Out to the A/V Receiver. Select "Not Connected" if not used.
17. Use the CURSOR PAD ◀, ▶, ▲ and ▼ to highlight NEXT, then press the SELECT button to move on to the next step.

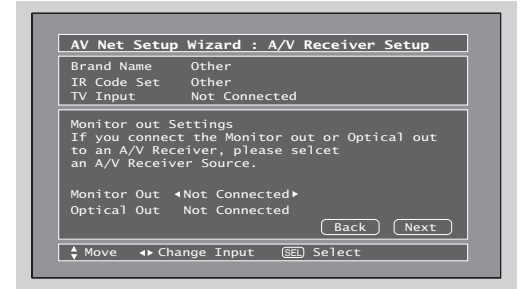

18. If you would like to label your A/V Receiver Source, use the CURSOR PAD ◀ or ▶ to highlight "Yes", then press the SELECT button to continue. Selecting "No" will bypass the Source Labeling.

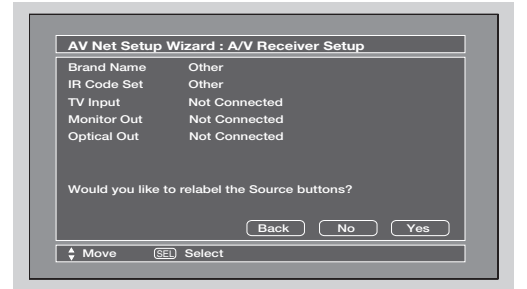

19. Use the CURSOR PAD ▲ or ▼ to select your A/V Receiver Sources.
20. Use the CURSOR PAD ◀ or ▶ to label your A/V Receiver Sources.
21. Use the CURSOR PAD ◀, ▶, ▲ and ▼ to highlight NEXT, then press the SELECT button to move on to the next SETUP screen.

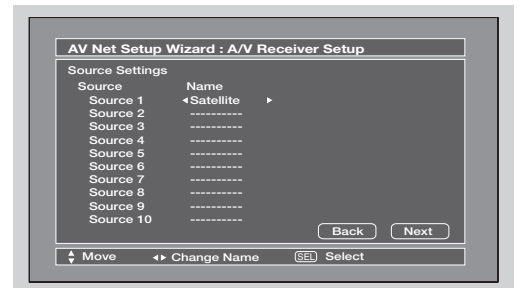



# Setup

- Confirm all settings, then press the SELECT button to move on to the next SETUP screen.



- Select "YES" to setup another device or select "No, thanks, I'm done" to exit the AV Net setup.



## Learning Mode (Example: CUSTOM/DVD 3 Setup)

- Press the SELECT button to start the SETUP WIZARD.



- Use the CURSOR PAD ▲ or ▼ to highlight NO.
- Press the SELECT button to select "NO". (Select NO to setup other devices).
- Use the CURSOR PAD ◀, ▶, ▲ and ▼ to highlight NEXT, then press the SELECT button to move on to the next SETUP screen.

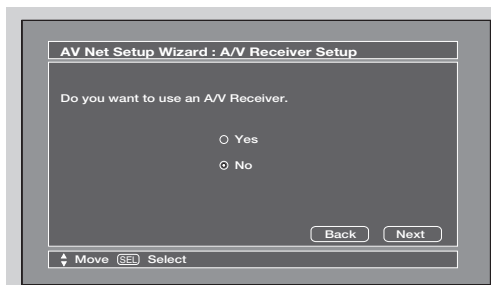

- CURSOR PAD ◀, ▶, ▲ and ▼ to highlight "Custom", then press the SELECT button to select.
- Select NEXT to continue.



# Setup

- 7. Use the CURSOR PAD ◀ or ▶ to choose the device you wish to learn. (Example: DVD 3)
- 8. Select NEXT to continue.



- 9. Select the DVD 3 softkey to learn. (Example: PLAY ▶ button).
- 10. Select NEXT to continue.

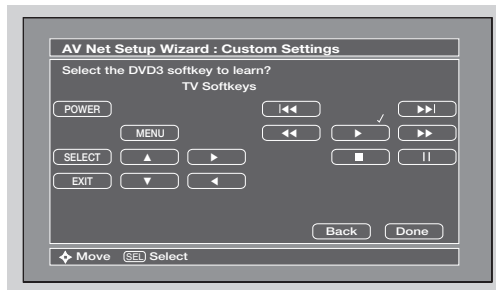

- 11. Press and hold the ▶ “Play button” of the DVD remote control while pointing directly at the learning AV NET sensor of the Plasma TV (located at the lower right corner of the screen) at a distance of 3 to 6 feet or 1 to 2 meters.

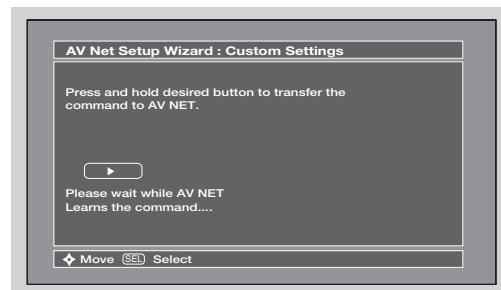

- 12. If the IR Code transfer was successful, the screen on the right appears, then select “OK” to continue setup.



- 13. Select another softkey to learn or select “DONE” to move on to the next screen.

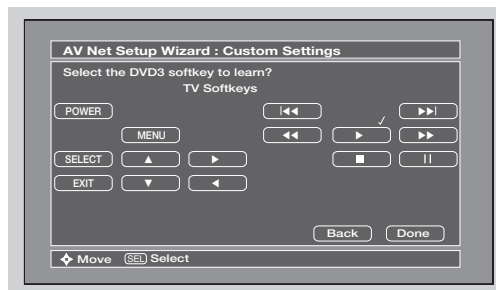

# Setup

14. Select the Test button ► “Play button” to check the response of the device to this command.
15. Use the CURSOR PAD ◀, ▶, ▲ and ▼ to highlight NEXT, then press the SELECT button to move on to the next SETUP screen.

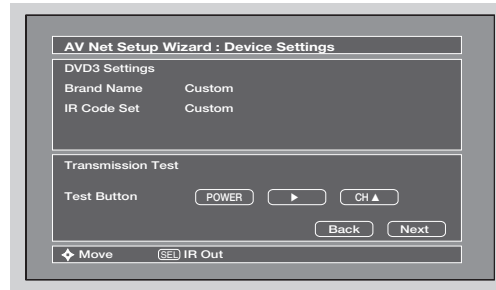

16. Use the CURSOR PAD ◀ or ▶ to select the TV Input that connects to the video and audio output of the DVD.
17. Use the CURSOR PAD ◀, ▶, ▲ and ▼ to highlight NEXT, then press the SELECT button to move on to the next SETUP screen.



18. Confirm all settings, then press the SELECT button to move on to the next SETUP screen.



19. Continue with the normal procedures to setup TV Input, Monitor Out, Optical Out and the labeling of the source buttons.
20. Select “YES” to setup another device or select “No thanks, I’m done” to exit the AV NET setup.



- NOTE:**
1. After a successful A/V NET setup to a chosen TV Input, the user can access soft key controls by selecting the device in the inputs menu.
  2. Each Device and Custom setting only accepts one device at a time. The second device/custom setup will give the user the options to either modify or delete the device.
  3. When setting up devices that have Monitor Out options (examples: A/V receiver, VCR), the Monitor Out and Audio Out will have default settings of TV Tuner out and Fixed respectively.
  4. Before changing or modifying the Video and Audio Inputs, both should be set to “Not Connected” to access available options.
  5. The device label will show on the Inputs menu until deleted or modified.
  6. The AV NET setup will have priority over the Input setup.

# Setup

## Set Closed Caption

Closed Captions are the dialogue, narration, and/or sound effects of a television program or home video which are displayed on the TV screen. Your local TV program guide denotes these programs as **CC** or **CC**.

1. Use the **CURSOR PAD** **◀**, **▶**, **▲** and **▼** to highlight and select the function to change.
2. Press **EXIT** to quit menu or select **SET CLOSED CAPTION** to return to the previous menu.

### Caption Display:

**ON/OFF** will turn the **CC** display on or off.

**AUTO** will turn the **CC** display on when Mute/Soft Mute is on.

### Analog Captions:

Set **CAPTIONS** for Analog programs. This function will help choose and set available mode and channel.

### Caption Mode:

**CAPTIONS** is for the program you are viewing.

**TEXT** is for additional information such as news reports or a TV program guide. This information covers the entire screen and viewing the TV program is not possible. Text may not be available with every **CC** program.

### Channel:

- 1 is used for the primary language (usually English).
- 2 is sometimes used for a second language (may vary by region).
- 3 is sometimes used for a third language (may vary by region).
- 4 is sometimes used for a fourth language (may vary by region).

### Digital Captions

Set captions for digital programs. This function will help choose and set available language, font, size and style of digital captions.

1. Use the **CURSOR PAD** **◀**, **▶**, **▲** or **▼** to highlight and select desired **DIGITAL CAPTIONS** feature.
2. Press **EXIT** to quit menu or select **SET CLOSED CAPTION** to return to the previous menu.

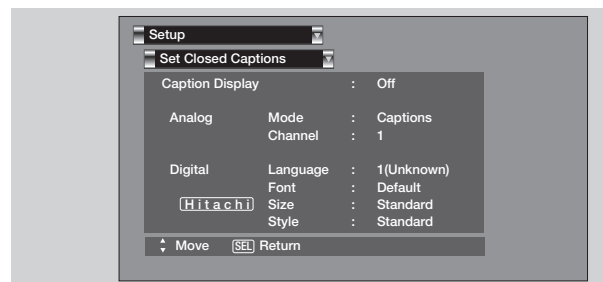
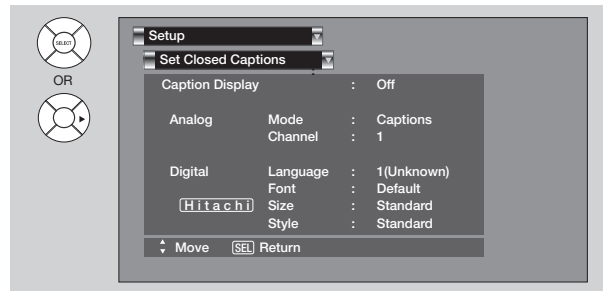
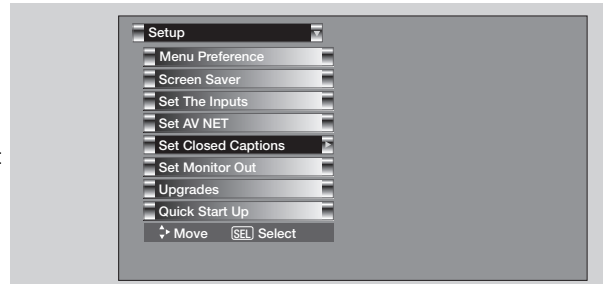

- NOTE:**
1. Some types of digital closed captions will not work with this TV.
  2. Caption Display will not work when viewing a 480p, 720p, or 1080i input via the **COMPONENT: Y-PbPr** inputs.
  3. When **PIP SURF** is on, Closed Caption will not work.
  4. Digital Captions Font Style are sometimes different from the Font Style of Analog Captions.
  5. Closed Caption and Digital Captions availability and content depends on the broadcaster. Closed Caption is available when Closed Caption icon is displayed on screen.
  6. Digital Captions will not be available (grayed out) when using analog channels.

# Setup

## Set Monitor Out

This feature will select the source of the Monitor Output.

### Monitor:

Select **MONITOR** to output the audio and video signals of the chosen input source (**CABLE, AIR, INPUT 1-5**) to a VCR or other A/V device.

### TV Tuner Out:

Select **TV TUNER OUT** to output the audio and video signals of the last watched Antenna Source (**CABLE, AIR**).

### Fixed

Select **AUDIO OUT FIXED** to have the Audio at fixed volume.

### Variable

Select **AUDIO OUT VARIABLE** to have Audio volume that can be controlled by the Plasma TV Volume Up/Down.

Video Out	Audio Out	Use
Monitor	Fixed	To record currently viewed Video and Audio.
Monitor	Variable	When an external device like a monitor or Hi-Fi audio system is connected to the audio and video output of the TV. You can control the volume output by changing the volume of the TV.
TV Tuner Out	Fixed	To record currently viewed Video and Audio from either Cable or Air.

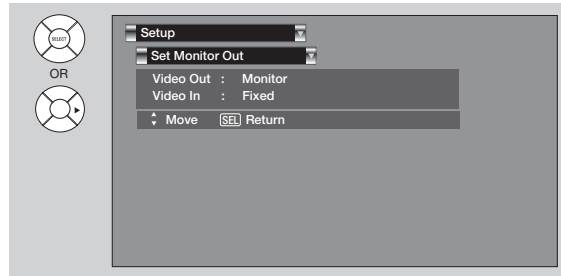
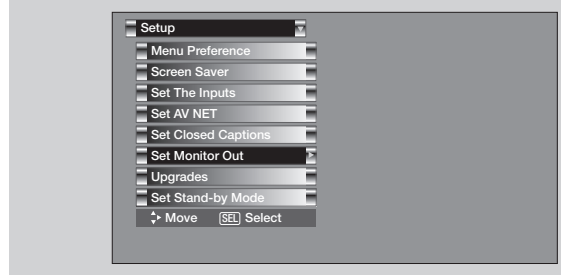

1. Use **CURSOR PAD ▲** or **▼** to highlight the function to change
2. Use the **CURSOR PAD ◀** or **▶** to select the function.
3. Press **EXIT** to quit menu or select **SET MONITOR OUT** to return to previous menu.

**NOTE:** 1. When **TV TUNER OUT** is selected, **VARIABLE AUDIO OUT** will not be available (grayed out).  
2. When using **MONITOR OUT** for recording, set the **VIDEO OUT** to **MONITOR**.

**MONITOR:** Available Monitor Out Signals

Input Mode			Monitor Out				
			S-Video	Video	L/R	HiFi	
ANT (Air or Cable)	Digital Channel	No Macrovision	S-Video	YES	YES	YES	YES
		Macrovision	S-Video	-	-	-	YES
	Analog Channel		Video	-	YES	YES	YES
Input 1	HDMI_1		-	-	-	YES	
	S-Video_1		YES	YES	YES	YES	
	Video_1		-	YES	YES	YES	
Input 2	HDMI_2		-	-	-	YES	
	S-Video_2		YES	YES	YES	YES	
	Video_2		-	YES	YES	YES	
Input 3	Y-PbPr_3		-	-	-	YES	
	Video_3		-	YES	YES	YES	
Input4	Y-PbPr_4		-	-	-	YES	
	Video_4		-	YES	YES	YES	
Input5	S-Video_5		YES	YES	YES	YES	
	Video_5		-	YES	YES	YES	

## TV TUNER OUT: Available Monitor Out Signals

Input Mode				Monitor Out (TV Tuner Out)			
				S-Video	Video	L/R	HiFi
ANT (Air or Cable)	Digital Channel	No Macrovision	S-Video	YES ANT	YES ANT	YES ANT	YES ANT
		Macrovision	S-Video	-	-	-	YES ANT
	Analog Channel		Video		-	YES ANT	YES ANT
Input 1	HDMI_1		Y-PbPr	YES ANT digital only	YES ANT	YES ANT	YES ANT
	S-Video_1						
	Video_1						
Input 2	HDMI_2		Y-PbPr				
	S-Video_2						
	Video_2						
Input 3	Y-PbPr_3						
	Video_3						
Input4	Y-PbPr_4						
	Video_4						
Input5	S-Video_5						
	Video_5						

### Upgrades

This feature shows software information and easy upgrade procedure. This function allows the TV software to be upgraded by using a flash card (**MMC CARD**). If a future software upgrade is required for your TV, **HITACHI** will notify and provide you with a flash card. In order to receive written notification and the flash card, please complete and return the warranty card.

1. Insert **MMC CARD**
2. Press the **CURSOR PAD ▲** or **▼** to highlight **UPGRADE NOW**.
3. Press the **SELECT** button to select and start upgrading.

**NOTE:** Any power interruption during the upgrade process will cancel the upgrade. When this happens, repeat the upgrade procedure.

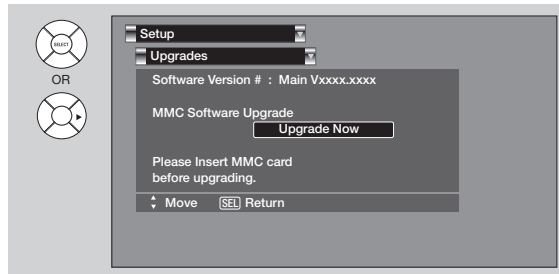
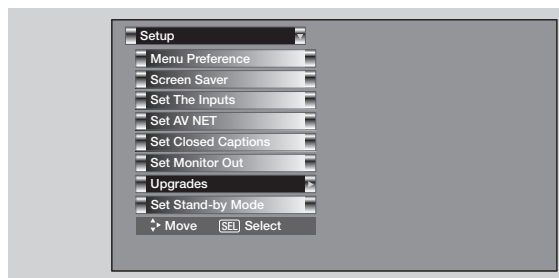

# Setup

## Quick Start Up

This feature will select **QUICK START UP** options. Set this feature to **ON** to have the TV tune channels (both Analog and Digital) quickly when first turning the TV on. Set this feature to **OFF** to save electricity. Selecting **ON** for the **QUICK START UP** feature will activate the TV tuners circuits when the TV is in “standby mode” which is commonly referred to as “off”. This will allow you to quickly tune to channels when first turning the TV on. Digital signals often change and this feature will monitor any changes and prepare the television to quickly present a picture. A small amount of electricity is used to continually monitor signals when this feature is selected.

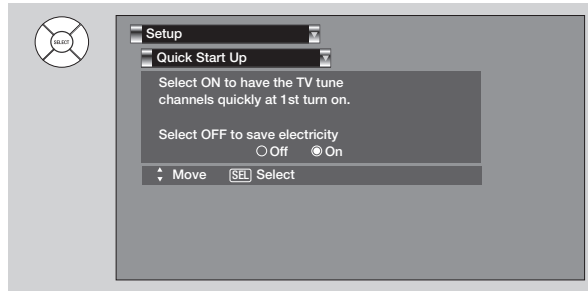
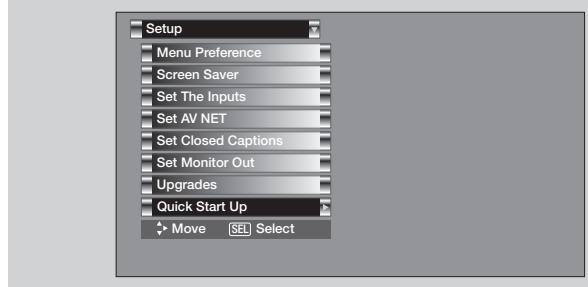

## Power Swivel

This feature controls the motorized stand. It allows the customer to turn the plasma display left or right using the remote control. This feature is only available when the Table Top Stand is connected.

1. Use the **CURSOR PAD** ◀ or ▶ to unlock or lock the Power Swivel.  
Exit the OSD menu system before controlling the motorized stand.
2. Press the **CURSOR PAD** ▶ to rotate the TV to the right.
3. Press the **CURSOR PAD** ◀ to rotate the TV to the left.
4. Release the **CURSOR PAD** to stop rotation.



- NOTE:**
1. The Power Swivel has a maximum turning radius of 30° (left and right).
  2. Do not place any objects in the path of the monitor when using the power swivel feature.
  3. Before using the power swivel, please make sure that the path of the monitor is clear of any fingers, hands or any other body parts to avoid causing injury.
  4. When the Picture-In-Picture (PIP) or Freeze mode is ON, the Power Swivel is disabled.

# Equipment Care and Troubleshooting

## DO

- Dust the screen and cabinet with a soft cloth.
- Clean the screen with a soft cloth moistened in warm water and dry with a soft cloth. A mild soap may be used if the screen is extremely dirty.
- Place your Plasma Television away from extreme heat, humidity, and extremely dusty places.
- Remove the plug from the wall outlet if your Plasma Television will not be used for a long period of time, for instance, when you go on vacation.

## DO NOT

- Do not clean your screen with strong cleaners, polishes or a chemically treated cloth.
- Do not place rubber or vinyl products or cellophane tape on your Plasma Television.
- Avoid repeatedly touching the screen.
- Do not subject the remote control to shocks such as dropping it on the floor, etc. This may cause damage to the precision parts.
- Avoid placing the remote control in a high humidity place or getting it wet. Do not leave it on or near a heater. Excessive heat or moisture may cause the unit to fail.
- When the batteries run down, remote control operation will become erratic or become unresponsive. Replace the old batteries with two new "AA" size batteries. Do not use an old battery with a new battery.
- Exposing the screen to direct sunlight for a long period of time or heat may cause damage to the plasma screen.

## TROUBLESHOOTING

Your **HITACHI** Plasma Television incorporates advanced power surge protection technology designed to protect against component or circuit damage due to external or internal voltage power surges.

### IF YOUR TELEVISION SHOULD APPEAR TO HAVE A LOSS OF POWER, PLEASE FOLLOW THIS PROCEDURE:

1. Press the **POWER SWITCH (ON/OFF SWITCH)** once.
2. If there is still no power, wait 30 seconds and press the **POWER SWITCH** again.
3. If there is still no power, unplug the power cord from the wall. Wait 30 seconds and plug the power cord back in. Press the **POWER SWITCH** again.

This protective technology should provide for years of lasting entertainment from your **HITACHI** Plasma Television.

SYMPTOMS	CHECK THESE ITEMS AND TRY THESE ADJUSTMENTS											
	Be sure external connection is correct	Be sure power cord is plugged in	Be sure TV is switched "ON"	Try another channel / station trouble	Check antenna connections (back of TV)	Check antenna for broken lead-in wire	Check for local interference	Adjust Contrast control	Adjust Brightness control	Adjust Color control	Adjust Tint control	Adjust Volume control
No Picture, no sound	●	●	●	●	●	●						
Sound OK, picture poor	●			●	●	●	●	●				
Picture OK, sound poor	●			●	●	●	●					●
Picture blurred	●			●	●	●	●					
Lines or streaks in picture				●	●	●	●					
Poor reception on some channels				●	●	●	●					
Picture rolls vertically				●			●					
No color	●			●	●	●	●			●		
Poor color	●			●	●	●	●			●	●	



## Reception Problems

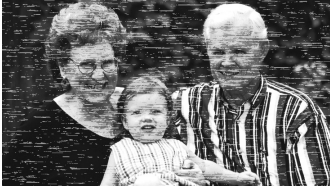

### IGNITION NOISE:

Black spots or horizontal streaks may appear, picture may flutter or drift. Usually caused by interference from automobile ignition systems, neon lamps, electrical drills, and other electrical appliances.



### GHOSTS:

Ghosts are caused by the television signal following two paths. One is the direct path and the other is reflected from tall buildings, hills or some other objects. Changing the direction or position of the antenna may improve reception. Ghosting may also be caused by defects in the antenna system such as unshielded leads or connecting several sets to the same antenna without using multiple antenna couplers.



### SNOW:

If your receiver is located in the fringe area of a television station where the signal is weak, your picture may be marred by the appearance of small dots. When the signal is extremely weak, it may be necessary to install a special antenna to improve the picture.

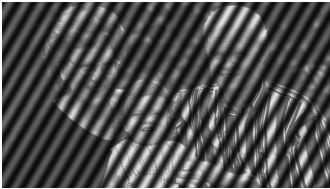

### RADIO FREQUENCY INTERFERENCE:

#### • RADIO FREQUENCY INTERFERENCE:

The interference produces moving ripples or diagonal streaks, and in some cases, causes loss of contrast in the picture.

#### • PREVENTION OF AN OBSTACLE TO RADIO RECEIVERS

This television has been designed pursuant to the FCC class B Rules. This is to prevent a problem to Radio receivers. If this television causes a problem to Radio receivers, then take the following steps:

- Keep the television away from Radio.
- Adjust Radio antennas in order for the television not to receive interference.
- The antenna cable of Radio should be kept away from the television.
- Use a coaxial cable for antenna.

You can check if this television influences Radio receivers by turning off all other equipment other than the television. If you find a problem receiving Radio when using the television, check the instructions mentioned above.



### BLOCK NOISE (DIGITAL INPUT):

Fuzzy blocks may appear in some area or the whole area of the screen. This is usually caused by interference from automobile ignition systems, neon lamps, electrical drills, ghosting of the image and weak signals.

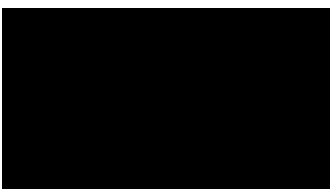

### BLACK SCREEN:

When using an antenna, weak signals will display a black screen. It may be necessary to upgrade your antenna.

**NOTE:** The TV set can generate sound distortion in external devices such as a radio. Please separate radio equipment from the TV set to a considerable distance.

## Troubleshooting

No.	Items	Notes
1	Buzzing sound from Plasma display panel.	A buzzing sound may be heard when the plasma television is turned on in a very quiet room. This is due to the plasma panel drive circuit when it is functioning. The buzzing sound is normal and is not a malfunction.
2	Infrared interference	Some infrared rays are emitted from the plasma television panel that might affect the operation of other infrared controlling equipment.
3	Bright and dark spots	High precision technology is used to manufacture the plasma television. But there maybe points that do not illuminate, points that are too bright, and points with color different from that of the periphery. Please note that this is not a malfunction.
4	Picture Image	In some cases, residual images may remain after the short term display of still images when the picture changes.
5	Display panel surface temperature is too high.	The plasma display panel display images by means of electrical discharges inside the panel. This may cause the temperature of the panel surface to increase. Please note that this is not a malfunction.
6	Plasma Surface	A reinforced glass filter is installed over the plasma panel surface. A strong impact to the front panel risk a danger of glass breakage.
7	Transportation	Please transport the plasma television in it's packing box and placed in an upright position. Do not transport the plasma television in a horizontal position. This increases the possibility of panel breakage and pixel failure.
8	Granular spots	When a screen is seen at point-blank range, a random fine grain may be visible in the dark areas of the picture.
9	High temperature environment	High temperature affect the electric discharge/luminescence characteristic of the PDP panel. Do not place the plasma television in high temperature environments.
10	Operation	Operating altitude: 800 to 1,114hPa (6,194ft to -2,484ft). Operating temperature: 41°F to 95°F.
11	Storage	Storage altitude: 300 to 1,114hPa (31,912ft to -2,484ft). Storage temperature: 5°F to 140°F
12	Power ON or OFF	Repeatedly turning the plasma television Power ON and OFF at short intervals may result in failure of the television.



### PLUG AND PLAY

This Class B digital apparatus meets all requirements of the Canadian Interference-Causing Equipment Regulations.

This Class B digital apparatus complies with Canadian ICES-003.

Cet appareil numérique de la classe B est conforme à la norme NMB-003 du Canada.

Cable Compatible Television Apparatus- Télévision câblocompatible, Canada.

This Plasma Television receiver will display television closed captioning, (  or  ), in accordance with paragraph 15.119 of the FCC rules.

### AGENCY REGULATORY INFORMATION

#### Federal Communications Commission Notice

This equipment has been tested and found to comply with the limits for a Class B digital device, pursuant to Part 15 of the FCC Rules. These limits are designed to provide reasonable protection against harmful interference in a residential installation. This equipment generates, uses and can radiate radio frequency energy and if not installed and used in accordance with the instructions, may cause harmful interference to radio communications. However, there is no guarantee that interference will not occur in a particular installation. If this equipment does cause harmful interference to radio or television reception, which can be determined by turning the equipment off and on, the user is encouraged to try to correct the interference by one or more of the following measures:

- Reorient or relocate the receiving antenna.
- Increase the separation between the equipment and the receiver.
- Connect the equipment into an outlet on a circuit different from that to which the receiver is connected.
- Consult the dealer or an experienced radio/television technician for help.

#### Modifications

The FCC requires the user to be notified that any changes or modifications made to this device that are not expressly approved by Hitachi Home Electronics (America), Inc. may void the user's warranty.

#### Cables

Connections to this device must be made with shielded cables with metallic RFI/EMI connector hoods to maintain compliance with FCC Rules and Regulations.

Any cables that are supplied with the system must be replaced with identical cables in order to assure compliance with FCC rules. Order Hitachi spares as replacement cables.

# Features and Specifications

## Features:

- New Easy-to-Use On-Screen Menu Control (3 Language)
- New AV Network System Control  
Control up to 4 components with one remote  
2 IR Mouse cables included
- Illuminated and Preprogrammed Remote Control
- Power Management: ON/OFF via signal detection
- Picture Enhancement
- Input Signal Identification
- CableCARD compatible - Contact your local cable operator for more information
- HDMI (High Definition Multimedia Interface)(High Bandwidth Digital Content Protection V1.1 Compatible)
- Photo Input (for your digital camera)
-  Technology

## Video:

- 1024 x 1024 Display Resolution (42")
- 1366 x 768 Display Resolution (55")
- ALiS (Alternate Lighting of Surfaces Technology)
- High-Contrast Pure-Color Glass Shield
- Wide Viewing Angle: 160°
- 4 Color Temperature Presets: Black/White-5400K, Standard-6500K, Medium-9300K, High-1200K.
- Multiple Screen Fill Modes  
(4:3 Standard/Expanded/Zoom1/  
Zoom2/16:9 Standard/Zoom)<sup>1</sup>
- 4MB 10-bit 3D Y/C Comb Filter
- Picture Modes (Day and Night)

## Inputs:

- Power Input . . . . .AC 120V, 60Hz
- Power Consumption  
- Refer to rear panel at the back of the Plasma Monitor
- Antenna input impedance . . . . .75 Ohm
- Channel coverage . . . . .191ch.  
VHF-Band . . . . .2 ~ 13  
UHF-Band . . . . .14 ~ 69  
CATV Mid Band . . . . .A-5 ~ A-1  
. . . . .A-I  
Super Band . . . . .J-W  
Hyper Band . . . . .W+1 - W+28  
Ultra Band . . . . .W+29 - W+94
- Video . . . . .1.0Vp-p, 75 Ohm
- S-Video  
Luminance (Y) . . . . .1.0Vp-p, 75 Ohm  
Chrominance (C) . . . . .0.286Vp-p, 75 Ohm
- Component Video  
Luminance (Y) . . . . .1.0Vp-p, 75 Ohm  
Chrominance (P<sub>B</sub>/P<sub>R</sub>) . . . . .0.7Vp-p, 75 Ohm
- Audio input Impedance . . . . .270k Ohm
- Average input level . . . . .470mVrms
- HDMI . . . . .(19 PIN)

## Outputs:

- Video 1.0Vp-p. 75 Ohm
- Audio . . . . .470mVrms, 1k Ohm
- Optical Out (Digital Audio) . . . . .1 Optical Connector

## Audio:

- MTS Stereo/SAP
- TruBass
- 40W
- Soft Mute (50%)

## Supplied Accessories:

- Remote Control
- Batteries
- 6' AC Cable
- Table Top Stand (42" models only)
- IR Mouse Cable (2)
- Cleaning Cloth
- Power Swivel Cable (42" models only)
- Ferrite Core

## Optional Accessories:

- For U.S. Models: Please access our website:  
[www.hitachi.us/tv](http://www.hitachi.us/tv)

## INPUTS/OUTPUTS

•Wideband Component Y, Pb,Pr . . . . .	2
•Composite Video . . . . .	3
•S-Video . . . . .	3
•Antenna (RF) Inputs . . . . .	2
•Audio Output . . . . .	1
•Monitor Output . . . . .	1
•Optical Output . . . . .	1
•IR Blaster . . . . .	2
•CableCARD Slot . . . . .	1
•Upgrade Card Slot . . . . .	1
•Swivel Output . . . . .	1
•Subwoofer Output . . . . .	1
•HDMI . . . . .	2
•Photo Input . . . . .	1

## SPECIFICATIONS

- Pixel Pitch . . 0.90(horiz.) x 0.51(vert.) mm. (42")  
. . . . . 0.90(horiz.) x 0.90(vert.) mm. (55")
- FCC class: . . . . . B for Consumer Use
- Power Requirements: . . . . . 108-132V, 60Hz

<sup>1</sup> Screen mode availability varies by input format

HDTV Monitors display HDTV when combined with an HDTV Tuner and Source.

All specifications, weights, and dimensions are subject to change without prior notice. Please access [www.hitachi.com/tv](http://www.hitachi.com/tv) for detailed specifications and dimensions for custom installations.

UltraVision Digital is a registered trademark of Hitachi Home Electronics (America), Inc.

TruBass, SRS and the  symbol are trademarks of SRS Labs, Inc. TruBass technology is incorporated under license from SRS Labs, Inc.

Licensed by BBE Sound, Inc. under USP5510752 and 5736897. BBE and BBE symbol are registered trademarks of BBE Sound, Inc. Manufactured under license from BBE Sound, Inc.

 HDMI, the HDMI logo and High-Definition Multimedia Interface are trademarks or registered trademarks of HDMI Licensing LLC.

\*Manufactured under license from Dolby Laboratories. "Dolby" and the double-D symbol are trademarks of Dolby Laboratories.

# Set Dimensions

**42 Inch Models (Includes Table Top Stand) Weight (lbs./kg): 98/44.5**

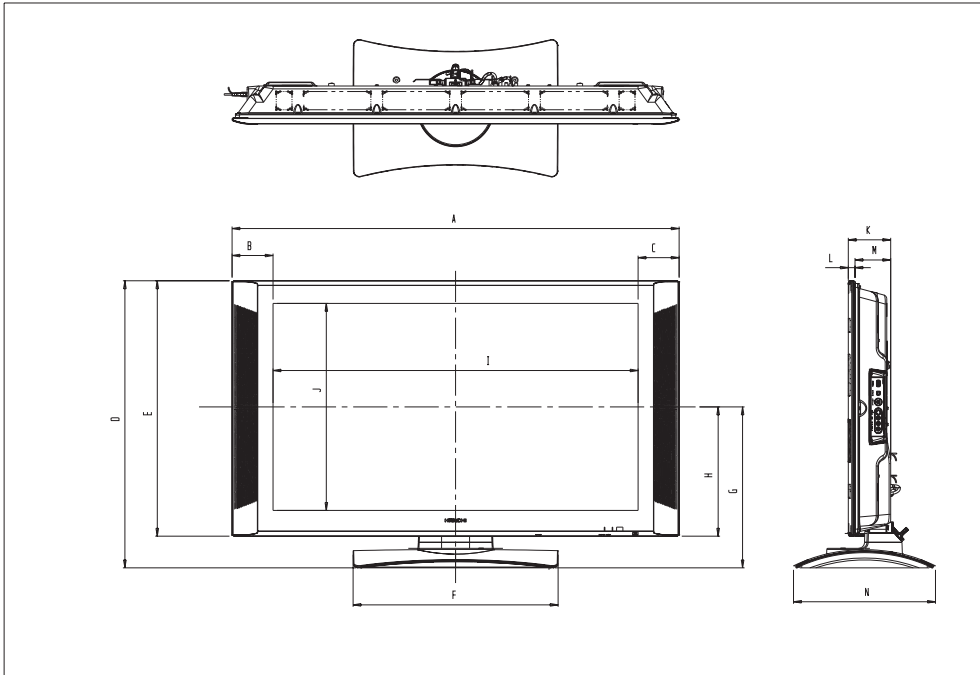

	A	B	C	D	E	F	G	H	I	J	K	L	M	N
Inches	44-5/8	4-1/8	4-1/8	28-11/16	25-1/2	20-1/2	16-1/16	12-15/16	36-7/16	20-11/16	4-1/4	11/16	3-9/16	14-3/16
mm	1134	104	104	728.2	648	520	408.2	328	926	525	107.5	17	90.5	360

**55 Inch Models (Plasma Television Only) Weight (lbs./kg): 135.6/61.5**

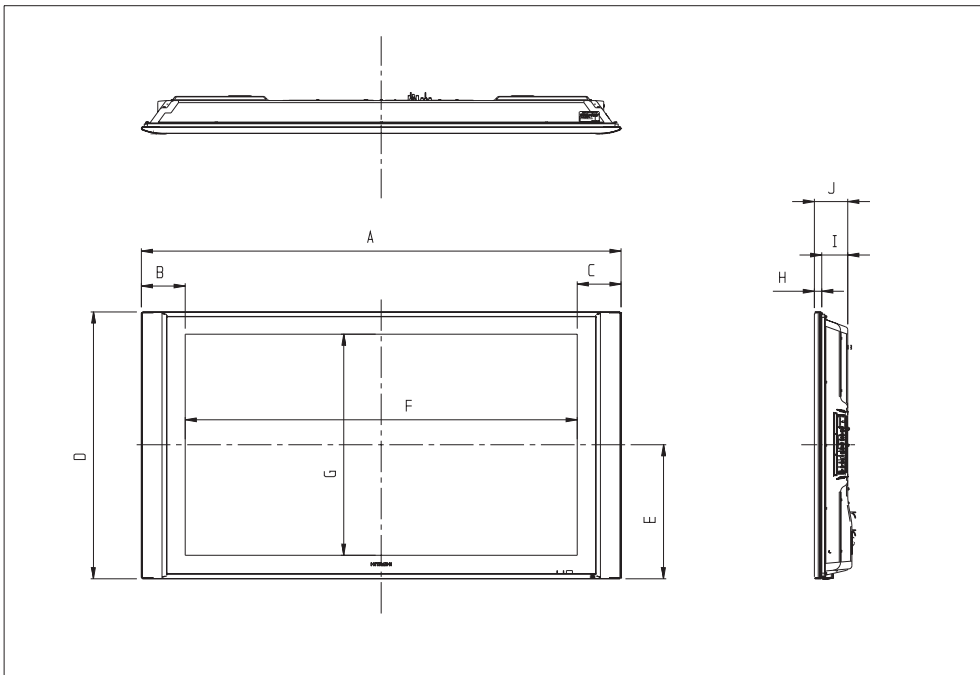

	A	B	C	D	E	F	G	H	I	J	K	L	M	N
Inches	59 7/16	5 7/16	5 7/16	33 1/16	16 5/8	48 3/16	27 3/8	7/8	3 2/8	4 1/8				
mm	1510	138	138	840	422	1234	696	23	82	105				

# HITACHI

## Inspire the Next

### Service Hotline

To locate an authorized **HITACHI** service facility in the continental U.S.A. and Canada,

**DIAL TOLL FREE**

**7 days a week, 24 hours a day**

**1-800-HITACHI**

*(1-800-448-2244)*



**HITACHI AMERICA, LTD.**  
**HOME ELECTRONICS DIVISION**

HITACHI has made every effort to assure you hours of trouble free operation from your unit. However, should you require service, a network of HITACHI Authorized Service Facilities has been established in all 50 states and Puerto Rico. Each facility will provide you with convenient and expedient assistance. Our service hotline operator will direct you to the HITACHI Authorized Service Facility nearest you. Just present proof of purchase and/or delivery receipts to the Hitachi Authorized Service Facility, and service will be rendered in accordance with the terms of the limited warranty as stated on your warranty card or operating guide.

Should you have any questions regarding warranty, service, operation, or technical assistance, please contact:

**Hitachi America, LTD.**  
**Home Electronics Division**  
**900 Hitachi Way**  
**Chula Vista, CA 91914-3556**

**HITACHI CANADA, LTD.**  
**DIGITAL MEDIA DIVISION**

Should you have any questions regarding warranty, service, operation, or technical assistance, please contact:

**In Canada: 1-800-HITACHI (1-800-448-2244)**

Monday – Friday (EST).....9:00am – 7:00pm  
Saturday (EST) .....9:00am – 5:00pm

Look for your French Manual on the outside of the box. If the manual is missing, call **1-800-HITACHI (1-800-448-2244)** for a copy.

Pour de plus amples renseignements sur le service durant la période couverte par la garantie, sur le fonctionnement ou pour de l'assistance technique communiquez avec:

**Au Canada: 1-800-HITACHI (1-800-448-2244)**

Lundi - Vendredi L'EST .....9:00am – 7:00pm  
Samedi L'EST.....9:00am – 5:00pm

La version français de votre manuel se trouve a l'exterieur de la boîte. Si le manuel est manquant, coposez le **1-800-HITACHI (1-800-448-2244)** pour obenir votre copie.

**HITACHI CANADA, LTD.**  
**2495 Meadowpine Blvd.**  
**Mississauga, Ontario L5N 6C3**

# End User License Agreement for HITACHI DTV Software

## END USER LICENSE AGREEMENT FOR HITACHI DTV SOFTWARE

**IMPORTANT – READ CAREFULLY:** This End User License Agreement for **HITACHI** DTV Software (this "Agreement") is a legal agreement between you ("you" or "your"), in your capacity as the owner of a **HITACHI** brand digital television (the "DTV"), and **HITACHI** America, Ltd., Home Electronics Division ("**HITACHI**"). By using the DTV or the operating system software installed on the DTV (the "System Software") or any Upgrade (as defined below, and together with the System Software, the "Software"), you agree to be bound by the terms and conditions of this Agreement. IF YOU DO NOT AGREE TO BE BOUND BY THIS LICENSE AGREEMENT, DO NOT USE THE DTV OR THE SOFTWARE.

1. **LICENSE GRANT.** **HITACHI** grants to you, for the life of the DTV, a non-exclusive, non-transferable, revocable license to install and use one copy of the Software on the DTV, subject to the following limitations and restrictions:
  - a. You may not share, duplicate, republish or redistribute the Software;
  - b. You may not resell, rent, lease, sublicense, gift, loan, assign or otherwise transfer the Software or any of your rights under this Agreement;
  - c. You may not modify, adapt, translate, reverse engineer, decompile, disassemble or make derivative works from the Software or use the Software in combination with any non-Hitachi software; and
  - d. You may not use the Software for any commercial purpose.
2. **VIOLATIONS; INDEMNITY.** You understand and agree that your use of the Software in any manner except as permitted under this Agreement could constitute a serious crime and could subject you to damages and an award to **HITACHI** of attorneys' fees in connection with your violation of this Agreement. You further understand that you may be held legally responsible for any copyright infringement or other violation of intellectual property rights caused or facilitated by your failure to abide by the terms of this Agreement. You agree to defend, indemnify and hold **HITACHI** and its parent and affiliate companies harmless from and against any and all liability resulting from any breach by you of this Agreement.
3. **INTELLECTUAL PROPERTY.** The Software is protected by federal copyright laws, international copyright treaties and other intellectual property laws and treaties. The Software is licensed, not sold, to you. All right, title and interest in and to the Software and any intellectual property associated therewith, including any accompanying printed materials, shall belong to **HITACHI** and its licensors and suppliers. Except as expressly provided herein, neither **HITACHI** nor any of its licensors or suppliers grants to you under this Agreement any express or implied right in or to any patents, copyrights, trademarks, trade secrets or other intellectual property. All right, title and interest in and to the intellectual property rights associated with any content that is accessible through use of the Software shall belong to the applicable content owners and may be protected by copyright or other intellectual property laws and treaties. This Agreement grants you no rights to use such content. Any rights of **HITACHI** not expressly granted to you hereunder are reserved expressly by Hitachi.
4. **SOFTWARE UPGRADES.** In the future, **HITACHI** may release or make available one or more upgrades to the System Software (each, an "Upgrade"). You understand and agree that if you decide to install or use any Upgrade, your installation and use of such Upgrade and/or any other software or intellectual property **HITACHI** may provide in connection therewith shall be governed by the terms and conditions of this Agreement, except to the extent that **HITACHI** provides different or supplementary license terms or conditions that accompany such Upgrade or other software or intellectual property. In the event **HITACHI** provides you with a "flash card" or other media to effect or facilitate an Upgrade, you understand and acknowledge that your failure to return such flash card or other media to **HITACHI** as **HITACHI** may require could result in **HITACHI** placing your name and your DTV's serial number on a "No Further Upgrades" list, which will prohibit you from receiving any subsequent Upgrades **HITACHI** may later release or make available. IF YOU DO NOT AGREE WITH ALL THE TERMS AND CONDITIONS OF THIS AGREEMENT OR ALL THE TERMS AND CONDITIONS OF ANY DIFFERENT OR SUPPLEMENTARY LICENSE THAT MAY ACCOMPANY SUCH UPGRADE, (A) DO NOT USE ANY HITACHI-PROVIDED FLASH CARD OR OTHER MEDIA, (B) DO NOT PERFORM INSTALL ANY HITACHI-PROVIDED UPGRADE SOFTWARE ON YOUR DTV, AND (C) PROMPTLY RETURN SUCH FLASH CARD OR OTHER MEDIA TO HITACHI.
5. **EXPORT RESTRICTIONS.** **HITACHI** is licensing the Software for use within North America only. You agree that you will not export or re-export the Software. You specifically agree not to export or re-export the Software: (i) to any country to which the U.S. has embargoed or restricted the export of goods or services, which currently include, but are not necessarily limited to Cuba, Iran, Libya, North Korea, Sudan and Syria, or to any national of any such country, wherever located, who intends to transmit or transport the Software back to such country; (ii) to any person or entity who you know or have reason to know will utilize the Software in the design, development, or production of nuclear, chemical, or biological weapons; or (iii) to any person or entity who has been prohibited from participating in U.S. export transactions by any federal agency of the U.S. government. You warrant and represent that neither the U.S. Bureau of Industry and Security nor any other U.S federal Agency has suspended, revoked, or denied your export privileges.
6. **NO WARRANTIES.** The software is provided to you in "as is" condition and **HITACHI** makes no warranties of any kind whatsoever regarding the software and, to the maximum extent permitted by law, hereby expressly disclaims all warranties of any kind whatsoever, express or implied, with respect to the software. All implied warranties, including without limitation, the implied warranties of non-infringement, merchantability and fitness for a particular purpose are hereby expressly disclaimed by hitachi to the maximum extent permitted by law.
7. **LIMITATION OF LIABILITY.** To the maximum extent permitted by applicable law, **HITACHI**, its licensors, suppliers, parent companies, affiliates, subsidiaries, employees and agents shall not under any circumstances be liable to you or any third parties for any damages of any nature arising in any way from this agreement, your use of the software or otherwise, whether indirect, special, incidental, consequential or otherwise, including, without limitation, any claims for lost profits, lost good will, lost data, business interruption, procurement of substitute goods or services, or expenditures made or committed for in reliance on the continuation of this agreement, even if advised in advance of the possibility of such damages.
8. **NO FAILURE OF ESSENTIAL PURPOSE.** You agree that neither **HITACHI S** breach of this agreement nor its failure to repair a defect, error or bug in the software shall constitute a failure of the essential purpose of this agreement.
9. **CRYPTOGRAPHIC SOFTWARE.** The software contains software developed by the openssl project, including cryptographic software written by eric young (the "cryptographic software"). The cryptographic software is provided by the openssl project in "as is" condition and any express or implied warranties, including but not limited to, the implied warranties of merchantability and fitness for a particular purpose are hereby expressly disclaimed to the maximum extent permitted by law. In no event shall the openssl project, its contributors, **HITACHI** or any of its parent or affiliate companies be liable for any direct, indirect, incidental, special, exemplary, or consequential damages (including, but not limited to, procurement of substitute goods or services; loss of use, data, or profits; or business interruption) however caused and on any theory of liability, whether in contract, strict liability, or tort (including negligence or otherwise) arising in any way out of the use of the software or the cryptographic software, even if advised in advance of the possibility of such damages.
10. **TERMINATION.** **HITACHI** may terminate this Agreement immediately at any time by providing notice to you.
11. **GOVERNING LAW; SEVERABILITY.** This Agreement will be governed by the laws of the State of New York, and you consent to the exclusive jurisdiction and venue in the federal courts sitting in the Southern District of New York, unless no federal subject matter jurisdiction exists, in which case you consent to the exclusive jurisdiction and venue in the Borough of Manhattan, New York, USA.

# Appendixes

## Appendix A:

IMAGE INPUT					
INPUT	TYPE	FORMAT	ASPECT	VIDEO ID	AUTO ASPECT
Air or Cable (Analog Channels)	--	NTSC	4:3	--	On/Off
INPUT 1 & 2	HDMI	480i/480p	16:9	16:9	Off
			Letter	Letter	Off
			4:3	4:3	Off
INPUT 1-5	S-Video <sup>1</sup> Video	NTSC	--	No Info.	On/Off
			16:9	16:9	Off
			Letter	Letter	Off
			4:3	4:3	Off
INPUT 3 & 4	Y-P <sub>b</sub> P <sub>r</sub>	480i/480p	16:9	16:9	Off
			Letter	Letter	Off
			4:3	4:3	Off
			--	No Info.	On/Off

<sup>1</sup>S-Video = Not available in INPUT 3 & 4

## Appendix B:

IMAGE INPUT					
INPUT	TYPE	FORMAT	ASPECT	VIDEO ID	AUTO ASPECT
Air or Cable (Digital Channels)	--	1080i	4:3	--	On/Off
INPUT 1 & 2	HDMI	480i/480p	Letter	Letter	On
			4:3	4:3	On
INPUT 1-5	S-Video <sup>2</sup> Video	NTSC	Letter	Letter	On
			4:3	4:3	On
INPUT 3 & 4	Y-P <sub>b</sub> P <sub>r</sub>	480i/480p	Letter	Letter	On
			4:3	4:3	On

<sup>2</sup>S-Video = Not available in INPUT 3 & 4

## Appendix C:

IMAGE INPUT					
INPUT	TYPE	FORMAT	ASPECT	VIDEO ID	AUTO ASPECT
INPUT 1 & 2	HDMI	480i/480p	16:9	16:9	On
INPUT 1-5	S-Video <sup>3</sup> Video	NTSC	16:9	16:9	On
			4:3	4:3	On
INPUT 3 & 4	Y-P <sub>b</sub> P <sub>r</sub>	480i/480p	16:9	16:9	On

<sup>3</sup>S-Video = Not available in INPUT 3 & 4

## Appendix D:

IMAGE INPUT					
INPUT	TYPE	FORMAT	ASPECT	VIDEO ID	AUTO ASPECT
Air or Cable (Digital Channels)	--	1080i	16:9	--	On/Off
INPUT 1 & 2	HDMI	1080i/720p	16:9	--	On/Off
INPUT 3 & 4	Y-P <sub>b</sub> P <sub>r</sub>	1080i/720p	16:9	--	On/Off



# Appendixes

## Appendix E

After the CableCARD has been successfully installed, a CableCARD Information menu appears in the **SETUP** menu of the On-Screen Display.

Follow the instructions below to access the CableCARD Information menu.

1. Press the **MENU** button on the Remote Control to access the Main Menu screen.



2. Use the **CURSOR PAD ▼** to highlight **SETUP** in the Main Menu and press the **SELECT** button.
3. Use the **CURSOR PAD ▼** to highlight **CableCARD Information** and press the **SELECT** button.

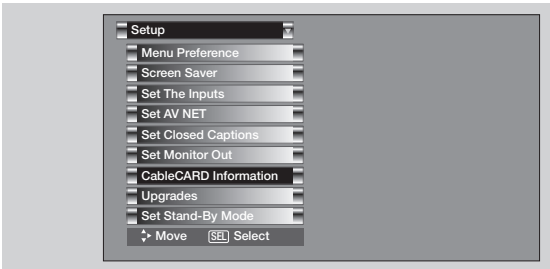

4. To view the CableCARD ID and Host ID, use the **CURSOR PAD ▼** to highlight **CableCARD Info** and press the **SELECT** button.

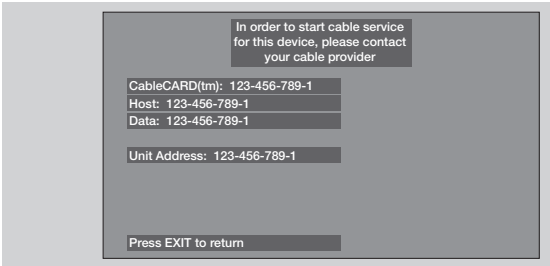
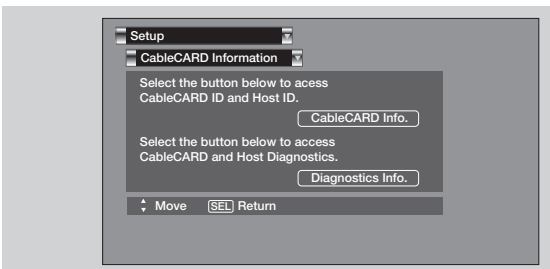

**NOTE:** The **Diagnostics Info.** window is for Service use only.

## THINGS TO CHECK WHEN USING THE CableCARD / CableCARD Services

1. Check that the CableCARD is properly inserted in the CableCARD slot.
2. Remove the CableCARD by pressing the eject button and pull the CableCARD straight out.
3. Visually inspect the CableCARD to ensure all pin-holes are in good condition, with none blocked or damaged.
4. Make sure the CableCARD is re-inserted in the correct direction, then slowly push until it is fully seated in the slot.
5. When the CableCARD is installed, note all screen messages that appear ("CableCARD Installed", "Acquiring Data", "CableCARD is not Installed"). If the "CableCARD Installed" message does not appear when card is installed, check the TV's card slot and CableCARD pins for obstructions or damage.
6. If problems still remain, please contact your Cable Service Provider.

### NOTES:

1. When a CableCARD is installed, Auto Channel scan will not be needed because the channel list is automatically loaded to the TV's channel memory.
2. The TV will take several seconds to detect and recognize the presence of the CableCARD. This process must be completed before any CableCARD information or Channel listings is accessed.

# Index

<b>A</b>		TV Ratings (Canadian - French) . . . . .	52
Accessories, . . . . .	4		
Antennas (Connecting), . . . . .	6		
Aspect Ratio, . . . . .	23, 42		
Audio			
TruBass . . . . .	44		
Audio Settings . . . . .	44		
Audio Source . . . . .	45		
Auto Noise Cancel . . . . .	45		
A/V Network . . . . .	20, 58-67		
<b>B</b>			
Balance . . . . .	44		
Bass . . . . .	44		
Black Enhancement . . . . .	42		
Black Side Panel . . . . .	43		
Brightness . . . . .	41		
<b>C</b>			
CableCARD . . . . .	12		
Caution and Safety Tips . . . . .	2-3		
Channel Manager . . . . .	46-47		
Auto Channel Scan . . . . .	46		
Clock . . . . .	53		
Closed Captions			
Captions . . . . .	68		
Color Temperature . . . . .	42		
Color . . . . .	41		
Contrast . . . . .	41		
Contrast Mode . . . . .	42		
<b>E</b>			
Event Timer . . . . .	55		
External Video Source . . . . .	13-19		
<b>F</b>			
Favorite Channel . . . . .	27		
Freeze . . . . .	8, 30		
<b>H</b>			
HDMI . . . . .	17		
<b>I</b>			
Input Setup . . . . .	58		
<b>L</b>			
Language			
Menu Language . . . . .	56		
Locks			
Change Access Code . . . . .	48		
Channel Lock . . . . .	48		
Front Panel Lock . . . . .	48		
Movie Ratings . . . . .	49		
TV Ratings . . . . .	50		
TV Ratings (Canadian - English) . . . . .	51		
<b>M</b>			
Menu Preference			
Language . . . . .	56		
Background . . . . .	57		
Monitor Out . . . . .	69		
<b>N</b>			
Noise Cancel . . . . .	45		
<b>P</b>			
Perfect Volume . . . . .	45		
Photo Input . . . . .	25-26		
Picture Mode . . . . .	41		
Picture-in-Picture (PIP) . . . . .	28-30		
Power Swivel . . . . .	4, 5, 7, 71		
<b>R</b>			
Remote Control			
Functions . . . . .	21-38		
Programming Codes . . . . .	37-38		
Installing Batteries . . . . .	4		
<b>S</b>			
Screen Saver . . . . .	57		
Sharpness . . . . .	41		
Speakers . . . . .	45		
Connecting External Speakers . . . . .	19		
Internal . . . . .	45		
Split Mode . . . . .	29		
<b>T</b>			
Timers . . . . .	53-55		
Tint . . . . .	41		
Treble . . . . .	44		
<b>V</b>			
Video Settings . . . . .	41-43		



## Notes



## Notes



# HITACHI

Inspire the Next