

Register your product and get support at
www.philips.com/support

55PFL5907
50PFL5907
46PFL5907
42PFL5907



EN User Manual

ES Manual del Usuario

FR Manuel d'Utilisation

EN: For further assistance, call the customer support service in your country.

- To obtain assistance, contact Philips Customer Care Center;
In the U.S.A., Canada, Puerto Rico, or the U.S. Virgin Islands **1 866 309 0843**
México D.F. and Área Metropolitana: **58 87 97 36**
Interior de la Republica; **01 800 839 19 89**

ES: Para obtener más información, llame al servicio de soporte al cliente de su país.

- Para obtener asistencia, comuníquese con Centro de atención al cliente de Philips;
En los Estados Unidos, en Canadá, Puerto Rico o en las Islas Vírgenes de los Estados Unidos; **1 866 309 0843**
México D.F. y Área Metropolitana: **58 87 97 36**
Interior de la Republica; **01 800 839 19 89**

FR: Pour obtenir de l'aide supplémentaire, communiquez avec le centre de service à la clientèle de votre pays.

- Pour obtenir de l'aide, communiquez avec le centre de service à la clientèle Philips au;
Dans le États-Unis, au Canada, à Puerto Rico ou aux Îles Vierges américaines; **1 866 309 0843**
México D.F. et Área Metropolitana; **58 87 97 36**
Interior de la Republica; **01 800 839 19 89**

PHILIPS

Contents

1 Notice	5	Software	43
2 Important	7	Checking your current software version	43
Positioning the TV	7	Preparing for the software upgrade	43
Regulatory notices	7	Upgrading the software	44
Environmental care	7	Automatically check for latest software	44
3 Get started	8	Netflix deactivation	44
Features	8	Netflix ESN	44
Supplied accessories	8	VUDU deactivation	44
Symbols used in this User Manual	8	YouTube deactivation	44
Attaching the base	9	Hulu Plus deactivation	44
Managing cables	9	6 Connecting devices	45
Installing the remote control batteries	9	Selecting your connection quality	45
Remote control function	10	Connecting your devices	45
Control panel	11	7 Useful tips	49
Terminals	11	FAQ	49
Connecting the antenna or the cable	12	Troubleshooting	49
Plugging in the AC power cord	12	8 Information	52
Initial setup	13	Glossary	52
4 Use your TV	15	Maintenance	52
Switching on your TV and putting it in Standby mode	15	9 Specifications	53
Adjusting volume	15	10 Warranty	54
Switching channels	15	License	end of book
Watching channels from an external device	16		
Access the Home menu	16		
Philips Wireless MediaConnect	17		
View photos, play music and watch videos using DLNA	17		
Net TV	19		
Enjoying vTuner	20		
Pandora® operations	22		
Using Twitter	23		
Using auto mode	25		
Create and use lists of favorite channels	25		
Sleep timer	25		
Changing picture format	26		
TV screen information	26		
USB	27		
5 Use more of your TV	29		
Picture	30		
Sound	32		
Features	33		
Caption settings	33		
Sleeptimer	34		
Child and ratings lock	34		
Change PIN	36		
Installation	36		
Language	36		
Channel installation	37		
Preferences	38		
Use Philips EasyLink	38		
Network	40		
Return your settings to default values	43		

Return your Product Registration Card or visit at <http://www.productrecords.com/philips/> today to get the very most from your purchase.

Registering your model with Philips makes you eligible for all of the valuable benefits listed below, so don't miss out. Complete and return your Product Registration Card at once **or visit at www.philips.com/support** to ensure:

*Product Safety Notification

By registering your product, you'll receive notification - directly from the manufacturer - in the rare case of a product recall or safety defect.

*Additional Benefits

Registering your product guarantees that you'll receive all of the privileges to which you're entitled, including special money-saving offers.

Know these **safety** symbols



The caution marking is located on the rear or bottom of the cabinet.



The lightning flash with arrowhead symbol, within an equilateral triangle, is intended to alert the user to the presence of uninsulated "dangerous voltage" within the apparatus's enclosure that may be of sufficient magnitude to constitute a risk of electric shock to persons.



The exclamation point within an equilateral triangle is intended to alert the user to the presence of important operating and maintenance (servicing) instructions in the literature accompanying the apparatus.

WARNING: To reduce the risk of fire or electric shock, do not expose this apparatus to rain or moisture. Apparatus shall not be exposed to dripping or splashing and no objects filled with liquids, such as vases, shall be placed on the apparatus.

ATTENTION: Pour éviter les choc électriques, introduire la lame la plus large de la fiche dans la borne correspondante de la prise et pousser jusqu'au fond.

PHILIPS Visit our World Wide Web Site at www.philips.com/support

CHILD SAFETY:

It Makes A Difference How and Where You Use Your Flat Panel Display

Congratulations on your purchase! As you enjoy your new product, please keep these safety tips in mind:



THE ISSUE

- The home theater entertainment experience is a growing trend and larger flat panel displays are popular purchases. However, flat panel displays are not always supported on the proper stands or installed according to the manufacturer's recommendations.
- Flat panel displays that are inappropriately situated on dressers, bookcases, shelves, desks, speakers, chests or carts may fall over and cause injury.

THIS MANUFACTURER CARES!

- The consumer electronics industry is committed to making home entertainment enjoyable and safe.

TUNE INTO SAFETY

- One size does NOT fit all. Follow the manufacturer's recommendations for the safe installation and use of your flat panel display.
- Carefully read and understand all enclosed instructions for proper use of this product.
- Do not allow children to climb on or play with furniture that the television set is sitting on or mounted to.
- Don't place flat panel displays on furniture that can easily be used as steps, such as a chest of drawers.
- Remember that children can become excited while watching a program, especially on a "larger than life" flat panel display. Care should be taken to place or install the display where it cannot be pushed, pulled over, or knocked down.
- Care should be taken to route all cords and cables connected to the flat panel display so that they cannot be pulled or grabbed by curious children.

WALL MOUNTING: IF YOU DECIDE TO WALL MOUNT YOUR FLAT PANEL DISPLAY, ALWAYS:

- Use a mount that has been recommended by the display manufacturer and/or listed by an independent laboratory (such as UL, CSA, ETL).
- Follow all instructions supplied by the display and wall mount manufacturers.
- If you have any doubts about your ability to safely install your flat panel display, contact your retailer about professional installation.
- Make sure that the wall where you are mounting the display is appropriate. Some wall mounts are not designed to be mounted to walls with steel studs or old cinder block construction. If you are unsure, contact a professional installer.
- A minimum of two people are required for installation. Flat panel displays can be heavy.

Important Safety Instructions

1. Read these instructions.
2. Keep these instructions.
3. Heed all warnings.
4. Follow all instructions.
5. Do not use this apparatus near water.
6. Clean only with dry cloth.
7. Do not block any ventilation openings. Install in accordance with the manufacturer's instructions.
8. Do not install near any heat sources such as radiators, heat registers, stoves, or other apparatus (including amplifiers) that produce heat.
9. Do not defeat the safety purpose of the polarized or grounding-type plug. A polarized plug has two blades with one wider than the other. A grounding type plug has two blades and a third grounding prong. The wide blade or the third prong are provided for your safety. If the provided plug does not fit into your outlet, consult an electrician for replacement of the obsolete outlet.
10. Protect the power cord from being walked on or pinched particularly at plugs, convenience receptacles, and the point where they exit from the apparatus.
11. Only use attachments/accessories specified by the manufacturer.
12. Use only with the cart, stand, tripod, bracket, or table specified by the manufacturer, or sold with the apparatus. When a cart is used, use caution when moving the cart/apparatus combination to avoid injury from tip-over. 
13. Unplug this apparatus during lightning storms or when unused for long periods of time.
14. Refer all servicing to qualified service personnel. Servicing is required when the apparatus has been damaged in any way, such as power-supply cord or plug is damaged, liquid has been spilled or objects have fallen into the apparatus, the apparatus has been exposed to rain or moisture, does not operate normally, or has been dropped.

Note to the CATV system installer:

This reminder is provided to call the CATV system installer's attention to Article 820-40 of the NEC that provides guidelines for proper grounding and, in particular, specifies that the cable ground shall be connected to the grounding system of the building, as close to the point of cable entry as practical.

Example of Antenna Grounding as per NEC – National Electric Code

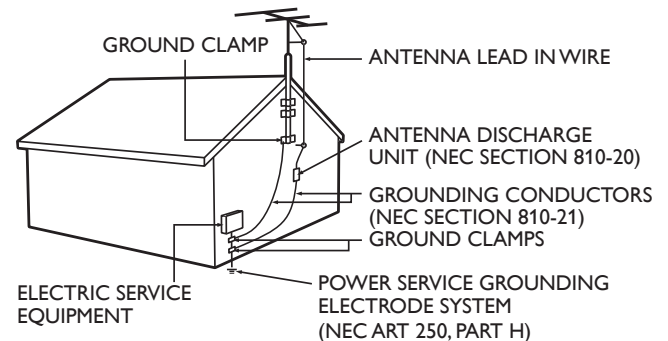

Wall Mount Bracket Kit

Brand: PHILIPS

	Model #	Screw dimension
55PFL5907 50PFL5907 46PFL5907 42PFL5907	SQM6485/17	M6 x 0.71" (18mm) with space

- For use only with UL listed Wall Mount Bracket.
- The recommended Wall Mount Bracket Kit (sold separately) allows the mounting of the TV on the wall.
- For detailed information on installing the wall mount, refer to the Wall Mount Instruction Book.
- P&F USA is not responsible for any damage to the product or injury to yourself or others if you elect to install the TV Wall Mount Bracket or mount the TV onto the Bracket on your own.
- The Wall Mount Bracket must be installed by experts.

P&F USA is not liable for these types of accidents or injury noted below.

- Install the Wall Mount Bracket on a sturdy vertical wall.
- If installed onto a ceiling or slanted wall, the TV and Wall Mount Bracket may fall which could result in a severe injury.
- Do not use screws that are longer or shorter than their specified length. If screws too long are used this may cause mechanical or electrical damage inside the TV set. If screws too short are used this may cause the TV set to fall.
- Do not fasten the screws by excessive force. This may damage the product or cause the product to fall, leading to an injury.
- For safety reasons use 2 people to mount the TV onto a Wall Mounting Bracket.
- Do not mount the TV onto the Wall Mounting Bracket while your TV is plugged in or Turned On. It may result in an electrical shock injury.

When installing the unit on the wall, allow this much space.

Top:	11.8 inches (30cm)
Left and right side:	5.9 inches (15cm)
Bottom:	3.9 inches (10cm)

1 Notice

Trademarks are the property of Koninklijke Philips Electronics N.V. or their respective owners.

P&F USA reserves the right to change products at any time without being obliged to adjust earlier supplies accordingly.

The material in this User Manual is believed adequate for the intended use of the system. If the product or its individual modules or procedures are used for purposes other than those specified herein, confirmation of their validity and suitability must be obtained. P&F USA warrants that the material itself does not infringe any United States patents. No further warranty is expressed or implied.

P&F USA cannot be held responsible neither for any errors in the content of this document nor for any problems as a result of the content in this document. Errors reported to P&F USA will be adapted and published on the P&F USA support website as soon as possible.

Pixel characteristics

This LCD product has a high number of color pixels. Although it has effective pixels of 99.999% or more, black dots or bright points of light (red, green or blue) may appear constantly on the screen. This is a structural property of the display (within common industry standards) and is not a malfunction.

Warranty

No components are user serviceable. Do not open or remove covers to the inside of the product. Repairs may only be done by Service Centers and official repair shops. Failure to do so shall void any warranty, stated or implied.

Any operation expressly prohibited in this User Manual, any adjustments or assembly procedures not recommended or authorized in this User Manual shall void the warranty.

Federal Communications Commission Notice

This equipment has been tested and found to comply with the limits for a Class B Digital device, pursuant to part 15 of the FCC Rules. These limits are designed to provide reasonable protection against harmful interference in a residential installation. This equipment generates, uses and can radiate radio frequency energy and, if not installed and used in accordance with the instructions, may cause harmful interference to radio communications. However, there is no guarantee that interference will not occur in a particular installation. If this equipment does cause harmful interference to radio or television reception, which can be determined by Turning the equipment Off and On, the user is encouraged to try to correct the interference by one or more of the following measures:

- Reorient or relocate the receiving antenna.
- Increase the separation between the equipment and the receiver.
- Connect the equipment into an outlet on a circuit different from that to which the receiver is connected.
- Consult the dealer or an experienced radio or television technician for help.

Declaration of Conformity

Trade Name: PHILIPS
Responsible Party: P&F USA, Inc.
Model: 55PFL5907/50PFL5907/46PFL5907/42PFL5907
Address: PO Box 2248, Alpharetta, GA 30023-2248
 U.S.A.
Telephone Number: 1 866 309 0843

Modifications

This apparatus may generate or use radio frequency energy. Changes or modifications to this apparatus may cause harmful interference unless the modifications are expressly approved in the User Manual. The user could lose the authority to operate this apparatus if an unauthorized change or modification is made.

Cables

Connections to this device must be made with shielded cables with metallic RFI/EMI connector hoods to maintain compliance with FCC Rules and Regulations.

Canadian notice

This Class B Digital apparatus complies with Canadian ICES-003. Standard Television Receiving Apparatus, Canada BETS-7/NTMR-7.

FCC Caution: Changes or modifications not expressly approved by the party responsible for compliance could void the user's authority to operate this equipment.

This transmitter must not be co-located or operating in conjunction with any other antenna or transmitter.

Country Code Statement

For product available in the USA market, only channel 1~11 can be operated. Selection of other channels is not possible.

To maintain compliance with FCC RF exposure requirements, use only belt-clips, holsters or similar accessories that do not contain metallic components in its assembly. The use of accessories that do not satisfy these requirements may not comply with FCC RF exposure requirements and should be avoided.

FCC Radiation Exposure Statement

This equipment is compliance with SAR for general population/uncontrolled exposure limits in ANSI/IEEE C95.1-1999 and had been tested in accordance with the measurement methods and procedures specified in OET Bulletin 65 Supplement C. This equipment should be installed and operated with minimum distance 2.5cm between the radiator & your body.

This device complies with Industry Canada license-exempt RSS standard(s). Operation is subject to the following two conditions: (1) this device may not cause interference and (2) this device must accept any interference, including interference that may cause undesired operation of the device.

This equipment complies with FCC radiation exposure limits set forth for an uncontrolled environment and meets the FCC radio frequency (RF) Exposure Guidelines in Supplement C to OET65. This equipment has very low levels of RF energy that it deemed to comply without maximum permissive exposure evaluation (MPE). But it is desirable that it should be installed and operated keeping the radiator at least 20cm or more away from person's body (excluding extremities: hands, wrists, feet and ankles).

Copyright

All other registered and unregistered trademarks are the property of their respective owners.



The terms HDMI and HDMI High-Definition Multimedia Interface, and the HDMI Logo are trademarks or registered trademarks of HDMI Licensing LLC in the United States and other countries.



Manufactured under license from Dolby Laboratories. Dolby and the double-D symbol are trademarks of Dolby Laboratories.



SRS[®] is a trademark of SRS Labs, Inc. TruSurround HD technology is incorporated under license from SRS Labs, Inc. SRS TruSurround HD[™] creates an immersive, feature-rich surround sound experience from two speakers, complete with rich bass, high frequency detail and clear dialog.



ENERGY STAR[®] is a joint program of the U.S. Environmental Protection Agency and the U.S. Department of Energy helping us all save money and protect the environment through energy efficient products and practices.

Consumer Notice:

This TV has been set to maximize energy efficiency while delivering the best possible picture using the factory installed home mode settings. Changing or enabling other features in this TV (e.g. brightened backlighting) will possibly increase energy consumption beyond the original ENERGY STAR[®] qualified limits.



DLNA[®], the DLNA Logo and DLNA CERTIFIED[®] are trademarks, service marks, or certification marks of the Digital Living Network Alliance.



Netflix and the Netflix logo are trademarks or registered trademarks of Netflix, Inc.



Film Fresh and the Film Fresh logo are registered trademarks of Film Fresh Inc.



VUDU[™] is a trademark of VUDU, Inc.



YouTube and the YouTube logo are trademarks of Google Inc.



CloudTV[™] (CloudTV[™] by ActiveVideo[®]) technology provided under license from ActiveVideo Networks, Inc. U.S. and Foreign Patents apply. CloudTV[™] and the "CloudTV[™]" logo are proprietary trademarks of ActiveVideo Networks, Inc.



PANDORA, the PANDORA logo, and the Pandora trade dress are trademarks or registered trademarks of Pandora Media, Inc. Used with permission.



Twitter is a trademark of Twitter, Inc.



vTuner is a trademark of Nothing Else Matters Software, Ltd.



Hulu, the Hulu logo, www.hulu.com, and other Hulu marks, graphics, logos, scripts, and sounds are trademarks of Hulu. None of the Hulu trademarks may be copied, downloaded, or otherwise exploited.



CinemaNow and the CinemaNow logo are trademarks of BestBuy Stores L.P. and BestBuy Canada LTD.

Portions of this software are copyright © The FreeType Project (www.freetype.org).

The American Academy of Pediatrics discourages television viewing for children younger than two years of age.

2 Important

Positioning the TV

- Large screen TVs are heavy. 2 people are required to carry and handle a large screen TV.
- Make sure to hold the upper and bottom frames of the unit firmly as illustrated.
- Install the unit in a horizontal and stable position.
- Do not install the unit in direct sunlight or in a place subject to dust or strong vibration.
- Depending on the environment, the temperature of this unit may increase slightly. This is not a malfunction.
- Avoid a place with drastic temperature changes.
- Do not place anything directly on top or bottom of the unit.
- Depending on your external devices, noise or disturbance of the picture and/or sound may be generated if the unit is placed too close to them. In this case, please ensure enough space between the external devices and the unit.
- Do not insert the AC power cord into the power socket outlet before all the connections are made.
- Ensure that you always have easy access to the AC power cord or plug to disconnect the TV from the power.
- Before you move the TV, disconnect attached cables to prevent damage to connectors.
- Be sure to unplug the AC power cord from the AC outlet before moving or carrying the unit.

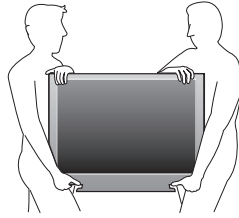

Environmental care



The packaging of this product is intended to be recycled. Contact your local authorities for information about how to recycle the packaging. For product recycling information, please visit - www.recycle.philips.com

End of life directives



Philips pays a lot of attention to produce environment-friendly products in green focal areas. Your new TV contains materials which can be recycled and reused. At the end of its life, specialized companies can dismantle the discarded TV to concentrate the reusable materials and to minimize the amount of materials to be disposed of. Please ensure you dispose of your old TV according to local regulations.

Disposal of used batteries

The batteries supplied do not contain the heavy metals mercury and cadmium. Nevertheless, in many areas batteries may not be disposed of with your household waste. Please ensure you dispose of batteries according to local regulations.

Regulatory notices

Do not place the unit on the furniture that is capable of being tilted by a child and an adult leaning, pulling, standing or climbing on it. A falling unit can cause serious injury or even death.

This apparatus should not be placed in a built-in installation such as a bookcase or rack unless proper ventilation is provided.

Make sure to leave a space of 4 inches (10cm) or more around this apparatus.

Press  to Turn the unit On and go into Standby mode.

To completely Turn Off the unit, you must unplug the AC power cord. Disconnect the AC plug to shut the unit off when trouble is found or not in use. The AC plug shall remain readily available.

Never use a gas duster on this TV.

The gas trapped inside of this unit may cause ignition and explosion.

CAUTION: Danger of explosion if battery is incorrectly replaced. Replace only with the same or equivalent type.

WARNING: Batteries (battery pack or battery installed) shall not be exposed to excessive heat such as sunshine, fire or the like.

WARNING: To prevent injury, this apparatus must be securely attached to the furniture/wall in accordance with the instructions. Tipping, shaking or rocking the unit may cause injury/death.

3 Get started

Features

- **DTV/TV/CATV**
You can use your remote control to select channels which are broadcast in Digital format and conventional Analog format. Also, cable subscribers can access their cable TV channels.
- **Information display**
You can display the title, contents and other information of the current program on the TV screen.
- **AutoProgram**
This unit automatically scans and memorizes channels available in your area, eliminating difficult setup procedures.
- **Net TV**
This unit lets you enjoy Internet services. Use the remote control to browse the Net TV pages. You can play movies and much more, all from your TV screen.
- **Child lock**
This feature allows you to block children's access to inappropriate programs.
- **Closed Caption decoder**
Built-in Closed Caption decoder displays text for Closed Caption supported programs.
- **MTS/SAP tuner**
Audio can be selected from the remote control.
- **Auto Standby**
If there is no Input signal and no operation for 15 minutes, the unit will go into Standby mode automatically.
- **Sleep timer**
You can set the unit to go into Standby mode after a specific amount of time.
- **Choices for on-screen language**
Select your on-screen language: English, Spanish or French.
- **Stereo sound function**
- **PLL frequency synthesized tuning**
Provides free and easy channel selection and lets you tune directly to any channel using the number and decimal point "•" buttons on the remote control.
- **Various adjustment for picture and sound**
Customizes image quality suitable for your room and sets your sound preference.
- **EasyLink via HDMI link**
EasyLink allows your other HDMI link devices to be controlled by the HDMI cable connected to your TV.
- **HDMI Input**
- **HDMI-DVI Input**
If your video device has DVI Output jack, use an HDMI-DVI conversion cable to connect the unit.
- **Component Video Input**
- **PC Input**
- **AV Input**
- **USB terminal**
The picture (JPEG), music (MP3) and video files stored on a USB Memory Stick can be played back on this unit.
- **Digital Audio Output**
- **Headphone Audio Output**
- **Digital Natural Motion (120Hz)**
It uses frame interpolation to make the video appear smooth which causes a video lag of about 200 milliseconds.

Supplied accessories

User Manual



Quick Start guide



Registration card



Remote Control and batteries (AAA, 1.5V x 2)

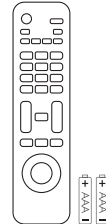

TV base and screws

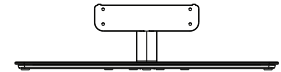

Screws packed with this unit:

Model	Quantity	Size
55PFL5907	4	M6 x 18
50PFL5907		
46PFL5907		
42PFL5907		

Cable management tie

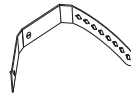

Audio/Composite/Component dongle

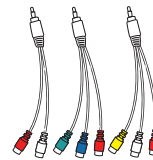

AC power cord



Note

- If you lose the screws, please purchase the above-mentioned Phillips head screws at your local store.
- If you need to replace these accessories, please refer to the part name or No. with the illustrations and call our toll free customer support line found on the cover of this User Manual.

When using a universal remote control to operate this unit.

- Make sure the component code on your universal remote control is set to our brand. Refer to the instruction book accompanying your remote control for more details.
- We do not guarantee 100% interoperability with all universal remote controls.

Symbols used in this User Manual

The following is the description for the symbols used in this User Manual. Description refers to:

Digital TV operation

Analog/Cable TV operation

- If neither symbol appears, the operation is applicable to both.

Attaching the base

You must attach the base to the unit to have it as a table top unit. Be sure the front and rear of the base match the proper direction. For large screen TVs, at least 2 people are required for these steps.

1

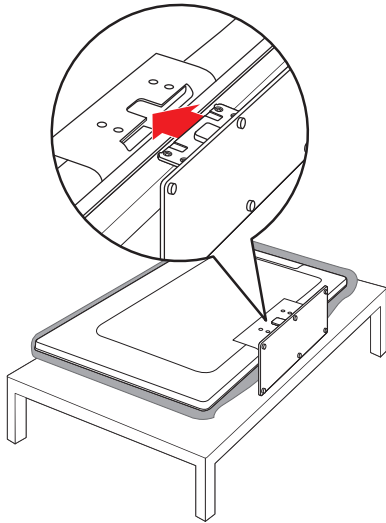

2

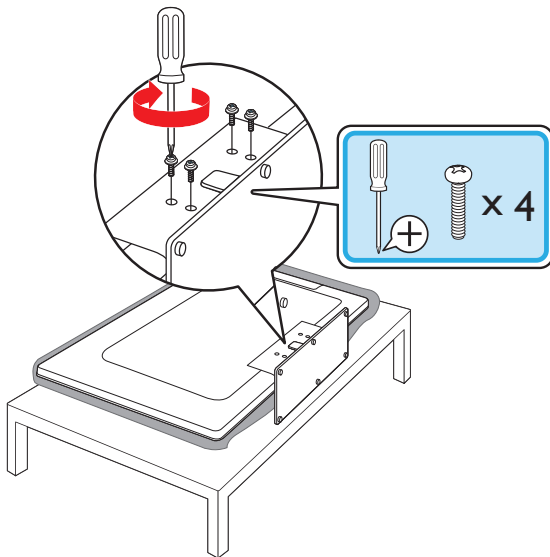

Note

- Make sure to use a table which can support the weight of this unit and is larger than this unit.
- Make sure the table is in a stable location.
- When attaching the base, ensure that "FRONT" with "arrow" written on the bottom of the base is downward.
- When attaching the base, ensure that all screws are tightly fastened. If the base is not properly attached, it could cause the unit to fall, resulting in injuries as well as damage to the unit.
- To remove the base from this unit, unscrew the Phillips head screws in step 2. Be careful not to drop the base when you remove it.

Managing cables

Route your antenna cable and all other cables through the cable management tie at the back of the TV. The holder helps keep your cables tidy and easily manageable.

1 Attach the cable management tie as illustrated below.

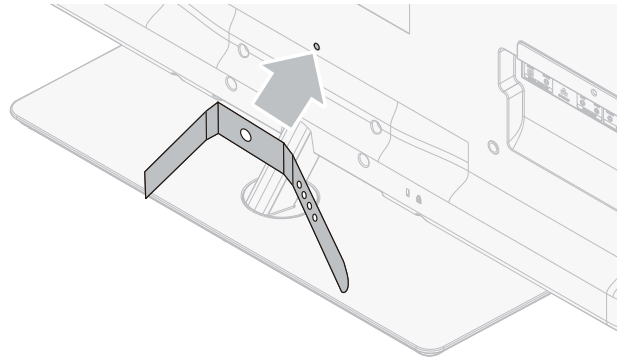

2 Pass cables through the cable management tie to avoid tangles.

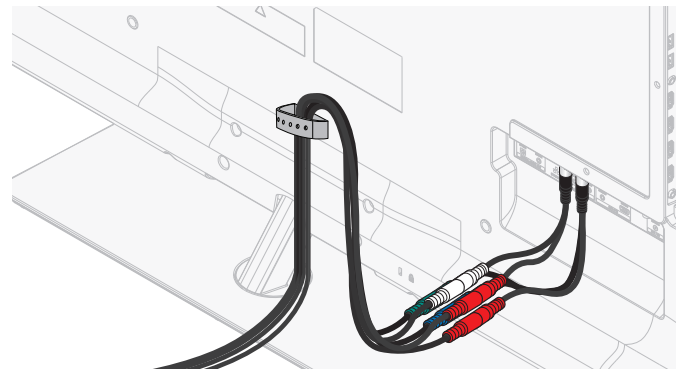

Installing the remote control batteries

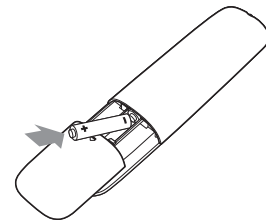

- 1 Slide the battery cover off the back of the remote control.
- 2 Insert the 2 supplied batteries (AAA, 1.5V). Be sure the + and - ends of the batteries line up with the markings inside the case.
- 3 Slide the cover back into position.

Note

- Remove the batteries if not using the remote control for an extended period of time.

Remote control function

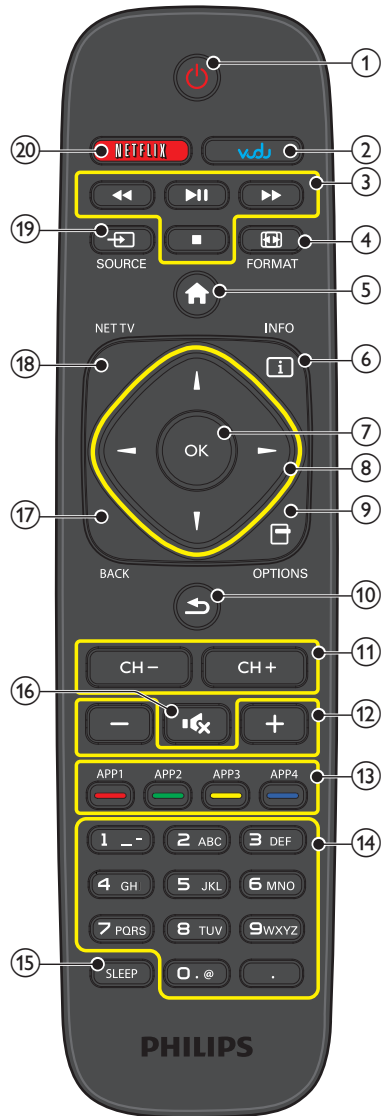

- ① **⏻ (POWER-ON/STANDBY-ON)**
Press to Turn the unit On and go into Standby mode.
To completely Turn Off the unit, you must unplug the AC power cord.
- ② **VUDU**
Access to VUDU directly.
- ③ **EasyLink(HDMI CEC) buttons**
Functionally useful for EasyLink(HDMI CEC), Net service and DLNA.
 - ◀◀/▶▶ Press to search backward or forward through the disc.
 - ▶▶ Press to start, pause or resume playback.
 - Press to stop the disc playback.
- ④ **FORMAT**
Selects a picture format.
- ⑤ **⏠ (MENU)**
Press to display the Home menu.
- ⑥ **INFO** **INFO**
Displays information about the TV channel or accessory device.
- ⑦ **OK**
Press to decide the command of setting when the Home menu is displayed.
- ⑧ **▲▼◀▶ (NAVIGATION buttons)**
Press to move left/right/up/down through the items.
- ⑨ **□ (OPTIONS)**
Displays a list of menu items applicable to the highlighted object or screen.
- ⑩ **↶ (PREV.CH)**
Press to return to the previously viewed channel.
- ⑪ **CH +/-**
Press to select channels.
- ⑫ **+/- (VOLUME)**
Press to adjust the volume.
- ⑬ **Apps (App1/App2/App3/App4) buttons**
Works as direct access to user specified net apps.
- ⑭ **0-9 (NUMBER buttons)**
Press to select channels.
 - (DOT) Press to shift the subchannel from the main channel.
- ⑮ **SLEEP**
Press to activate the sleep timer.
- ⑯ **🔇 (MUTE)**
Press to Turn the sound On and Off.
- ⑰ **BACK**
Press to return to the previous menu operation.
- ⑱ **NET TV**
Access to Net TV menu directly.
- ⑲ **📺 SOURCE**
Toggles to select connected devices.
- ⑳ **NETFLIX**
Access to Netflix directly.

Control panel

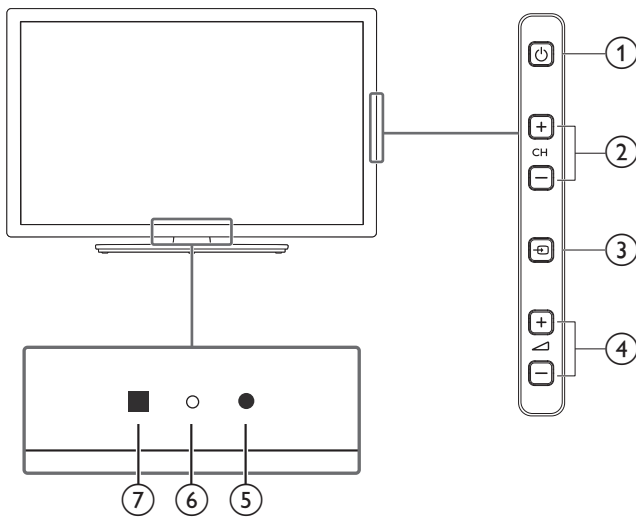

- ① **⏻ (POWER/STANDBY)**
Press ϕ to Turn the unit On and go into Standby mode.
To completely Turn Off the unit, you must unplug the AC power cord.
- ② **CH +/-**
Press to select channels or to move up (+)/ down (-) when selecting menu items.
- ③ **SOURCE**
Toggle to select the connected devices.
Press to decide the command of setting when selecting menu items.
- ④ **VOLUME -/+**
Press to adjust volume down (-)/up (+) or to move left (-)/right (+) when selecting menu items.
- ⑤ **Ambient light sensor**
Alters the brightness of the TV screen automatically by detecting your room lighting level. Do not block the light sensor allowing it to work properly.
- ⑥ **Power On indicator**
Lights up white when the unit is Turned On and flashes while the unit is Turning On.
- ⑦ **Infrared sensor**
Receives IR signals from remote control.

Terminals

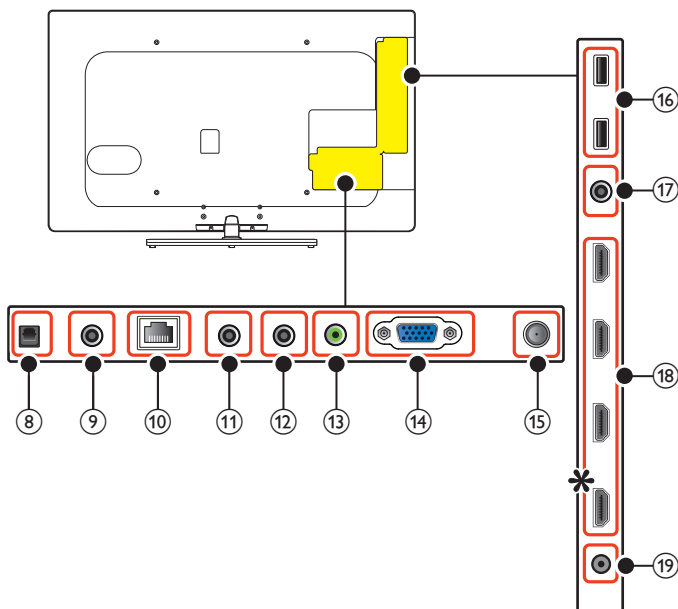

- ⑧ **Digital Audio Optical Output jack**
Digital Audio Optical Output to home theaters and other Digital Audio systems.
- ⑨ **Digital Audio Output jack**
Digital Audio (S/PDIF) Output to home theaters and other Digital Audio systems.
- ⑩ **Ethernet port**
For Internet connection using an Ethernet cable with an RJ-45 connector.
- ⑪ **Component Audio Input jacks**
Component Analog Audio (L/R) jacks signal.
- ⑫ **Component Video Input jacks**
- ⑬ **PC Audio Input jack**
PC Analog Audio jack signal with Stereo mini 3.5mm plug Audio cable on PC.
- ⑭ **VGA cable connection for PC**
- ⑮ **75 ohm Cable/Antenna connection**
Signal Input from an antenna, cable or satellite.
- ⑯ **USB terminal**
Data Input from USB Memory Stick only.
Do not connect any device to this terminal such as; Digital camera, keyboard, mouse, etc.
- ⑰ **Composite (VIDEO) Video and Audio Input jacks for VIDEO**
Composite Video / Analog Audio (L/R) jacks signal.
- ⑱ **HDMI Input jacks**
Digital Audio and video Input from high definition Digital devices such as Blu-ray disc players, cable boxes and satellite set-top boxes.
- * For HDMI 1 only
In addition to normal HDMI and HDMI-DVI functionality, it outputs TV Audio to an HDMI-ARC-compliant device, such as a home theater system.
- ⑲ **Headphone Audio Output jack**
Headphone 3.5mm stereo jack for personal listening.

Connecting the antenna or the cable

Be sure your antenna or other device is connected properly before plugging in the AC power cord.

If you connect to an antenna through RF cable

Any DTV programs that are broadcast in your area can be received for free through an antenna connection.

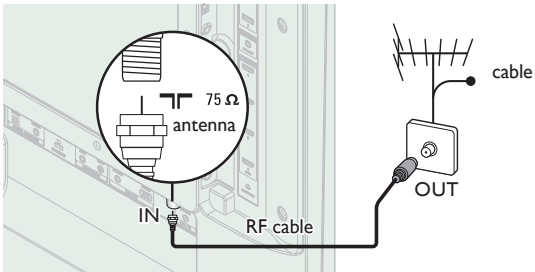

If you connect a set-top box through RF cable

If the TV is connected to a cable box or satellite set-top box via a coaxial connection, set the TV to channel 3, 4 or the channel specified by the service provider.

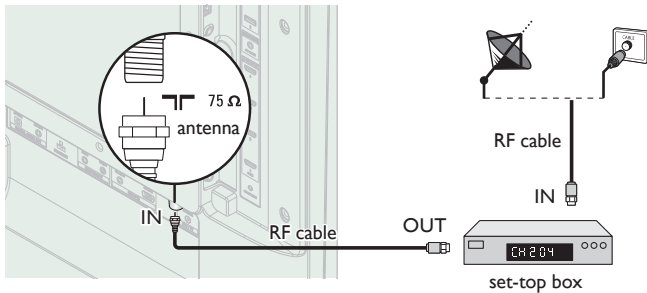

If you connect a set-top box through HDMI

If the TV is connected to a cable box or satellite set-top box via HDMI, make sure you select the correct Source by using **SOURCE**.

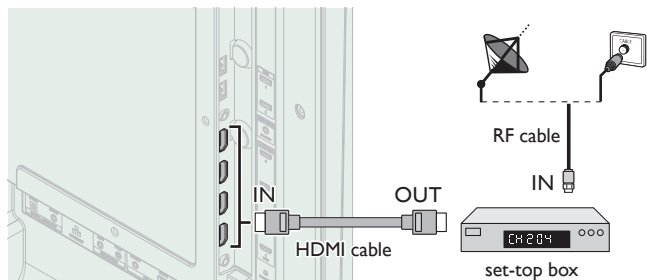

If you connect a set-top box through Component Video Input

If the TV is connected to a cable box or satellite set-top box via Component Video Input, make sure you select the correct Component Video Source by using **SOURCE**.

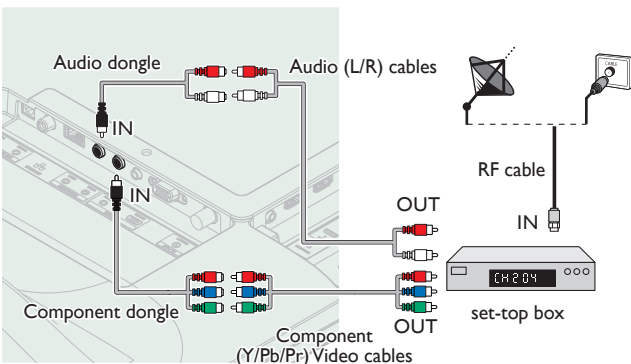

Connecting a set-top box, Blu-ray/DVD recorder via composite connectors and Analog Audio

Do not place your recorder too close to the screen because some recorders can be susceptible to signals.

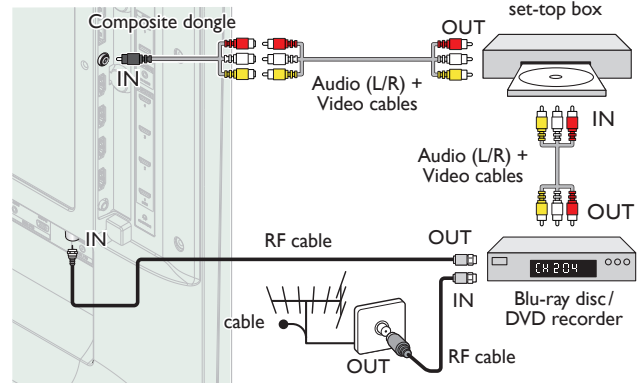

Note

- If you have any question about the DTV's antenna, visit www.antennaweb.org for further information.
- Depending on your antenna system, you may need different types of combiners (mixers) or separators (splitters) for HDTV signal. The minimum RF bandpass on these devices is 2,000MHz or 2GHz.
- For your safety and to avoid damage to this unit, please unplug the RF coaxial cable from the antenna Input jack before moving the unit.
- If you did use an antenna to receive Analog TV, it should also work for DTV reception. Outdoor or attic antennas will be more effective than a set-top box or inside antenna.
- To Turn On your reception source easily between antenna and cable, install an antenna selector.
- If you are not receiving a signal from your cable service, contact the Cable provider.
- Only the left loudspeaker reproduces sound for mono equipment. Use a mono to stereo adapter (not supplied) for sound reproduction via all internal loudspeakers.

Plugging in the AC power cord

Make sure that the AC power cord must be plugged to an AC outlet after all the necessary connections are made.

Caution

- Do not connect the AC power cord to a power supply outside the indicated voltage of this unit (AC 120V~240V).
- Connecting the AC power cord to a power supply outside of this range may result in fire or electrical shocks.

Note

- Each time you plug in the AC power cord, no operations will be performed for a few seconds. This is not a malfunction.

*These operations are accessible by remote control.
Some may also be accessible by control panel on the main unit.*

Initial setup

This section will guide you through the unit's initial setting which includes selecting a language for your on-screen menu, country, location and AutoProgram, which automatically scans and memorizes viewable channels. You can also set the network connection in this setting.

Before you begin:

Make sure the unit is connected to antenna or cable.

- After making all the necessary connections, press **Power** to Turn On the unit.
 - It may take a few moments to Turn On the unit for the first time.
 - Initial setup menu appears automatically after the unit is Turned On.
- Use **▲▼** to select the on-screen language, country, location on the right side of the TV screen, then press **OK**.
 - You must set **Home** in location setting. Otherwise, **Picture** and **Sound** settings you adjusted will not be memorized after the unit goes into Standby mode.
- Use **▲▼** to select the signal type.
 - If the TV is connected to a cable box or satellite set-top box, select the 2nd one and skip to step 5.

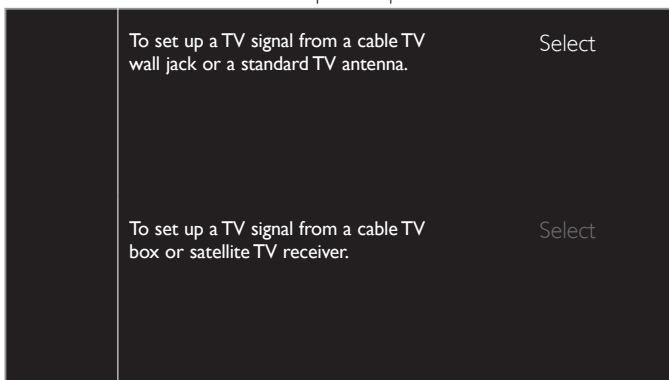

- Use **▲▼** to select **Antenna** for TV channels or **Cable** for CATV channels, then press **OK**.

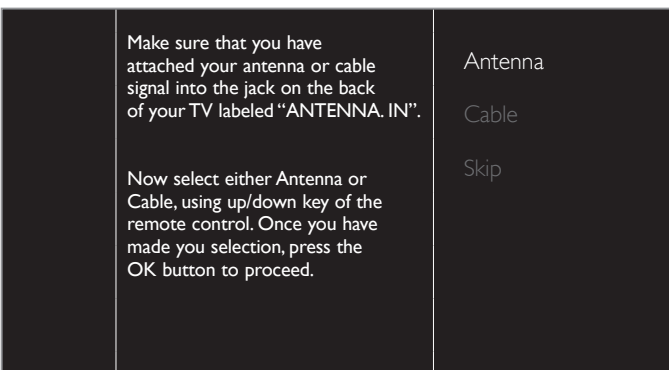

- When **Antenna** is selected, the TV detects antenna signals. It searches for DTV and Analog TV channels available in your area.
- When **Cable** is selected, the TV detects signals supplied by cable. It searches for DTV, Analog TV and Cable channels available in your area.
 - Autoprogram** will begin.

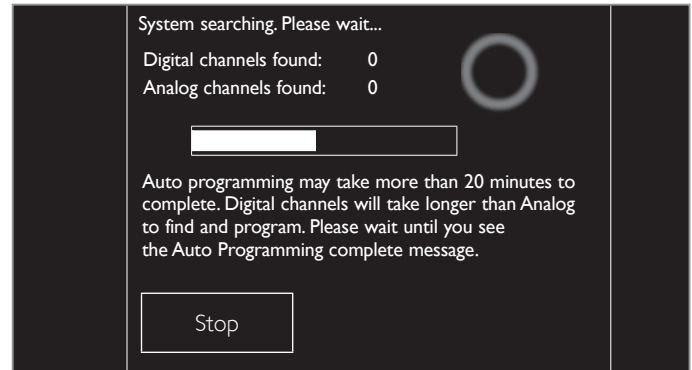

- After the channel installation is completed, Network setup screen will appear. Use **▲▼** to select **Wireless** or **Wired**, then press **OK**.

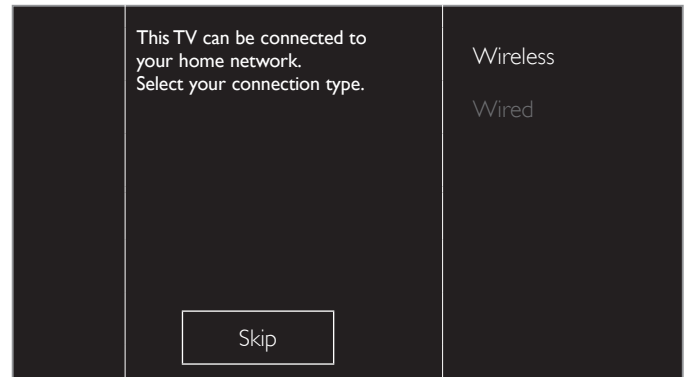

Wireless	If you have a Wireless router, select Wireless to connect to the Internet.
Wired	If you connect with an Ethernet cable, select Wired to connect to the Internet.

- If you have a router with WPS function, select **Wireless** and use **▲▼** to select **Easy Connect**, then press **OK**.
- Follow the on-screen instructions to complete the installation.
 - When you select **On** in the selection screen of **Auto software update**. A message will appear if there is the latest software on the network server.
 - Use **◀▶** to select **Start**, then press **OK** to begin **Settings assistant**.

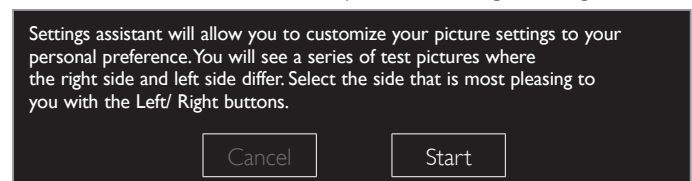

- Press **◀** or **▶** 5 times to select the side of the pictures that is the most pleasing to you, then press **OK**.

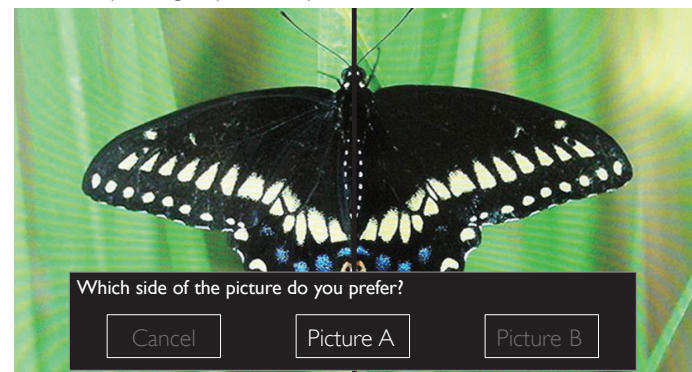

Continued on next page.

9 Press **OK** to finish **Settings assistant**.

Store your preferences.

Cancel

Store

- **Network updates** will appear after **Connection test** succeeds. Use ◀▶ to select **Yes**, then press **OK**.
- When the initial setup is completed, the lowest memorized channel with the confirmation message will be displayed on the TV screen.



Note

- If you are not receiving a signal from your cable service, contact the Cable provider.
- If you press ⏸ during AutoProgram, this setup of TV channels will be canceled.
- The initial AutoProgram function can be executed for either **Antenna** or **Cable** only once. When you change the connection (Antenna/Cable), set **Autoprogram** again.
 ▶▶▶▶▶ p.37

After an initial setup is completed..

- If you want to scan the channels automatically again.
Autoprogram ▶▶▶▶▶ p.37
- You can add the desired cable and Analog channels unmemorized by AutoProgram.
Weak channel installation ▶▶▶▶▶ p.37
- If you want to change to another language.
Language ▶▶▶▶▶ p.36
- If you want to change the country setting.
Country ▶▶▶▶▶ p.19
- If you want to change the location setting.
Location ▶▶▶▶▶ p.38
- If you want to change the network setting.
Network ▶▶▶▶▶ p.40
- If you want to restore the picture setting.
Settings assistant ▶▶▶▶▶ p.30

4 Use your TV

Switching on your TV and putting it in Standby mode

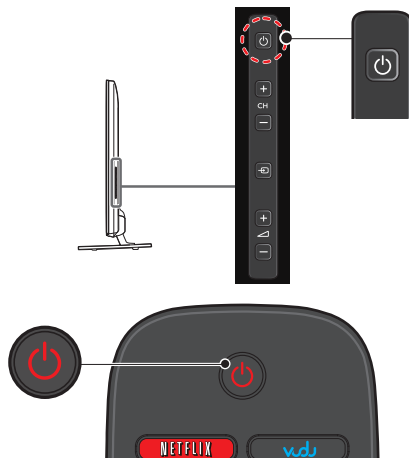

To Turn Power On or to Turn Standby On

- Press on the side panel or the remote control.

Note

- Energy consumption contributes to air and water pollution. When the AC power cord is plugged in, your TV consumes energy. Your TV has very low Standby power consumption.

Adjusting volume

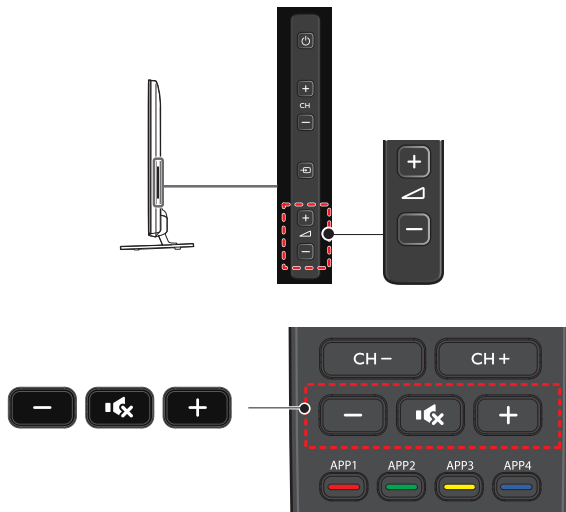

To increase or decrease volume

- Press +(up)/-(down) (**VOLUME**) on the side panel or press +/- (**VOLUME**) on the remote control.

To mute or unmute sound

- Press (**MUTE**) on the remote control to mute the sound.
- Press (**MUTE**) again or +/- (**VOLUME**) to recover the original sound.

Switching channels



To select Channels by using CH +/-

- Press **CH +** (up)/**CH -** (down) on the side panel or the remote control.

To select Channels by using the NUMBER buttons

Digital TV operation

- For Digital channels, press a number followed by a dot “•” and the corresponding sub channel number.
- When selecting Digital channel 11.1
Be sure to press • before entering the subchannel number.



Analog/Cable TV operation

- When selecting cable or Analog channel 11



Press (**PREV.CH**) to return to the previously viewed channel.

Note

- To select the non-memorized channels, use the **NUMBER** buttons.
- Channel not available** or **No Signal** will appear on the TV screen after the subchannel broadcast is over.
- Audio only** message will appear on the TV screen, when you receive only sound signal.

Watching channels from an external device

Switching Each Input Mode can easily switch with the remote control between TV (DTV or Analog TV) and external devices when they are connected to the unit.

- 1 Turn On a set-top box or the connected device.
 - The picture from your set-top box or the connected device might appear automatically on the TV screen.

If the picture does not appear

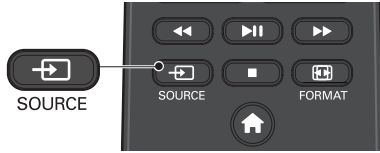

Press **SOURCE** repeatedly to select the set-top box or the connected device and wait a few seconds till the picture appears.

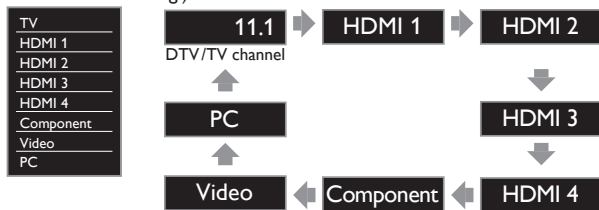

- Pressing **▲** reverses the direction of the Input modes.
- 2 Use the remote control of the set-top box or the connected device to select channels.

Access the Home menu

- 1 Press **HOME** (MENU).

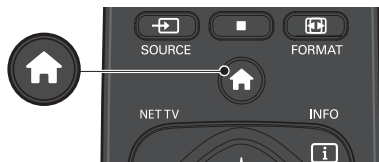

Guide to Home menu

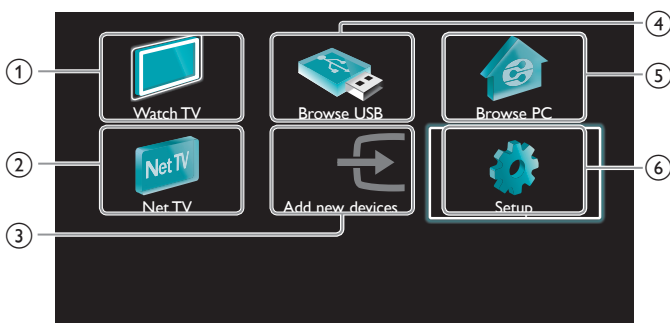

- | | |
|-------------------|---------------------------------------------------------------------------------|
| ① Watch TV | : Switches back to the antenna source if another source is selected. |
| ② Net TV | : Accesses Net TV menus. |
| ③ Add new devices | : Adds new devices to the Home menu. |
| ④ Browse USB | : Accesses USB menus. |
| ⑤ Browse PC | : Accesses DLNA menus. |
| ⑥ Setup | : Accesses menus that allow you to change picture, sound and other TV settings. |

Note

- After selecting **Add new devices**, follow the on-screen instructions to select the correct device and connector.

Lock or unlock your device from the Home menu

This section describes how to lock or unlock specified device.

- 1 Press **HOME** (MENU) on the remote control.
- 2 Use **▲▼◀▶** to select a device to lock or unlock.
- 3 Press **OPTIONS** on the remote control.
- 4 Use **▲▼** to select **Device lock** or **Device unlock**, then press **OK**.
 - If device lock is unlocked, **Device lock** will be displayed. If device lock is locked, **Device unlock** will be displayed and **LOCK** will be displayed at the top right of the device icons.
- 5 Enter your PIN. **Change PIN** → p.36
 - Once you have set PIN, PIN input menu does not appear after the unit is Turned on.

Enable or disable RC key forwarding from the Home menu

This section describes how to enable or disable RC key forwarding for a particular device.

- 1 Press **HOME** (MENU) on the remote control.
- 2 Use **▲▼◀▶** to select a device to enable or disable RC key forwarding.
- 3 Press **OPTIONS** on the remote control.
- 4 Use **▲▼** to select **Enable RC key forwarding** or **Disable RC key forwarding**, then press **OK**.
 - If RC key forwarding is set to off, **Enable RC key forwarding** will be displayed. If RC key forwarding is set to on, **Disable RC key forwarding** will be displayed and **RC** will be displayed at the top left of the device icons.

Note

- This function is available only when your devices are connected to this unit through HDMI cables and assigned to an HDMI port (HDMI 1 to HDMI 4) with **Add new devices** in the Home menu.

Philips Wireless MediaConnect

You can enjoy your TV as a PC monitor wirelessly using your home network. Make sure you download the Philips Wireless MediaConnect software and install it on your PC before you perform the steps below.

Install Philips Wireless MediaConnect

- 1 Display **Setup** using Home menu and use ▲▼ to select **Software**, then press **OK**.
- 2 Use ▲▼ to select **MediaConnect code**, then press **OK**.
 - Write down the 12-digit code displayed on the screen. You will need this to download MediaConnect software.
- 3 Start your Internet browser on your PC and open the Philips Wireless MediaConnect download page at www.wifimediaconnect.philips.com/
On the website, you can check the necessary PC system requirements.
- 4 Enter the 12 digit code you wrote at step 2.
- 5 Click the "Download now" button to download the free Philips Wireless MediaConnect software.
- 6 Once downloaded, start the file "Philips Wireless MediaConnect_setup.exe". Follow the instructions on the screen to complete software installation.

Using Philips Wireless MediaConnect

- 1 Launch Philips Wireless MediaConnect on your PC first.
 - Select "Start projecting" with right click on the  in the system tray.
 - The start up screen for Philips Wireless MediaConnect will be displayed and the unit searches for an available PC that is running Philips Wireless MediaConnect software.

Once connected, the Philips Wireless MediaConnect software will encode and stream the screen of your PC as a video along with audio.

Depending on your computer and network configuration, there will be a delay between your PC screen and the TV but the audio-video will always be in sync.

Philips Wireless MediaConnect Help

To read the Philips Wireless MediaConnect Help, right click the program icon in the notification tray of the PC and select Help.

Specifics

You can project high definition (HD) or standard definition (SD) video, depending on the processing power of your PC. For smooth playback of HD video, please use a hardware accelerated video player on your computer. A hardware accelerated video player uses the graphics adapter of your PC to render HD video rather than the processor. This frees up the processor for Philips Wireless MediaConnect video encoding. The content protection on most Blu-ray or DVD disc movies might restrict watching the movie on TV when the disc is playing on a PC. The TV shows PC media files with a small delay. Philips Wireless MediaConnect is only available for PC.

PC requirements

Windows XP; Windows Vista; Windows 7,
Mac OS X 10.6 or above (PC only)

Minimum PC requirements

- Intel® Core™ 2 Duo 1.8GHz
- 512MB RAM
- IEEE 802.11n

Recommended PC requirements

- Intel® Core™ 2 Duo 2.1GHz
- 1GB RAM

View photos, play music and watch videos using DLNA

On your TV you can play video, music and photo files stored on DLNA certified home media servers connected to your home network. In order to use this feature, you must connect this unit to the Internet.

It is recommended that files to be played back in this unit are recorded under the following specifications:

<MP3>

- Sampling frequency : 32kHz or 44.1kHz or 48kHz
- Constant bit rate : 32kbps - 320kbps

<JPEG>

- Upper limit : 16Mpixel

<MPEG>



- Playable codec : MPEG2
- Maximum size of a video : 1920×1080
- Audio type : AC3, MPEG1 audio layer 3 (MP3), MPEG1 audio layer 2, LPCM

Note

- A maximum of 1,023 folders or files can be recognized.
- For the home server list, maximum of 16 servers can be displayed.
- The 10th and deeper hierarchies cannot be displayed.
- Unplayable files in the home server will not be displayed in the file list.
- For some files, playback is not available even if displayed in the file list.
- In order to play back the contents in home servers, the player and the servers must be connected to the same access point.
- Compatibility and available playback function may differ depending on the home server.
- Video files with unsupported audio format will be skipped.
- The quality of the playback picture or audio differs depending on your network condition.

Before using DLNA

Follow the procedure below before using DLNA.

- 1 Connect this unit to the Internet.
 - **Connecting the TV to the Internet using an Ethernet cable**  p.46
 - **Connecting the TV to the Internet using a wireless LAN**  p.47
 - Broadband Internet connection of 8Mbps or faster is required.
- 2 Set up the necessary network connection settings. **Network**  p.40

Using DLNA

- 1 Start DLNA home media servers in your home network.
 - For details, refer to the instruction book of the DLNA certified device.
- 2 Press  (MENU) on the remote control.
- 3 Use ▲▼◀▶ to select **Browse PC**.
 - This unit will start loading the home server list.
- 4 After loading, home server list will appear. Select a home server you want to access, then press **OK**.

Guide to DLNA

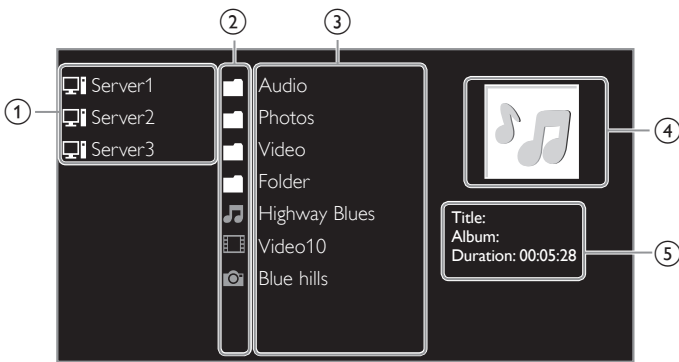

- ① Home server list
- ② Folder/media icon
- ③ Group (folder)/file list
- ④ Image
- ⑤ Current file info

View your pictures using DLNA

- 1 Press ▲▼ to select a file or a folder.
- 2 Press OK or ►|| to start a Slide show of the files.
 - Press OK or ►|| to pause the Slide show. The || icon appears.
 - Press ◀◀ or ▶▶ to move between images.
 - Press BACK or ■ to stop the Slide show.
 - Press ☰ OPTIONS to display the optional menu, then use ▲▼ to select the desired item.

Slide time *1	Short	Switches to the next image in 5 seconds.
	Medium	Switches to the next image in 10 seconds.
	Long	Switches to the next image in 15 seconds.
Transitions *1	None	No effect when switching images.
	Dissolve	Overlaps a next image on a current image.
	Wipe right	Pushes a current image out from left.
	Wipe left	Pushes a current image out from right.
	Wipe up	Pushes a current image out from bottom.
	Wipe down	Pushes a current image out from top.
	Box in	A next image comes into the center from out.
Box out	A next image goes to the out from center.	
Rotate *2	0	Displays an image at its original direction.
	90	Rotates an image clockwise by 90 degrees.
	180	Rotates an image clockwise 180 degrees.
	270	Rotates an image clockwise 270 degrees.
Zoom *2	1x	Displays an image at its original size.
	2x	Magnifies a current image as twice.
	4x	Magnifies a current image as fourfold.

*1 You can set **Slide time** and **Transitions** when images are in Slide show.

*2 You can set **Rotate** and **Zoom** when Slide show is in pause mode.

Listen to music using DLNA

- 1 Press ▲▼ to select a file or a folder.
- 2 Press OK or ►|| to play the selected files.
 - Press OK or ►|| to pause, press OK or ►|| again to resume.
 - Press ▶▶ to skip up the next file.
 - Press ◀◀ to skip down the previous file.
 - Press ■ to stop playback.
 - Press ☰ OPTIONS to display the optional menu, then use ▲▼ to select the desired item.

Repeat	Off	Sets repeat playback to off.
	On	Sets repeat playback for all MP3 files in the current folder.
Shuffle	Off	Sets shuffle playback to off.
	On	Sets shuffle playback for all MP3 files in the current folder.
TV speakers	Off	The sound will not be output from the unit's speakers.
	On	The sound will be output from the unit's speakers.
	Speakers EasyLink	You can control audio output from your connected EasyLink Compliant Devices with +/– (VOLUME) by using this unit's remote control.

Note

- **Master EasyLink** must be activated in the **Preferences** menu to make the **TV speakers** menu available when you select **On** or **Speakers EasyLink**.

Watch videos using DLNA

- 1 Press ▲▼ to select a file or a folder.
- 2 Press OK or ►|| to play the selected files.
 - Press OK or ►|| to pause, press OK or ►|| again to resume.
 - Press ▶▶ to fast-forward search.
 - Press ◀◀ to fast-backward search.
 - Press ■ to stop playback. Press ►|| to resume from the point at which playback was stopped. Press OK to play from the beginning of the file at which playback was stopped.
 - Press CH+ to play the next file.
 - Press CH– to play the current file at the beginning. Press CH– twice within 5 seconds to play the previous file.
 - Press ☰ OPTIONS to display the optional menu, then use ▲▼ to select the desired item.

TV speakers	Off	The sound will not be output from the unit's speakers.
	On	The sound will be output from the unit's speakers.
	Speakers EasyLink	You can control audio output from your connected EasyLink Compliant Devices with +/– (VOLUME) by using this unit's remote control.

Note

- The resume information will be kept even when the unit is Turned Off.
- If you play another file while the previously viewed file is being resumed, the resume information of the previously viewed file will be deleted.

Net TV

Net TV offers Internet services for your TV. Use the remote control to browse the Net TV pages. You can play movies and much more, all from your TV screen.

- Because Net TV is an online system, it can be modified over time to better serve its purpose.
- Some Net TV services can be added, changed or stopped after some time.
- You cannot download and save files or install plug-ins.

Before Logging in to Net TV

Follow the procedure below before logging in to Net TV.

- 1 Connect this unit to the Internet.
- 2 Set up the necessary network connection settings. **Network** p.40

Logging in to Net TV

- 1 Press **NET TV**.
 - Net TV screen will appear; then use to select service icon.
 - For the first time only, **Philips Terms of Use Internet Enabled product** screen will appear. After confirming the content, use to select **Agree**, then press **OK**.

Guide to Net TV screen



- ① **Net service icons (fixed)**: Displays default service icons.
- ② **My Apps list**: Displays Net service icons you have listed in **App Gallery**.
- ③ **Country**: Selects what country you live.
- ④ **Terms of use**: Displays a clause of Net service.
- ⑤ **App Gallery**: Displays currently available Net service icons in your country.
- ⑥ **Page guide**: Displays the order of pages. The current page will be highlighted.
- ⑦ **APP1/APP2/APP3/APP4**: Displays Net service icons you have registered in **App Gallery** for **APP1/APP2/APP3/APP4**.
 - Press **Apps** buttons (red/green/yellow/blue) to start up **APP1/APP2/APP3/APP4** accordingly.

My Apps functions

Remove App

- 1 Use to select the desired App, then press **OPTIONS**.
- 2 Use to select **Remove App**, then press **OK**.
 - The selected App will be removed from **My Apps** list.

Move App

- 1 Use to select the desired App, then press **OPTIONS**.
- 2 Use to select **Move App**, then press **OK**.
 - The selected App icon will be smaller.
- 3 Use to the point you want to place, then press **OK**.

Guide to App Gallery

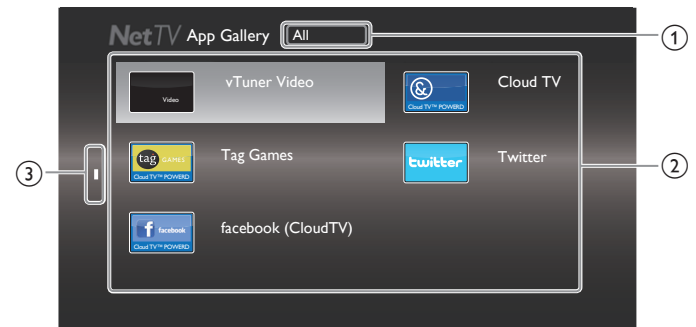

- ① **Category menu**: : List of category menu.
- ② **Icon list**: : Displays unregistered Net service icons on **My Apps** list.
- ③ **Page guide**: : Displays the order of pages. The current page will be highlighted.

- 1 Press **NET TV**, then use to select **App Gallery**.
- 2 Use to select the desired App in **My Apps** list, then press **OK**.
 - You can also choose from **Category menu**. Use to select **All**, then use **OK** to select the desired category.
 - If you select **Add**, the selected App icon will be placed at the end of **My Apps** list.
 - If you select **Add and move**, the selected App icon will be smaller and use to the point you want to place, then press **OK**. Even if you press **BACK** to cancel this function, the selected App icon will be placed at the end of **My Apps** list.

Information on Network Services

For detailed information on 3rd party Internet services, please visit the service providers website:

- Netflix : <http://www.netflix.com/HowItWorks>
 Film Fresh : <http://filmfresh.roxionow.com/>
 VUDU : http://www.vudu.com/product_overview.html
 Cloud TV : <http://www.activevideo.com>
 Hulu Plus : <http://www.hulu.com>
 CinemaNow : <http://www.cinemanow.com>

Enjoying vTuner

With this unit, you can enjoy video and Internet radio with vTuner via the Internet. In order to watching video and listen to Internet radio, you must connect this unit to the Internet.

Video playback

After you set up the network connection, follow the procedure below to watch the video.

Guide to the player screen

e.g.) Recommendations

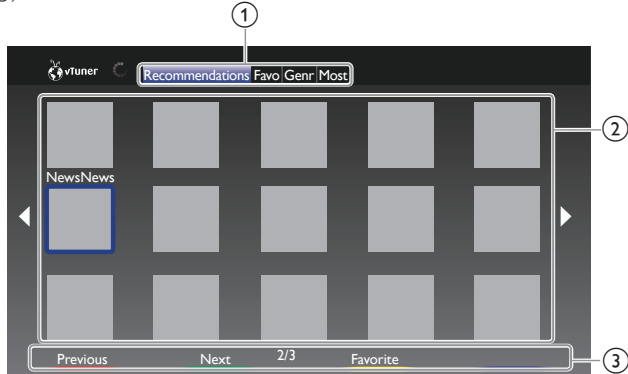

- ① Category : List of category menus
Recommendations : List of recommendation stations
Favorites : List of your favorite video stations
Genre : List of stations categorized by genre
Most Popular Podcasts : List of popular podcasts
- ② Station list : Displays station list.
- ③ Operation guide : Displays **Apps buttons (red/green/yellow/blue)** guide.

- 1 Press **NET TV** on the remote control and then use **▲▼◀▶** to select **vTuner-Video**.
- 2 Use **◀▶** to select the desired category, then press **OK**.
- 3 In the player screen, use **▲▼◀▶** to select the desired station or genre, then press **OK**.

Guide to the playback screen



- ① Station icon
 ② Station name
 ③ Station information
 ④ Episode list
 ⑤ **Apps buttons (red/green/yellow/blue)** guide
 ⑥ Current episode information

- 4 In the playback screen, use **▲▼** to select the desired episode, then press **OK**.
 - After loading, playback of the selected episode will start.
 - To stop playback, press **■**.
 - Episode list can be displayed 5 episodes at one time. To show the previous/next episodes, press **Apps buttons (red/green)**.
 - To enlarge playback screen, press **Apps button (blue)**.

Note

- Video service may not be fully available with narrowband Internet connection. (e.g. 56k modem) When watching video, use broadband Internet connection. (For details, contact your Internet service provider.)
- Depending on the bit rate of a station or the network environment, it may take a while to complete loading the station or playback may not be available.
- The streaming video may be interrupted during playback, when the vTuner server is busy.
- Some stations cannot be displayed in the list, depending on the network environment.
- If the loading time of a station exceeds 3 minutes, the loading will be canceled.
- The order of station/episode in the list depends on the information from vTuner server and may change without notice.

Add to Favorites

You can add your favorite stations to **Favorites** in the category tab. To add your favorite stations, follow the procedure below.

- 1 Follow steps 1 to 2 in **Video playback**. **▶▶▶ p.20**
- 2 Use **▲▼◀▶** to select the station you want to add to **Favorites**, then press **Apps button (yellow)**.
 - The selected station is added to the station list in **Favorites**.
 - Confirmation message will appear.
 - Press **Apps button (yellow)** to add your favorite station in **Favorites** while the desired episode is selected in the episode list or the episode is being played back.
- 3 Press **OK**.

Remove from Favorites

- 1 Follow step 1 in **Video playback**. **▶▶▶ p.20**
- 2 Use **◀▶** to select **Favorites** in the category tab, then press **OK**.
- 3 Use **▲▼◀▶** to select the station you want to remove from **Favorites**, then press **Apps button (yellow)**.
 - Confirmation message will appear.
- 4 Use **◀▶** to select **Yes**, then press **OK**.
 - The selected station is removed from **Favorites**.

Internet radio playback

After you set up the network connection, follow the procedure below to listen to Internet radio.

Guide to the playback screen

e.g.) Location



- ① Current hierarchy (total number of items)
- ② Current station information
(Information will be changed when **INFO** [i] is pressed)
- ③ **Apps** buttons (red/green/yellow/blue) guide
- ④ Station list
- ⑤ Station icon
- ⑥ Playback status

- 1 Press **NET TV** on the remote control and then use **▲▼◀▶** to select **vTuner Radio**.
 - Category list will appear.
- 2 In the category list, use **▲▼** to select the desired category, then press **OK**.
 - Station/folder list of selected category will appear.
 - For **Location** and **Genre**, use **▲▼** to select the desired location or genre after selecting the category, then press **OK**.

Recently Played	List of stations which are recently played
Favorites	List of your favorite radio stations
My Added Stations	List of stations which are added on vTuner website (This category will appear only after you add stations on vTuner website.)
Location	List of stations categorized by location
Genre	List of stations categorized by genre
New Stations	List of the latest stations which are recently added automatically.
Most Popular Stations	List of the most frequently accessed stations by the all listeners.

- 3 In the station/folder list, use **▲▼** to select the desired station, then press **OK**.
 - After loading, playback of the selected station will start.
 - If you select a folder, use **▲▼** to select the desired station in the next hierarchy, then press **OK**.
 - To stop playback, press **■**.
 - To go back to the previous or next hierarchy, press **◀▶**.

Note

- This unit cannot play back stations with audio format other than MP3 and WMA.
- Internet radio service may not be fully available with narrowband Internet connection. (e.g. 56k modem) When listening to Internet radio, use broadband Internet connection. (For details, contact your Internet service provider.)
- Depending on the bit rate of a station or the network environment, it may take a while to complete loading the station or playback may not be available.
- The streaming audio may be interrupted during playback, when the vTuner server is busy.
- Some stations cannot be displayed in the list, depending on the network environment.
- If the loading time of a station exceeds 3 minutes, the loading will be canceled.
- The order of station/folder in the list depends on the information from vTuner server and may change without notice.

Add to favorite list

You can add your favorite stations to **Favorites** in the category list. To add your favorite stations, follow the procedure below.

- 1 Follow steps 1 to 3 in **Internet radio playback**. ►► p.21
- 2 Use **▲▼** to select the station you want to add to **Favorites**, then press **Apps** button (yellow).
 - The selected station is added to **Favorites** folder.
 - Confirmation message will appear.
 - If you select a folder, use **▲▼** to select the desired station in the next hierarchy, then press **Apps** button (yellow).
- 3 Press **OK**.

Note

- You can also add your favorite stations to **Favorites** on your PC. To add your favorite stations on your PC, visit <http://go2service.vtuner.com/pe/> and create a vTuner account with the access code, which you can check from the category list. **Internet radio playback** ►► p.21
- You can change folder names or order of lists in your vTuner page on the Internet.
- **My_Favorite** folder will appear after you add a station to **Favorites** on this unit. (Your favorite station will also be added to **My_Favorite** folder.)

Remove from favorite list

- 1 Follow step 1 in **Internet radio playback**. ►► p.21
- 2 Use **▲▼** to select **Favorites**, then press **OK**.
- 3 Use **▲▼** to select the station you want to remove from **Favorites**, then press **Apps** button (yellow).
 - Confirmation message will appear.
- 4 Use **◀▶** to select **Yes**, then press **OK**.
 - The selected station is removed from **Favorites** folder.

Add stations on the vTuner website

You can add stations which are not in the vTuner station list.

- 1 Follow step 1 in **Internet radio playback**. ►► p.21
- 2 Use **▲▼** to select **Get access code**, then press **OK**.
 - The latest vTuner website address and access code for this unit will be displayed. Please take a note of the access code. (This access code will be required when creating a vTuner account.)
- 3 On your PC, visit the website and create your vTuner account.
 - Follow the instructions given on the PC screen.
- 4 Add stations by following the instructions given on the PC screen.
 - The stations will be added to **My Added Stations**.

Reset the station list

You can remove all stations/folders in **Recently Played**, **Favorites** and **My Added Stations**.

- 1 Follow step 1 in **Internet radio playback**. ➡ p.21
- 2 Use ▲▼ to select **Reset**, then press **OK**.
- 3 Use ◀▶ to select **Yes**, then press **OK**.
 - All stations/folders in **Recently Played**, **Favorites** and **My Added Stations** are removed.

Pandora® operations

With this unit, you can instantly listen to personalized radio stations streamed over the Internet from Pandora.

To learn more about Pandora, please visit www.pandora.com

Activating Pandora

In order to listen to Internet radio streamed from Pandora via the Internet, you must create a Pandora account and activate this unit.

- 1 Press **NET TV**, then use ▲▼◀▶ to select **PANDORA**.
- 2 Use ▲▼ to select **Create new account**, then press **OK**.
- 3 Use ▲▼ to select **No, I am new to Pandora.**, then press **OK**.
- 4 Note the activation code and website address displayed on the TV screen.
- 5 On your PC, visit the website address noted at step 4.
- 6 Follow directions on the website to create your account.
- 7 On this unit, select **Continue** and press **OK** to complete activation.

Adding Pandora User Accounts

You can add multiple Pandora user accounts on this unit.

- 1 Follow steps 1 to 2 in **Activating Pandora**. ➡ p.22
- 2 Use ▲▼ to select **Yes, I have a Pandora account**, then press **OK**.
- 3 Enter your e-mail address, then press **OK** while **OK** is selected.
- 4 Enter a password, then press **OK** while **OK** is selected.
- 5 Use ▲▼ to select **Sign In**, then press **OK**.
 - Your account is added to the user list and player screen appears on the TV screen.

Note

- Pandora is available only in the United States.
- You can add up to 5 accounts. After creating 5 accounts, **Create new account** will not be displayed.

Creating a New Station

By entering your favorite artists or tracks, Pandora selects music and creates a new station for you on the basis of the entered information.

- 1 On the player screen, press **Apps button (yellow)** to call up the **Tool Menu**.
- 2 Use ▲▼ to select **Create a new station**, then press **OK**.
- 3 Enter a name of your favorite artist or tracks, then press **OK** while **OK** is selected.
 - Search result will appear on the right side of the TV screen.
 - If the selection screen of result type appears, use ▲▼ to select the desired type, then press **OK**.
- 4 Use ▲▼ to select the desired station, then press **OK** to start the playback.

▶▶	Resumes the playback/pause the playback.
■	Stops the playback and the station list will appear.
▶▶	Skips to the next track.

Note

- On the **Tool Menu**, you can delete or rename the currently selected station.

Guide to the Player Screen

On the player screen, you can set various options to the currently playing track.

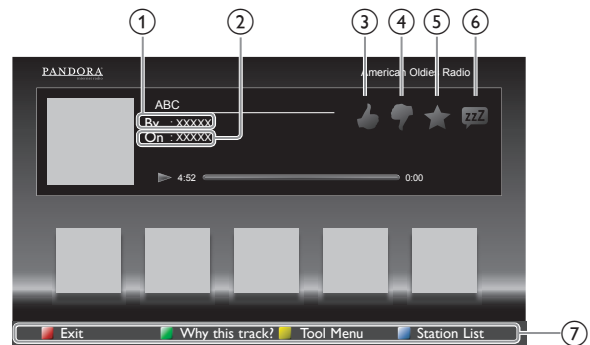

- ① Artist name : Displays artist name.
- ② Album name : Displays album name.
- ③ : Give thumbs up to the currently playing track. Pandora will play tracks similar to the track.
- ④ : Give thumbs down to the currently playing track. Pandora will skip and will not play the track.
- ⑤ : Bookmarks the currently playing track. You can view your bookmarked tracks list by accessing Pandora website and log into your account.
- ⑥ : Tells Pandora that you do not like the currently playing track. Pandora will not play the track for about a month.
- ⑦ Operation guide : Displays **Apps buttons (red/green/yellow/blue)** guide.

Using Twitter

You can view your Twitter feeds and more using the Twitter application on this unit.

– For more details about Twitter, please visit www.twitter.com

Logging in to Twitter

After you set up the network connection, you must log in with your Twitter account.

Make sure the unit is not in network service or Browse USB mode.

1 Press **NET TV** on the remote control and then use **▲▼◀▶** to select **Twitter**.

- Login screen will appear.

2 Use **▲▼** to select **Username**, then press **OK**.

- Software keyboard will appear.

Characters	Select each one of characters from the list.
Clear	Delete the last character in the entry field.
All clear	Delete all characters in the entry field.
a/A/@	Switch case and symbols.
Cancel	Cancel the input.
OK	Determine the input Username and/or Password.

3 Use **▲▼◀▶** to input your **Username** and **Password** into the entry fields. Select **OK** after you have filled in all the necessary items in the entry field, then press **OK**.

- Password can be skipped next time onwards once you have selected **Remember me** when registering the user name.
- Software keyboard will disappear.

4 Use **▲▼◀▶** to select **Start**, then press **OK**.

- The unit will now establish a connection with the Twitter server and perform authentication.

5 When the unit is logged in successfully, Twitter **Home** screen will appear at the left and the timeline will appear at the bottom of the TV screen.

Note

- User name and password are case-sensitive.
- User name will not accept your e-mail account. Use only your user name registered on the Twitter server.
- If you select **Start** with no user name, the unit logs in as 'Public'. In this case you can display 'Public timeline' and 'Trends' only.
- For questions regarding Twitter, please visit www.twitter.com

Guide to Twitter Home screen

Twitter Home Screen consolidates browsing of tweets and some functional menus for Twitter.

To call up the screen, press **NET TV** on the remote control and then use **▲▼◀▶** to select **Twitter**.

Single View

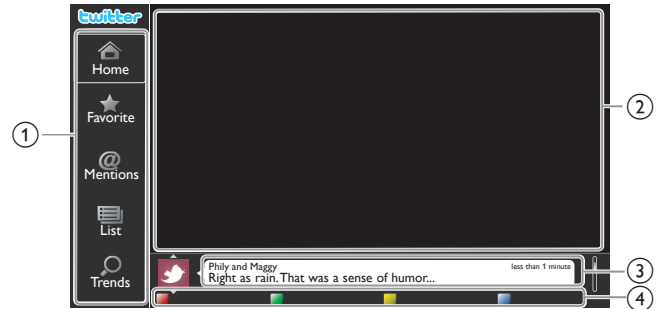

- ① Menu : List of functional menus.
- ② Viewing channel : Displays currently watching channel.
- ③ Timeline : Displays currently tweeting on Twitter.
- ④ Operation guide : Displays **Apps buttons** (red / green / yellow / blue) guide.

Full View

Single view switches to Full view when you select timeline then press **OK**.

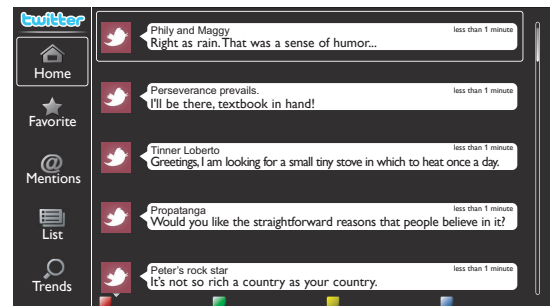

Viewing tweets on the TV

After logging in to Twitter, your TV will download the latest 20 tweets to display.

- 1 Press **NET TV** on the remote control and then use **▲▼◀▶** to select **Twitter**.
- 2 Use **▲▼◀▶** to select the desired user name, then press **OK**.
 - If you have not stored the password, **OTV** will appear beside the user name.
- 3 When the unit is logged in successfully, Twitter **Home** menu will appear at the left and the timeline will appear at the bottom of the TV screen.

Note

- 4 user names (accounts) can be stored in this unit.

Continued on next page.

Viewing Favorites on Twitter

Your TV displays the logged in user's favorites on Twitter.

- 1 Follow steps 1 to 2 in **Viewing tweets on the TV**. p.23
- 2 Use **▲▼** to select **Favorite**, then press **OK**.
 - If you have no favorites, **TV was not able to acquire the Tweet.** will appear.

Displaying Mentions on Twitter

Your TV displays replies for the logged in user:

- 1 Follow steps 1 to 2 in **Viewing tweets on the TV**. p.23
- 2 Use **▲▼** to select **Mentions**, then press **OK**.
 - If you have no replies, **TV was not able to acquire the Tweet.** will appear.

Viewing Lists on Twitter

The list shows timeline categories such as friends, family, colleagues, or sports teams created by yourself on your account.

- 1 Follow steps 1 to 2 in **Viewing tweets on the TV**. p.23
- 2 Use **▲▼** to select **List**, then press **OK**.
 - If you have no lists, **Cannot get the list information.** will appear.
- 3 When you press **Apps button (yellow)** in 1 or 5 list view, the timeline will be separated at top and bottom. The upside displays 3 timelines and the downside display 2 timelines.

2 List View

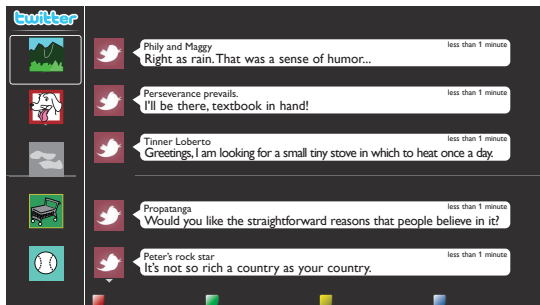

- 4 When you press **Apps button (blue)** in 1 or 2 list view, the timeline will increase 5 lines.

5 List View



Viewing Trends on Twitter

Trends show topics trending in your area.

- 1 Follow steps 1 to 2 in **Viewing tweets on the TV**. p.23
- 2 Use **▲▼** to select **Trends**, then press **OK**.
 - Press **Apps button (green)** to switch between the **Area** and **Trends**.
 - If you display **Area**, the topside will be displayed some countries, and the downside will be displayed some cities.

Using auto mode

- 1 Press **OPTION** and select **Auto picture** or **Auto sound** to set your TV to a predefined picture and sound setting.

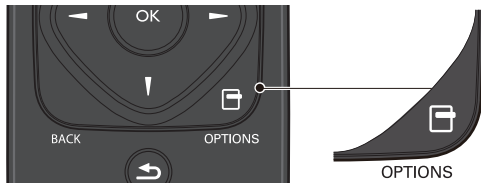

- 2 Use **▲▼** to select one of the following settings:

Auto picture	Auto sound	Description
Personal		The customized settings you defined using the Picture and Sound menu
Vivid		Enhanced picture contrast, sharpness and sound for viewing in a well-lit room
Sports		Brilliant picture settings and clear sound for high action
Standard		For normal TV viewing
Movie		Deep picture and powerful sound settings for a cinematic experience
Game	-	Optimized for PCs and game consoles
Internet video	-	Optimized for low bitrate Internet video
Power saver	-	Eco TV settings for low power consumption
-	Music	Optimized for music playback
-	News	Set the anchor's voice at a comfortable volume

Switch to one of the channels on a list

- 1 Press **OK** to display the last list that you selected.
- 2 Use **▲▼** to select a channel, then press **OK**.
 - The TV switches to that channel.

Note

- Press **CH +/-** to select channels in a list or press the **NUMBER** buttons to select channels that are not in a list.

Sleep timer

Sleep timer can set the unit to go into Standby mode after an incremental period of time.

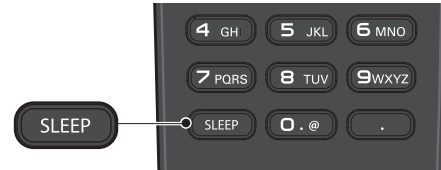

Press **SLEEP** repeatedly to change the amount of time (increases the time by 5 minutes up to 180 minutes).

- Each press of **◀** will decrease the time by 5 minutes.
- Press **INFO** **ⓘ** once to call up the display for checking the remaining time.
- To cancel sleep timer, press **SLEEP** or **◀▶** repeatedly until "0" is displayed.

Create and use lists of favorite channels

You can create lists of your preferred TV channels so that you can find those channels easily.

Select a list of favorite channels

- 1 Press **OPTION** and select **Favorites**.

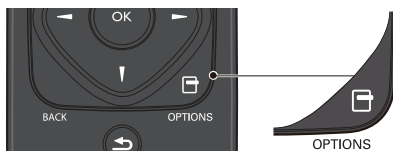

- Your lists of favorite channels are displayed.

- 2 Use **▲▼** to select the desired list, then press **OK**.

Create or edit a list of favorite channels

- 1 Press **OPTION** and select **Favorites**.
- 2 Use **▲▼** to select the desired list, then press **OK**.
- 3 Press **OPTION** to enter edit mode.
 - A list of channels is shown.
- 4 Use **▲▼** to select the desired channel, then press **OK** to add or remove on the list of favorite channels.
 - indicates that the channel is added.
 - indicates that the channel is removed.
- 5 Press **HOME** (**MENU**) to exit.

Changing picture format

Display modes can be selected when your TV receives a 16:9 or 4:3 video signal.

Three types of display modes can be selected for a PC Input signal.

Press **FORMAT** repeatedly to switch the TV aspect ratio.

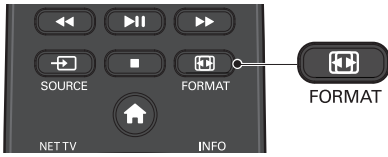

For 16:9 video signal

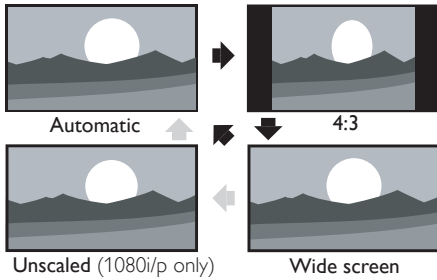

Automatic	Other than DTV and HDMI connected devices, enlarges the picture to best fit the screen. DTV and HDMI connected devices display the picture at its original size. The subtitles may remain visible.
4:3	Displays a 16:9 picture at a 4:3 size; the picture is shortened horizontally. Sidebars appear on both edges of the screen.
Wide screen	Displays a 16:9 picture that is stretched horizontally and vertically.
Unscaled (1080i/p only)	Displays a 16:9 picture at its original size.

For 4:3 video signal

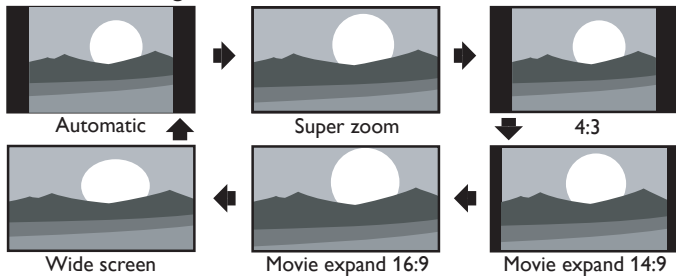

Automatic	Other than DTV and HDMI connected devices, enlarges the picture to best fit the screen. DTV and HDMI connected devices display the picture at its original size. The subtitles may remain visible.
Super zoom	Displays a 4:3 picture at a 16:9 size; the picture is stretched horizontally and vertically and its left and right edges are enlarged. This crops out the top and bottom of the picture.
4:3	Displays a 4:3 picture at its original size. Sidebars appear on both edges of the screen.
Movie expand 14:9	Displays a 4:3 picture at a 14:9 size; the picture is stretched horizontally and vertically. This crops out the top and bottom of the picture. Sidebars appear on both edges of the screen.
Movie expand 16:9	Displays a 4:3 picture at a 16:9 size; the picture is stretched horizontally and vertically. This crops out the top and bottom of the picture.
Wide screen	Displays a picture that is stretched out of proportion to fill the screen.

For PC Input signal

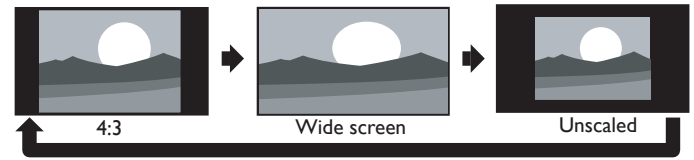

- This unit can also be connected to your PC that has a DVI terminal. Use an HDMI-DVI conversion cable for this Video connection and it requires Stereo mini 3.5mm plug Audio cable for Analog Audio signal as well.
- Refer to 16:9 video signal on this page if PC has HDMI Output.

4:3	Displays a proportionately stretched picture. Sidebars appear on both edges of the screen.
Wide screen	Displays a picture that is stretched out of proportion to fill the screen.
Unscaled	Displays a picture in its original size.

TV screen information

You can display the currently selected channel or other information such as the aspect ratio on the TV screen.

In the Digital mode, the detailed broadcasting information for the current off-the-air channel such as program title and program guides are displayed.

1 Press INFO

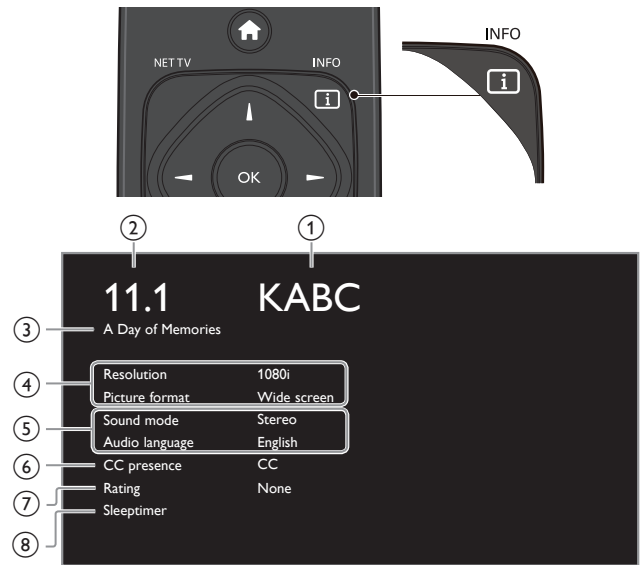

- ① broadcast station
- ② channel number/ Input mode
Switching channels ➡ p.15
Watching channels from an external device ➡ p.16
- ③ program title (for DTV only)
- ④ program's image aspect ratio
Changing picture format ➡ p.26
- ⑤ audio language (DTV)/audio mode (Analog TV)
Sound ➡ p.32
- ⑥ CC (not available if Closed Caption is set to Off)
Caption settings ➡ p.33
- ⑦ child lock rating
Child and ratings lock ➡ p.34
- ⑧ remaining time of sleep timer
Sleep timer ➡ p.34

2 Press INFO to hide the information.

Note

- While the program guide is displayed, the Closed Caption function is interrupted.
- The information display will automatically disappear in 5 seconds.

USB

Your TV is fitted with a USB connection that enables you to view photos, listen to music or watch video files stored on a USB Memory Stick.

- 1 Connect the USB Memory Stick to the USB terminal on the side of your TV.
- 2 Press **HOME** (MENU) and use **▲▼◀▶** to select **USB**, then press **OK**.
- 3 Use **▲▼** to select your desired USB port, then press **OK**.



- 4 Use **▲▼** to select the **Picture**, **Music** or **Video**, then press **OK**.
 - The files recorded under the following specifications are required.
 - Press **OPTION** to display the optional menu, then press **OK** to switch between **List** and **Thumbnails**.

Picture (JPEG)					
Upper limit	16Mpixel				
Music (MP3)					
Sampling frequency	32 kHz, 44.1 kHz or 48 kHz				
Constant bit rate	32 kbps - 320 kbps				
Video					
Maximum size of a video	1920 x 1080				
Extension	.mpg, .mpeg	.vob	.avi	.mp4	.wmv
Video codec	MPEG1, MPEG2	MPEG2	MPEG4 SP MPEG4 ASP	H.264, MPEG4	WMV9 (WVC1)
Audio codec	AC3	YES	YES	YES	NO
MPEG1 audio layer3 (MP3)	YES	NO	YES	NO	NO
MPEG1 audio layer2	YES	NO	YES	NO	NO
LPCM	YES	NO	NO	NO	NO
AAC-LC	NO	NO	NO	YES	NO
WMA	NO	NO	NO	NO	YES

Note

- Up to 2GB (FAT16) or 8GB (FAT32) capacity can be supported.
- Up to 10,000 files or 1,000 folders with 19 hierarchies can be recognized.
- Up to 255 English characters can be recognized.
- This unit does not support MTP(Media Transfer Protocol).
- This unit supports FAT16 and FAT32 file systems.
- If the file is not supported, an error message appears.
- When the USB Memory Stick is not recognized, try reconnecting it again.
- We cannot be held responsible if your USB Memory Stick is not supported, nor will we accept any liability for damage or loss of stored data.
- A file name exceeding 128 characters or contains a dot character is not supported on this TV.
- Progressive JPEG files are not supported.

Picture (JPEG)

- 1 Use **▲▼** to select a file or a folder:



- 2 Press **OK** or **▶||** to start a Slide show of the files.
 - Press **OK** or **▶||** to pause the Slide show. The **||** icon appears.
 - Press **◀◀** or **▶▶** to move between images.
 - Press **BACK** or **■** to stop the Slide show.
 - Press **OPTION** to display the optional menu, then use **▲▼** to select the desired item.

Slide time *1	Short	Switches to the next image in 5 seconds.
	Medium	Switches to the next image in 10 seconds.
	Long	Switches to the next image in 15 seconds.
Transitions *1	None	No effect when switching images.
	Dissolve	Overlaps a next image on a current image.
	Wipe right	Pushes a current image out from left.
	Wipe left	Pushes a current image out from right.
	Wipe up	Pushes a current image out from bottom.
	Wipe down	Pushes a current image out from top.
	Box in	A next image comes into the center from out.
Box out	A next image goes to the out from center.	
Auto picture	Selects the picture mode according to your preference. (Vivid, Sports, Standard, Movie, Game, Internet video and Power saver)	
Rotate *2	0	Displays an image at its original direction.
	90	Rotates an image clockwise by 90 degrees.
	180	Rotates an image clockwise 180 degrees.
	270	Rotates an image clockwise 270 degrees.
Zoom *2	1x	Displays an image at its original size.
	2x	Magnifies a current image by 2 times.
	4x	Magnifies a current image by 4 times.

*1 You can set **Slide time** and **Transitions** when images are in Slide show.

*2 You can set **Rotate** and **Zoom** when Slide show is in Pause mode.

Music (MP3)

1 Use ▲▼ to select a file or a folder.

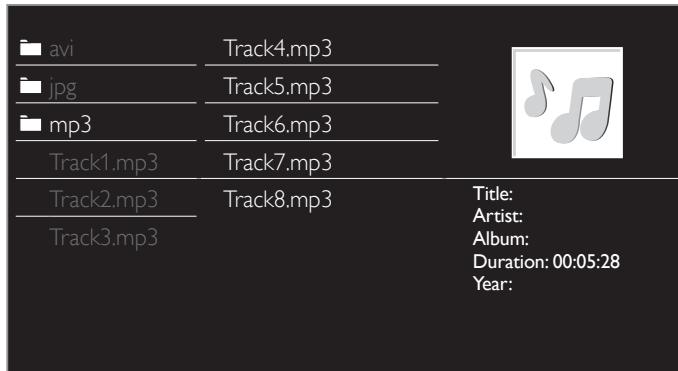

2 Press **OK** or **▶||** to play the selected files.

- Press **OK** or **▶||** to pause, then press **OK** or **▶||** again to resume.
- Press **▶▶** to skip to the next file.
- Press **◀◀** to return to the beginning of the file currently playing.
- Press **■** to stop playback.
- Press **☑** **OPTIONS** to display the optional menu, then use ▲▼ to select the desired item.

Repeat	Off	Sets repeat playback to Off.
	On	Sets repeat playback for all MP3 files in the current folder.
Shuffle	Off	Sets shuffle playback to Off.
	On	Sets shuffle playback for all MP3 files in the current folder.
TV speakers	Off	The sound will not be output from the unit's speakers.
	On	The sound will be output from the unit's speakers.
	Speakers EasyLink	You can control Audio Output from your connected EasyLink Compliant Devices with +/- (VOLUME) by using this unit's remote control.
Auto sound	Selects the sound mode according to your preference. (Standard, Vivid, Sports, Movie, Music and News)	

☰ Note

- TV speakers will be displayed only when **Master EasyLink** is set to **On**. EasyLink **▶▶▶** p.39

Video

1 Use ▲▼ to select a file or a folder.



2 Press **OK** or **▶||** to play the selected files.

- Press **OK** or **▶||** to pause, then press **OK** or **▶||** again to resume.
- Press **▶▶** to fast-forward search.
- Press **◀◀** to fast-backward search.
- Press **■** to stop playback.
- Press **▶||** to resume from the point at which playback was stopped. Press **OK** to play from the beginning of the file.
- Press **☑** **OPTIONS** to display the optional menu, then use ▲▼ to select the desired item.

Subtitle	Not available	Displays if no subtitle is available.
	Subtitle Off	Sets subtitle to Off.
	Subtitle 1-8	Selects the desired subtitle if the Video file contains them.
Audio language	Not available	The unit displays if no Audio language is available.
	Audio 1-8	Selects the desired Audio language if the Video file contains them.
TV speakers	Off	The sound will not be output from the unit's speakers.
	On	The sound will be output from the unit's speakers.
	Speakers EasyLink	You can control Audio Output from your connected EasyLink Compliant Devices with +/- (VOLUME) by using this unit's remote control.
Auto picture	Selects the picture mode according to your preference. (Vivid, Sports, Standard, Movie, Game, Internet video and Power saver)	
Auto sound	Selects the sound mode according to your preference. (Standard, Vivid, Sports, Movie, Music and News)	

☰ Note

- The resume information will be kept even when the unit is Turned Off.
- If you play another file while the previously viewed file is being resumed, the resume information of the previously viewed file will be deleted.
- The file or the folder in resume stop mode will be highlighted in gray on **List** or **Thumbnails**.
- TV speakers will be displayed only when **Master EasyLink** is set to **On**. EasyLink **▶▶▶** p.39

5 Use more of your TV

This section describes the overview of the **Setup** menu displayed when you press **HOME** (MENU) and use **UP** **DOWN** **LEFT** **RIGHT** to select **Setup**. The **Setup** menu consists of the function setting items below.

- 1 Press **HOME** (MENU) to display Home menu.

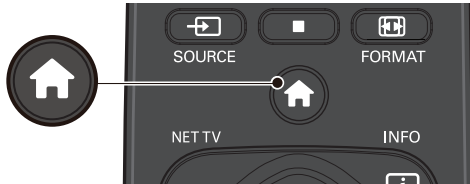

- 2 Use **UP** **DOWN** **LEFT** **RIGHT** to select **Setup**, then press **OK**.

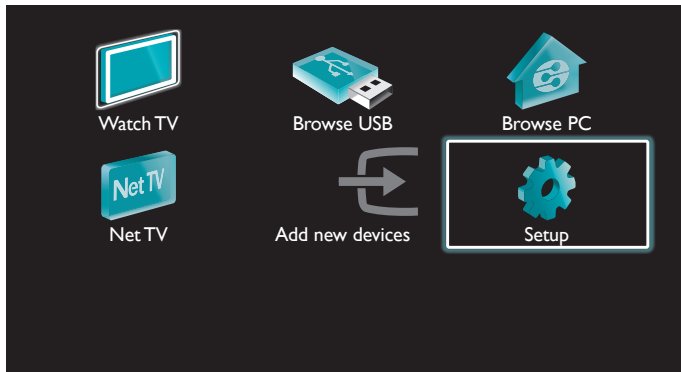

- 3 Use **UP** **DOWN** to select the desired menu and an item, then press **OK** or use **UP** **DOWN** **LEFT** **RIGHT** to determine the setting.

Picture	Settings assistant	Start now
Sound	Auto picture	Personal
Features	Backlight	
Installation	Contrast	
Software	Brightness	
	Color	
	Tint	
	Sharpness	

Picture

▶▶▶▶▶ p.30

Adjusting the picture mode or customize the picture quality as your preference.

Sound

▶▶▶▶▶ p.32

Adjusting the sound mode, equalizer and some other sound functions.

Features

▶▶▶▶▶ p.33

Adjusting the Closed Caption, parental guide and some other useful functions.

Installation

▶▶▶▶▶ p.36

You can choose language, scan the channels available in your area or make the Network settings.

Software

▶▶▶▶▶ p.43

You can check the current software version, update the software or deactivate the setting for Netflix and VUDU.

- 4 When the setting is completed, press **HOME** (MENU) or **BACK** to exit.

Picture

Before you begin:

You must set **Home** in **Location**. ►► p.38

Otherwise, personalized picture and sound settings will not be memorized after the unit goes into Standby mode.

- 1 Press **HOME** (MENU) and use **▲▼◀▶** to select **Setup**, then press **OK**.
- 2 Use **▲▼** to select **Picture**, then press **OK**.

Picture	Settings assistant	Start now
Sound	Auto picture	Personal
Features	Backlight	
Installation	Contrast	
Software	Brightness	
	Color	
	Tint	
	Sharpness	

- 3 Use **▲▼◀▶** to select the item you want to adjust, then press **OK**.
 - The following picture settings can be configured. Depending on the format of the picture Source, some picture settings are not available.

Settings assistant	to guide you through the best picture setting
Auto picture	to select the desired setting, then press OK (Personal , Vivid , Sports , Standard , Movie , Game , Internet video and Power saver) When you adjust the following settings, Personal will be set automatically.

	Cursor ◀	Cursor ▶
Backlight	to reduce power consumption	to set the backlight brighter
Contrast	to decrease contrast	to increase contrast
Brightness	to decrease brightness	to increase brightness
Color	to decrease color intensity	to increase color intensity
Tint	to add green	to add red
Sharpness	to soften	to sharpen

* Advanced picture	to select the desired setting, then press OK (Color alignment , Noise reduction , Light sensor , Black stretch , Dynamic contrast , Gamma , MPEG artifact reduction , Dynamic backlight , Color enhancement , Custom color management and Film mode)	
Picture format	Automatic	Changing picture format ►► p.26
	Super zoom	
	4:3	
	Movie expand 14:9	
	Movie expand 16:9	
	Unscaled	
Mode selection	PC	to Turn Off image enhancement features which makes the TV to act purely as a monitor
	HDTV	to enable image enhancement features to improve picture quality
Auto adjustment	to adjust the horizontal/vertical position, clock and phase of the PC screen automatically	

	Cursor ◀	Cursor ▶
Clock	to decrease setting value	to increase setting value
Phase		
Horizontal shift	to move PC screen left	to move PC screen right
Vertical shift	to move PC screen down	to move PC screen up

Continued on next page.

*You can set a particular about picture quality in Advanced picture.

Auto picture	Color alignment	Mode
Backlight	Noise reduction	Auto
Contrast	Light sensor	On
Brightness	Black stretch	Medium
Color	Dynamic contrast	Maximum
Tint	Gamma	
Sharpness	Digital Natural Motion	Off
Advanced picture	Dynamic backlight	Maximum

Color alignment	Mode	to set the color temperature to Personal, Cool, Normal and Warm . When you adjust the following settings, Personal will be set automatically.	
		Cursor ◀	Cursor ▶
	Red gain	to decrease contrast with red	to increase contrast with red
	Green gain	to decrease contrast with green	to increase contrast with green
	Blue gain	to decrease contrast with blue	to increase contrast with blue
	Red offset	to decrease brightness with red	to increase brightness with red
	Green offset	to decrease brightness with green	to increase brightness with green
	Blue offset	to decrease brightness with blue	to increase brightness with blue
Noise reduction	to select the desired setting, then press OK (Off, Minimum, Medium, Maximum and Auto)		
Light sensor	Off	to set Light sensor to Off	
	On	to adjust backlight for the best picture quality by dynamically adjusting the backlight intensity in accordance with lighting condition in the room	
Black stretch	to select the desired setting, then press OK (Off, Minimum, Medium and Maximum)		
Dynamic contrast	to select the desired setting, then press OK (Off, Minimum, Medium and Maximum)		
Gamma	Cursor ◀	Cursor ▶	
	to adjust the gamma encoding of images		
Digital Natural Motion	to select the desired setting, then press OK (Off, Minimum, Medium and Maximum)		
Dynamic backlight	to select the desired setting, then press OK (Off, Minimum, Medium and Maximum)		
MPEG artifact reduction	to select the desired setting, then press OK (Off, Minimum, Medium and Maximum)		
Color enhancement	Off	to set color enhancement to Off	
	On	to make colors more vivid and bright	

Custom color management	to select the desired setting, then press OK (Red, Yellow, Green, Cyan, Blue and Magenta)		
		Cursor ◀	Cursor ▶
	Tint	to rotate only selected color tint in clockwise direction	to rotate only selected color tint in counterclockwise direction
	Saturation	to decrease color with only selected color	to increase color with only selected color
Film mode	Brightness	to decrease brightness with only selected color	to increase brightness with only selected color
	Off	to set film mode to Off	
	Auto	to optimize the picture recorded by the original film	

Note

- **Mode selection** is available only if
 - the external input modes are selected HDMI 1, HDMI 2, HDMI 3 or HDMI 4.
 - the connected HDMI device is outputting a video signal.
- Adjusts backlight for the best picture quality by dynamically adjusting the backlight intensity in accordance with lighting condition in the room when **Light sensor** is set to **On**. Please ensure the room lighting is stable and the light sensor is not blocked.
- **Digital Natural Motion** If the input video contains adjacent video frames with inherent motion blur captured by the video camera, **Digital Natural Motion** will interpolate blur and cause streaking artifacts in high motion scenes. If the content you are watching causes a lot of Interpolation Induced Blur Amplification, it is best to turn off **Digital Natural Motion** temporarily.
- **Digital Natural Motion** uses frame interpolation to make the video appear smooth which causes a video lag of about 200 milliseconds. If you are using the TV for gaming or as a PC monitor DNM will introduce lag. If your gaming system has a lag adjustment feature for your game controller, use it to negate the lag or else turn off DNM for any application where lag is an issue. If you prefer to use DNM while watching movies on your Home Theater PC (HTPC) and are using an external Audio Receiver for sound output, set a 200 millisecond delay on your audio output for A/V sync. You will not experience A/V sync issues for anything other than gaming or HTPC applications since the TV has internal A/V sync functionality.

Sound

Before you begin:

You must set **Home** in **Location**. ► p.38

Otherwise, personalized picture and sound settings will not be memorized after the unit goes into Standby mode.

- 1 Press **HOME** (MENU) and use **▲▼◀▶** to select **Setup**, then press **OK**.
- 2 Use **▲▼** to select **Sound**, then press **OK**.

Picture	Auto sound	Personal
Sound	Equalizer	Start now
Features	Balance	
Installation	Digital audio language	English
Software	SRS TruSurround HD	On
	AVL	Off
	TV speakers	On
	Digital output format	Multichannel

- 3 Use **▲▼◀▶** to select the item you want to adjust, then press **OK**.

The following sound settings can be configured. Depending on the format of the broadcasting, some sound settings are not available.

Auto sound	to select the desired setting (Personal, Standard, Vivid, Sports, Movie, Music and News) When you adjust the following settings (Equalizer, SRS TruSurround HD and AVL), Personal will be set automatically.
-------------------	-----------------------------------------------------------------------------------------------------------------------------------------------------------------------------------------------------------------

Adjust the tonal quality for each frequency.

Equalizer	Cursor ◀	Cursor ▶
	to adjust the each level of tonal quality Press BACK to go back to the previous menu.	

Adjust the speakers to suit your listening preference.

Balance	Cursor ◀	Cursor ▶
	to adjust the balance of the right and left speakers	

Digital TV operation

You can select the Audio language while your TV is receiving the Digital broadcasting.

Digital audio language	to select the language according to your preference. (It differs depending on the program.)
-------------------------------	---------------------------------------------------------------------------------------------

Analog/Cable TV operation

You can select **Main** or **SAP** while your TV is receiving the Analog broadcasting that has the SAP (Second Audio Program). (It differs depending on the program.)

Alternate audio	Main	to output main-audio
	SAP	to output second-audio program

Analog/Cable TV operation

When you set to **Main** in **Alternate audio** above, you can select **Mono** or **Stereo** if the Analog broadcasting is sending the MTS (Multichannel television sound).

Mono/Stereo	Mono	to output mono-audio
	Stereo	to output stereo-audio

This selects sound modes for more spatial or surround sound reproduction.

SRS TruSurround HD	Off	to set SRS TruSurround HD™ to Off
	On	to set SRS TruSurround HD™ to On

This function keeps a constant loudness differential between the TV commercials and the programs.

AVL	Off	to remove the auto volume leveling
	On	to reduce volume differences between the TV commercials and the programs

You can select the Audio Output from the unit's speakers or not. If your amplifier is HDMI link function compatible and connected by an HDMI cable to this unit, some sound operations such as volume up can be changed by using this unit's remote control. Make sure **Master EasyLink** is set to **On**. ► p.39

TV speakers	Off	not to output sound from the unit's speakers
	On	to output sound from the unit's speakers
	Speakers EasyLink	to control Audio Output from your connected EasyLink Compliant Devices with +/- (VOLUME) by using this unit's remote control.

You can set the digital audio output format from SPDIF/ARC.

Digital output format	PCM	to output PCM
	Multichannel	to output Multichannel (When the audio of the content is PCM, it will be output in PCM even if Multichannel is selected.)

If a channel or Input device is too loud or too soft, navigate to that channel or Input device.

Delta volume	Cursor ◀	Cursor ▶
	to set a negative delta volume level as per your personal preferences	to set a positive delta volume level as per your personal preferences



Note

- **Alternate audio** and **Mono/Stereo** are not available when you watching TV programs with a cable box or satellite set-top box connected through an HDMI cable or Component / Composite Video cables.

Features

- 1 Press **HOME** (MENU) and use **▲▼◀▶** to select **Setup**, then press **OK**.
- 2 Use **▲▼** to select **Features**, then press **OK**.

Picture	Caption settings	Closed captions
Sound	Sleeptimer	
Features	Child lock	Channel lock
Installation	Change PIN	Start now
Software		

- 3 Adjust the following items.

Caption settings

Closed Captioning displays the Audio portion of programming as text superimposed over the video.

- 1 Use **▲▼** to select **Caption settings**, then press **OK**.

Caption settings	Closed captions	Off
Sleeptimer	Caption service	CC-1
Child lock	Digital caption service	CS-1
Change PIN	Digital caption options	Reset to default

Closed captions	Off	not to display the Closed Caption
	On	to display the Closed Caption
	On during mute	to display the Closed Caption when you set to mute

Digital TV operation

In addition to the basic Closed Caption, DTV has its own Closed Caption called Digital caption service. Use this menu to change the settings for Digital caption service.

Digital caption service	CS-1 to CS-6	Selects one of these before changing any other item in Caption settings menu. Choose CS-1 under normal circumstances.
-------------------------	--------------	-------------------------------------------------------------------------------------------------------------------------------------

You can choose the size, font, color, background and other characteristics of the caption text.

Digital caption options	Reset to default	You can reset the status of Digital caption options.
		You can change Closed Captioning font size, style, color and transparency. (Size, Style, Text Color and Text opacity)
		You can change background color and transparency of the displayed caption. (Background color and Background opacity)
		You can change edge color and type of the displayed caption. (Edge type and Edge color)

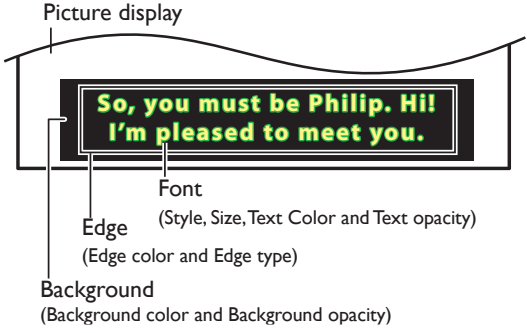

- Review your setting choice made below by looking in the upper left corner of the displayed setting box (not all selections show the differences selected).

Analog/Cable TV operation

Caption service	CC-1 and T-1	The primary caption and text services. The captioning or text is displayed in the same language as the program's dialog (up to 4 lines of script on the TV screen).
	CC-3 and T-3	Serve as the preferred data channels. The captioning or text is often a secondary language.
	CC-2, CC-4, T-2 and T-4	Rarely available and broadcasters use them only in special conditions, such as when CC-1 and CC-3 or T-1 and T-3 are not available.

- There are 3 display modes according to programs:

Paint-on	Displays input characters on the TV screen immediately.
Pop-on	Once characters are stored in memory, they are displayed all at once.
Roll-up	Displays the characters continuously by scrolling (max. 4 lines).

Continued on next page.

 Note

- **Digital caption service** that you can switch differs depending on the broadcast description.
- Closed Captioning service may not be controlled by this unit's menu options if you are watching television through an external cable or satellite set-top box. In which case you will need to use the menu options on the external set-top box to control Closed Captioning.
- The captions do not always use correct spelling and grammar.
- Not all TV programs and product commercials include Closed Caption information. Refer to your area TV program listings for the TV channels and times of Closed Caption shows. The captioned programs are usually noted in the TV listings with service marks such as **CC**.
- Not all captioning services are used by a TV channel during the transmission of a Closed Caption program.
- Closed Caption will NOT be displayed when you are using an HDMI or a Component (except for 480i) connection.
- To show the Closed Caption on your TV screen, broadcast signal must contain the Closed Caption data.
- Not all TV programs and commercials have the Closed Caption or all types of the Closed Caption.
- Captions and texts may not exactly match the TV voice.
- Changing channels may delay the Closed Caption for a few seconds.
- Adjusting or muting the volume may delay the Closed Caption for a few seconds.
- Abbreviations, symbols and other grammatical shortcuts may be used in order to keep pace with the on-screen action. This is not a malfunction.
- The caption or text characters will not be displayed while the Home menu or functions display is shown.
- If a black box appears on the TV screen, this means that the Closed Caption is set to the text mode. To clear the box, select **CC-1**, **CC-2**, **CC-3** or **CC-4**.
- If the unit receives poor quality television signals, the captions may contain errors or there might be no captions at all. Some possible causes of poor quality signals are:
 - Automobile ignition noise
 - Electric motor noise
 - Weak signal reception
 - Multiplex signal reception (ghosts or screen flutter)
 - Data dropout and Pixelation (for DTV only)
- The unit retains the Closed Caption setting if the power fails.
- When the unit receives special effects playback signal (e.g. Search, Slow and Still) from a VCR's video Output channel (ch3 or ch4), the unit may not display the correct caption or text.

Child and ratings lock

You can prevent your children from watching certain programs or certain channels by locking the TV controls and by using ratings.

1 Use **▲ ▼** to select **Child lock**, then press **OK**.

Picture	Caption settings	Closed captions
Sound	Sleeptimer	
Features	Child lock	Channel lock
Installation	Change PIN	Start now
Software		

2 Use the **NUMBER** buttons to enter the 4-digit numbers for your PIN code.

- When you have not set up your PIN code, enter **0, 0, 0, 0**.
- When the PIN code is correct, **Child lock** menu is displayed.

See the following description for setting each item.

Caption settings	Channel lock	Select
Sleeptimer	TV ratings lock	Select
Child lock	Movie ratings lock	Select
Change PIN	Canada English ratings lo	Select
	Canada French ratings lo	Select
	Region ratings lock	Select

Sleeptimer

Sleep timer can set the unit to go into Standby mode after an incremental period of time.

- 1 Use **▲ ▼** to select **Sleeptimer**, then press **OK**.
- 2 Use **►** repeatedly to change the amount of time (increases the time by 5 minutes up to 180 minutes).
 - Each press of **◀** will decrease the time by 5 minutes.
 - Press **INFO**  once to call up the display for checking the remaining time.
 - To cancel the sleep timer, press **►** repeatedly until "0" is displayed.

 Note

- You can also press **SLEEP** directly to switch the desired setting.  p.25

 Note

- When you select the higher rating and set it to , the lower ratings will be blocked automatically.
- When you set the **All** to , all ratings return to automatically.
- **Region ratings lock** will be available when the unit receives a Digital broadcast using the new rating system.
- To block any inappropriate programs, set your limits in **TV ratings lock**, **Movie ratings lock** and **Region ratings lock**.
- For the United States, the unit may download the Region Ratings Lock Table, if required.
- The Canadian rating systems on this unit are based on CEA-766-A and CRTIC policy.

Continued on next page.

Channel lock

Particular channels or external Input modes can be invisible in this function.

- 3 Use ▲▼ to select **Channel lock**, then press **OK**.
- 4 Use ▲▼ to select the particular channels or external Input, then press **OK** repeatedly to switch between view and block.
 - indicates that the channel or Input Source is locked.
 - indicates that the channel or Input Source is not locked.

Caption settings	Channel lock	<input type="checkbox"/> 40.1	DTV
Sleeptimer	TV ratings lock	<input checked="" type="checkbox"/> 40.2	DTV
Child lock	Movie ratings lock	<input checked="" type="checkbox"/> 40.3	DTV
Change PIN	Canada English ratings lo	<input type="checkbox"/> HDMI 1	
	Canada French ratings lo	<input type="checkbox"/> HDMI 2	
	Region ratings lock	<input type="checkbox"/> HDMI 3	
		<input type="checkbox"/> HDMI 4	
		<input type="checkbox"/> Component	

Setting TV and movie ratings

Movie ratings lock is the rating system created by MPAA. TV ratings lock has controlled access to individual programs based on their age ratings and content rating.

- 3 Use ▲▼ to select **TV ratings lock** or **Movie ratings lock**, then press **OK**.
- 4 Use ▲▼ to select the desired rating, then press **OK** repeatedly to switch between view and block.
 - indicates that the rating is locked.
 - indicates that the sub rating is locked.
 - indicates that the rating is not locked.

TV ratings lock

Channel lock	<input type="checkbox"/> All
TV ratings lock	<input checked="" type="checkbox"/> None
Movie ratings lock	<input type="checkbox"/> TV-Y
Canada English ratings	<input type="checkbox"/> TV-Y7
Canada French ratings	<input type="checkbox"/> TV-G
Region ratings lock	<input type="checkbox"/> TV-PG
	<input type="checkbox"/> TV-14
	<input type="checkbox"/> TV-MA

Movie ratings lock

Caption settings	Channel lock	<input type="checkbox"/> All
Sleeptimer	TV ratings lock	<input checked="" type="checkbox"/> NR
Child lock	Movie ratings lock	<input type="checkbox"/> G
Change PIN	Canada English ratings lo	<input type="checkbox"/> PG
	Canada French ratings lo	<input type="checkbox"/> PG-13
	Region ratings lock	<input type="checkbox"/> R
		<input type="checkbox"/> NC-17
		<input type="checkbox"/> X

US movie ratings	US TV ratings	Description
All		All ratings locked including no rating
NR	None	No rating
-	TV-Y	Appropriate for all children
-	TV-Y7	Appropriate for all children 7 and older
G	TV-G	General audience
PG	TV-PG	Parental guidance suggested
PG-13	-	Unsuitable for children under 13
-	TV-14	Unsuitable for children under 14
R	-	Restricted under 17 requires accompanying parent or adult guardian
NC-17	-	No one under 17 admitted
X	TV-MA	Mature audience only

To set the sub ratings

For TV ratings lock, you can further set the sub ratings to block specific elements of programming. To set the sub ratings, follow the step below.

Use ▲▼◀▶ to select the desired rating, then press **OK** repeatedly to switch between and .

Channel lock	<input type="checkbox"/> All	<input checked="" type="checkbox"/> Fantasy Violence
TV ratings lock	<input type="checkbox"/> None	
Movie ratings lock	<input type="checkbox"/> TV-Y	
Canada English ratings	<input checked="" type="checkbox"/> TV-Y7	
Canada French ratings	<input type="checkbox"/> TV-G	
Region ratings lock	<input type="checkbox"/> TV-PG	
	<input type="checkbox"/> TV-14	
	<input type="checkbox"/> TV-MA	

US TV ratings	Sub Rating
TV-Y7	Fantasy Violence
TV-PG	Dialog Language
TV-14	Sex Violence
TV-MA	Language Sex Violence

Note

- Blocked sub rating will appear beside the main rating category in **TV ratings lock** menu.
- You cannot block a sub rating if the main rating is set to .
- Changing the category to or automatically changes all its sub ratings to the same (or .

Continued on next page.

Canada English or Canada French ratings

You can select the rating for Canada English or Canada French broadcasting.

- Use ▲▼ to select **Canada English ratings lock** or **Canada French ratings lock**, then press **OK**.
- Use ▲▼ to select the desired rating, then press **OK** repeatedly to switch between view and block.
 - indicates that the rating is locked.
 - indicates that the rating is not locked.

Canada English ratings lock	Canada French ratings lock	Description
All		Locked all ratings
E		Exempt program
C	–	For all children
C8+	–	For children over 8
G		General audience
–	8ans+	Unsuitable for ages under 8
PG	–	Parental guidance suggested
–	13ans+	Unsuitable for ages under 13
14+	–	Unsuitable for ages under 14
–	16ans+	Unsuitable for ages under 16
18+	18ans+	Adult audience only

Note

- The V-Chip can block non rated programs as per "CEA-608-E sec. L.3". If the option to block **NR**, **None** or **E** programs is used in **Movie ratings lock**, **TV ratings lock**, **Canada English ratings lock** or **Canada French ratings lock** accordingly "unusual results may occur and the unit may not receive emergency bulletins or other types of programming:"/Emergency Bulletins (Such as EAS messages, weather warnings and others)/Locally originated programming/News/Political/Public Service Announcements/Religious/Sports/Weather.

Change PIN

Although the default PIN code (0000) is supplied with the unit, you can set your own PIN code.

- Use ▲▼ to select **Change PIN**, then press **OK**.
- Press the **NUMBER** buttons to enter the new 4-digit PIN code.
 - Enter PIN code again to confirm.

Change PIN

Please enter your current PIN.

Note

- Make sure new PIN code and confirm PIN code must be exactly the same. If they are different, the space is cleared for reentering.
- If you have forgotten your PIN code, enter 0711 to reset the PIN code.

Installation

- Press **⬆** (MENU) and use ▲▼◀▶ to select **Setup**, then press **OK**.
- Use ▲▼ to select **Installation**, then press **OK**.

Picture	Language	English
Sound	Channels	Autoprogram
Features	Preferences	Location
Installation	Network	Network settings assi
Software	Reset AV settings	Start now

- Adjust the following items.

Language

- Use ▲▼ to select **Language**, then press **OK**.

Picture	Language	English
Sound	Channels	Français
Features	Preferences	Español
Installation	Network	
Software	Reset AV settings	

- Use ▲▼ to select **English**, **Español** or **Français**, then press **OK**.

Note

- If you need the English menu instead of the Spanish or French menu's, press **⬆** (MENU).
- Use ◀▶▲▼ to select **Configuración** or **Configuration**, then press **OK**.
 - Use ▲▼ to select **Instalación** or **Installation**, then press **OK**.
 - Use ▲▼ to select **Idioma** or **Langue**, then press **OK**.
 - Use ▲▼ to select **English**, then press **OK**.
 - Press **⬆** (MENU) to exit the Home menu.

Channel installation

Be sure the RF cable is correctly connected to this unit and you are registered with your cable TV provider when you install cable channels.

Autoprogram

If you switch wires (e.g. between antenna and CATV) or if you move the unit to a different area after the initial setting, or if you restore the DTV channels you deleted, it is recommended to use AutoProgram to perform a new channel search.

You need to select the signal type in **Installation mode** before you perform AutoProgram.

- 1 Use ▲▼ to select **Channels**, then press **OK**.
- 2 Use ▲▼ to select **Autoprogram**, then press **OK**.
 - If you run **Autoprogram** when you have locked channels, a message appears asking to enter your PIN code. Enter your PIN code in order to complete the installation. You need to set the channel lock again after the installation.
- 3 Press **OK** to select **Start now**.
 - When the scanning and memorizing are completed, the lowest memorized channel will be displayed.
- 4 Follow the on-screen instructions to complete the installation.

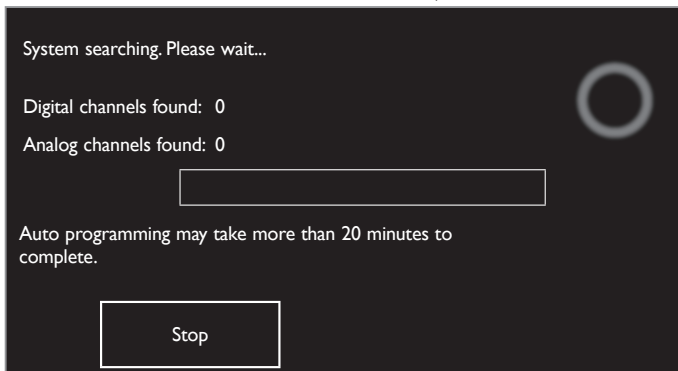

Note

- After setting **Autoprogram**, using **CH +/-** skips unavailable programs automatically.
- If you are not receiving a signal from your cable service, contact the cable provider.
- If you press **⏻** or during AutoProgram, the setup of TV channels will be canceled.
- Even if **Autoprogram** is completed, the channel setting will be lost if the AC power cord is unplugged before the unit goes into Standby mode by pressing **⏻**.
- The PIN code will be required once you set a PIN code in the **Child and ratings lock**. **▶▶▶ p.34**
- If you want to change your PIN code, follow the instruction of **Change PIN**. **▶▶▶ p.36**

Weak channel installation

This function lets you add the channels that were not added by the AutoProgram due to the reception conditions during the initial setup. It is available only when you select Antenna in **Installation mode**.

- 1 Use ▲▼ to select **Channels**, then press **OK**.
- 2 Use ▲▼ to select **Weak channel installation**, then press **OK**.
 - The PIN code will be required if you have locked channels.
- 3 Use ◀▶ to select channel Input box, then use ▲▼ to select a channel you want to memorize.
- 4 Use ◀▶ to select **Search**, then press **OK**.
- 5 Display will be changed to **Store** from **Search** when the channel is found, then press **OK**.

Note

- In most cases, Digital channels are not broadcast on the RF channel on which they appear on your TV. To add Digital channels you need to know the RF channel on which the Digital channel is being broadcast. (e.g. If there is a Digital channel 9.1 which is being broadcast on RF channel 25, you need to enter 25 while performing a weak channel installation.) To find out the RF channel on which a particular Digital channel is being broadcast, please contact your local service provider. Installing Digital channels using **Weak channel installation** might not work for direct cable connections and if the Digital signal is too weak for the TV to process.

Installation mode

- 1 Use ▲▼ to select **Channels**, then press **OK**.
- 2 Use ▲▼ to select **Installation mode**, then press **OK**.
- 3 Use ▲▼ to select **Antenna** or **Cable**, then press **OK**.
 - When **Antenna** is selected, the TV detects antenna signals. It searches for DTV and Analog TV channels available in your area.
 - When **Cable** is selected, the TV detects signals supplied by cable. It searches for DTV Analog TV and Cable channels available in your area.

Uninstall channels

The channels selected here can be skipped when selecting the channels using **CH +/-**.

Those channels can still be selected with the **NUMBER** buttons.

- 1 Use ▲▼ to select **Channels**, then press **OK**.
- 2 Use ▲▼ to select **Uninstall channels**, then press **OK**.
- 3 Use ▲▼ to select the channel you want to remove, then press **OK**.
 - The removed channels are not displayed on the list of favorite channels.
 - To reactivate a removed channel, use ▲▼ then press **OK**.

Preferences

You can set the unit to reduce the power consumption or adjust the backlight brightness in **Location** setting.

EasyLink allows you to operate your connected EasyLink device.

Setting your location to home

Choosing **Home** gives you full flexibility to change predefined settings for picture and sound.

- 1 Use ▲▼ to select **Preferences**, then press **OK**.
- 2 Use ▲▼ to select **Location**, then press **OK**.

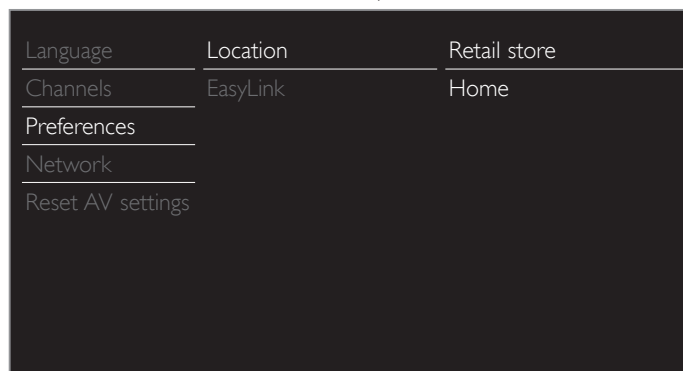

- 3 Use ▲▼ to select **Home**, then press **OK**.

Retail store	The unit will be set up with predefined settings for retail displays. In this setting, the power consumption may possibly exceed the limit requirement of the ENERGY STAR® qualification.
Home	This setting is ENERGY STAR® qualified. The unit is set to maximize the energy efficiency for home setting and it can be adjusted through a choice of picture and sound quality according to your preference.

Note

- You must set **Home**. Otherwise, personalized picture and sound settings will not be memorized after the unit goes into Standby mode.
- If you select **Home**, E-sticker will not be displayed.

E-sticker

When you set **Location** to **Retail store**, E-sticker (Electronic Sticker) is displayed. E-sticker can be Turned Off using procedure below.

- 1 Use ▲▼ to select **Preferences**, then press **OK**.
- 2 Use ▲▼ to select **E-sticker**, then press **OK**.
- 3 Use ▲▼ to select **Off**, then press **OK**.

Use Philips EasyLink

Your TV supports Philips EasyLink, which enables one-touch play and one-touch Standby between EasyLink-compliant devices. Compliant devices must be connected via an HDMI connector.

One-touch play

When you connect your TV to devices that support one-touch play, you can control your TV and the devices with one remote control. For example, when you press ► (**play**) on your DVD remote control, your TV automatically switches to the correct channel to show the DVD content.

One-touch Standby

When you connect your TV to devices that support Standby, you can use your TV remote control to put your TV and all connected HDMI devices in Standby mode. You can perform one-touch Standby using the remote control from any of the connected HDMI devices.

System audio control

When you connect your TV to HDMI CEC compliant devices, your TV can switch automatically to play audio from the connected device. To use one-touch audio, you must map the audio input from the connected device to your TV. You can use the remote control from the connected device to adjust the volume.

Remote control (RC) key forwarding

RC key forwarding allows you to control EasyLink-compliant devices using your TV remote control.

HDMI-ARC (Audio Return Channel) (HDMI 1 only)

HDMI-ARC allows you to use Philips EasyLink to output TV audio directly to a connected Audio device, without the need for an additional Digital Audio cable. Be sure that the device is HDMI CEC and ARC compliant, and that the TV is connected to the device using an HDMI cable attached to both HDMI-ARC connectors.

Note

- Philips does not guarantee 100% interoperability with all HDMI CEC devices.
- The EasyLink-compliant device must be Switched On and selected as the source.

EasyLink

This function allows you to operate the linked functions between our brand devices with a EasyLink feature and this unit connecting through an HDMI cable. You must connect this unit to our brand EasyLink devices and be sure its EasyLink setting is also set to On.

- 1 Use ▲▼ to select **Preferences**, then press **OK**.
- 2 Use ▲▼ to select **EasyLink**, then press **OK**.
- 3 Use ▲▼◀▶ to select the item you want to adjust, then press **OK**.

Location	Master EasyLink	On
EasyLink	Auto TV on	On
	RC key forwarding	Select
	HDMI-ARC	Off
	Device list	Select

Set the **Master EasyLink** to **On** or **Off**. The following additional settings will be grayed out when you set to **Off**.

Master EasyLink	Off	Disables all EasyLink.
	On	Selects if you have connected an external device that is compatible with the EasyLink function.

This unit will Turn On when the Power On signal is sent from your connected EasyLink device.

Auto TV on	Off	This unit stays in Standby mode even if you Turn On your connected EasyLink device.
	On	This unit Turns On automatically when you Turn On your connected EasyLink device.

You can operate some functions such as disc playback or call up the menu of the connected devices, by using this unit's remote control. You can set each HDMI input to activate the **RC key forwarding**. Each press of **OK** will toggle **RC key forwarding On** or **Off**.

- indicates that the **RC key forwarding** is **On**.
- indicates that the **RC key forwarding** is **Off**.

RC key forwarding	HDMI 1	PLAY, PAUSE ▶ /STOP ■/ FWD ▶▶/REV ◀◀/☐ OPTIONS/ ▲▼◀▶/OK/BACK/ the NUMBER buttons can be used to control your connected EasyLink devices by this unit's remote control.
	HDMI 2	
	HDMI 3	
	HDMI 4	

HDMI-ARC allows you to use Philips EasyLink to output TV Audio directly to a connected Audio device, without the need for an additional Digital Audio cable

HDMI-ARC (HDMI 1 only)	Off	Disable HDMI-ARC.
	On	You can output TV Audio through the HDMI cable solely, provided both the TV and device are HDMI-ARC compliant.

Device list

This function lets you see the product model number or name of connected devices.

Use ▲▼ to select the desired EasyLink device listed on the TV screen, then press **OK**.

Your connected EasyLink device will be Turned On if the device is in Stand by mode.

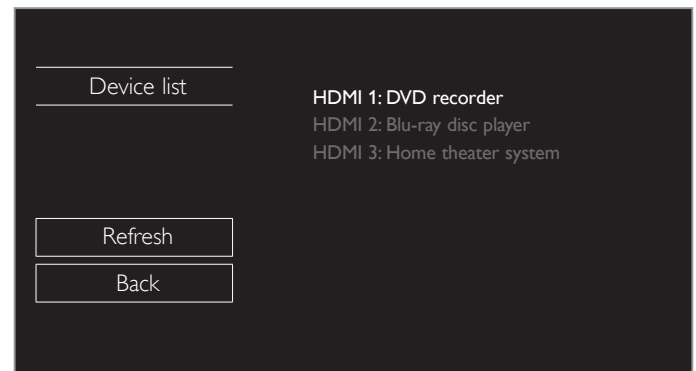

Network

Set up network connection settings in order to use Net TV or network upgrade function.

- The meanings of abbreviations are defined as below.
 - AP :Wireless LAN Access Point
 - WPS :Wi-Fi protected Setup
 - SSID :Wireless network name
- The key entry screen will appear when you select SSID, WEP/WPA/WPA2 or Proxy address.

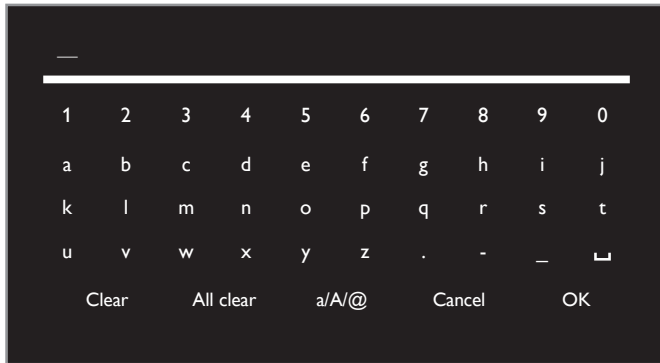

- Enter the key of the selected wireless network using ▲▼◀▶, then press **OK**.
 - Clear** : Clear the entered number or word.
 - All clear** : Clear all the entered numbers or words.
 - a/A/@** : Switch between abc, ABC and @!?
 - Cancel** : Shows the cancellation display.
 - OK** : Set the entered number or word.

1 Use ▲▼ to select **Network**, then press **OK**.

Picture	Language	English
Sound	Channels	Autoprogram
Features	Preferences	Location
Installation	Network	Network settings assi
Software	Reset AV settings	Start now

Network settings assistant

Before you proceed to **Connection test** or other settings in **Network** section, set this selection to suit your preference.

2 Use ▲▼ to select **Network settings assistant**, then press **OK**.

Language	Network settings assistant	Start now
Channels	Manual network settings	Network selection
Preferences	Connection test	Start now
Network	Setting status	Information
Reset AV settings	Reset network settings	Start now

3 Press **OK** to select **Start now**.

Wireless setting

Select to use a wireless LAN to connect to the Internet by wireless connection.

4 Use ▲▼ to select **Wireless**, then press **OK**.

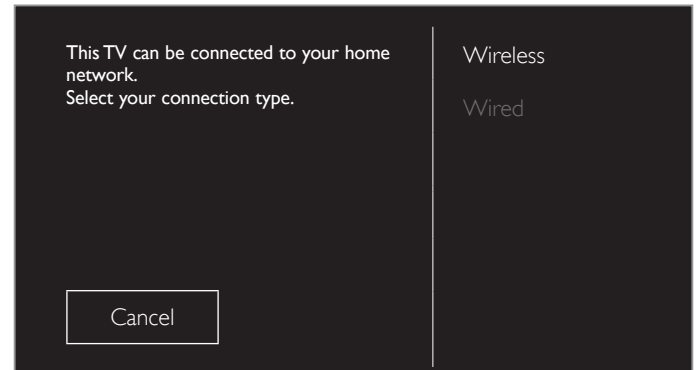

5 Use ▲▼ to select the desired setting, then press **OK**.

Easy connect	Select this setting if your router has a WPS button. Start scanning for wireless networks on the TV after pressing the WPS button on your router. If connection test fails, try Easy connect again.*1 If it fails then refer to the router's manual for more details.
Scan	Search for wireless networks automatically and select the SSID from the list. Wireless network setting ►► p.41
Manual entry	Set up the connection to the AP (e.g. wireless router) manually by entering the SSID.

*1 WPS (Easy Connect) cannot be used when the security protocol is set to WEP. Change the Access Point's security mode from WEP to WPA or WPA2 (recommended).

Wired setting

Select to use an Ethernet cable to connect to the Internet by wired connection. Please purchase shielded Ethernet cables at your local store and use them when you connect to network equipment.

4 Use ▲▼ to select **Wired**, then press **OK**.

- Connection test** will start automatically. ►► p.42

Manual network settings

2 Use ▲▼ to select **Manual network settings**, then press **OK**.

Network settings assistant	Network selection	Wireless
Manual network settings	Wireless network setting	Auto
Connection test	IP configuration	IP setting mode
Setting status	Proxy configuration	Proxy setting
Reset network settings		

Network selection

3 Use ▲▼ to select **Network selection**, then press **OK**.

4 Use ▲▼ to select the desired setting, then press **OK**.

Wired	If you connect to an Ethernet cable, select Wired to connect to the Internet.
Wireless	If you have a router with WPS function, select Wireless to connect to the Internet.

Continued on next page.

Wireless network setting

This menu is displayed only when you set **Wireless** in **Network selection**. In order to use a wireless network, you must set up a connection to the AP (e.g. wireless router).

3 Use ▲▼ to select **Wireless network setting**, then press **OK**.

Auto

Search for wireless networks automatically and select the SSID from the list.

4 Use ▲▼ to select **Auto**, then press **OK**.

5 The list of wireless networks will be displayed.
Use ▲▼ to select the appropriate the SSID, then press **OK**.

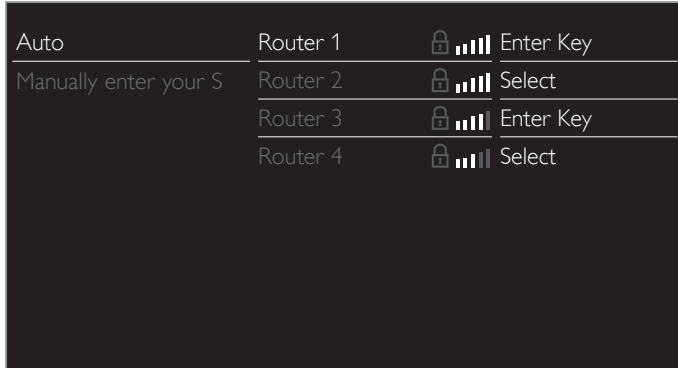

- If you select the SSID with a lock icon, WEP*2/WPA/WPA2 Key entry screen will appear. Enter the WEP*2/WPA/WPA2 key of the selected wireless network using ▲▼◀▶, then press **OK**.
- If you select the SSID has a WPS, the WPS setting screen will appear. Use ▲▼◀▶ to select a setting, then press **OK**.

Easy connect	Select this setting if your router has a WPS button. Start scanning for wireless networks on the TV after pressing the WPS button on your router. If connection test fails, try Easy connect again.*1 If it fails then refer to the router's manual for more details.
WPS code	Select this setting if your router has a WPS but does not have a WPS button. Enter the 8-digit WPS PIN code shown on your TV in the router settings menu via PC before Connect is selected.
Manual	If your wireless network with authentication setting (WEP*2, WPA-PSK or WPA2-PSK), WEP*2/WPA/WPA2 Key entry screen will appear. Enter the WEP*2/WPA/WPA2 key of the selected wireless network using ▲▼◀▶, then press OK .

*1 WPS (Easy Connect) cannot be used when the security protocol is set to WEP. Change the Access Point's security mode from WEP to WPA or WPA2 (recommended).

*2 WEP is not recommended to be used due to its Major security flaws. Change the Security protocol on the wireless router to WPA or WPA2 (recommended) mode.

Confirmation message will appear. Select **OK** to complete the settings.

Note

- For a wireless network with authentication setting, key icon appears to the right hand of the SSID.
- Signal icon shows the strength of the signal.
- WEP*2/WPA key appears as asterisks on the confirmation screen.
- The wireless LAN supports following specifications.
 - Wireless standards : IEEE 802.11 b/g/n
 - Frequency spectrum : 2.4GHz
 - Security protocol : WEP*2/WPA/WPA2

Manually enter your SSID

Set up the connection to the AP (e.g. wireless router) manually by entering the SSID.

4 Use ▲▼ to select **Manually enter your SSID**, then press **OK**.

- AP (e.g. wireless router) SSID entry screen will appear. Enter the SSID using ▲▼◀▶, then press **OK**.

5 Use ▲▼ to select the authentication setting of the selected wireless network.

- For a wireless network with authentication setting, select the authentication setting, according to the security type of the wireless network.

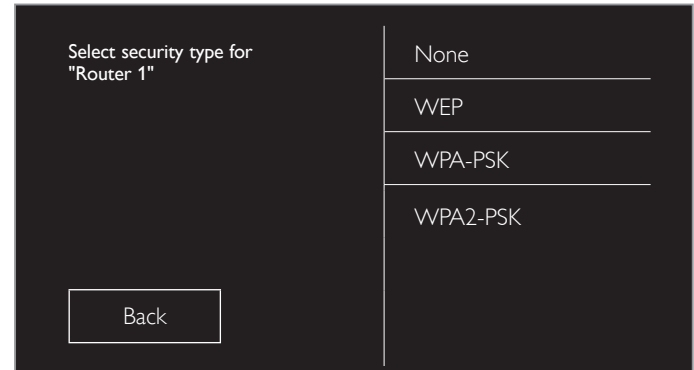

None	Set the authentication setting to None .
WEP*2	Set the authentication setting to WEP *2.
WPA-PSK	Set the authentication setting to WPA-PSK .
WPA2-PSK	Set the authentication setting to WPA2-PSK .

- For a wireless network without authentication setting, select **None**.
- If you select **WEP*2**, **WPA-PSK** or **WPA2-PSK**, WEP*2/WPA/WPA2 Key entry screen will appear. Enter the WEP*2/WPA/WPA2 key of the selected wireless network using ▲▼◀▶, then press **OK**.
- Confirmation message will appear. Select **Yes** to complete the settings.

*2 WEP is not recommended to be used due to its Major security flaws. Change the Security protocol on the wireless router to WPA or WPA2 (recommended) mode.

Continued on next page.

IP configuration

In following cases, select **IP configuration** to set each setting as necessary.

- When connection test failed with the setting of **Connection test**.
- When instructed by your Internet service provider to make specific settings in accordance with your network environment.

3 Use ▲▼ to select **IP configuration**, then press **OK**.

4 Use ▲▼ to select a setting, then press **OK**.

Network selection	IP setting mode	Manual
Wireless network setting	IP address	192.168.11.3
IP configuration	Subnet mask	255.255.255.0
Proxy configuration	Default gateway	192.168.11.1
	Primary DNS	192.168.11.1
	Secondary DNS	0.0.0.0
	MAC address	00:12:0E:10:09:15

IP setting mode	Auto	Sets the IP setting automatically.
	Manual	Sets the IP setting manually.
IP address * ^{1,3}		A set of numbers which are assigned to devices participating in a computer network.
Subnet mask * ^{1,3}		A mask which is used to determine what subnet an IP address belongs to.
Default gateway * ^{1,3}		IP address of the network device (such as router) which provides Internet access.
DNS setting mode	Auto	Sets the DNS setting automatically.
	Manual	Sets the DNS setting manually.
Primary DNS * ^{2,3}		A server which handles the name and IP address over the Internet.
Secondary DNS * ^{2,3}		A server which handles the name and IP address over the Internet.
MAC address		An address which recognizes the devices connecting to the network. It is also called Hardware Address.

*¹ Items can be selected only when **IP setting mode** is set to **Manual**.

*² Items can be selected only when **DNS setting mode** is set to **Manual**.

*³ Use ▲▼ or the **NUMBER buttons** to input numbers. When you use ▲▼ to input numbers, then press **OK** or input the triple digits by using the **NUMBER buttons**, the cursor moves to the next entry field. When you use ▲▼ to input numbers, then press **OK** or input the triple digits by using the **NUMBER buttons** at the rightmost entry field, numbers will be stored and go back to the previous menu.

Note

- The range of input numbers is between 0 and 255.
- If you enter a number larger than 255, the number will automatically be 255.
- The manually entered number will be saved even if you change the setting to **Auto**.
- If you want to enter 1 or 2 digit number in one cell, press **OK** to move on to the next cell.
- If the entered IP address or the default gateway or primary DNS number is same as the default setting, IP address setting will be set to **Auto**. (The manually entered number will be saved).
- When IP address setting is set to **Manual**, the setting of DNS setting will automatically be **Manual** and when IP address setting is set to **Auto**, you can set either **Auto** or **Manual** for DNS setting.

Proxy configuration

3 Use ▲▼ to select **Proxy configuration**, then press **OK**.

4 Use ▲▼ to select a setting, then press **OK**.

Network selection	Proxy setting	Do not use
Wireless network setting		
IP configuration		
Proxy configuration		

- **Do not use** is selected for default settings.
- If you need to change the proxy setting as instructed by your Internet service provider to set the designated proxy address and port, select **Use**.

Proxy setting	Do not use	Not use the proxy server.
	Use	Uses the proxy server.
Proxy address *		Selects the number or word by using ▲▼◀▶, then press OK .
Proxy port *		Use ▲▼ or the NUMBER buttons to input numbers.

* Items can be selected only when **Proxy setting** is set to **Use**.

Note

- The range of input numbers for the port number is between 0 and 65535. (If you enter a number larger than 65535, it will be regarded as 65535.)
- For proxy port, the selected ports may be blocked and not be able to use depending on your network environment.
- If the proxy address is entered with blank only, proxy server setting will be set to **Do not use**.

Connection test

Perform the following steps to test your Internet connection after you have connected an Ethernet cable or entered network settings such as IP address, DNS settings, etc. manually.

2 Use ▲▼ to select **Connection test**, then press **OK**.

3 Press **OK** to select **Start now**.

- Connection test will start automatically and the test result will appear right after the connection test finishes.

Testing...	The test is in progress.
Pass	Connection test is successfully completed.
Fail	Connection test failed. Check the connection settings.

4 Press **OK** to go to the list of network status confirmation screen.

Note

- If the connection test passes, you are ready to use Net TV or network upgrade function using the Internet without making any additional settings.
- If the connection test fails, check if the Ethernet cable is connected to this TV properly or if you have entered all the required details for the wireless LAN connection properly.

Continued on next page.

Setting status

You can check the status of network settings.

- Use ▲▼ to select **Setting status**, then press **OK**.
 - Network setting list will be displayed.
 - MAC address of this unit will be displayed in the list.

Reset network settings

You can reset the status of network settings.

- Use ▲▼ to select **Reset network settings**, then press **OK**.
- Press **OK** to select **Start now**.

Return your settings to default values

When you return picture and sound settings to their default values the channel installation settings are not affected.

- Use ▲▼ to select **Reset AV settings**, then press **OK**.
- Press **OK** to select **Start now**.

Software

Philips continuously tries to improve its products and we strongly recommend that you upgrade the TV software when upgrades are available.

New software can be downloaded from our website at www.philips.com/support using the model number of your TV to find information.

- Press **HOME** (MENU) and use ▲▼◀▶ to select **Setup**, then press **OK**.
- Use ▲▼ to select **Software**, then press **OK**.

Picture	Software information	Select
Sound	Software update	USB
Features	Automatically check for	Off
Installation	Netflix deactivation	
Software	Netflix ESN	
	VUDU deactivation	
	YouTube deactivation	
	Hulu Plus deactivation	

Note

- Digital Rights Management**
This product contains technology subject to certain intellectual property rights of Microsoft. Use or distribution of this technology outside of this product is prohibited without the appropriate license(s) from Microsoft.

Checking your current software version

- Use ▲▼ to select **Software information**, then press **OK**.
 - The version and a description of the current software is displayed.

Picture	Software information	PHL-XXXXX_XXX_X
Sound	Software update	
Features	Automatically check for	
Installation	Netflix deactivation	
Software	Netflix ESN	
	VUDU deactivation	
	YouTube deactivation	
	Hulu Plus deactivation	

Preparing for the software upgrade

You require the following equipment:

- A PC with web browsing capability
- An archive utility that supports the ZIP-format (e.g. WinZip for Windows or Stuffit for Mac OS)
- An empty clean formatted USB Memory Stick

Note

- Only FAT/DOS-formatted portable memory is supported.
- Use only software upgrades that can be found on the Philips web site.

Warning

- When the software upgrade is running, don't press any buttons.
- Do not remove the USB Memory Stick during the software upgrade.
- If an error occurs during the upgrade, retry the procedure or for further assistance, please contact Call Center.

Downloading the software

Find information and software related to your TV and download the latest software upgrade file to your PC.

- On your PC, open a web browser and go to www.philips.com/support.
- Enter the model number in the "Type the Model Number..." field.
- Click the desired software to be downloaded.
 - Decompress the ZIP-file.
- Copy the upgrade file to the root directory of the USB Memory Stick.

Upgrading the software

USB upgrade

You can upgrade the software by using USB Memory Stick.

- 1 Connect your USB Memory Stick with the upgrade file to the USB terminal on the side of your TV.



- 2 Use ▲▼ to select **Software update**, then press **OK**.
- 3 Use ▲▼ to select **USB**, then press **OK**.
- 4 Use ▲▼ to select your desired USB port, then press **OK**.
- 5 Use ▲▼ to select the desired Update file.
- 6 Use ◀▶ to select **Yes**, then press **OK**.
- 7 Read the on-screen instructions and confirm that you want to continue with the installation.



- 8 When the software upgrade is completed, press ⏻ to set the unit to go into Standby mode, then remove the USB Memory Stick.
- 9 Unplug the AC power cord for a few seconds from AC outlet and plug it again.
- 10 Press ⏻ again to Turn the unit On.
 - The TV starts up with the new software.
 - For further assistance, please contact Call Center.

Network update

You can update the software by connecting the unit to the Internet.

- 1 Use ▲▼ to select **Software update**, then press **OK**.
- 2 Use ▲▼ to select **Network**, then press **OK**.
- 3 Use ◀▶ to select **Yes**, then press **OK**.
 - This unit will then start checking for the latest firmware version.
- 4 Confirmation message will appear. Use ◀▶ to select **Yes**, then press **OK**.
 - The unit will start downloading the latest firmware version.
 - The unit will start updating the firmware version.
 - It may take a while to complete the updating.
- 5 When the software update is complete, press ⏻ to make sure the unit goes to Standby mode.
- 6 Unplug the AC power cord for a few seconds from AC outlet and plug it again.
- 7 Press ⏻ again to Turn the unit On.
 - The TV starts up with the new software.
 - For further assistance, please contact Call Center.

Note

- In order to update software via the Internet, you must connect the unit to the Internet and set up necessary settings. **Network settings assistant** ■■■▶ p.40 **Network** ■■■▶ p.40
- Please do not unplug the AC power cord or Ethernet cable while executing the **Network update**.
- All settings will remain the same even if you update the software version.
- The version of Net service will also be updated if newer version of Net service is available when updating the firmware.

Automatically check for latest software

This function lets you know if the latest software is available while the unit is connected to the Internet.

- 1 Use ▲▼ to select **Automatically check for latest software**, then press **OK**.
- 2 Use ▲▼ to select the desired option, then press **OK**.

Off	Disable automatically check for latest software.
On	A message will appear if there is the latest software on the network server.

Netflix deactivation

Displays the deactivation setting for Netflix.

- 1 Use ▲▼ to select **Netflix deactivation**, then press **OK**.
- 2 Use ▲▼ to select the desired option, then press **OK**.

Yes	Deactivate the connection to Netflix.
No	Activate the connection to Netflix.

Netflix ESN

Displays the ESN information.

- 1 Use ▲▼ to select **Netflix ESN**, then press **OK**.
 - Displays the ESN (Electronic Serial Number) to get any services from Netflix.

VUDU deactivation

Displays the deactivation setting for VUDU.

- 1 Use ▲▼ to select **VUDU deactivation**, then press **OK**.
- 2 Use ▲▼ to select the desired option, then press **OK**.

Yes	Deactivate the connection to VUDU.
No	Activate the connection to VUDU.

YouTube deactivation

Displays the deactivation setting for YouTube.

- 1 Use ▲▼ to select **YouTube deactivation**, then press **OK**.
- 2 Use ▲▼ to select the desired option, then press **OK**.

Yes	Deactivate the connection to YouTube.
No	Activate the connection to YouTube.

Hulu Plus deactivation

Displays the deactivation setting for Hulu Plus.

- 1 Use ▲▼ to select **Hulu Plus deactivation**, then press **OK**.
- 2 Use ▲▼ to select the desired option, then press **OK**.

Yes	Deactivate the connection to Hulu Plus.
No	Activate the connection to Hulu Plus.

6 Connecting devices

No supplied cables are used with these connections:

- Please purchase the necessary cables at your local store.

Before you connect AC power cord:

Be sure other devices are connected properly before plugging in the AC power cord.

Selecting your connection quality

HDMI - Highest quality

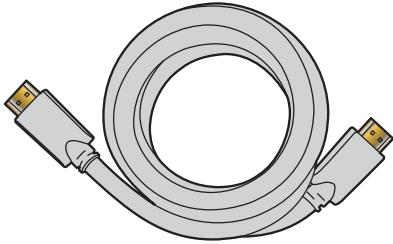

Supports high-definition Digital signals and gives highest picture and sound quality. Video and Audio signals are combined in one cable. You must use HDMI for full high-definition video and to enable Philips EasyLink.

Note

- Philips HDMI supports HDCP (High-bandwidth Digital Contents Protection). HDCP is a form of Digital Rights Management that protects high definition content in Blu-ray discs or DVDs.
- The HDMI-ARC connector on the TV features HDMI-ARC functionality. This allows output of TV Audio to an HDMI-ARC-compliant device.

Component (Y Pb Pr) - High quality

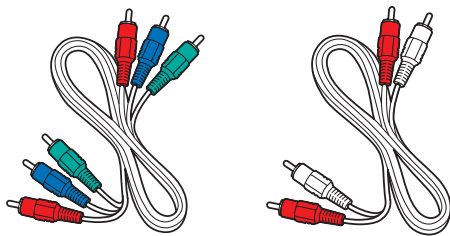

Supports high-definition Analog signals but gives lower picture quality than HDMI. Component (Y/Pb/Pr) Video cables combine Red/Green/Blue video cables with Red/White Audio (L/R) cables. Match the cable colors when you connect to the TV.

Composite - Basic quality

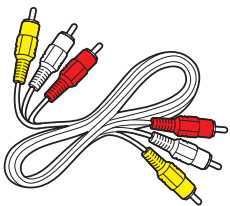

For Analog connections. Composite Video/Audio Analog cable usually combine a Yellow video cable with Red/White Audio (L/R) cables. With this unit, Yellow cable must be connected to Y (Green) of Component Video Input jacks.

Connecting your devices

HDMI Digital connection

HDMI connection offers the highest picture quality. HDMI (High-Definition Multimedia Interface) transports high definition Digital video and multi-channel Digital Audio through a single cable.

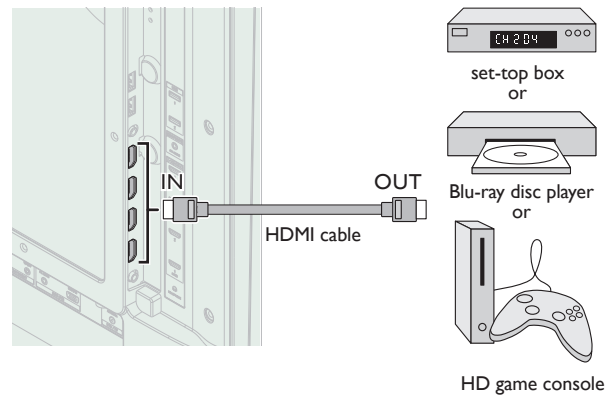

HDMI-DVI connection

This unit can be connected to your device that has a DVI terminal. Use an HDMI-DVI conversion cable for this connection and it requires Audio cable for Analog Audio signal as well.

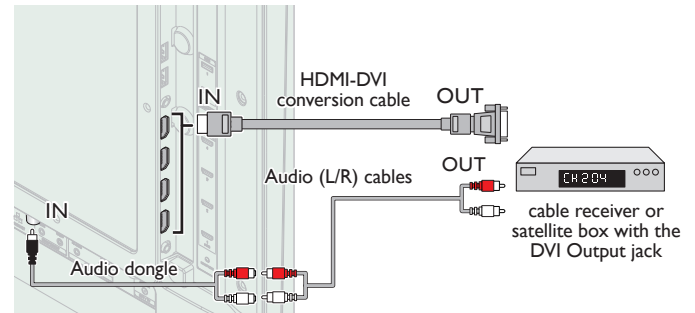

Note

- Use an HDMI cable with the HDMI logo (a certified HDMI cable). High Speed HDMI cable is recommended for the better compatibility.
- For HDMI connection**
- The unit accepts 480i / 480p / 720p / 1080i, 1080p 24/30/60Hz of video signals, 32kHz / 44.1kHz and 48kHz of Audio signals.
 - This unit accepts 2 channel Audio signal (LPCM) only.
 - This unit accepts only signals in compliance with EIA861.
- For HDMI-DVI connection**
- The unit accepts 480i, 480p, 720p, 1080i and 1080p video signals.
 - HDMI-DVI connection requires separate Audio connections as well and the Audio signals are output as Analog (L/R) Audio.
 - DVI does not display 480i image which is not in compliance with EIA/CEA-861/861B.

Continued on next page.

HDMI-ARC connection

HDMI-ARC allows you to use EasyLink to output TV Audio directly to a connected Audio device, without the need for an additional Digital Audio cable.

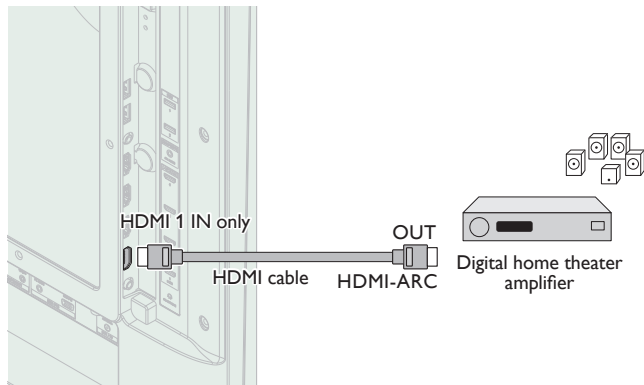

Note

- The HDMI 1 connector is HDMI Audio Return Channel (ARC) compliant. Use it to output Digital Audio to an HDMI home theater system.
- Be sure that the device is HDMI CEC and ARC compliant and that the TV is connected to the device using an HDMI cable attached to HDMI-ARC connectors.

Component Analog Video Connection

Component Analog Video connection offers better picture quality for video devices connected to the unit.

If you connect to the unit's Component Video (Y/Pb/Pr) Input jacks, connect Analog Audio cables to the Analog Audio (L/R) Input jacks.

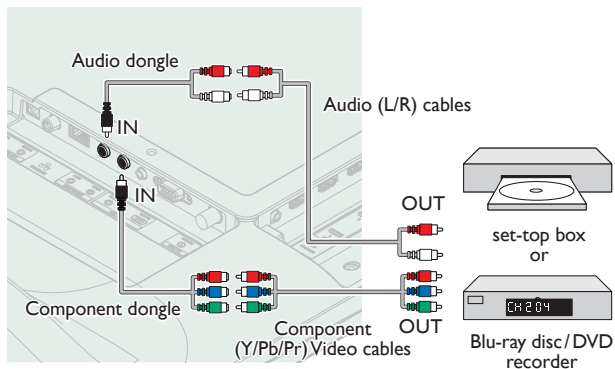

Note

- The unit accepts 480i/480p/720p and 1080i/p of video signals for this connection.

Composite Analog Video Connection

Composite Analog Video connection offers standard picture quality for video devices connected to the unit.

If you connect to the unit's Composite Video (Y/VIDEO) Input jack, connect Audio cables to the Audio (L/R) Input jacks. When the Audio is monaural, then only connect to the Audio L Input jack.

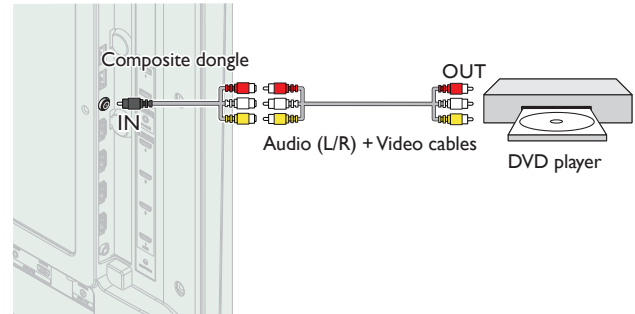

Note

- With this unit, Yellow cable must be connected to Y (Green) of Component Video Input jacks.
- Whenever you connect to the Composite Video Input jack (Y/VIDEO), you must disconnect the Component Video Input jacks (Pb and Pr). If you leave those jacks connected, it may cause of unstable picture.
- Only the left loudspeaker reproduces sound for mono equipment. Use a mono to stereo adapter (not supplied) for sound reproduction via all internal loudspeakers.

Connecting the TV to the Internet using an Ethernet cable

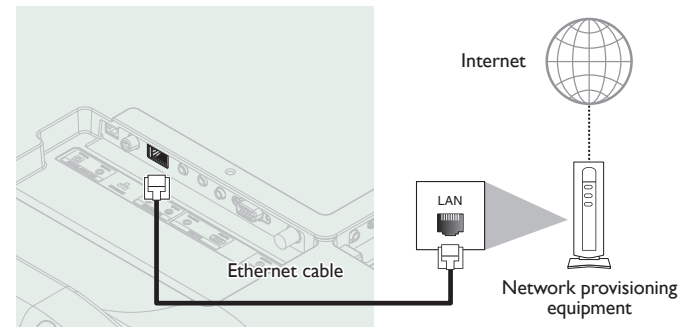

Note

- Please purchase shielded Ethernet cables at your local store and use them when you connect to network equipment.
- After connecting an Ethernet cable, set up necessary network settings. **Network** **▶▶▶ p.40**
- Do not insert any cable other than an Ethernet cable to the Ethernet port to avoid damaging the unit.
- If your telecommunications equipment (modem, etc.) does not have broadband router functions, connect a broadband router.
- If your telecommunications equipment (modem, etc.) has broadband router functions but there is no vacant port, use a hub.
- For a broadband router, use a router which supports 10BASE-T/100BASE-TX.
- Do not connect your PC directly to the Ethernet port of this unit.

Continued on next page.

Connecting the TV to the Internet using a wireless LAN

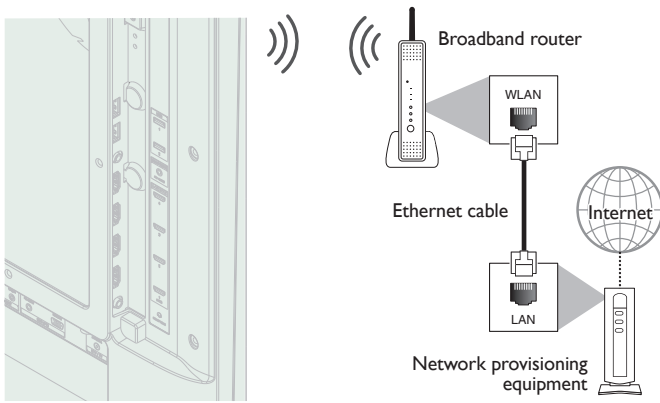

Note

- After you made the wireless connection, set up necessary network settings. **Network** **p.40**
- Use a Wireless LAN Access Point (AP) (e.g. wireless router) which supports IEEE 802.11 b/g/n. (n is recommended for stable operation of the wireless network.)
- This unit does not support Ad-hoc mode.
- Other radio devices or obstacles may cause interference to the wireless network connection.

Digital Audio Output Connection

If you connect this unit to an external Digital Audio device, you can enjoy multi-channel Audio like 5.1 ch Digital broadcasting sound. Use a Digital Audio coaxial cable or Digital Audio optical cable to connect the unit to external Digital Audio devices.

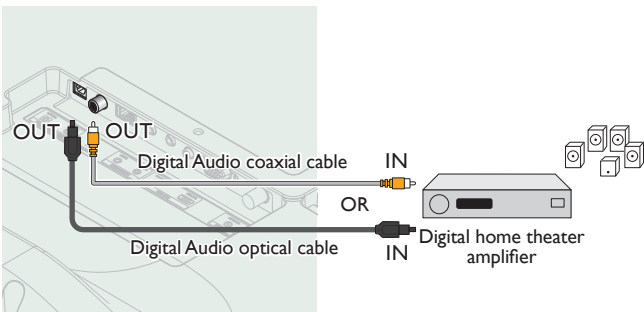

PC connection

HDMI connection

This unit can be connected to your PC that has a HDMI terminal. Use an HDMI cable for this Digital connection.

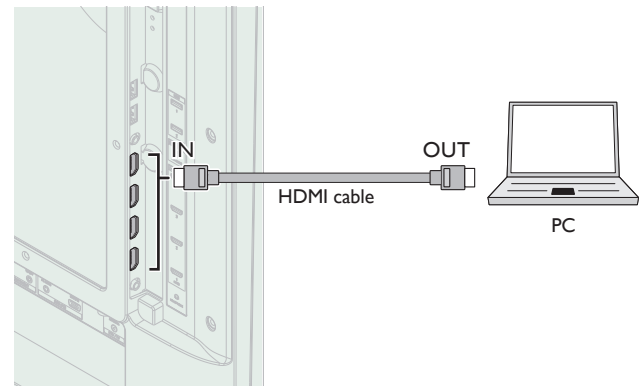

HDMI-DVI connection

This unit can be connected to your PC that has a DVI terminal. Use an HDMI-DVI conversion cable for this Video Digital connection and it requires Stereo mini 3.5mm plug Audio cable for Analog Audio signal as well.

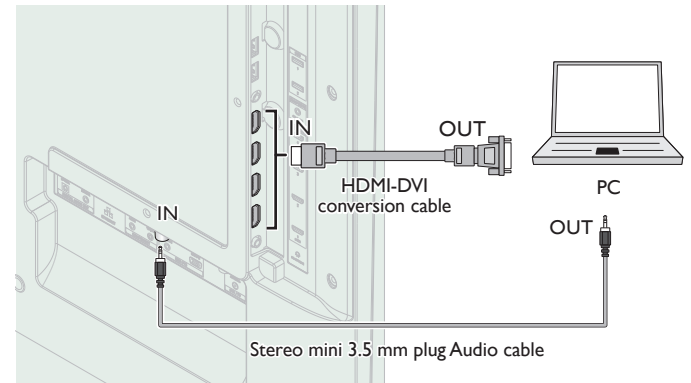

VGA connection

This unit is equipped with a PC Input jack. If you connect this unit to your PC, you can use this unit as a PC monitor. Use a VGA cable for this Video connection and it requires a Stereo mini 3.5mm plug Audio cable for Analog Audio signal as well.

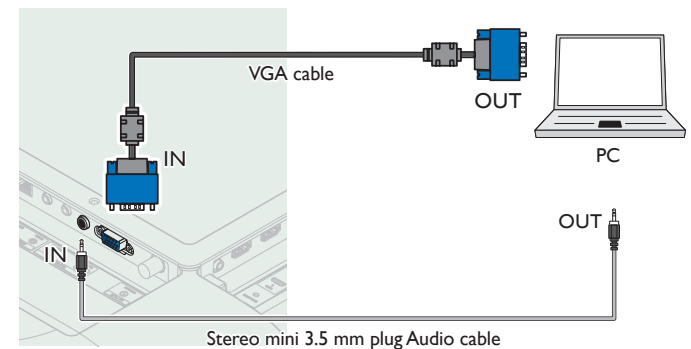

Continued on next page.

The following video signals can be displayed:

Resolution	Refresh rate
640 × 480	60Hz
720 × 480	
800 × 600	
1024 × 768	
1280 × 768	
1280 × 1024	
1360 × 768	
1400 × 1050	
1440 × 900	
1680 × 1050	
1920 × 1080	

Other formats or non-standard signals will not be displayed correctly.

Note

- Please purchase the VGA cable or HDMI-DVI conversion cable that has a ferrite core.
- The following operations may reduce noise.
 - Attach a ferrite core to the AC power cord of your PC.
 - Unplug the AC power cord and use the built-in battery of your PC.
- Use an HDMI cable with the HDMI logo (a certified HDMI cable). High Speed HDMI cable is recommended for the better compatibility.
- The unit accepts 480i, 480p, 720p, 1080i and 1080p video signals.
- HDMI-DVI connection requires separate Audio connections as well and the Audio signals are output as Analog (L/R) Audio.
- DVI does not display 480i image which is not in compliance with EIA/CEA-861/861B.

USB Memory Stick

This unit offers easy playback of picture (JPEG), music (MP3) and video files.

Insert the USB Memory Stick into the USB terminal shown below.

USB  p.27



Note

- The unit recognizes only a USB Memory Stick.
- Do not use a USB hub or an extension cable to connect an external hard disk drive to the unit. (Not supported.)
- A USB Memory Stick is always inserted to this unit directly.
- A USB Memory Stick is not supplied with this unit.
- We do not guarantee that all USB Memory Sticks can be supported by this unit.
- Be sure to keep a backup copy of the original files on your device before you play them back on this unit. We have no responsibilities for damage or loss of your stored data.
- To protect your USB Memory Stick files from being erased place the write protect sliding tab in the protect position.
- When you are ready to remove a USB Memory Stick, set the unit to go into Standby mode to avoid any damage to your data and the unit.
- A USB Memory Stick that requires its own driver or the device with a special system such as fingerprint recognition are not supported.
- This unit is not allowed to use the USB Memory Stick which requires an external power supply (500mA or more).

7 Useful tips

FAQ

Question	Answer
My remote control does not work. What should I do?	<ul style="list-style-type: none"> • Check the antenna or cable connection to the main unit. • Check the batteries of the remote control. • Check if there is an obstacle between the infrared sensor window and the remote control. • Test the signal Output use IR Signal Check. ▶▶▶ p.52 If okay, then possible infrared sensor trouble. • Aim the remote control directly at the infrared sensor window on the front of the unit. • Reduce the distance to the unit. • Re-insert the batteries with their polarities (+/-) as indicated. • When there is an infrared-equipped device such as PC near this unit, it may interrupt the remote control signal of this unit. Move the infrared-equipped device away from this unit, change the angle of the infrared sensor or Turn Off the infrared communication function.
How come the initial setup appears every time I Turn On this unit?	<ul style="list-style-type: none"> • Make sure to complete the initial setup before the unit goes into Standby mode.
Why can I not watch some RF signal TV programs.	<ul style="list-style-type: none"> • Autoprogram must be completed when you set up the unit for the first time or move it to a location where previously unavailable channels are broadcast. • Make sure Autoprogram has been completed. ▶▶▶ p.37 • The selected channel may not be broadcasting. • When Autoprogram is interrupted and not completed, some channels will not be received. Make sure to complete the Autoprogram. ▶▶▶ p.37 • The selected channel cannot be viewed by the Child and ratings lock setting. ▶▶▶ p.34 • The unit requires some kind of antenna Input. An indoor antenna (Digital or VHF/UHF), an external antenna (Digital or VHF/UHF) or an RF coaxial cable from your wall cable/satellite box needs to be plugged into the unit.
How come there is no image from the connected external devices?	<ul style="list-style-type: none"> • Check if the correct Input mode is selected by pressing ☐ SOURCE. Watching channels from an external device ▶▶▶ p.16 • Check the antenna, cable or other Input connection to the unit. • When using the Component Video Connection check that the Green (Y), Blue (Pb/Cb) and Red (Pr/Cr) connectors are connected to their corresponding colored jacks on the unit.
When I enter a channel number, it changes automatically.	<ul style="list-style-type: none"> • Many Digital channels have alternate channel numbers. The unit changes the numbers automatically to the ones signifying the broadcasting station channel number. These basic numbers used for previous Analog broadcasts. (e.g., Input ch# 30 automatically changes to ch# 6.1)
Why are captions not displayed entirely? Or, captions are delayed behind the dialog.	<ul style="list-style-type: none"> • Captions that are delayed a few seconds behind the actual dialog are common for live broadcasts. Most captioning production companies can display a dialog to maximum of 220 words per minute. If a dialog exceeds that rate, selective editing is used to insure that the captions remain up-to-date with the current TV screen dialog.
How can I set the clock ?	<ul style="list-style-type: none"> • There is no clock function on this unit.
I cannot change the Child lock setting because my PIN code no longer works.	<ul style="list-style-type: none"> • Although the default PIN code (0000) is supplied with the unit, the PIN code will be required once you set a PIN code in Child and ratings lock. ▶▶▶ p.34 When you forget your PIN code, enter 0711 in Change PIN to reset the PIN code. ▶▶▶ p.36

Troubleshooting

If the unit does not perform properly when operated as instructed in this User Manual, **check the following chart and all connections once before calling for service.**

Symptom	Remedy
No power	<ul style="list-style-type: none"> • Make sure the AC power cord is plugged in. • Make sure that the AC outlet supplies the proper voltage, plug another electrical appliance into the AC outlet to ensure that the AC outlet operates normally. • If a power failure occurs, unplug the AC power cord for 1 minute to allow the unit to reset itself.
Control buttons do not work.	<ul style="list-style-type: none"> • Press only one button at a time. Do NOT press more than one button at the same time. • Ensure that no buttons on the remote control are depressed and move freely.
Power is ON but no screen image.	<ul style="list-style-type: none"> • Check whether the connection of the antenna, cable receiver or satellite box is connected correctly. • Check whether all the cables to the unit are connected to the correct Output jack of your device like Blu-ray/DVD recorder. • Make sure that the selected Input mode is connected to the working Input jack. • Check if your computer is NOT in sleep mode when the Input mode of this unit is in PC mode. Tap any key on the keyboard to wake up your computer.

Continued on next page.

Symptom	Remedy
Cannot use the wireless connection.	<ul style="list-style-type: none"> Check if the Wireless LAN Access Point (AP) (e.g. wireless router) is oriented properly or not placed too close between them. Once you have activated the wireless connection please wait 30 seconds for the connection to be established after Turning On the unit, before trying to access network features such as Net TV.
Cannot use Netflix feature.	<ul style="list-style-type: none"> Netflix is available only in the United States and Canada. Check if the network connection is properly made. Visit http://www.netflix.com/HowItWorks on your PC and become a Netflix member.
Cannot use Hulu Plus feature.	<ul style="list-style-type: none"> Hulu Plus is available only in the United States. Check if the network connection is properly made.
Cannot add movies or TV episodes to the Instant Queue.	<ul style="list-style-type: none"> Visit www.netflix.com on your PC.
Even though the speed of the Internet connection improves during playback, the picture quality of Netflix streaming movie does not improve.	<ul style="list-style-type: none"> The picture quality does not change during playback. It differs depending on the speed of Internet connection at the time of loading.
Cannot use VUDU feature.	<ul style="list-style-type: none"> VUDU is available only in the United States, Canada and Mexico. Check if the network connection is properly made.
Cannot rent or buy movies / TV episodes on VUDU.	<ul style="list-style-type: none"> You need to activate the VUDU account. For detailed information, please visit the service providers website at http://www.vudu.com/product_overview.html Log into your account at http://my.vudu.com and check your payment information.
The picture quality of streaming movie (Netflix, Hulu Plus, Film Fresh or VUDU) is poor.	<ul style="list-style-type: none"> Check the speed of your Internet connection. You need speeds of at least 8 Mbps to this player for high quality uninterrupted playback.
Streaming movie (Netflix, Hulu Plus, Film Fresh or VUDU) often stops or starts buffering during playback.	<ul style="list-style-type: none"> Contact your Internet service provider to troubleshoot your Internet connection for speed and line quality. Consistent line quality and speed are very important for Internet video playback.
Cannot connect to the network while my PC is connected to the network.	<ul style="list-style-type: none"> Check the content of your Internet service contract to see if your Internet Service Provider prevents multiple terminals connecting at the same time.
Cannot use Easy connect (WPS) to connect to the Access Point.	<ul style="list-style-type: none"> Connect the unit to the Access Point using Scan or Manual entry mode. If the Access Point's security mode is set to WEP*, change the setting to WPA or WPA2 (recommended), then try Easy connect (WPS) again. (For Access Point configuration, please consult its user manual or manufacturer.) * WEP is not recommended to be used due to its Major security flaws. Change the Security protocol on the wireless router to WPA or WPA2 (recommended) mode.
Folder or files stored on DLNA home media server are not displayed in the file list or cannot be played back.	<ul style="list-style-type: none"> Check the setting on your home media server. (Refer to the user manual of the home media server.) Check the network connection and settings.
Cannot use Film Fresh feature.	<ul style="list-style-type: none"> Film Fresh is available only in the United States. Check if the network connection is properly made. Visit http://filmfresh.roxionow.com/ (Film Fresh) on your PC and create an account.
Cannot use Pandora feature.	<ul style="list-style-type: none"> Check if the network connection is properly made. Pandora is available only in the United States. You must create a Pandora account and activate this unit. Activating Pandora ➡ p.22
The audio of Internet radio station interrupted.	<ul style="list-style-type: none"> vTuner server, station or the Internet connection is busy. The bit rate of the station is high.
Cannot play back Internet radio.	<ul style="list-style-type: none"> Check if the network connection is properly made. Check the firewall setting of the modem or router. For some stations, playback is not available on this unit.
The quality of the Internet radio audio is poor or noise occurs during playback of Internet station.	<ul style="list-style-type: none"> The bit rate of the station is low.
Cannot get into the PC's screen even the Philips Wireless MediaConnect is launched.	<ul style="list-style-type: none"> Make sure if the network connection is connected properly. Check if your PC runs Philips Wireless MediaConnect. Make sure your TV and PC are connected on the same network.
I have a 1.8GHz CPU but MediaConnect does not work on my PC.	<ul style="list-style-type: none"> For smooth operation of your PC while Philips Wireless MediaConnect is running you need a mainstream dual core processor from Intel® or AMD. Intel® : Core™2 Duo or Core™ i3/5/7 @ 1.8GHz or higher; AMD : Athlon™ II X2, Turion™ II Dual-Core or Phenom™ X2 @ 2GHz or higher.

Note

- The LCD screen is manufactured to provide many years of useful life. Occasionally a few non active pixels may appear as a fixed point of blue, green or red. This is not to be considered a defect in the LCD screen.
- Some functions are not available in specific modes, but this is not a malfunction. Read the description in this User Manual for more details on correct operations.

8 Information

Glossary

Analog TV (NTSC)

Acronym that stands for National Television Systems Committee and the name of Analog broadcasting standards. Off-the-air NTSC signals are no longer being sent by major broadcasting stations in the USA.

ARC (Audio Return Channel) (HDMI 1 only)

HDMI-ARC allows you to use Philips EasyLink to output TV audio directly to a connected Audio device, without the need for an additional Digital Audio cable. Be sure that the device is HDMI CEC and ARC compliant, and that the TV is connected to the device using an HDMI cable attached to both HDMI-ARC connectors.

Aspect ratio

The width of a TV screen relative to its height. Conventional TVs are 4:3 (in other words, the TV screen is almost square); widescreen models are 16:9 (the TV screen is almost twice as wide as its height).

CEC (Consumer Electronics Control)

This allows you to operate the linked functions between our brand devices with CEC feature and this unit. We do not guarantee 100% interoperability with other brands of CEC compliant devices.

Component Video

This is a video signal format that conveys each of 3 principal colors of light (red, blue and green) through different signal lines. This allows the viewers to experience picture colors as original as it is. There are several signal formats, including Y/Pb/Pr and Y/Cb/Cr.

Dolby Digital

The system developed by Dolby Laboratories to compress Digital sound. It offers stereo sound (2ch) or multi-channel Audio.

DTV (ATSC)

Acronym that stands for Advanced Television Systems Committee and the name of the Digital broadcasting standards.

E-sticker

E-sticker is showing set features, technical information, etc on this TV set that is displayed on the TV screen mainly used by TV retailers. Previously the information was on a printed sticker that was put on the display.

HDMI (High-Definition Multimedia Interface)

Interface that supports all uncompressed, Digital Audio/Video formats including set-top box, Blu-ray/DVD recorder or Digital television, over a single cable.

HDTV (High Definition TV)

Ultimate Digital format that produces high resolution and high picture quality.

PIN code

A stored 4-digit number that allows access to parental control features.

SAP (Secondary Audio Program)

Second-Audio channel delivered separately from main-Audio channel. This Audio channel is used as an alternate in bilingual broadcasting.

SDTV (Standard Definition TV)

Standard Digital format that is similar to the Analog TV (NTSC) picture quality.

SRS TruSurround HD™

Creates an immersive, feature-rich surround sound experience from two speakers, complete with rich bass, high frequency detail and clear dialog.

Maintenance

Cabinet Cleaning

- Wipe the front panel and other exterior surfaces of the unit with a soft cloth.
- Never use a solvent or alcohol. Do not spray insecticide liquid near the unit. Such chemicals may cause damage and discoloration to the exposed surfaces.

Panel Cleaning

Wipe the panel of the unit with a soft cloth. Before cleaning the panel, disconnect the AC power cord.

Servicing

Should your unit become inoperative, do not try to correct the problem yourself. There are no user serviceable parts inside. Call our toll free customer support line found on the cover of this User Manual to locate an authorized service center.

IR Signal Check

If the remote control is not working properly, you can use a Digital camera (including a cellular phone with built-in camera) to see if it is sending out an infrared signal.



With a Digital camera (including built-in cell phone cameras):
Point the Digital Camera towards the remote control infrared diode at the front of the remote control. Press any button on the remote control and look through the camera display. If the infrared pulsating light appears through the camera, the remote control is sending out an IR signal.

9 Specifications

Model #	55PFL5907 50PFL5907 46PFL5907 42PFL5907
Picture enhancement	
Type	FHD (1920 × 1080 pixels 120Hz)
Aspect ratio	16:9
Viewing angles	55PFL5907, 46PFL5907, 42PFL5907 : 178° (V) by 178° (H) 50PFL5907 : 176° (V) by 176° (H)
Built-in Digital tuner	ATSC / NTSC
Sound enhancement	
Mono / Stereo	Mono, Stereo, SRS TruSurround HD™
Power output (RMS watts)	8 W × 2 + 10 W woofer
Equalizer	5 band
Ease of use	
Picture format	SD (4:3 Source) : Automatic / Super zoom / 4:3 / Movie expand 14:9 / Movie expand 16:9 / Wide screen HD (16:9 Source) : Automatic / 4:3 / Wide screen / Unscaled (1080i/p only) HDMI AV (4:3 Source) : Automatic / Super zoom / 4:3 / Movie expand 14:9 / Movie expand 16:9 / Wide screen HDMI AV (16:9 Source) : Automatic / 4:3 / Wide screen / Unscaled (1080i/p only) PC Source : 4:3 / Wide screen / Unscaled (Refer to HDMI AV (16:9 Source) above if PC has HDMI Output.)
Photo Slide show	JPEG files only
MP3 playback	MP3 files only
Video playback	MPEG1(.mpg/.mpeg), MPEG2(.mpg/.mpeg/.vob), H.264(.mp4), MPEG4 SP/ASP(.avi), MPEG4(.mp4), WVC1(.wmv)
Connections	
Component Video Input (Y/Pb/Pr)	1 supporting video signals : 480i/p, 720p, 1080i/p 60Hz
Component Audio L/R Input	1
Composite Video / Audio Input	1
HDMI Input	4 supporting video signals : 480i/p, 720p, 1080i/p, 24Hz-60Hz HDMI-ARC (HDMI 1 only) PC-Input signal up to FHD (1920 × 1080)
PC Input	via VGA, HDMI and HDMI-DVI + PC Audio
USB	2
Wireless LAN	Supporting wireless standards : IEEE 802.11 b/g/n (2.4GHz)
Ethernet port	1
Digital Audio Output	2 supporting Dolby Digital
Headphone Output	1 1/8 inches (3.5mm)
Power	
Power requirements	120V~240V AC +/- 10%, 50/60Hz +/- 0.5%
Temperature	
Operating temperature	41 °F (5 °C) to 104 °F (40 °C)

- Specifications are subject to change without prior notice.

10 Warranty

LIMITED WARRANTY ONE (1) YEAR

WARRANTY COVERAGE:

This warranty obligation is limited to the terms as set forth below.

WHO IS COVERED:

This product warranty is issued to the original purchaser or the person receiving the product as a gift against defects in materials and workmanship as based on the date of original purchase ("Warranty Period") from an Authorized Dealer. The original sales receipt showing the product name and the purchase date from an authorized retailer is considered such proof.

WHAT IS COVERED:

This warranty covers new products if a defect in material or workmanship occurs and a valid claim is received within the Warranty Period. At its option, the company will either (1) repair the product at no charge, using new or refurbished replacement parts, or (2) exchange the product with a product that is new or which has been manufactured from new, or serviceable used parts and is at least functionally equivalent or most comparable to the original product in current inventory, or (3) refund the original purchase price of the product.

Replacement products or parts provided under this warranty are covered against defects in materials and workmanship from the date of the replacement or repair for ninety (90) days or for the remaining portion of the original product's warranty, whichever provides longer coverage for you. When a product or part is exchanged, any replacement item becomes your property and the replaced item becomes company property. When a refund is given, your product becomes company property.

Note: Any product sold and identified as refurbished or renewed carries a ninety (90) day limited warranty.

Replacement product can only be sent if all warranty requirements are met. Failure to follow all requirements can result in delay.

WHAT IS NOT COVERED - EXCLUSIONS AND LIMITATIONS:

This Limited Warranty applies only to new company manufactured products that can be identified by the trademark, trade name, or logo affixed to it. This Limited Warranty does not apply to any hardware product or any software, even if packaged or sold with the product, as manufacturers, suppliers, or publishers may provide a separate warranty for their own products packaged with the bundled product.

The company is not liable for any damage to or loss of any programs, data, or other information stored on any media contained within the product, or other additional product or part not covered by this warranty. Recovery or reinstallation of programs, data or other information is not covered under this Limited Warranty.

This warranty does not apply (a) to damage caused by accident, abuse, misuse, neglect, misapplication, or non-supplied product, (b) to damage caused by service performed by anyone other than company approved Authorized Service Location, (c) to a product

or a part that has been modified without written company permission, or (d) if any serial number has been removed or defaced, or (e) product, accessories or consumables sold "AS IS" without warranty of any kind by including refurbished product sold "AS IS" by some retailers.

This Limited Warranty does not cover:

- Shipping charges to return defective product.
- Labor charges for installation or setup of the product, adjustment of customer controls on the product, and installation or repair of antenna/signal source systems outside of the product.
- Product repair and/or part replacement because of improper installation or maintenance, connections to improper voltage supply, power line surge, lightning damage, retained images or screen markings resulting from viewing fixed stationary content for extended periods, product cosmetic appearance items due to normal wear and tear, unauthorized repair or other cause not within the control of the company.
- Damage or claims for products not being available for use, or for lost data or lost software.
- Damage from mishandled shipments or transit accidents when returning product.
- A product that requires modification or adaptation to enable it to operate in any country other than the country for which it was designed, manufactured, approved and/or authorized, or repair of products damaged by these modifications.
- A product used for commercial or institutional purposes (including but not limited to rental purposes).
- Product lost in shipment and no signature verification receipt can be provided.
- Failure to operate per Owner's Manual.

TO OBTAIN ASSISTANCE...

Contact the Customer Care Center at:
1 866 309 0843

REPAIR OR REPLACEMENT AS PROVIDED UNDER THIS WARRANTY IS THE EXCLUSIVE REMEDY FOR THE CONSUMER, WITH THE ISSUING COMPANY NOT LIABLE FOR ANY INCIDENTAL OR CONSEQUENTIAL DAMAGES FOR BREACH OF ANY EXPRESS OR IMPLIED WARRANTY ON THIS PRODUCT. EXCEPT TO THE EXTENT PROHIBITED BY APPLICABLE LAW, ANY IMPLIED WARRANTY OF MERCHANTABILITY OR FITNESS FOR A PARTICULAR PURPOSE ON THIS PRODUCT IS LIMITED IN DURATION TO THE DURATION OF THIS WARRANTY.

Some states do not allow the exclusions or limitation of incidental or consequential damages, or allow limitations on how long an implied warranty lasts, so the above limitations or exclusions may not apply to you.

This warranty gives you specific legal rights. You may have other rights which vary from state/province to state/province.

License

This product uses some open source software:

GPL software: linux, gcc, sysfsutils, Realtek WiFi driver, binutils, busybox, dhcpd

LGPL software: directfb, glibc, Qt

MIT: Expat, c-ares, libxml2, lua, lua-xmlreader, lua-slncrypto, giflib

MIT/X: cURL

gSOAP Public License: gSOAP

BSD: WPA Supplicant

zlib/libpng License: zlib, libpng

XML-RPC FOR C/C++ license: xmlrpc

Free Type, LibJPEG, OpenSSL, MINIX 3, unicode, ADPCM, OpenGL

GPL

GNU GENERAL PUBLIC LICENSE

Version 2, June 1991

Copyright (C) 1989, 1991 Free Software Foundation, Inc.

51 Franklin Street, Fifth Floor, Boston, MA 02110-1301, USA

Everyone is permitted to copy and distribute verbatim copies of this license document, but changing it is not allowed.

Preamble

The licenses for most software are designed to take away your freedom to share and change it. By contrast, the GNU General Public License is intended to guarantee your freedom to share and change free software to make sure the software is free for all its users. This General Public License applies to most of the Free Software Foundation's software and to any other program whose authors commit to using it. (Some other Free Software Foundation software is covered by the GNU Lesser General Public License instead.) You can apply it to your programs, too.

When we speak of free software, we are referring to freedom, not price. Our General Public Licenses are designed to make sure that you have the freedom to distribute copies of free software (and charge for this service if you wish), that you receive source code or can get it if you want it, that you can change the software or use pieces of it in new free programs; and that you know you can do these things.

To protect your rights, we need to make restrictions that forbid anyone to deny you these rights or to ask you to surrender the rights. These restrictions translate to certain responsibilities for you if you distribute copies of the software, or if you modify it. For example, if you distribute copies of such a program, whether gratis or for a fee, you must give the recipients all the rights that you have. You must make sure that they, too, receive or can get the source code. And you must show them these terms so they know their rights.

We protect your rights with two steps: (1) copyright the software, and (2) offer you this license which gives you legal permission to copy, distribute and/or modify the software.

Also, for each author's protection and ours, we want to make certain that everyone understands that there is no warranty for this free software. If the software is modified by someone else and passed on, we want its recipients to know that what they have is not the original, so that any problems introduced by others will not reflect on the original authors' reputations.

Finally, any free program is threatened constantly by software patents. We wish to avoid the danger that redistributors of a free program will individually obtain patent licenses, in effect making the program proprietary. To prevent this, we have made it clear that any patent must be licensed for everyone's free use or not licensed at all.

The precise terms and conditions for copying, distribution and modification follow.

TERMS AND CONDITIONS FOR COPYING, DISTRIBUTION AND MODIFICATION

0. This License applies to any program or other work which contains a notice placed by the copyright holder saying it may be distributed under the terms of this General Public License. The "Program", below, refers to any such program or work, and a "work based on the Program" means either the Program or any derivative work under copyright law: that is to say, a work containing the Program or a portion of it, either verbatim or with modifications and/or translated into another language. (Hereinafter, translation is included without limitation in the term "modification".) Each licensee is addressed as "you". Activities other than copying, distribution and modification are not covered by this License; they are outside its scope. The act of running the Program is not restricted, and the output from the Program is covered only if its contents constitute a work based on the Program (independent of having been made by running the Program). Whether that is true depends on what the Program does.
1. You may copy and distribute verbatim copies of the Program's source code as you receive it, in any medium, provided that you conspicuously and appropriately publish on each copy an appropriate copyright notice and disclaimer of warranty; keep intact all the notices that refer to this License and to the absence of any warranty; and give any other recipients of the Program a copy of this License along with the Program. You may charge a fee for the physical act of transferring a copy, and you may at your option offer warranty protection in exchange for a fee.
2. You may modify your copy or copies of the Program or any portion of it, thus forming a work based on the Program, and copy and distribute such modifications or work under the terms of Section 1 above, provided that you also meet all of these conditions:
 - a) You must cause the modified files to carry prominent notices stating that you changed the files and the date of any change.
 - b) You must cause any work that you distribute or publish, that in whole or in part contains or is derived from the Program or any part thereof, to be licensed as a whole at no charge to all third parties under the terms of this License.
 - c) If the modified program normally reads commands interactively when run, you must cause it, when started running for such interactive use in the most ordinary way, to print or display an announcement including an appropriate copyright notice and a notice that there is no warranty (or else, saying that you provide a warranty) and that users may redistribute the program under these conditions, and telling the user how to view a copy of this License. (Exception: if the Program itself is interactive but does not normally print such an announcement, your work based on the Program is not required to print an announcement.)

These requirements apply to the modified work as a whole. If identifiable sections of that work are not derived from the Program, and can be reasonably considered independent and separate works in themselves, then this License, and its terms, do not apply to those sections when you distribute them as separate works. But when you distribute the same sections as part of a whole which is a work based on the Program, the distribution of the whole must be on the terms of this License, whose permissions for other licensees extend to the entire whole, and thus to each and every part regardless of who wrote it.

Thus, it is not the intent of this section to claim rights or contest your rights to work written entirely by you; rather, the intent is to exercise the right to control the distribution of derivative or collective works based on the Program.

In addition, mere aggregation of another work not based on the Program with the Program (or with a work based on the Program) on a volume of a storage or distribution medium does not bring the other work under the scope of this License.

3. You may copy and distribute the Program (or a work based on it, under Section 2) in object code or executable form under the terms of Sections 1 and 2 above provided that you also do one of the following:

- a) Accompany it with the complete corresponding machine-readable source code, which must be distributed under the terms of Sections 1 and 2 above on a medium customarily used for software interchange; or,
- b) Accompany it with a written offer, valid for at least three years, to give any third party, for a charge no more than your cost of physically performing source distribution, a complete machine-readable copy of the corresponding source code, to be distributed under the terms of Sections 1 and 2 above on a medium customarily used for software interchange; or,
- c) Accompany it with the information you received as to the offer to distribute corresponding source code. (This alternative is allowed only for noncommercial distribution and only if you received the program in object code or executable form with such an offer, in accord with Subsection b above.)

The source code for a work means the preferred form of the work for making modifications to it. For an executable work, complete source code means all the source code for all modules it contains, plus any associated interface definition files, plus the scripts used to control compilation and installation of the executable. However, as a special exception, the source code distributed need not include anything that is normally distributed (in either source or binary form) with the major components (compiler, kernel, and so on) of the operating system on which the executable runs, unless that component itself accompanies the executable.

If distribution of executable or object code is made by offering access to copy from a designated place, then offering equivalent access to copy the source code from the same place counts as distribution of the source code, even though third parties are not compelled to copy the source along with the object code.

4. You may not copy, modify, sublicense, or distribute the Program except as expressly provided under this License. Any attempt otherwise to copy, modify, sublicense or distribute the Program is void, and will automatically terminate your rights under this License. However, parties who have received copies, or rights, from you under this License will not have their licenses terminated so long as such parties remain in full compliance.
5. You are not required to accept this License, since you have not signed it. However, nothing else grants you permission to modify or distribute the Program or its derivative works. These actions are prohibited by law if you do not accept this License. Therefore, by modifying or distributing the Program (or any work based on the Program), you indicate your acceptance of this License to do so, and all its terms and conditions for copying, distributing or modifying the Program or works based on it.
6. Each time you redistribute the Program (or any work based on the Program), the recipient automatically receives a license from the original licensor to copy, distribute or modify the Program subject to these terms and conditions. You may not impose any further restrictions on the recipients' exercise of the rights granted herein. You are not responsible for enforcing compliance by third parties to this License.
7. If, as a consequence of a court judgment or allegation of patent infringement or for any other reason (not limited to patent issues), conditions are imposed on you (whether by court order, agreement or otherwise) that contradict the conditions of this License, they do not excuse you from the conditions of this License. If you cannot distribute so as to satisfy simultaneously your obligations under this License and any other pertinent obligations, then as a consequence you may not distribute the Program at all. For example, if a patent license would not permit royalty-free redistribution of the Program by all those who receive copies directly or indirectly through you, then the only way you

could satisfy both it and this License would be to refrain entirely from distribution of the Program.

If any portion of this section is held invalid or unenforceable under any particular circumstance, the balance of the section is intended to apply and the section as a whole is intended to apply in other circumstances.

It is not the purpose of this section to induce you to infringe any patents or other property right claims or to contest validity of any such claims; this section has the sole purpose of protecting the integrity of the free software distribution system, which is implemented by public license practices. Many people have made generous contributions to the wide range of software distributed through that system in reliance on consistent application of that system; it is up to the author/donor to decide if he or she is willing to distribute software through any other system and a licensee cannot impose that choice.

This section is intended to make thoroughly clear what is believed to be a consequence of the rest of this License.

8. If the distribution and/or use of the Program is restricted in certain countries either by patents or by copyrighted interfaces, the original copyright holder who places the Program under this License may add an explicit geographical distribution limitation excluding those countries, so that distribution is permitted only in or among countries not thus excluded. In such case, this License incorporates the limitation as if written in the body of this License.
9. The Free Software Foundation may publish revised and/or new versions of the General Public License from time to time. Such new versions will be similar in spirit to the present version, but may differ in detail to address new problems or concerns. Each version is given a distinguishing version number: If the Program specifies a version number of this License which applies to it and "any later version", you have the option of following the terms and conditions either of that version or of any later version published by the Free Software Foundation. If the Program does not specify a version number of this License, you may choose any version ever published by the Free Software Foundation.
10. If you wish to incorporate parts of the Program into other free programs whose distribution conditions are different, write to the author to ask for permission. For software which is copyrighted by the Free Software Foundation, write to the Free Software Foundation; we sometimes make exceptions for this. Our decision will be guided by the two goals of preserving the free status of all derivatives of our free software and of promoting the sharing and reuse of software generally.

NO WARRANTY

11. BECAUSE THE PROGRAM IS LICENSED FREE OF CHARGE, THERE IS NO WARRANTY FOR THE PROGRAM, TO THE EXTENT PERMITTED BY APPLICABLE LAW. EXCEPT WHEN OTHERWISE STATED IN WRITING THE COPYRIGHT HOLDERS AND/OR OTHER PARTIES PROVIDE THE PROGRAM "AS IS" WITHOUT WARRANTY OF ANY KIND, EITHER EXPRESSED OR IMPLIED, INCLUDING, BUT NOT LIMITED TO, THE IMPLIED WARRANTIES OF MERCHANTABILITY AND FITNESS FOR A PARTICULAR PURPOSE. THE ENTIRE RISK AS TO THE QUALITY AND PERFORMANCE OF THE PROGRAM IS WITH YOU. SHOULD THE PROGRAM PROVE DEFECTIVE, YOU ASSUME THE COST OF ALL NECESSARY SERVICING, REPAIR OR CORRECTION.
12. IN NO EVENT UNLESS REQUIRED BY APPLICABLE LAW OR AGREED TO IN WRITING WILL ANY COPYRIGHT HOLDER, OR ANY OTHER PARTY WHO MAY MODIFY AND/OR REDISTRIBUTE THE PROGRAM AS PERMITTED ABOVE, BE LIABLE TO YOU FOR DAMAGES, INCLUDING ANY GENERAL, SPECIAL, INCIDENTAL OR CONSEQUENTIAL DAMAGES ARISING OUT OF THE USE OR INABILITY TO USE THE PROGRAM (INCLUDING BUT NOT LIMITED TO LOSS OF DATA OR DATA BEING RENDERED INACCURATE

OR LOSSES SUSTAINED BY YOU OR THIRD PARTIES OR A FAILURE OF THE PROGRAM TO OPERATE WITH ANY OTHER PROGRAMS), EVEN IF SUCH HOLDER OR OTHER PARTY HAS BEEN ADVISED OF THE POSSIBILITY OF SUCH DAMAGES.

END OF TERMS AND CONDITIONS

How to Apply These Terms to Your New Programs

If you develop a new program, and you want it to be of the greatest possible use to the public, the best way to achieve this is to make it free software which everyone can redistribute and change under these terms. To do so, attach the following notices to the program. It is safest to attach them to the start of each source file to most effectively convey the exclusion of warranty; and each file should have at least the "copyright" line and a pointer to where the full notice is found.

one line to give the program's name and an idea of what it does.

Copyright (C) yyyy name of author

This program is free software; you can redistribute it and/or modify it under the terms of the GNU General Public License as published by the Free Software Foundation; either version 2 of the License, or (at your option) any later version.

This program is distributed in the hope that it will be useful, but WITHOUT ANY WARRANTY; without even the implied warranty of MERCHANTABILITY or FITNESS FOR A PARTICULAR PURPOSE. See the GNU General Public License for more details.

You should have received a copy of the GNU General Public License along with this program; if not, write to the Free Software Foundation, Inc., 51 Franklin Street, Fifth Floor, Boston, MA 02110-1301, USA.

Also add information on how to contact you by electronic and paper mail.

If the program is interactive, make it output a short notice like this when it starts in an interactive mode:

Gnomovision version 69, Copyright (C) year name of author

Gnomovision comes with ABSOLUTELY NO WARRANTY; for details type 'show w'. This is free software, and you are welcome to redistribute it under certain conditions; type 'show c' for details.

The hypothetical commands 'show w' and 'show c' should show the appropriate parts of the General Public License. Of course, the commands you use may be called something other than 'show w' and 'show c'; they could even be mouse-clicks or menu items--whatever suits your program.

You should also get your employer (if you work as a programmer) or your school, if any, to sign a "copyright disclaimer" for the program, if necessary.

Here is a sample; alter the names:

Yoyodyne, Inc., hereby disclaims all copyright interest in the program 'Gnomovision' (which makes passes at compilers) written by James Hacker:

signature of Ty Coon, 1 April 1989

Ty Coon, President of Vice

This General Public License does not permit incorporating your program into proprietary programs. If your program is a subroutine library, you may consider it more useful to permit linking proprietary applications with the library. If this is what you want to do, use the GNU Lesser General Public License instead of this License.

If you are interested in obtaining GPL source code used in this product, please contact

Open Source Team, P&F USA, Inc., PO Box 2248, Alpharetta, GA 30023-2248.

LGPL

GNU LESSER GENERAL PUBLIC LICENSE

Version 2.1, February 1999

Copyright (C) 1991, 1999 Free Software Foundation, Inc.

51 Franklin Street, Fifth Floor, Boston, MA 02110-1301 USA

Everyone is permitted to copy and distribute verbatim copies of this license document, but changing it is not allowed.

[This is the first released version of the Lesser GPL. It also counts as the successor of the GNU Library Public License, version 2, hence the version number 2.1.]

Preamble

The licenses for most software are designed to take away your freedom to share and change it. By contrast, the GNU General Public Licenses are intended to guarantee your freedom to share and change free software to make sure the software is free for all its users.

This license, the Lesser General Public License, applies to some specially designated software packages--typically libraries--of the Free Software Foundation and other authors who decide to use it. You can use it too, but we suggest you first think carefully about whether this license or the ordinary General Public License is the better strategy to use in any particular case, based on the explanations below.

When we speak of free software, we are referring to freedom of use, not price. Our General Public Licenses are designed to make sure that you have the freedom to distribute copies of free software (and charge for this service if you wish); that you receive source code or can get it if you want it; that you can change the software and use pieces of it in new free programs; and that you are informed that you can do these things.

To protect your rights, we need to make restrictions that forbid distributors to deny you these rights or to ask you to surrender these rights. These restrictions translate to certain responsibilities for you if you distribute copies of the library or if you modify it.

For example, if you distribute copies of the library, whether gratis or for a fee, you must give the recipients all the rights that we gave you. You must make sure that they, too, receive or can get the source code. If you link other code with the library, you must provide complete object files to the recipients, so that they can relink them with the library after making changes to the library and recompiling it. And you must show them these terms so they know their rights.

We protect your rights with a two-step method: (1) we copyright the library, and (2) we offer you this license, which gives you legal permission to copy, distribute and/or modify the library.

To protect each distributor, we want to make it very clear that there is no warranty for the free library. Also, if the library is modified by someone else and passed on, the recipients should know that what they have is not the original version, so that the original author's reputation will not be affected by problems that might be introduced by others.

Finally, software patents pose a constant threat to the existence of any free program. We wish to make sure that a company cannot effectively restrict the users of a free program by obtaining a restrictive license from a patent holder. Therefore, we insist that any patent license obtained for a version of the library must be consistent with the full freedom of use specified in this license.

Most GNU software, including some libraries, is covered by the ordinary GNU General Public License. This license, the GNU Lesser General Public License, applies to certain designated libraries, and is quite different from the ordinary General Public License. We use this license for certain libraries in order to permit linking those libraries into non-free programs.

When a program is linked with a library, whether statically or using a shared library, the combination of the two is legally speaking a combined work, a derivative of the original library. The ordinary General Public License therefore permits such linking only if the entire combination fits

its criteria of freedom. The Lesser General Public License permits more lax criteria for linking other code with the library.

We call this license the “Lesser” General Public License because it does Less to protect the user’s freedom than the ordinary General Public License. It also provides other free software developers Less of an advantage over competing non-free programs. These disadvantages are the reason we use the ordinary General Public License for many libraries. However, the Lesser license provides advantages in certain special circumstances.

For example, on rare occasions, there may be a special need to encourage the widest possible use of a certain library, so that it becomes a de-facto standard. To achieve this, non-free programs must be allowed to use the library. A more frequent case is that a free library does the same job as widely used non-free libraries. In this case, there is little to gain by limiting the free library to free software only, so we use the Lesser General Public License.

In other cases, permission to use a particular library in non-free programs enables a greater number of people to use a large body of free software. For example, permission to use the GNU C Library in non-free programs enables many more people to use the whole GNU operating system, as well as its variant, the GNU/Linux operating system.

Although the Lesser General Public License is Less protective of the users’ freedom, it does ensure that the user of a program that is linked with the Library has the freedom and the wherewithal to run that program using a modified version of the Library.

The precise terms and conditions for copying, distribution and modification follow. Pay close attention to the difference between a “work based on the library” and a “work that uses the library”. The former contains code derived from the library, whereas the latter must be combined with the library in order to run.

GNU LESSER GENERAL PUBLIC LICENSE

TERMS AND CONDITIONS FOR COPYING, DISTRIBUTION AND MODIFICATION

0. This License Agreement applies to any software library or other program which contains a notice placed by the copyright holder or other authorized party saying it may be distributed under the terms of this Lesser General Public License (also called “this License”). Each licensee is addressed as “you”.

A “library” means a collection of software functions and/or data prepared so as to be conveniently linked with application programs (which use some of those functions and data) to form executables.

The “Library”, below, refers to any such software library or work which has been distributed under these terms. A “work based on the Library” means either the Library or any derivative work under copyright law: that is to say, a work containing the Library or a portion of it, either verbatim or with modifications and/or translated straightforwardly into another language. (Hereinafter, translation is included without limitation in the term “modification”.)

“Source code” for a work means the preferred form of the work for making modifications to it. For a library, complete source code means all the source code for all modules it contains, plus any associated interface definition files, plus the scripts used to control compilation and installation of the library.

Activities other than copying, distribution and modification are not covered by this License; they are outside its scope. The act of running a program using the Library is not restricted, and output from such a program is covered only if its contents constitute a work based on the Library (independent of the use of the Library in a tool for writing it). Whether that is true depends on what the Library does and what the program that uses the Library does.

1. You may copy and distribute verbatim copies of the Library’s complete source code as you receive it, in any medium, provided that you conspicuously and appropriately publish on each copy an appropriate copyright notice and disclaimer of warranty; keep intact all the notices that refer to this License and to the absence of any warranty; and distribute a copy of this License along with the Library.

You may charge a fee for the physical act of transferring a copy, and you may at your option offer warranty protection in exchange for a fee.

2. You may modify your copy or copies of the Library or any portion of it, thus forming a work based on the Library, and copy and distribute such modifications or work under the terms of Section 1 above, provided that you also meet all of these conditions:

- The modified work must itself be a software library.
- You must cause the files modified to carry prominent notices stating that you changed the files and the date of any change.
- You must cause the whole of the work to be licensed at no charge to all third parties under the terms of this License.
- If a facility in the modified Library refers to a function or a table of data to be supplied by an application program that uses the facility, other than as an argument passed when the facility is invoked, then you must make a good faith effort to ensure that, in the event an application does not supply such function or table, the facility still operates, and performs whatever part of its purpose remains meaningful. (For example, a function in a library to compute square roots has a purpose that is entirely well-defined independent of the application. Therefore, Subsection 2d requires that any application-supplied function or table used by this function must be optional: if the application does not supply it, the square root function must still compute square roots.)

These requirements apply to the modified work as a whole. If identifiable sections of that work are not derived from the Library, and can be reasonably considered independent and separate works in themselves, then this License, and its terms, do not apply to those sections when you distribute them as separate works. But when you distribute the same sections as part of a whole which is a work based on the Library, the distribution of the whole must be on the terms of this License, whose permissions for other licensees extend to the entire whole, and thus to each and every part regardless of who wrote it.

Thus, it is not the intent of this section to claim rights or contest your rights to work written entirely by you; rather, the intent is to exercise the right to control the distribution of derivative or collective works based on the Library.

In addition, mere aggregation of another work not based on the Library with the Library (or with a work based on the Library) on a volume of a storage or distribution medium does not bring the other work under the scope of this License.

3. You may opt to apply the terms of the ordinary GNU General Public License instead of this License to a given copy of the Library. To do this, you must alter all the notices that refer to this License, so that they refer to the ordinary GNU General Public License, version 2, instead of to this License. (If a newer version than version 2 of the ordinary GNU General Public License has appeared, then you can specify that version instead if you wish.) Do not make any other change in these notices.

Once this change is made in a given copy, it is irreversible for that copy, so the ordinary GNU General Public License applies to all subsequent copies and derivative works made from that copy.

This option is useful when you wish to copy part of the code of the Library into a program that is not a library.

4. You may copy and distribute the Library (or a portion or derivative of it, under Section 2) in object code or executable form under the terms of Sections 1 and 2 above provided that you accompany it with the complete corresponding machine-readable source code, which must be distributed under the terms of Sections 1 and 2 above on a medium customarily used for software interchange.

If distribution of object code is made by offering access to copy from a designated place, then offering equivalent access to copy the source code from the same place satisfies the requirement to distribute the source code, even though third parties are not compelled to copy the source along with the object code.

5. A program that contains no derivative of any portion of the Library, but is designed to work with the Library by being compiled or linked with it, is called a "work that uses the Library". Such a work, in isolation, is not a derivative work of the Library, and therefore falls outside the scope of this License.

However, linking a "work that uses the Library" with the Library creates an executable that is a derivative of the Library (because it contains portions of the Library), rather than a "work that uses the library". The executable is therefore covered by this License. Section 6 states terms for distribution of such executables.

When a "work that uses the Library" uses material from a header file that is part of the Library, the object code for the work may be a derivative work of the Library even though the source code is not. Whether this is true is especially significant if the work can be linked without the Library, or if the work is itself a library. The threshold for this to be true is not precisely defined by law.

If such an object file uses only numerical parameters, data structure layouts and accessors, and small macros and small inline functions (ten lines or less in length), then the use of the object file is unrestricted, regardless of whether it is legally a derivative work. (Executables containing this object code plus portions of the Library will still fall under Section 6.)

Otherwise, if the work is a derivative of the Library, you may distribute the object code for the work under the terms of Section 6. Any executables containing that work also fall under Section 6, whether or not they are linked directly with the Library itself.

6. As an exception to the Sections above, you may also combine or link a "work that uses the Library" with the Library to produce a work containing portions of the Library, and distribute that work under terms of your choice, provided that the terms permit modification of the work for the customer's own use and reverse engineering for debugging such modifications.

You must give prominent notice with each copy of the work that the Library is used in it and that the Library and its use are covered by this License. You must supply a copy of this License. If the work during execution displays copyright notices, you must include the copyright notice for the Library among them, as well as a reference directing the user to the copy of this License. Also, you must do one of these things:

- a) Accompany the work with the complete corresponding machine-readable source code for the Library including whatever changes were used in the work (which must be distributed under Sections 1 and 2 above); and, if the work is an executable linked with the Library, with the complete machine-readable "work that uses the Library", as object code and/or source code, so that the user can modify the Library and then relink to produce a modified executable containing the modified Library. (It is understood that the user who changes the contents of definitions files in the Library will not necessarily be able to recompile the application to use the modified definitions.)

- b) Use a suitable shared library mechanism for linking with the Library. A suitable mechanism is one that (1) uses at run time a copy of the library already present on the user's computer system, rather than copying library functions into the executable, and (2) will operate properly with a modified version of the library, if the user installs one, as long as the modified version is interface-compatible with the version that the work was made with.

- c) Accompany the work with a written offer, valid for at least three years, to give the same user the materials specified in Subsection 6a, above, for a charge no more than the cost of performing this distribution.

- d) If distribution of the work is made by offering access to copy from a designated place, offer equivalent access to copy the above specified materials from the same place.

- e) Verify that the user has already received a copy of these materials or that you have already sent this user a copy.

For an executable, the required form of the "work that uses the Library" must include any data and utility programs needed for reproducing the executable from it. However, as a special exception, the materials to be distributed need not include anything that is normally distributed (in either source or binary form) with the major components (compiler, kernel, and so on) of the operating system on which the executable runs, unless that component itself accompanies the executable.

It may happen that this requirement contradicts the license restrictions of other proprietary libraries that do not normally accompany the operating system. Such a contradiction means you cannot use both them and the Library together in an executable that you distribute.

7. You may place library facilities that are a work based on the Library side-by-side in a single library together with other library facilities not covered by this License, and distribute such a combined library, provided that the separate distribution of the work based on the Library and of the other library facilities is otherwise permitted, and provided that you do these two things:

- a) Accompany the combined library with a copy of the same work based on the Library, uncombined with any other library facilities. This must be distributed under the terms of the Sections above.

- b) Give prominent notice with the combined library of the fact that part of it is a work based on the Library, and explaining where to find the accompanying uncombined form of the same work.

8. You may not copy, modify, sublicense, link with, or distribute the Library except as expressly provided under this License. Any attempt otherwise to copy, modify, sublicense, link with, or distribute the Library is void, and will automatically terminate your rights under this License. However, parties who have received copies, or rights, from you under this License will not have their licenses terminated so long as such parties remain in full compliance.

9. You are not required to accept this License, since you have not signed it. However, nothing else grants you permission to modify or distribute the Library or its derivative works. These actions are prohibited by law if you do not accept this License. Therefore, by modifying or distributing the Library (or any work based on the Library), you indicate your acceptance of this License to do so, and all its terms and conditions for copying, distributing or modifying the Library or works based on it.

10. Each time you redistribute the Library (or any work based on the Library), the recipient automatically receives a license from the original licensor to copy, distribute, link with or modify the Library

subject to these terms and conditions. You may not impose any further restrictions on the recipients' exercise of the rights granted herein. You are not responsible for enforcing compliance by third parties with this License.

11. If, as a consequence of a court judgment or allegation of patent infringement or for any other reason (not limited to patent issues), conditions are imposed on you (whether by court order, agreement or otherwise) that contradict the conditions of this License, they do not excuse you from the conditions of this License. If you cannot distribute so as to satisfy simultaneously your obligations under this License and any other pertinent obligations, then as a consequence you may not distribute the Library at all. For example, if a patent license would not permit royalty-free redistribution of the Library by all those who receive copies directly or indirectly through you, then the only way you could satisfy both it and this License would be to refrain entirely from distribution of the Library.

If any portion of this section is held invalid or unenforceable under any particular circumstance, the balance of the section is intended to apply, and the section as a whole is intended to apply in other circumstances.

It is not the purpose of this section to induce you to infringe any patents or other property right claims or to contest validity of any such claims; this section has the sole purpose of protecting the integrity of the free software distribution system which is implemented by public license practices. Many people have made generous contributions to the wide range of software distributed through that system in reliance on consistent application of that system; it is up to the author/donor to decide if he or she is willing to distribute software through any other system and a licensee cannot impose that choice.

This section is intended to make thoroughly clear what is believed to be a consequence of the rest of this License.

12. If the distribution and/or use of the Library is restricted in certain countries either by patents or by copyrighted interfaces, the original copyright holder who places the Library under this License may add an explicit geographical distribution limitation excluding those countries, so that distribution is permitted only in or among countries not thus excluded. In such case, this License incorporates the limitation as if written in the body of this License.
13. The Free Software Foundation may publish revised and/or new versions of the Lesser General Public License from time to time. Such new versions will be similar in spirit to the present version, but may differ in detail to address new problems or concerns.

Each version is given a distinguishing version number. If the Library specifies a version number of this License which applies to it and "any later version", you have the option of following the terms and conditions either of that version or of any later version published by the Free Software Foundation. If the Library does not specify a license version number; you may choose any version ever published by the Free Software Foundation.

14. If you wish to incorporate parts of the Library into other free programs whose distribution conditions are incompatible with these, write to the author to ask for permission. For software which is copyrighted by the Free Software Foundation, write to the Free Software Foundation; we sometimes make exceptions for this. Our decision will be guided by the two goals of preserving the free status of all derivatives of our free software and of promoting the sharing and reuse of software generally.

NO WARRANTY

15. BECAUSE THE LIBRARY IS LICENSED FREE OF CHARGE, THERE IS NO WARRANTY FOR THE LIBRARY, TO THE EXTENT PERMITTED BY APPLICABLE LAW. EXCEPT WHEN OTHERWISE STATED IN WRITING THE COPYRIGHT HOLDERS AND/OR OTHER PARTIES PROVIDE THE LIBRARY

"AS IS" WITHOUT WARRANTY OF ANY KIND, EITHER EXPRESSED OR IMPLIED, INCLUDING, BUT NOT LIMITED TO, THE IMPLIED WARRANTIES OF MERCHANTABILITY AND FITNESS FOR A PARTICULAR PURPOSE. THE ENTIRE RISK AS TO THE QUALITY AND PERFORMANCE OF THE LIBRARY IS WITH YOU. SHOULD THE LIBRARY PROVE DEFECTIVE, YOU ASSUME THE COST OF ALL NECESSARY SERVICING, REPAIR OR CORRECTION.

16. IN NO EVENT UNLESS REQUIRED BY APPLICABLE LAW OR AGREED TO IN WRITING WILL ANY COPYRIGHT HOLDER, OR ANY OTHER PARTY WHO MAY MODIFY AND/OR REDISTRIBUTE THE LIBRARY AS PERMITTED ABOVE, BE LIABLE TO YOU FOR DAMAGES, INCLUDING ANY GENERAL, SPECIAL, INCIDENTAL OR CONSEQUENTIAL DAMAGES ARISING OUT OF THE USE OR INABILITY TO USE THE LIBRARY (INCLUDING BUT NOT LIMITED TO LOSS OF DATA OR DATA BEING RENDERED INACCURATE OR LOSSES SUSTAINED BY YOU OR THIRD PARTIES OR A FAILURE OF THE LIBRARY TO OPERATE WITH ANY OTHER SOFTWARE), EVEN IF SUCH HOLDER OR OTHER PARTY AS BEEN ADVISED OF THE POSSIBILITY OF SUCH DAMAGES.

END OF TERMS AND CONDITIONS

How to Apply These Terms to Your New Libraries

If you develop a new library, and you want it to be of the greatest possible use to the public, we recommend making it free software that everyone can redistribute and change. You can do so by permitting redistribution under these terms (or, alternatively, under the terms of the ordinary General Public License).

To apply these terms, attach the following notices to the library. It is safest to attach them to the start of each source file to most effectively convey the exclusion of warranty; and each file should have at least the "copyright" line and a pointer to where the full notice is found.

<one line to give the library's name and a brief idea of what it does.>

Copyright (C) <year> <name of author>

This library is free software; you can redistribute it and/or modify it under the terms of the GNU Lesser General Public License as published by the Free Software Foundation; either version 2.1 of the License, or (at your option) any later version. This library is distributed in the hope that it will be useful, but WITHOUT ANY WARRANTY; without even the implied warranty of MERCHANTABILITY or FITNESS FOR A PARTICULAR PURPOSE. See the GNU Lesser General Public License for more details.

You should have received a copy of the GNU Lesser General Public License along with this library; if not, write to the Free Software Foundation, Inc., 51 Franklin Street, Fifth Floor, Boston, MA 02110-1301 USA

Also add information on how to contact you by electronic and paper mail.

You should also get your employer (if you work as a programmer) or your school, if any, to sign a "copyright disclaimer" for the library, if necessary. Here is a sample; alter the names:

Yoyodyne, Inc., hereby disclaims all copyright interest in the library 'Frob' (a library for tweaking knobs) written by James Random Hacker:

<signature of Ty Coon>, 1 April 1990

Ty Coon, President of Vice

That's all there is to it!

If you are interested in obtaining GPL source code used in this product, please contact Open Source Team, P&F USA, Inc., PO Box 2248, Alpharetta, GA 30023-2248.

MIT

Expat

Copyright (c) 1998, 1999, 2000 Thai Open Source Software Center Ltd and Clark Cooper

Copyright (c) 2001, 2002, 2003, 2004, 2005, 2006 Expat maintainers.

c-ares

Copyright 1998, 2009 by the Massachusetts Institute of Technology.

Copyright (C) 2007-2009 by Daniel Stenberg

Permission to use, copy, modify, and distribute this software and its documentation for any purpose and without fee is hereby granted, provided that the above copyright notice appear in all copies and that both that copyright notice and this permission notice appear in supporting documentation, and that the name of M.I.T. not be used in advertising or publicity pertaining to distribution of the software without specific, written prior permission. M.I.T. makes no representations about the suitability of this software for any purpose. It is provided "as is" without express or implied warranty.

libxml2

Copyright (C) 1998-2003 Daniel Veillard. All Rights Reserved.

lua

Copyright (c) 1994-2010 Lua.org, PUC-Rio

lua-xmlreader

Copyright (c) 2008 A.S. Bradbury

lua-slncrypto

Copyright (c) 2005 Malet Partner, Berlin, partner@malete.org

giflib

The GIFLIB distribution is Copyright (c) 1997 Eric S. Raymond

Permission is hereby granted, free of charge, to any person obtaining a copy of this software and associated documentation files (the "Software"), to deal in the Software without restriction, including without limitation the rights to use, copy, modify, merge, publish, distribute, sublicense, and/or sell copies of the Software, and to permit persons to whom the Software is furnished to do so, subject to the following conditions:

The above copyright notice and this permission notice shall be included in all copies or substantial portions of the Software.

THE SOFTWARE IS PROVIDED "AS IS", WITHOUT WARRANTY OF ANY KIND, EXPRESS OR IMPLIED, INCLUDING BUT NOT LIMITED TO THE WARRANTIES OF MERCHANTABILITY, FITNESS FOR A PARTICULAR PURPOSE AND NONINFRINGEMENT. IN NO EVENT SHALL THE AUTHORS OR COPYRIGHT HOLDERS BE LIABLE FOR ANY CLAIM, DAMAGES OR OTHER LIABILITY, WHETHER IN AN ACTION OF CONTRACT, TORT OR OTHERWISE, ARISING FROM, OUT OF OR IN CONNECTION WITH THE SOFTWARE OR THE USE OR OTHER DEALINGS IN THE SOFTWARE.

Permission is hereby granted, free of charge, to any person obtaining a copy of this software and associated documentation files (the Software), to deal in the Software without restriction, including without limitation

the rights to use, copy, modify, merge, publish, distribute, sublicense, and/or sell copies of the Software, and to permit persons to whom the Software is furnished to do so, subject to the following conditions:

The above copyright notice and this permission notice shall be included in all copies or substantial portions of the Software.

THE SOFTWARE IS PROVIDED "AS IS", WITHOUT WARRANTY OF ANY KIND, EXPRESS OR IMPLIED, INCLUDING BUT NOT LIMITED TO THE WARRANTIES OF MERCHANTABILITY, FITNESS FOR A PARTICULAR PURPOSE AND NONINFRINGEMENT. IN NO EVENT SHALL THE AUTHORS OR COPYRIGHT HOLDERS BE LIABLE FOR ANY CLAIM, DAMAGES OR OTHER LIABILITY, WHETHER IN AN ACTION OF CONTRACT, TORT OR OTHERWISE, ARISING FROM, OUT OF OR IN CONNECTION WITH THE SOFTWARE OR THE USE OR OTHER DEALINGS IN THE SOFTWARE.

MIT/X

cURL

COPYRIGHT AND PERMISSION NOTICE

Copyright (c) 1996 - 2012, Daniel Stenberg, <daniel@haxx.se>.

All rights reserved.

Permission to use, copy, modify, and distribute this software for any purpose with or without fee is hereby granted, provided that the above copyright notice and this permission notice appear in all copies.

THE SOFTWARE IS PROVIDED "AS IS", WITHOUT WARRANTY OF ANY KIND, EXPRESS OR IMPLIED, INCLUDING BUT NOT LIMITED TO THE WARRANTIES OF MERCHANTABILITY, FITNESS FOR A PARTICULAR PURPOSE AND NONINFRINGEMENT OF THIRD PARTY RIGHTS. IN NO EVENT SHALL THE AUTHORS OR COPYRIGHT HOLDERS BE LIABLE FOR ANY CLAIM, DAMAGES OR OTHER LIABILITY, WHETHER IN AN ACTION OF CONTRACT, TORT OR OTHERWISE, ARISING FROM, OUT OF OR IN CONNECTION WITH THE SOFTWARE OR THE USE OR OTHER DEALINGS IN THE SOFTWARE.

Except as contained in this notice, the name of a copyright holder shall not be used in advertising or otherwise to promote the sale, use or other dealings in this Software without prior written authorization of the copyright holder.

gSOAP

Part of the software embedded in this product is gSOAP software.

Portions created by gSOAP are Copyright (C) 2001-2009 Robert A. van Engelen, Genivia inc. All Rights Reserved.

THE SOFTWARE IN THIS PRODUCT WAS IN PART PROVIDED BY GENIVIA INC AND ANY EXPRESS OR IMPLIED WARRANTIES, INCLUDING, BUT NOT LIMITED TO, THE IMPLIED WARRANTIES OF MERCHANTABILITY AND FITNESS FOR A PARTICULAR PURPOSE ARE DISCLAIMED. IN NO EVENT SHALL THE AUTHOR BE LIABLE FOR ANY DIRECT, INDIRECT, INCIDENTAL, SPECIAL, EXEMPLARY, OR CONSEQUENTIAL DAMAGES (INCLUDING, BUT NOT LIMITED TO, PROCUREMENT OF SUBSTITUTE GOODS OR SERVICES; LOSS OF USE, DATA, OR PROFITS; OR BUSINESS INTERRUPTION) HOWEVER CAUSED AND ON ANY THEORY OF LIABILITY, WHETHER IN CONTRACT, STRICT LIABILITY, OR TORT (INCLUDING NEGLIGENCE OR OTHERWISE) ARISING IN ANY WAY OUT OF THE USE OF THIS SOFTWARE, EVEN IF ADVISED OF THE POSSIBILITY OF SUCH DAMAGE.

BSD

Copyright (c) 2003-2010, Jouni Malinen <j@w1.fi> and contributors
All Rights Reserved.

Redistribution and use in source and binary forms, with or without modification, are permitted provided that the following conditions are met:

1. Redistributions of source code must retain the above copyright notice, this list of conditions and the following disclaimer.
2. Redistributions in binary form must reproduce the above copyright notice, this list of conditions and the following disclaimer in the documentation and/or other materials provided with the distribution.
3. Neither the name(s) of the above-listed copyright holder(s) nor the names of its contributors may be used to endorse or promote products derived from this software without specific prior written permission.

THIS SOFTWARE IS PROVIDED BY THE COPYRIGHT HOLDERS AND CONTRIBUTORS "AS IS" AND ANY EXPRESS OR IMPLIED WARRANTIES, INCLUDING, BUT NOT LIMITED TO, THE IMPLIED WARRANTIES OF MERCHANTABILITY AND FITNESS FOR A PARTICULAR PURPOSE ARE DISCLAIMED. IN NO EVENT SHALL THE COPYRIGHT OWNER OR CONTRIBUTORS BE LIABLE FOR ANY DIRECT, INDIRECT, INCIDENTAL, SPECIAL, EXEMPLARY, OR CONSEQUENTIAL DAMAGES (INCLUDING, BUT NOT LIMITED TO, PROCUREMENT OF SUBSTITUTE GOODS OR SERVICES; LOSS OF USE, DATA, OR PROFITS; OR BUSINESS INTERRUPTION) HOWEVER CAUSED AND ON ANY THEORY OF LIABILITY, WHETHER IN CONTRACT, STRICT LIABILITY, OR TORT (INCLUDING NEGLIGENCE OR OTHERWISE) ARISING IN ANY WAY OUT OF THE USE OF THIS SOFTWARE, EVEN IF ADVISED OF THE POSSIBILITY OF SUCH DAMAGE.

zlib/libpng License

zlib.h -- interface of the 'zlib' general purpose compression library version 1.2.3, July 18th, 2005

Copyright (C) 1995-2005 Jean-loup Gailly and Mark Adler

This software is provided 'as-is', without any express or implied warranty. In no event will the authors be held liable for any damages arising from the use of this software.

Permission is granted to anyone to use this software for any purpose, including commercial applications, and to alter it and redistribute it freely, subject to the following restrictions:

1. The origin of this software must not be misrepresented; you must not claim that you wrote the original software. If you use this software in a product, an acknowledgment in the product documentation would be appreciated but is not required.
2. Altered source versions must be plainly marked as such, and must not be misrepresented as being the original software.
3. This notice may not be removed or altered from any source distribution.

Jean-loup Gailly
jloup@zip.org

Mark Adler
madler@alumni.caltech.edu

The data format used by the zlib library is described by RFCs (Request for Comments) 1950 to 1952 in the files <http://www.ietf.org/rfc/rfc1950.txt> (zlib format), [rfc1951.txt](http://www.ietf.org/rfc/rfc1951.txt) (deflate format) and [rfc1952.txt](http://www.ietf.org/rfc/rfc1952.txt) (gzip format).

xmlrpc

XML-RPC For C/C++ License

Copyright (C) 2001 by First Peer, Inc. All rights reserved.

Copyright (C) 2001 by Eric Kidd. All rights reserved.

Redistribution and use in source and binary forms, with or without modification, are permitted provided that the following conditions are met:

1. Redistributions of source code must retain the above copyright notice, this list of conditions and the following disclaimer.
2. Redistributions in binary form must reproduce the above copyright notice, this list of conditions and the following disclaimer in the documentation and/or other materials provided with the distribution.
3. The name of the author may not be used to endorse or promote products derived from this software without specific prior written permission.

THIS SOFTWARE IS PROVIDED BY THE AUTHOR AND CONTRIBUTORS "AS IS" AND ANY EXPRESS OR IMPLIED WARRANTIES, INCLUDING, BUT NOT LIMITED TO, THE IMPLIED WARRANTIES OF MERCHANTABILITY AND FITNESS FOR A PARTICULAR PURPOSE ARE DISCLAIMED. IN NO EVENT SHALL THE AUTHOR OR CONTRIBUTORS BE LIABLE FOR ANY DIRECT, INDIRECT, INCIDENTAL, SPECIAL, EXEMPLARY, OR CONSEQUENTIAL DAMAGES (INCLUDING, BUT NOT LIMITED TO, PROCUREMENT OF SUBSTITUTE GOODS OR SERVICES; LOSS OF USE, DATA, OR PROFITS; OR BUSINESS INTERRUPTION) HOWEVER CAUSED AND ON ANY THEORY OF LIABILITY, WHETHER IN CONTRACT, STRICT LIABILITY, OR TORT (INCLUDING NEGLIGENCE OR OTHERWISE) ARISING IN ANY WAY OUT OF THE USE OF THIS SOFTWARE, EVEN IF ADVISED OF THE POSSIBILITY OF SUCH DAMAGE.

Free Type

Portions of this software are copyright (c) 2001, 2002, 2003, 2004, 2006
The FreeType Project (www.freetype.org). All rights reserved.

LibJPEG

This software is based in part on the work of the Independent JPEG Group.

OpenSSL

LICENSE ISSUES

The OpenSSL toolkit stays under a dual license, i.e. both the conditions of the OpenSSL License and the original SSLeay license apply to the toolkit. See below for the actual license texts. Actually both licenses are BSD-style Open Source licenses. In case of any license issues related to OpenSSL please contact openssl-core@openssl.org.

OpenSSL License

Copyright (c) 1998-2011 The OpenSSL Project. All rights reserved.

Redistribution and use in source and binary forms, with or without modification, are permitted provided that the following conditions are met:

1. Redistributions of source code must retain the above copyright notice, this list of conditions and the following disclaimer.
2. Redistributions in binary form must reproduce the above copyright notice, this list of conditions and the following disclaimer in the documentation and/or other materials provided with the distribution.
3. All advertising materials mentioning features or use of this software must display the following acknowledgment: "This product includes software developed by the OpenSSL Project for use in the OpenSSL Toolkit. (<http://www.openssl.org/>)"
4. The names "OpenSSL Toolkit" and "OpenSSL Project" must not be used to endorse or promote products derived from this software without prior written permission. For written permission, please contact openssl-core@openssl.org.

5. Products derived from this software may not be called "OpenSSL" nor may "OpenSSL" appear in their names without prior written permission of the OpenSSL Project.
6. Redistributions of any form whatsoever must retain the following acknowledgment: "This product includes software developed by the OpenSSL Project for use in the OpenSSL Toolkit (<http://www.openssl.org/>)"

THIS SOFTWARE IS PROVIDED BY THE OpenSSL PROJECT "AS IS" AND ANY EXPRESSED OR IMPLIED WARRANTIES, INCLUDING, BUT NOT LIMITED TO, THE IMPLIED WARRANTIES OF MERCHANTABILITY AND FITNESS FOR A PARTICULAR PURPOSE ARE DISCLAIMED. IN NO EVENT SHALL THE OpenSSL PROJECT OR ITS CONTRIBUTORS BE LIABLE FOR ANY DIRECT, INDIRECT, INCIDENTAL, SPECIAL, EXEMPLARY, OR CONSEQUENTIAL DAMAGES (INCLUDING, BUT NOT LIMITED TO, PROCUREMENT OF SUBSTITUTE GOODS OR SERVICES; LOSS OF USE, DATA, OR PROFITS; OR BUSINESS INTERRUPTION) HOWEVER CAUSED AND ON ANY THEORY OF LIABILITY, WHETHER IN CONTRACT, STRICT LIABILITY, OR TORT (INCLUDING NEGLIGENCE OR OTHERWISE) ARISING IN ANY WAY OUT OF THE USE OF THIS SOFTWARE, EVEN IF ADVISED OF THE POSSIBILITY OF SUCH DAMAGE.

This product includes cryptographic software written by Eric Young (eay@cryptsoft.com).

This product includes software written by Tim Hudson (tjh@cryptsoft.com).

Original SSLeay License

Copyright (C) 1995-1998 Eric Young (eay@cryptsoft.com)

All rights reserved.

This package is an SSL implementation written by Eric Young (eay@cryptsoft.com).

The implementation was written so as to conform with Netscapes SSL.

This library is free for commercial and non-commercial use as long as the following conditions are adhered to. The following conditions apply to all code found in this distribution, be it the RC4, RSA, lhash, DES, etc., code; not just the SSL code. The SSL documentation included with this distribution is covered by the same copyright terms except that the holder is Tim Hudson (tjh@cryptsoft.com).

Copyright remains Eric Young's, and as such any Copyright notices in the code are not to be removed. If this package is used in a product, Eric Young should be given attribution as the author of the parts of the library used. This can be in the form of a textual message at program startup or in documentation (online or textual) provided with the package.

Redistribution and use in source and binary forms, with or without modification, are permitted provided that the following conditions are met:

1. Redistributions of source code must retain the copyright notice, this list of conditions and the following disclaimer:
2. Redistributions in binary form must reproduce the above copyright notice, this list of conditions and the following disclaimer in the documentation and/or other materials provided with the distribution.
3. All advertising materials mentioning features or use of this software must display the following acknowledgement: "This product includes cryptographic software written by Eric Young (eay@cryptsoft.com)"
The word 'cryptographic' can be left out if the routines from the library being used are not cryptographic related :-).
4. If you include any Windows specific code (or a derivative thereof) from the apps directory (application code) you must include an acknowledgement: "This product includes software written by Tim Hudson (tjh@cryptsoft.com)"

THIS SOFTWARE IS PROVIDED BY ERIC YOUNG "AS IS" AND ANY EXPRESS OR IMPLIED WARRANTIES, INCLUDING, BUT NOT LIMITED TO, THE IMPLIED WARRANTIES OF MERCHANTABILITY AND FITNESS FOR A PARTICULAR PURPOSE ARE DISCLAIMED. IN NO EVENT SHALL THE AUTHOR OR CONTRIBUTORS BE LIABLE FOR ANY DIRECT, INDIRECT, INCIDENTAL, SPECIAL, EXEMPLARY, OR CONSEQUENTIAL DAMAGES (INCLUDING, BUT NOT LIMITED TO, PROCUREMENT OF SUBSTITUTE GOODS OR SERVICES; LOSS OF USE, DATA, OR PROFITS; OR BUSINESS INTERRUPTION) HOWEVER CAUSED AND ON ANY THEORY OF LIABILITY, WHETHER IN CONTRACT, STRICT LIABILITY, OR TORT (INCLUDING NEGLIGENCE OR OTHERWISE) ARISING IN ANY WAY OUT OF THE USE OF THIS SOFTWARE, EVEN IF ADVISED OF THE POSSIBILITY OF SUCH DAMAGE.

The licence and distribution terms for any publically available version or derivative of this code cannot be changed. i.e. this code cannot simply be copied and put under another distribution licence

[including the GNU Public Licence.]

MINIX 3

Copyright (c) 1987,1997, 2006, Vrije Universiteit, Amsterdam, The Netherlands All rights reserved.

Redistribution and use of the MINIX 3 operating system in source and binary forms, with or without modification, are permitted provided that the following conditions are met:

Redistributions of source code must retain the above copyright notice, this list of conditions and the following disclaimer:

Redistributions in binary form must reproduce the above copyright notice, this list of conditions and the following disclaimer in the documentation and/or other materials provided with the distribution.

Neither the name of the Vrije Universiteit nor the names of the software authors or contributors may be used to endorse or promote products derived from this software without specific prior written permission.

Any deviations from these conditions require written permission from the copyright holder in advance

unicode

Unicode Copyright.

1. Copyright c 1991-2011 Unicode, Inc. All rights reserved.
2. Certain documents and files on this website contain a legend indicating that "Modification is permitted." Any person is hereby authorized, without fee, to modify such documents and files to create derivative works conforming to the UnicodeR Standard, subject to Terms and Conditions herein.
3. Any person is hereby authorized, without fee, to view, use, reproduce, and distribute all documents and files solely for informational purposes in the creation of products supporting the Unicode Standard, subject to the Terms and Conditions herein.
4. Further specifications of rights and restrictions pertaining to the use of the particular set of data files known as the Unicode Character Database can be found in Exhibit 1.
5. Each version of the Unicode Standard has further specifications of rights and restrictions of use. For the book editions (Unicode 5.0 and earlier), these are found on the back of the title page. The online code charts carry specific restrictions. All other files, including online documentation of the core specification for Unicode 6.0 and later, are covered under these general Terms of Use.
6. No license is granted to "mirror" the Unicode website where a fee is charged for access to the "mirror" site.

7. Modification is not permitted with respect to this document. All copies of this document must be verbatim.

EXHIBIT 1

UNICODE, INC. LICENSE AGREEMENT - DATA FILES AND SOFTWARE

Unicode Data Files include all data files under the directories

<http://www.unicode.org/Public/>, <http://www.unicode.org/reports/>, and <http://www.unicode.org/cldr/data/>. Unicode Data Files do not include PDF online code charts under the directory

<http://www.unicode.org/Public/>. Software includes any source code published in the Unicode Standard or under the directories

<http://www.unicode.org/Public/>, <http://www.unicode.org/reports/>, and <http://www.unicode.org/cldr/data/>.

NOTICE TO USER: Carefully read the following legal agreement. BY DOWNLOADING, INSTALLING, COPYING OR OTHERWISE USING UNICODE INC.'S DATA FILES ("DATA FILES"), AND/OR SOFTWARE ("SOFTWARE"), YOU UNEQUIVOCALLY ACCEPT, AND AGREE TO BE BOUND BY, ALL OF THE TERMS AND CONDITIONS OF THIS AGREEMENT. IF YOU DO NOT AGREE, DO NOT DOWNLOAD, INSTALL, COPY, DISTRIBUTE OR USE THE DATA FILES OR SOFTWARE.

COPYRIGHT AND PERMISSION NOTICE

Copyright c 1991-2011 Unicode, Inc. All rights reserved. Distributed under the Terms of Use in <http://www.unicode.org/copyright.html>.

Permission is hereby granted, free of charge, to any person obtaining a copy of the Unicode data files and any associated documentation (the Data Files) or Unicode software and any associated documentation (the Software) to deal in the Data Files or Software without restriction, including without limitation the rights to use, copy, modify, merge, publish, distribute, and/or sell copies of the Data Files or Software, and to permit persons to whom the Data Files or Software are furnished to do so, provided that (a) the above copyright notice(s) and this permission notice appear with all copies of the Data Files or Software, (b) both the above copyright notice(s) and this permission notice appear in associated documentation, and (c) there is clear notice in each modified Data File or in the Software as well as in the documentation associated with the Data File(s) or Software that the data or software has been modified.

THE DATA FILES AND SOFTWARE ARE PROVIDED "AS IS", WITHOUT WARRANTY OF ANY KIND, EXPRESS OR IMPLIED, INCLUDING BUT NOT LIMITED TO THE WARRANTIES OF MERCHANTABILITY, FITNESS FOR A PARTICULAR PURPOSE AND NON-INFRINGEMENT OF THIRD PARTY RIGHTS. IN NO EVENT SHALL THE COPYRIGHT HOLDER OR HOLDERS INCLUDED IN THIS NOTICE BE LIABLE FOR ANY CLAIM, OR ANY SPECIAL INDIRECT OR CONSEQUENTIAL DAMAGES, OR ANY DAMAGES WHATSOEVER RESULTING FROM LOSS OF USE, DATA OR PROFITS, WHETHER IN AN ACTION OF CONTRACT, NEGLIGENCE OR OTHER TORTIOUS ACTION, ARISING OUT OF OR IN CONNECTION WITH THE USE OR PERFORMANCE OF THE DATA FILES OR SOFTWARE.

Except as contained in this notice, the name of a copyright holder shall not be used in advertising or otherwise to promote the sale, use or other dealings in these Data Files or Software without prior written authorization of the copyright holder.

ADPCM

Copyright 1992 by Stichting Mathematisch Centrum, Amsterdam, The Netherlands.

All Rights Reserved

Permission to use, copy, modify, and distribute this software and its documentation for any purpose and without fee is hereby granted, provided that the above copyright notice appear in all copies and that

both that copyright notice and this permission notice appear in supporting documentation, and that the names of Stichting Mathematisch Centrum or CWI not be used in advertising or publicity pertaining to distribution of the software without specific, written prior permission.

STICHTING MATHEMATISCH CENTRUM DISCLAIMS ALL WARRANTIES WITH REGARD TO THIS SOFTWARE, INCLUDING ALL IMPLIED WARRANTIES OF MERCHANTABILITY AND FITNESS, IN NO EVENT SHALL STICHTING MATHEMATISCH CENTRUM BE LIABLE FOR ANY SPECIAL, INDIRECT OR CONSEQUENTIAL DAMAGES OR ANY DAMAGES WHATSOEVER RESULTING FROM LOSS OF USE, DATA OR PROFITS, WHETHER IN AN ACTION OF CONTRACT, NEGLIGENCE OR OTHER TORTIOUS ACTION, ARISING OUT OF OR IN CONNECTION WITH THE USE OR PERFORMANCE OF THIS SOFTWARE.

OpenGL

Notice

License Applicability. Except to the extent portions of this file are made subject to an alternative license as permitted in the SGI Free Software License B, Version 1.0 (the "License"), the contents of this file are subject only to the provisions of the License. You may not use this file except in compliance with the License. You may obtain a copy of the License at Silicon Graphics, Inc., attn: Legal Services, 1600 Amphitheatre Parkway, Mountain View, CA 94043-1351, or at: <http://oss.sgi.com/projects/FreeB>

Note that, as provided in the License, the Software is distributed on an "AS IS" basis, with ALL EXPRESS AND IMPLIED WARRANTIES AND CONDITIONS DISCLAIMED, INCLUDING, WITHOUT LIMITATION, ANY IMPLIED WARRANTIES AND CONDITIONS OF MERCHANTABILITY, SATISFACTORY QUALITY, FITNESS FOR A PARTICULAR PURPOSE, AND NON-INFRINGEMENT.

Original Code. The Original Code is: OpenGL Sample Implementation, Version 1.2.1, released January 26, 2000, developed by Silicon Graphics, Inc. The Original Code is Copyright (c) 1991-2000 Silicon Graphics, Inc.

Copyright in any portions created by third parties is as indicated elsewhere herein. All Rights Reserved.

Additional Notice Provisions: The application programming interfaces established by SGI in conjunction with the Original Code are The OpenGL(R) Graphics System: A Specification (Version 1.2.1), released April 1, 1999; The OpenGL(R) Graphics System Utility Library (Version 1.3), released November 4, 1998; and OpenGL(R) Graphics with the X Window System(R) (Version 1.3), released October 19, 1998. This software was created using the OpenGL(R) version 1.2.1 Sample Implementation published by SGI, but has not been independently verified as being compliant with the OpenGL(R) version 1.2.1 Specification. SGI FREE SOFTWARE LICENSE B (Version 1.1 [02/22/2000])

1. Definitions.

- 1.1. "Additional Notice Provisions" means such additional provisions as appear in the Notice in Original Code under the heading "Additional Notice Provisions."
- 1.2. "Covered Code" means the Original Code or Modifications, or any combination thereof.
- 1.3. "Hardware" means any physical device that accepts input, processes input, stores the results of processing, and/or provides output.
- 1.4. "Larger Work" means a work that combines Covered Code or portions thereof with code not governed by the terms of this License.
- 1.5. "Licensable" means having the right to grant, to the maximum extent possible, whether at the time of the initial grant or subsequently acquired, any and all of the rights conveyed herein.
- 1.6. "License" means this document.

- 1.7. "Licensed Patents" means patent claims Licensable by SGI that are infringed by the use or sale of Original Code or any Modifications provided by SGI, or any combination thereof.
- 1.8. "Modifications" means any addition to or deletion from the substance or structure of the Original Code or any previous Modifications. When Covered Code is released as a series of files, a Modification is:
- A. Any addition to the contents of a file containing Original Code and/or addition to or deletion from the contents of a file containing previous Modifications.
- B. Any new file that contains any part of the Original Code or previous Modifications.
- 1.9. "Notice" means any notice in Original Code or Covered Code, as required by and in compliance with this License.
- 1.10. "Original Code" means source code of computer software code that is described in the source code Notice required by Exhibit A as Original Code, and updates and error corrections specifically thereto.
- 1.11. "Recipient" means an individual or a legal entity exercising rights under, and complying with all of the terms of, this License or a future version of this License issued under Section 8. For legal entities, "Recipient" includes any entity that controls, is controlled by, or is under common control with Recipient. For purposes of this definition, "control" of an entity means (a) the power, direct or indirect, to direct or manage such entity, or (b) ownership of fifty percent (50%) or more of the outstanding shares or beneficial ownership of such entity.
- 1.12. "Recipient Patents" means patent claims Licensable by a Recipient that are infringed by the use or sale of Original Code or any Modifications provided by SGI, or any combination thereof.
- 1.13. "SGI" means Silicon Graphics, Inc.
- 1.14. "SGI Patents" means patent claims Licensable by SGI other than the Licensed Patents.
2. License Grant and Restrictions.
- 2.1. SGI License Grant. Subject to the terms of this License and any third party intellectual property claims, for the duration of intellectual property protections inherent in the Original Code, SGI hereby grants Recipient a worldwide, royalty-free, non-exclusive license, to do the following: (i) under copyrights Licensable by SGI, to reproduce, distribute, create derivative works from, and, to the extent applicable, display and perform the Original Code and/or any Modifications provided by SGI alone and/or as part of a Larger Work; and (ii) under any Licensable Patents, to make, have made, use, sell, offer for sale, import and/or otherwise transfer the Original Code and/or any Modifications provided by SGI. Recipient accepts the terms and conditions of this License by undertaking any of the aforementioned actions. The patent license shall apply to the Covered Code if, at the time any related Modification is added, such addition of the Modification causes such combination to be covered by the Licensed Patents. The patent license in Section 2.1(ii) shall not apply to any other combinations that include the Modification. No patent license is provided under SGI Patents for infringements of SGI Patents by Modifications not provided by SGI or combinations of Original Code and Modifications not provided by SGI.
- 2.2. Recipient License Grant. Subject to the terms of this License and any third party intellectual property claims, Recipient hereby grants SGI and any other Recipients a worldwide, royalty-free, non-exclusive license, under any Recipient Patents, to make, have made, use, sell, offer for sale, import and/or otherwise transfer the Original Code and/or any Modifications provided by SGI.
- 2.3. No License For Hardware Implementations. The licenses granted in Section 2.1 and 2.2 are not applicable to implementation in Hardware of the algorithms embodied in the Original Code or any Modifications provided by SGI .
3. Redistributions.
- 3.1. Retention of Notice/Copy of License. The Notice set forth in Exhibit A, below, must be conspicuously retained or included in any and all redistributions of Covered Code. For distributions of the Covered Code in source code form, the Notice must appear in every file that can include a text comments field; in executable form, the Notice and a copy of this License must appear in related documentation or collateral where the Recipient's rights relating to Covered Code are described. Any Additional Notice Provisions which actually appears in the Original Code must also be retained or included in any and all redistributions of Covered Code.
- 3.2. Alternative License. Provided that Recipient is in compliance with the terms of this License, Recipient may, so long as without derogation of any of SGI's rights in and to the Original Code, distribute the source code and/or executable version(s) of Covered Code under (1) this License; (2) a license identical to this License but for only such changes as are necessary in order to clarify Recipient's role as licensor of Modifications; and/or (3) a license of Recipient's choosing, containing terms different from this License, provided that the license terms include this Section 3 and Sections 4, 6, 7, 10, 12, and 13, which terms may not be modified or superseded by any other terms of such license. If Recipient elects to use any license other than this License, Recipient must make it absolutely clear that any of its terms which differ from this License are offered by Recipient alone, and not by SGI. It is emphasized that this License is a limited license, and, regardless of the license form employed by Recipient in accordance with this Section 3.2, Recipient may relicense only such rights, in Original Code and Modifications by SGI, as it has actually been granted by SGI in this License.
- 3.3. Indemnity. Recipient hereby agrees to indemnify SGI for any liability incurred by SGI as a result of any such alternative license terms Recipient offers.
4. Termination. This License and the rights granted hereunder will terminate automatically if Recipient breaches any term herein and fails to cure such breach within 30 days thereof. Any sublicense to the Covered Code that is properly granted shall survive any termination of this License, absent termination by the terms of such sublicense. Provisions that, by their nature, must remain in effect beyond the termination of this License, shall survive.
5. No Trademark Or Other Rights. This License does not grant any rights to: (i) any software apart from the Covered Code, nor shall any other rights or licenses not expressly granted hereunder arise by implication, estoppel or otherwise with respect to the Covered Code; (ii) any trade name, trademark or service mark whatsoever, including without limitation any related right for purposes of endorsement or promotion of products derived from the Covered Code, without prior written permission of SGI; or (iii) any title to or ownership of the Original Code, which shall at all times remain with SGI. All rights in the Original Code not expressly granted under this License are reserved.
6. Compliance with Laws; Non-Infringement. There are various worldwide laws, regulations, and executive orders applicable to dispositions of Covered Code, including without limitation export, re-export, and import control laws, regulations, and executive orders, of the U.S. government and other countries, and Recipient is reminded it is obliged to obey such laws, regulations, and executive orders. Recipient may not distribute Covered Code that (i) in any way infringes (directly or contributorily) any intellectual property rights of any kind of any other person or entity or (ii) breaches any representation or warranty, express,

- implied or statutory, to which, under any applicable law, it might be deemed to have been subject.
7. Claims of Infringement. If Recipient learns of any third party claim that any disposition of Covered Code and/or functionality wholly or partially infringes the third party's intellectual property rights, Recipient will promptly notify SGI of such claim.
 8. Versions of the License. SGI may publish revised and/or new versions of the License from time to time, each with a distinguishing version number. Once Covered Code has been published under a particular version of the License, Recipient may, for the duration of the license, continue to use it under the terms of that version, or choose to use such Covered Code under the terms of any subsequent version published by SGI. Subject to the provisions of Sections 3 and 4 of this License, only SGI may modify the terms applicable to Covered Code created under this License.
 9. DISCLAIMER OF WARRANTY. COVERED CODE IS PROVIDED "AS IS." ALL EXPRESS AND IMPLIED WARRANTIES AND CONDITIONS ARE DISCLAIMED, INCLUDING, WITHOUT LIMITATION, ANY IMPLIED WARRANTIES AND CONDITIONS OF MERCHANTABILITY, SATISFACTORY QUALITY, FITNESS FOR A PARTICULAR PURPOSE, AND NON-INFRINGEMENT. SGI ASSUMES NO RISK AS TO THE QUALITY AND PERFORMANCE OF THE SOFTWARE. SHOULD THE SOFTWARE PROVE DEFECTIVE IN ANY RESPECT, SGI ASSUMES NO COST OR LIABILITY FOR SERVICING, REPAIR OR CORRECTION. THIS DISCLAIMER OF WARRANTY IS AN ESSENTIAL PART OF THIS LICENSE. NO USE OF ANY COVERED CODE IS AUTHORIZED HEREUNDER EXCEPT SUBJECT TO THIS DISCLAIMER.
 10. LIMITATION OF LIABILITY. UNDER NO CIRCUMSTANCES NOR LEGAL THEORY, WHETHER TORT (INCLUDING, WITHOUT LIMITATION, NEGLIGENCE OR STRICT LIABILITY), CONTRACT, OR OTHERWISE, SHALL SGI OR ANY SGI LICENSOR BE LIABLE FOR ANY DIRECT, INDIRECT, SPECIAL, INCIDENTAL, OR CONSEQUENTIAL DAMAGES OF ANY CHARACTER INCLUDING, WITHOUT LIMITATION, DAMAGES FOR LOSS OF GOODWILL, WORK STOPPAGE, LOSS OF DATA, COMPUTER FAILURE OR MALFUNCTION, OR ANY AND ALL OTHER COMMERCIAL DAMAGES OR LOSSES, EVEN IF SUCH PARTY SHALL HAVE BEEN INFORMED OF THE POSSIBILITY OF SUCH DAMAGES. THIS LIMITATION OF LIABILITY SHALL NOT APPLY TO LIABILITY FOR DEATH OR PERSONAL INJURY RESULTING FROM SGI'S NEGLIGENCE TO THE EXTENT APPLICABLE LAW PROHIBITS SUCH LIMITATION. SOME JURISDICTIONS DO NOT ALLOW THE EXCLUSION OR LIMITATION OF INCIDENTAL OR CONSEQUENTIAL DAMAGES, SO THAT EXCLUSION AND LIMITATION MAY NOT APPLY TO RECIPIENT.
 11. Indemnity. Recipient shall be solely responsible for damages arising, directly or indirectly, out of its utilization of rights under this License. Recipient will defend, indemnify and hold harmless Silicon Graphics, Inc. from and against any loss, liability, damages, costs or expenses (including the payment of reasonable attorneys fees) arising out of Recipient's use, modification, reproduction and distribution of the Covered Code or out of any representation or warranty made by Recipient.
 12. U.S. Government End Users. The Covered Code is a "commercial item" consisting of "commercial computer software" as such terms are defined in title 48 of the Code of Federal Regulations and all U.S. Government End Users acquire only the rights set forth in this License and are subject to the terms of this License.
 13. Miscellaneous. This License represents the complete agreement concerning the its subject matter. If any provision of this License is held to be unenforceable, such provision shall be reformed so as to achieve as nearly as possible the same legal and economic

effect as the original provision and the remainder of this License will remain in effect. This License shall be governed by and construed in accordance with the laws of the United States and the State of California as applied to agreements entered into and to be performed entirely within California between California residents. Any litigation relating to this License shall be subject to the exclusive jurisdiction of the Federal Courts of the Northern District of California (or, absent subject matter jurisdiction in such courts, the courts of the State of California), with venue lying exclusively in Santa Clara County, California, with the losing party responsible for costs, including without limitation, court costs and reasonable attorneys fees and expenses. The application of the United Nations Convention on Contracts for the International Sale of Goods is expressly excluded. Any law or regulation that provides that the language of a contract shall be construed against the drafter shall not apply to this License.

Exhibit A

License Applicability. Except to the extent portions of this file are made subject to an alternative license as permitted in the SGI Free Software License B, Version 1.1 (the "License"), the contents of this file are subject only to the provisions of the License. You may not use this file except in compliance with the License. You may obtain a copy of the License at Silicon Graphics, Inc., attn: Legal Services, 1600 Amphitheatre Parkway, Mountain View, CA 94043-1351, or at: <http://oss.sgi.com/projects/FreeB>

Note that, as provided in the License, the Software is distributed on an "AS IS" basis, with ALL EXPRESS AND IMPLIED WARRANTIES AND CONDITIONS DISCLAIMED, INCLUDING, WITHOUT LIMITATION, ANY IMPLIED WARRANTIES AND CONDITIONS OF MERCHANTABILITY, SATISFACTORY QUALITY, FITNESS FOR A PARTICULAR PURPOSE, AND NON-INFRINGEMENT.

Original Code. The Original Code is: [name of software, version number, and release date], developed by Silicon Graphics, Inc. The Original Code is Copyright (c) [dates of first publication, as appearing in the Notice in the Original Code] Silicon Graphics, Inc. Copyright in any portions created by third parties is as indicated elsewhere herein. All Rights Reserved.

Additional Notice Provisions: [such additional provisions, if any, as appear in the Notice in the Original Code under the heading "Additional Notice Provisions"]

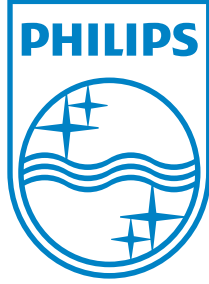

P&F USA, Inc.
PO Box 2248, Alpharetta, GA 30023-2248

P&F Mexicana, S.A. de C.V.
Av. La Palma No. 6, Col. San Fernando La Herradura,
Huixquilucan, Edo. de México. C.P. 52787