

**SAMSUNG**

# **SAMSUNG** **PLASMA DISPLAY**

---

**Owner's Instructions**  
**HP-P5031**



**This device is a Class B digital apparatus.**

# Important Warranty Information Regarding Television Format Viewing

Wide screen format PDP Displays (16:9, the aspect ratio of the screen width to height) are primarily designed to view wide screen format full-motion video. The images displayed on them should primarily be in the wide screen 16:9 ratio format, or expanded to fill the screen if your model offers this feature and the images are constantly moving. Displaying stationary graphics and images on screen, such as the dark side-bars on nonexpanded standard format television video and programming, should be limited to no more than 5% of the total television viewing per week.

Additionally, viewing other stationary images and text such as stock market reports, video game displays, station logos, web sites or computer graphics and patterns, should be limited as described above for all televisions. **Displaying stationary images that exceed the above guidelines can cause uneven aging of PDP Displays that leave subtle, but permanent burned-in ghost images in the PDP picture. To avoid this, vary the programming and images, and primarily display full screen moving images, not stationary patterns or dark bars.** On PDP models that offer picture sizing features, use these controls to view different formats as a full screen picture.

Be careful in the selection and duration of television formats used for viewing. Uneven PDP aging as a result of format selection and use, as well as burned-in images, are not covered by your Samsung limited warranty.

## User Instructions

### ● Screen Image retention

Do not display a still image (such as on a video game or when hooking up a PC to this PDP) on the plasma display panel for more than several minutes as it can cause screen image retention. This image retention is also known as "screen burn". To avoid such image retention, refer to page 44 of this manual to reduce the degree of brightness and contrast of this screen when displaying a still image.

### ● Cell Defect

The plasma display panel consists of fine cells. Although the panels are produced with more than 99.9 percent active cells, there may be some cells that do not produce light or remain lit.

### ● Altitude

The PDP will not operate normally at altitudes above 6500 ft.

### ● Warranty

Warranty does not cover any damage caused by image retention.  
Burn-in is not covered by the warranty.

## Table of Contents

### General Information

Your New Plasma Display Panel .....	6
Remote Control Buttons .....	8
Wall Installation Instructions .....	10
Connecting Speakers .....	14
How to assemble the Stand-Base .....	16

### Connections

Connecting VHF and UHF Antennas .....	18
Connecting Cable TV .....	19
Connecting a VCR .....	21
Connecting a Camcorder .....	22
Connecting a DVD Player .....	23
Connecting a DTV Receiver .....	24

### Operation

Turning the PDP On and Off .....	26
Plug & Play Feature.....	28
Memorizing the Channels .....	31
Setting Up Your Remote Control .....	36
Viewing an External Signal Source .....	38

### Picture Control

Customizing the Picture .....	42
Using Automatic Picture Settings .....	43
Selecting the Color Tone .....	44
DNle (Digital Natural Image engine) .....	45
Changing the Screen Size .....	46
Freezing the Picture .....	48
Viewing the Picture-in-Picture .....	49
Selecting a Signal Source (Antenna or Cable) for PIP .....	54
Setting the MCC(My Control Color) Mode .....	56

### Sound Control

Customizing the Sound .....	62
Using Automatic Sound Settings .....	63
Choosing a Multi-Channel Sound (MTS)Soundtrack .....	64
Using the Auto Volume .....	65
Setting the TruSurround XT .....	66
Listening to the Sound of the Sub(PIP) Picture .....	67
Selecting the Internal Mute.....	68

### Channel Control

Fine Tuning Channels .....	70
LNA (Low Noise Amplifier) .....	71

### Connecting a PC and Operation

Connecting a PC .....	74
Adjusting the PC Screen .....	78
Changing the Position of the Image.....	79
Picture Quality Adjustment .....	80
Information .....	83

### Time Setting

Setting the Clock .....	86
Setting the Sleep Timer .....	87
Setting the Timers .....	88

### Function Description

Selecting a Menu Language .....	92
Digital Noise Reduction .....	93
Selecting the Film Mode .....	94
Using the Color Weakness Enhancement Option .....	95
Setting the Melody Sound .....	96
Setting the Blue Screen .....	97
Viewing Closed Captions .....	98
Using the V-Chip.....	99

### Appendix

Troubleshooting .....	106
Care and Maintenance .....	107
Specifications.....	108



S  
V  
W  
S  
U  
N  
G

P L A S M A   D I S P L A Y   P A N E L

# General Information



Your New Plasma Display Panel .....	6
Remote Control Buttons .....	8
Wall Installation Instructions .....	10
Connecting Speakers .....	14
How to assemble the Stand-Base .....	16



# Your New Plasma Display Panel

## Front Panel



### SOURCE/ENTER button

Press to display all of the available video sources (ie., TV, AV1, AV2, S-Video, Component1, Component2, PC, DVI). Press to confirm a selection.

### MENU button

Displays the main on-screen menu and exit.

### VOL(+,-) button

Press to increase or decrease the volume. Also used to select or adjust items on the on-screen menu.

### CH(^, v) button

Press CH^ or CHv to change Channels. Also used to move up or down in the On-screen menu.



Press to turn the PDP on and off.

### Power Indicator

- Power Off: Red
- Power On: Off
- Timer On : Green

### Remote Control Signal Receiver

Aim the remote control towards this spot on the PDP.

## Checking Accessories

Once you have unpacked your PDP, check to make sure that you have all the parts shown here. If any piece is missing or broken, call your dealer.



Owner's Instructions

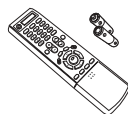

Remote Control (BN59-00377G)/  
AAA Batteries (4301-000103)



Ferrite Core 2EA  
(3301-001110)



Power Cord  
(3903-000144)



Antenna Cable  
(BN39-00333A)



Speaker Cables  
(BN39-00530A)

### Sold Separately



S-VIDEO Cable  
(AA39-40001E)



DVI Cable  
(BN39-00072A)



Component Cables (RCA)  
(AA39-00033A)



PC Cable  
(AA39-00288A)



PC Audio Cable  
(BH39-00120A)

## Rear Panel

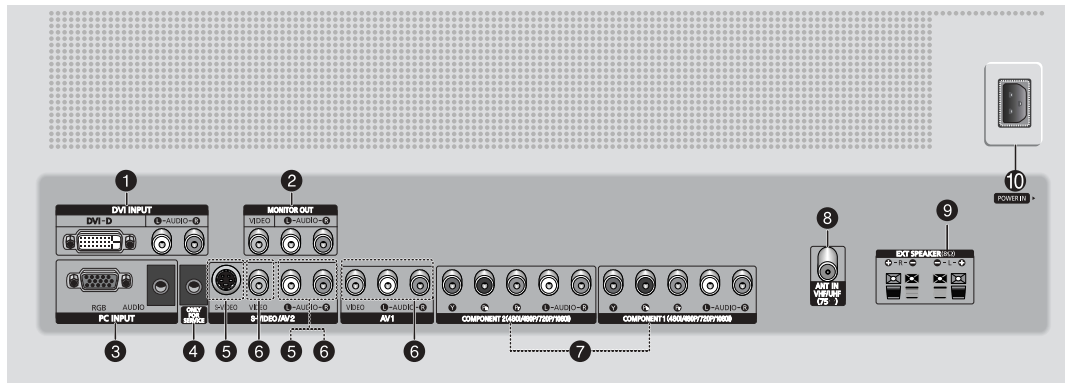

### 1 DVI INPUT (DVI-D / L-AUDIO-R)

Connect to the digital video and audio output jack of a device with DVI output.

### 2 MONITOR OUT (VIDEO / L-AUDIO-R)

Outputs for external devices.

### 3 PC INPUT (RGB IN / AUDIO)

Connect to the video and audio output jack on your PC.

### 4 FOR SERVICE ONLY

Connector for service only.

### 5 S-VIDEO

#### (S-VIDEO / L-AUDIO-R)

Video and audio inputs for external devices with an S-Video output, such as a camcorder or VCR.

### 6 AV1, AV2

#### (VIDEO / L-AUDIO-R)

Video and audio inputs for external devices, such as a camcorder or VCR.

### 7 COMPONENT 1, COMPONENT 2

Video (Y/Pb/Pr) and audio (L-AUDIO-R) inputs for Component.

### 8 ANT IN VHF/UHF (75Ω)

75Ω Coaxial connector for Antenna/Cable Network.

### 9 EXT SPEAKER (8Ω)

Connectors for external rear speakers.

### 10 POWER IN

Connect the supplied power cord.

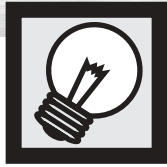

# Remote Control Buttons

## Remote Control

- 1 POWER button**  
Turns the PDP on and off.
- 2 ASPECT button**  
Press to change the screen size.
- 3 Number buttons**
- 4 +100 button**  
Press to select channels over 100. For example, to select channel 121, press "+100", then press "2" and "1."
- 5 MUTE button**  
Press to mute the PDP sound.
- 6 VOL (Volume) buttons**  
Use it to adjust volume.
- 7 SLEEP button**  
Press to select a preset time interval for automatic shutoff.
- 8 MENU button**  
Displays the main on-screen menu.
- 9 ENTER button**  
Confirms a selection.
- 10 PIP button**  
Activates picture in picture.
- 11 STILL button**  
Press to pause the current screen.
- 12 LCD Display**  
When you press a button, 'Wi-Fi' appears along with selected mode (TV, VCR, CATV, DVD or STB) and the remote's battery charge status.
- 13 P.MODE button**  
Adjust the PDP picture by selecting one of the preset factory settings (or select your personal, customized picture settings.)
- 14 MODE button**  
Selects a target device to be controlled by the Samsung remote control (i.e., VCR, Cable, DVD players or Samsung STB). If you change modes, the new mode is momentarily displayed on LCD.
- 15 PRE-CH button**  
Tunes to the previous channel.
- 16 SOURCE button**  
Press to display all of the available video sources (TV, AV1, AV2 S-VIDEO, COMPONENT1, COMPONENT2, PC, DVI).
- 17 CH (Channel) buttons**  
Use it to switch channels.
- 18 INFO button**  
Press to display information on the PDP screen.
- 19 EXIT button**  
Press to exit the menu.
- 20 Up/Down Left/Right buttons**  
Control the cursor in the menu.

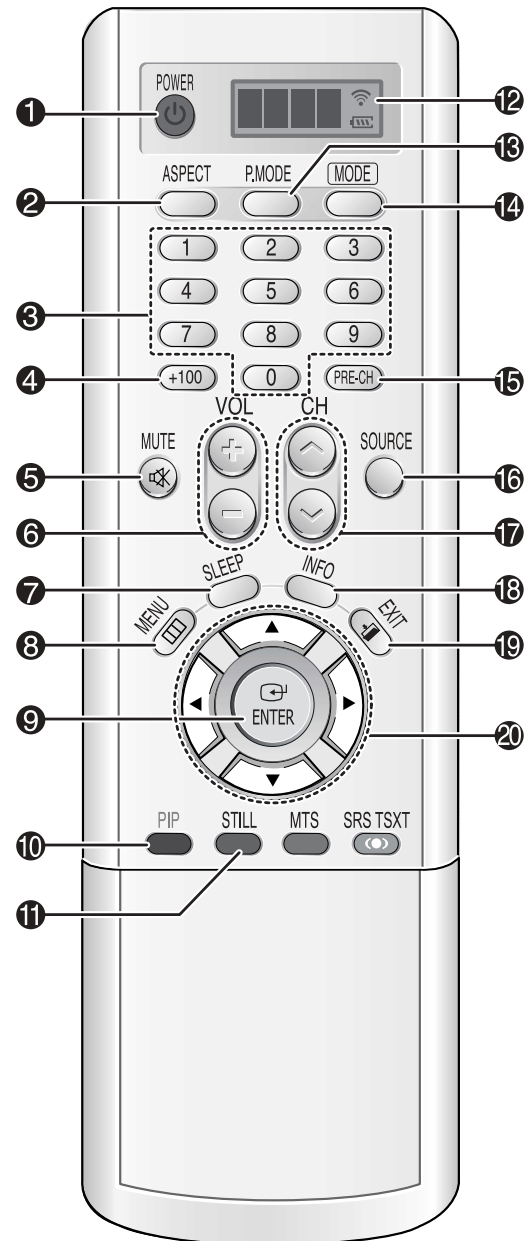



# Plasma Display

- 21 SRS TSXT button**  
Selects Trusurround XT mode.
- 22 MTS button**  
Press to choose stereo, mono or Separate Audio Program (SAP broadcast).
- 23 AUTO PROG. button**  
The TV automatically cycles through all of the available channels and stores them in memory.
- 24 ADD/DEL button**  
Press to add or delete channels in the TV's memory.
- 25 DNle button**  
Activates DNle (Digital Natural Image engine).
- 26 CAPTION button**  
Controls the caption decoder.
- 27 SET button**  
Used during set up of this Samsung remote control, so that it will work compatibly with other devices (VCR, Cable Box, DVD)
- 28 PIP control buttons**  
  - SIZE : Press to make the PIP window Large, Small or Double.
  - SWAP : Exchanges the video signal that is currently displayed on the main screen with the signal in the PIP window.
  - CH  $\wedge, \vee$  : Displays the available channels in sequence. (These buttons change channels in the PIP window only).
- 29 VCR, DVD control buttons**  
Controls VCR tape or DVD disc functions: Stop, Rewind, Play/Pause, Fast Forward.
- 30 RESET button**  
If your remote control is not functioning properly, take out the batteries and press the reset button for about 2~3 seconds. Re-insert the batteries and try using the remote control again.

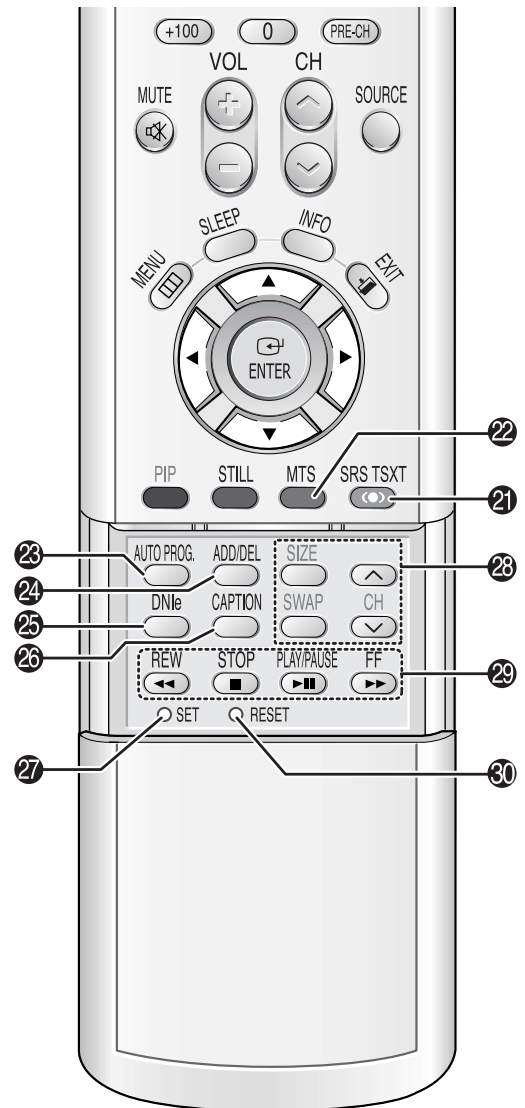

## Installing the Batteries in Your Remote Control

**1** Slide the back cover to open the battery compartment of the remote control.

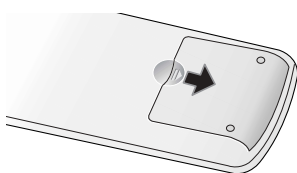

**2** Install two AAA size batteries. Make sure to match the "+" and "-" ends of the batteries with the diagram inside the compartment.

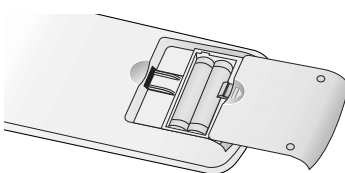

**3** Slide the cover back into place.

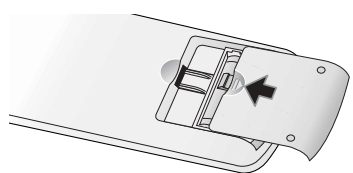

### Remote Control Operation Range.

You can use your remote control within a distance of 23 feet and an angle of 30 degrees from the left and right sides of the PDP's remote control receiver.



# Wall Installation Instructions

This wall mount bracket installation guide is for the following models:HP-P5031

## ● Installation Notes

- 
- 1 Do not install the PDP on any location other than a vertical wall.
- 
- 2 To protect the performance of the PDP and prevent problems, avoid the following locations:
    - Do not install next to smoke and fire detectors.
    - Do not install in an area subjected to vibration or high voltage.
    - Do not install near or around any heating apparatus.
- 
- 3 Use only recommended parts and components.

## ● Parts (Wall attachment panel is sold separately. Check with your dealer)

**Wall Mount Bracket**

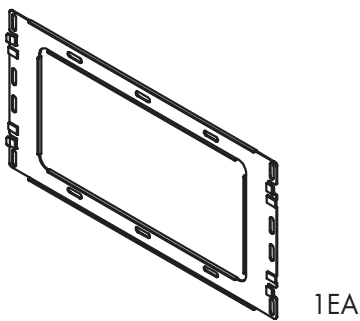

1EA

**ASSY-HINGE**

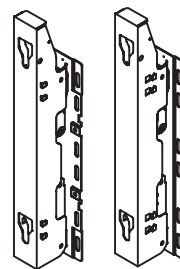

LEFT :1EA    RIGHT :1EA

**Support Bars**

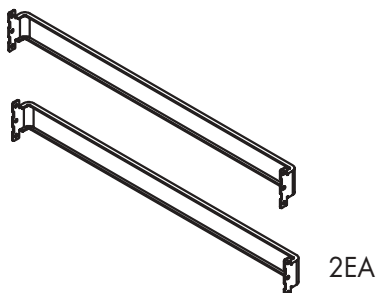

2EA

**Screws**



Insulation Holder : 4 EA    SCREW① : 4 EA    SCREW② : 12 EA



## ● How to assemble the Wall Mount Bracket

- 1 The wall mount comes packaged in 3 parts. These parts must be assembled together. Please tighten the captive screw in the direction of the arrow after assembling the bracket. Install the Wall Mount Bracket after the screws are securely inserted into the wall.

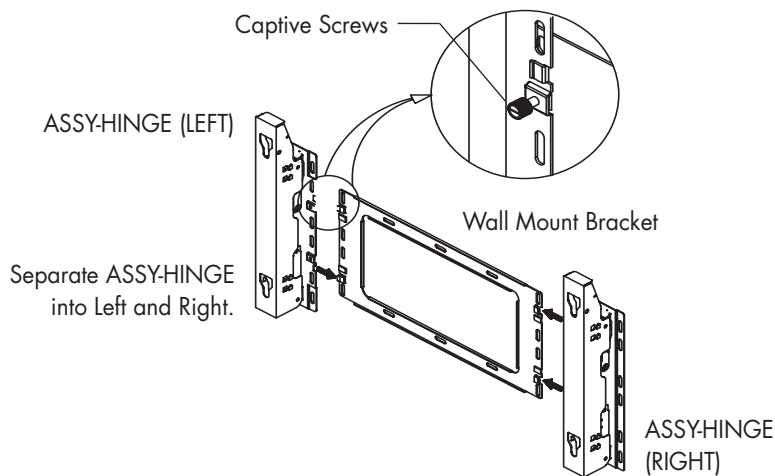

- 2 After installing the Wall Mount Bracket, assemble the support bars and hinges (as illustrated) using screws provided. (12 screws(②) are provided. For safety reasons, make sure all 12 screws are firmly attached.)

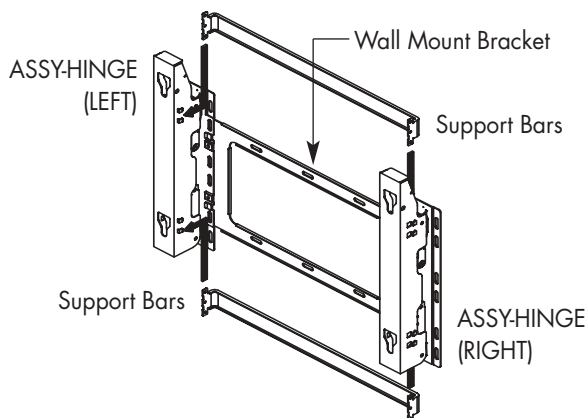

- 3 After securing the screws, be sure that every part is firmly attached (as shown in the illustration).

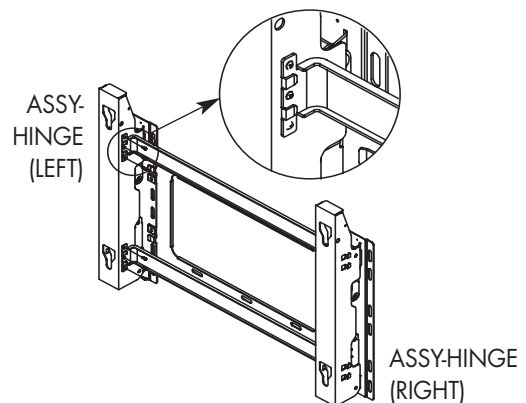



# Wall Installation Instructions

## ● Fixing the PDP panel to the wall attachment panel bracket

1 Remove the screws from the back of the PDP.

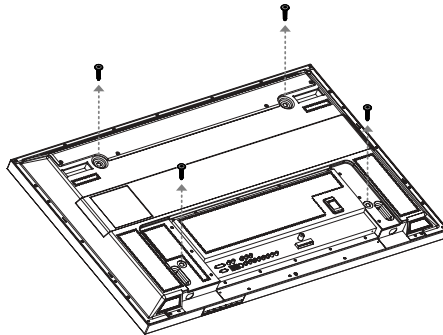

2 Connect insulation holders to screws (see the illustration below).

- If you are uncertain about installation, hire a specialist to install the wall mount bracket.
- Be sure to check that the insulation holders are completely secured on both the left and right side after hanging the PDP on the wall mount bracket.
- Be careful to avoid getting your fingers caught during installation.
- Make sure the wall attachment panels are tightened. Otherwise the PDP may fall.

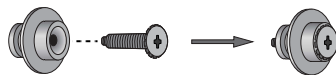

3 Tighten the screws of the insulation holders to the back of the PDP.

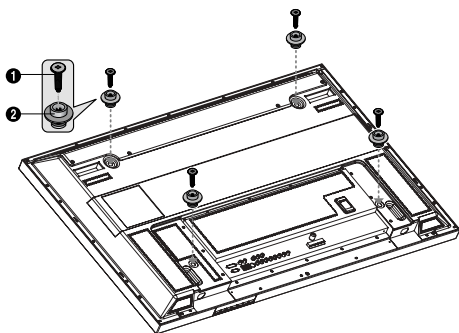

4 Put the 4 insulation holders on the PDP in the grooves of the wall mount bracket and pull down on the PDP (1) to secure it to the wall mount bracket (2). Tighten the screws as shown (3) so that the PDP cannot be separated from wall mount bracket.

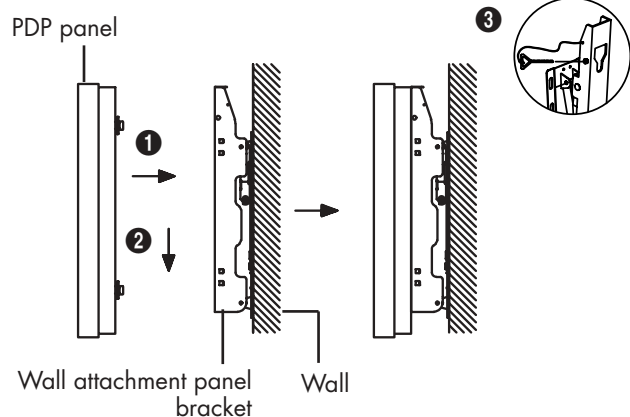

### **Note**

- A 5 inch gap is needed between the back of the Plasma TV and the wall.

## ● How to Adjust Mounting Angle

**Notice** : Please secure the mounting bracket on the wall surface after setting its angle at 0°.

### Factory default

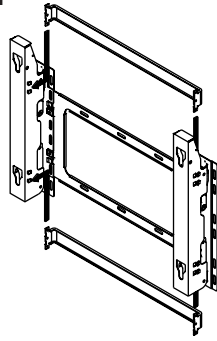

Please tighten the captive screw in the direction of the arrow after assembling the bracket.

### How to Adjust Mounting Angle

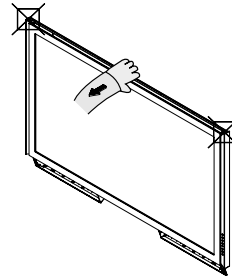

Hold onto the middle of the PDP to adjust the angle (not the sides of the PDP).

### Change Angle

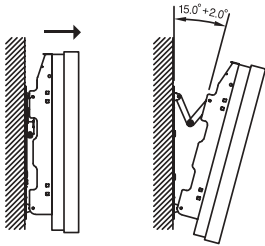

- 1 Secure the SET to the wall mount bracket. (Please refer to the following instructions.)
- 2 Set the angle by pulling the upper end of the SET attached to bracket in the direction of the arrow.
- 3 The angle can be adjusted from 0° to 15° by ±2°.

### Connecting External Devices to the PDP

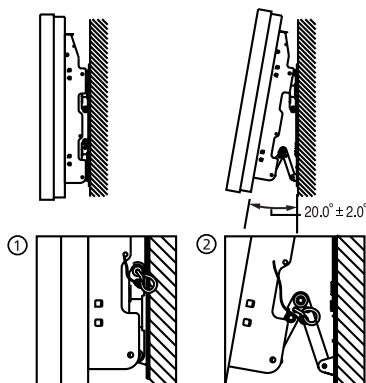

- 1 Be sure to remove the safety pins underneath the PDP. (**Caution** : If the safety pins are not removed, the angle cannot be adjusted.) Any attempt to do so may cause damage to the PDP.
- 2 Hold onto the bottom of the PDP and pull forward fully as directed by the arrow(as illustrated) to adjust the angle. (0°~20° by 2°). Insert the Safety Pins to the front guide holes on both sides as illustrated in figure ②.
- 3 **Viewing the PDP after connecting the external devices.** Remove the Safety Pins to adjust the angle to 0°, and then secure the Safety Pins again. (**Warning** : For safety, be sure to secure the PDP using the safety pins. If the safety pins are not used, the PDP may fall, causing serious injury.)

### Note

- Contact an authorized technician when installing the wall attachment panel.
- After hanging the PDP panel on the wall attachment panel, make sure that the Insulation holders are completely hung.
- Be careful not to get your fingers caught during installation.
- Make sure the wall attachment panel brackets are tightened. Otherwise, the PDP panel may fall down.
- Please secure the mounting bracket on the wall surface after setting its angle at 0°.



# Connecting Speakers

- 
- 1 Remove the screws on the rear of the PDP.

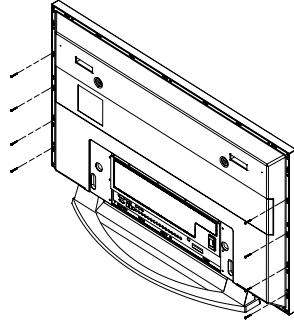

- 
- 2 Hang the two "T" shaped hangers on the square holes on the rear of the PDP.

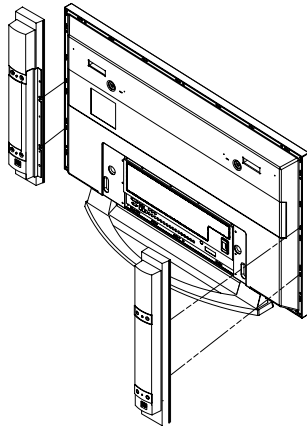

- 
- 3 Tighten the PDP and the speaker bracket using the screws removed from the PDP.

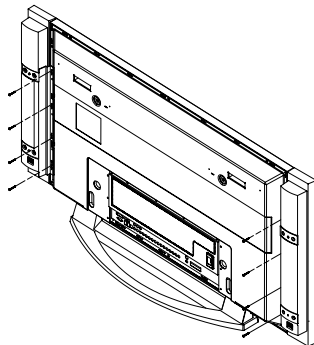

- When moving your PDP, do NOT hold the speaker connected to your PDP. It may damage the bracket clamping the speaker and your PDP together and result in a drop of your PDP and a risk of personal damage and injury.

# Plasma Display

Connect the speaker audio cable to the external speaker output jack on the rear of the PDP matching the "+" and "-" ends of the cable with the diagram on the PDP.

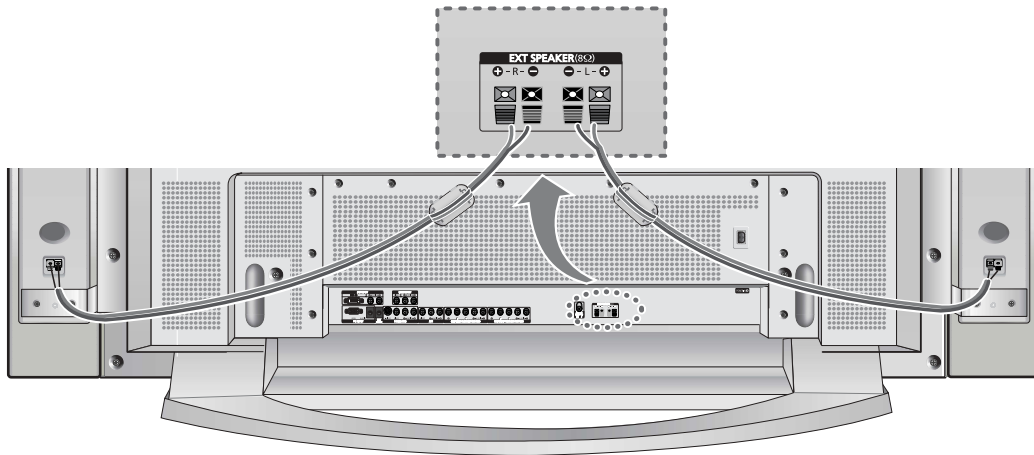

- The speakers **MUST** have to a power handling capability of 10 watts minimum (impedance 8Ω).  
When you connect the speaker wire to the external speaker out connector, first bind the speaker wire round the ferrite core to secure it.

## Ferrite Cores

The ferrite cores are used to attenuate undesired signals. When connecting cables, attach one of these ferrite cores to the cable near the connector.

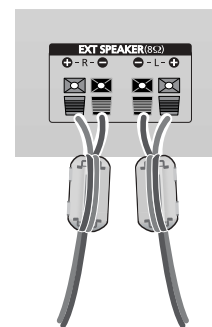



# How to assemble the Stand-Base

- 1 Assemble two support pins with the stand base and firmly secure both sides of the support pins using 8 screws provided.

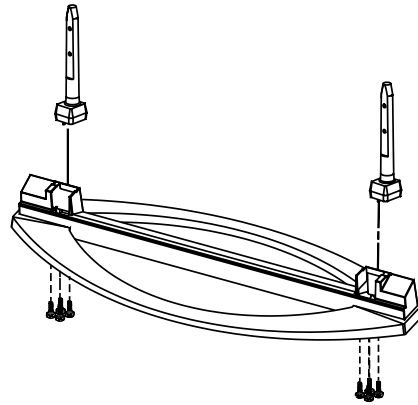

- 2 Assemble the PDP with the stand and firmly secure the PDP using 4 screws provided.

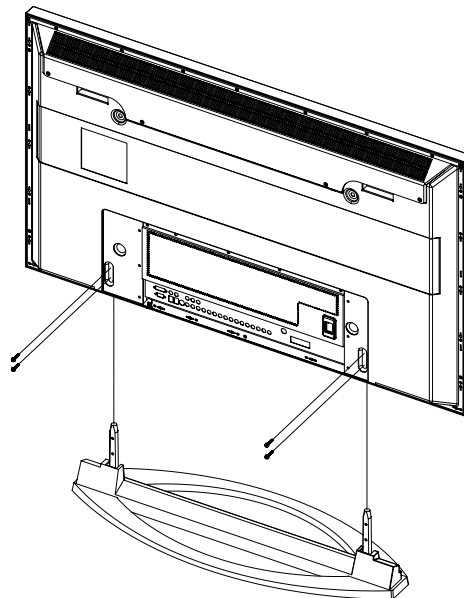

- Two or more people should carry the PDP. Never lay the PDP on the floor because of possible damage to the screen. Always store the PDP upright.



S  
V  
W  
S  
U  
N  
G

P L A S M A   D I S P L A Y   P A N E L

**Connections**



Connecting VHF and UHF Antennas .....	18
Connecting Cable TV .....	19
Connecting a VCR .....	21
Connecting a Camcorder .....	22
Connecting a DVD Player .....	23
Connecting a DTV Receiver .....	24



# Connecting VHF and UHF Antennas

## Antennas with 75-ohm Round Leads

If your antenna looks like this:  it has 75-ohm round leads.

- 1 Plug the antenna lead into the VHF/UHF terminal on the PDP.  
Use the Antenna Cable, an accessory included in the product package.

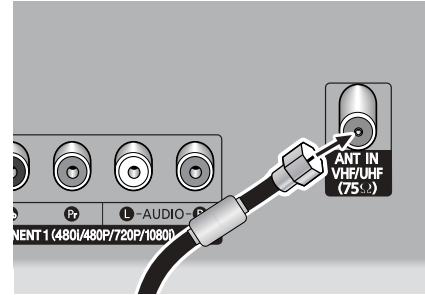



## Connecting Cable TV

You can connect different cable systems to your PDP, including cable without a cable box, and cable with a cable box that descrambles some or all channels.

### Cable without a Cable Box

- 1 Plug the incoming cable into the VHF/UHF terminal on the PDP.  
Use the Antenna Cable, an accessory included in the product package.

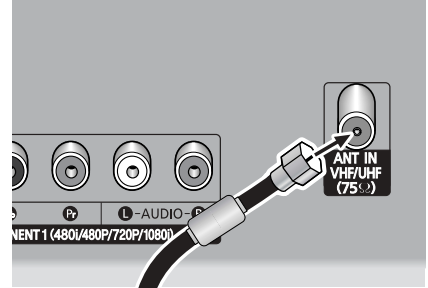

### Cable with a Cable Box that Descrambles All Channels

- 1 Find the cable connected to the ANTENNA OUT terminal on your cable box. This terminal might be labeled "ANT OUT", "VHF OUT" or simply "OUT".



- 2 Connect the cable to the VHF/UHF terminal on the PDP.  
Use the Antenna Cable, an accessory included in the product package.

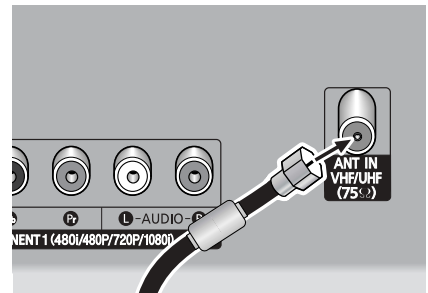

## Cable with a Cable Box that Descrambles Some (But Not All) Channels

To complete this connection you will need a two-way splitter, an RF (A/B) switch, and four coaxial cables (which you can buy from your Samsung dealer or any electronics store).

- 1 Find and disconnect the cable that is connected to the ANTENNA IN terminal of your cable box. This terminal might be labeled "ANT IN", "VHF IN" or simply, "IN". Connect this cable to a two-way splitter.

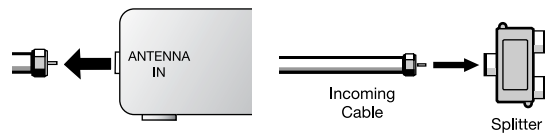

- 2 Connect a coaxial cable between an OUTPUT terminal of the splitter and the IN terminal of the cable box.

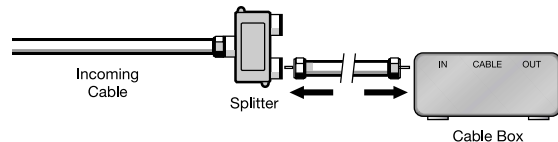

- 3 Connect a coaxial cable between the ANTENNA OUT terminal of the cable box and the B-IN terminal of the A/B switch.

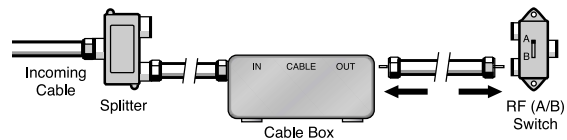

- 4 Connect a coaxial cable between the ANTENNA OUT terminal of the cable box and the B-IN terminal of the A/B switch.

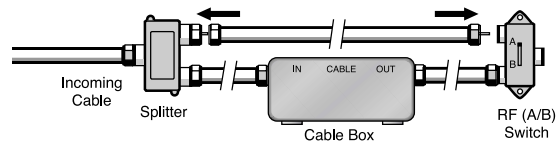

- 5 Connect the last coaxial cable between the OUT terminal of the RF (A/B) switch and the VHF/UHF terminal on the PDP.

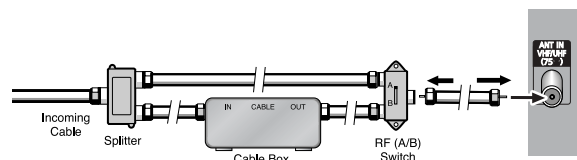

After you've made this connection, set the A/B switch to the "A" position for normal viewing. Set the A/B switch to the "B" position to view scrambled channels. (When you set the A/B switch to "B", you will need to tune your Set-Top Box to the cable box's output channel, which is usually channel 3 or 4.)



## Connecting a VCR

### Connecting a VCR to the Video or S-Video/Audio jack

PDP

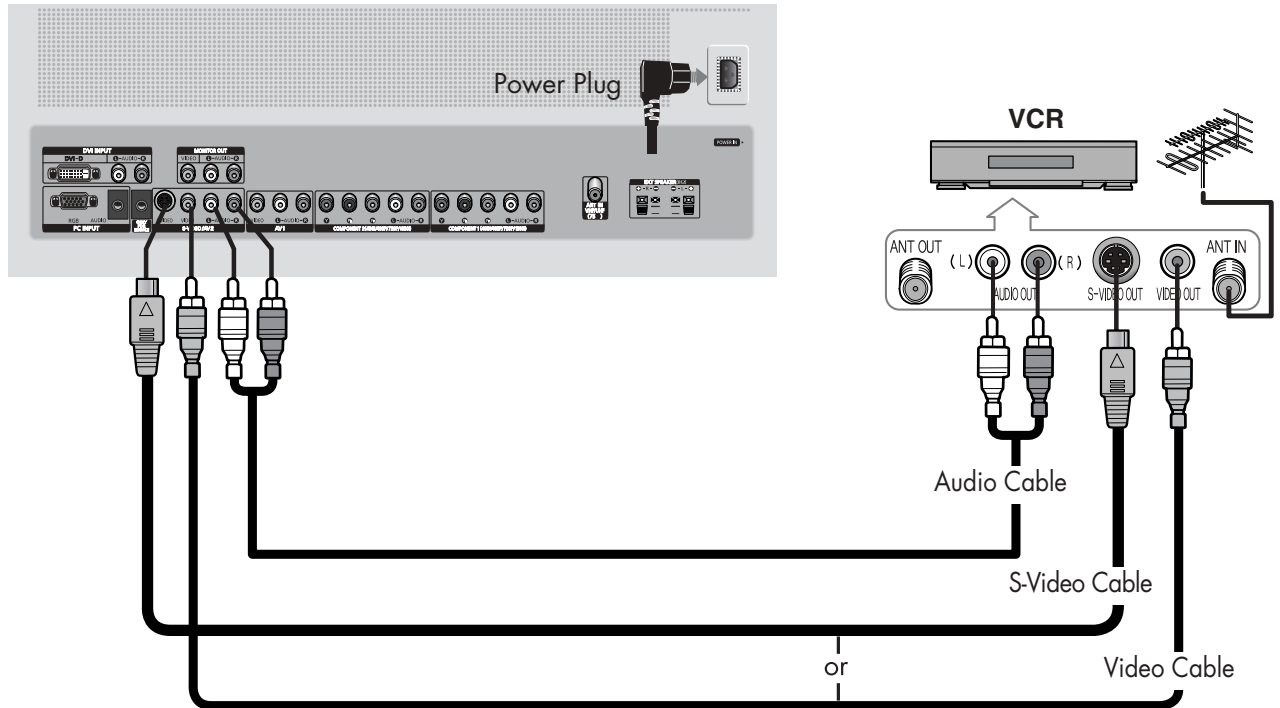

### How to Connect

Connect the Video/Audio cables between the VIDEO or S-VIDEO / L - AUDIO - R jacks on the PDP and VIDEO or S-VIDEO / L - AUDIO - R output jacks on the VCR. (Note: For better video, you can use an S-Video cable.)

#### Videotape Playback:

1. Turn on your PDP.
2. Press the SOURCE button to select "Video(AV1 or AV2)" or "S-Video."
3. Turn on your VCR, insert a videotape and press the play button.



# Connecting a Camcorder

## Viewing camcorder tapes

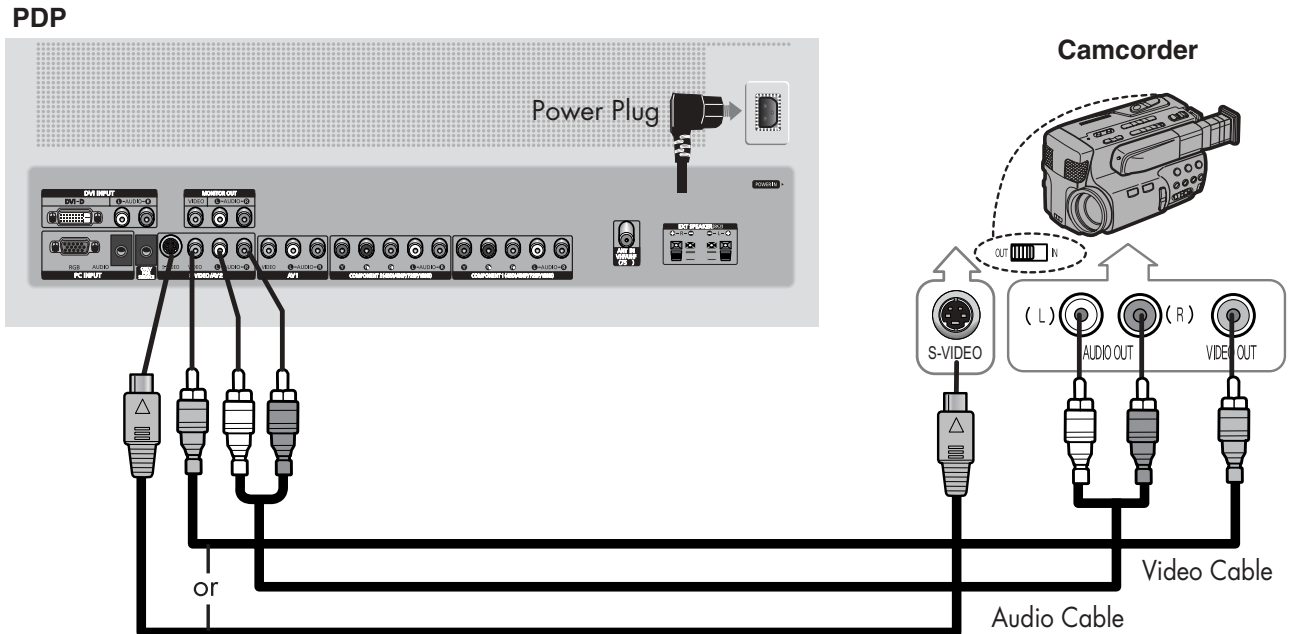

### How to Connect

Connect a Video/Audio cable between the VIDEO or S-VIDEO / L - AUDIO - R jacks on the PDP and the VIDEO or S-VIDEO / AUDIO output jacks on the camcorder.

#### Viewing Tapes

1. Turn on your PDP.
2. Press the SOURCE button to select "Video(AV1 or AV2)" or "S-VIDEO".
3. Turn on your camcorder and set it to Video Mode. (For details, refer to your camcorder Owner's instructions.)
4. Set the IN/OUT switch on your camcorder to OUT.
5. Insert the tape into the camcorder and press the Play button.

# Plasma Display



## Connecting a DVD Player (480i, 480p)

This PDP displays the optimum picture in 720p mode.

### Playing DVD

PDP

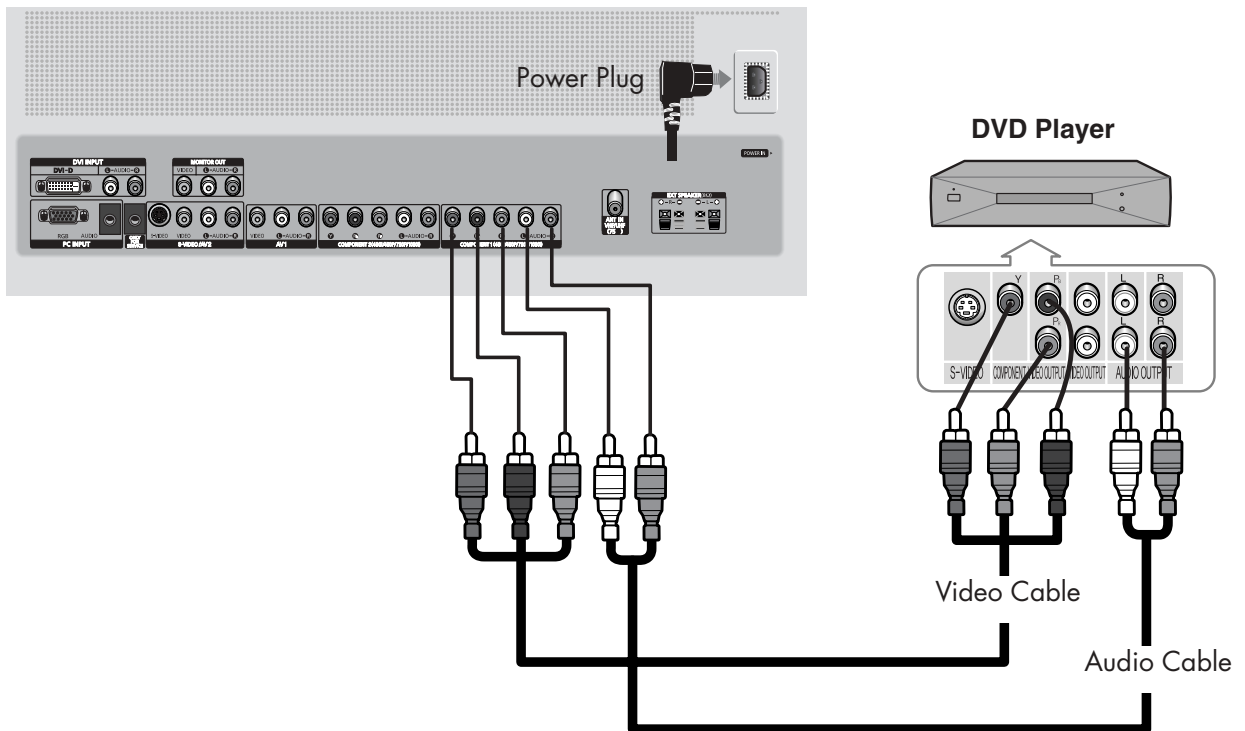

### How to Connect

- 1 Connect a Video Cable between the Y, Pb, Pr (COMPONENT1, 2) input jacks on the PDP and Y/P<sub>B</sub>/P<sub>R</sub> output jacks on the DVD player.
- 2 Connect a Audio Cable between the AUDIO L/R (COMPONENT1, 2) input jacks on the PDP and the AUDIO output jacks on the DVD player.

#### To Play DVD:

1. Turn on your PDP.
2. Press the SOURCE button to select "COMPONENT1" or "COMPONENT2".
3. Turn on your DVD player, insert a DVD disc and press the Play button.
  - For an explanation of Component video, see your DVD owner's instructions.



# Connecting a DTV Receiver (480p, 720p, 1080i)

This PDP displays the optimum picture in 720p mode.

## Watching DTV

PDP

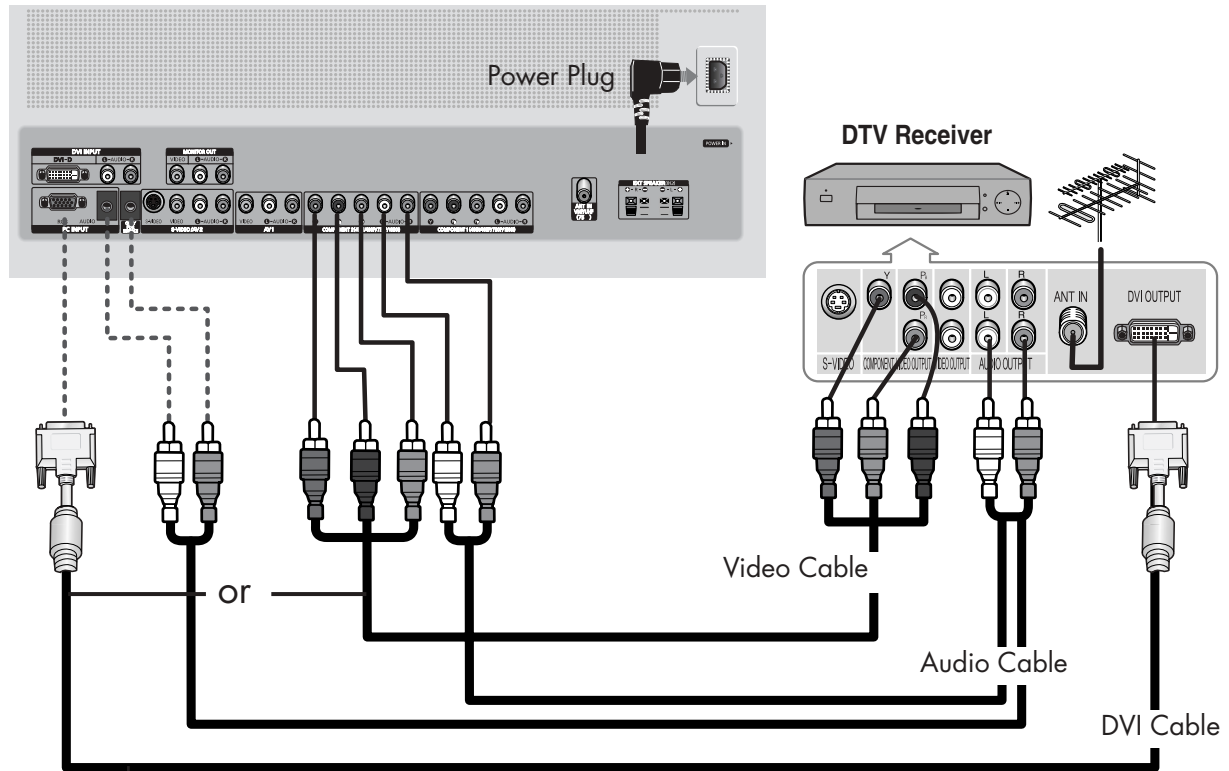

Use a DVI-D connection cable. (sold separately)

### How to Connect

- 1 Connect the cable or antenna to the antenna input jack on the DTV.
- 2 Connect a Video cable between the Y, P<sub>b</sub>, P<sub>r</sub> (COMPONENT 1, 2) or DVI jack on the PDP and the Y, P<sub>b</sub>, P<sub>r</sub> (COMPONENT) or DVI output jacks on the DTV receiver.
- 3 Connect an Audio cable between the COMPONENT 1, 2 (L/R AUDIO) or DVI (L/R AUDIO) jacks on the PDP and the AUDIO output jacks on the DTV receiver.

#### To Watch DTV:

1. Turn on your PDP.
2. Press the SOURCE button to select "COMPONENT1", "COMPONENT2" or "DVI".
3. Turn on your DTV receiver.
  - For an explanation of Component video, see your DTV receiver owner's instructions.



S  
V  
W  
S  
U  
N  
G

P L A S M A   D I S P L A Y   P A N E L

# Operation



Turning the PDP On and Off .....	26
Plug & Play Feature .....	28
Memorizing the Channels.....	31
Setting Up Your Remote Control .....	36
Viewing an External Signal Source .....	38



# Turning the PDP On and Off

## Turning the PDP On and Off

Press the POWER button on the remote control. The PDP will be turned on and you will be ready to use its features.

You can also use the POWER (I/O) button on the front of the PDP.

### Notes:

- If your PDP isn't turned on when the power button is pressed: Press the **MODE** button to check if the TV mode has been chosen (  ).

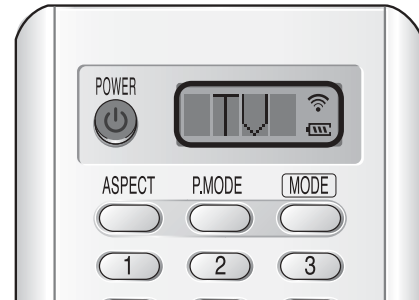

## Viewing the Menus and Displays

Your PDP has a simple, easy-to-use menu system that appears on the PDP screen. This system makes it convenient and fast to use features on the PDP. Your PDP also lets you display the status of many of your PDP's features.

### Viewing the Menus

- 1 With the power on, press the MENU button on the remote control. The main menu appears on the screen. The Input menu is selected.



- 2 Press the ▲ or ▼ buttons to move to items in the menu. Press the ◀/▶/ENTER buttons to display, change, or use the selected items.

Press the ENTER (  ) button to enter items in the menu.

On screen menus disappear from the screen automatically after about two minutes, or you can press the MENU or EXIT button on your remote control to exit the menu.

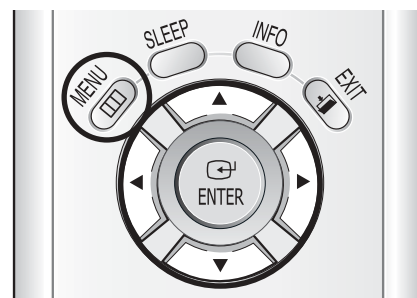

## Displaying Status Information

Press the INFO button on the remote control.  
The PDP will display the Picture mode, Sound mode, MTS,  
Caption, and Clock.

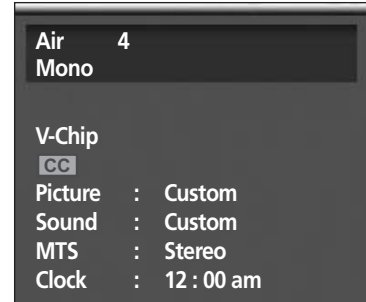



# Plug & Play Feature

When the television is initially powered ON, several basic customer settings proceed automatically and subsequently. The following settings are available.

- 1 If the television is in Standby mode, press the POWER button on the remote control.
  - The message Start Plug & Play is displayed and then the Language menu is automatically displayed.



- 2 Select the appropriate language by pressing the ▲ or ▼ button.
  - The message Check antenna input is displayed.



- 3 Press the ENTER button to confirm your choice.



- 4 Press the ENTER button.

- 5** Select the correct signal source (Air, STD, HRC and IRC) by pressing the ▲ or ▼ button, then press the ENTER button.

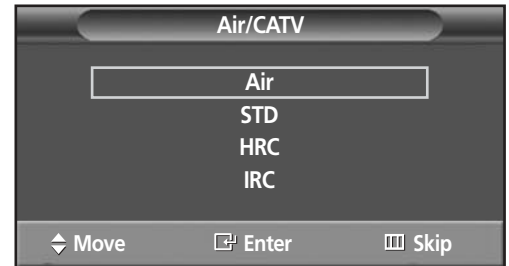

- 6** To start the channel search, press the ENTER button.
- The search will end automatically. Channels are sorted and stored in an order which reflects their position in the frequency range (with lowest first and highest last). When it has finished, the Clock Set menu is displayed.
  - To stop the search before it has finished or return to normal viewing, press the MENU button.

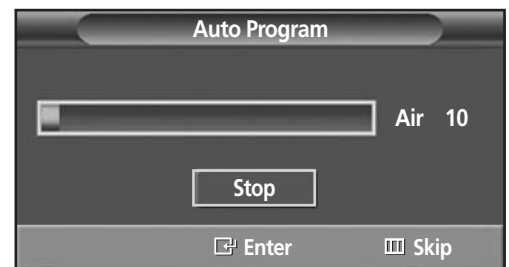
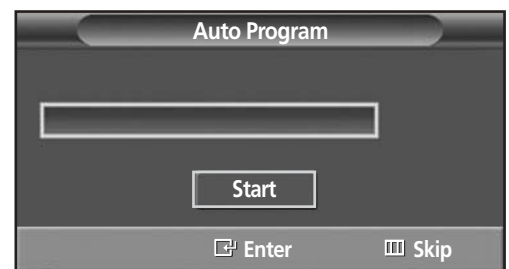

- 7** Press the ENTER button.  
Press the ◀ or ▶ button to move to the Hour, Minute, or am/pm.  
Set the Hour, Minute, or am/pm by pressing the ▲ or ▼ button.  
Press the ENTER button.

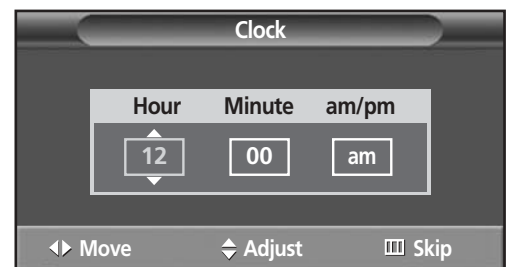

- 8** When it has finished, the message "Enjoy your watching" is displayed, and the channels which have been stored can be viewed.

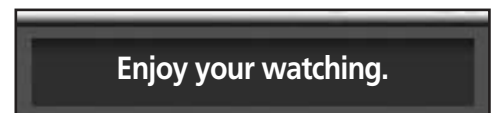



# Plug & Play Feature (continued)

If you want to reset this feature...

- 1 Press the MENU button. Press the ▲ or ▼ button to select "Setup", then press the ENTER button.



- 2 Press the ▲ or ▼ button to select "Miscellaneous", then press the ENTER button.

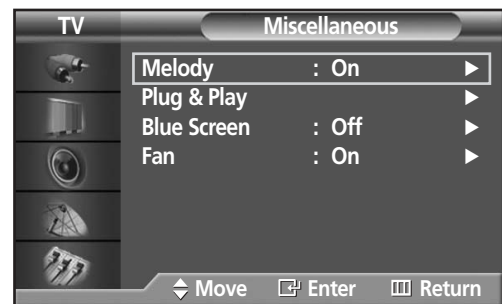

- 3 Press the ▲ or ▼ button to select "Plug & Play". Press the ENTER button.



- 4 For further details on how to set, refer to the previous page.

## **Note**

- Plug and Play can only be accessed in the TV mode.



## Memorizing the Channels

Your PDP can memorize and store all of the available channels for both “off-air” (antenna) and cable channels. After the available channels are memorized, use the CH ^ and CH v buttons to scan through the channels. This eliminates the need to change channels by entering the channel digits. There are three steps for memorizing channels: selecting a broadcast source, memorizing the channels (automatic) and adding and deleting channels (manual).

### Selecting the Video Signal-source

Before your television can begin memorizing the available channels, you must specify the type of signal source that is connected to the PDP (i.e., an antenna or a cable system).

- 1 Press the MENU button. Press the ▲ or ▼ button to select “Channel”, then press the ENTER button.

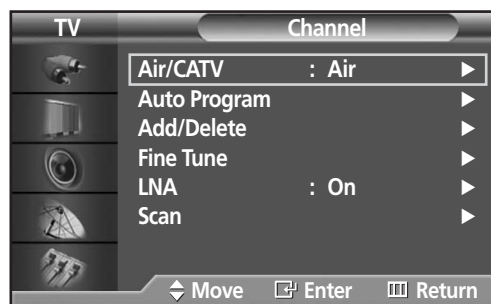

- 2 Press the ENTER button to select “Air/CATV”.

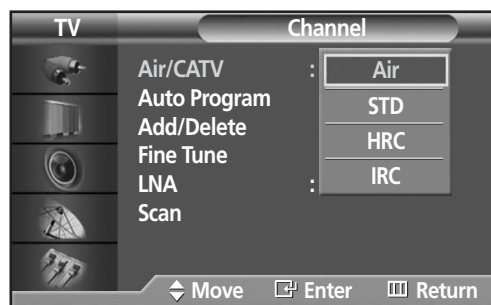

- 3 Press the ▲ or ▼ button to select “Air”, “STD”, “HRC” or “IRC”, then press the ENTER button.
  - If you are connected to an antenna, leave “Air” displayed. If you connected cable, press the ▲ or ▼ button to the display the type of cable system: “STD”, “HRC” or “IRC”. (If you are not sure which type of cable system you have, contact your cable company).

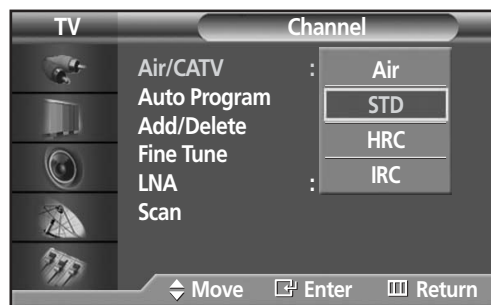

- 4 Press the MENU button to exit.

#### Note

- STD, HRC and IRC identify various types of cable TV systems. Contact your local cable company to identify the type of cable system that exists in your particular area. At this point the signal source has been selected. Proceed to “Storing Channels in Memory” (Next page).

## Storing Channels in Memory (Automatic Method)

- 1 First, select the correct signal source (Air, STD, HRC and IRC). See steps on previous page. Press the MENU button. Press the ▲ or ▼ button to select "Channel", then press the ENTER button.

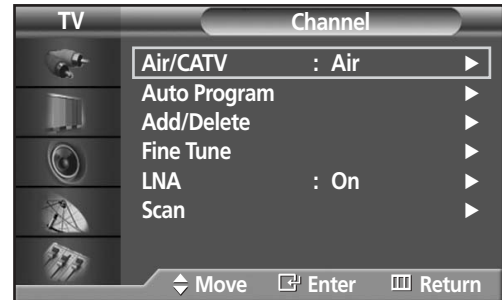

- 2 Press the ▲ or ▼ button to select "Auto Program", then press the ENTER button.

➤ Quick way to access the Automatic Channel Setting: Just press the "AUTO PROG." button on the remote control.

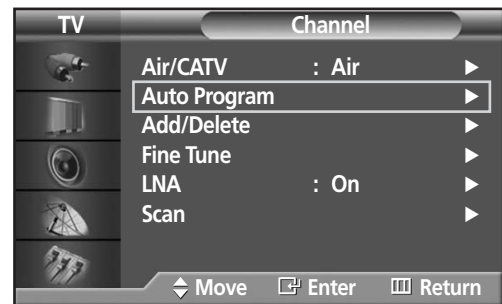

- 3 Press the ENTER button. The PDP will begin memorizing all of the available channels. After all the available channels are stored, the Auto program menu reappears. Press the ENTER button to stop.

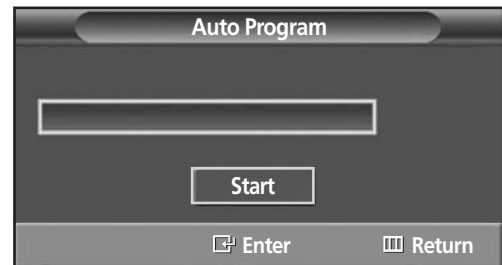

- 4 Press the MENU button to exit.

### **Note**

- The PDP automatically cycles through all of the available channels and stores them in memory. This takes about one to two minutes.



## Adding and Erasing Channels (Manual Method)

First, press the CH  $\wedge$  or CH  $\vee$  button or the number buttons to select the channel you want to add or delete.

- 1 Press the MENU button. Press the  $\blacktriangle$  or  $\blacktriangledown$  button to select "Channel", then press the ENTER button.

➤ Quick way to access the Adding and Erasing Channels :  
Just press the "ADD/DEL" button on the remote control.

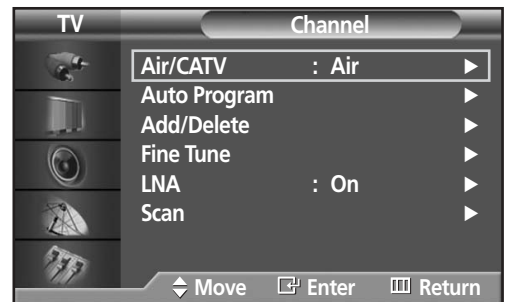

- 2 Press the  $\blacktriangle$  or  $\blacktriangledown$  button to select "Add/Delete", then press the ENTER button. Repeatedly pressing ENTER button will alternate between "Add" and "Delete". Press the CH  $\wedge$  or CH  $\vee$  button to change channels you want to add or delete.

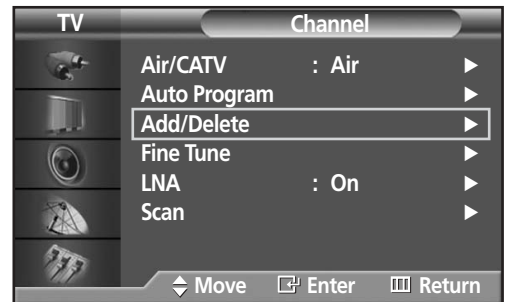

- 3 Press the MENU button to exit.

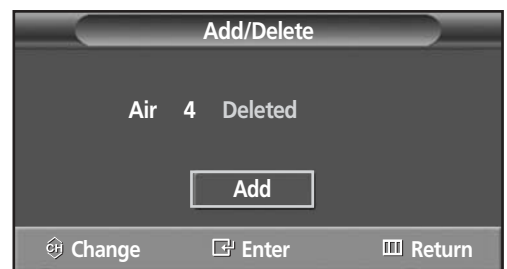

### **Note**

- You can view any channel (including an erased channel) by using the number buttons on the remote control.

## To View Memorized Channels (PIP Mode)

1 Press the MENU button. Press the ▲ or ▼ button to select "Channel", then press the ENTER button.

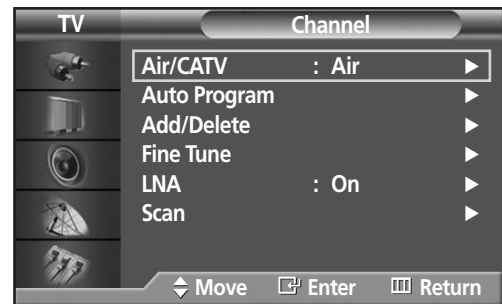

2 Press the ▲ or ▼ button to select "Scan", then press the ENTER button.  
Only the memorized channels are chosen.

- When Channel scan starts, PIP mode will be activated automatically. The screen will remain in PIP mode when the SCAN has finished. Press the PIP button to exit PIP mode.



3 Press the MENU button to stop.

## Changing Channels

### Using the Channel Buttons

Press the CH  $\wedge$  or CH  $\vee$  button to change channels.

*When you press the CH  $\wedge$  or CH  $\vee$  button, the PDP changes channels in sequence. You will see all the channels that the PDP has memorized.*

*(The PDP must have memorized at least three channels.)*

*You will not see channels that were either erased or not memorized.*



### Directly Accessing Channels

Press the number buttons to go directly to a channel. For example, to select channel 27, press "2" then "7". The TV will change channels when you press the second number.

*When you use the number buttons, you can directly select channels that were either erased or not memorized. To change to single-digit channels (0~9) faster, press "0" before the single digit. (For channel "4" press "0", then "4").*



### Using the PRE-CH button to select the previous channel

Press the PRE-CH button. The TV will switch to the last channel viewed.

*To quickly switch between two channels that are far apart, tune to one channel, then use the number button to select the second channel. Then, use the PRE-CH button to quickly alternate between them.*



## Adjusting the Volume

### Using the Volume Buttons

Press the VOL + or VOL - button to increase or decrease the volume.

## Using Mute

### Using the MUTE Buttons

At any time, you can temporarily cut off the sound using the MUTE button.

- 1 Press the MUTE button and the sound cuts off. The word "Mute" will appear in the lower-left corner of the screen.
- 2 To turn mute off, press the MUTE button again, or simply press the VOL + or VOL - button.





# Setting Up Your Remote Control

This PDP's remote control can operate almost any VCR, cable box or DVD. After it has been set up properly, your remote control can operate in four different modes :TV , VCR, Cable, DVD or STB. Pressing the corresponding button on the remote control allows you to switch between these modes, and control whichever piece of equipment you choose.

*Note :*

- The remote control may not be compatible with all DVD Players, VCRs, Cable boxes.
- The remote control can only operate STB made by Samsung.

## Setting Up the Remote to Operate Your VCR, Cable box or DVD player

**1** Turn off your VCR. (or Cable box, DVD player)

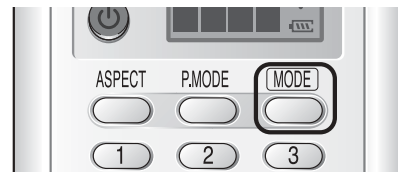

**2** Press the MODE button. The Mode is changed whenever MODE button is pressed.



**3** Press the SET button on your TV's remote control.



**4** Using the number buttons on your remote control, enter three digits of the VCR (or Cable box, DVD player) code listed on page 37 of this manual for your brand of VCR (or CATV, DVD). Make sure you enter three digits of the code, even if the first digit is a "0".  
(If more than one code is listed, try the first one.)

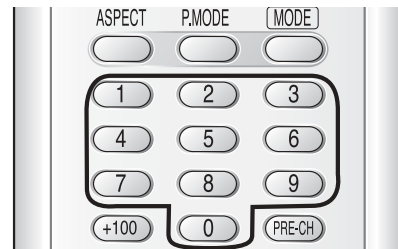

**5** Press the POWER button on the remote control. Your VCR (or CATV, DVD) should turn on if your remote is set up correctly. If your VCR (or CATV, DVD) does not turn on after setup, repeat steps 2, 3, and 4, but try one of the other codes listed for your brand of VCR (or CATV, DVD).  
If no other codes are listed, try each code, 000 through 089 (or Cable box: 000 through 077, DVD player: 000 through 008).

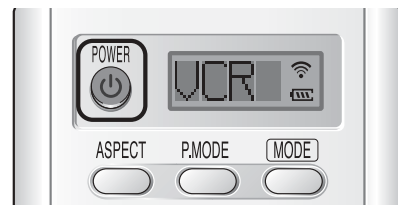

### Notes

- When your remote control is in "VCR" mode, the VCR control buttons (STOP, REW, PLAY/PAUSE, FF) still operate your VCR.
- When your remote control is in "CATV" or "DVD" mode, the VCR control buttons (STOP, REW, PLAY/PAUSE, FF) still operate your VCR.
- You do not need to program the remote for Samsung STBs as the codes are pre-programmed.

# Plasma Display

## Remote Control Codes

### VCR Codes

Brand	Codes	Brand	Codes	Brand	Codes
Admiral	020	JVC	007 008 018 021 026 037	RCA	
Aiwa	025	Kenwood	007 008 018 026 037		017 019 002 021 035 041 043 057 068
Akai	027 004 032	KLH	070	Samsung	000 001 002 003 004 005
Audio Dynamics	007 026	Lloyd	025	Sansui	026
Bell&Howell	018	Logik	038	Sanyo	018 024
Broksonic	022	LXI	025	Scott	003 047 052 067
Candle	002 006 003 015 008 055	Magnavox	021 036 056 059	Sears	018 019 006 024 028 029 041
Canon	021 056	Marantz	008 007 018 021 026 036		048 051
Citizen	002 003 006 008 015 055		037 062	Sharp	020 034 045 015
Colortyme	007	Marta	006	Shimom	027 033 038 058
Craig	002 024	MEI	021	Signature	025
Curtis Mathes	002 017 007 008	Memorex	006 021 024 025	Sony	027 033 044
	021 025 056 064 066	MGA	034	Sylvania	021 025 036 056 059
Daewoo	003 015 010 011 012 013	Midland	005	Symphonic	025
	014 016	Minolta	019 041	Tandy	018 025
DBX	007 026	Mitsubishi	019 034 041 046	Tashika	006
Dimensia	017	Montgomery Ward	020	Tatung	037
Dynatech	034	MTC	002 025	Teac	025 037 068
Emerson	001 003 006 021 022 025	Multitech	002 025 038 005	Technics	021
	030 032 034 040 047 050	NEC	018 007 026 037 008 062 064	Teknika	021 006 025 031
	052 060 063 065 066 067	Optimus	020	TMK	066
	069	Panasonic	021 056 071 072	Toshiba	003 019 029 051 052
Fisher	018 024 028 029 048 051 061	Pentax	019 041	Totevision	002 006
Funai	025	Pentex Research	008	Unitech	002
General Electric	017 002 021	Philco	021 036 056 059	VectorResearch	007 026
	005 056	Philips	021 036	Victor	026
Go Video	002	Pioneer	019 026 039 053	Video Concepts	007 026
LG(Goldstar)	006 007 008 009 010	Portland	015 049 055	Videosonic	002
Harman Kardon	007	PROSCAN	017	Wards	002 003 006 019 020 021
Hitachi	019 025 041 042	Quartz	018		024 025 034 038 041
InstantReplay	021	Quasar	021 056	Yamaha	007 008 018 026 037
JC Penny	002 007 018 019 021	Radio Shack/Realistic		Zenith	023 027 033 073
	026 037 041 054 056		006 018 020 021 024 025 029 034 048 056		

### Cable Box Codes

Brand	Codes	Brand	Codes	Brand	Codes
Anvision	017 018	Philips	019 021 023 028	Sprucer	022
GI	041	Pioneer	018 020 004 044	Stargate 2000	036
Hamlin	003 024 031	RCA	014 022 040	Sylvania	016
Hitachi	025 030	Regal	003	Texscan	016
Jerrold	038 039	Regency	015 023	Tocom	032
Macom	025 030	SA	042 043	Universal	033 034
Magnavox	019 023 028	Samsung	000 001 002 003 004 005	Viewstar	019 021 023 028
Oak	026		006 007	Wamer amex	046
Panasonic	003 022 027 037 044	Scientific Atlanta	042 043	Zenith	017 029 035 037 045

### DVD Codes

Brand	Codes
Samsung	000 001
JVC	002
PROSCAN	003
RCA	003
LG(Goldstar)	006
Sony	007
Denon	008
Curtis Mathes	009

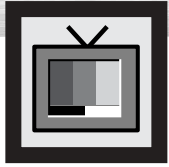

# Viewing an External Signal Source

Use the remote control to switch between viewing signals from connected equipment, such as VCRs, DVD, Set-Top box and the TV source (broadcast or cable).

## Setting the Signal Source

- 1 Press the MENU button. Press the ENTER button to select "Input".

➤ Quick way to access viewing an external signal source :  
Just press the "SOURCE" button on the remote control.



- 2 Press the ENTER button to select "Source List".

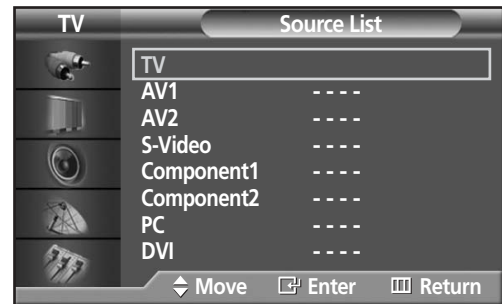

- 3 Press the ▲ or ▼ button to select signal source, then press the ENTER button.

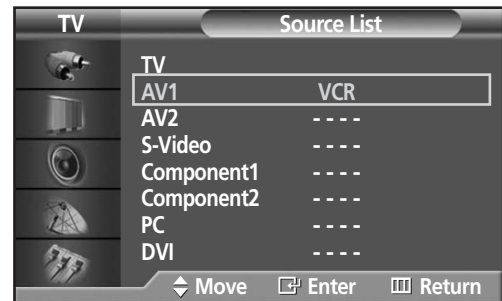

- 4 Press the MENU button to exit.

### Notes

- When you connect equipment to the PDP, you can choose between the following sets of jacks: AV1, AV2, S-Video, Component1, Component2, PC or DVI on the PDP's rear panel.

## Assigning Names to External input mode

**1** Press the MENU button. Press the ENTER button to select "Input".



**2** Press the ▲ or ▼ button to select "Edit Name", then press the ENTER button.

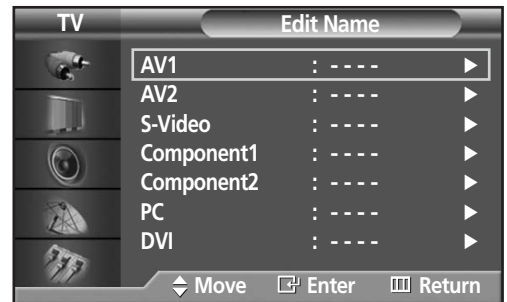

**3** Press the ENTER button. Press the ▲ or ▼ button to select external device, then press the ENTER button.

- You can select the VCR, DVD, Cable STB, HD STB, Satellite STB, AV Receiver, DVD Receiver, Game, Camcorder, DVD Combo, DHR or PC.
- Set other signal sources (AV2, S-Video, Component1, Component2, PC or DVI) using the same method as listed above.

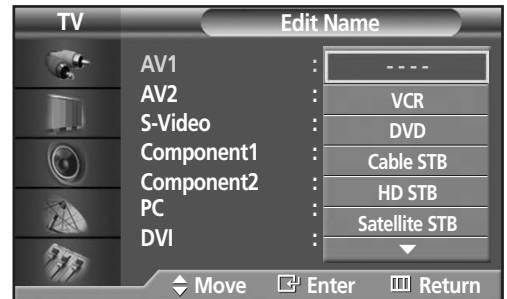

**4** Press the MENU button to exit.

### Notes

- DHR : DVD HDD Recorder





S  
V  
W  
S  
U  
N  
G

P L A S M A   D I S P L A Y   P A N E L

## Picture Control

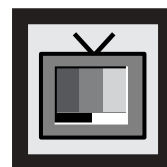

Customizing the Picture .....	42
Using Automatic Picture Settings .....	43
Selecting the Color Tone.....	44
DNle (Digital Natural Image engine) .....	45
Changing the Screen Size .....	46
Freezing the Picture .....	48
Viewing the Picture-in-Picture.....	49
Selecting a Signal Source (Antenna or Cable) for PIP.....	54
Setting the MCC(My Control Color) Mode .....	56

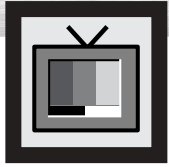

# Customizing the Picture

You can use the on-screen menus to change the Contrast, Brightness, Sharpness, Color, and Tint settings of your PDP.

- 1 Press the MENU button. Press the ▲ or ▼ button to select "Picture", then press the ENTER button.

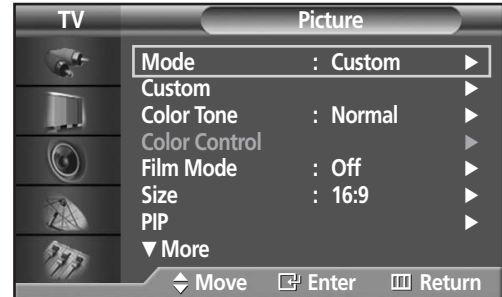

- 2 Press the ▲ or ▼ button to select "Custom", then press the ENTER button. You will also see the items "Contrast", "Brightness", "Sharpness", "Color" and "Tint".



- 3 Press the ▲ or ▼ button to select the item you wish to change, then press the ENTER button. Press the ◀ or ▶ button to change the value of the item.



- 4 Press the MENU button to exit.

## Note

- In the PC/DVI mode, you can't adjust the Color and Tint.

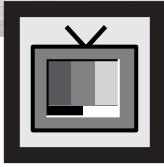

## Using Automatic Picture Settings

Your PDP has automatic picture settings that allow you to adjust the video display easily.

- 1 Press the MENU button. Press the ▲ or ▼ button to select "Picture", then press the ENTER button.

➤ Quick way to access the picture setting: Just press the "P.MODE" button on the remote control.

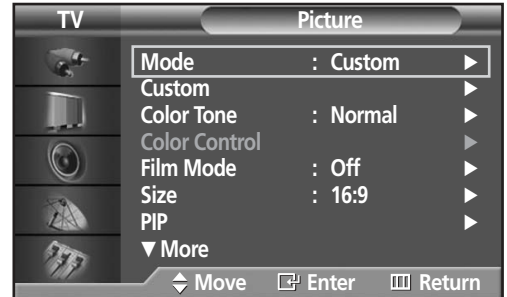

- 2 Press the ENTER button to select "Mode".

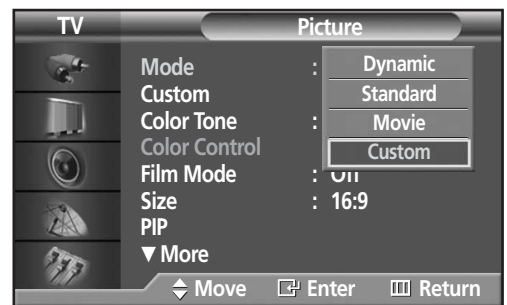

- 3 Press the ▲ or ▼ button to select "Dynamic", "Standard", "Movie", "Custom" picture setting, then press the ENTER button.
  - You can select "Custom", "Entertain", "Internet", or "Text" in PC/DVI mode.

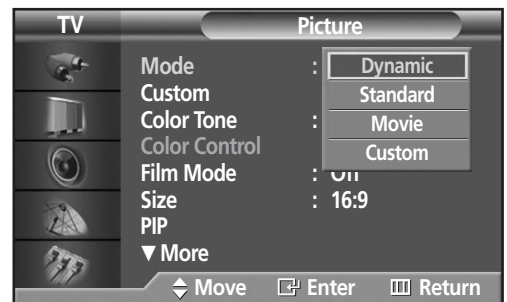

- 4 Press the MENU button to exit.

- Choose Dynamic for viewing the TV during the day or when there is bright light in the room.
- Choose Standard for the standard factory settings.
- Choose Movie when viewing the movie.
- Choose Custom if you want to adjust the settings according to personal preference (see "Customizing the Picture", page 42).

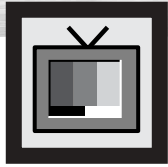

# Selecting the Color Tone

1 Press the MENU button. Press the ▲ or ▼ button to select "Picture", then press the ENTER button.

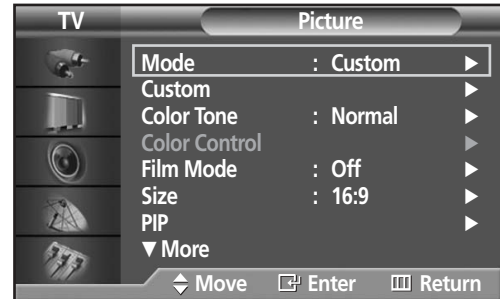

2 Press the ▲ or ▼ button to select "Color Tone", then press the ENTER button.

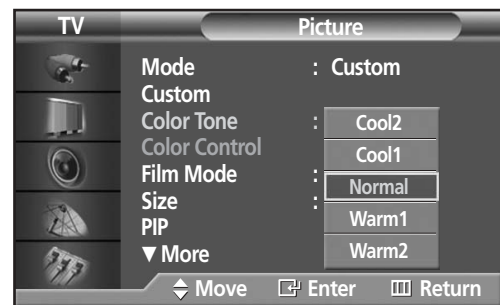

3 Press the ▲ or ▼ button to select "Cool2", "Cool1", "Normal", "Warm1" or "Warm2", then press the ENTER button.

- You can select "Custom", "Cool", Normal" or "Warm" in PC mode.
- You can select "Cool", "Normal" or "Warm" in DVI mode.

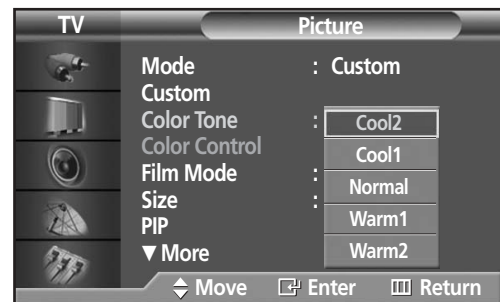

4 Press the MENU button to exit.

# Plasma Display

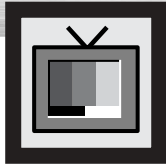

## DNle (Digital Natural Image engine)

Samsung's New Technology brings you more detailed images with contrast, white enhancement and 3D noise reduction.

**1** Press the MENU button. Press the ▲ or ▼ button to select "Picture", then press the ENTER button.

➤ Quick way to select DNle: Simply press the "DNle" button under the cover of the remote control.

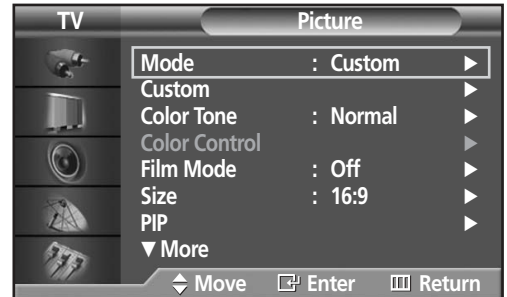

**2** Press the ▲ or ▼ button to select "DNle", then press the ENTER button.

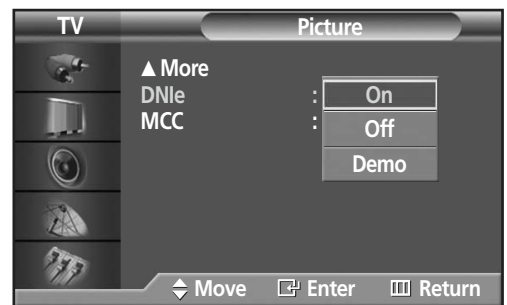

**3** Press the ▲ or ▼ button to select "On", "Off" or "Demo", then press the ENTER button.

- On : Switches on the DNle mode.
- Off : Switches off the DNle mode.
- Demo : The screen before applying DNle appears on the right and the screen after applying DNle appears on the left.

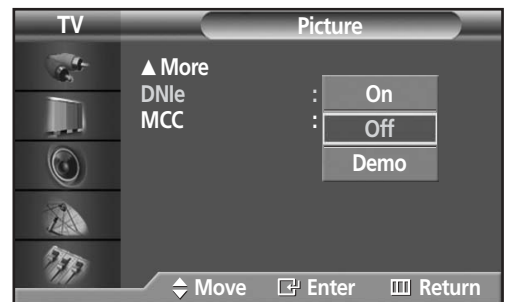

**4** Press the MENU button to exit.

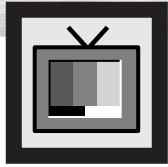

# Changing the Screen Size

Screen size selection depends on the type of video input(DVD, PC etc.).

- 1 Press the MENU button. Press the ▲ or ▼ button to select "Picture", then press the ENTER button.

➤ Quick way to access the Screen Size menu : Just press the "ASPECT" button on the remote control.

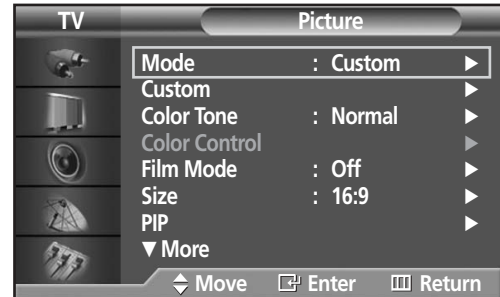

- 2 Press the ▲ or ▼ button to select "Size", then press the ENTER button.

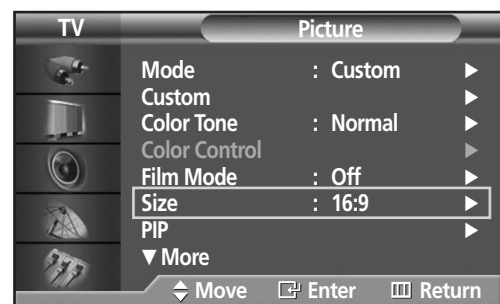

- 3 Press the ▲ or ▼ button to select the screen size you want, then press the ENTER button.

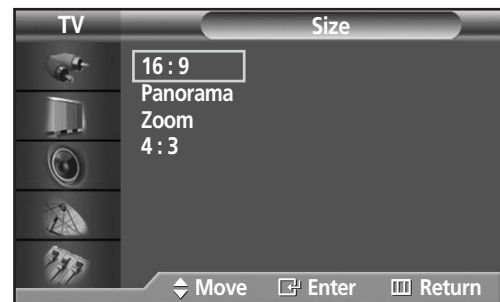

- 4 Press the MENU button to exit.

## Note

- If you watch a still image or the 4:3 (Normal) mode for a long time (over 2 hours), an image may be burned onto the screen.  
View the monitor in 16:9(Wide) or Panorama mode as much as possible.

## 16:9(Wide)

16:9 Aspect Ratio that fits DVD and Wide Screen applications.

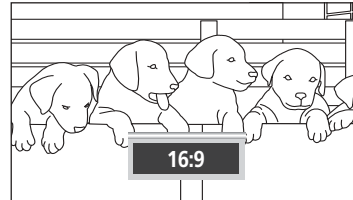

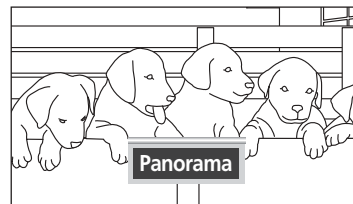

## Panorama

Fits a 16:9 picture onto a 4:3 screen and displays it without clipping the image.



## Zoom

Magnifies the 16:9 wide picture (in a vertical direction) to fit the screen size. Select  by pressing the ◀ or ▶ button. Use the ▲ or ▼ button to move the picture up and down. After selecting , use the ▲ or ▼ button to magnify or reduce the picture size in a vertical direction.

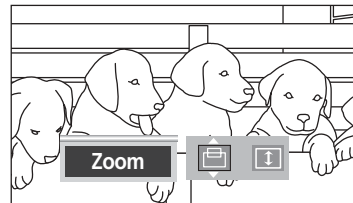

## 4 : 3(Normal)

Standard TV and VCR screen size having a 4:3 Aspect Ratio.

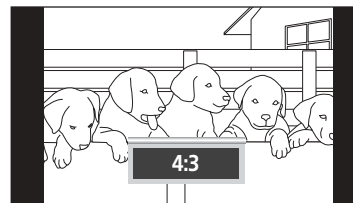

## Notes

- In TV, VIDEO, S-VIDEO and Component (480i) modes, all screen modes can be selected. (16:9 → Panorama → Zoom → 4:3).
- In PC/DVI mode, only 16:9 & 4:3 modes can be selected.
- In Component (480p, 720p, 1080i) modes, Panorama mode can't be selected.
- In Component (480p, 720p, 1080i) modes, you can move the picture on screen by pressing the ▲ or ▼ button. (All screen modes)
- Changing the screen size to Normal, or Zoom during PIP mode will cause the PIP window to disappear.

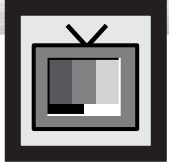

# Freezing the Picture

## Still

Press the STILL button on the remote control to freeze a moving picture. Press again to cancel.

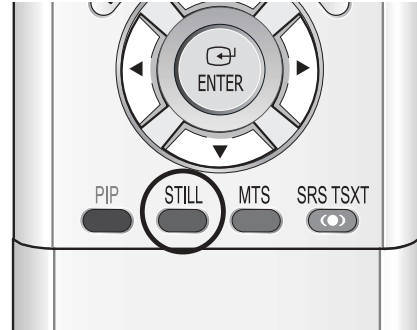





## Viewing the Picture-in-Picture

### Selecting the PIP Screen

**1** Press the MENU button. Press the ▲ or ▼ button to select "Picture", then press the ENTER button.

- Quick way to access the PIP mode: Just press the "PIP" button on the remote control.
- For further information on "Sound Select", refer to page 67.

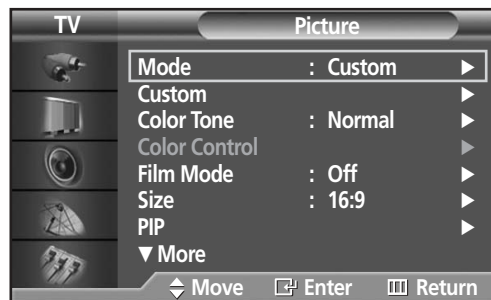

**2** Press the ▲ or ▼ button to select "PIP", then press the ENTER button.

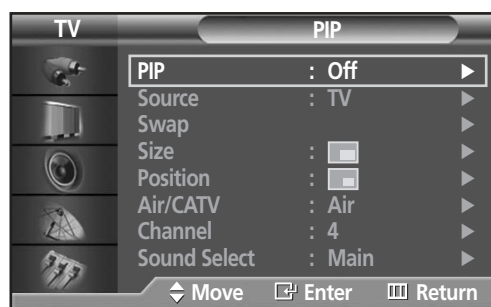

**3** Press the ENTER button, then press the ▲ or ▼ button to select "On". The PIP image will appear in the corner of the screen.

- Pressing the ▲ or ▼ button will alternate between "On" and "Off".

#### Note

- Check if the V-Chip Lock (refer to page 101) is ON if the PIP On/Off will not function. PIP does not function when the V-Chip Lock is set to On. Change the setting to Off and try it again.

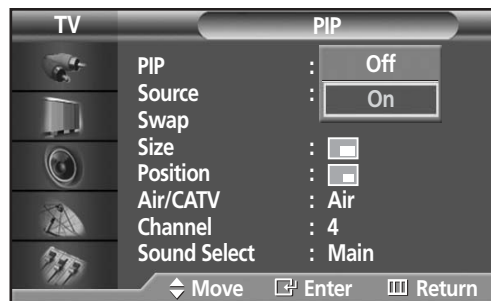

**4** Press the MENU button to exit.

### PIP Settings

○ : PIP and Swap Operate  
X : PIP doesn't Operate

Main screen \ PIP screen	TV	AV 1	AV 2	S-Video	Component 1	Component 2	PC	DVI
TV	○	○	○	○	○	○	○	○
AV 1	○	X	○	○	○	○	○	○
AV 2	○	○	X	○	○	○	○	○
S-Video	○	○	○	X	○	○	○	○
Component 1	○	○	○	○	X	X	X	X
Component 2	○	○	○	○	X	X	X	X
PC	○	○	○	○	X	X	X	X
DVI	○	○	○	○	X	X	X	X

# Selecting an External Signal

You can use PIP to view a signal from an external source, such as a VCR.

1 Press the MENU button. Press the ▲ or ▼ button to select "Picture", then press the ENTER button.

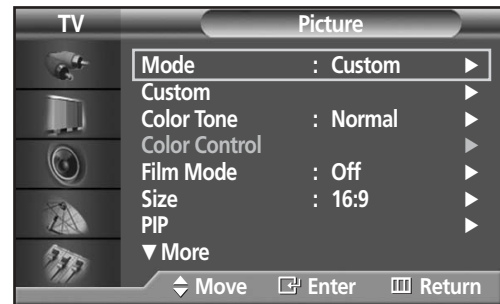

2 Press the ▲ or ▼ button to select "PIP", then press the ENTER button.

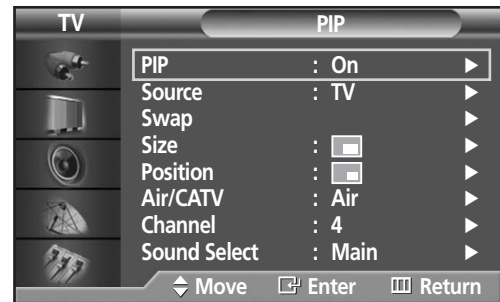

3 Press the ▲ or ▼ button to select "Source", then press the ENTER button.

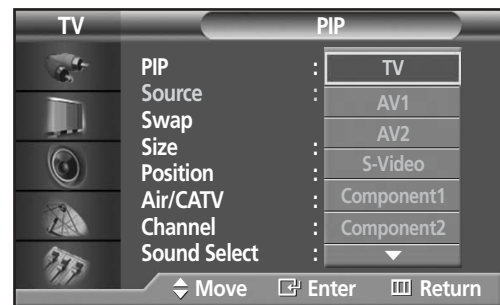

4 Press the ▲ or ▼ button to cycle through all of the available signal sources: "TV", "AV1", "AV2", "S-Video", "Component1", "Component2", "PC" and "DVI".

The signal from these inputs will not appear if you have not connected any equipment to the PDP's respective input jacks.

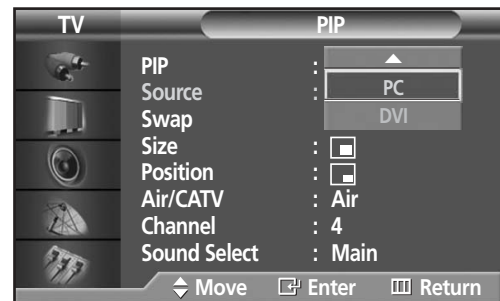

5 Press the MENU button to exit.

## Note

- The PIP function operates in Wide screen.
- Using Multi-Screen in the Normal (4:3) or Zoom screen will change the size of the main screen to Wide screen.

## Swapping the Contents of the PIP and Main Image

**1** Press the MENU button. Press the ▲ or ▼ button to select "Picture", then press the ENTER button.

➤ Quick way to access swapping: Just press the "SWAP" button under the cover of the remote control.

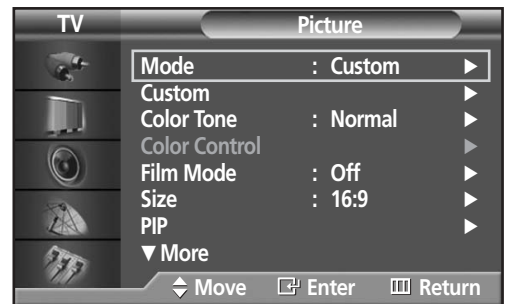

**2** Press the ▲ or ▼ button to select "PIP", then press the ENTER button.

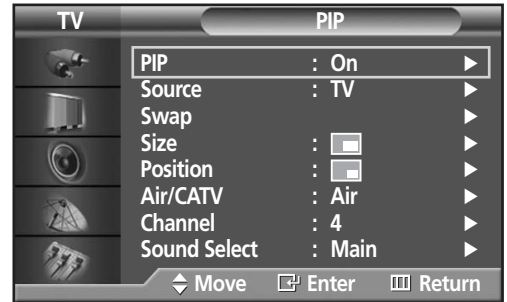

**3** Press the ▲ or ▼ button to select "Swap", then press the ENTER button.

- The image in the PIP window will appear on the main screen, and vice versa.

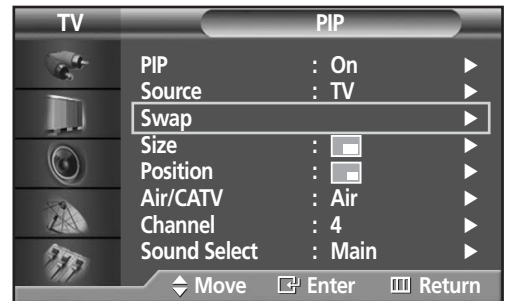

**4** Press the MENU button to exit.

## Changing the Size of the PIP Window

**1** Press the MENU button. Press the ▲ or ▼ button to select "Picture", then press the ENTER button.

➤ Quick way to access PIP size: Just press the "SIZE" button under the cover of the remote control.

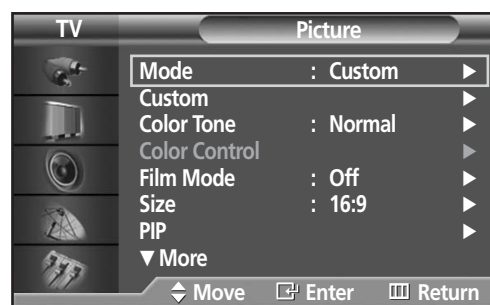

**2** Press the ▲ or ▼ button to select "PIP", then press the ENTER button.

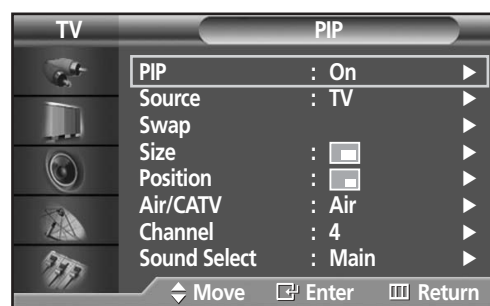

**3** Press the ▲ or ▼ button to select "Size", then press the ENTER button.

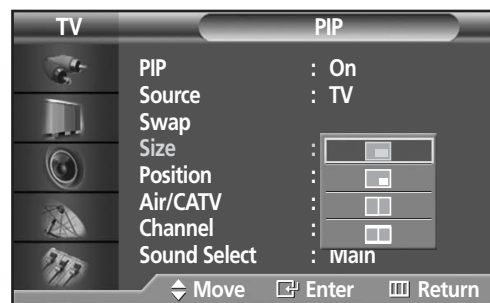

**4** Press the ▲ or ▼ button to select option you want, then press the ENTER button.

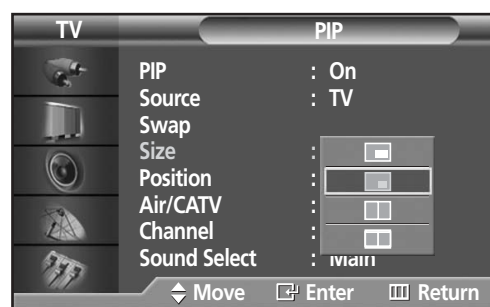

**5** Press the MENU button to exit.

## Changing the Location of the PIP Image

1 Press the MENU button. Press the ▲ or ▼ button to select "Picture", then press the ENTER button.

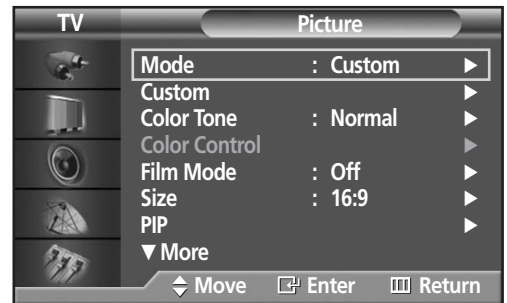

2 Press the ▲ or ▼ button to select "PIP", then press the ENTER button.

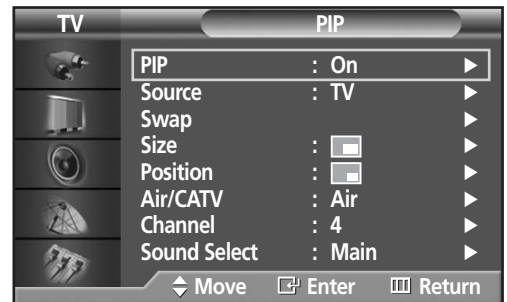

3 Press the ▲ or ▼ button to select "Position", then press the ENTER button.

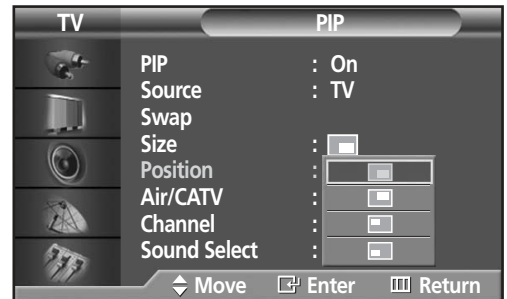

4 Press the ▲ or ▼ button to select the PIP position you want, then press the ENTER button.

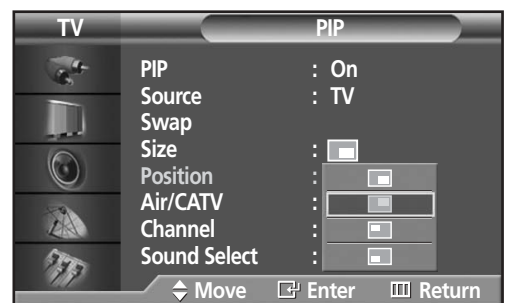

5 Press the MENU button to exit.

### Note

- The Double 1 ( ) or Double 2 ( ) mode can not be selected in position.

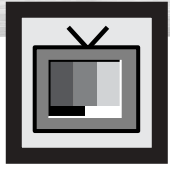

# Selecting a Signal Source (Antenna or Cable) for PIP

If the PIP source is TV while PIP is ON, you can select a different broadcasting source for the PIP picture from the main picture.

- 1 Press the MENU button. Press the ▲ or ▼ button to select "Picture", then press the ENTER button.

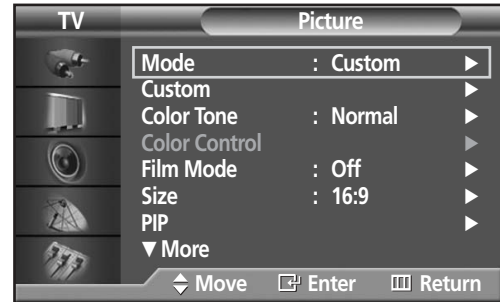

- 2 Press the ▲ or ▼ button to select "PIP", then press the ENTER button.

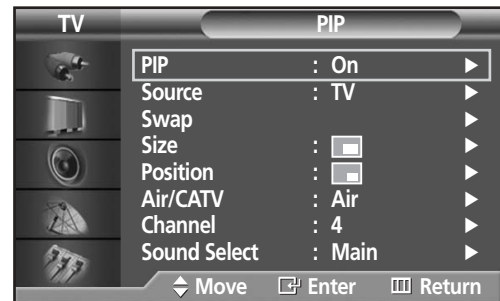

- 3 Press the ▲ or ▼ button to select "Air/CATV", then press the ENTER button.

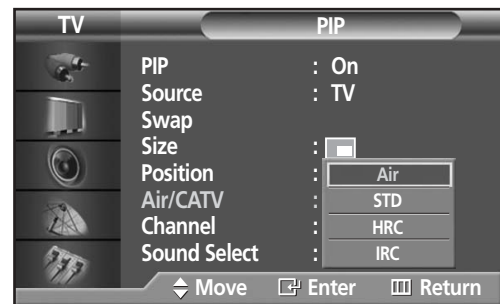

- 4 If an antenna is connected, the setting is "Air". If a Cable TV system is providing the signal, press the ▲ or ▼ button until the appropriate type of cable system is selected ("STD", "HRC" or "IRC").

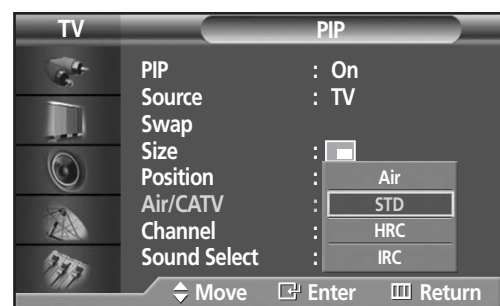

- 5 Press the MENU button to exit the menu.

## Changing the PIP Channel

**1** Press the MENU button. Press the ▲ or ▼ button to select "Picture", then press the ENTER button.

➤ Quick way to change the PIP channel: Just press the "CH▲" or "CH▼" button under the cover of the remote control.

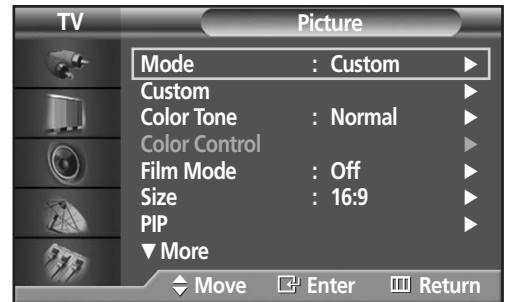

**2** Press the ▲ or ▼ button to select "PIP", then press the ENTER button.

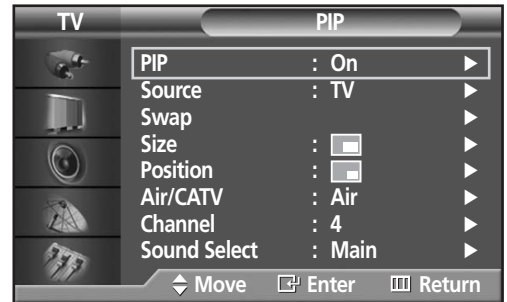

**3** Press the ▲ or ▼ button to select "Channel", then press the ENTER button.

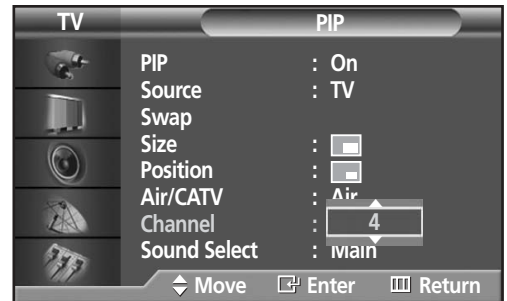

**4** Press the ▲ or ▼ button to change the channel that appears in the PIP window.

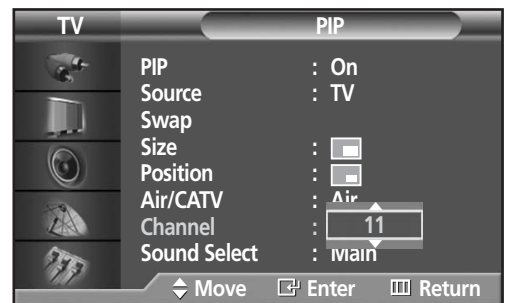

**5** Press the MENU button to exit.

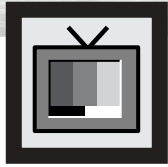

# Setting the MCC(My Control Color) Mode

MCC (My Color Control) Modes:

MCC allows users to adjust colors to according to their preferences, by adjusting skin, sky, and grass tones using the predefined settings (Standard, Custom, Turkish Blue, Emerald Green, Indian Pink) without affecting other colors on the screen.

## Using the MCC Function in the Easy Control Menu

Skin, sky and grass tones are easily adjustable to suit your preferences.

1 Press the MENU button. Press the ▲ or ▼ button to select "Picture", then press the ENTER button.

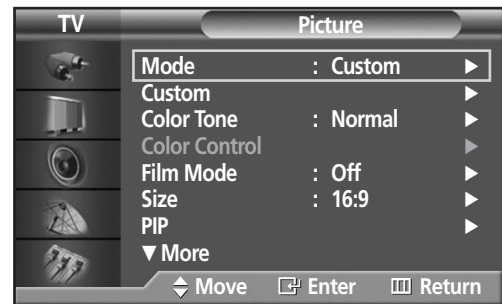

2 Press the ▲ or ▼ button to select "MCC", then press the ENTER button.

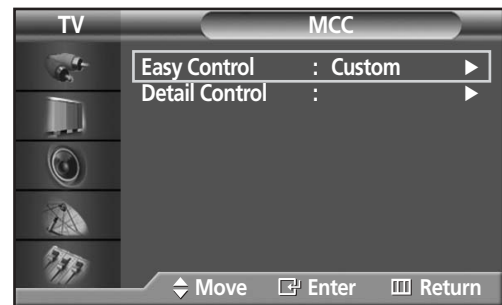

3 Press the ▲ or ▼ button to select "Easy Control", then press the ENTER button.

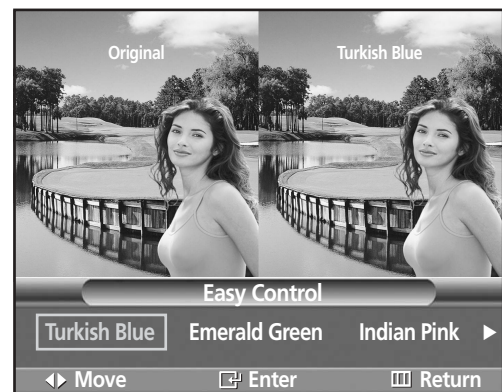

4 Press the ◀ or ▶ button to select among the various picture settings. The original picture (before adjustment) is shown on the left side, while the selected mode is shown on the right side.

➤ There are five MCC modes: Standard, Custom, Turkish Blue, Emerald Green and Indian Pink.

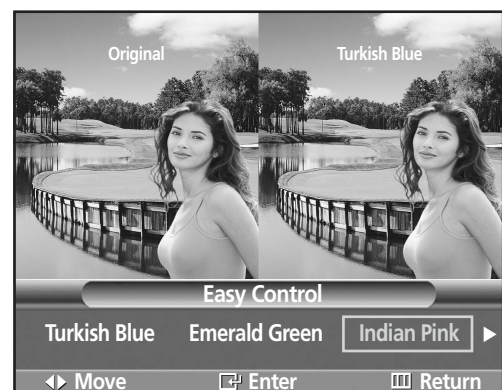

5 Press the MENU button to exit the menu.



## MCC Mode Characteristics

Using MCC Mode, you can enjoy vivid colors as shown below.



➤ Standard Picture.



➤ Emphasizes Clear Blues.

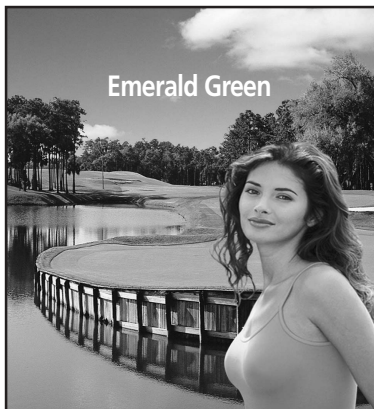

➤ Emphasizes Mild Greens.

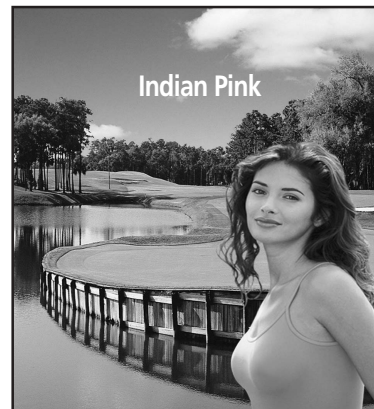

➤ Emphasizes Warm Skin Colors.

### **Note**

- Images shown above may differ from the actual adjustment on the screen. These images are presented for illustrative purposes.

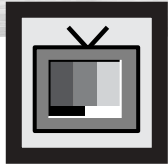

# Setting the MCC(My Control Color) Mode

## MCC Custom Settings

Users can adjust the 3 MCC colors (Skin, Sky, and Grass Tones).

1 Press the MENU button. Press the ▲ or ▼ button to select "Picture", then press the ENTER button.

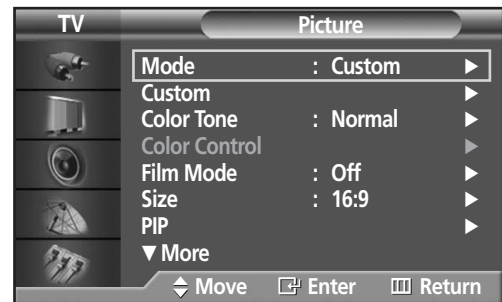

2 Press the ▲ or ▼ button to select "MCC", then press the ENTER button.

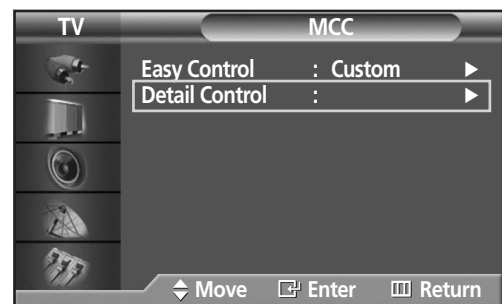

3 Press the ▲ or ▼ button to select "Detail Control", then press the ENTER button.

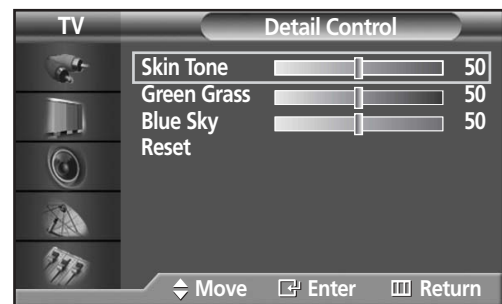

4 Press the ▲ or ▼ button to select the desired MCC color and then press the ENTER or ► button.

➤ The original picture (before adjustment) is shown on the left side, while the picture after adjustment is shown on the right side, and an adjustment bar on the bottom of the screen.

5 Press the ◀ or ▶ button to adjust the settings. Press the ▲ or ▼ button to choose other MCC colors.

6 Press the ENTER or MENU button to confirm the changes and return to the previous menu.



## Resetting the MCC Colors to the Factory Defaults

To return to the factory default settings for MCC colors, use the Reset function.

**1** Press the MENU button. Press the ▲ or ▼ button to select "Picture", then press the ENTER button.

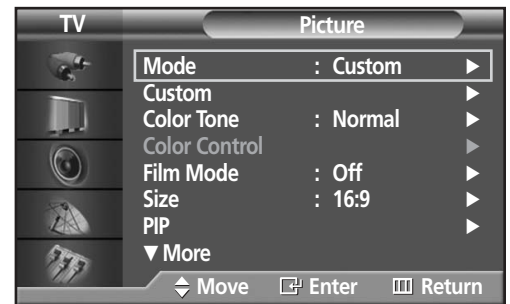

**2** Press the ▲ or ▼ button to select "MCC", then press the ENTER button.

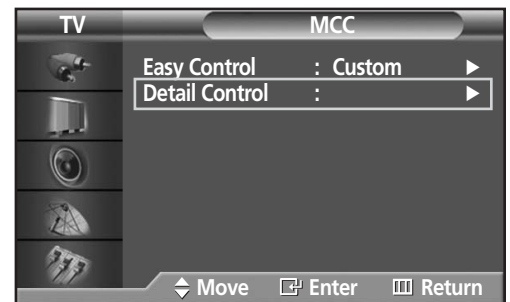

**3** Press the ▲ or ▼ button to select "Detail Control", then press the ENTER button.

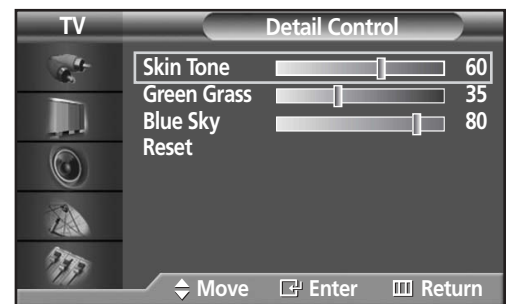

**4** Press the ▲ or ▼ button to select "Reset" and press the ENTER button.

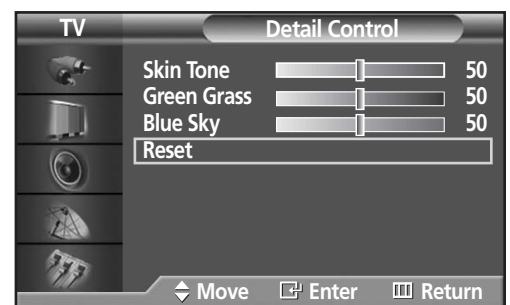

**5** The previously adjusted MCC Colors will be reset to the factory defaults. (The default value for MCC colors is 50.)



S  
V  
W  
S  
U  
N  
G

P L A S M A   D I S P L A Y   P A N E L

## Sound Control



Customizing the Sound .....	62
Using Automatic Sound Settings .....	63
Choosing a Multi-Channel Sound (MTS) Soundtrack .....	64
Using the Auto Volume .....	65
Setting the TruSurround XT .....	66
Listening to the Sound of the Sub(PIP) Picture .....	67
Selecting the Internal Mute .....	68



# Customizing the Sound

- 1 Press the MENU button. Press the ▲ or ▼ button to select "Sound", then press the ENTER button.

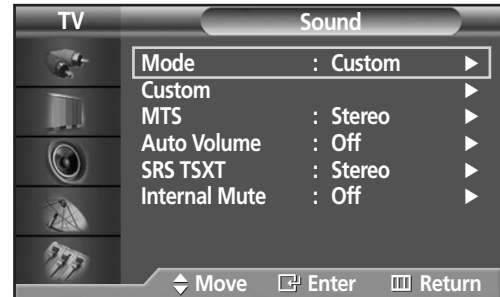

- 2 Press the ▲ or ▼ button to select "Custom", then press the ENTER button.

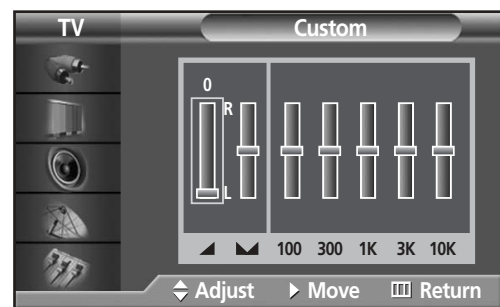

- 3 Select the option (volume, balance, equalizer) to be adjusted by pressing the ◀ or ▶ button. Press the ▲ or ▼ button to adjust the setting.

- 4 Press the MENU button to exit.

- If you make any changes to the equalizer settings, the sound Mode is automatically switched to the custom mode.



## Using Automatic Sound Settings

1 Press the MENU button. Press the ▲ or ▼ button to select "Sound", then press the ENTER button.

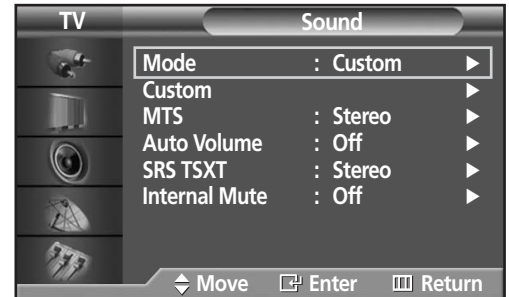

2 Press the ENTER button to select "Mode".

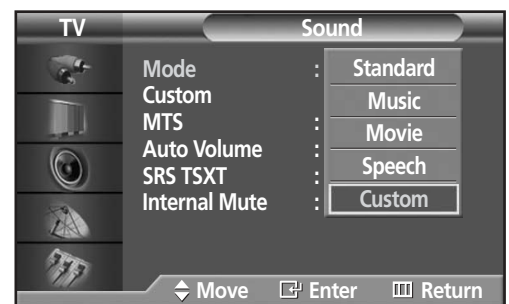

3 Press the ▲ or ▼ button to select "Standard", "Music", "Movie", "Speech" or "Custom" sound setting, then press the ENTER button.

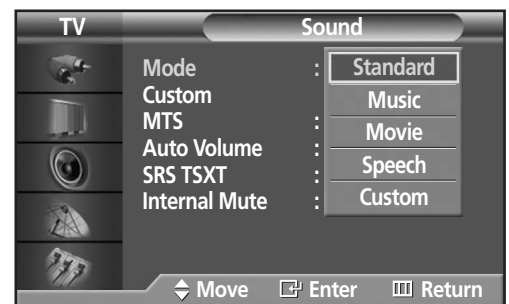

4 Press the MENU button to exit.

- Choose Standard for the standard factory settings.
- Choose Music when watching music videos or concerts.
- Choose Movie when watching movie.
- Choose Speech when watching a show that is mostly dialogue (i.e., news).
- Choose Custom to recall your personalized settings. (see "Customizing the Sound", page 62).



# Choosing a Multi-Channel Sound (MTS) Soundtrack

Depending on the particular program being broadcast, you can listen to stereo, mono, or a Separate Audio Program. (SAP audio is usually a foreign-language translation. Sometimes SAP has unrelated information like news or weather.)

1 Press the MENU button. Press the ▲ or ▼ button to select "Sound", then press the ENTER button.

➤ Quick way to access the MTS menu: Just press the "MTS" button on the remote control.

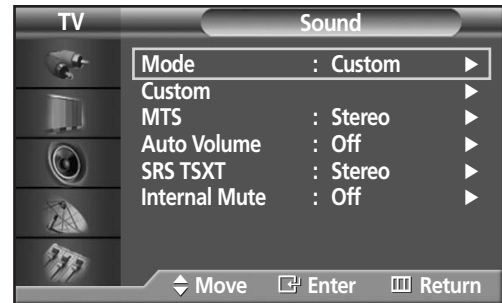

2 Press the ▲ or ▼ button to select "MTS", then press the ENTER button.

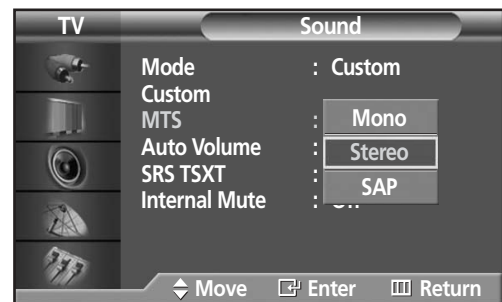

3 Press the ▲ or ▼ button to select "Mono", "Stereo" or "SAP", then press the ENTER button.

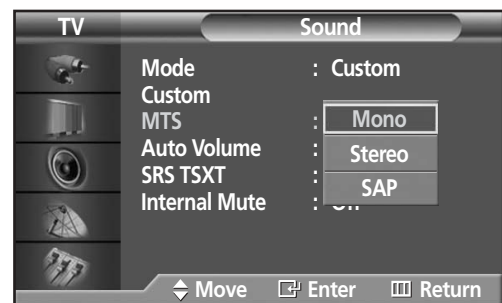

4 Press the MENU button to exit.

- Choose *Stereo* for channels that are broadcasting in stereo.
- Choose *Mono* for channels that are broadcasting in mono, or if you are having difficulty receiving a stereo signal.
- Choose *SAP* to listen to the Separate Audio Program, which is usually a foreign-language translation.

## Note

- The MTS function operates in TV mode only.





## Using the Auto Volume

Each broadcasting station has its own signal conditions, which can make it necessary to adjust the volume every time the channel is changed. "Auto volume" lets you automatically adjust the volume of the desired channel by lowering the sound output when the modulation signal is high or by raising the sound output when the modulation signal is low.

- 1 Press the MENU button. Press the ▲ or ▼ button to select "Sound", then press the ENTER button.

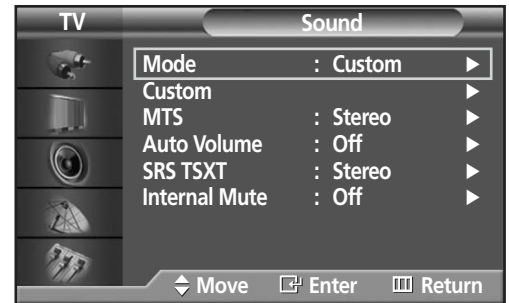

- 2 Press the ▲ or ▼ button to select "Auto Volume", then press the ENTER button.

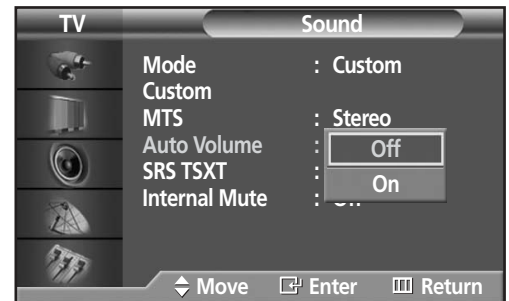

- 3 Press the ▲ or ▼ button to select "On", then press the ENTER button.
  - Pressing the ▲ or ▼ button will alternate between "On" and "Off".

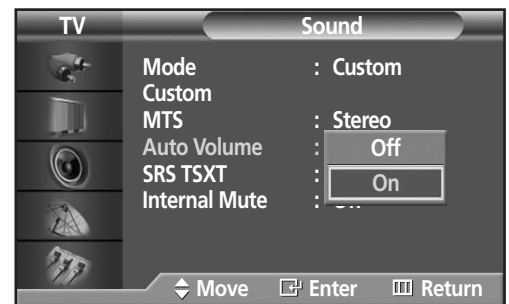

- 4 Press the MENU button to exit.



# Setting the TruSurround XT

TruSurround XT is a patented SRS technology that solves the problem of playing 5.1 multichannel content over two speakers. Trusurround delivers a compelling, virtual surround sound experience through any two-speaker playback system, including internal television speakers. It is fully compatible with all multichannel formats.

**1** Press the MENU button. Press the ▲ or ▼ button to select "Sound", then press the ENTER button.

➤ Quick way to access the TruSurround XT menu: Just press the "SRS TSXT" button on the remote control.

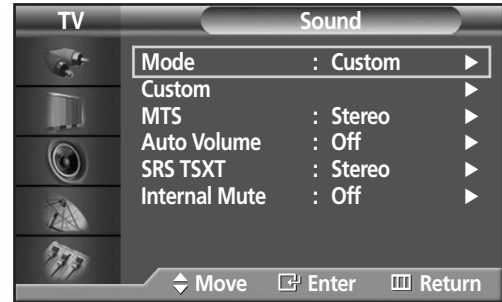

**2** Press the ▲ or ▼ button to select "SRS TSXT", then press the ENTER button.

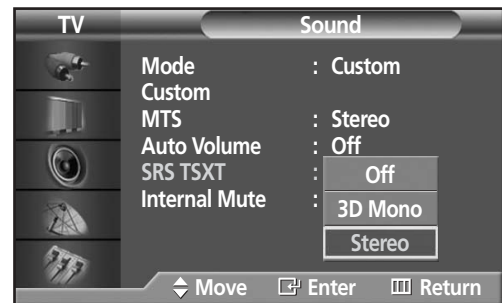

**3** Press the ▲ or ▼ button to change the setting (Off, 3D Mono or Stereo), then press the ENTER button.

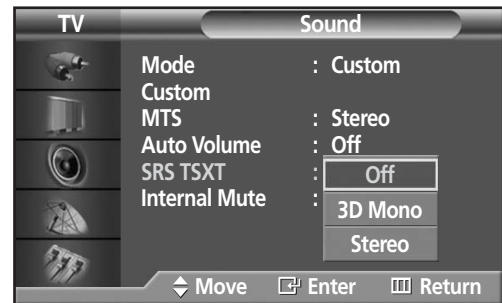

**4** Press the MENU button to exit.

➤ TruSurround XT, SRS and ( ●● ) Symbol are trademarks of SRS Labs, Inc. TruSurround XT technology is incorporated under license from SRS Labs, Inc.

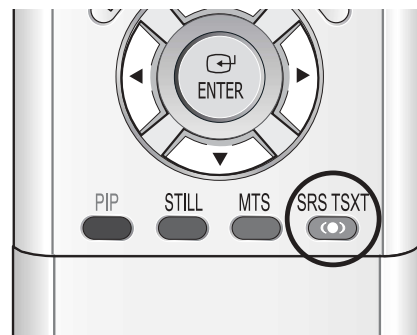



## Listening to the Sound of the Sub(PIP) Picture

When the PIP feature is activated, you can listen to the sound of the sub picture.

- 1 Press the MENU button. Press the ▲ or ▼ button to select "Picture", then press the ENTER button.

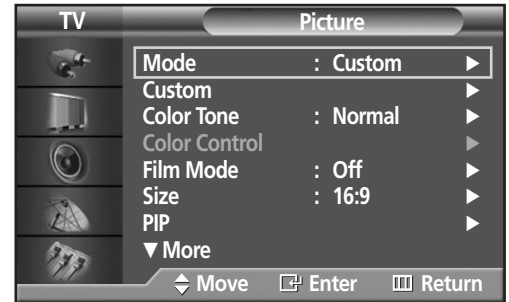

- 2 Press the ▲ or ▼ button to select "PIP", then press the ENTER button.

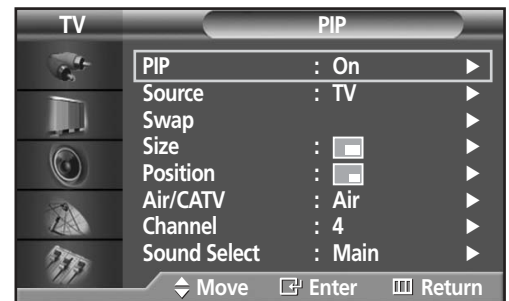

- 3 Press the ▲ or ▼ button to select "Sound Select", then press the ENTER button.
  - Pressing the ▲ or ▼ button will alternate between "Main" and "Sub".

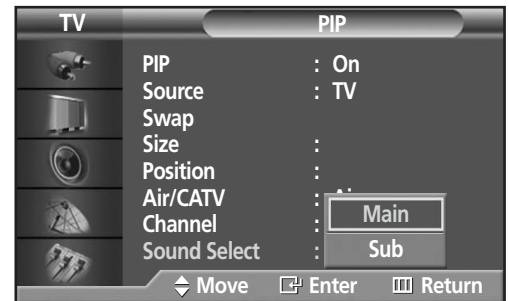

- 4 Set to Sub by pressing the ▲ or ▼ button.
  - You can listen to the sound of the sub picture.
  - To listen the sound of the main picture, set to Main.

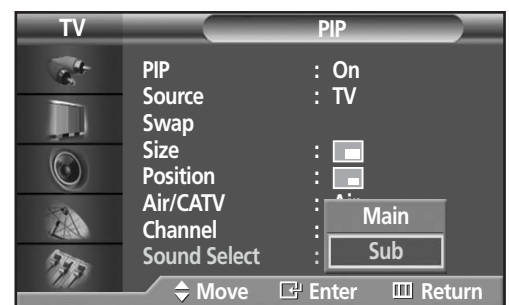



# Selecting the Internal Mute

The internal speakers can be muted in order to hear sound from external speakers you've connected.

1 Press the MENU button. Press the ▲ or ▼ button to select "Sound", then press the ENTER button.

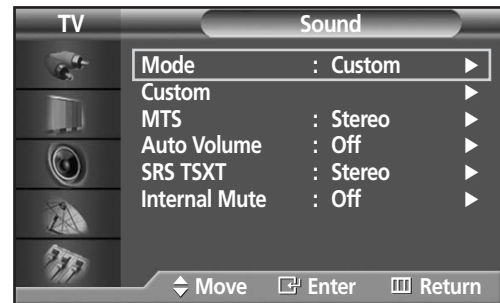

2 Press the ▲ or ▼ button to select "Internal Mute", then press the ENTER button.

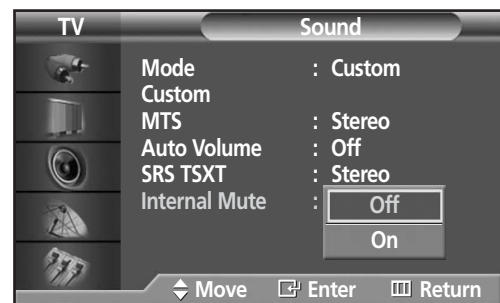

3 Press the ▲ or ▼ button to select "On", then press the ENTER button.

- Pressing the ▲ or ▼ button will alternate between "On" and "Off".

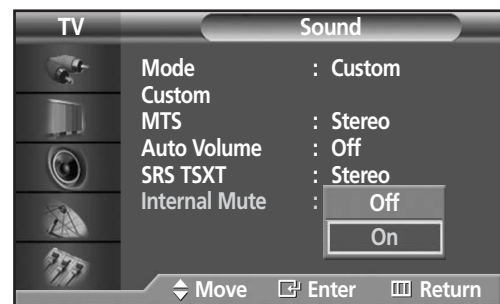

4 Press the MENU button to exit.

S  
M  
W  
S  
U  
N  
G

P L A S M A   D I S P L A Y   P A N E L

## Channel Control



Fine Tuning Channels.....	70
LNA (Low Noise Amplifier).....	71



# Fine Tuning Channels

Use fine tuning to manually adjust a particular channel for optimal reception.

1 Press the MENU button. Press the ▲ or ▼ button to select "Channel", then press the ENTER button.



2 Press the ▲ or ▼ button to select "Fine Tune", then press the ENTER button.

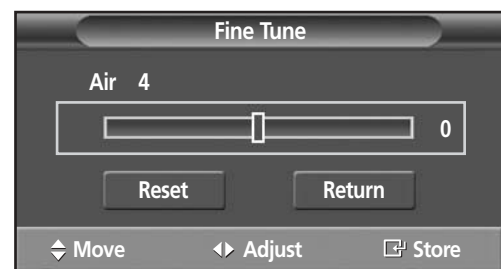

3 Press the ◀ or ▶ button to adjust the fine tuning.

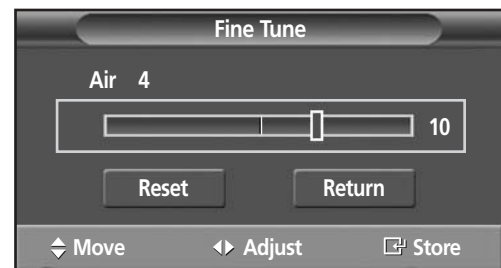

4 To store the fine tuning setting in the TV's memory, press the ENTER button. (A star icon(\*) will appear.) To reset the fine tuning to "0", press the ▼ button to select "Reset", then press the ENTER button.

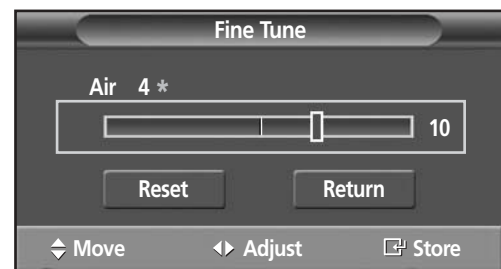

5 Press the MENU button to exit.

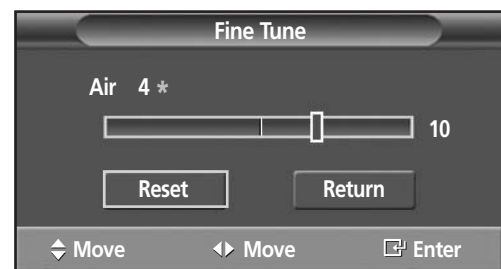

**CH**

## LNA (Low Noise Amplifier)

If the TV is operating in a weak-signal area, sometimes the LNA function can improve the reception (a low-noise preamplifier boosts the incoming signal).

- 1 Press the MENU button. Press the ▲ or ▼ button to select "Channel", then press the ENTER button.

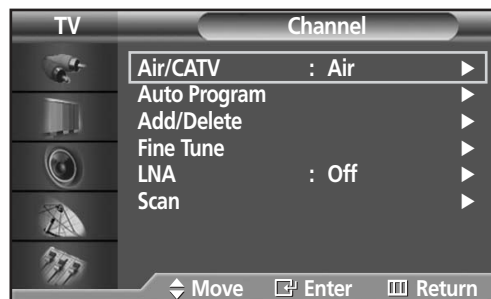

- 2 Press the ▲ or ▼ button to select "LNA", then press the ENTER button.



- 3 Press the ▲ or ▼ button to select "On", then press the ENTER button.
  - Pressing the ▲ or ▼ button will alternate between "On" and "Off".



- 4 Press the MENU button to exit.





S  
M  
W  
S  
U  
N  
G

P L A S M A   D I S P L A Y   P A N E L

## Connecting a PC and Operation



Connecting a PC.....	74
Adjusting the PC Screen.....	78
Changing the Position of the Image.....	79
Picture Quality Adjustment .....	80
Information .....	83



# Connecting a PC

Connection to a Macintosh computer may require an adapter.

## PDP

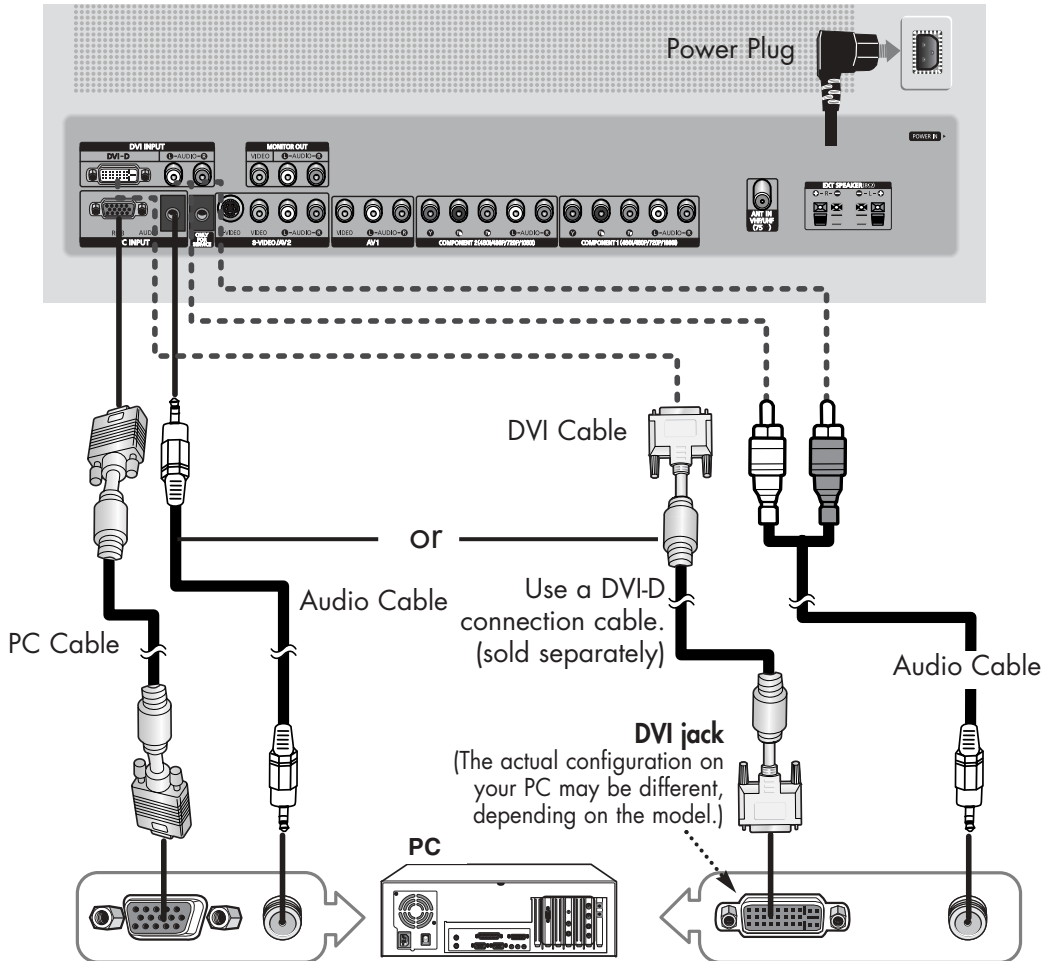

## Connecting a PC (15p D-SUB) to the PDP

- 1 Connect a PC cable between the PC Output jack on the PC and the RGB input jack on the PDP.
- 2 Connect a Audio cable between the Audio jack on the PC and the Audio input jacks (PC INPUT) on the PDP.

## Connecting a PC (DVI) to the PDP

- 1 Connect a DVI cable between the PC DVI jack on the PC and the DVHD input jack on the PDP.
- 2 Connect a Audio cable between the Audio jack on the PC and the Audio L/R input (DVI INPUT) jacks on the PDP.

### To watch the PC screen:

1. Turn on your PDP.
2. Press the SOURCE button on the remote control or SOURCE button on the front panel to select "PC".
3. Turn on your PC and check for PC system requirements. (Refer to pages 76 and 77 for PC system requirements.)
4. Adjust the PC screen. (Refer to pages 78 and 80.)

## Pin Configuration

### D-Sub Cable

- 15Pin Signal Cable (based on protruded pin)

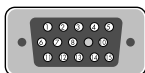

Pin No.	PC IN	PC OUT
1	Red (R)	Red (R)
2	Green (G)	Green (G)
3	Blue (B)	Blue (B)
4	Grounding	Grounding
5	Grounding (DDC)	Grounding (DDC)
6	Red (R) Grounding	Red (R) Grounding
7	Green (G) Grounding	Green (G) Grounding
8	Blue (B) Grounding	Blue (B) Grounding
9	Reserved	Reserved
10	Sync Grounding	Sync Grounding
11	Grounding	Grounding
12	Data (DDC)	Data (DDC)
13	Horizontal sync.	Horizontal sync.
14	Vertical sync.	Vertical sync.
15	Clock (DDC)	Clock (DDC)

### DVI-D Cable (Digital-Only Connector)



Pin No.	Signal Assignment	Pin No.	Signal Assignment
1	T.M.D.S. Data2-	13	T.M.D.S. Data3+
2	T.M.D.S. Data2+	14	+5V Power
3	T.M.D.S. Data2/4 Shield	15	Ground (for +5V)
4	T.M.D.S. Data4-	16	Hot Plug Detect
5	T.M.D.S. Data4+	17	T.M.D.S. Data0-
6	DDC Clock	18	T.M.D.S. Data0+
7	DDC Data	19	T.M.D.S. Data0/5 Shield
8	No Connect	20	T.M.D.S. Data5-
9	T.M.D.S. Data1-	21	T.M.D.S. Data5+
10	T.M.D.S. Data1+	22	T.M.D.S. Clock Shield
11	T.M.D.S. Data1/3 Shield	23	T.M.D.S. Clock+
12	T.M.D.S. Data3-	24	T.M.D.S. Clock-

## Setting up Your PDP (Plug and Play)

Our adoption of the new VESA® Plug and Play solution eliminates complicated and time consuming setup. It allows you to install your monitor in a Plug and Play compatible system, without the usual setup hassles and confusion. Your PC system can easily identify and configure itself for use with your display. This monitor automatically tells the PC system its Extended Display Identification data (EDID) using Display Data Channel (DDC) protocols.

# How to Set up Your PC Software (Windows only)

The Windows display-settings for a typical computer are shown below. However, the actual screens on your PC will probably be different, depending upon your particular version of Windows and your particular video card. Even if your actual screens look different, the same, basic set-up information will apply in almost all cases. (If not, contact your computer manufacturer or Samsung Dealer.)



On the windows screen, select in the following sequence : Start → Settings → Control Panel.



When the control panel screen appears, click on "Display" and a display dialog-box will appear.

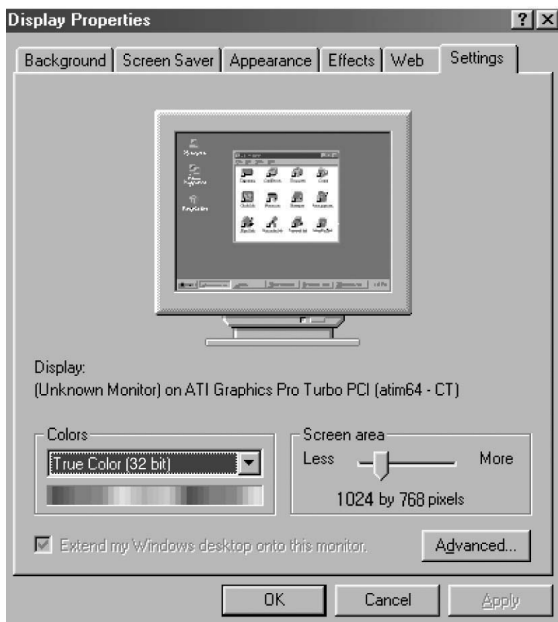

Select the "Settings" tab in the display dialog-box.

The two key variables that apply to the PDP-PC interface are "resolution" and "colors". The correct settings for these two variables are:

- Size (sometimes called "resolution") : 1024 x 768 pixels.
- Color: "32-bit" color  
Shown at left is a typical screen for "Display" dialog box.

If a vertical-frequency option exists on your display settings dialog box, the correct value is "60" or "60 Hz". Otherwise, just click "OK" and exit the dialog box.

Continued...

# Plasma Display

**Notes:**

Both screen position and size will vary, depending on the type of PC monitor and its resolution. The table below shows all of the display modes that are supported:

Video Signal	Resolution (Dot X Line)	Vertical Frequency(Hz)	Horizontal Frequency(KHz)	Vertical Polarity	Horizontal Polarity
IBM PC / AT Compatible	720 X 400	70.087	31.469	P	N
	640 X 480	59.940	31.469	N	N
		72.809	37.861	N	N
		75.000	37.5	N	N
		85.008	43.269	N	N
	800 X 600	56.250	35.156	N/P	N/P
		60.317	37.897	P	P
		72.188	48.077	P	P
		75.000	46.875	P	P
	1024 X 768	85.061	53.674	P	P
		60.004	48.363	N	N
		70.069	56.476	N	N
		75.029	60.023	P	P
		84.997	68.677	P	P
	1280 X 1024	60.020	63.981	P	P

- The interlace mode is not supported.
- The PDP operates abnormally if a non-standard video format is selected.
- The table above conforms to IBM/VESA regulations and is based on using the Analog Input.
- "1280 x 1024" is not available in DVI mode.

**Notes:**

- When this PDP is used as a PC display, 32-bit color is supported.
- Depending on the manufacturer, your PC display screen might appear different. (and depending on your particular version of Windows.)  
Check your PC instruction book for information about connecting your PC to a PDP.
- If a vertical and horizontal frequency-select mode exists, select 60Hz (vertical) and 48.4kHz (horizontal).
- In some cases, abnormal signals (such as stripes) might appear on the screen when the PC power is turned off (or if the PC is disconnected). If so, press the SOURCE button on the remote control or SOURCE button on the front panel to enter the VIDEO mode. Also, make sure that the PC is connected.
- Connect only a PC monitor to the monitor output port while viewing the PC screen. (Otherwise, random signals might appear).



# Adjusting the PC Screen

## Adjusting the R.G.B

### Preset:

- Press the SOURCE button to select "PC".

1 Press the MENU button. Press the ▲ or ▼ button to select "Picture", then press the ENTER button.

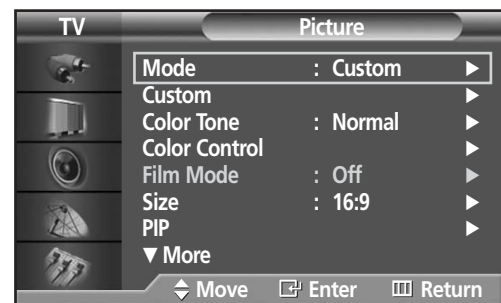

2 Press the ▲ or ▼ button to select "Color Control", then press the ENTER button. The "Color Control" is available only when the "Color Tone" is set to Custom and a PC is connected.

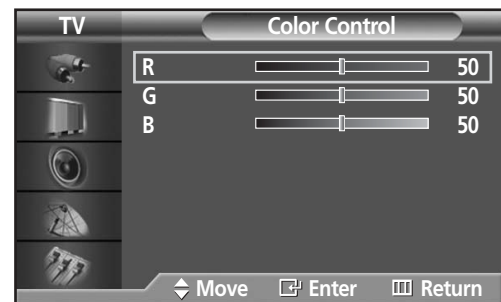

3 Press the ▲ or ▼ button to select the item you want to change, then press the ENTER button. Press the ◀ or ▶ button to change the value of the item, using the on-screen gauge as your guide.



4 Press the MENU button to exit.



## Changing the Position of the Image

After connecting the PDP to your PC, adjust the position of the screen if it is not well-aligned.

### Preset:

- Press the SOURCE button to select "PC."

1 Press the MENU button. Press the ▲ or ▼ button to select "Setup", then press the ENTER button.



2 Press the ▲ or ▼ button to select "PC", then press the ENTER button.

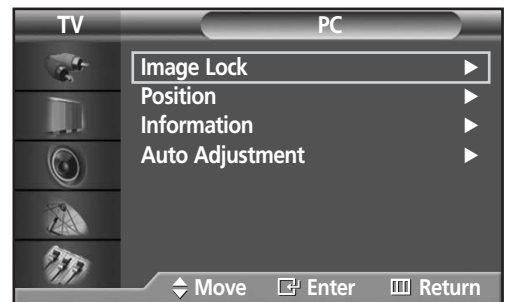

3 Press the ▲ or ▼ button to select "Position", then press the ENTER button.

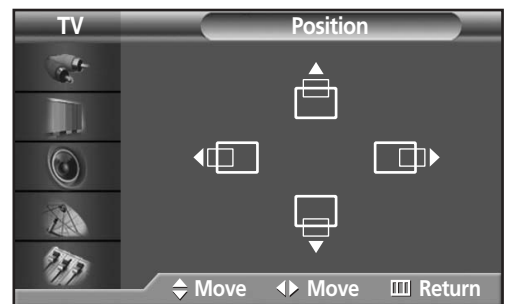

4 Adjust the position of screen by pressing the ▲ / ▼ / ◀ / ▶ button.

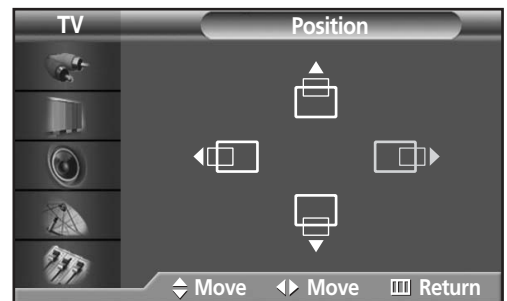

5 Press the MENU button to exit.



# Picture Quality Adjustment

## Picture Automatic Adjustment

### Preset:

- Press the SOURCE button to select "PC".

1 Press the MENU button. Press the ▲ or ▼ button to select "Setup", then press the ENTER button.

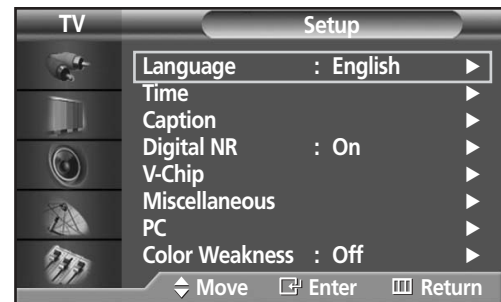

2 Press the ▲ or ▼ button to select "PC", then press the ENTER button.

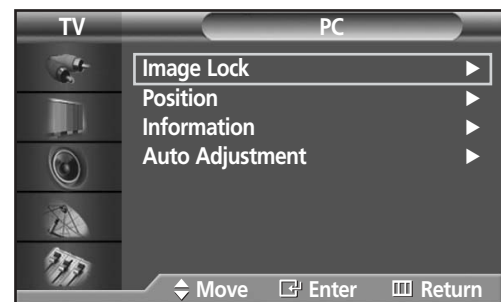

3 Press the ▲ or ▼ button to select "Auto Adjustment", then press the ENTER button. The message "Auto Adjustment in progress." appears on the screen and the picture adjustments are automatically activated.

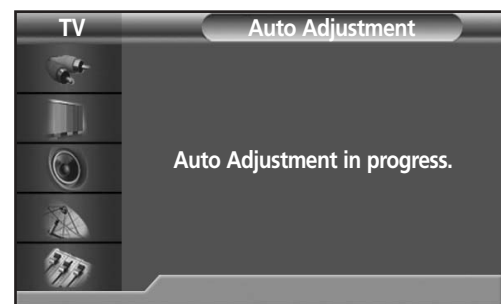

4 Press the MENU button to exit.



## Coarse Adjustment

### Preset:

- Press the SOURCE button to select "PC".

1 Press the MENU button. Press the ▲ or ▼ button to select "Setup", then press the ENTER button.



2 Press the ▲ or ▼ button to select "PC", then press the ENTER button.

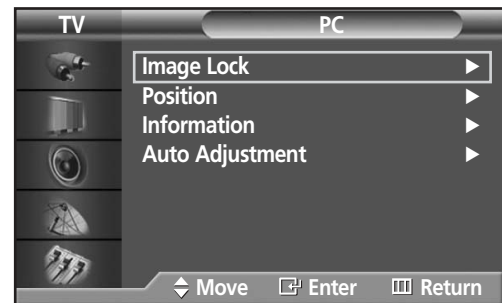

3 Press the ▲ or ▼ button to select "Image Lock", then press the ENTER button.

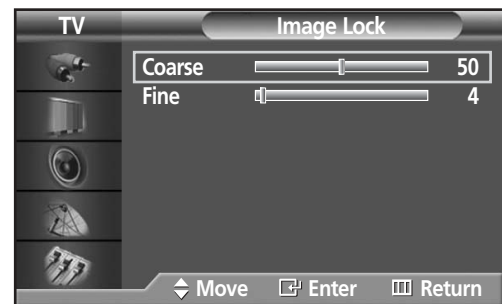

4 Press the ENTER button to select "Coarse".  
Remove picture noise (vertical stripes) on the screen by pressing the ◀ or ▶ button. (If Coarse is not set properly, vertical stripes will appear on the screen.)



5 Press the MENU button to exit.

# Fine Tuning (Fine)

## Preset:

- Press the SOURCE button to select "PC".

1 Press the MENU button. Press the ▲ or ▼ button to select "Setup", then press the ENTER button.



2 Press the ▲ or ▼ button to select "PC", then press the ENTER button.

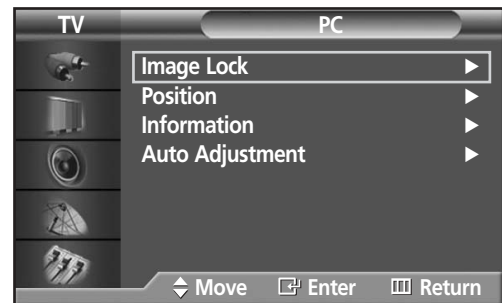

3 Press the ▲ or ▼ button to select "Image Lock", then press the ENTER button.

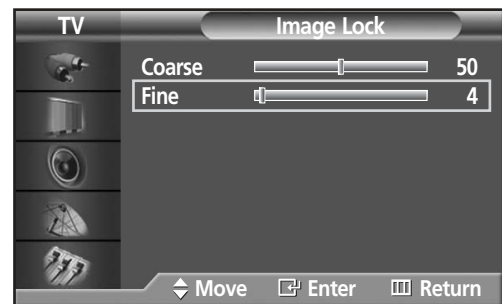

4 Press the ▲ or ▼ button to select "Fine", then press the ENTER button. Remove picture noise on the screen by pressing the ◀ or ▶ button. (If Fine is not set properly, noise will appear on the screen.)



5 Press the MENU button to exit.



## Information

### Preset:

- Press the SOURCE button to select "PC".

1 Press the MENU button. Press the ▲ or ▼ button to select "Setup", then press the ENTER button.



2 Press the ▲ or ▼ button to select "PC", then press the ENTER button.

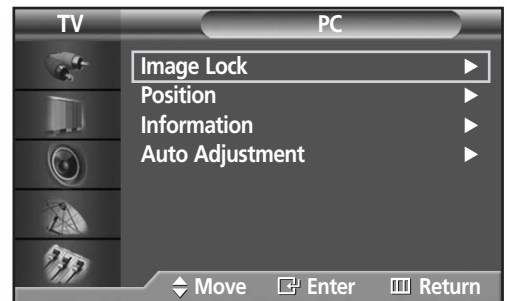

3 Press the ▲ or ▼ button to select "Information", then press the ENTER button. The vertical, horizontal frequencies and resolution appear.

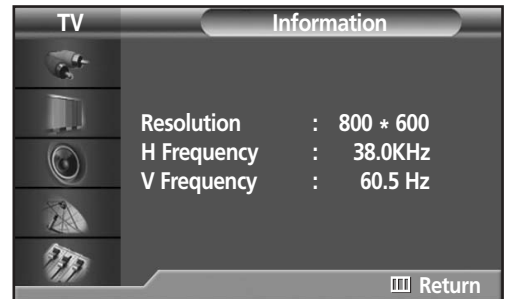

4 Press the MENU button to exit.



P L A S M A   D I S P L A Y   P A N E L

# Time Setting



Setting the Clock .....	86
Setting the Sleep Timer .....	87
Setting the Timers .....	88



# Setting the Clock

1 Press the MENU button. Press the ▲ or ▼ button to select "Setup", then press the ENTER button.



2 Press the ▲ or ▼ button to select "Time", then press the ENTER button.

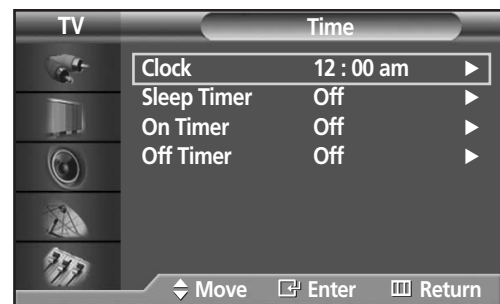

3 Press the ENTER button to select "Clock", then press the ▲ or ▼ button to select correct hour.

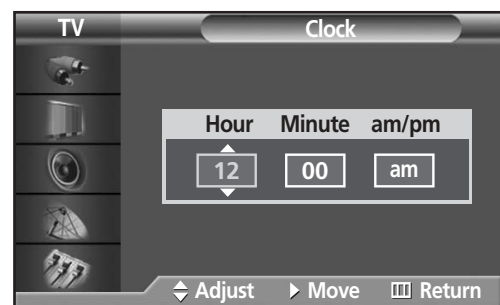

4 Press the ▶ button to select "Minute", then press the ▲ or ▼ button to select correct minute.

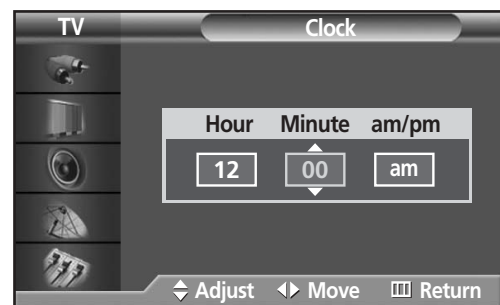

5 Press the ▶ button to select "am/pm", then press the ▲ or ▼ button to select the proper time of day (am or pm). Press the ENTER button.

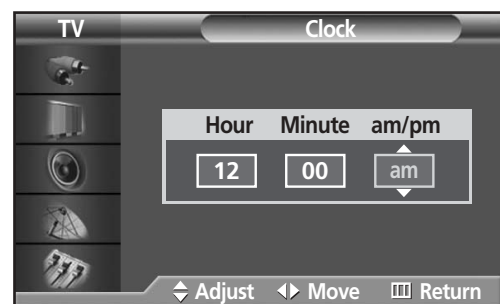

6 Press the MENU button to exit.



## Setting the Sleep Timer

You can set your PDP to automatically turn off after a preset interval.

- 1 Press the MENU button. Press the ▲ or ▼ button to select "Setup", then press the ENTER button.

➤ Quick way to access the sleep timer setting: Just press the "SLEEP" button on the remote control.



- 2 Press the ▲ or ▼ button to select "Time", then press the ENTER button.

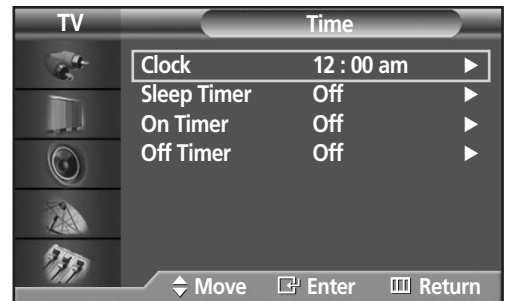

- 3 Press the ▲ or ▼ button to select "Sleep Timer", then press the ENTER button.

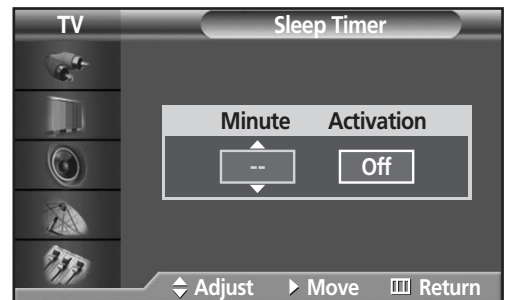

- 4 Press the ▲ or ▼ button to select the time interval for the PDP to stay on. The interval ranges from 30 to 180 minutes.

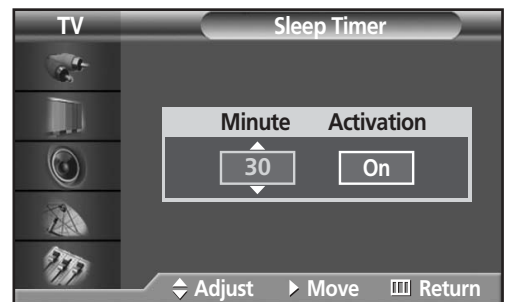

- 5 Press the ► button to select "Activation", then press the ▲ or ▼ button to select "On" or "Off".

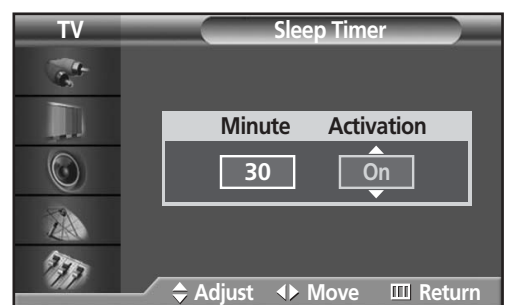

- 6 Press the MENU button to exit.



# Setting the Timers

This PDP can be set to turn on or off automatically at specific times that you choose. Before using the timers, you must set the PDP's clock, as described previously.

1 Press the MENU button. Press the ▲ or ▼ button to select "Setup", then press the ENTER button.



2 Press the ▲ or ▼ button to select "Time", then press the ENTER button.

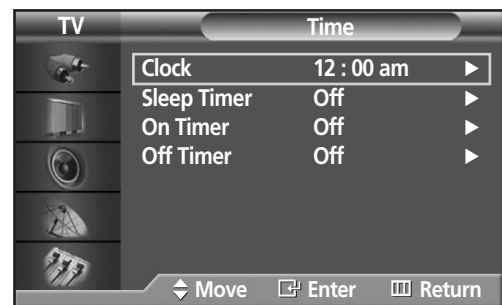

3 Press the ▲ or ▼ button to select "On Timer". Press the ENTER button to select "Hour", then press the ▲ or ▼ button to select correct hour.



4 Press the ► button to select "Minute", then press the ▲ or ▼ button to select correct minute.



5 Press the ► button to select "am/pm", then press the ▲ or ▼ button to select the proper time of day (am or pm).





# Plasma Display

- 
- 6 Press the ► button to select "Channel", then press the ▲ or ▼ button to select the channel you want when PDP turns on.



- 
- 7 Press the ► button to select "Volume", then press the ▲ or ▼ button to select the volume level you want when PDP turns on.



- 
- 8 Press the ► button to select "Activation", then press the ▲ or ▼ button to select "On" or "Off".



- 
- 9 If you want to set Off Time, press the MENU button. Press the ▲ or ▼ button to select "Off Time". Set the "Off Time" just as you set "On Time".

- 
- 10 Press the MENU button to exit.



S  
V  
W  
S  
U  
N  
G

P L A S M A   D I S P L A Y   P A N E L

## Function Description

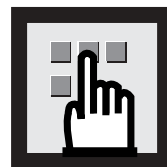

Selecting a Menu Language .....	92
Digital Noise Reduction .....	93
Selecting the Film Mode .....	94
Using the Color Weakness Enhancement Option .....	95
Setting the Melody Sound .....	96
Setting the Blue Screen .....	97
Viewing Closed Captions .....	98
Using the V-Chip .....	99

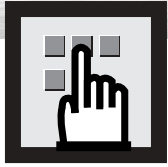

# Selecting a Menu Language

1 Press the MENU button. Press the ▲ or ▼ button to select "Setup", then press the ENTER button.



2 Press the ENTER button to select "Language".

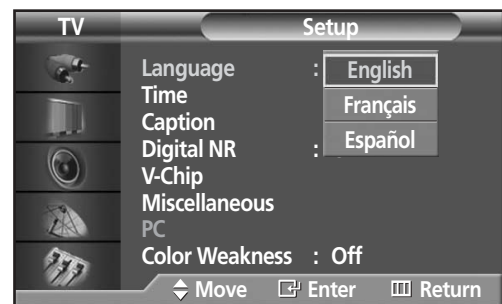

3 Press the ▲ or ▼ button to select the appropriate language: "English", "Français" or "Español".



4 Press the MENU button to exit.

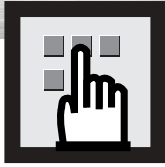

## Digital Noise Reduction

If the broadcast signal received by your TV is weak, you can activate the Digital Noise Reduction feature to help reduce any static and ghosting that may appear on the screen.

- 1 Press the MENU button. Press the ▲ or ▼ button to select "Setup", then press the ENTER button.



- 2 Press the ▲ or ▼ button to select "Digital NR", then press the ENTER button.

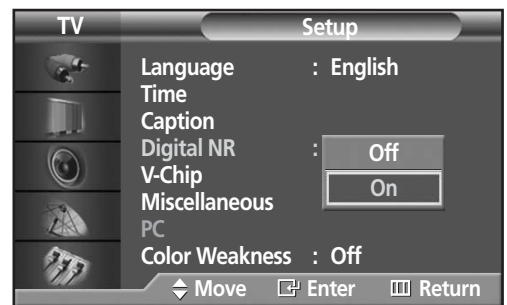

- 3 Press the ▲ or ▼ button to select "On" or "Off", then press the ENTER button.

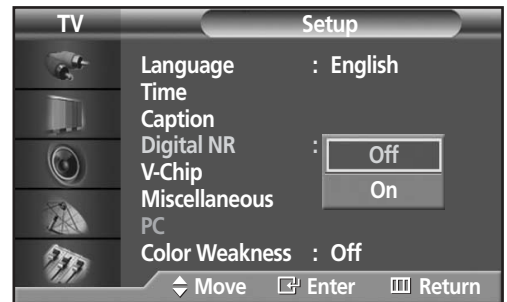

- 4 Press the MENU button to exit.

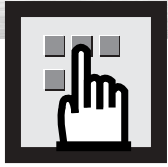

# Selecting the Film Mode

On: Automatically senses and processes film signals from all sources and adjusts the picture for optimum quality.

Off: Switches off the Film mode.

1 Press the MENU button. Press the ▲ or ▼ button to select "Picture", then press the ENTER button.

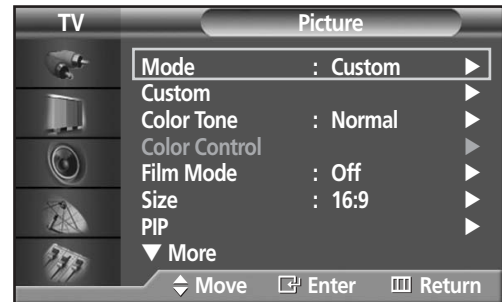

2 Press the ▲ or ▼ button to select "Film Mode", then press the ENTER button.

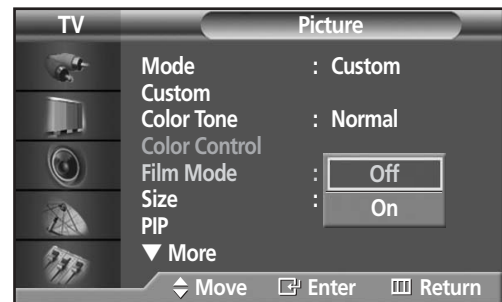

3 Press the ▲ or ▼ button to select "On" or "Off", then press the ENTER button.

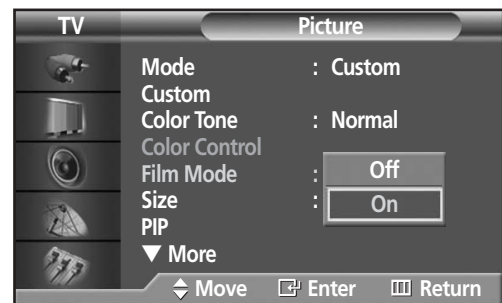

4 Press the MENU button to exit.

## Note

- Film mode is supported in TV, VIDEO, S-VIDEO and COMPONENT 480i.

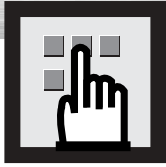

## Using the Color Weakness Enhancement Option

This option adjusts the Red, Blue or Green color to enhance the image according to the user's particular color weakness.

**1** Press the MENU button. Press the ▲ or ▼ button to select "Setup", then press the ENTER button.

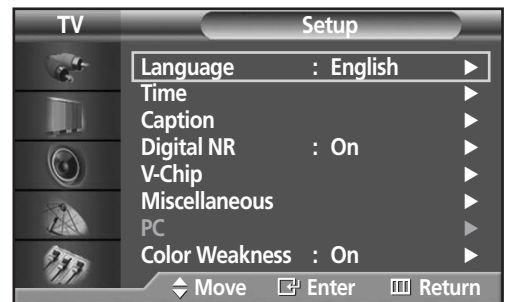

**2** Press the ▲ or ▼ button to select "Color Weakness", then press the ENTER button.



**3** Press the ▲ or ▼ button to select "On", then press the ENTER button. You will also see the items "R", "G", and "B".

- Pressing the ▲ or ▼ button will alternate between "On" and "Off".



**4** Press the ▲ or ▼ button to select the item you wish to change, then press the ENTER button. Press the ◀ or ▶ button to change the value of the item, then press the ENTER button.

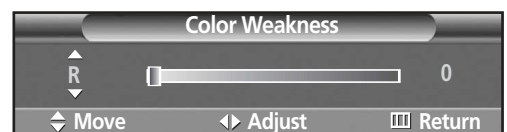

**5** Press the MENU button to exit.

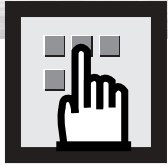

# Setting the Melody Sound

You can set a melody to sound when the television is powered on or off.

- 1 Press the MENU button. Press the ▲ or ▼ button to select "Setup", then press the ENTER button.



- 2 Press the ▲ or ▼ button to select "Miscellaneous", then press the ENTER button.

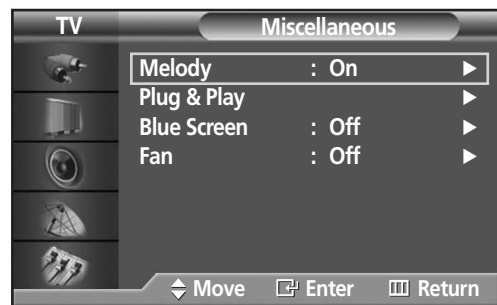

- 3 Press the ▲ or ▼ button to select "Melody", press the ENTER button.

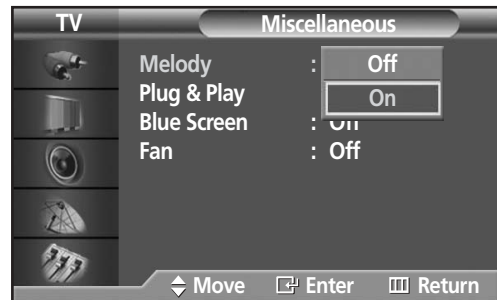

- 4 Press the ▲ or ▼ button to select "On" or "Off", then press the ENTER button.

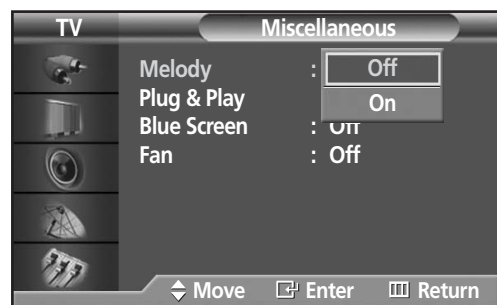

- 5 Press the MENU button to exit.



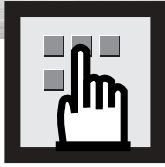

## Setting the Blue Screen

If no signal is being received or the signal is very weak, a blue screen automatically replaces the noisy picture background. If you wish to continue viewing the poor picture, you must set the "Blue Screen" mode to "Off".

- 1 Press the MENU button. Press the ▲ or ▼ button to select "Setup", then press the ENTER button.



- 2 Press the ▲ or ▼ button to select "Miscellaneous", then press the ENTER button.

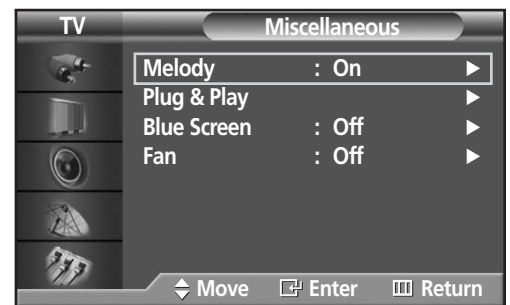

- 3 Press the ▲ or ▼ button to select "Blue Screen", Press the ENTER button.



- 4 Press the ▲ or ▼ button to select "On" or "Off", then press the ENTER button.

- Blue Screen is displayed when there is no signal from an external device in the External Mode, regardless of the Blue Screen Setting.

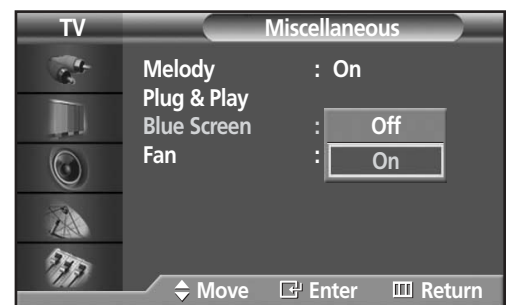

- 5 Press the MENU button to exit.

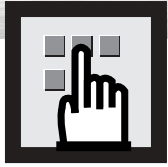

# Viewing Closed Captions

Your TV decodes and displays the closed captions that are broadcast with certain TV shows. These captions are usually subtitles for the hearing impaired or foreign language translations. All VCRs record the closed caption signal from television programs, so home-recorded video tapes also provide closed captions. Most prerecorded commercial video tapes provide closed captions as well. Check for the closed caption symbol in your television schedule and on the tape's packaging: .

Note: The Caption feature does not work with DVD or DTV signals.

- 1 Press the MENU button. Press the ▲ or ▼ button to select "Setup", then press the ENTER button. Press the ▲ or ▼ button to select "Caption", then press the ENTER button.

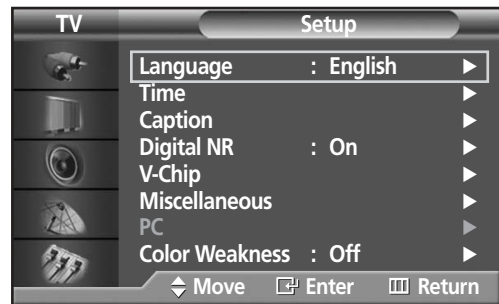

- 2 Press the ENTER button to select "Caption". Press the ▲ or ▼ button to turn closed caption on/off, then press the ENTER button.

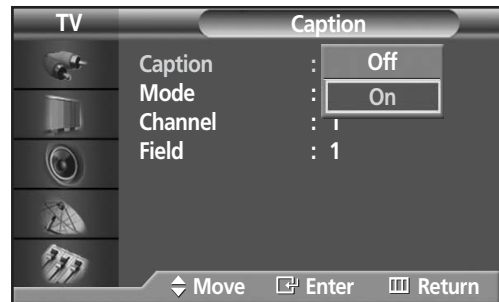

- 3 Press the ▲ or ▼ button to select "Mode", then press the ENTER button. Press the ▲ or ▼ button to select "Text" or "Caption", then press the ENTER button.

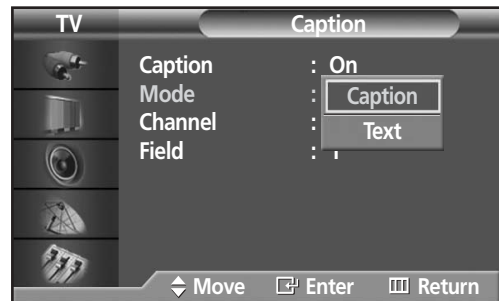

- 4 Depending on the particular broadcast, it might be necessary to make changes to "Channel" and "Field": Press the ▲ / ▼ / ◀ / ▶ button to make the changes. (Follow the same procedure as in steps 3 above.)

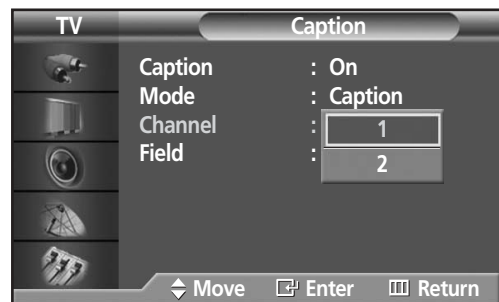

- 5 Press the MENU button to exit.

## Note

- Different channels and fields display different information: Field 2 carries additional information that supplements the information in Field 1. (For example, Channel 1 may have subtitles in English, while Channel 2 has subtitles in Spanish.)

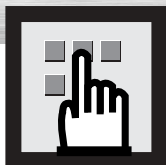

## Using the V-Chip

The V-Chip feature automatically locks out programs that are deemed inappropriate for children. The user must enter a PIN (personal ID number) before any of the V-Chip restrictions are set up or changed.

Note: When the V-chip feature is activated, the PIP and auto channel program features do not function.

### Setting Up Your Personal ID Number (PIN)

- 1 Press the MENU button. Press the ▲ or ▼ button to select "Setup", then press the ENTER button.



- 2 Press the ▲ or ▼ button to select "V-Chip", then press the ENTER button. The message "Enter PIN" will appear. Enter your 4 digit PIN number.

Note: The default PIN number of a new TV set is "0-0-0-0".

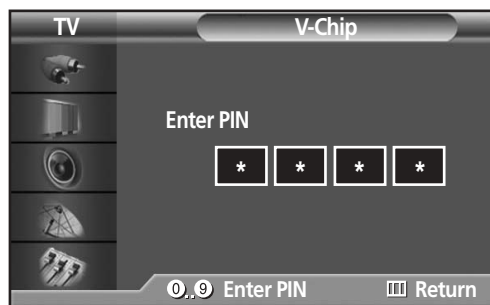

- 3 The "V-Chip" screen will appear. Press the ▲ or ▼ button to select "Change PIN", then press the ENTER button.

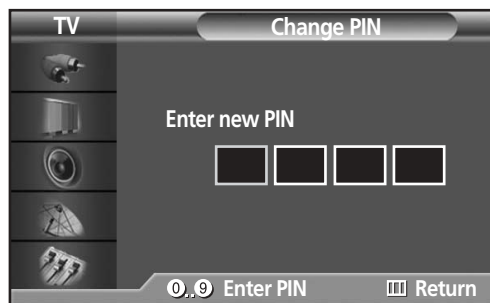

- 4 The Change PIN screen will appear. Choose any 4 digits for your PIN and enter them. As soon as the 4 digits are entered, the "Confirm new PIN" screen appears. Re-enter the same 4 digits. When the Confirm screen disappears, your PIN has been memorized.

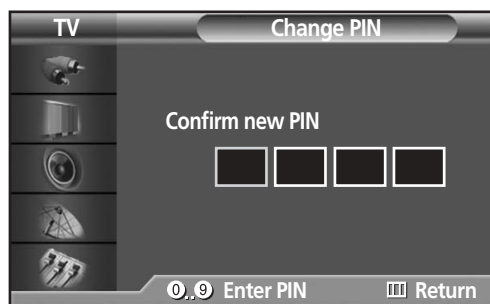

- 5 Press the MENU button to exit.

#### Note

- If you forget the PIN, press the remote-control buttons in the following sequence, which resets the pin to 0-0-0-0 : Power Off. → Mute → 8 → 2 → 4 → Power On.

## How to Enable/Disable the V-Chip

- 1 Press the MENU button. Press the ▲ or ▼ button to select "Setup", then press the ENTER button.

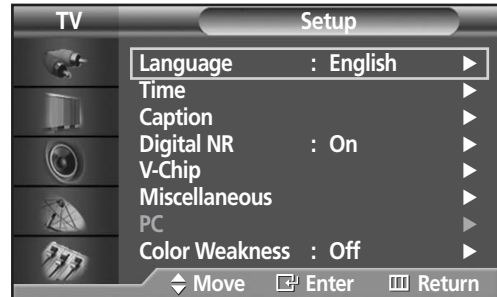

- 2 Press the ▲ or ▼ button to select "V-Chip", then press the ENTER button. The message "Enter PIN" will appear. Enter your 4 digit PIN number.

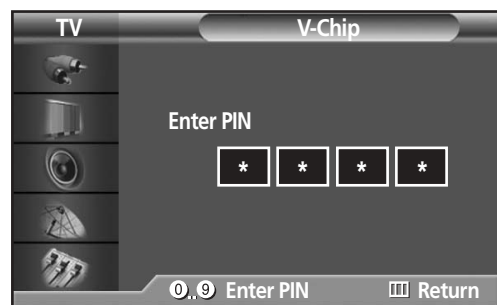

- 3 The "V-Chip" screen will appear. To enable the V-Chip feature, press the ENTER button so that the "V-Chip Lock" field is "On". (Pressing the ▲ or ▼ button will alternate between "On" and "Off".) Press the ENTER button.

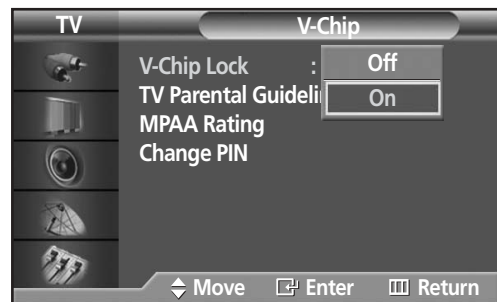

- 4 Press the MENU button to exit.

## How to Set up Restrictions using the "TV Parental Guidelines"

First, set up a personal identification number (PIN), and enable the V-Chip. (See previous section.) Parental restrictions can be set up using either of two methods: The TV guidelines or the MPAA rating.

- 1 Press the MENU button. Press the ▲ or ▼ button to select "Setup", then press the ENTER button.



- 2 Press the ▲ or ▼ button to select "V-Chip", then press the ENTER button. The message "Enter PIN" will appear. Enter your 4-digit PIN number.

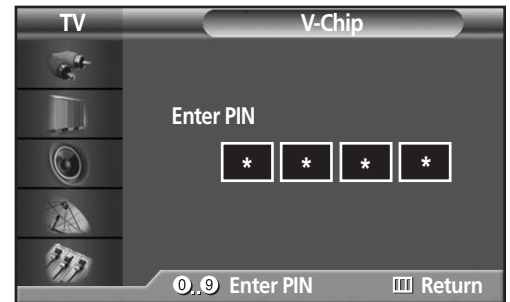

- 3 The "V-Chip" screen will appear. Press the ▲ or ▼ button to select "TV Parental Guidelines", then press the ENTER button.

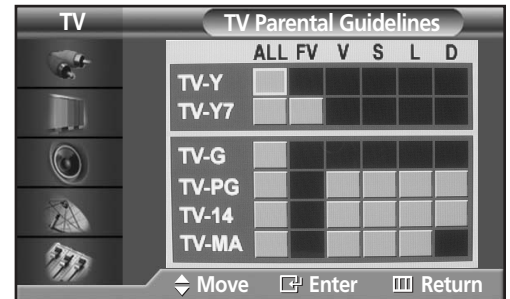



- 4 The "TV Parental Guidelines" screen will appear. Press the ▲ or ▼ button to select one of the six ages based categories:

TV-Y Young children  
TV-Y7 Children 7 and over

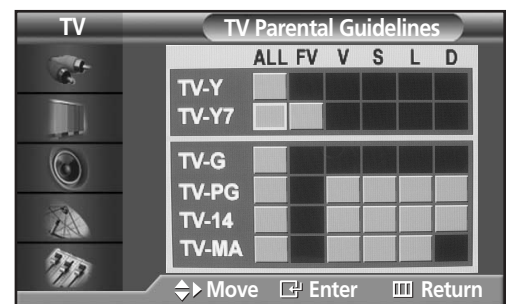
TV-G General audience  
TV-PG Parental guidance  
TV-14 Viewers 14 and over  
TV-MA Mature audience



- 
- 5** At this point, one of the TV-Ratings is selected. Press the ENTER button. Depending on your existing setup, a symbol  will be selected. (Blank = Unblocked,  = Blocked)

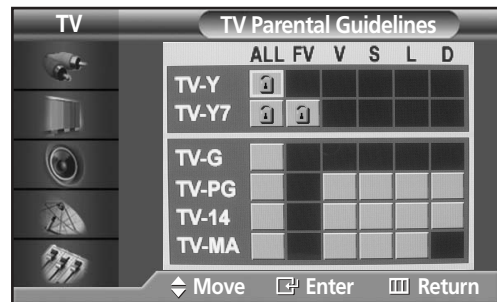

While " " is selected, press the ENTER button to block or unblock the category. To select a different TV-Rating, press the ▲ or ▼ button and then repeat the process.



Note 1: The TV-Y7, TV-PG, TV-14 and TV-MA have additional options. See the next step to change any of the following sub-ratings:

FV: Fantasy violence  
D: Sexually Suggestive Dialog  
L: Adult Language  
S: Sexual situation  
V: Violence

Note 2: The V-Chip will automatically block certain categories that are "more restrictive". For example, if you block "TV-Y" category, then TV-Y7 will automatically be blocked. Similarly, if you block the TV-G category, then all the categories in the "young adult" group will be blocked (TV-G, TV-PG, TV-14 and TV-MA). The sub-ratings (D, L, S, V) work together similarly. (See next section.)

- 
- 6** How to set the FV, D, L, S and V sub-ratings. First, select one of these TV-Ratings: TV-Y7, TV-PG, TV-14 or TV-MA (See Step 4, on previous page). Next, while the TV-Rating is selected, repeatedly press the ► button. This will cycle through the available sub-ratings (FV, L, S, D or V). A symbol " " will be displayed for each sub-rating. While " " is selected, press the ENTER button to change the sub-rating. To select a different TV-Rating, press the ▲ or ▼ button and then repeat the process. Note: The V-chip will automatically block certain categories that are "More restrictive". For example, if you block "L" sub-rating in TV-PG, then the "L" sub-ratings in TV-14 and TV-MA will automatically be blocked.

- 
- 7** Press the MENU button to clear all the screens. (Or proceed to the next section, and set up additional restrictions based on the MPAA codes).

**Note**

- These categories consist of two separate groups: TV-Y and TV-Y7 (young children through age 7), and TV-G through TV-MA (everybody else). The restrictions for these two groups work independently: If a household includes very young children as well as young adults, the TV guidelines must be set up separately for each age group. (See next step.)

## How to Set up Restrictions using the MPAA Ratings: G, PG, PG-13, R, NC-17, X, NR

The MPAA rating system uses the Motion Picture Association of America (MPAA) system, and its main application is for movies. When the V-Chip lock is on, the TV will automatically block any programs that are coded with objectionable ratings (either MPAA or TV-Ratings).

- 1 Press the MENU button. Press the ▲ or ▼ button to select "Setup", then press the ENTER button.

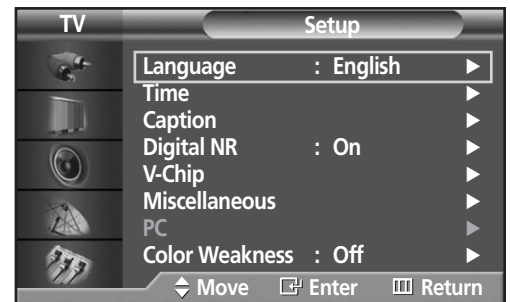

- 2 Press the ▲ or ▼ button to select "V-Chip", then press the ENTER button. The message "Enter PIN" will appear. Enter your 4 digit PIN number.

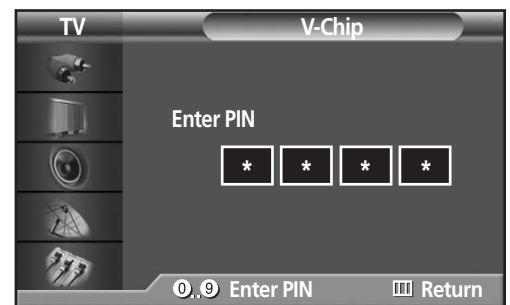

- 3 The "V-Chip" screen will appear. Press the ▲ or ▼ button to select "MPAA Rating", then press the ENTER button.

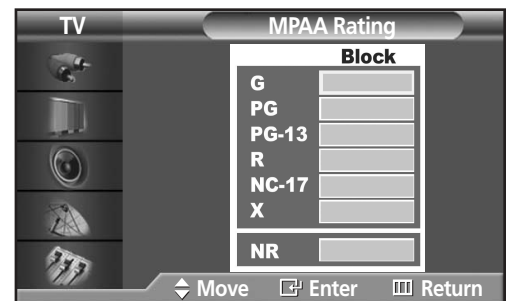

- 4 The "MPAA Rating" screen will appear. Repeatedly press the ▲ or ▼ button to select a particular MPAA category. Pressing the ▲ or ▼ button will cycle through the MPAA categories:

<b>G</b>	General audience (no restrictions).
<b>PG</b>	Parental guidance suggested.
<b>PG-13</b>	PG-13 (Parents strongly cautioned).
<b>R</b>	R (Restricted. Children under 17 should be accompanied by an adult).
<b>NC-17</b>	No children under age 17.
<b>X</b>	X (Adults only).
<b>NR</b>	Not rated.

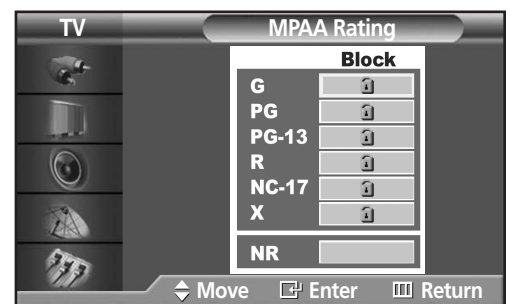

While a particular category is selected, press the ENTER button to activate it.

A selected symbol "🔒" will be displayed. Press the ENTER button to block or unblock the category.

Note: The V-Chip will automatically block any category that is "more restrictive". For example, if you block the "PG-13" category, then "R", "NC-17" and "X" will automatically be blocked also.

## How to Reset the TV after the V-Chip Blocks a Channel (“Emergency Escape”)

If the TV is tuned to a restricted channel, the V-Chip will block it. The screen will go blank and the following message will appear:

- 
- 1 Press the ENTER button.

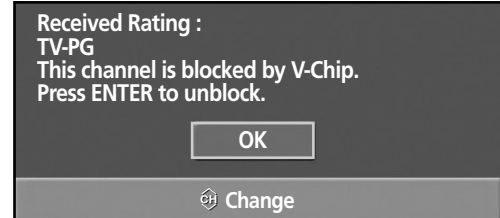

- 
- 2 Enter your PIN number.



To resume normal viewing, tune to a different channel using the number buttons. Under certain conditions (depending on the rating of the local TV programs) the V-Chip might lock out all the channels. In this case, use the V-Chip function for an “emergency escape”:

- 
- 1 Press the MENU button. Press the ▲ or ▼ button to select “Setup”, then press the ENTER button.

- 
- 2 Press the ▲ or ▼ button to select “V-Chip”, then press the ENTER button.

- 
- 3 Enter your PIN number, and press the ▲ or ▼ button to temporarily disable the V-Chip Lock.



S  
V  
W  
S  
U  
N  
G

P L A S M A   D I S P L A Y   P A N E L

# Appendix

Troubleshooting.....	106
Care and Maintenance .....	107
Specifications .....	108



# Troubleshooting

Before you call a service technician, please scan this list of problems and possible solutions. It may save you time and money.

<b>Problem</b>	<b>Possible Solution</b>
Poor picture.	Check all wire connections.
Your Remote control does not operate the PDP.	Press the "MODE" button to put your remote control in the "TV" mode.
The PDP won't turn on.	Check if the power plug is connected.
There is no screen image.	Check to see that both the PDP and the source are plugged in and turned on.
The image is too light or too dark.	Adjust the Brightness or Contrast settings.
The image is too large or too small.	Adjust the Size settings.



## Care and Maintenance

With proper care, your PDP will give you many years of service. Please follow these guidelines to get the maximum performance from your PDP.

### Identifying Problems

- Do not put the PDP near extremely hot, cold, humid or dusty places.
- Do not put the PDP near appliances that create magnetic fields.
- Keep the ventilation openings clear.
- Do not place the PDP on a rough and slanted surface, such as cloth or paper.

### Liquids

- Do not place liquids near or on the PDP.

### Cabinet

- Never open the cabinet or touch the parts inside.
- Wipe your PDP with a clean, dry cloth. Never use water, cleaning fluids, wax, or chemicals.
- Do not put heavy objects on top of the cabinet.

### Temperature

- If your PDP is suddenly moved from a cold to a warm place, unplug the power cord for at least two hours so that moisture that may have formed inside the unit can dry completely.



# Specifications

Exterior design and product specifications are subject to change without prior notice to improve the performance of this product.

Model	HP-P5031	
Dimensions	Display	1205.5 (W) X 81.5 (D) X 725 (H) mm / 47.47 (W) X 3.21 (D) X 28.54 (H) inches
Weight	Display	41.7 kg (Without Stand) / 91.9 lbs
Voltage	AC 120 V~, 60 Hz	
Number of Pixels	1366 (H) x 768 (V)	
Screen Size	127 Cm/50 inches (16:9)	
ANTENNA input	VHF, UHF (75Ω unbalanced)	
VIDEO input	AV1 AV2 S-VIDEO COMPONENT 1 - 480i / 480p / 720p / 1080i COMPONENT 2 - 480i / 480p / 720p / 1080i PC (MINI D-SUB 15P) DVI-D	
AUDIO input	AV1 AV2/ S-VIDEO COMPONENT 1 COMPONENT 2 PC DVI-D	
Monitor Output	VIDEO, AUDIO(L/R)	
Speaker Output	15W+15W (8 Ω)	



## Memo

---



**1-800-SAMSUNG (1-800-726-7864)**

**Samsung Electronics America  
Service Division**

400 Valley Road, Suite 201  
Mount Arlington, NJ 07856  
[www.samsungusa.com](http://www.samsungusa.com)

**Samsung Electronics Canada Inc.  
Samsung Customer Care**

7037 Financial Drive  
Mississauga, Ontario  
L5N 6R3  
[www.samsung.ca](http://www.samsung.ca)