



Owner's Guide

Mitsubishi Plasma Display PD-5050 & PD-6150



IMPORTANT SAFETY INSTRUCTIONS (PD-5050/PD-6150)

Read before operating equipment

1. Read these instructions.
2. Keep these instructions.
3. Heed all warnings.
4. Follow all instructions.
5. Do not use this plasma display near water.
6. Clean only with a dry cloth.
7. Do not block any of the ventilation openings. Install in accordance with the manufacturers instructions.
8. Do not install near any heat sources such as radiators, heat registers, stoves, or other apparatus (including amplifiers) that produce heat.
9. Do not defeat the safety purpose of the polarized or grounding-type plug. A polarized plug has two blades with one wider than the other. A grounding type plug has two blades and third grounding prong. The wide blade or third prong are provided for your safety. When the provided plug does not fit into your outlet, consult an electrician for replacement of the obsolete outlet.
10. Protect the power cord from being walked on or pinched particularly at plugs, convenience receptacles, and the point where they exit from the apparatus.
11. Only use attachments/accessories specified by the manufacturer.
12.  Use only with a cart, stand, tripod, bracket, or table specified by the manufacturer, or sold with the plasma display. When a cart is used, use caution when moving the cart/plasma display combination to avoid injury from tip-over.
13. Unplug this plasma display during lightning storms or when unused for long periods of time.
14. Refer all servicing to qualified service personnel. Servicing is required when the plasma display has been damaged in any way, such as power-supply cord or plug is damaged, liquid has been spilled or objects have fallen into apparatus, the apparatus has been exposed to rain or moisture, does not operate normally, or has been dropped.
15. This product may contain lead or mercury. Disposal of these materials may be regulated due to environmental considerations.
For disposal or recycling information, please contact your local authorities or the Electronic Industries Alliance: www.eiae.org.
16. **Damage Requiring Service** - The plasma display should be serviced by qualified service personnel when:
 - A. The power supply cord or the plug has been damaged; or
 - B. Objects have fallen, or liquid has been spilled into the plasma display; or
 - C. The plasma display has been exposed to rain; or
 - D. The plasma display does not appear to operate normally or exhibits a marked change in performance; or
 - E. The plasma display has been dropped, or the enclosure damaged.

17. **Tilt/Stability** - All televisions must comply with recommended international global safety standards for tilt and stability properties of its cabinets design.
 - Do not compromise these design standards by applying excessive pull force to the front, or top, of the cabinet which could ultimately overturn the product.
 - Also, do not endanger yourself, or children, by placing electronic equipment/toys on the top of the cabinet. Such items could unsuspectingly fall from the top of the set and cause product damage and/or personal injury.
18. **Wall Mounting** - The plasma display should be mounted to a wall only as recommended by the manufacturer.
19. **Power Lines** - An outdoor antenna should be located away from power lines.
20. **Outdoor Antenna Grounding** - If an outside antenna is connected to the receiver, be sure the antenna system is grounded so as to provide some protection against voltage surges and built up static charges.
Section 810 of the National Electric Code, ANSI/NFPA No. 70- 1984, provides information with respect to proper grounding of the mats and supporting structure grounding of the lead-in wire to an antenna-discharge unit, size of grounding connectors, location of antenna-discharge unit, connection to grounding electrodes and requirements for the grounding electrode.
21. **Objects and Liquid Entry** - Care should be taken so that objects do not fall and liquids are not spilled into the enclosure through openings.

The plasma display shall not be exposed to dripping or splashing and that no objects filled with liquids, such as vases, shall be placed on apparatus.

WARNING

To reduce the risk of fire or electric shock, do not expose this plasma display to rain or moisture.

Caution

This device needs to be attached to a stand or other mounting hardware.

Use the following optional accessories. Use with other optional accessories is capable of resulting in instability causing possible injury.

Do Not use the bottom carton as a temporary or permanent stand.

Manufacturer's name: MITSUBISHI DIGITAL ELECTRONICS AMERICA, INC
Stand: MB-5010/MB-5030 for PD-5050
MB-6130 for PD-6150
Tilt Wall Mount: PMOUNT-5061T

Please contact MITSUBISHI DIGITAL ELECTRONICS AMERICA, INC for approved optional accessories.

Important Information

Precautions

Please read this manual carefully before using your Mitsubishi plasma display and keep the manual handy for future reference.

CAUTION



RISK OF ELECTRIC SHOCK
DO NOT OPEN



CAUTION: TO REDUCE THE RISK OF ELECTRIC SHOCK, DO NOT REMOVE COVER. NO USER-SERVICEABLE PARTS INSIDE. REFER SERVICING TO QUALIFIED SERVICE PERSONNEL.

This symbol warns the user that uninsulated voltage within the unit may have sufficient magnitude to cause electric shock. Therefore, it is dangerous to make any kind of contact with any part inside of this unit.



This symbol alerts the user that important literature concerning the operation and maintenance of this unit has been included. Therefore, it should be read carefully in order to avoid any problems.



This symbol alerts the user that important literature concerning the operation and maintenance of this unit has been included. Therefore, it should be read carefully in order to avoid any problems.

WARNING

TO PREVENT FIRE OR SHOCK HAZARDS, DO NOT EXPOSE THIS UNIT TO RAIN OR MOISTURE. ALSO DO NOT USE THIS UNIT'S POLARIZED PLUG WITH AN EXTENSION CORD RECEPTACLE OR OTHER OUTLETS, UNLESS THE PRONGS CAN BE FULLY INSERTED. REFRAIN FROM OPENING THE CABINET AS THERE ARE HIGH-VOLTAGE COMPONENTS INSIDE. REFER SERVICING TO QUALIFIED SERVICE PERSONNEL.

Warning

Not for use in a computer room as defined in the Standard for the Protection of Electronic Computer/ Data Processing Equipment ANSI/NFPA 75.

This equipment has been tested and found to comply with the limits for a Class B digital device, pursuant to Part 15 of the FCC Rules. These limits are designed to provide reasonable protection against harmful interference in a residential installation. This equipment generates, uses, and can radiate radio frequency energy and, if not installed and used in accordance with the instructions, may cause harmful interference to radio communications. However, there is no guarantee that interference will not occur in a particular installation. If this equipment does cause harmful interference to radio or television reception, which can be determined by turning the equipment off and on, the user is encouraged to try to correct the interference by one or more of the following measures:

- Reorient or relocate the receiving antenna.
- Increase the separation between the equipment and receiver.
- Connect the equipment into an outlet on a circuit different from that to which the receiver is connected.
- Consult the dealer or an experienced radio / TV technician for help.

Warnings and Safety Precautions

The Mitsubishi plasma display is designed and manufactured to provide long, trouble-free service. No maintenance other than cleaning is required. Use a soft dry cloth to clean the panel. Never use solvents such as alcohol or thinner to clean the panel surface.

The plasma display panel consists of fine picture elements (cells). Although Mitsubishi plasma display's utilize panels with more than 99.99 percent active cells, there may be some cells that do not produce light or remain lit.

For operating safety and to avoid damage to the unit, please read and observe the following instructions.

To avoid shock and fire hazards:

1. Provide adequate space for ventilation to avoid internal heat build-up. Do not cover rear vents or install the unit in a closed cabinet or shelves.
The unit is equipped with cooling fans. If you install the unit in an enclosure, make sure there is adequate space at the top of the unit to allow hot air to rise and escape. If the display becomes too hot, the overheat protector will be activated and the display will be turned off. If this happens, turn off the power to the display and unplug the power cord. If the room where the monitor is installed is particularly hot, move the display to a cooler location, and wait for the display to cool for 60 minutes. If the problem persists, contact your Mitsubishi dealer for service.
2. Do not use the power cord polarized plug with extension cords or outlets unless the prongs can be completely inserted.
3. Do not expose the unit to water or moisture.
4. Avoid damage to the power cord, and do not attempt to modify the power cord.
5. Unplug the unit during electrical storms or if the unit will not be used over a long period.
6. Do not open the cabinet which has potentially dangerous high voltage components inside. If the unit is damaged in this way the warranty will be void. Moreover, there is a serious risk of electric shock.
7. Do not attempt to service or repair the unit. Mitsubishi is not liable for any bodily harm or damage caused if unqualified persons attempt service or open the back cover. Refer all service to authorized Mitsubishi Service Centers.

NOTE:

When you connect a computer to this monitor, use an RGB cable including the ferrite cores on both ends of the cable. If you do not do this, this display will not conform to mandatory FCC standards.

Attaching the ferrite cores:

Attach the ferrite cores on both ends of the power cable (supplied).

Close the lid tightly until the clamps click.

*HDMI cable doesn't need ferrite cores.

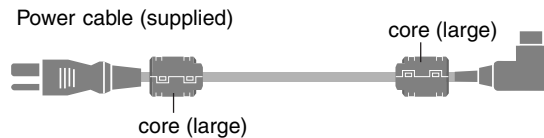

To avoid damage and prolong operating life:

1. Use only with 100V-240V 50/60Hz AC power supply. Continued operation at line voltages greater than 100-240 Volts AC will shorten the life of the unit, and might even cause a fire hazard.
2. Handle the unit carefully when installing it and do not drop.
3. Set the unit away from heat, excessive dust, and direct sunlight.
4. Protect the inside of the unit from liquids and small metal objects. In case of an accident, unplug the unit and have it serviced by an authorized Mitsubishi Service Center.
5. Do not hit or scratch the panel surface as this causes flaws on the surface of the screen.
6. For correct installation and mounting it is strongly recommended to use a trained, authorized Mitsubishi dealer.
7. Only use tabletop stands or wall-mount brackets that are designed specifically for this product.
8. As is the case with any phosphor-based display (like a CRT monitor, for example) light output will gradually decrease over the life of a Plasma Display Panel.

Recommendations to avoid or minimize uneven phosphor aging:

Like all phosphor-based display devices and all other gas plasma displays, plasma displays can be susceptible to uneven phosphor aging under certain circumstances. Certain operating conditions, such as the continuous display of a static image over a prolonged period of time, can result in uneven phosphor aging if proper precautions are not taken. To protect your investment in this Mitsubishi plasma display, please adhere to the following guidelines and recommendations for minimizing this type of damage:

1. Do not turn off ORBITER.*
2. Always enable and use your computer's video game or DVD player screen saver during use with these sources.
3. Display a moving image whenever possible.
4. Change the position of the menu display from time to time.
5. Always power down the display when you are finished using it.

If the plasma display is in long term use or continuous operation, take the following measures to reduce the likelihood of uneven phosphor aging:

1. Do not turn off ORBITER.*
2. Lower the Brightness and Contrast levels as much as possible without impairing image readability.
3. Display an image with many colors and color gradations (i.e. photographic or photo-realistic images).
4. Create image content with minimal contrast between light and dark areas. Use complementary or pastel colors whenever possible.
5. Avoid displaying images with few colors and distinct, sharply defined borders between colors.

NOTE:

Uneven phosphor aging/burn-in is not covered by the warranty.

Contact Mitsubishi at 1-800-332-2119 for other recommended procedures that will best suit your particular application needs.

*ORBITER - Uneven phosphor aging/burn-in reduction feature. To minimize the risk of uneven phosphor aging/burn-in when displaying still images, the Mitsubishi PD-5050 and PD-6150 offers a built-in feature known as ORBITER. The ORBITER feature intermittently shifts the screen image horizontally and vertically in small increments. This intermittent screen movement is usually not evident in full motion video. In some instances the ORBITER shift might be evident while displaying static guides or menus. The default setting for ORBITER is On (AUTO1). Mitsubishi chose this setting to help reduce uneven phosphor aging. Please do not shut the ORBITER off. For more information regarding ORBITER, see page 27.

WARNING: Do not leave stationary or letterbox images on-screen for extended periods of time. Mix types of pictures shown. Uneven phosphor aging is NOT covered by your warranty.

The normal use of a TV should include a mixture of TV picture types. The most frequently used picture types should fill the screen with constantly moving images rather than stationary images or patterns. Displaying the same stationary patterns over extended periods of time, or displaying the same stationary pattern frequently can leave a subtle but permanent ghost image. To avoid this, mix your viewing pattern. Do not show the same stationary image for more than 15% of your total TV viewing in any one week. Display constantly moving and changing images that fill the screen whenever possible.

This plasma display is a phosphor-based display. As is the case with any phosphor-based display (like a CRT TV/monitor, for example) light output will gradually decrease over the life of a plasma display panel. Normal TV pictures fill the screen with constantly changing images. Under these conditions, phosphor-based displays age at an even rate across the entire screen. This maintains a TV picture that is evenly bright over the whole screen. Stationary images or images that only partially fill the screen (leaving black or colored bars to fill the screen), when used over extended periods of time or when viewed repeatedly, can cause uneven aging of the phosphors used in plasma displays and can leave subtle ghosts of the stationary images in the picture.

When using a computer or similar device through a VGA input, be sure to turn on the Screen Saver feature and set the activation time to 5 minutes or less. If your computer program allows, you should also set your toolbars to the hidden mode.

Still or stationary images may be received from broadcasters, cable channels, satellite channels, DVD discs, video tapes, laser discs, on-line services, web/internet searching devices, video games, and digital TV tuner/converter boxes. Examples of these types of images include, but are not limited to the following:

- **Letterbox top/bottom black bars:** shown at the top and bottom of the TV screen when you watch a widescreen (16:9) movie on a standard (4:3) TV.
- **Side bar images:** solid bars shown on each side of an image when watching a standard (4:3) program on a widescreen (16:9) TV.
- **Stock-market report bars:** ticker running at the bottom of the TV screen.
- **Shopping channel logos & pricing displays:** bright graphics that are shown constantly or repeatedly in the same location.
- **Video game patterns and scoreboards**
- **Bright station logos:** moving or low-contrast graphics are less likely to cause uneven aging of the picture tubes.
- **On-line (Internet) web sites:** or any other stationary or repetitive computer style images.
- **Closed Caption Backgrounds:** If Close Caption will be used frequently Mitsubishi suggests the use of the gray background.

Cleaning Safeguards

Plasma Display Screen & Cabinet

Please follow the cleaning safeguards listed below to prevent damage to your Plasma Display and retain this document for future reference.

IMPORTANT: No Abrasives!

DO NOT use any kind of abrasive cloth or cleaner or ammonia on the Plasma Display's screen or cabinet.

Cleaning Your Plasma Display

Normally, light dusting with a dry, non-abrasive cloth will clean your Plasma Display. If cleaning beyond this is needed, please follow these guidelines:

First, turn off the Plasma Display and unplug the power cord from the wall outlet before cleaning.

Cleaning the cabinet of your Plasma Display

- Gently wipe down the Plasma Display with a soft, non-abrasive cloth such as cotton flannel or a clean cloth diaper, lightly moistened with water.
- Dry with a second dry, soft, non-abrasive cloth.

General Cleaning Warnings:

- **DO NOT** apply pressure to the Plasma Display's screen.
- **DO NOT** allow liquid to enter the Plasma Display through the ventilation slots or any crevice.
- **DO NOT** use any strong or abrasive cleaners because they can scratch the screen and the cabinet.
- **DO NOT** use any cleaners that contain ammonia, bleach, alcohol, benzene, or thinners because they can damage and dull the surfaces.
- **DO NOT** scrub or rub the screen or cabinet. Wipe it gently.

IMPORTANT

For further assistance in operating your Plasma Display or if you are in need of service, please contact us at www.mitsubishi-tv.com or call Consumer Relations at

800-332-2119

Introduction

Introduction to the PD-5050/ PD-6150 Plasma Displays

Mitsubishi's PD-5050/PD-6150 plasma displays are a seamless blend of cutting-edge visual technology and sophisticated design. The displays sleek techno-art lines blend in well with most environments. The displays crisp, vivid image quality will transform data from any graphic medium from PCs to DVD players into art. Mitsubishi has made sure that a host of multimedia resources can be easily connected and displayed as brilliantly as intended.

The features you'll enjoy include:

- 16:9 aspect ratio
- Capsulated Color Filter (CCF) and black matrix
- The enhanced display uses a two-stage filtering system for deeper, more accurate colors.
- High-resolution screen: 1365 x 768 pixels
- 160-degrees of off-axis viewing, horizontally and vertically.
- Flicker - and warp - free display provides excellent image geometry even in screen corners
- Not affected by magnetic fields, no color drift or edge distortion.
- VGA, SVGA, XGA, SXGA, UXGA computer signal compatibility
- NTSC, PAL, SECAM, composite and S-Video signal compatibility
- 480P, 1080I, 720P and HDTV signal compatibility
- PCs, VCRs, Laser Disc and DVD player source compatibility
- Sophisticated formatting circuitry automatically converts VGA, SVGA, XGA, SXGA and UXGA signals to the panel's native resolution
- Precision algorithms are used to convert interlaced signals to progressive scan.
- User selectable on-screen color temperature settings
- Component video input terminal for DVD, 15.75kHz (Y, CB, CR)
- Digital broadcasting source compatibility
- Menu-driven on-screen control system that makes image adjustments a snap
- Eight languages (English, German, French, Italian, Spanish, Swedish, Chinese and Russian.)

Contents of the Package

- Plasma display
- Power cord
- Remote control with two AAA Batteries
- Owner's guide
- Registration Card
- Safety metal fittings*
- Screws for safety metal fittings*
- Ferrite cores (large x 2)
- Cable clamps
- BNC-RCA Adapters

* These fittings are for fastening the unit to a wall to prevent tipping when used with an optional tabletop stand. Fasten the safety fittings to the holes in the back of the display using the mount screws.

Options

- Tabletop stand
- Tilt Wall Mount

Contents

Installation	1	Image Adjust Settings Menu	21
General Instructions	1	Adjusting the Position, Size, Fine Picture, Picture Adj	21
Ventilation requirements for enclosure mounting	1	Set Up Settings Menu	22
How to use the safety metal fittings and the screws for safety metal fittings	1	Setting the language for the menus	22
Part Names and Function	2	Setting the BNC connectors	22
Front View	2	Setting high definition images to the suitable screen size	22
Side View / Rear View	3	Setting a computer image to the correct RGB select screen	22
Remote Control	4	Setting the signal and black level for HDMI signal ...	23
Battery installation and replacement	5	Setting the video signal format	23
Operating range	5	Setting the background color when no signal is being input	23
Handling the remote control	5	Setting the gray level for the sides of the screen	24
Connections	6	Setting the screen size for S1/S2 video input	24
Connecting your PC or Macintosh computer	7	Turning the display menu on/off	24
Connecting your VCR	7	Setting the position of the menu	24
Connecting your DVD Player	7	Resetting to the default values	25
MonitorLink Connections	8	Functions Settings Menu	26
External HDMI Device	8	Setting the power management for computer images	26
Pin assignments and signal levels for 15 pin RGB (analog)	8	POWER/STANDBY indicator	26
Cable Management	9	Setting the Input Skip	26
Basic Operations	10	Reducing the burn-in of the screen	26
Power	10	Signal Information Menu	28
To turn the unit ON and OFF:	10	Checking the frequencies, polarities of input signals, and resolution	28
Volume	10	MonitorLink Control	29
To adjust the sound volume:	10	Troubleshooting	30
Mute	10	Technical Specifications PD-5050	32
To cancel the sound:	10	Technical Specifications PD-6150	33
Info	10	Table of Signals Supported	34
To check the settings:	10	Warranty	36
Digital Zoom	10		
Sleep/Off Timer	11		
To set the off timer:	11		
To check the remaining time:	11		
To cancel the off timer:	11		
Format Sizes	12		
Format Operation (manual)	12		
When viewing videos or digital video discs	12		
Format Operation with Computer Signals	13		
Menu Controls	14		
Menu Tree Operations	15		
Picture Settings Menu	17		
Storing picture settings	17		
Adjusting the picture	17		
Reducing noise in the picture	18		
Setting the color temperature	19		
Adjusting the color to the desired level	19		
Changing the Gamma Curve	19		
Making the Low Tone adjustments	19		
Adjusting the pedestal level	20		
ColorView™	20		
Film Mode	20		
Setting the picture mode according to the brightness of the room	20		
Audio Settings Menu	21		
Adjusting the treble, bass and left/right balance and audio input select	21		
Selecting the input of the audio connectors	21		

Installation

General Instructions

CAUTION

This device needs to be attached to a stand or other mounting hardware. Be sure to use a stand or other mounting hardware that is designed specifically for this product.

DO NOT USE THE BOTTOM CARTON AS A TEMPORARY OR PERMANENT STAND. (See Drawing A)

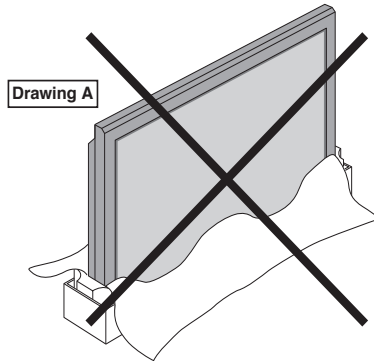

Drawing B

When installing or carrying, use the handles attached to the upper back of the display.



You can attach your optional mount or stand to the plasma display in the following way:

1. Before performing work make sure to disconnect the AC cord from the plasma display.
2. Before performing work spread the protective sheet, which was wrapped around the display, on a flat, even surface. This will prevent the display from being damaged.
3. Use the handles (Drawing B) to gently lay the plasma display face down on the protective sheet. (See Drawing C).
4. Do not touch or hold the screen face while carrying the display.
5. To complete the installation follow the instructions included with the stand or other mounting hardware.

Drawing C

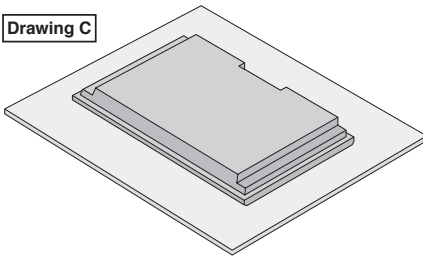

Ventilation requirements for enclosure mounting

To allow heat to disperse, leave space between surrounding objects as shown on the diagram below when installing.

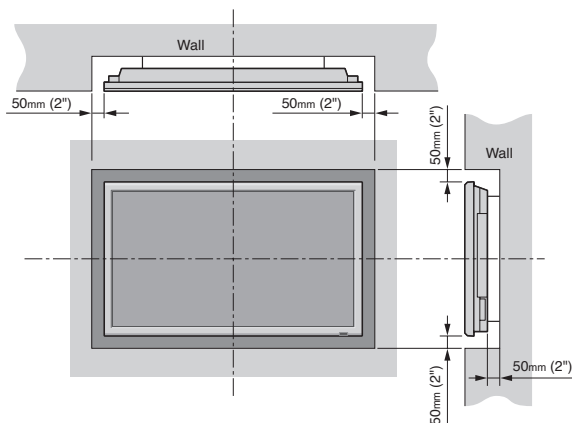

How to use the safety metal fittings and the screws for safety metal fittings

These are fittings for fastening the unit to a wall to prevent tipping due to external shock when using the stand (optional). Fasten the safety fittings to the holes in the back of the monitor using the safety fitting mount screws.

* Safety metal fittings will differ according to the model.

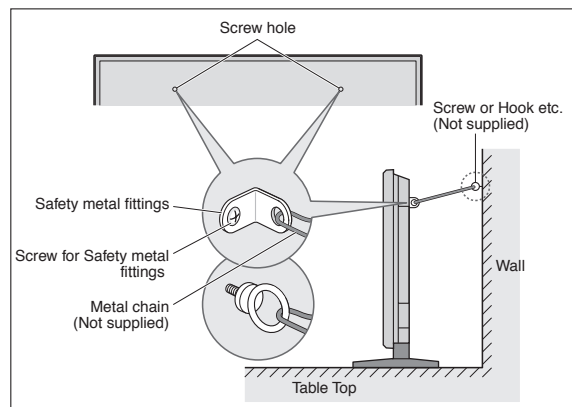

Part Names and Function

Front View

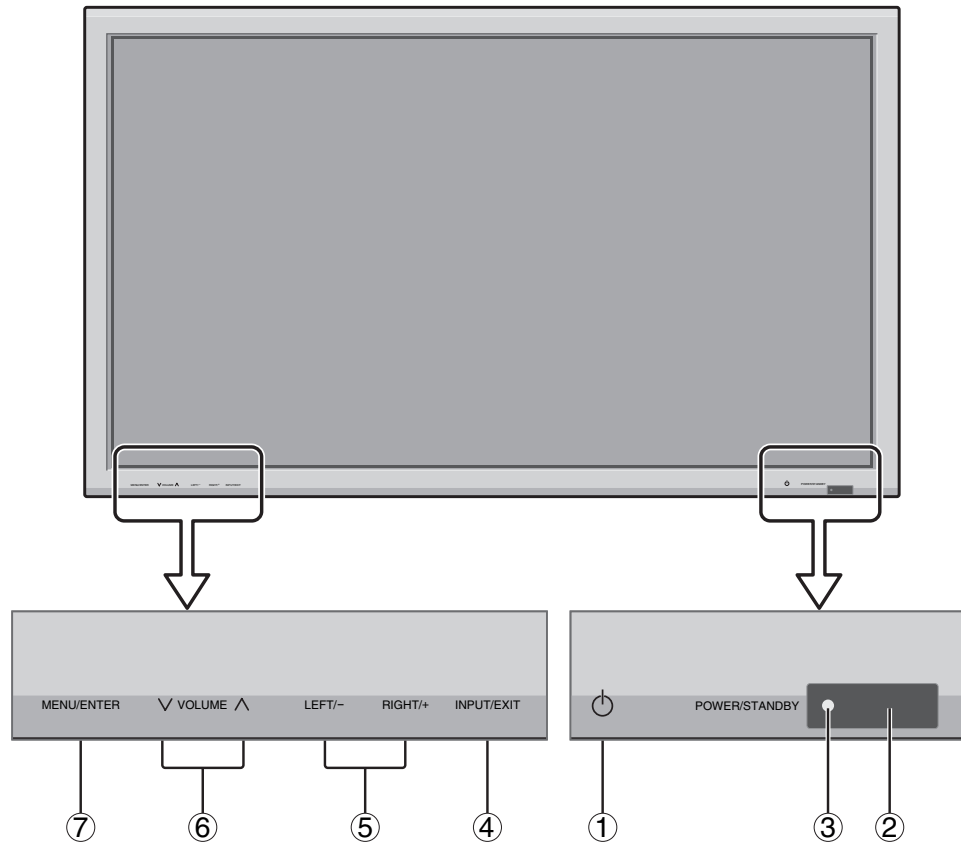

- ① **POWER**
Push this button to turn the display's main power on or off.
- ② **REMOTE SENSOR WINDOW**
Receives the signals from the remote control.
- ③ **POWER/STANDBY Indicator**
When the power is on Lights green.
When the power is in the standby mode ... Lights red.
- ④ **INPUT / EXIT BUTTON**
Switches the input.
The available inputs depend on the setting of "BNC INPUT", "RGB SELECT" and "HDMI SET UP".
Functions as the EXIT buttons in the On-Screen Menu mode.
- ⑤ **LEFT/- and RIGHT/+**
Functions as the ADJUST (◀/▶) buttons in the On-Screen Menu mode.
- ⑥ **VOLUME ∨ and ∧**
Adjusts the volume. Functions as the ADJUST (▼/▲) buttons in the On-Screen Menu mode.
- ⑦ **MENU/ENTER BUTTON**
Display the main menu or select a menu item.

WARNING
The Power on/off button does not disconnect the plasma display completely from the main power supply.

Side View

Rear View

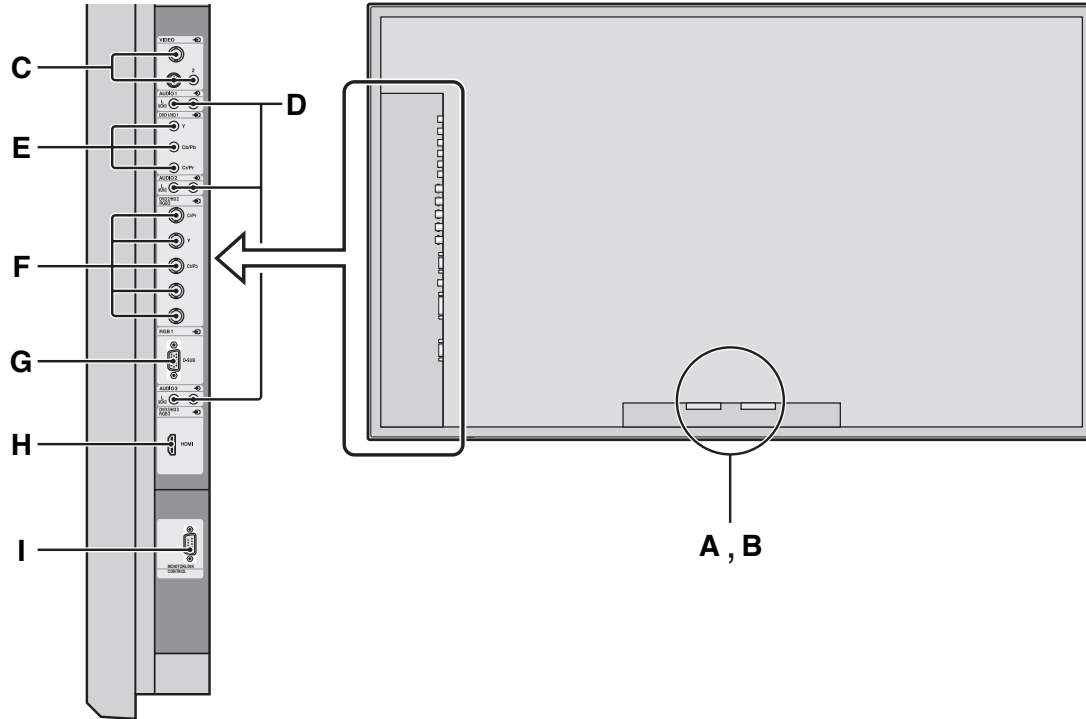

A AC IN

Connect the included power cord here.

B EXT SPEAKER L and R

Connect speakers (optional) here. Maintain the correct polarity. Connect the \oplus (positive) speaker wire to the \oplus EXT SPEAKER terminal and the \ominus (negative) speaker wire to the \ominus EXT SPEAKER terminal on both LEFT and RIGHT channels. Please refer to your speaker's owner's manual.

C INPUT 1, 2, 3 (BNC, RCA, S-Video)

Connect VCR's, DVD's or Video Cameras, etc. here.

D AUDIO1, AUDIO2, AUDIO3

These are audio input terminals. The input is selectable. Select which video input to assign them to from the audio menu screen.

E COMPONENT 1

Connect DVD's, Cable Boxes or High Definition sources, etc. here.

F RGB2 / COMPONENT 2

COMP2: You can connect DVDs, High Definition sources, Cable Boxes, etc. here.

This input can be set for use with an RGB or component source. (see page 22, **Setting the BNC connectors.**)

RGB2: You can connect an analog RGB signal and the synchronization signal.

G RGB1 (D-Sub)

Connect an analog RGB signal from a computer, etc. here.

H MONITORLINK/HDMI

Connect a digital signal from a source with a HDMI output.

I MONITORLINK CONTROL (RS-232C)

This terminal is used when operating and controlling the display externally (by external control).

Remote Control

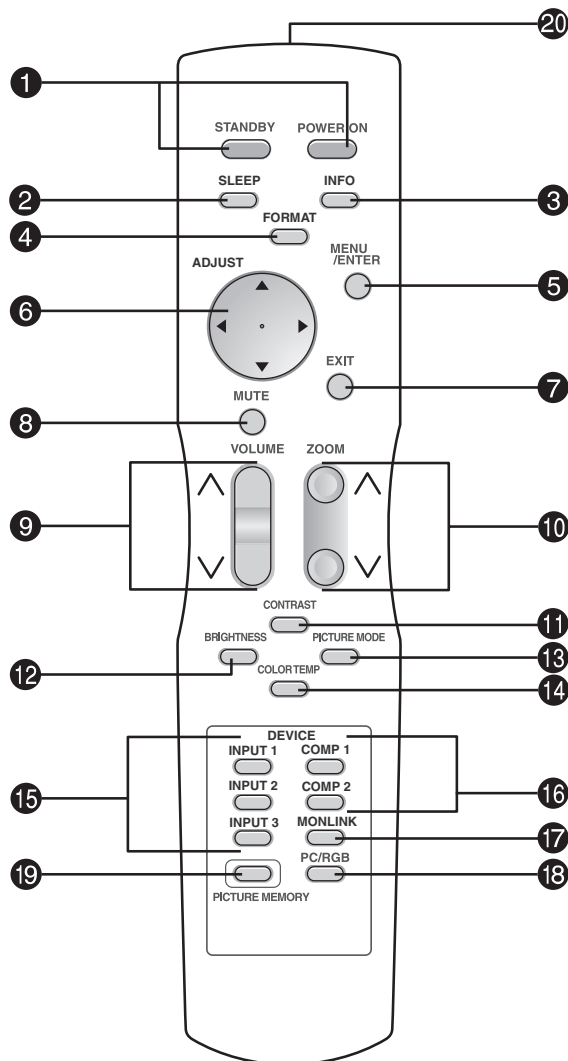

1 POWER ON/STANDBY

Switches the power to ON or STANDBY mode. (These buttons do not operate when POWER/STANDBY indicator of the main unit is off.)

2 SLEEP

Press this button to activate the off timer.

3 INFO

Displays the source settings on the screen.

4 FORMAT

Automatically detects the signal and sets the aspect ratio. FORMAT button is not active for all signals.

5 MENU/ENTER

Press this button to access the Menu.

Press this button during the display of the main menu to go to the sub menu.

6 ADJUST (▲ / ▼ / ◀ / ▶)

Use these buttons to select items or settings and to adjust settings or switch the display patterns.

7 EXIT

Press this button to exit the MAIN MENU. Press this button during the display of the sub menu to return to the previous menu.

8 MUTE

Press this button to mute the audio.

9 VOLUME (▲ / ▼)

Press this button to adjust audio volume.

10 ZOOM (▲ / ▼)

Press this button to enlarge or reduce the image.

11 CONTRAST

Press this button to adjust contrast directly.

12 BRIGHTNESS

Press this button to adjust brightness directly.

13 PICTURE MODE

Press this button to adjust picture mode directly.

14 COLOR TEMP

Press this button to adjust color tone directly.

15 INPUT 1, 2, 3

Press one of these buttons to select INPUT1 or INPUT2 or INPUT3 as the source.

INPUT 1-3 can also be selected using the INPUT/EXIT button on the front panel of the display.

16 COMP1, 2

Press one of these buttons to select COMP1 or COMP2 as the source.

COMP 1-2 can also be selected using the INPUT/EXIT button on the front panel of the display.

17 MONLINK

Press this button to select MONLINK/HDMI as the source.

18 PC/RGB

Press this button to select PC/RGB as the source. PC/RGB can also be selected using the INPUT SELECT button on the display.

19 PICTURE MEMORY

Switches sequentially between picture memory settings 1 to 6

20 Remote control signal transmitter

Transmits the remote control signal

How to use the remote control

Battery Installation and Replacement

Insert the 2 “AAA” batteries, making sure insert them with the proper polarity.

1. Remove the remote control’s back cover by gently pressing the rigid tab in the direction of the arrow.

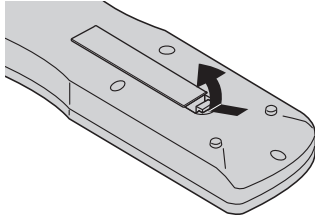

2. Install the batteries according to the (+) and (–) indication inside the case. For ease of installation, install the negative (–) side first.

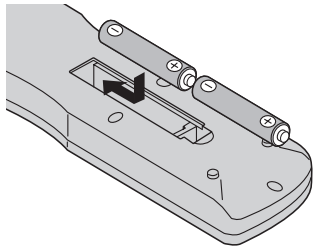

3. Replace the cover.

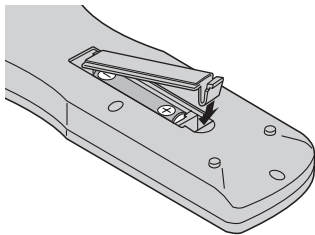

Operating Range

- * Use the remote control within a distance of about 7 m/ 23ft. from the front of the display’s remote control sensor and at horizontal and vertical angles of up to approximately 30°.
- * The remote control operation may not function if the display’s remote control sensor is exposed to direct sunlight or strong artificial light, or if there is an obstacle between the sensor and the remote control.

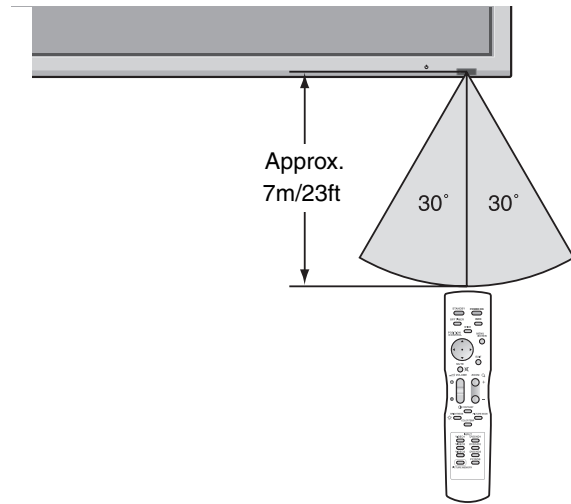

Handling the remote control

- Do not drop or mishandle the remote control.
- Do not get the remote control wet. If the remote control gets wet, wipe it dry immediately.
- Avoid heat and humidity.
- When not using the remote control for a long period, remove the batteries.
- Do not use new and old batteries together, or use different types together.
- Do not take apart the batteries, heat them, or throw them into a fire.

Connections

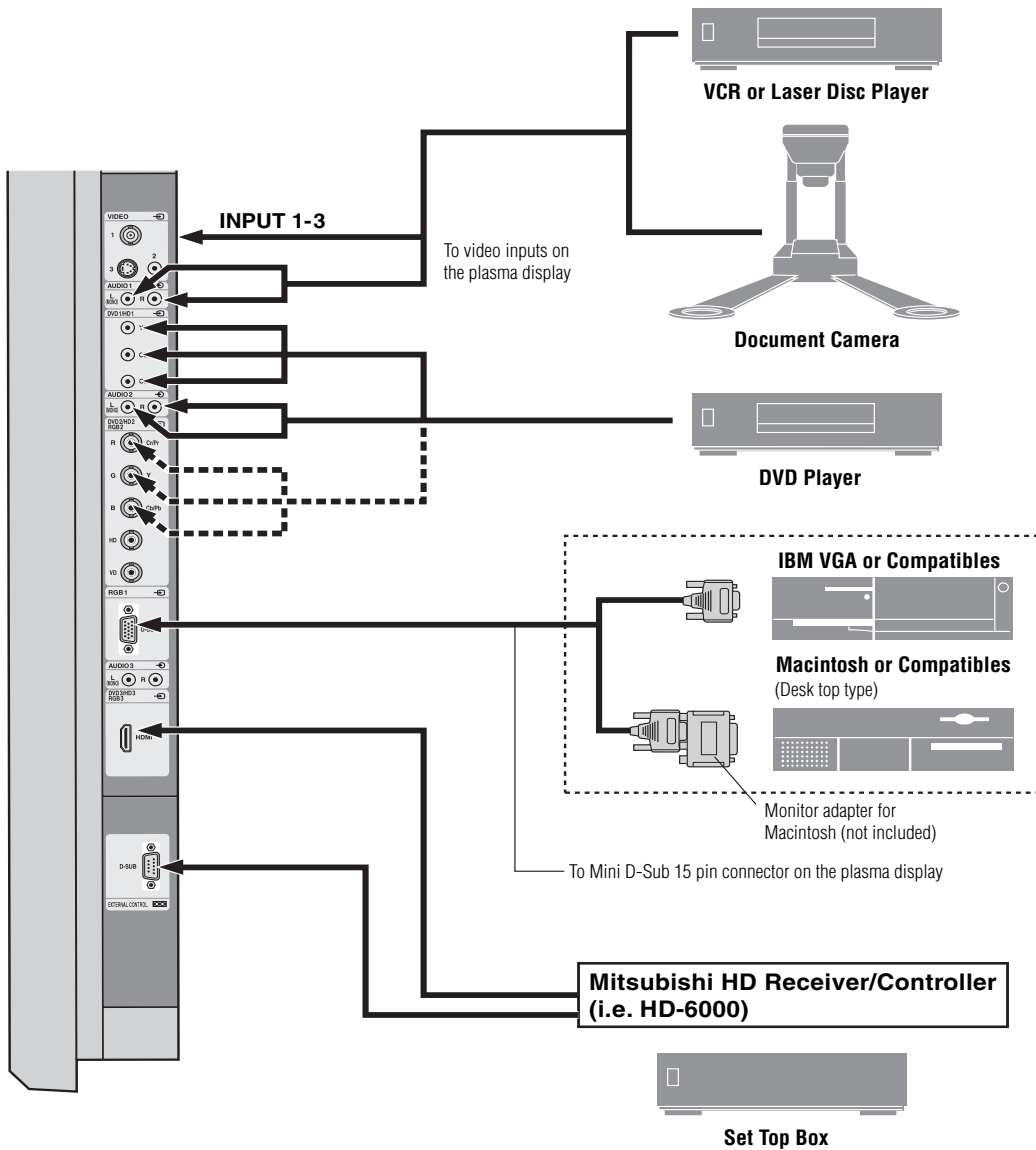

Connecting Your PC or Macintosh Computer

Connecting your PC or Macintosh computer to your plasma display will enable you to display your computer's screen image for an impressive presentation. The plasma display supports the signals described on page 34.

To connect a PC or Macintosh simply:

1. Turn off the power to your plasma display and computer.
2. If your PC does not support SXGA/XGA/SVGA/VGA you will need to install an SXGA/XGA/SVGA/VGA graphics board. Consult your computer's owner's manual for your SXGA/XGA/SVGA/VGA configuration. If you need to install a new board, see the manual that comes with your new graphics board for installation instructions.
3. This plasma display provides signal compatibility up to VESA 1600 × 1200 (UXGA). However, it is not recommended to use this resolution due to image readability.
4. Connect a D-sub HD15 pin cable* from the side of the display to a PC or Macintosh®. For Macintosh, use a monitor adapter (not included) to connect to your computer's video port, if necessary.
5. Turn on the plasma display and the computer.
6. If the plasma display goes blank after a period of inactivity, it may be caused by a screen saver installed on the computer you've connected to the plasma display.

When using a Macintosh with the plasma display, the following four display standards are supported using the Macintosh adapter :

- 13" fixed mode
- 16" fixed mode
- 19" fixed mode
- 21" fixed mode

The 19" fixed mode is recommended for your monitor.

*Note: D-sub HD15 pin cables, RCA cables, and component cables, can be found at your local electronics store.

Connecting Your VCR

Use common RCA cables* (not provided) to connect your VCR to your plasma display. To make these connections, simply:

1. Turn off the power to your plasma display and VCR.
2. Connect one end of your RCA cable to the video output connector on the back of your VCR, connect the other end to the Video input on your plasma display. Use standard RCA audio patch cables to connect the audio from your VCR to your plasma display (if your VCR has this capability). Be careful to keep your right and left channel connections correct for stereo sound.
3. Turn on the plasma display and the VCR.

Note: Refer to your owner's manual for more information about your equipment's video output requirements.

Connecting Your DVD Player

You can connect your plasma display to a DVD player. To do so, simply:

1. Turn off the power to your plasma display and DVD player.
2. Use a component video cable* (not provided) to connect your DVD player to the Y, Cb, and Cr inputs on your plasma display.
Or use the DVD-player's S-Video output. Use a standard S-Video (not provided) cable to connect to the S-Video input on the plasma display.
3. Use standard RCA audio patch cables to connect the audio from your DVD Player to your plasma display.
4. Turn on the plasma display and the DVD player.

MonitorLink™ Connections MonitorLink and MonitorLink Control

1. Connect a HDMI to HDMI cable from the MONLINK OUTPUT of a Mitsubishi HD-6000 Receiver/Controller to the MONLINK input on the plasma display. A HDMI to HDMI cable and a RS-232C cable are included in the HD-6000 accessory box.
2. Connect the L (left) and R (right) audio terminals from the Mitsubishi Receiver/Controller to AUDIO LEFT and AUDIO RIGHT on a stereo receiver.
3. Connect the MonitorLink Control cable (RS-232C) from the Mitsubishi Receiver/Controller back panel to the plasma display side panel.

External HDMI Device with HDCP Connection

HDMI (High Definition Multimedia Interface) is the first all digital consumer electronics A/V interface that supports uncompressed video and multi-channel audio in a single digital interface. You can connect an EIA/CEA-861/861B compliant consumer electronic device, such as a set top box or DVD player with a HDMI or DVI output terminal to the plasma display's HDMI input terminal. If the external device has a DVI output only, use a DVI to HDMI adapter cable to connect to the HDMI terminal.

1. Connect a HDMI cable from the HDMI output of the external HDMI device to the MonitorLink/HDMI input on the side of the plasma display.
2. Connect the L (left) and R (right) audio terminals from the external device to AUDIO LEFT and AUDIO RIGHT on a stereo receiver.

Note: When used as a HDMI/DVI Input, MonitorLink input is compliant with HDCP and the EIA-861 standards for standard, extended and high definition video. This input is not intended for use with personal computers or devices outputting video signals with computer resolution.

Pin Assignments and Signal Levels for D-sub HD15 pin RGB (Analog) Connector

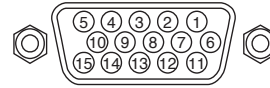

Pin No.	Signal (Analog)
1	Red
2	Green or sync-on-green
3	Blue
4	No connection
5	Ground
6	Red ground
7	Green ground
8	Blue ground
9	No connection
10	Sync signal ground
11	No connection
12	Bi-directional DATA (SDA)
13	Horizontal sync or Composite sync
14	Vertical sync
15	Data clock

Cable Management

Using the cable clamps provided with the plasma display bundle and attach the signal and audio cables to the back panel.

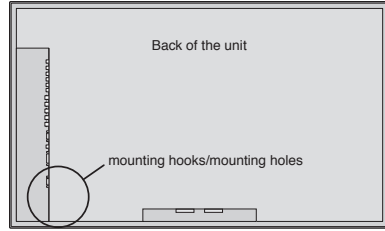

To attach

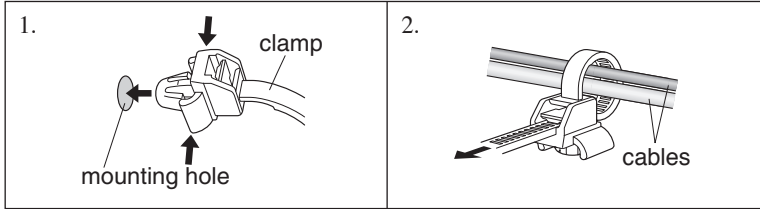

To detach

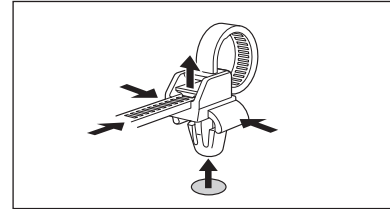

Basic Operations

POWER

ON:

1. Plug the power cord into an active AC power outlet.
2. Press the Power button located underneath the right side of the front panel.
The displays POWER/STANDBY indicator turns green and the plasma display is on.

OFF:

Press the Power button (underneath the front panel) to turn off the display.
The displays POWER/STANDBY indicator goes off.

STANDBY ON:

Press the POWER ON button (on the remote control) to turn on the display.
The display's POWER/STANDBY indicator will light up (green) when the plasma display is on.

STANDBY OFF:

Press the STANDBY button on the remote. The displays POWER/STANDBY indicator turns red and the standby mode is set.

VOLUME

To adjust the sound volume:

1. Press and hold the VOLUME \wedge button (on the remote control or the front panel) to increase the volume to the desired level.
2. Press and hold the VOLUME \vee button (on the remote control or the front panel) to decrease the volume to the desired level.

MUTE

To cancel the sound:

Press the MUTE button on the remote control to cancel the sound; press again to restore.

INFO

To check the settings:

1. The screen changes each time the INFO button is pressed.
2. If the button is not pressed for approximately three seconds, the menu turns off.

DIGITAL ZOOM

Digital zoom specifies the picture position and enlarges the picture.

1. Press the ZOOM (\wedge or \vee) button to display the magnifying glass. ()

To change the size of the picture:

Press the ZOOM \wedge button to enlarge the picture.
A press of the ZOOM \vee button will reduce the picture and return it to its original size.

To change the picture position:

Select the position with the \blacktriangle \blacktriangledown \blacktriangleleft \blacktriangleright buttons.

2. Press the EXIT button to exit the ZOOM mode.

SLEEP/OFF TIMER

To set the off timer:

The off timer can be set to turn the power off after 30, 60, 90 or 120 minutes.

1. Press the SLEEP button to start the timer at 30 minutes.
2. Press the SLEEP button to the desired time.
3. The timer starts when the menu turns off.

→ 30 → 60 → 90 → 120 → 0

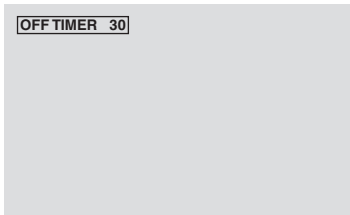

To check the remaining time:

1. Once the off timer has been set, press the SLEEP button once.
2. The remaining time is displayed, then turns off after a few seconds.
3. When five minutes remain the remaining time appears until it reaches zero.

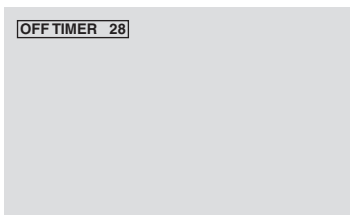

To cancel the off timer:

1. Press the SLEEP button twice in a row.
2. The off timer is canceled.



Note:

After the power is turned off with the off timer ... A slight current is still supplied to the display. When you are leaving the room or do not plan to use the system for a long period of time, turn off the displays main power using the Power Button located underneath the front panel.

Format Sizes

Format Operation (manual)

With this function, you can select one of six screen sizes.

When viewing videos or digital video discs

1. Press the FORMAT button on the remote control.
2. *Within 3 seconds ...*

Press the FORMAT button again.

The screen size switches as follows:

→ NARROW → STANDARD → STRETCH → EXPAND → ZOOM → 14:9

When a 720P or 1080I signal is input:

STANDARD ↔ ZOOM

NARROW screen size (4:3)

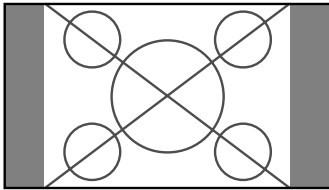

The NARROW screen size is displayed.

- * The picture has the same size as video pictures with a 4 : 3 aspect ratio.

STANDARD screen size

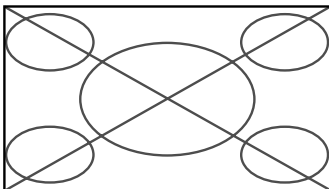

The image is expanded in the horizontal direction.

- * Images compressed in the horizontal direction ("squeezed images") are expanded in the horizontal direction and displayed on the entire screen with correct linearity. (Normal images are expanded in the horizontal direction.)

STRETCH screen size

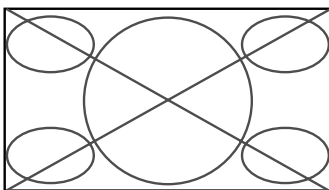

The picture is expanded in the horizontal and vertical directions at different ratios.

- * Use this for watching normal video programs (4:3) with a wide screen.

EXPAND screen size

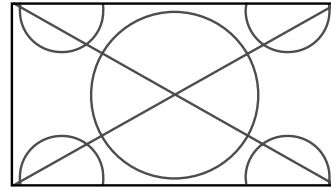

The picture is expanded in the horizontal and vertical direction, maintaining the original proportions.

- * Use this for theater size (wide) movies, etc.

ZOOM screen size

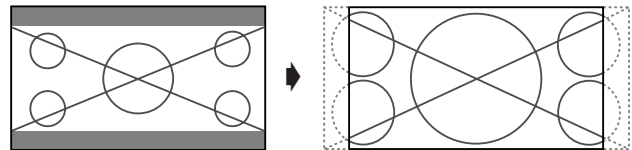

Original image

Information is lost on both sides.

The squeezed film image is expanded to fill the entire screen at a ratio of 2.35:1. Black bands do not appear at the top and bottom but information is lost on the left and right margins.

- This feature is available when the input signal is video, component (480I, 480P, 576I, 576P, 720P, 1080I) or RGB (525P or 625P signal from a scan converter).
- * If black bands appear on the top and bottom in the full screen size, select the 2.35:1 size screen to avoid phosphor burn-in.

14:9 screen size

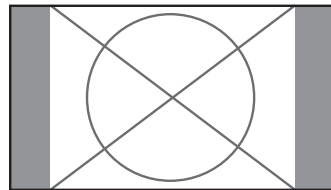

The image is displayed at a 14:9 aspect ratio.

- * This feature is available when the input signal is video, component (480I, 480P, 576I, 576P) or RGB (525P or 625P signal from a scan converter).

WARNING

DO NOT OPERATE THE PLASMA DISPLAY IN NARROW (4:3) SCREEN SIZE MODE OR 14:9 SCREEN SIZE MODE FOR AN EXTENDED PERIOD. THE SIDE BARS CAN CAUSE PHOSPHOR BURN-IN.

Format Operation with Computer Signals

Switch to the wide screen mode to expand the 4 : 3 image to fill the entire screen.

1. Press the FORMAT button on the remote control.
2. *Within 3 seconds ...*

Press the FORMAT button again.
The screen size switches as follows:

→ NARROW → STANDARD → EXPAND

NARROW screen size (4:3 or SXGA 5:4)

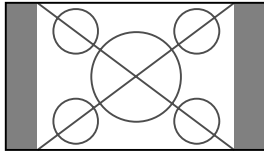

The picture has the same size as the normal computer image.

STANDARD screen size

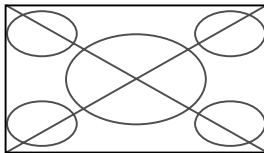

The image is expanded in the horizontal direction.

EXPAND screen size

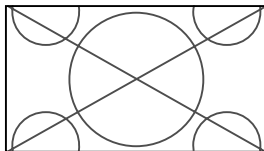

When wide signals are input.

STANDARD screen size

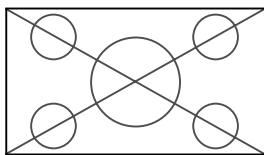

Information

■ Supported resolution

See page 34 for details on the display output of the various VESA signal standards supported by the display.

■ **When 852 (848) dot × 480 line wide VGA* signals with a vertical frequency of 60 Hz and horizontal frequency of 31.7 (31.0) kHz are input**

Select an appropriate setting for RGB SELECT mode referring to the “Table of Signals Supported” on page 34.

* “VGA”, “SVGA” and “SXGA” are registered trademarks of IBM, Inc. of the United States.

WARNING

DO NOT OPERATE THE PLASMA DISPLAY IN NARROW (4:3) SCREEN SIZE MODE FOR AN EXTENDED PERIOD. THIS CAN CAUSE PHOSPHOR BURN-IN.

Menu Controls

Menu Operations

The following describes how to use the menus and the selected items.

1. Press the MENU/ENTER button on the remote control to display the MAIN MENU.

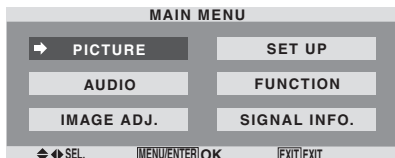

2. Press the ADJUST buttons ▲ ▼ ◀ and ▶ on the remote control to highlight the menu you wish to enter.
3. Press the MENU/ENTER button on the remote control to select a sub menu or item.

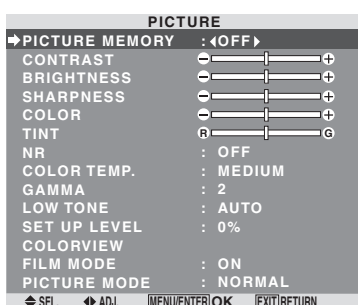

4. Adjust the level or change the setting of the selected item by using the ADJUST buttons ◀ ▶ on the remote control.

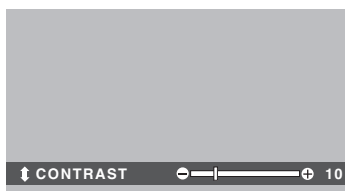

5. The adjustments or the settings are stored in memory. If neither the ◀ or ▶ button is pressed within 5 seconds, the current setting is stored into memory and the previous screen appears.
6. Repeat steps 2 – 5 to adjust an additional item, or press the EXIT button on the remote control to return to the MAIN MENU.

Note: The main menu disappears by pressing the EXIT button.

Menu Tree

Shaded areas indicate the default value.

←→+ : Press the ◀ or ▶ button to adjust. The default value is at the center.

Main menu	Sub menu	Sub menu 2	Sub menu 3	Sub menu 4	RESET	PAGE # REFERENCE	
PICTURE	PICTURE MEMORY	OFF/MEMORY1-6			YES	17	
	CONTRAST	←→+ 0←52→72			YES	17	
	BRIGHTNESS	←→+ 0←32→64			YES	17	
	SHARPNESS	←→+ 0←16→32			YES	17	
	COLOR	←→+ 0←32→64			YES	17	
	TINT	R←→G 0←32→64			YES	17	
	NR	OFF/NR-1/NR-2/NR-3			YES	18	
	COLOR TEMP.	LOW/MID LOW/MEDIUM/HIGH			YES	19	
	WHITE BALANCE	GAIN RED	←→+ 0←40→70			YES	19
		GAIN GREEN	←→+ 0←40→70			YES	19
		GAIN BLUE	←→+ 0←40→70			YES	19
		BIAS RED	←→+ 0←40→70			YES	19
		BIAS GREEN	←→+ 0←40→70			YES	19
		BIAS BLUE	←→+ 0←40→70			YES	19
		RESET	OFF←→ON			YES	19
		GAMMA	1←2←3→4			YES	19
		LOW TONE	AUTO←→1←...→3			YES	19
	SET UP LEVEL	0%←→3.75%←→7.5%			YES	20	
	COLORVIEW	RED	Y←→M 0←32→64			YES	20
		GREEN	C←→Y 0←32→64			YES	20
		BLUE	M←→C 0←32→64			YES	20
		YELLOW	G←→R 0←32→64			YES	20
		MAGENTA	R←→B 0←32→64			YES	20
		CYAN	B←→G 0←32→64			YES	20
		RESET	OFF←→ON			YES	20
	FILM MODE	ON←→OFF			YES	20	
	PICTURE MODE	NORMAL/THEATER1/THEATER2/DEFAULT/BRIGHT			YES	20	

Main menu	Sub menu	Sub menu 2	Sub menu 3	Sub menu 4	RESET	REFERENCE
AUDIO	BASS	←→+ 0←13→26			YES	21
	TREBLE	←→+ 0←13→26			YES	21
	BALANCE	L←→R -22←0→+22			YES	21
	AUDIO INPUT1	INPUT 1-3 / COMP 1-2 / PC / RGB			YES	21
	AUDIO INPUT2	INPUT 1-3 / COMP 1-2 / PC / RGB			YES	21
	AUDIO INPUT3	INPUT 1-3 / COMP 1-2 / PC / RGB			YES	21

Main menu	Sub menu	Sub menu 2	Sub menu 3	Sub menu 4	RESET	REFERENCE
IMAGE ADJUST	ASPECT MODE	EXPAND/NARROW/STANDARD/STRETCH/14:9/ZOOM			NO	21
	V-POSITION	←→+ -64←0→+64			YES	21
	H-POSITION	←→+ -128←0→+127			YES	21
	V-HEIGHT	←→+ 0←64			YES	21
	H-WIDTH	←→+ 0←64			YES	21
	AUTO PICTURE	ON←→OFF*2			NO	21
	FINE PICTURE*1	←→+ *2 0←64			YES	21
	PICTURE ADJ.*1	←→+ *2 0←64→128			YES	21

Main menu	Sub menu	Sub menu 2	Sub menu 3	Sub menu 4	RESET	REFERENCE	
SET UP	LANGUAGE	ENGLISH/DEUTSCH/FRANÇAIS/ESPAÑOL/ITALIANO/SVENSKA/中文/РУССКИЙ			NO	22	
	BNC INPUT	RGB←→COMPONENT			YES	22	
	HD SELECT	1080I/1035I/540P			NO	22	
	RGB SELECT	AUTO/STILL/MOTION/WIDE1/WIDE2/WIDE3/DTV			YES	22	
	HDMI SET UP	PLUG/PLAY	PC←→STB/DVD			NO	23
		BLACK LEVEL	LOW←→HIGH			NO	23
		COLOR SYSTEM	AUTO/PAL/PAL-M/PAL-N/PAL 60/SECAM/4.43 NTSC/3.58NTSC			NO	23
	BACK GROUND	GRAY/BLACK			YES	23	
	GRAY LEVEL	0←...→2←...→15			YES	24	
	S1/S2	AUTO←→OFF			YES	24	
	DISPLAY MENU	ON←→OFF			YES	24	
	MENU ADJUST	TOP LEFT←→TOP CENTER←→TOP RIGHT←→BTM LEFT←→BTM CENTER←→BTM RIGHT			YES	24	
	ALL RESET	ON←→OFF			—	25	

Main menu	Sub menu	Sub menu 2	Sub menu 3	Sub menu 4	RESET	PAGE # REFERENCE	
FUNCTION	POWER MGT.	ON←→OFF			YES	26	
	INPUT SKIP	ON←→OFF			YES	26	
	LONGLIFE	MANUAL/AUTO				YES	26
		PEAK BRIGHT		100%/75%/50%/25%		YES	27
		ORBITER		AUTO1/AUTO2/OFF		YES	27
		INVERSE/WHITE		OFF/INVERSE/WHITE		YES	27
		SOFT FOCUS		OFF/1-4		YES	27
		ORBITER MENU		ON/OFF		YES	28
		MENU CONTRAST		NORMAL/LOW		YES	28
Main menu	Sub menu	Sub menu 2	Sub menu 3	Sub menu 4	RESET	REFERENCE	
SIGNAL INFO.					—	28	

*1 Only when AUTO PICTURE is OFF.

*2 RGB/PC only

Information

■ Restoring the factory default settings

Select "ALL RESET" under the SET UP menu. Note that this also restores other settings to the factory defaults.

Picture Settings Menu

Storing picture settings

This function allows you to store in memory the current input signal and PICTURE menu settings and to recall these settings when necessary.

There are six picture memory locations available, and notes of up to 15 characters can be added to each.

Example: Storing picture settings at MEMORY1

Press MENU/ENTER button to access MAIN MENU. Use the ◀▶▲▼ buttons to select the PICTURE menu and then press the MENU/ENTER button.

Use the ▲▼ buttons to select the PICTURE MEMORY setting.

Use the ◀▶ buttons to change PICTURE MEMORY: OFF to PICTURE MEMORY: MEMORY1 and then press the MENU/ENTER button.

The “PICTURE MEMORY” screen appears.

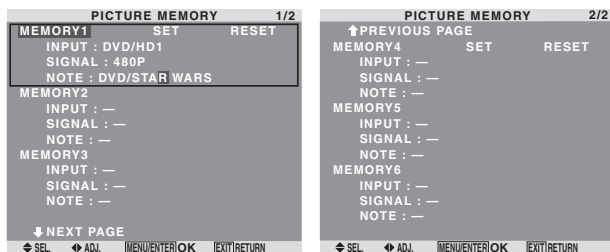

Adjusting the picture

The contrast, brightness, sharpness, color and tint can be adjusted as desired.

Example: Adjusting the contrast

Press MENU/ENTER button to access MAIN MENU.

Use the ◀▶▲▼ buttons to select the PICTURE menu and then press the MENU/ENTER button.

Use the ▲▼ buttons to select the CONTRAST setting.

Use the ◀▶ buttons to decrease or increase CONTRAST.

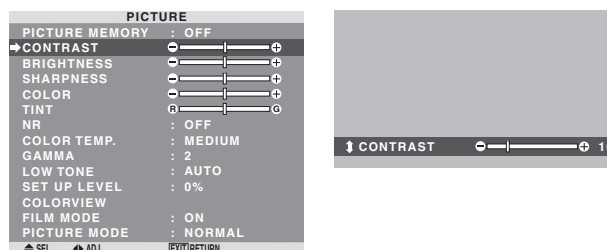

Note: If “CAN NOT ADJUST” appears ...
When trying to enter the PICTURE submenu, make sure PICTURE MODE is not set to DEFAULT.

Information

■ PICTURE MEMORY Settings

OFF: Picture memory not used.

MEMORY1 to 6: There are six available picture memory locations.

■ Setting the memory

- Use the ▲ and ▼ button to select the desired memory location, MEMORY1 to MEMORY6.
- Use the ◀ and ▶ buttons to select “SET”, then press the MENU/ENTER button.
- If necessary, input a note.

■ Resetting the memory

Use the ▲ and ▼ button to select the desired memory location, MEMORY1 to MEMORY6, then use the ◀ and ▶ buttons to select “RESET”, and finally press the MENU/ENTER button.

The memory is cleared, and “—” is displayed in the “INPUT”, “SIGNAL” and “NOTE” columns.

■ Inputting notes

- Use the ◀ and ▶ buttons to select “NOTE”, then press the MENU/ENTER button.
- Input the note.
Use the ▲ and ▼ button to select the character.
Use the ◀ and ▶ buttons to move the cursor.
Use the EXIT button to delete the character at the cursor position.
- When you have finished inputting the note, press the MENU/ENTER button.

Information

■ Picture adjustment screen

CONTRAST: Changes the picture’s white level.

BRIGHTNESS: Changes the picture’s black level.

SHARPNESS: Changes the picture’s sharpness.

COLOR: Changes the color intensity.

TINT: Changes the picture’s tint. Adjust for natural colored skin, background, etc.

■ Adjusting the computer image

Only the contrast and brightness can be adjusted when a computer signal is connected.

■ Restoring the factory default settings

Select “DEFAULT” under the “PICTURE MODE” settings.

Reducing noise in the picture

Use these settings if the picture has noise due to poor reception or when playing video tapes which have poor picture quality.

Example: Setting "NR-3"

Press MENU/ENTER button to access MAIN MENU.

Use the ◀ ▶ ▲ ▼ buttons to select the PICTURE menu and then press the MENU/ENTER button.

Use the ▲ ▼ buttons to select the NR setting.

Use the ◀ ▶ buttons to change NR.

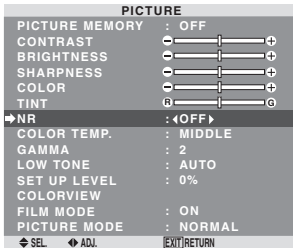

Information

■ NR

- * "NR" stands for Noise Reduction.
- * This function reduces noise in the picture.

■ Types of noise reduction

There are three levels of noise reduction.
The effect becomes stronger as the number increases
(in the order NR-1 → NR-2 → NR-3).
OFF: Turns the noise reduction function off.

Setting the color temperature

Use this procedure to set color tone produced by the plasma display.

Example: Setting "HIGH"

Press MENU/ENTER button to access MAIN MENU.

Use the ◀▶▲▼ buttons to select the PICTURE menu and then press the MENU/ENTER button.

Use the ▲▼ buttons to select the COLOR TEMP setting.

Use the ◀▶ buttons to change COLOR TEMP to HIGH.

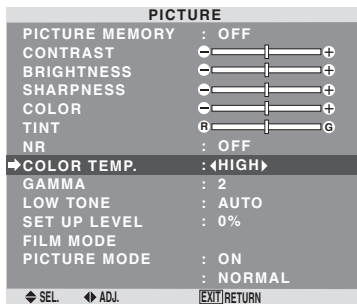

Information

■ Setting the color temperature

LOW: Redder

MID LOW: Slightly red

MEDIUM: Standard (slightly bluer)

HIGH: Bluer

Adjusting the color to the desired level

Use this procedure to adjust the white balance for each color temperature to achieve the desired color quality.

Example: Adjusting the "GAIN RED" of "HIGH" color temperature

Press MENU/ENTER button to access MAIN MENU.

Use the ◀▶▲▼ buttons to select the PICTURE menu and then press the MENU/ENTER button.

Use the ▲▼ buttons to select the COLOR TEMP setting.

Use the ◀▶ buttons to change COLOR TEMP to HIGH.

Then press MENU/ENTER. The "WHITE BALANCE" screen will appear.

Use the ▲▼ buttons to select the GAIN RED.

Use the ◀▶ buttons to decrease or increase GAIN RED.

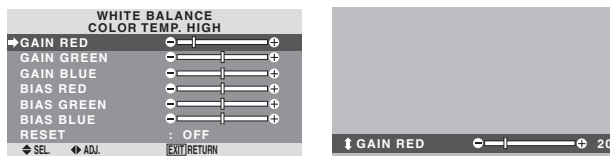

Information

■ Adjusting the white balance

GAIN R/G/B: White balance adjustment for white level

BIAS R/G/B: White balance adjustment for black level

RESET: Resets settings to the factory default values.

Use ◀ and ▶ buttons to select "ON", then press the MENU/ENTER button.

■ Restoring the factory default settings

Select "RESET" under the WHITE BALANCE menu.

Changing the Gamma Curve

This feature adjusts the brightness of the midtone areas while keeping shadows and highlights unchanged.

Example: Setting "2"

Press MENU/ENTER button to access MAIN MENU.

Use the ◀▶▲▼ buttons to select the PICTURE menu and then press the MENU/ENTER button.

Use the ▲▼ buttons to select the GAMMA setting.

Use the ◀▶ buttons to decrease or increase GAMMA.

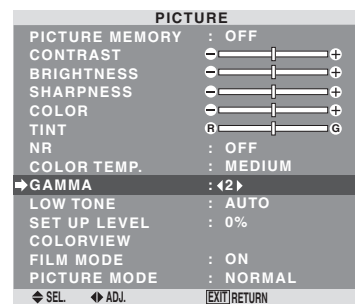

Information

■ GAMMA settings

The picture becomes darker as the number increases (in the sequence of 1, 2, 3, 4).

Making the Low Tone adjustments

This feature allows more detailed tone to be reproduced especially in dark areas.

Example: Setting "2"

Press MENU/ENTER button to access MAIN MENU.

Use the ◀▶▲▼ buttons to select the PICTURE menu and then press the MENU/ENTER button.

Use the ▲▼ buttons to select the LOW TONE setting.

Use the ◀▶ buttons to change LOW TONE.

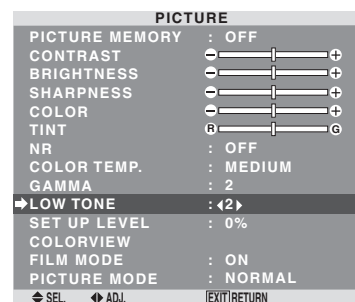

Information

■ LOW TONE settings

AUTO: Will automatically evaluate the picture and make adjustments.

1: Will apply the dither method suitable for still pictures.

2: Will apply the dither method suitable for motion pictures.

3: Will apply the error diffusion method.

Adjusting the pedestal level (black level)

This feature adjusts the video black level in a video image.

Example: Setting "3.75%"

Press MENU/ENTER button to access MAIN MENU.

Use the ◀▶▲▼ buttons to select the PICTURE menu and then press the MENU/ENTER button.

Use the ▲▼ buttons to select the SET UP LEVEL setting.

Use the ◀▶ buttons to change the SET UP LEVEL.

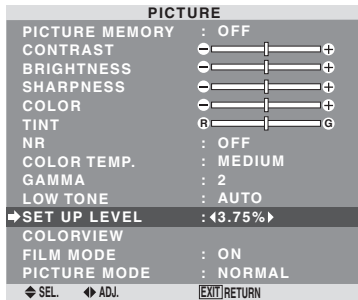

Information

■ SET UP LEVEL settings

0%: Normal status

3.75%: 3.75% lower than normal

7.5%: 7.5% lower than normal

ColorView™

Use this procedure to adjust hue and color density for red, green, blue, yellow, magenta and cyan.

You can accentuate the green color of trees, the blue of the sky, etc.

Example: Using COLORVIEW

Press MENU/ENTER button to access MAIN MENU.

Use the ◀▶▲▼ buttons to select the PICTURE menu and then press the MENU/ENTER button.

Use the ▲▼ buttons to select COLORVIEW and then press the MENU/ENTER button.

Use the ▲▼ buttons to select the color you want to adjust.

Use the ◀▶ buttons to adjust the color.

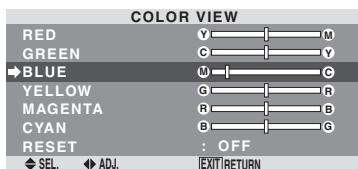

Information

■ COLORVIEW settings

RED: Adjust red

GREEN: Adjust green

BLUE: Adjust blue

YELLOW: Adjust yellow

MAGENTA: Adjust magenta

CYAN: Adjust cyan

RESET: Resets settings to the factory default value.

Use ◀ and ▶ buttons to select "ON", then press the MENU/ENTER button.

FILM Mode

Press MENU/ENTER button to access MAIN MENU.

Use the ◀▶▲▼ buttons to select the PICTURE menu and then press the MENU/ENTER button.

Use the ▲▼ buttons to select the FILM MODE setting.

Use the ◀▶ buttons to turn FILM MODE on or off.

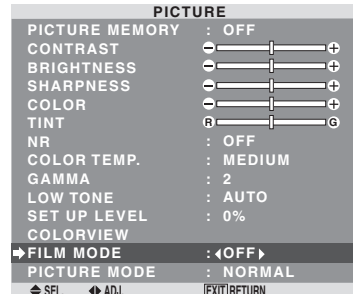

Information

■ FILM MODE

ON: Automatic discrimination of the image and projection in FILM mode.

OFF: FILM mode does not function.

Setting the picture mode according to the brightness of the room

There are four picture modes that can be used effectively according to the environment in which you are viewing the display.

Press MENU/ENTER button to access MAIN MENU.

Use the ◀▶▲▼ buttons to select the PICTURE menu and then press the MENU/ENTER button.

Use the ▲▼ buttons to select the PICTURE MODE setting.

Use the ◀▶ buttons to change the PICTURE MODE.

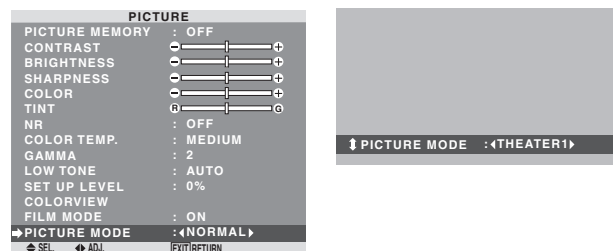

Information

■ Types of picture modes

THEATER1, 2: Set this mode when watching video in a dark room.

This mode provides darker, finer pictures, like the screen in movie theaters.

For a darker image, select THEATER2.

NORMAL: Set this mode when watching video in a bright room.

This mode provides dynamic pictures with distinct differences between light and dark sections.

BRIGHT: This mode provides brighter pictures than NORMAL.

DEFAULT: Use this to reset the picture to the factory default settings.

Audio Settings Menu

Adjusting the treble, bass and left/right balance and audio input select

The treble, bass and left/right balance can be adjusted to suit your tastes.

Example: Adjusting the bass

Press MENU/ENTER button to access MAIN MENU.

Use the ◀ ▶ ▲ ▼ buttons to select the AUDIO menu and then press the MENU/ENTER button.

Use the ▲ ▼ buttons to select the BASS setting.

Use the ◀ ▶ buttons to decrease or increase BASS level.

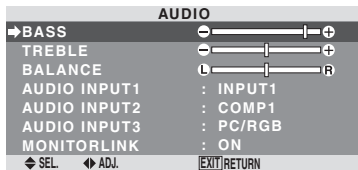

Note : If “CAN NOT ADJUST” appears...
Set “AUDIO INPUT” on the AUDIO menu correctly.

Information

■ Audio settings menu

BASS: Controls the level of low frequency sound.

TREBLE: Controls the level of high frequency sound.

BALANCE: Controls the balance of the left and right channels.

Selecting the Input of the audio connectors

Setting the AUDIO 1, 2, and 3 connectors to the desired input.

Example: Setting “AUDIO INPUT1” to “VIDEO 2”

Press MENU/ENTER button to access MAIN MENU.

Use the ◀ ▶ ▲ ▼ buttons to select the AUDIO menu and then press the MENU/ENTER button.

Use the ▲ ▼ buttons to select the appropriate AUDIO INPUT (1-3).

Use the ◀ ▶ buttons to select the appropriate input source. The available sources depend on input settings.

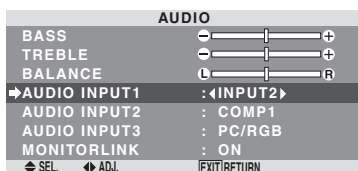

Information

■ AUDIO INPUT

A single audio input cannot be selected as the audio channel for more than one input terminal.

Image Adjust Settings Menu

Adjusting the Position, Size, Fine Picture, Picture Adj

The position of the image can be adjusted and flickering of the image can be corrected.

Example: Adjusting the vertical position in the normal mode

Press MENU/ENTER button to access MAIN MENU.

Use the ◀ ▶ ▲ ▼ buttons to select the IMAGE ADJ. menu and then press the MENU/ENTER button.

NARROW ↔ STANDARD

* The mode can also be switched by pressing the FORMAT button on the remote control.

* The settings on the IMAGE ADJUST menu are not preset at the factory.

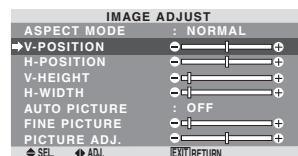

Information

■ When “AUTO PICTURE” is “OFF”

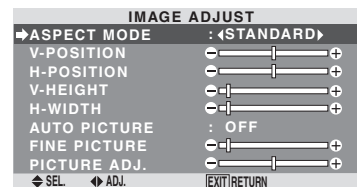

When Auto Picture is off, the Fine Picture and the Picture ADJ. items are displayed so that you can adjust them.

■ Adjusting the Auto Picture

ON: The PICTURE ADJ., FINE PICTURE and Position adjustments are made automatically.

Not available for digital ZOOM.

OFF: The PICTURE ADJ., FINE PICTURE and Position adjustments are made manually.

* If FINE PICTURE can't be adjusted, set AUTO PICTURE to OFF and adjust manually.

■ Adjusting the position of the image

V-POSITION: Adjusts the vertical position of the image.

H-POSITION: Adjusts the horizontal position of the image.

V-HEIGHT: Adjusts the vertical size of the image. (Except for STRETCH mode)

H-WIDTH: Adjusts the horizontal size of the image. (Except for STRETCH mode)

FINE PICTURE*: Adjusts for flickering.

PICTURE ADJ.*: Adjusts for striped patterns on the image.

* The PICTURE ADJ. and FINE PICTURE features are available only when the “AUTO PICTURE” is off.

* The AUTO PICTURE, FINE PICTURE and PICTURE ADJ. are available only for RGB signals.

These features are not available for moving pictures on INPUT, COMP or RGB.

SET UP Settings Menu

Setting the language for the menus

The menu display can be set to one of eight languages.

Example: Setting the menu display to “DEUTSCH”

Press MENU/ENTER button to access the MAIN MENU.

Use the ◀ ▶ ▲ ▼ buttons to select the SET UP menu and then press the MENU/ENTER button.

Use the ▲ ▼ buttons to select the LANGUAGE setting.

Use the ◀ ▶ buttons to change the LANGUAGE.

SET UP	
▶ LANGUAGE	: ◀ DEUTSCH ▶
BNC INPUT	: COMPONENT
HD SELECT	: 1080I
RGB SELECT	: AUTO
HDMI SET UP	
COLOR SYSTEM	: AUTO
BACK GROUND	: GRAY
GRAY LEVEL	: 3
S1/S2	: OFF
DISPLAY MENU	: ON
MENU ADJUST	: TOP LEFT
ALL RESET	: OFF
◀ SEL. ▶ ADJ. [EXIT] RETURN	

Information

■ Language settings

ENGLISH	English	ITALIANO	Italian
DEUTSCH	German	SVENSKA	Swedish
FRANÇAIS	French	中文	Chinese
ESPAÑOL	Spanish	РУССКИЙ	Russian

Setting the BNC connectors

Select whether to set the input of the 5 BNC connectors to RGB or component.

Example: Set the BNC INPUT mode to “RGB”

Press MENU/ENTER button to access the MAIN MENU.

Use the ◀ ▶ ▲ ▼ buttons to select the SET UP menu and then press the MENU/ENTER button.

Use the ▲ ▼ buttons to select BNC INPUT setting.

Use the ◀ ▶ buttons to change the BNC INPUT.

SET UP	
LANGUAGE	: ENGLISH
▶ BNC INPUT	: ◀ RGB ▶
HD SELECT	: 1080I
RGB SELECT	: AUTO
HDMI SET UP	
COLOR SYSTEM	: AUTO
BACK GROUND	: GRAY
GRAY LEVEL	: 3
S1/S2	: OFF
DISPLAY MENU	: ON
MENU ADJUST	: TOP LEFT
ALL RESET	: OFF
◀ SEL. ▶ ADJ. [EXIT] RETURN	

Information

■ BNC INPUT Settings

RGB: Use the 5BNC terminals for RGB input.

COMPONENT: Use the 3BNC terminals for component input.

Setting high definition images to the suitable screen size

DO NOT CHANGE THIS SETTING. 1080I is the US digital broadcast standard. The other two formats (1035I, 540p) will not display properly.

SET UP	
LANGUAGE	: ENGLISH
BNC INPUT	: COMPONENT
▶ HD SELECT	: ◀ 1035I ▶
RGB SELECT	: AUTO
HDMI SET UP	
COLOR SYSTEM	: AUTO
BACK GROUND	: GRAY
GRAY LEVEL	: 3
S1/S2	: OFF
DISPLAY MENU	: ON
MENU ADJUST	: TOP LEFT
ALL RESET	: OFF
◀ SEL. ▶ ADJ. [EXIT] RETURN	

Information

■ HD SELECT modes

1080I: Standard digital broadcasts

1035I: Japanese “High Vision” signal format

540P: Special Digital broadcasts (for example : DTC100)

Setting a computer image to the correct RGB select screen

With a computer image, select the RGB SELECT mode for a moving image such as (video) mode, wide mode or digital broadcast.

Press MENU/ENTER button to access MAIN MENU.

Use the ◀ ▶ ▲ ▼ buttons to select the SET UP menu and then press the MENU/ENTER button.

Use the ▲ ▼ buttons to select the RGB SELECT setting.

Use the ◀ ▶ buttons to change the RGB SELECT setting.

SET UP	
LANGUAGE	: ENGLISH
BNC INPUT	: COMPONENT
HD SELECT	: 1080I
▶ RGB SELECT	: ◀ MOTION ▶
HDMI SET UP	: 1024 × 768
COLOR SYSTEM	: AUTO
BACK GROUND	: GRAY
GRAY LEVEL	: 3
S1/S2	: OFF
DISPLAY MENU	: ON
MENU ADJUST	: TOP LEFT
ALL RESET	: OFF
◀ SEL. ▶ ADJ. [EXIT] RETURN	

Information

■ RGB SELECT modes

One of these 7 modes must be selected in order to display the following signals correctly.

AUTO: Select the suitable mode for the specifications of input signals as listed in the table “Computer input signals supported by this system” on page 7 of Model Information.

STILL: To display VESA standard signals. (Use this mode for a still image from a computer.)

MOTION: The video signal (from a scan converter) will be converted to a RGB signal. This makes the picture more easily viewable. (Use this mode for a motion image from a computer.)

WIDE1: When a 852 dot × 480 line signal with a horizontal frequency of 31.7kHz is input, the image may be compressed horizontally. To prevent this, set RGB SELECT to WIDE1.

WIDE2: When a 848 dot × 480 line signal with a horizontal frequency of 31.0 kHz is input, the image may be compressed horizontally. To prevent this, set RGB SELECT to WIDE2.

WIDE3: When a 1920 dot × 1200 line signal with a horizontal frequency of 74.0 kHz is input, the image may be compressed horizontally. To prevent this, set RGB SELECT to WIDE3.

DTV: Set this mode when watching digital broadcasting (480P).

See page 7 of Model Information for the details of the above settings.

Setting the signal and black level for HDMI signal

Choose the signal for the HDMI connector (PC or STB/DVD) and set the black level.

Example: Setting the “PLUG/PLAY” mode to “STB/DVD”

Press MENU/ENTER buttons to access the MAIN MENU. Use the ◀ ▶ ▲ ▼ buttons to select the SET UP menu and then press the MENU/ENTER button.

Use the ▲ ▼ buttons to select the HDMI SET UP setting.

Use the ◀ ▶ buttons to change the HDMI SET UP setting.

HDMI SET UP	
▶ PLUG/PLAY	: ◀ STB/DVD ▶
BLACK LEVEL	: HIGH

◀ SEL. ▶ ADJ. EXIT/RETURN

Information

■ PLUG/PLAY settings

PC: When connected to the PC signal.

BLACK LEVEL is set to “LOW” automatically.

STB/DVD: When connected to the SET TOP BOX, DVD etc.

BLACK LEVEL is set to “HIGH” automatically.

■ BLACK LEVEL settings

LOW: When connected to the PC signal.

HIGH: When connected to the SET TOP BOX, DVD etc. Change “HIGH” into “LOW” if the black level appears gray.

Setting the video signal format

Use these operations to set the color systems of composite video signals or Y/C input signals.

Example: Setting the color system to “3.58 NTSC”

SET UP	
LANGUAGE	: ENGLISH
BNC INPUT	: COMPONENT
HD SELECT	: 1080I
RGB SELECT	: AUTO
HDMI SET UP	
▶ COLOR SYSTEM	: ◀ 3.58NTSC ▶
BACK GROUND	: GRAY
GRAY LEVEL	: 3
S1/S2	: OFF
DISPLAY MENU	: ON
MENU ADJUST	: TOP LEFT
ALL RESET	: OFF

◀ SEL. ▶ ADJ. EXIT/RETURN

Information

■ Video signal formats

Different countries use different formats for video signals. Set to the color system used in your current country.

AUTO: The color systems are automatically identified and the format is set accordingly.

PAL: This is the standard format used mainly in the United Kingdom and Germany.

SECAM: This is the standard format used mainly in France and Russia.

4.43 NTSC, PAL60: This format is used for videos in countries using PAL and SECAM video signals.

3.58 NTSC: This is the standard format used mainly in the United States and Japan.

PAL-M: This is the standard format used mainly in Brazil.

PAL-N: This is the standard format used mainly in Argentina.

Setting the background color when no signal is being input

Set the background color to black.

Example: Setting “BACK GROUND” to “BLACK”

Press MENU/ENTER button to access the MAIN MENU.

Use the ◀ ▶ ▲ ▼ buttons to select the SET UP menu and then press the MENU/ENTER button.

Use the ▲ ▼ buttons to select the BACKGROUND setting.

Use the ◀ ▶ buttons to change the BACKGROUND color.

SET UP	
LANGUAGE	: ENGLISH
BNC INPUT	: COMPONENT
HD SELECT	: 1080I
RGB SELECT	: AUTO
HDMI SET UP	
COLOR SYSTEM	: AUTO
▶ BACK GROUND	: ◀ BLACK ▶
GRAY LEVEL	: 3
S1/S2	: OFF
DISPLAY MENU	: ON
MENU ADJUST	: TOP LEFT
ALL RESET	: OFF

◀ SEL. ▶ ADJ. EXIT/RETURN

Information

■ BACK GROUND Settings

BLACK: Sets the background color to black.

GRAY: Sets the background color to gray.

Setting this makes it easier to see that there is no signal.

Setting the gray level for the sides of the screen

Use this procedure to set the gray level for the parts on the screen on which nothing is displayed when the screen is set to the 4:3 size.

Example: Setting "GRAY LEVEL" to "5"

Press MENU/ENTER button to access the MAIN MENU.

Use the ◀ ▶ ▲ ▼ buttons to select the SET UP menu and then press the MENU/ENTER button.

Use the ▲ ▼ buttons to select the GRAY LEVEL setting.

Use the ◀ ▶ buttons to change the GRAY LEVEL settings.

SET UP	
LANGUAGE	: ENGLISH
BNC INPUT	: COMPONENT
HD SELECT	: 1080I
RGB SELECT	: AUTO
HDMI SET UP	
COLOR SYSTEM	: AUTO
BACK GROUND	: GRAY
▶GRAY LEVEL	: ◀5▶
S1/S2	: OFF
DISPLAY MENU	: ON
MENU ADJUST	: TOP LEFT
ALL RESET	: OFF
◀SEL	▶ADJ. [EXIT]RETURN

Information

■ GRAY LEVEL settings

This adjusts the brightness of the black (the gray level) for the sides of the screen.

The standard is 0 (black). The level can be adjusted from 0 to 15. The factory setting is 2 (dark gray).

Setting the screen size for S1/S2 video input

If the S-video signal contains screen size information, the image will be automatically adjusted to fit the screen when this S1/S2 is set to AUTO.

This feature is available only when an S-video signal is input via the INPUT3 terminal.

Example: Setting "S1/S2" to "AUTO"

Press MENU/ENTER button to access the MAIN MENU.

Use the ◀ ▶ ▲ ▼ buttons to select the SET UP menu and then press the MENU/ENTER button.

Use the ▲ ▼ buttons to select the S1/S2 setting.

Use the ◀ ▶ buttons to change the S1/S2 setting.

SET UP	
LANGUAGE	: ENGLISH
BNC INPUT	: COMPONENT
HD SELECT	: 1080I
RGB SELECT	: AUTO
HDMI SET UP	
COLOR SYSTEM	: AUTO
BACK GROUND	: GRAY
GRAY LEVEL	: 3
▶S1/S2	: ◀AUTO▶
DISPLAY MENU	: ON
MENU ADJUST	: TOP LEFT
ALL RESET	: OFF
◀SEL	▶ADJ. [EXIT]RETURN

Information

■ S1/S2 settings

AUTO: Adjusts the screen size automatically according to the S1/S2 video signal.

OFF: Turns the S1/S2 function off.

Turning the display menu on/off

When this is set to OFF, the menu will not be displayed even if you press the MENU/ENTER button.

Example: Turning the MENU off

Press MENU/ENTER button to access the MAIN MENU.

Use the ◀ ▶ ▲ ▼ buttons to select the SET UP menu and then press the MENU/ENTER button.

Use the ▲ ▼ buttons to select the DISPLAY MENU setting.

Use the ◀ ▶ buttons to turn the DISPLAY MENU on or off.

SET UP	
LANGUAGE	: ENGLISH
BNC INPUT	: COMPONENT
HD SELECT	: 1080I
RGB SELECT	: AUTO
HDMI SET UP	
COLOR SYSTEM	: AUTO
BACK GROUND	: GRAY
GRAY LEVEL	: 3
S1/S2	: OFF
▶DISPLAY MENU	: ◀OFF▶
MENU ADJUST	: TOP LEFT
ALL RESET	: OFF
◀SEL	▶ADJ. [EXIT]RETURN

Information

■ DISPLAY MENU settings

ON: The on-screen menu appears.

OFF: The on-screen menu does not appear.

If you press the MENU/ENTER button on the remote control for more than 3 seconds the main menu will appear and can be set (although it is not ON).

Setting the position of the menu

Adjusts the position of the menu when it appears on the screen.

Example: Set the position to "TOP CENTER"

Press MENU/ENTER button to access the MAIN MENU.

Use the ◀ ▶ ▲ ▼ buttons to select the SET UP menu and then press the MENU/ENTER button.

Use the ▲ ▼ buttons to select the MENU ADJUST setting.

Use the ◀ ▶ buttons to change the MENU ADJUST setting.

SET UP	
LANGUAGE	: ENGLISH
BNC INPUT	: COMPONENT
HD SELECT	: 1080I
RGB SELECT	: AUTO
HDMI SET UP	
COLOR SYSTEM	: AUTO
BACK GROUND	: GRAY
GRAY LEVEL	: 3
S1/S2	: OFF
DISPLAY MENU	: ON
▶MENU ADJUST	: ◀TOP CENTER▶
ALL RESET	: OFF
◀SEL	▶ADJ. [EXIT]RETURN

Information

■ MENU ADJUST settings

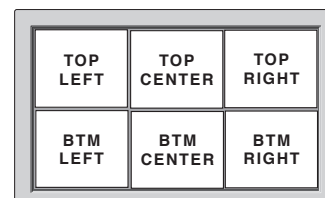

Resetting to the default values

Use these operations to restore all the settings (PICTURE, AUDIO, IMAGE ADJUST, SET UP, etc) to the factory default values.

Refer to pages 15 & 16 for items to be reset.

Press MENU/ENTER button to access the MAIN MENU.

Use the ◀ ▶ ▲ ▼ buttons to select the SET UP menu and then press the MENU/ENTER button.

Use the ▲ ▼ buttons to select the ALL RESET setting.

Use the ◀ ▶ buttons to turn on or off the ALL RESET button.

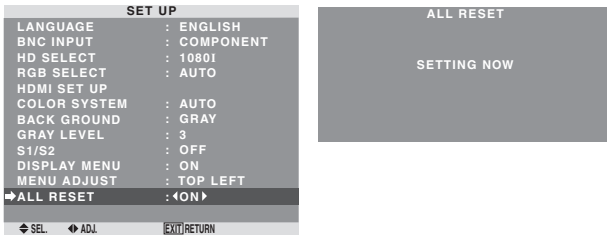

When the “SETTING NOW” screen disappears, then all the settings are restored to the default values.

Function Settings Menu

Setting the power management for computer images

This energy-saving (power management) function automatically reduces the displays power consumption if no operation is performed for a certain amount of time.

Example: Turning the power management function on

Press MENU/ENTER button to access the MAIN MENU.

Use the ◀ ▶ ▲ ▼ buttons to select the FUNCTION menu and then press the MENU/ENTER button.

Use the ▲ ▼ buttons to select the POWER MGT. setting.

Use the ◀ ▶ buttons to turn the POWER MGT. feature on or off.

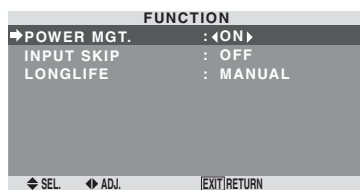

Information

■ Power management function

* The power management function automatically reduces the displays power consumption if the computer's keyboard or mouse is not operated for a certain amount of time. This function can be used when using the display with a computer.

* If the computer's power is not turned on or if the computer and selector tuner are not properly connected, the system is set to the off state.

* For instructions on using the computer's power management function, refer to the computer's operating instructions.

■ Power management settings

ON: In this mode the power management function is turned on.

OFF: In this mode the power management function is turned off.

■ Power management function and POWER/STANDBY indicator

The POWER/STANDBY indicator indicates the status of the power management function. See below for indicator status and description.

POWER/STANDBY indicator

Power management mode	POWER/STANDBY indicator	Power management operating status	Description	Turning the picture back on
On	Green	Not activated.	Horizontal and vertical synchronizing signals are present from the computer.	Picture already on.
Off	Red	Activated.	Horizontal and/or vertical synchronizing signals are not sent from the computer.	Operate the keyboard or mouse. The picture reappears.

Setting the Input Skip

When this is ON, signals which are not present will be skipped over and only pictures whose signals are being transmitted will be displayed.

Example: Set to "ON"

Press MENU/ENTER button to access the MAIN MENU.

Use the ◀ ▶ ▲ ▼ buttons to select the FUNCTION menu and then press the MENU/ENTER button.

Use the ▲ ▼ buttons to select the INPUT SKIP setting.

Use the ◀ ▶ buttons to turn the INPUT SKIP feature on or off.

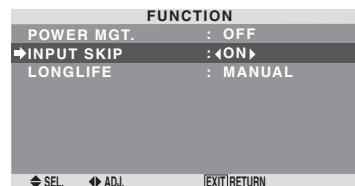

Information

■ INPUT SKIP settings

OFF: Regardless of the presence of the signal, scan and display all signals.

ON: If no input signal is present, skip that signal.

* "SETTING NOW" will appear during the input search.

Reducing burn-in of the screen

The brightness of the screen, the position of the picture, positive/negative mode are adjusted to reduce burn-in of the screen.

Press MENU/ENTER button to access the MAIN MENU.

Use the ◀ ▶ ▲ ▼ buttons to select the FUNCTION menu and then press the MENU/ENTER button.

Use the ▲ ▼ buttons to select the LONGLIFE setting.

Use the ◀ ▶ buttons to change the LONGLIFE setting from AUTO to MANUAL and then press the MENU/ENTER button. The "LONGLIFE" screen will appear.

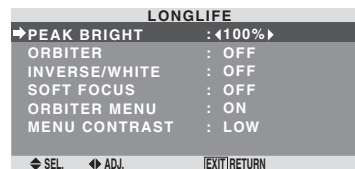

Information

■ When set to AUTO

Set automatically, as described below.

PEAK BRIGHT: 100%

ORBITER: ON

INVERSE/WHITE: OFF

SOFT FOCUS: OFF

ORBITER MENU: ON

MENU CONTRAST: LOW

PEAK BRIGHT

Use this to activate the brightness limiter.

Example: Setting "PEAK BRIGHT" to "75%"

Follow the instructions given in the "**Reducing burn-in of the screen**" section.

Bring up the LONGLIFE menu.

Use the ▲ ▼ buttons to select PEAK BRIGHT setting.

Use the ◀ ▶ buttons to change PEAK BRIGHT setting.

LONGLIFE	
▶ PEAK BRIGHT	: ◀75%▶
ORBITER	: OFF
INVERSE/WHITE	: OFF
SOFT FOCUS	: OFF
ORBITER MENU	: ON
MENU CONTRAST	: LOW
◀ SEL	▶ ADJ. [EXIT] RETURN

Information

■ PEAK BRIGHT settings

100%: The brightness of the screen is adjusted automatically to suit the picture quality.

75%, 50%, 25%: Sets maximum brightness.

The brightness level decreases in the order of 75%, 50%, 25%. 25% provides minimum brightness.

* These values are approximate.

ORBITER

Use this to set the picture shift.

Example: Setting "ORBITER" to "AUTO1"

Follow the instructions given in the "**Reducing burn-in of the screen**" section.

Bring up the LONGLIFE menu.

Use the ▲ ▼ buttons to select ORBITER setting.

Use the ◀ ▶ buttons to turn the ORBITER on or off.

LONGLIFE	
PEAK BRIGHT	: 100%
▶ ORBITER	: ◀AUTO1▶
INVERSE/WHITE	: OFF
SOFT FOCUS	: OFF
ORBITER MENU	: ON
MENU CONTRAST	: LOW
◀ SEL	▶ ADJ. [EXIT] RETURN

Information

■ ORBITER settings

OFF: Orbiter mode is turned off.

This is the default setting when RGB is input.

AUTO1: The picture moves around the screen intermittently, making the picture smaller. This is the default setting when a Video or a DVD/HD/DTV signal is input. Set to "OFF" when these signals are not used.

AUTO2: The picture moves around the screen intermittently, making the picture bigger.

* When a Video or a DVD/HD/DTV signal is input, the AUTO1 and 2 functions will affect only the moving picture and will not make the screen smaller or bigger.

INVERSE/WHITE

Use this to set the inverse mode or to display a white screen.

Example: Setting "INVERSE/WHITE" to "WHITE"

Follow the instructions given in the "**Reducing burn-in of the screen**" section.

Bring up the LONGLIFE menu.

Use the ▲ ▼ buttons to select INVERSE/WHITE setting.

Use the ◀ ▶ buttons to change the INVERSE/WHITE setting.

LONGLIFE	
PEAK BRIGHT	: 100%
ORBITER	: OFF
▶ INVERSE/WHITE	: ◀WHITE▶
SOFT FOCUS	: OFF
ORBITER MENU	: ON
MENU CONTRAST	: LOW
◀ SEL	▶ ADJ. [EXIT] RETURN

Information

■ INVERSE/WHITE Settings

OFF: INVERSE/WHITE mode is turned off.

INVERSE: The picture is displayed alternately between positive image and negative image.

WHITE: The entire screen turns white.

SOFT FOCUS

Reduces edges and softens the image.

Example: Setting "SOFT FOCUS" to "LEVEL2"

Follow the instructions given in the "**Reducing burn-in of the screen**" section.

Bring up the LONGLIFE menu.

Use the ▲ ▼ buttons to select SOFT FOCUS setting.

Use the ◀ ▶ buttons to change the SOFT FOCUS setting.

LONGLIFE	
PEAK BRIGHT	: 100%
ORBITER	: OFF
INVERSE/WHITE	: OFF
▶ SOFT FOCUS	: ◀LEVEL2▶
ORBITER MENU	: ON
MENU CONTRAST	: LOW
◀ SEL	▶ ADJ. [EXIT] RETURN

Information

■ SOFT FOCUS settings

OFF: Turns the SOFT FOCUS function off.

LEVEL1, 2, 3, 4: Activates the SOFT FOCUS setting. The higher numbers create a softer image.

"SHARPNESS" can not be adjusted on the "PICTURE" menu.

ORBITER MENU

Use this to set menu shift.

Example: Setting "ORBITER MENU" to "OFF"

Follow the instructions given in the "Reducing Burn-in of the screen" section.

Bring up the LONGLIFE menu.

Use the ▲ ▼ buttons to select ORBITER MENU setting.

Use the ◀ ▶ buttons to turn the ORBITER MENU on or off.

LONGLIFE	
PEAK BRIGHT	: 100%
ORBITER	: OFF
INVERSE/WHITE	: OFF
SOFT FOCUS	: OFF
▶ ORBITER MENU	: ◀OFF▶
MENU CONTRAST	: LOW
◀ SEL.	▶ ADJ. [EXIT] RETURN

Information

■ ORBITER MENU settings

ON: The position of the menu will be shifted by eight dots each time the menu is displayed.

OFF: The menu will be displayed at the same position.

MENU CONTRAST

Use this to reduce the brightness of the menu.

Example: Setting "MENU CONTRAST" to "NORMAL"

Follow the instructions given in the "Reducing Burn-in of the screen" section.

Bring up the LONGLIFE menu.

Use the ▲ ▼ buttons to select MENU CONTRAST setting.

Use the ◀ ▶ buttons to change the MENU CONTRAST setting.

LONGLIFE	
PEAK BRIGHT	: 100%
ORBITER	: OFF
INVERSE/WHITE	: OFF
SOFT FOCUS	: OFF
ORBITER MENU	: ON
▶ MENU CONTRAST	: ◀NORMAL▶
◀ SEL.	▶ ADJ. [EXIT] RETURN

Information

■ MENU CONTRAST settings

NORMAL: Menu brightness is set to normal.

LOW: Menu brightness is set to lower.

Signal Information Menu

Checking the frequencies, polarities of input signals, and resolution

Use this function to check the frequencies and polarities of the signals currently being input from a computer, etc.

On "MAIN MENU", select "SIGNAL INFO.", then press the MENU/ENTER button.

The "SIGNAL INFORMATION" is displayed.

SIGNAL INFORMATION	
H. FREQUENCY	: 48.4KHz
V. FREQUENCY	: 60.0Hz
H. POLARITY	: NEGATIVE
V. POLARITY	: NEGATIVE
MEMORY	: 24
RESOLUTION	: 1024 × 768
◀ SEL.	▶ ADJ. [EXIT] RETURN

PC: MEMORY will be displayed.

Others: MODE will be displayed.

MonitorLink Control

Application

These specifications cover the communications control of the plasma monitor by external equipment.

Use a crossed (reverse) cable.

Type of connector: D-Sub 9-pin male

Pin No.	Pin Name	Pin No.	Pin Name
1	No Connection	6	DSR (DCE side ready)
2	RXD (Receive data)	7	RTS (Ready to send)
3	TXD (Transmit data)	8	CTS (Clear to send)
4	DTR (DTE side ready)	9	No connection
5	GND		

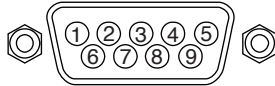

Communication Parameters

- | | |
|--------------------------|--------------|
| (1) Communication system | Asynchronous |
| (2) Interface | RS-232C |
| (3) Baud rate | 9600 bps |
| (4) Data length | 8 bits |
| (5) Parity | Odd |
| (6) Stop bit | 1 bit |
| (7) Communication code | Hex |
| (8) Flow control | None |

MonitorLink Control Codes (Reference)

FUNCTION	CODE DATA							
	9FH	80H	60H	4EH	00H	CDH		
Power ON	9FH	80H	60H	4EH	00H	CDH		
Power OFF	9FH	80H	60H	4FH	00H	CEH		
Input Switch	INPUT1 (BNC)	DFH	80H	60H	47H	01H	01H	08H
	INPUT2 (RCA)	DFH	80H	60H	47H	01H	02H	09H
	INPUT3 (S-Video)	DFH	80H	60H	47H	01H	03H	0AH
	COMP1 (RCA)	DFH	80H	60H	47H	01H	05H	0CH
	COMP2 (BNC)	DFH	80H	60H	47H	01H	06H	0DH
	MONLINK (HDMI)	DFH	80H	60H	47H	01H	0EH	15H
	RGB1 (mini D-sub 15-pin)	DFH	80H	60H	47H	01H	07H	0EH
	RGB2 (5BNC)	DFH	80H	60H	47H	01H	08H	0FH
	MONLINK (DVI)	DFH	80H	60H	47H	01H	0CH	13H
	MONLINK (HDMI)	DFH	80H	60H	47H	01H	0EH	15H
Audio Mute	ON	9FH	80H	60H	3EH	00H	BDH	
	OFF	9FH	80H	60H	3FH	00H	BEH	
Picture Mode	NORMAL	DFH	80H	60H	0AH	01H	01H	CBH
	THEATER 1	DFH	80H	60H	0AH	01H	02H	CCH
	THEATER 2	DFH	80H	60H	0AH	01H	03H	CDH
	DEFAULT	DFH	80H	60H	0AH	01H	04H	CEH
	BRIGHT	DFH	80H	60H	0AH	01H	05H	CFH
Screen Mode	STRETCH	DFH	80H	60H	51H	01H	02H	13H
	EXPAND	DFH	80H	60H	51H	01H	03H	14H
	NARROW	DFH	80H	60H	51H	01H	04H	15H
	STANDARD	DFH	80H	60H	51H	01H	05H	16H
	14 : 9	DFH	80H	60H	51H	01H	09H	1AH
	ZOOM	DFH	80H	60H	51H	01H	0AH	1BH
Auto Picture	ON	DFH	80H	60H	7FH	03H	03H	09H 00H 4DH
	OFF	DFH	80H	60H	7FH	03H	03H	09H 01H 4EH
FILM Mode	ON	DFH	80H	60H	C1H	01H	01H	82H
	OFF	DFH	80H	60H	C1H	01H	02H	83H

Note: Contact Mitsubishi for a full list of the External Control Codes if needed.

Troubleshooting

If the picture quality is poor or there is some other problem, check the adjustments, operations, etc., before requesting service.

Symptom	Checks	Remedy
Picture moves intermittently around the screen.	Is ORBITER ON (AUTO1)?	• Default setting for ORBITER is ON (AUTO1). In this mode, picture moves intermittently around the screen. See page 27 to turn off ORBITER.
Mechanical sound is heard.	• Maybe the sound from the cooling fans used to prevent over heating.	
The unit emits a crackling sound.	• Are the image and sound normal?	• If there are no abnormalities in the image and sound, the noise is caused by the cabinet reacting to changes in humidity. This will not affect performance.
Picture is disturbed. Sound is noisy. Remote control operates erroneously.	• Is a connected component set directly in front or at the side of the display?	• Leave some space between the display and the connected components.
The remote control does not work.	• Are the remote control's batteries worn out?	• Replace both batteries with new ones.
Display's power does not turn on when the remote control's power button is pressed.	• Is the display's power cord plugged into a power outlet?	• Plug the display's power cord into a power outlet.
	• Are all the display's indicators off?	• Press the power button on the display's to turn on the power.
	• Are the remote control's batteries worn out?	• Replace both batteries with new ones.
Display does not operate when the remote control's buttons are pressed.	• Is the remote control pointed at the display, or is there an obstacle between the remote control and the display?	• Point the remote control at the display's remote control sensor when pressing buttons, or remove the obstacle.
	• Is direct sunlight or strong artificial light shining on the display's remote control sensor?	• Eliminate the light by closing curtains, pointing the light in a different direction, etc.
	• Are the remote control's batteries worn out?	• Replace both batteries with new ones.
	• The remote cable is plugged into the REMOTE IN terminal (Wired).	• Unplug the remote cable from the display.
No sound or picture is produced.	• Is the display's power cord plugged into a power outlet?	• Plug the display's power cord into a power outlet.
Picture appears but no sound is produced.	• Is the volume set at the minimum?	• Increase the volume.
	• Is the mute mode set?	• Press the remote control's MUTE button.
	• Are the speakers properly connected?	• Connect the speakers properly.
	• Is AUDIO INPUT set correctly?	• Set AUDIO INPUT on the AUDIO menu correctly.
Poor picture with VIDEO signal input.	• Improper control setting. Local interference. Cable interconnections. Input impedance is not correct level.	• Adjust picture control as needed. Try another location for the display. Be sure all connections are secure.
Poor picture with RGB signal input.	• Improper control setting. Incorrect 15 PIN connector pin connections.	• Adjust picture controls as needed. Check pin assignments and connections.
Tint is poor or colors are weak.	• Are the tint and colors properly adjusted?	• Adjust the tint and color (under PICTURE).
Nothing appears on screen.	• Is the computer's power turned on?	• Turn on the computer's power.
	• Is a source connected?	• Connect source to the display.
	• Is the power management function in the standby or off mode?	• Operate the computer (move the mouse, etc.).
Part of picture is cut off or picture is not centered.	• Is the position adjustment appropriate?	• Adjust the IMAGE ADJUST properly.
Image is too large or too small.	• Is the screen size adjustment appropriate?	• Press the FORMAT button on the remote control and adjust properly.
Picture is unstable.	• Is the computer's resolution setting appropriate?	• Set to the proper resolution.
POWER/STANDBY indicator is lighted in red.	• Horizontal and / or vertical sync signal is not present when the Intelligent Power Manager control is on.	• Check the input signal.
POWER/STANDBY indicator is blinking in red.	• The temperature inside the main unit has become too high and has activated the protector.	• Promptly switch off the power of the main unit and wait until the internal temperature drops. See*1. PAGE 31
POWER/STANDBY indicator is blinking in green and red, or green.	_____	• Promptly switch off the power of the main unit. See *2. PAGE 31

*1 Overheat protector

If the display becomes too hot, the overheat protector will be activated and the display will be turned off. If this happens, turn off the power to the display and unplug the power cord. If the room where the display is installed is particularly hot, move the display to a cooler location and wait for the display to cool for 60 minutes. If the problem persists, contact your dealer.

*2 In the following case, power off the display immediately and contact your dealer or authorized Service Center.

The display turns off 5 seconds after powering on and then the POWER/STANDBY indicator blinks. It indicates that the power supply circuit, plasma display panel, temperature sensor, or one or more fans have been damaged.

PD-5050 Specifications

Screen Size	43.5"(H) × 24.5"(V) inches 1106(H) × 622(V) mm diagonal 50"
Aspect Ratio	16 : 9
Resolution	1365(H) × 768(V) pixels
Pixel Pitch	0.032"(H) × 0.032"(V) inches 0.81(H) × 0.81(V) mm
Color Processing	4,096 steps, 68.7 billion colors
Signals	
Synchronization Range	Horizontal : 15.5 to 110 kHz (automatic : step scan) Vertical : 50.0 to 120 Hz (automatic : step scan)
Input Signals	RGB, NTSC (3.58/4.43), PAL (B,G,M,N), PAL60, SECAM, HD* ¹ , DVD* ¹ , DTV* ¹
Input Terminals	
RGB	
RGB 1 (Analog)	mini D-sub 15-pin × 1
RGB 2 (Analog)	BNC (R, G, B, H/CS, V) × 1* ²
MONLINK (Digital)	HDMI
Video	
INPUT 1	BNC × 1
INPUT 2	RCA-pin × 1
INPUT 3	S-Video; DIN 4-pin × 1
DVD/HD/DTV	
COMP 1	RCA-pin (Y, PB[CB], PR[CR]) × 1* ¹
COMP 2	BNC (Y, PB[CB], PR[CR]) × 1* ¹ . * ²
MONLINK	HDMI
Audio	Stereo RCA × 3 (Selectable)
External Control	D-sub 9-pin × 1 (RS-232C)
Sound output	9W+9W at 6 ohm
Power Supply	AC100-240V 50/60Hz
Current Rating	7.6A (maximum)
Power Consumption	435W (typical)
Dimensions	48.1 (W) × 30 (H) × 3.9 (D) inches 1222 (W) × 736 (H) × 99(D) mm
Weight	100 lbs / 45.4 kg (without stand)
Environmental Considerations	
Operating Temperature	0°C to 40°C / 32°F to 104°F
Humidity	20 to 80% (no condensation)
Altitude	0 to 9180 feet / 0 to 2800 m
Storage Temperature	-10°C to 50°C / 14°F to 122°F
Humidity	10 to 90% (no condensation)
Altitude	0 to 9840 feet / 0 to 3000 m
Front Panel User Controls	Power on/off, Input/Exit, Volume up/down/ Menu/Exit
Remote Control Functions	Power on/off, Menu/Exit, Volume up/ down, Adjust (UP, DOWN, LEFT, RIGHT), Zoom up/down
OSM Functions	PICTURE (PICTURE MEMORY/CONTRAST/ BRIGHTNESS/SHARPNESS/COLOR/TINT/NR/ COLOR TEMP/WHITE BALANCE/GAMMA/ LOW TONE/SET UP LEVEL/COLORVIEW/ FILM MODE/PICTURE MODE), AUDIO (BASS/ TREBLE/BALANCE/AUDIO INPUT1/AUDIO INPUT2/AUDIO INPUT3), IMAGE ADJUST (ASPECT MODE/V-POSITION/H-POSITION/V- HEIGHT/H-WIDTH/AUTO PICTURE/FINE PICTURE/PICTURE ADJ.), SET UP (LANGUAGE*/BNC INPUT/HD SELECT/RGB SELECT/HDMI SET UP/COLOR SYSTEM/BACK GROUND/GRAY LEVEL/S1/ S2/DISPLAY MENU/MENU ADJUST/ALL RESET), FUNCTION (POWER MGT./INPUT SKIP/LONG LIFE [PEAK BRIGHT / ORBITER / INVERSE/WHITE / SOFT FOCUS / ORBITER MENU / MENU CONTRAST]), SIGNAL INFO.

*English, German, French, Italian, Spanish, Swedish, Chinese, Russian

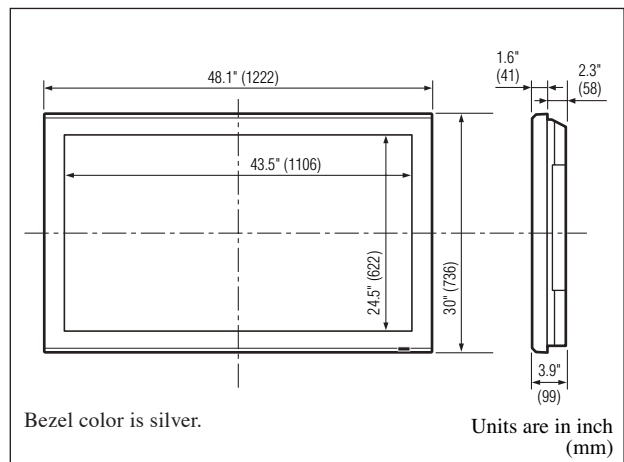

The features and specifications may be subject to change without notice.

*¹HD/DVD/DTV input signals supported on this system

480P (60 Hz)	480I (60 Hz)	525P (60 Hz)
525I (60 Hz)	576P (50 Hz)	576I (50 Hz)
625P (50 Hz)	625I (50 Hz)	720P (60 Hz)
1035I (60 Hz)	1080I (50 Hz)	1080I (60 Hz)

*²The 5-BNC connectors are used as RGB/PC2 and COMP2 input. Select one of them under "BNC INPUT".

Other Features Motion compensated 3D Scan Converter (NTSC, PAL, 480I, 576I, 525I, 625I, 1035I, 1080I), 2-3 pull down Converter (NTSC, 480I, 525I, 1035I, 1080I (60Hz)), 2-2 pull down Converter (PAL, 576I, 625I, NTSC, 480I, 525I), Digital Zoom Function (100-900% Selectable), Self Diagnosis, Image Burn reduction tools (PEAK BRIGHT, INVERSE/WHITE, ORBITER), Color Temperature select (high/medium/mid low/low, user has 4 memories), Auto Picture, Input Skip, ColorView, Low Tone (3 mode), Gamma Correction (4 mode), Plug and play (DDC1, DDC2b, RGB3: DDC2b only),

Accessories Remote control with two AAA batteries, Power cord, Owner's Guide, Safety metal fittings, Ferrite cores, Cable clamps, Registration Card, BNC-RCA Adapters

Regulations UL Approved (UL 60950-1 and UL65000, CAN/CSA C22.2 No.60950-1 and CAN/CSA-E60065-00)
DOC Canada requirements
Meets FCC Class B requirements

PD-6150 Specifications

Screen Size	53.2"(H)×29.9"(V) inches 1351(H)×760(V) mm diagonal 61"
Aspect Ratio	16 : 9
Resolution	1365(H)×768(V) pixels
Pixel Pitch	0.039"(H)×0.039"(V) inches 0.99(H)×0.99(V) mm
Color Processing	4,096 steps, 68.7 billion colors
Signals	
Synchronization Range	Horizontal : 15.5 to 110 kHz (automatic : step scan) Vertical : 50.0 to 120 Hz (automatic : step scan)
Input Signals	RGB, NTSC (3.58/4.43), PAL (B,G,M,N), PAL60, SECAM, HD*1, DVD*1, DTV*1
Input Terminals	
RGB	
RGB 1 (Analog)	mini D-sub 15-pin × 1
RGB 2 (Analog)	BNC (R, G, B, H/CS, V) × 1*2
MONLINK (Digital)	HDMI
Video	
INPUT 1	BNC × 1
INPUT 2	RCA-pin × 1
INPUT 3	S-Video: DIN 4-pin × 1
DVD/HD/DTV	
COMP 1	RCA-pin (Y, PB[CB], PR[CR]) × 1*1
COMP 2	BNC (Y, PB[CB], PR[CR]) × 1*1,*2
MONLINK	HDMI
Audio	Stereo RCA × 3 (Selectable)
External Control	D-sub 9-pin × 1 (RS-232C)
Sound output	9W+9W at 6 ohm
Power Supply	AC100-240V 50/60Hz
Current Rating	8.0A (maximum)
Power Consumption	540W (typical)
Dimensions	57.9 (W)×34.7 (H)×4.8 (D) inches 1470 (W)×880 (H)×122(D) mm
Weight	137 lbs / 62.2 kg (without stand)
Environmental Considerations	
Operating Temperature	0°C to 40°C / 32°F to 104°F
Humidity	20 to 80% (no condensation)
Altitude	0 to 9180 feet / 0 to 2800 m
Storage Temperature	-10°C to 50°C / 14°F to 122°F
Humidity	10 to 90% (no condensation)
Altitude	0 to 9840 feet / 0 to 3000 m
Front Panel User Controls	Power on/off, Input/Exit, Volume up/down/ Menu/Exit
Remote Control Functions	Power on/off, Menu/Exit, Volume up/down, Adjust (UP, DOWN, LEFT, RIGHT), Zoom up/down
OSM Functions	PICTURE (PICTURE MEMORY/CONTRAST/ BRIGHTNESS/SHARPNESS/COLOR/TINT/NR/ COLOR TEMP./WHITE BALANCE/GAMMA/ LOW TONE/SET UP LEVEL/COLORVIEW/ FILM MODE/PICTURE MODE), AUDIO (BASS/ TREBLE/BALANCE/AUDIO INPUT1/AUDIO INPUT2/AUDIO INPUT3), IMAGE ADJUST (ASPECT MODE/V-POSITION/H-POSITION/V- HEIGHT/H-WIDTH/AUTO PICTURE/FINE PICTURE/PICTURE ADJ.), SET UP (LANGUAGE*/BNC INPUT/HD SELECT/RGB SELECT/HDMI SET UP/COLOR SYSTEM/BACK GROUND/GRAY LEVEL/S1/ S2/DISPLAY MENU/MENU ADJUST/ALL RESET), FUNCTION (POWER MGT./INPUT SKIP/LONG LIFE [PEAK BRIGHT / ORBITER / INVERSE/WHITE / SOFT FOCUS / ORBITER MENU / MENU CONTRAST]), SIGNAL INFO. *English, German, French, Italian, Spanish, Swedish, Chinese, Russian

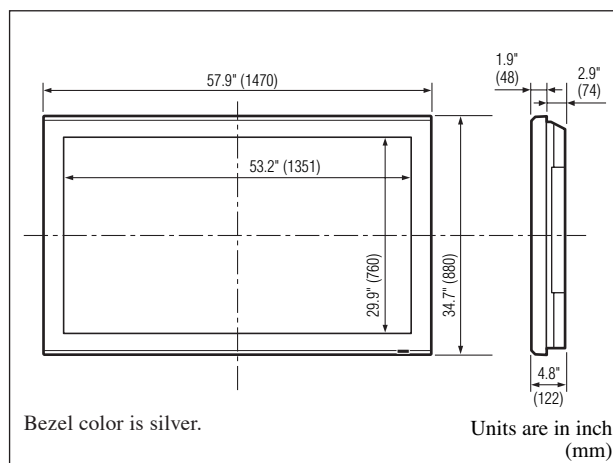

The features and specifications may be subject to change without notice.

*1 HD/DVD/DTV input signals supported on this system

480P (60 Hz)	480I (60 Hz)	525P (60 Hz)
525I (60 Hz)	576P (50 Hz)	576I (50 Hz)
625P (50 Hz)	625I (50 Hz)	720P (60 Hz)
1035I (60 Hz)	1080I (50 Hz)	1080I (60 Hz)

*2 The 5-BNC connectors are used as RGB/PC2 and COMP2 input. Select one of them under "BNC INPUT".

Other Features Motion compensated 3D Scan Converter (NTSC, PAL, 480I, 576I, 525I, 625I, 1035I, 1080I), 2-3 pull down Converter (NTSC, 480I, 525I, 1035I, 1080I (60Hz)), 2-2 pull down Converter (PAL, 576I, 625I, NTSC, 480I, 525I), Digital Zoom Function (100-900% Selectable), Self Diagnosis, Image Burn reduction tools (PEAK BRIGHT, INVERSE/WHITE, ORBITER), Color Temperature select (high/medium/mid low/low, user has 4 memories), Auto Picture, Input Skip, ColorView, Low Tone (3 mode), Gamma Correction (4 mode), Plug and play (DDC1, DDC2b, RGB3: DDC2b only)

Accessories Remote control with two AAA batteries, Power cord, Owner's Guide, Safety metal fittings, Ferrite cores, Cable clamps, Registration Card, BNC-RCA Adapters

Regulations UL Approved (UL 60950-1 and UL65000, CAN/CSA C22.2 No.60950-1 and CAN/CSA-E60065-00)
DOC Canada requirements
Meets FCC Class B requirements

Table of Signals Supported

Supported resolution

- When the screen mode is NARROW, each signal is converted to a 1024 dots×768 lines signal. (Except for *2,3,4)
- When the screen mode is TRUE, the picture is displayed in the original resolution.
- When the screen mode is STANDARD, each signal is converted to a 1365 dots×768 lines signal. (Except for *3)

Computer input signals supported by this system

Model	Dots × lines	Vertical frequency (Hz)	Horizontal frequency (kHz)	Sync Polarity		Presence		Screen mode			RGB select*5	HDMI	Memory
				Horizontal	Vertical	Horizontal	Vertical	NARROW (4:3)	TRUE	STANDARD (16:9)			
IBM PC/AT*8 compatible computers	640×400	70.1	31.5	NEG	NEG	YES	YES	YES*2	YES	YES	YES	NO	4
	640×480	59.9	31.5	NEG	NEG	YES	YES	YES	YES	YES	STILL	YES	5
		72.8	37.9	NEG	NEG	YES	YES	YES	YES	YES	--	YES	7
		75.0	37.5	NEG	NEG	YES	YES	YES	YES	YES	STILL	YES	8
		85.0	43.3	NEG	NEG	YES	YES	YES	YES	YES	--	YES	9
		100.4	51.1	NEG	NEG	YES	YES	YES	YES	YES	--	YES	41
		120.4	61.3	NEG	NEG	YES	YES	YES	YES	YES	--	YES	42
	848×480	60.0	31.0	POS	POS	YES	YES	--	YES	YES	WIDE2	YES	19
	852×480*1	60.0	31.7	NEG	NEG	YES	YES	--	YES	YES	WIDE1	YES	17
	800×600	56.3	35.2	POS	POS	YES	YES	YES	YES	YES	STILL	YES	11
		60.3	37.9	POS	POS	YES	YES	YES	YES	YES	STILL	YES	12
		72.2	48.1	POS	POS	YES	YES	YES	YES	YES	--	YES	13
		75.0	46.9	POS	POS	YES	YES	YES	YES	YES	--	YES	14
		85.1	53.7	POS	POS	YES	YES	YES	YES	YES	--	YES	15
		99.8	63.0	POS	POS	YES	YES	YES	YES	YES	--	YES	43
		120.0	75.7	POS	POS	YES	YES	YES	YES	YES	NO	YES	44
		1024×768	60.0	48.4	NEG	NEG	YES	YES	YES*3	--	YES	STILL	YES
	70.1		56.5	NEG	NEG	YES	YES	YES*3	--	YES	--	NO	25
	75.0		60.0	POS	POS	YES	YES	YES*3	--	YES	STILL	NO	26
	85.0		68.7	POS	POS	YES	YES	YES*3	--	YES	--	NO	27
	100.6		80.5	NEG	NEG	YES	YES	YES*3	--	YES	--	NO	45
	1152×864	75.0	67.5	POS	POS	YES	YES	YES	--	YES	STILL	NO	51
	1280×768	56.2	45.1	POS	POS	YES	YES	--	--	YES	WIDE1	NO	52
		59.8	48.0	POS	NEG	YES	YES	--	--	YES	WIDE3	NO	80
	1280×768*9	69.8	56.0	NEG	POS	YES	YES	--	--	YES	WIDE1	NO	66
	1280×800*9	60.0	49.7	NEG	NEG	YES	YES	--	--	YES	WIDE1	NO	21
	1280×854*9	60.0	53.1	NEG	NEG	YES	YES	--	--	YES	WIDE2	NO	37
	1360×765	60.0	47.7	POS	POS	YES	YES	--	--	YES*3	WIDE1	NO	22
	1360×768	60.0	47.7	POS	POS	YES	YES	--	--	YES*3	WIDE1	NO	22
	1376×768	59.9	48.3	NEG	POS	YES	YES	--	--	YES	WIDE2	NO	53
	1280×1024	60.0	64.0	POS	POS	YES	YES	YES*4	--	YES	STILL	NO	29
		75.0	80.0	POS	POS	YES	YES	YES*4	--	YES	--	NO	30
		85.0	91.1	POS	POS	YES	YES	YES*4	--	YES	--	NO	40
		100.1	108.5	POS	POS	YES	YES	YES*4	--	YES	--	NO	47
	1680×1050*9	60.0	65.3	NEG	NEG	YES	YES	--	--	YES	WIDE4	NO	38
	1600×1200	60.0	75.0	POS	POS	YES	YES	YES	--	YES	--	NO	54
		65.0	81.3	POS	POS	YES	YES	YES	--	YES	--	NO	55
		70.0	87.5	POS	POS	YES	YES	YES	--	YES	--	NO	56
		75.0	93.8	POS	POS	YES	YES	YES	--	YES	--	NO	57
		85.0	106.3	POS	POS	YES	YES	YES	--	YES	--	NO	58
	1920×1200*9	60.0	74.6	NEG	NEG	YES	YES	--	--	YES	WIDE2	NO	81
	1920×1200RB*9	60.0	74.0	NEG	NEG	YES	YES	--	--	YES	WIDE3	NO	88
Apple Macintosh*6 *8	640×480	66.7	35.0	Sync on G	Sync on G	--	--	YES	YES	YES	--	NO	6
	832×624	74.6	49.7	Sync on G	Sync on G	--	--	YES	YES	YES	--	NO	16
	1024×768	74.9	60.2	Sync on G	Sync on G	--	--	YES*3	--	YES	WIDE1	NO	28
	1152×870	75.1	68.7	Sync on G	Sync on G	--	--	YES	--	YES	WIDE1	NO	39
	1440×900*9	60.0	56.0	NEG	NEG	YES	YES	--	--	YES	--	NO	89
Work Station (EWS4800)*8	1280×1024	60.0	64.6	NEG	NEG	YES	YES	YES*4	--	YES	--	NO	29
		71.2	75.1	NEG	NEG	YES	YES	YES*4	--	YES	--	NO	48
Work Station (HP)*8	1280×1024	72.0	78.1	--	--	--	--	YES*4	--	YES	--	NO	59
Work Station (SUN)*8	1152×900	66.0	61.8	C Sync	C Sync	--	--	YES	--	YES	--	NO	60
		76.0	71.7	C Sync	C Sync	--	--	YES	--	YES	--	NO	61
	1280×1024	76.1	81.1	C Sync	C Sync	--	--	YES*4	--	YES	--	NO	30
Work Station (SGI)	1024×768	60.0	49.7	--	--	--	--	YES*3	--	YES	--	YES	62
	1280×1024	60.0	63.9	--	--	--	--	YES*4	--	YES	--	NO	29
IDC-3000G													
PAL625P	768×576	50.0	31.4	NEG	NEG	YES	YES	YES*7	--	YES*7	--	NO	31
	NTSC525P	640×480	59.9	31.5	NEG	NEG	YES	YES	YES*7	--	YES*7	MOTION	NO

-
- *1 Only when using a graphic accelerator board that is capable of displaying 852×480 .
 - *2 This signal is converted to a $1024 \text{ dots} \times 640 \text{ lines}$ signal.
 - *3 The picture is displayed in the original resolution.
 - *4 The aspect ratio is 5:4. This signal is converted to a $960 \text{ dots} \times 768 \text{ lines}$ signal.
 - *5 Normally the RGB select mode suite for the input signals is set automatically. If the picture is not displayed properly, set the RGB mode prepared for the input signals listed in the table above.
 - *6 To connect the display to Macintosh computer, use a monitor adapter (NOT INCLUDED).
 - *7 Other screen modes (EXPAND and STRETCH) are available as well.
 - *8 When viewing a moving picture at a vertical frequency greater than 65Hz, the picture may sometimes be unstable (jumpy). If this occurs, please set the refresh rate of the external equipment to 60Hz.
To view 480I@60Hz (480 interlaced lines, 60Hz refresh rate) or 576I@50Hz (567 interlaced lines, 50Hz refresh rate) when sync polarity is "Sync on Green", set "RGB SELECT" to "MOTION".
 - *9 CVT standard compliant.

NOTE:

- *While the input signals comply with the resolution listed in the table above, you may have to adjust the position and size of the picture or the fine picture because of errors in synchronization of your computer.*
 - *When a $1280 \text{ dots} \times 1024 \text{ lines}$ signal or $1600 \text{ dots} \times 1200 \text{ lines}$ signal is input to the monitor, the picture will be compressed.*
 - *This display has a resolution of $1365 \text{ dots} \times 768 \text{ lines}$. It is recommended that the input signal should be XGA, wide XGA, or equivalent.*
 - *With digital input some signals are not accepted.*
 - *The sync may be disturbed when a nonstandard signal other than the aforementioned is input.*
 - *If you are connecting a composite sync signal, use the HD terminal.*
-
- "IBM PC/AT" and "XGA" are registered trademarks of International Business Machines, Inc. of the United States.
 - "Apple Macintosh" is a registered trademark of Apple Computer, Inc. of the United States.

Mitsubishi Plasma Display Panel Limited Warranty

mitsubishi Digital Electronics America, Inc. ("MDEA") warrants to the original purchaser of this Plasma Display Panel that if purchased from an authorized MITSUBISHI Audio/Video Dealer, should it prove defective by reason of improper workmanship and/or material:

a. Parts. All parts are warranted for a period of one year from the date of the original purchase at retail. We will repair or replace, at our option, any defective part without charge for the part. Parts used for replacement may be replaced with those of like kind and quality and may be new or remanufactured. Parts used for replacement are warranted for the remainder of the original warranty period.

b. Labor. We will provide the labor for a warranty repair by an authorized MITSUBISHI service center without charge for one year from the original date of purchase at retail.

c. Notice. To obtain warranty service, you must notify an authorized MITSUBISHI service center of any defect within the applicable warranty time period.

1. TO OBTAIN WARRANTY SERVICE:

a. Contact your nearest authorized MITSUBISHI service center, whose name and address can be obtained from your MITSUBISHI dealer or by writing or calling MDEA at the address and telephone number provided below.

b. Warranty service will be provided in your home or, if required, at an authorized MITSUBISHI service center, provided that your television is located within the geographic territory customarily covered by an authorized MITSUBISHI service center. If not, you must either deliver your television to an authorized service location at your own expense, or pay for any travel and/or transportation costs the service center may charge to and from your home. Actual service labor will be provided without charge.

c. Proof of purchase date from an authorized MITSUBISHI dealer is required when requesting warranty service. Present your sales receipt or other document which establishes proof and date of purchase. **THE RETURN OF THE OWNER REGISTRATION CARD IS NOT A CONDITION OF WARRANTY COVERAGE.** However, please return the Owner Registration Card so that we can contact you should a question of safety arise which could affect you.

3. This Plasma Display Panel uses a revolutionary technology, gas plasma, to create the screen image. This technology creates the image using small dots, or picture elements (pixels). Your Plasma Display Panel is manufactured to a high level of perfection, in fact, 99.99% perfect in the number of properly functioning. As in tube television, sometimes a pixel is continuously active or inactive. Our standard is clear, your pixels must be 99.99% perfect in the number of properly functioning pixels.

4. THIS WARRANTY DOES NOT COVER:

a. Up to .01% pixel outages (small dot picture elements that are dark or incorrectly illuminated).

b. Cosmetic damage or damage to this Plasma Display Panel or to any other products where such damage is caused by unauthorized modification, alteration, repairs to or service of the product by anyone other than an authorized MITSUBISHI service center; physical abuse to or misuse of the product (including any failure to carry out any maintenance as described in the Owner's Guide or any product damaged by excessive physical or electrical stress); any products that have had a serial number or any part thereof altered, defaced or removed; product use in any manner contrary to the Owner's Guide (including, but not limited to, uneven phosphor aging and imprinted images on the viewing screen); freight damage or damage due to improper shipping methods; damage caused by use of third party mounting brackets or stands or any damage caused by acts of God or other factors beyond the reasonable control of MDEA, such as power surge damage caused by electrical system or lightning. This warranty also excludes service calls where no defect in the product covered under this warranty is found, service calls related to unsatisfactory audio or visual reception or signal unless caused by a defect in the product that is covered under this warranty, all costs, expenses or any other damages arising from product installation, or set-ups, any adjustments of user controls (including, contrast, brightness, color, tint, fine tuning, sharpness), other adjustment necessary to prepare the unit for display or use, connection with any external TV tuner, audio receiver, antenna, cable or satellite systems, or service of products purchased or serviced outside the U.S.A. Please consult the operating instructions contained in the Owner's Guide furnished with the product for information regarding user controls.

5. ANY EXPRESS WARRANTY NOT PROVIDED HEREIN, AND ANY REMEDY WHICH, BUT FOR THIS PROVISION, MIGHT ARISE BY IMPLICATION OR OPERATION OF LAW, IS HEREBY EXCLUDED AND DISCLAIMED. THE IMPLIED WARRANTIES OF MERCHANTABILITY AND FITNESS FOR ANY PARTICULAR PURPOSE ARE EXPRESSLY LIMITED TO A TERM OF ONE YEAR.

6. UNDER NO CIRCUMSTANCES SHALL MDEA BE LIABLE TO PURCHASER OR ANY OTHER PERSON FOR ANY INCIDENTAL, SPECIAL OR CONSEQUENTIAL DAMAGES, WHETHER ARISING OUT OF BREACH OF WARRANTY, BREACH OF CONTRACT, OR OTHERWISE.

7. Some states do not allow limitations on how long an implied warranty lasts, or the exclusion or limitation of incidental, special or consequential damages, so the above limitations or exclusions may not apply to you.

8. This warranty gives you specific legal rights, and you may also have other rights which vary from state to state.

9. BEFORE REQUESTING SERVICE, please review the instruction booklet to insure proper installation and correct customer control adjustment. If the problem persists, contact your nearest MITSUBISHI Dealer for the name(s) of authorized MITSUBISHI Service Center(s). If you are unable to obtain this information, please call 800-332-2119, or write us at the address below.

MITSUBISHI DIGITAL ELECTRONICS AMERICA, INC.

9351 Jeronimo Road
Irvine, CA 92618-1904

DECLARATION OF CONFORMITY

This device complies with Part 15 of FCC Rules. Operation is subject to the following two conditions. (1) This device may not cause harmful interference, and (2) this device must accept any interference received, including interference that may cause undesired operation.

U.S. Responsible Party:	Mitsubishi Digital Electronics America
Address:	9351 Jeronimo Road
	Irvine, CA 92618
Tel. No.:	(949) 465-6000

Type of Product: Plasma Display
Equipment Classification: Class B Peripheral
Models: PD-5050/PD-6150



*We hereby declare that the equipment specified above
conforms to the technical standards as specified in the FCC Rules.*

Mitsubishi Digital Electronics America
9351 Jeronimo Road
Irvine, CA 92618

Printed in Japan
7S801691