



TOSHIBA



Introduction

Connecting your TV

Setting up your TV

Using the TV's Features

Appendix

OWNER'S MANUAL

Integrated High Definition Plasma Television

COLORSTREAM[®] HD

SRS WOW

DOLBY DIGITAL

HDMI

THEATERWIDE HD

HDTV
HIGH DEFINITION TELEVISION

Owner's Record

The model number and serial number are on the back of your TV. Record these numbers in the spaces below. Refer to these numbers whenever you communicate with your Toshiba dealer about this TV.

Model number:

Serial number:

50HP16

© 2006 TOSHIBA CORPORATION
All Rights Reserved

Always read and understand the **PRODUCT WARNINGS** and **USER DIRECTIONS** that are contained in this manual before attempting to use your television, to help ensure its safe use. Always store this manual near your television for convenient future reference.

Dear Customer,

Thank you for purchasing this Toshiba Plasma television.

You must carefully read and understand all of the safety instructions contained in this manual before you attempt to use this product in order to avoid potential hazards that could cause bodily injury or property damage or could damage your Plasma Television.

We hope that you are completely satisfied with your Toshiba Plasma television and that it will give you long and enjoyable service. We look forward to providing you with additional Toshiba products to serve all of your entertainment needs in the future.

Safety Precautions

WARNING: TO REDUCE THE RISK OF FIRE OR ELECTRIC SHOCK, DO NOT EXPOSE THIS APPLIANCE TO RAIN OR MOISTURE.

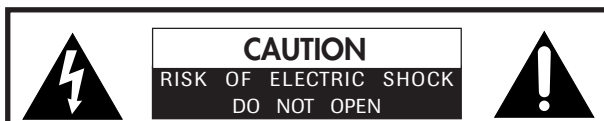

CAUTION: TO REDUCE THE RISK OF ELECTRIC SHOCK, DO NOT REMOVE COVER (OR BACK.) NO USER-SERVICEABLE PARTS INSIDE. REFER SERVICING TO QUALIFIED SERVICE PERSONNEL.

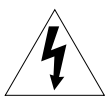

The lightning flash with arrowhead symbol, within an equilateral triangle, is intended to alert the user to the presence of uninsulated "dangerous voltage" within the product's enclosure that may be of sufficient magnitude to constitute a risk of electric shock to persons.



The exclamation point within an equilateral triangle, is intended to alert the user to the presence of important operating and maintenance (servicing) instructions in the literature accompanying the appliance.

CAUTION: To reduce the risk of electric shock, do not use the polarized plug with an extension cord, receptacle, or other outlet unless the blades can be inserted completely to prevent blade exposure.



ENERGY STAR® qualified TV. Products that earn the ENERGY STAR prevent green house gas emissions by meeting strict energy efficiency guidelines set by the U.S. Environmental Protection Agency and the U.S. Department of Energy. ENERGY STAR and the ENERGY STAR mark are registered U.S. marks.

WARNING: If you decide to wall mount this television, always use a UL-approved wall bracket appropriate for the size and weight of this television. The use of any wall bracket other than a UL-approved wall bracket appropriate for the size and weight of this television for wall mounting this television could result in serious bodily injury and/or property damage.

NOTICE OF POSSIBLE ADVERSE EFFECTS ON PLASMA DISPLAY

If a fixed (non-moving) pattern or image remains on the Plasma display for extended periods of time, the image can become permanently ingrained in the Plasma display and cause subtle but permanent ghost images. This type of damage is **NOT COVERED BY YOUR WARRANTY.** (See item 34 on page 4 for details.)

NOTE TO CATV INSTALLERS

This is a reminder to call the CATV system installer's attention to Article 820-40 of the U.S. NEC, which provides guidelines for proper grounding and, in particular, specifies that the cable ground shall be connected to grounding system of the building, as close to the point of cable entry as practical. For additional antenna grounding information, see item 25 and 26 on page 4.

Child Safety

It Makes A Difference Where Your TV Stands

Congratulations on your purchase!

As you enjoy your new TV, keep these safety tips in mind:



The Issue

- If you are like most consumers, you have a TV in your home. Many homes, in fact, have more than one TV.
- The home theater entertainment experience is a growing trend, and larger TVs are popular purchases; however, they are not always supported on the proper TV stands.
- Sometimes TVs are improperly secured or inappropriately situated on dressers, bookcases, shelves, desks, audio speakers, chests, or carts. As a result, TVs may fall over, causing unnecessary injury.



Toshiba Cares!

- The consumer electronics industry is committed to making home entertainment enjoyable and safe.
- The Consumer Electronics Association formed the Home Entertainment Support Safety Committee, comprised of TV and consumer electronics furniture manufacturers, to advocate children's safety and educate consumers and their families about television safety.

Tune Into Safety

- One size does NOT fit all! Use appropriate furniture large enough to support the weight of your TV (and other electronic components.)
- Use appropriate angle braces, straps, and anchors to secure your furniture to the wall (but never screw anything directly into the TV.)
- Carefully read and understand the other enclosed instructions for proper use of this product.
- Do not allow children to climb on or play with furniture and TVs.
- Avoid placing any item on top of your TV (such as a VCR, remote control, or toy) that a curious child may reach for.
- Remember that children can become excited while watching a program and can potentially push or pull a TV over.
- Share our safety message about this hidden hazard of the home with your family and friends. Thank you!



2500 Wilson Blvd.
Arlington, VA 22201 U.S.A.
Tel. 703-907-7600 Fax 703-907-7690
www.CE.org

CEA is the Sponsor, Producer and Manager of the International CES®



Important Safety Instructions

- 1) **Read these instructions.**
- 2) **Keep these instructions.**
- 3) **Heed all warnings.**
- 4) **Follow all instructions.**



- 5) **Do not use this apparatus near water.**
- 6) **Clean only with dry cloth.**
- 7) **Do not block any ventilation openings.** Install in accordance with the manufacturer's instructions.
- 8) **Do not install near any heat sources** such as radiators, heat registers, stoves, or other apparatus (including amplifiers) that produce heat.

- 9) **Do not defeat the safety purpose of the polarized or grounding type plug.** A polarized plug has two blades with one wider than the other. A grounding type plug has two blades and a third grounding prong. The wide blade or the third prong are provided for your safety. If the provided plug does not fit into your outlet, consult an electrician for replacement of the obsolete outlet.

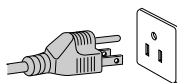

- 10) **Protect the power cord** from being walked on or pinched, particularly at plugs, convenience receptacles, and the point where they exit from the apparatus.

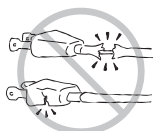

- 11) **Only use attachments/accessories specified by the manufacturer.**

- 12) **Use only with the cart, stand, tripod, bracket, or table specified by the manufacturer, or sold with the apparatus.** When a cart is used, use caution when moving the cart/apparatus combination to avoid injury from tip-over.



- 13) **Unplug this apparatus during lightning storms or when unused for long periods of time.**



- 14) **Refer all servicing to qualified service personnel.** Servicing is required when the apparatus has been damaged in any way, such as power-supply cord or plug is damaged, liquid has been spilled or objects have fallen into the apparatus, the apparatus has been exposed to rain or moisture, does not operate normally, or has been dropped.

- 14a) **CAUTION:** If the TV is dropped and the cabinet or enclosure surface has been damaged or the TV does not operate normally, take the following precautions:
 - ALWAYS turn off the TV and unplug the power cord to avoid possible electric shock or fire.
 - To prevent personal injury, never handle the damaged television.
 - ALWAYS contact a service technician to inspect the TV any time it has been damaged or dropped.



- 15) The apparatus shall not be exposed to dripping or splashing and that no objects filled with liquids, such as vases, shall be placed on the apparatus.

Installation, Care, and Service

Installation

Follow these recommendations and precautions and heed all warnings when installing your TV:

- 16) Never modify this equipment. Changes or modifications may void: a) the warranty, and b) the user's authority to operate this equipment under the rules of the Federal Communications Commission.

- 17) **DANGER: RISK OF SERIOUS PERSONAL INJURY, DEATH, OR EQUIPMENT DAMAGE!** Never place the TV on an unstable cart, stand, or table. The TV may fall, causing serious personal injury, death, or serious damage to the TV.  

- 18) Never place items such as vases, aquariums, or candles on top of the TV.

- 19) Always place the TV on the floor or a sturdy, level, stable surface that can support the weight of the unit. Use a sturdy tie between the TV's rear hook

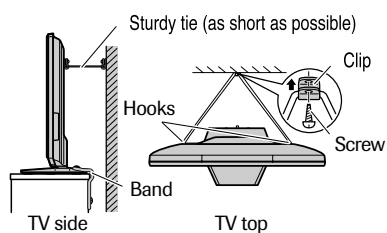

- and the rear wall, pillar, etc., to secure the TV. If you use a TV stand, fix the TV by using the attached band.

- 20) Never expose the apparatus to dripping or splashing liquid or place items such as vases, aquariums, any other item filled with liquid, or candles on top of the TV.

- 21) Never block or cover the slots or openings in the TV cabinet back, bottom, and sides.

Never place the TV:

- on a bed, sofa, rug, or similar surface;
- too close to drapes, curtains, or walls; or
- in a confined space such as a bookcase, built-in cabinet, or any other place with poor ventilation.



The slots and openings are provided to protect the TV from overheating and to help maintain reliable operation of the TV. Leave a space of at least 4 inches around the TV.

- 22) Always place the back of the television at least one (1) inch away from any vertical surface (such as a wall) to allow proper ventilation.

- 23) Never allow anything to rest on or roll over the power cord, and never place the TV where the power cord is subject to wear or abuse.

- 24) Never overload wall outlets and extension cords.

- 25) Always operate the TV with a 120V AC, 60Hz power source only.



CAUTION: To reduce the risk of electric shock, do not use the polarized plug with an extension cord, receptacle, or other outlet unless the blades can be inserted completely with three-wire grounding type to prevent blade exposure.

Introduction

Connecting your TV

Setting up your TV

Using the TV's Features

Appendix

Installation (cont. from previous page)

- 26) Always make sure the antenna system is properly grounded to provide adequate protection against voltage surges and built-up static charges (see Section 810 of the National Electric Code.)

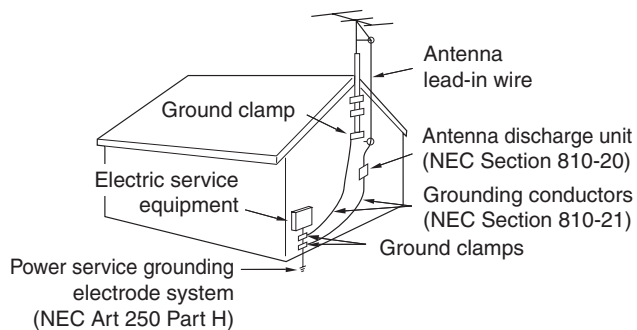

27)

**DANGER: RISK OF SERIOUS PERSONAL INJURY OR DEATH!**

- Use extreme care to make sure you are never in a position where your body (or any item you are in contact with, such as a ladder or screwdriver) can accidentally touch overhead power lines. Never locate the antenna near overhead power lines or other electrical circuits.
- Never attempt to install any of the following during lightning activity: a) an antenna system; or b) cables, wires, or any home theater component connected to an antenna or phone system.

**Care**

For better performance and safer operation of your TOSHIBA TV, follow these recommendations and precautions:

- 28) If you use the TV in the room of 0°C or less, the picture brightness may vary until the plasma monitor warms up. This is not a sign of a malfunction.
- 29) Always unplug the TV before cleaning. Wipe the display panel surface gently using only the supplied wiping cloth or a soft cloth (cotton, flannel, etc.) A hard cloth may damage the surface of the panel. Avoid contact with alcohol, thinner, benzene, acidic or and alkaline solvent cleaners, abrasive cleaners, or chemical cloths, as the surface may be impaired.

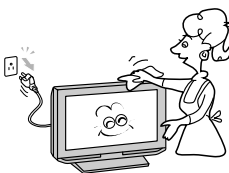

30)



- WARNING: RISK OF ELECTRIC SHOCK!** Never spill liquids or push objects of any kind into the TV cabinet slots.

Care (cont. from previous column)

- 31) While it is thundering, do not touch the connecting cables or apparatus.
- 32) For added protection of your TV from lightning and power surges, always unplug the power cord and disconnect the antenna from the TV if you leave the TV unattended or unused for long periods of time.
- 33) During normal use, the TV may make occasional snapping or popping sounds. This is normal, especially when the unit is being turned on or off. If these sounds become frequent or continuous, unplug the power cord and contact a Toshiba Authorized Service Center.
- 34) **Possible Adverse Effects on Plasma Display** If a fixed (non-moving) pattern or image remains on the Plasma display for extended periods of time, the image can become permanently ingrained in the plasma panel of the TV and cause subtle but permanent ghost images. **This type of damage is NOT COVERED BY YOUR WARRANTY.** Never leave the Plasma TV on for extended periods of time while it is displaying the following images or formats:
- **Fixed (non-moving) images**, including but not limited to PIP/POP windows, closed captions, video game patterns, TV station logos, stock tickers, and websites.
 - **Special formats** that do not use the entire screen, including but not limited to widescreen or letterbox format media viewed on a 4:3 aspect ratio display (with gray or black bars at the top and bottom of the screen) and 4:3 aspect ratio format media viewed on a widescreen/16:9 aspect ratio display (with gray or black bars on the left and right sides of the screen.)

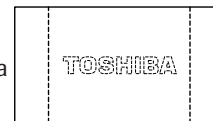
**Service**

35)

**WARNING: RISK OF ELECTRIC SHOCK!**

- Never attempt to service the TV yourself. Opening and removing the covers may expose you to dangerous voltage or other hazards. Refer all servicing to a Toshiba Authorized Service Center.

- 36) If you have the TV serviced:

- Ask the service technician to use only replacement parts specified by the manufacturer.
- Upon completion of service, ask the service technician to perform routine safety checks to determine that the TV is in safe operating condition.

- 37) When the TV reaches the end of its useful life, ask a qualified service technician to properly dispose of the TV.



FCC Declaration of Conformity Compliance Statement (Part 15):

The **Toshiba 50HP16 Plasma Color Television** comply with Part 15 of the FCC rules.

Operation is subject to the following two conditions: (1) this device may not cause harmful interference, and (2) this device must accept any interference that may cause undesired operation.

The party responsible for compliance to these rules is:
Toshiba America Consumer Products, L.L.C.
82 Totowa Rd. Wayne, NJ 07470.
Ph: 1-800-631-3811 or visit TACP's website at
www.tacp.Toshiba.com

Note: This equipment has been tested and found to comply with the limits for a Class B digital device, pursuant to Part 15 of the FCC rules. These limits are designed to provide reasonable protection against harmful interference in a residential installation. This equipment generates, uses, and can radiate radio frequency energy and, if not installed and

used in accordance with the instructions, may cause harmful interference to radio communications. However, there is no guarantee that interference will not occur in a particular installation. If this equipment does cause harmful interference to radio or television reception, which can be determined by removing and applying power to the equipment, the user is encouraged to try to correct the interference by one or more of the following measures:

- Reorient or relocate the receiving antenna.
- Increase the separation between the equipment and the receiver.
- Connect the equipment into an outlet on a circuit different from that to which the receiver is connected.
- Consult the dealer or an experienced radio/TV technician for help.

CAUTION: Changes or modifications to this equipment not expressly approved by Toshiba could void the user's authority to operate this equipment.

Important notes about your Plasma TV

The following symptoms are not signs of malfunction, but rather technical limitations of plasma TV technology.

- 1) The display of this Plasma TV radiates infrared rays. It may affect other infrared communication equipment under certain operating conditions.
- 2) Under certain conditions, the display of this Plasma TV may cause interference with the audio and/or video of certain types of electronic equipment that easily receive electromagnetic waves (e.g., AM radios and video equipment.) In particular, the display of this Plasma TV may affect certain types of electronic equipment that are located beyond the area where the Plasma TV is being used.
- 3) The display panel of this Plasma TV is manufactured using an extremely high level of precision technology; however, occasionally some parts of the screen may be missing picture elements and/or have luminous spots.
- 4) You can enjoy playing video games on this Plasma TV; however, certain video games that utilize so-called "light gun" joysticks for shooting at on-screen targets may not work with this Plasma TV.

- 5) **Possible Adverse Effects on Plasma Display:** Like all phosphor-based display devices and all gas-based plasma displays, the display of this Plasma TV may be susceptible to permanent ghost images (also known as phosphor burn-in) under certain circumstances. Certain operating conditions may accelerate the potential for phosphor burn-in, including but not limited to the following:
 - Displaying **fixed (non-moving) images**, including but not limited to PIP/POP windows, closed captions, video game patterns, TV station logos, stock tickers, and websites.
 - Displaying **special formats** that do not use the entire screen, including but not limited to widescreen or letterbox format media viewed on a 4:3 aspect ratio display (with gray or black bars at the top and bottom of the screen) and 4:3 aspect ratio format media viewed on a widescreen/16:9 aspect ratio display (with gray or black bars on the left and right sides of the screen.)

To minimize the potential for the occurrence of phosphor burn-in, Toshiba recommends the following:

- Display a moving image on the display of your Plasma TV whenever possible.
- Always turn off the power of your Plasma TV when you are finished using it.
- Reduce the Brightness and Contrast levels as much as possible without impairing image quality.
- Enable the Long Life settings (see page 38.)
- Try to display images that have many colors and color gradations (i.e., photographic or photo-realistic images.)
- Try to display images that have minimal contrast between light and dark areas (e.g., avoid white characters on black backgrounds.)
- Try to avoid displaying images that have few colors and/or that have distinct, sharply defined borders between colors.



Introduction	2	Setting the GameTimer™	29
Important Safety Instructions	3	Using the panel lock feature	29
FCC Declaration of Conformity Compliance Statement (Part 15):	5	Labeling channels	30
Important notes about your Plasma TV	5	Selecting the video input source	31
Features of your new TV	7	Labeling the video input sources	31
Exploring your new TV	7	Setting the clock	31
Selecting a location for the TV	8	Setting the ON timer	32
Connecting your TV	8	Setting the sleep timer	32
Connecting a VCR	9	Viewing the wide-screen picture formats (480i and 480p signals only)	33
Connecting a cable converter box or antenna ...	9	Scrolling the TheaterWide® picture (TheaterWide 2 and 3 only)	35
Connecting a DVD player/satellite receiver and a VCR	10	Selecting the cinema mode	36
Connecting a DVD player with ColorStream® (component video) and a VCR	11	Using the ASPECT feature	36
Connecting a DTV receiver/set-top box with ColorStream® (component video) and a VCR ...	12	Using the closed caption feature	37
Connecting a camcorder	13	Using the CC advanced feature	37
Connecting an HDMI™ or DVI device	14	Using the Long Life feature	38
Connecting an analog audio system	15	Reverse	38
Connecting a digital audio system with built-in digital surround	15	White	38
Connecting a device to the IR OUT terminal for IR pass-through device control	16	Picture shift	38
Connecting a PC (personal computer)	17	Side panel color	38
Power connection	17	Adjusting the picture	39
Setting up your TV	18	Selecting the picture mode	39
Using the remote control	18	Adjusting the picture quality	39
Preparing the remote control for use	18	Using the CableClear® feature	40
Installing the remote control batteries	18	Selecting the color temperature	40
Using the remote control to operate your other devices	18	Resetting your picture adjustments	40
Programming the remote control to operate your other devices	19	Adjusting the sound	41
Device code tables	20	Muting the sound	41
Learning about the remote control	22	Selecting stereo/SAP broadcasts	41
Starting setup	23	Adjusting the sound quality	41
Changing the on-screen display language ...	23	Resetting your audio adjustments	42
Adding channels to the TV's memory	24	Turning off the built-in speakers	42
Programming channels automatically	24	Using the StableSound® feature	42
Adding and erasing channels manually	24	Using the SRS WOW™ surround sound feature	43
Changing channels	24	Selecting the HDMI audio input source	43
Using the TV's features	25	Selecting the audio languages	44
Adjusting the channel settings	25	Selecting the digital output format	44
Switching between two channels	25	Checking the digital signal strength	44
Programming your favorite channels	25	Displaying TV status information on-screen	44
Using the LOCKS menu	26	Picture/Audio adjustments in PC mode	45
Selecting a password	26	Resetting your picture/audio adjustments in PC mode	45
Using the V-Chip (parental control) feature ..	27	Auto power off	46
Locking channels	28	Understanding the Power Return feature	46
Locking the video inputs	28	Appendix	46
		Troubleshooting	46
		Specifications	48
		Limited United States Warranty	49



Features of your new TV

The following are some of the exciting features of your new Toshiba widescreen, integrated High Definition, Plasma TV:

- Integrated digital tuning (8VSB ATSC and QAM) eliminates the need for a separate digital converter set-top box (in most cases).
- PC IN connection allows you to use the TV as a computer monitor.
- Two HDMI digital, High-Definition Multimedia Interface connections.
- Two sets of ColorStream® HD high-resolution component video inputs.
- Dolby* Digital and SRS WOW™ audio technologies.
- Digital Audio Out optical audio connection.
- CableClear® picture noise reduction.

* Manufactured under license from Dolby Laboratories. Dolby and the double-D symbol are trademarks of Dolby Laboratories.

Exploring your new TV

You can operate your TV by using the buttons on the right side panel or the remote control. The side and back panels provide the terminals to connect other equipment to your TV.

Front

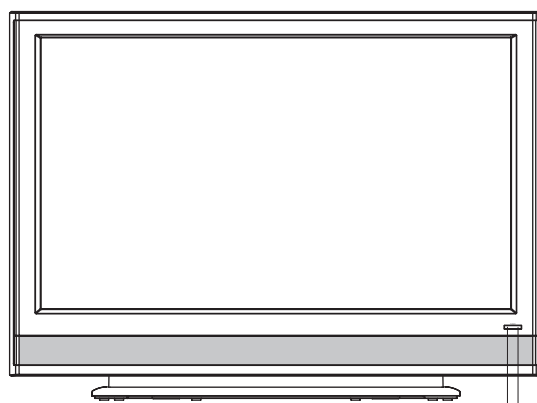

Power indicator
Remote sensor

The STARTING SETUP feature appears the first time you turn on the TV. See page 23 for details.

Note:

- To open the menu system, you can either press MENU on the remote control or simultaneously press both VOLUME buttons (◀ and ▶) on the right side panel.
- When a menu is open, to select the desired setting, you can use either the arrow buttons on the remote control or the CHANNEL ▲/▼ and VOLUME ◀▶ buttons on the right side panel.

Remote control

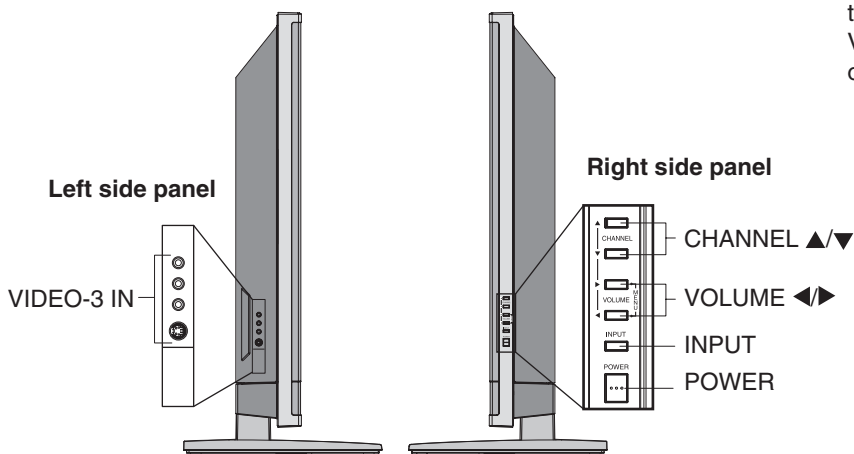
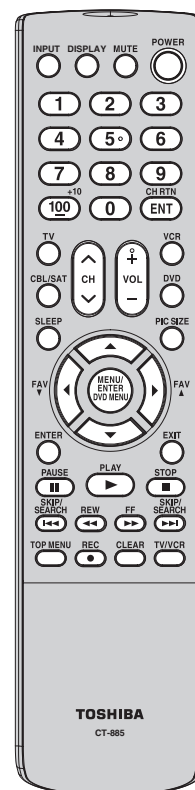



Exploring your new TV (continued)

Back of TV



Connecting your TV

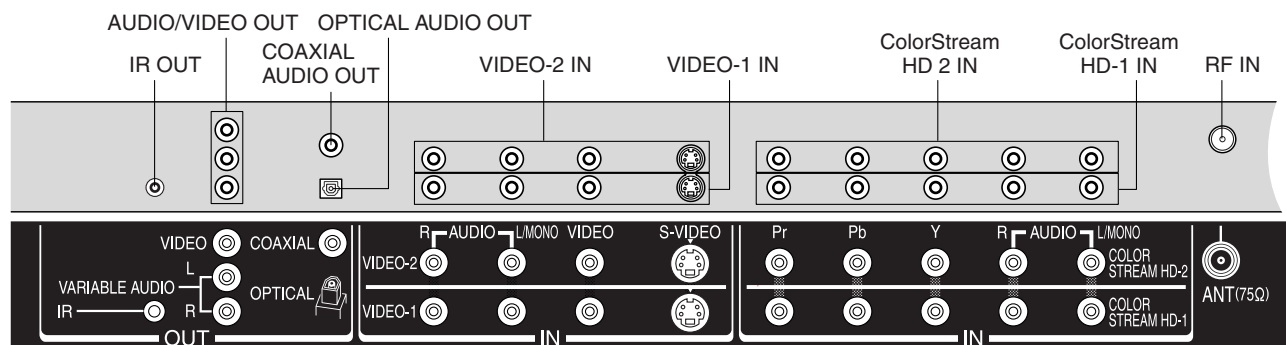

Left back panel

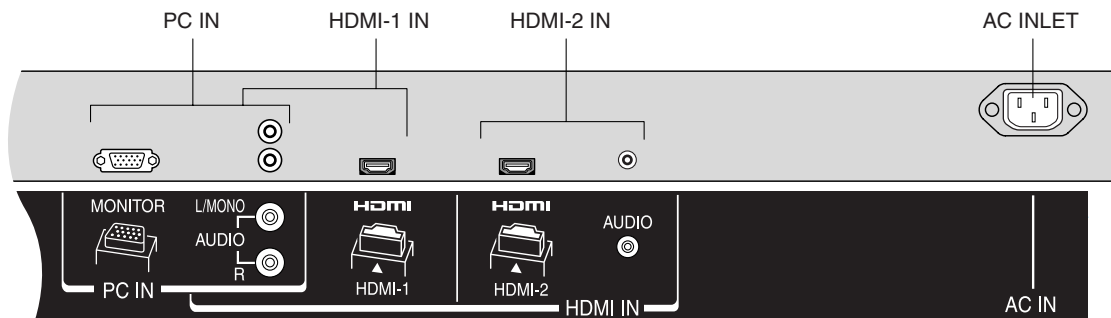

Right back panel

Selecting a location for the TV

- Place the TV on the floor or on a sturdy platform in a location where light does not directly hit the screen.
- Place the TV far enough from the walls to allow proper ventilation. Inadequate ventilation may cause overheating, which may damage the TV.

Connecting your TV

If you haven't connected electronic equipment before, or you have been frustrated in the past, you may wish to read this section. (Cables are not supplied.)

- A coaxial cable is the standard cable that comes in from your antenna or cable converter box. Coaxial cables use "F" connectors.
- Standard A/V (audio/video) cables are usually color coded according to use: yellow for video and red and white for audio. The red audio cable is for the stereo right channel, and the white audio cable is for the stereo left (or mono) channel. If you look at the rear panel of the TV, you will see that the terminals are color coded in the same manner as the cables.
- S-video cables provide better picture performance than standard video cables. S-video cables can only be used with S-video compatible components.
- Component video cables provide better picture performance than S-video cables. Component video cables can only be used with component video compatible components.
- HDMI (High Definition Multimedia Interface) cable is for use with video equipment that has HDMI output (see page 14.)

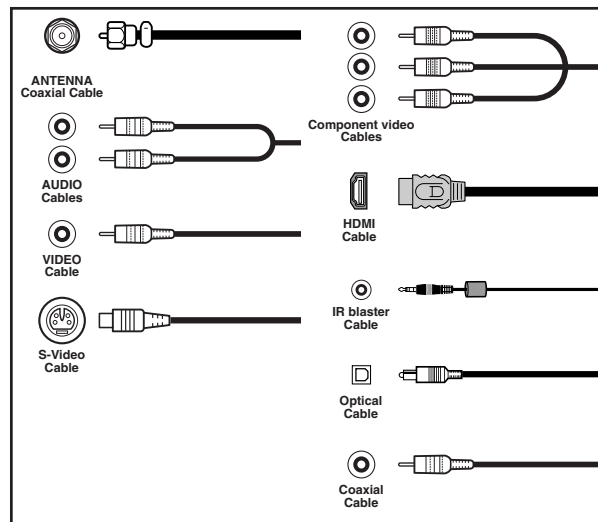

- IR blaster cable is for use with video device with IR (infrared) remote control.
- Optical/Coaxial cable is for use with AV amplifier with built-in digital surround (Dolby Digital or PCM.)



NOTE: DO NOT CONNECT A PC USING ONE OF THE HDMI INPUTS.

ALWAYS use the VGA port provided to connect a PC.





Connecting a VCR

This connection allows you to watch local channels and video programs, play or record on the VCR while watching TV, and record from one channel while watching another channel.

Cable Lead-in from cable box or antenna

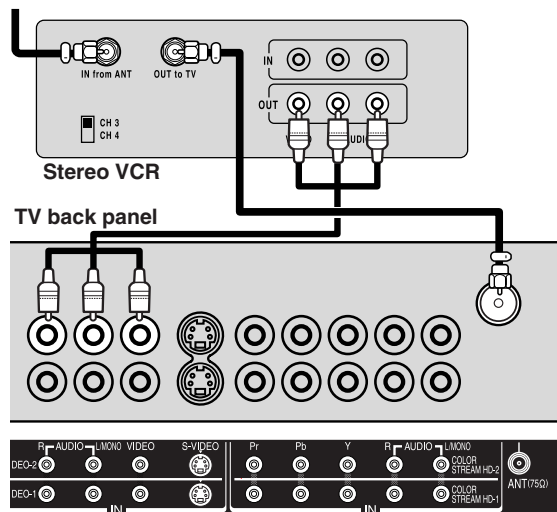

You will need:

- two coaxial cables
- one set of standard A/V cables

Note:

If using a mono VCR, connect L/Mono to VCR Audio OUT using only one audio cable. For better picture quality, if your VCR has S-video, you can use an S-video cable instead of the standard video cable. Do not connect a standard video cable and an S-video cable to VIDEO-1 (or VIDEO-2) simultaneously.

The unauthorized recording, use, distribution or revision of television programs, videotapes, DVDs, and other materials is prohibited under the Copyright Laws of the United States and other countries, and may subject you to civil and criminal liability.

Introduction

Connecting your TV

Connecting a cable converter box or antenna

This television has an extended tuning range and can tune most cable channels without using a cable company supplied converter box. Some cable companies offer "premium pay channels" in which the signal is scrambled. Descrambling these signals for normal viewing requires the use of a descrambler device, which is generally provided by the cable company.

Option 1: For Subscribers to Basic Cable TV Service

For basic cable service not requiring a Converter/Descrambler box, connect the incoming 75 ohm Coaxial Cable directly to the Antenna Jack on the back of the television.

Option 2: For Subscribers to Scrambled Cable TV Service

If you subscribe to a cable service that requires the use of a Converter/Descrambler box, connect the incoming cable to the Converter/Descrambler box and connect the output of the box to the Antenna Jack on the back of the television. Follow the connections shown below. Set the television to the output of the Converter/Descrambler box (usually channel 3 or 4) and use the Converter/Descrambler box to select channels.

Option 3: For Subscribers to Unscrambled Basic Cable with Scrambled Premium Channels

If you subscribe to a cable service in which basic cable channels are unscrambled and premium channels require the use of a Converter/Descrambler box, you may wish to use a two-set signal splitter (sometimes called a "two-set coupler") and an A/B Switch box from the cable installer or an electronics supply store. Follow the connections shown below. With the switch in the "B" position, you can directly tune any nonscrambled channels on your TV. With the switch in the "A" position, tune your TV to the output of the Converter/Descrambler box (usually channel 3 or 4) and use the box to tune scrambled channels.

Note:

When you use a converter box with your TV, there may be features that you cannot program using the remote control, such as labeling channels, blocking channels, and programming your favorite channels.

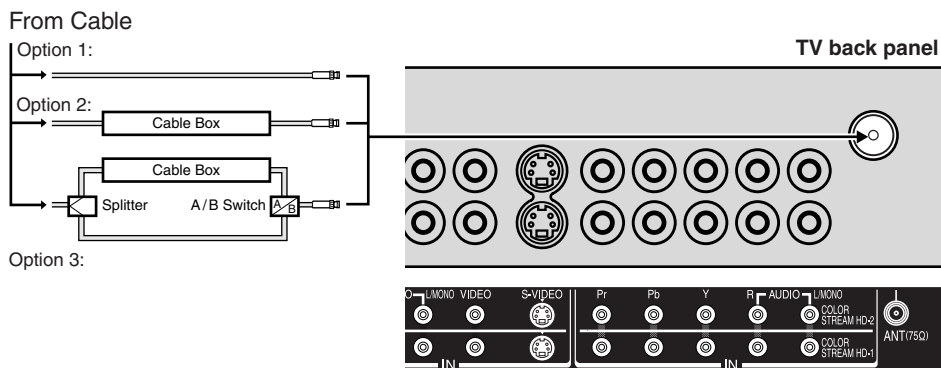

Setting up your TV

Using the TV's Features

Appendix



Connecting a DVD player/satellite receiver and a VCR

This connection allows you to watch DVD/satellite, VCR, or TV programs. You can record from the satellite receiver and TV, as well as record one TV channel while watching another channel.

From satellite

Connecting your TV

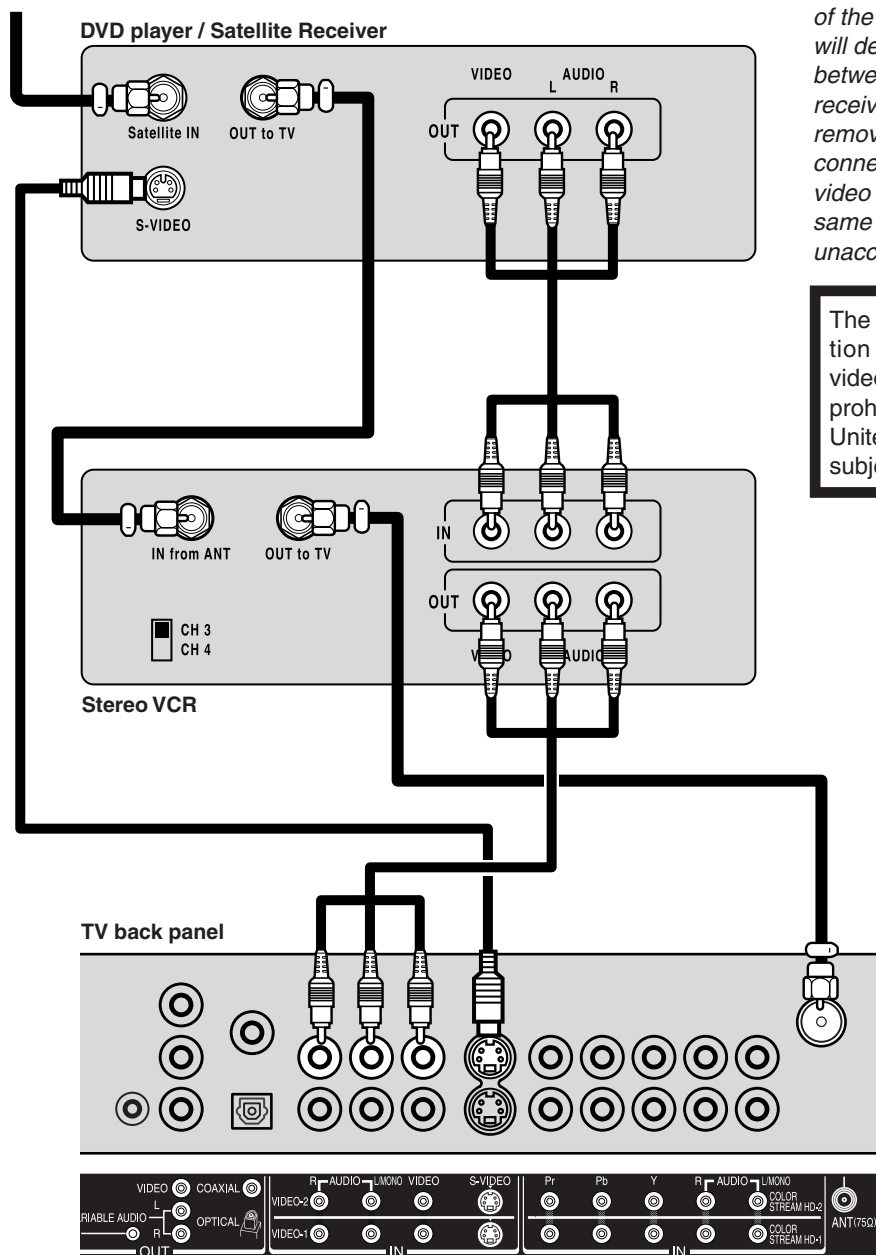

You will need:

- three coaxial cables
- two sets of standard A/V cables
- one S-video cable

Note:

You can use a standard video cable instead of the S-video cable, but the picture quality will decrease. If you use an S-video cable between the TV and DVD player/satellite receiver, make the audio connections but remove the standard video cable. Do not connect both an S-video and a standard video cable to VIDEO-1 (or VIDEO-2) at the same time or the picture performance will be unacceptable.

The unauthorized recording, use, distribution or revision of television programs, videotapes, DVDs, and other materials is prohibited under the Copyright Laws of the United States and other countries, and may subject you to civil and criminal liability.



Connecting a DVD player with ColorStream® (component video) and a VCR

This connection allows you to watch DVD, VCR, or TV programs and record TV programs. You can record from one source while watching a program from another source. Your TV is capable of using ColorStream (component video.) Connecting your TV to a component video compatible DVD player, such as a Toshiba DVD player with ColorStream®, can greatly enhance picture quality and performance.

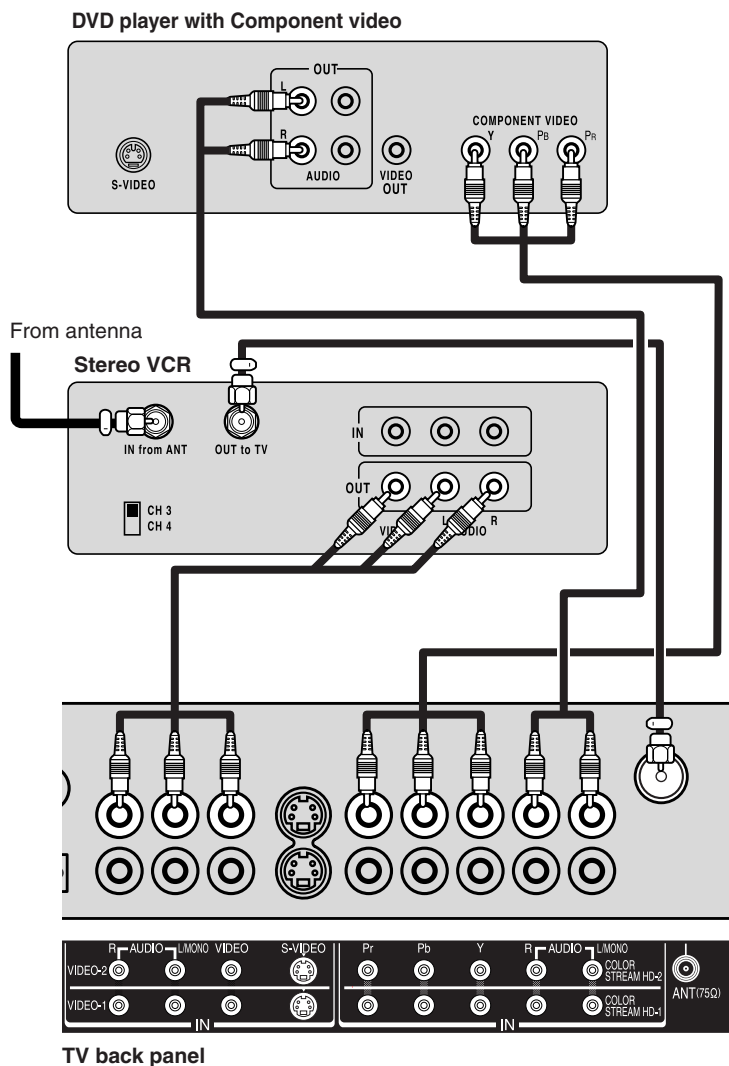

You will need:

- two coaxial cables
- one set of standard A/V cables
- one set of component video cables
- one pair of standard audio cables

Note:

You can connect the component video cables to either set of ColorStream jacks on the TV (HD-1 or HD-2).

The ColorStream HD-1 and HD-2 jacks can be used with Progressive (480p, 720p) and Interlaced (480i, 1080i) scan systems. A 1080i signal will provide the best picture performance.

The unauthorized recording, use, distribution or revision of television programs, videotapes, DVDs, and other materials is prohibited under the Copyright Laws of the United States and other countries, and may subject you to civil and criminal liability.

Introduction

Connecting your TV

Setting up your TV

Using the TV's Features

Appendix



Connecting a DTV receiver/set-top box with ColorStream® (component video) and a VCR

This connection allows you to watch DTV (digital TV), VCR, and TV programs, and record DTV and TV programs.

Your TV has ColorStream® (component video) inputs. Connecting your TV to a DTV receiver with component video can greatly enhance picture quality and realism.

Connecting your TV

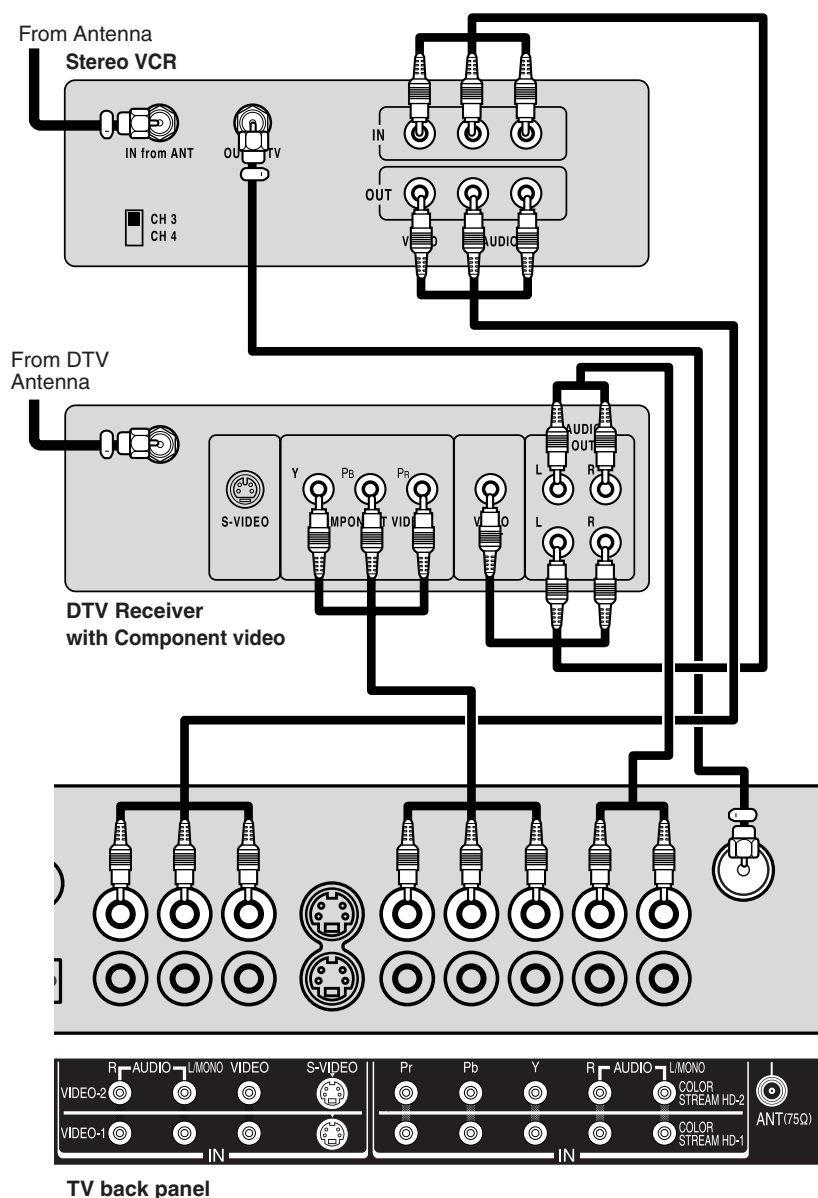

You will need:

- three coaxial cables
- two sets of standard A/V cables
- one set of standard audio cables
- one set of component video cables

Note:

You can connect the component video cables to either set of ColorStream jacks on the TV (HD-1 or HD-2.)

The ColorStream HD-1 and HD-2 jacks and HDMI-1 and HDMI-2 jacks can be used with Progressive (480p, 720p) and Interlaced (480i, 1080i) scan systems.

If your DTV receiver does not have component video, use the S-video and standard audio connections instead. Do not connect both an S-video and a standard video cable to VIDEO-1 (or VIDEO-2) at the same time or the picture performance will be unacceptable.

For an HDMI connection, see page 14.

The unauthorized recording, use, distribution, or revision of television programs, videotapes, DVDs, and other materials is prohibited under the Copyright Laws of the United States and other countries, and may subject you to civil and criminal liability.



Connecting a camcorder

This connection allows you to watch videos recorded on a camcorder.

You will need:

- one set of standard AV cables

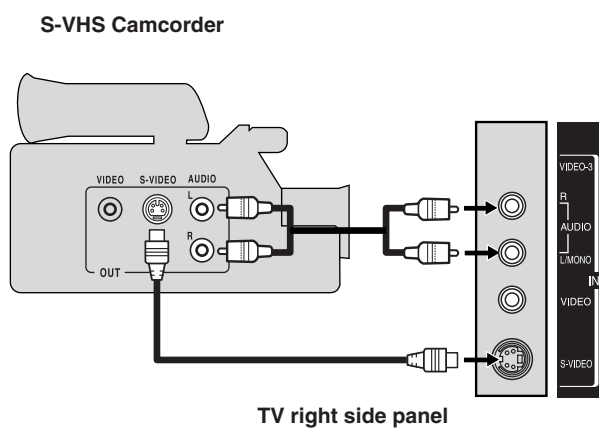
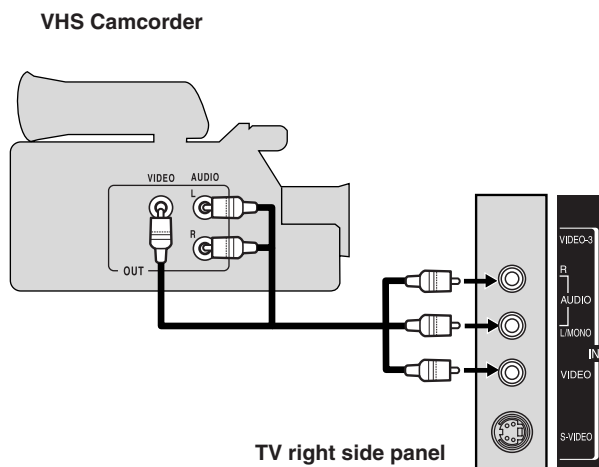

You will need:

- one S-video cable
- one pair of standard audio cables

Note:

For better picture quality, if your camcorder has S-video, you can use an S-video cable (plus the standard audio cables) instead of a standard video cable.

Do not connect both a standard video cable and an S-video cable at the same time or the picture performance will be unacceptable.

Introduction

Connecting your TV

Setting up your TV

Using the TV's Features

Appendix



Connecting an HDMI™ or DVI device

The HDMI inputs on your TV receive digital audio and uncompressed digital video from an HDMI source device, or uncompressed digital video from a DVI (Digital Video Interface) source device.

These inputs are designed to accept HDCP (High-Bandwidth Digital-Content Protection) program material in digital form from EIA/CEA-861/861B-compliant^[1] consumer electronic devices (such as a set-top box or DVD player with HDMI or DVI output).

The HDMI inputs are designed for best performance with high definition video signals. They will accept and display 480i, 480p, 720p and 1080i signals.



NOTE: DO NOT CONNECT A PC USING ONE OF THE HDMI INPUTS.
ALWAYS use the VGA port provided to connect a PC.

To connect an HDMI device, you will need:

- one HDMI cable (type A connector)

For proper operation, it is recommended that you use as short an HDMI cable as possible. You should not encounter difficulty if you use an HDMI cable that is shorter than 16.4 ft (5m.)

HDMI cable transfers both video and audio. Separate analog audio cables are not required (see illustration below.)

You must set the HDMI audio input setting to "HDMI" in the AUDIO menu (see page 43.)

Some CDVs (Video CDs) may not output digital audio signals. In that case, you may hear sound by connecting analog audio cables. If you do use analog audio cables for this reason, you will need to set the HDMI audio input setting to "DVI" to hear the analog audio (see page 43.)

Note: If you connect an HDMI device and analog audio cables and play media with digital audio output, to hear digital audio you must set the HDMI audio input setting to "HDMI" (page 43.)

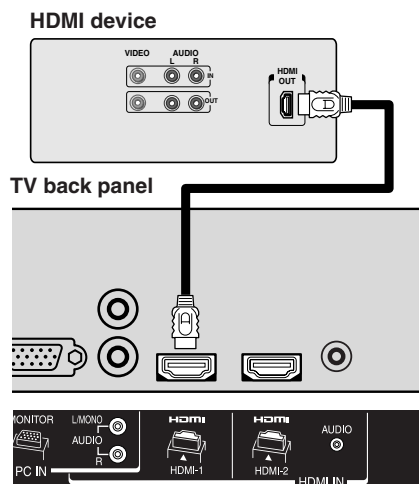

Note:
You can use both HDMI1 and HDMI2 IN for HDMI device connection.

[1] EIA/CEA-861/861B compliance covers the transmission of uncompressed digital video with high-bandwidth digital content protection, which is being standardized for reception of high-definition video signals.
Because this is an evolving technology, it is possible that some devices may not operate properly with the TV.

To ensure that the HDMI or DVI device is reset properly, it is recommended that you follow these procedures:

- When turning on your electronic components, **turn on the TV first**, and then the HDMI or DVI device.
- When turning off your electronic components, **turn off the HDMI or DVI device first**, and then the TV.

To connect a DVI device, you will need:

- one HDMI-to-DVI adapter cable (HDMI type A connector)

For proper operation, the length of an HDMI-to-DVI adapter cable should not exceed 9.8 ft (3m.) The recommended length is 6.6 ft (2m.)

- one pair of standard analog audio cables

An HDMI-to-DVI adapter cable transfers only video. Separate analog audio cables are required (see illustration below.)

You must set the HDMI audio input setting to "DVI" in the AUDIO menu (see page 43.)

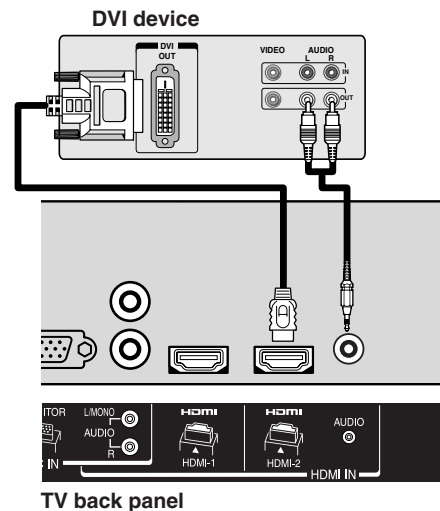

Note:
You can also use HDMI1 IN for DVI device connection. In this case, you must connect the audio cables to AUDIO L/R, not AUDIO.

HDMI, the HDMI logo, and High-Definition Multimedia Interface are trademarks or registered trademarks of HDMI Licensing, LLC.



Connecting an analog audio system

This connection allows you to use external speakers with an external audio amplifier to adjust the sound level.

To control the audio:

Turn on the TV and the stereo amplifier.

Turn off the TV's built-in speakers (see "Turning off the built-in speakers" on page 42.)

Note: To hear sound when using an external audio amplifier, the volume of both the TV and the amplifier must be set to a reasonable listening level.

You will need:

- one pair of standard audio cables

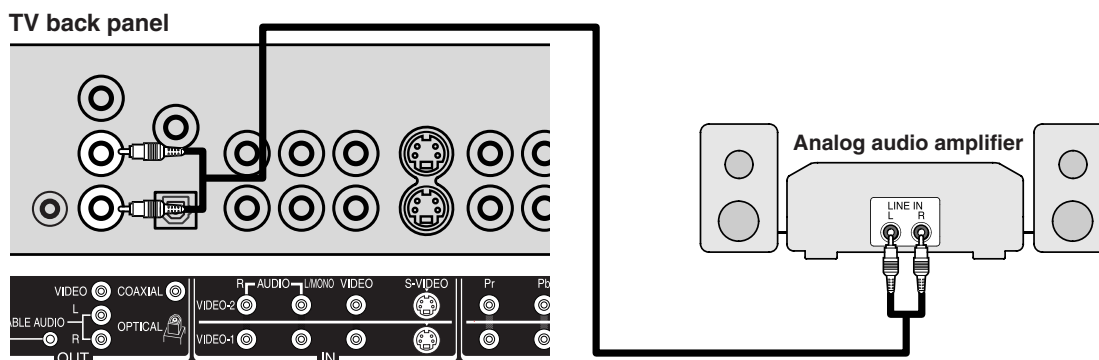

Connecting a digital audio system with built-in digital surround

The TV's two digital audio outputs output a Dolby* Digital  or 2-channel down-mixed PCM (pulse-code modulation) signal for use with an external Dolby Digital decoder or other external audio system with optical or coaxial audio input.

You will need:

- one optical audio cable or coaxial audio cable.

Note:

Refer to the Owner's manual of the audio amplifier as well.

AV Amplifier with built-in digital surround

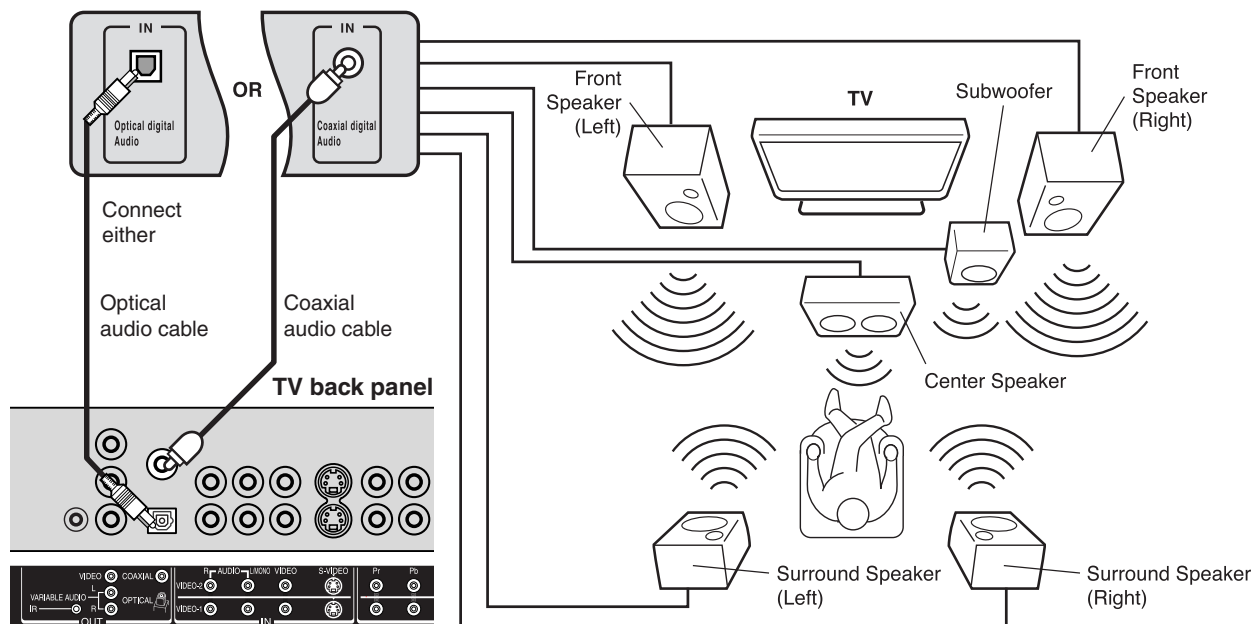

The COAXIAL DIGITAL AUDIO OUT jack outputs digital audio only during digital broadcasts with digital audio. To hear analog broadcast audio, you also must connect analog audio cables from the L/R ANALOG AUDIO jacks to the receiver's inputs. Consult the owner's manual for your receiver to determine the best way to switch between the analog and digital signals.

Connecting a device to the IR OUT terminal for IR pass-through device control

You can use the TV's IR OUT terminal (infrared pass-through) to remotely operate (through the TV) many infrared remote-controlled devices (such as a Toshiba infrared remote-controlled VCR or DVD player) enclosed within an entertainment center or similar cabinet. Without the IR OUT connection, the device typically would need to be visible to operate it remotely.

Connecting your TV

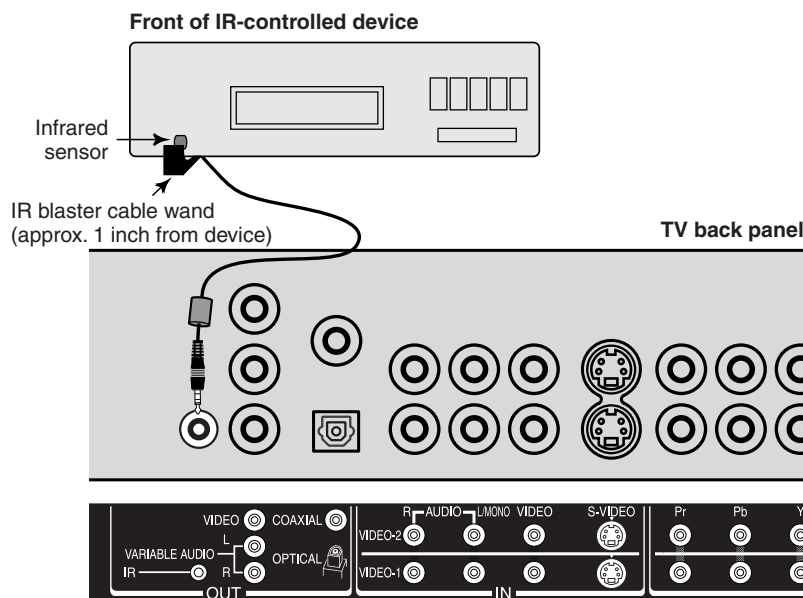

To connect the IR blaster cable:

1. Locate the infrared sensor on the front of your device. This sensor is marked on some devices* (see note at right.)
2. Align the IR blaster cable's wand about 1 inch away from the infrared sensor on the front of the device and attach it using double-sided mounting tape.
3. Plug the IR blaster cable's plug into the TV's IR OUT terminal.

To control the device:

Point the TV remote control (programmed to operate the device; see pages 18, 19) or the device's remote control at the front of the TV and press the button for the desired function. The signal passes from the remote control through the TV to the device via the IR blaster cable.

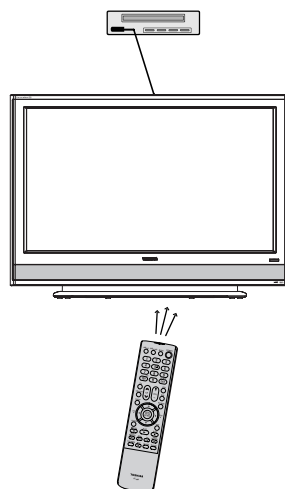

You will need:

- one IR blaster (IR emitter) cable (3.5mm mono mini plug)
- other audio/video cables as required to connect the device(s) to the TV (see pages 7–15)

* If you cannot locate the device's infrared sensor:

1. Turn OFF the device.
2. Starting at the lower left corner of the device, place the end of the device's remote control (with the infrared emitter) so it touches the front of the device and press POWER. (Do not use the TV's remote control for this step.)
3. If the device turns on, the point at which the remote control touched the device is the location of the sensor.
4. If the device does not turn on, move the remote control slightly to the right and press POWER again.
5. Repeat step 4 until you locate the device's infrared sensor.

Note:

If you use the device's remote control to operate the device, you also will need to use the TV's remote control to operate the TV.



Connecting a PC (personal computer)

This connection allows you to use the TV as a computer monitor. Before you connect a PC to the TV, adjust the PC's resolution and refresh rate according to the "Monitor display modes" table at right. When connecting a PC to the TV, use an analog VGA (15 pin) computer cable and a PC audio cable.

Set the video input source to PC mode (see "Selecting the video input source" on page 31 and "Picture/Audio adjustments in the PC mode" on page 45.)

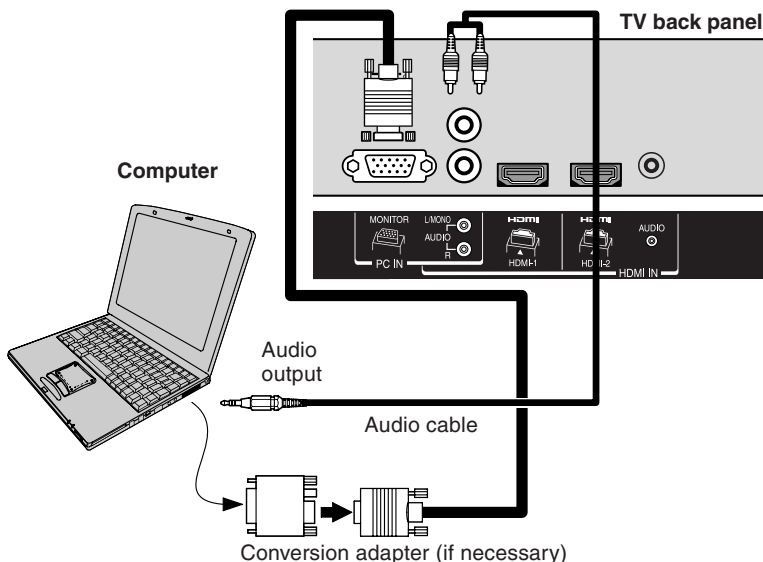

You will need:

- one VGA (15-pin) computer cable
- one PC audio cable

Monitor display modes		
Mode	Resolution	Refresh rate
VGA	640x480	60Hz
WVGA	848x480	60Hz
SVGA	800x600	60Hz
XGA	1024x768	60Hz
WXGA	1280x720	60Hz
WXGA	1280x768	60Hz
WXGA	1360x768	60Hz

Notes:

- Some PC models cannot be connected to this TV.
- An adapter is not needed for computers with a DOS/V compatible mini D-sub 15-pin terminal.
- The on-screen displays will have a different appearance in PC mode than in TV mode.
- If your PC display output corresponds to a WVGA or a WXGA resolution as indicated in the chart above (example: WXGA 1360 x 768), you must set the WVGA INPUT or WXGA INPUT to the ON position in the PC Picture menu in the TV (see page 45).



NOTE: DO NOT CONNECT A PC USING ONE OF THE HDMI INPUTS.

ALWAYS use the VGA port provided to connect a PC.

NOTICE OF POSSIBLE ADVERSE EFFECTS ON PLASMA DISPLAY

Avoid displaying stationary images on your Plasma display for extended periods of time. Fixed (non-moving) patterns or images (including but not limited to PIP/POP windows, closed captions, video game patterns, TV station logos, stock tickers, websites, and special formats that do not use the entire screen) can become permanently ingrained in the Plasma display and cause subtle but permanent ghost images. **This type of damage is NOT COVERED BY YOUR WARRANTY.**

Note:

Make sure to insert the plug of each cord securely.

WARNING:

- Do not connect this unit to power using any other power cord. This could cause fire, electric shock, or damage.
- Do not use with a voltage other than the power voltage displayed. This could cause fire, electric shock, or damage.

CAUTION:

- When this unit is not used for a long time (e.g., if you are away on a trip), in the interest of safety, be sure to unplug it from the wall outlet.
- Do not plug/unplug the power cord when your hands are wet. This may cause electric shock.
- If you need to replace the supplied AC cord, contact your Toshiba authorized dealer.

Power connection

To use AC power

1. Connect the AC cord into the TV's AC inlet.
2. Connect the AC cord into a wall outlet.

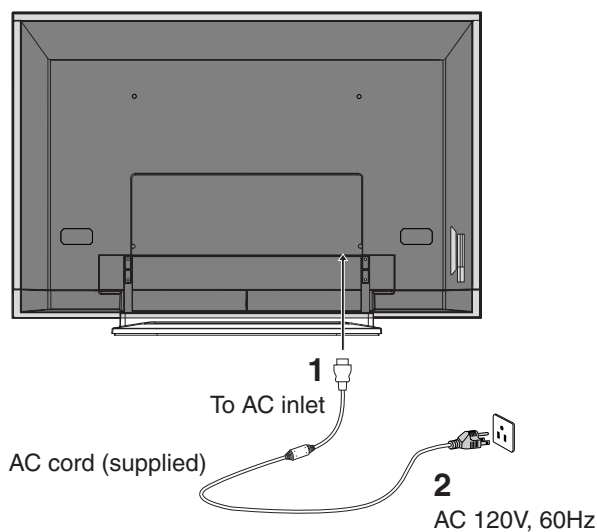



Setting up your TV

Using the remote control

Preparing the remote control for use

In addition to operating the TV, the remote control can operate most cable TV converters, satellite receivers, VCRs, and DVD players, regardless of their brand. The remote control is pre-programmed to operate most Toshiba satellite receivers, VCRs, and DVD players. To control a non-Toshiba device (or a Toshiba device that the remote control is not pre-programmed to operate), you must first program the remote control. See "Programming the remote control to operate your other devices" on the next page.

Installing the remote control batteries

To install the batteries:

1. Open the battery cover on the back of the remote control.

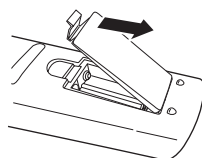

2. Install two "AAA" size batteries. Match the + and - signs on the batteries to the signs on the battery compartment.

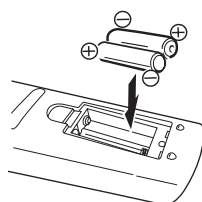

3. Close the battery cover on the remote control until the lock snaps.

Note:

The TV remote control may not operate your VCR, DVD player, or cable TV converter. Refer to the owner's manual supplied with your other devices to see which features may be available. Additionally, the remote control for this TV may not support certain features available on the original remote controls for your other devices, in which case it is suggested that you use the original remote control for the applicable device.

Caution:

- Never throw batteries into a fire.

Notes:

- Be sure to use AAA size batteries.
- Dispose of batteries in a designated disposal area.
- Batteries should always be disposed of with the environment in mind. Always dispose of batteries in accordance with applicable laws and regulations.
- If the remote control does not operate correctly, or if the operating range becomes reduced, replace batteries with new ones.
- When necessary to replace batteries in the remote control, always replace both batteries with new ones. Never mix battery types or use new and used batteries in combination.
- Always remove the batteries from the remote control if they are dead or if the remote control is not to be used for an extended period of time. This will prevent battery acid from leaking into the battery compartment.

Setting up your TV

Using the remote control to operate your other devices

To control a cable TV converter/satellite receiver:

Program the remote control to recognize the brand of your cable TV converter/satellite receiver (see "Programming the remote control to operate your other devices" on the next page.) The buttons shown at right will control the cable TV converter/satellite receiver. Press "CBL/SAT" first.

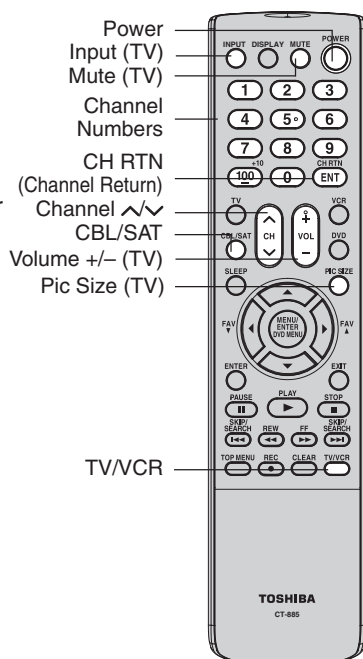

To control a VCR:

Program the remote control to recognize the brand of your VCR (see "Programming the remote control to operate your other devices" on the next page.) The buttons shown at right will then control the VCR. Press "VCR" first.

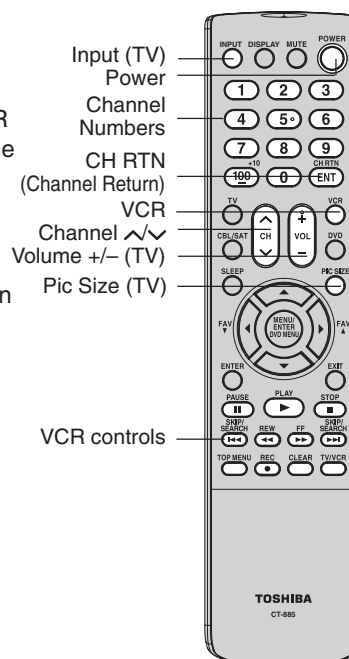



To control a DVD player:

Program the remote control to recognize the brand of your DVD player (see "Programming the remote control to operate your other devices" below.) The buttons shown at right will then control the DVD player.

Press "DVD" first.

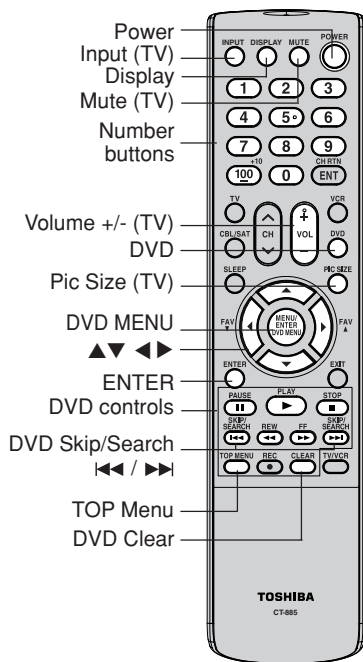

Programming the remote control to operate your other devices

This remote control is pre-programmed to operate most Toshiba satellite receivers, VCRs, and DVD players. To control a non-Toshiba device (or a Toshiba device that the remote control is not pre-programmed to operate), you must follow the steps below to program your remote control.

1. Refer to the code tables (on pages 20 and 21) to find the corresponding code for your device.
If more than one code is listed, try each one separately until you find the one that works.
2. If you are programming the remote control to operate your:
 - Cable TV converter/satellite receiver: Press "CBL/SAT."
 - VCR: Press "VCR."
 - DVD player: Press "DVD."
3. While holding down DISPLAY, press the Channel Number buttons to enter the three-digit code for your device within 10 seconds.
Note: If you do not enter the code within 10 seconds from step 3, or if you enter the wrong code, this operation is canceled.
4. Point the remote control at the cable TV converter/satellite receiver, VCR or DVD player, and press POWER to test the code.
 - If the device responds, you entered the correct code.
 - If the device does not respond, repeat steps 1–4 using another code.
5. Press "TV" to control the TV.

For future reference, write down the codes you used:

Cable TV converter/satellite receiver code _____

VCR code _____

DVD player code _____

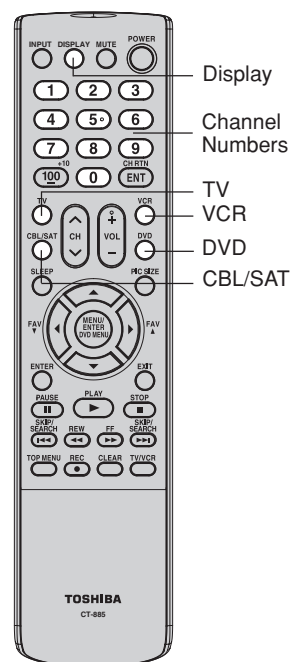

Note:

- When shipped from the factory, the remote control is set to operate your TV.
- Each time you replace the batteries, you must reprogram the remote control.
- Some newer VCRs are capable of working on either of two remote codes. These VCRs have a switch labeled "VCR1/VCR2." If your VCR has this kind of switch and does not respond to any of the codes for your VCR, set the switch to the other position (VCR1 or VCR2) and reprogram the remote control.

Introduction

Connecting your TV

Setting up your TV

Using the TV's Features

Appendix



Device code tables
[For CBL/SAT Mode]
CABLE Box

Brand	Code	Brand	Code	Brand	Code
ABC	061, 062, 063, 082, 084, 087, 091, 092, 096, 098	Jerrold	062, 069, 071, 082, 086, 089, 091, 096	Scientific Atlanta	063, 078, 079, 080, 088, 098, 101, 105
Archer	065, 092, 097, 099	Magnavox	072, 096	Sears	095
Cableview	064, 094	Memorex	091, 092, 104	Signature	062
Century	092	Multi Canal	090	Signature 2000	096
Citizen	090, 092, 097	Novavision	101	Sprucer	081, 085
Contec	083, 085, 086, 088, 093, 098	Panasonic	081, 083, 085	Starcom	069, 082, 087, 096, 103, 104
Diamond	093	Philco	087	Stargate	069, 090
Eagle	091	Philips	066, 067, 068, 070, 072, 073, 074, 075, 091, 092	Sylvania	095, 100
GE	061, 062	Pioneer	076, 077	TeleView	090
Gemini	069, 070, 094	Proscan	061, 062	Texscan	100
General Instruments	062, 089, 096	Radio Shack	092, 097, 099	Tocom	071, 084, 085
Hamlin	093	RCA	064, 081	U. S. Electronics	087, 096, 098
Hitachi	062, 095, 096	Realistic	065	United Cable	082
Jasco	097	Recoton	102	Universal	065, 092, 097, 099, 102, 103
		Samsung	077, 090	Wards	096

Satellite

Brand	Code	Brand	Code	Brand	Code
Alphastar	038, 059	Hughes Network Systems	019	Realistic	030
Chaparral	034	Intersat	048	Samsung	059
DISH Network	057	Janeil	027	Sony	014, 055
Drake	020, 040, 044, 046, 050, 053	JVC	017, 057	Star Choice	057
Echostar	018, 041, 051	Kenwood	029	Star Trak	025, 026, 037, 054
Express Vu	057	Magnavox	060	STS	024
Fujitsu	027	Optimus	058	Toshiba	000, 001, 002, 003, 004, 005, 006, 007, 020, 031, 056
GE	008, 009, 013	Pansat	036, 052	Uniden	021, 028, 030, 032, 035, 039, 043, 045, 047, 058
General Instruments	010, 011, 012, 022, 023, 031, 049	Primestar	015, 042	Zenith	027
Hitachi	033	Proscan	008, 009, 013		
Hughes	033	Radio Shack	022, 023, 030		
		RCA	008, 009, 013, 016		

[For VCR Mode]
VCR

Brand	Code	Brand	Code	Brand	Code
Admiral	049	Fuji	004, 041	Marantz	005, 006, 007, 012, 014, 026, 053, 067
Aiko	019	Funai	018, 073	Memorex	007, 009, 010, 016, 018, 034, 049, 063, 065, 066, 068, 075, 079
Aiwa	018	Garrard	018	MGA	020, 028, 039
Akai	003, 004, 037, 038, 039, 058, 069	GE	001, 002, 009, 040, 042, 048, 056	MGN	056
Audiovox	010	Go Video	056, 059, 061, 081	Minolta	024, 025, 035, 063
Bell & Howell	007, 068	Goldstar	005, 010, 014, 054, 056, 065, 067	Mitsubishi	020, 024, 025, 028, 039, 043, 065
Broksonic	008, 017	Gradiente	018, 065	Montgomery Ward	049
Calix	010	Harman Kardon	005	Motorola	049
Carver	026	Hitachi	024, 025, 035, 037, 042, 063, 070, 080	MTC	009, 046, 061
CCE	019	JBL	076	Multitech	009, 012, 018
Citizen	009, 010, 011, 012, 013, 014, 015, 019, 057, 073	JC Penney	005, 006, 007, 008, 009, 010, 023, 024, 025, 026, 035, 056, 061, 063, 065	NEC	005, 006, 007, 012, 014, 037, 043, 053, 054, 067, 070
Colortyme	005	Jensen	024, 025, 037	Nikko	010
Craig	009, 010, 016, 061, 065, 079	JVC	005, 006, 007, 014, 037, 043, 062, 063, 068, 082	Noblex	009
Curtis Mathes	001, 005, 009, 012, 014, 040, 048, 053, 056, 057	Kenwood	005, 006, 007, 012, 014, 037, 043, 053, 068, 071	Optimus	010, 049, 065
Daewoo	011, 013, 015, 017, 018, 019, 057, 078	Kodak	010	Optonica	031
Daytron	078	LG	010	Orion	054, 057, 062, 065, 068, 072
Denon	063	Lloyds	053, 073, 079	Panasonic	036, 045, 046, 057, 061, 072, 079
Dimensia	001, 048	Logik	061	Pentax	012, 024, 025, 035, 042, 053, 063
Electrohome	010, 020, 065	LXI	010	Pentex Research	014
Emerson	003, 008, 010, 011, 017, 018, 020, 028, 039, 054, 057, 062, 065, 068, 072	Magnasonic	061, 065, 078	Philco	026, 027, 063
Fisher	007, 016, 021, 022, 023, 057, 064, 068, 070, 071, 079	Magnavox	026, 027, 034, 044, 057, 061, 072	Philips	026, 031, 044, 057
				Pioneer	006, 024, 043, 055

Setting up your TV



VCR (Continued)

Brand	Code	Brand	Code	Brand	Code
Portland	012, 013, 015	Sanyo	007, 009, 016, 054, 064, 068, 071, 075, 079, 085	Tashiko	010
Proscan	001, 002, 048			Tatung	037
Proton	061	Scott	008, 011, 017, 028, 030, 057, 065, 072	Teac	018, 029, 037
Quasar	045			Technics	036
Radio Shack	010, 031, 065	Sears	007, 010, 016, 021, 022, 023, 024, 025, 035, 053, 057, 063, 064, 065, 068, 071, 075, 079	Teknika	010, 018, 065
Radio Shack/ Realistic	007, 009, 010, 016, 018, 020, 021, 022, 031, 049			Toshiba	000, 011, 021, 023, 024, 028, 030, 039, 057, 074, 078, 079
Radix	010	Sharp	013, 020, 031, 049, 051, 060, 066	Totevision	009, 010, 065
RCA	001, 002, 003, 009, 024, 025, 029, 035, 040, 042, 045, 048, 055, 056, 063, 071, 083	Shintom	004, 025, 032, 061	Unitec	073
Realistic	007, 009, 010, 011, 016, 018, 020, 021, 022, 031, 049, 051, 056, 060, 065, 075, 079	Signature	049	Unitech	009
		Signature 2000	075	Vector Research	005, 006, 011, 012, 053
		Singer	047, 061	Video Concepts	005, 006, 011, 012, 039, 053
		Sony	004, 032, 033, 041, 052, 058, 070, 074, 076, 077, 080	Wards	009, 010, 011, 016, 018, 020, 024, 025, 031, 035, 049, 051, 056, 057, 060, 065, 066, 079
Ricoh	047	STS	035	White Westinghouse	073
Runco	034	Sylvania	018, 026, 027, 028, 044, 072	XR-1000	018
Samsung	009, 011, 038, 056, 073, 084	Symphonic	018, 051, 053, 073, 079	Yamaha	005, 006, 007, 014, 037, 053
Sansui	006, 037, 043, 061	Tandy	007	Zenith	004, 032, 034, 041, 047, 069, 086

TV/VCR Combo

Brand	Code	Brand	Code	Brand	Code
Action	078	Precision	078	Toshiba	057
GE	059, 062	Quasar	065	Zenith	065
Goldstar	065	Realistic	079	Totevision	009, 010, 065
Panasonic	065	Sony	074		

[For DVD Mode]

DVD

Brand	Code	Brand	Code	Brand	Code
Aiwa	006, 015	Kenwood	037	Sampo	060
Apex	016, 017	Konka	008, 009	Samsung	061, 062, 086, 090
BOSE	097	Magnavox	004, 038	Sansui	073
Broksonic	018	Memorex	039	Sanyo	063, 091
Clarion	019	Mintek	040	Sharp	064, 067
Classic	020	NAD	026	Sherwood	074
Daewoo	021	Nakamichi	041	Sony	011, 012, 065, 066, 068, 069, 070
Denon	022, 023, 024, 025	Norcent	043	Sylvania	027
Emerson	026, 027	Onkyo	044	Teac	071
Fisher	028	Oritron	058	Technics	072
Funai	027	Panasonic	010, 045, 046, 047, 048, 049, 050	Techwood	075
GE	001, 029, 030	Philips	004, 051	Toshiba	000, 013, 076, 077, 078
Go Video	087	Pioneer	052, 053, 054, 055	Yamaha	079, 080, 081
GPX	031	Proscan	001, 056	Zenith	014, 082, 092
Hitachi	005, 032, 033, 034, 035	Qwestar	057, 058		
JVC	003, 007, 036, 042, 088	RCA	001, 002, 059, 089		

Portable DVD

Brand	Code	Brand	Code	Brand	Code
Aiwa	093	Panasonic	024, 096, 099	RCA	098
Audiovox	094, 095				

HTIB

Brand	Code	Brand	Code	Brand	Code
Lasonic	083	Panasonic	084	Venturer	085

[For VCR and DVD Mode]

DVD/VCR Combo

Brand	VCR Code	DVD Code	Brand	VCR Code	DVD Code
Go Video	081	087	Samsung	084	090
JVC	082	088	Sanyo	085	091
RCA	083	089	Zenith	086	092



Learning about the remote control

INPUT selects the video input source (page 31)

DISPLAY displays status information on-screen (page 44)

MUTE turns off the sound (page 41)

POWER turns the TV on and off

CHANNEL NUMBERS allow direct access to channels (page 25)

CH RTN (Channel Return) returns to the last viewed channel (page 25)

TV selects TV mode

CBL/SAT selects CBL/SAT mode (page 18)

CH $\wedge\vee$ cycles through programmed channels (page 24)

VOL +/- adjusts the volume level

VCR selects VCR mode (page 18)

DVD selects DVD mode (page 19)

SLEEP programs the TV to turn off at a set time (page 32)

PIC SIZE cycles through the five picture sizes: Natural, TheaterWide 1, TheaterWide 2, TheaterWide 3 and full (page 33)

MENU/ENTER accesses the menu system; also sets menu selections (page 23)

FAV $\blacktriangle/\blacktriangledown$ (**Favorite Channels**) cycles through the channels you programmed as favorite channels (page 25)

EXIT closes on-screen menus (page 23)

DVD MENU accesses the DVD menu

PAUSE pauses a videotape/DVD

PLAY plays a videotape/DVD

STOP stops a videotape/DVD

DVD SKIP/SEARCH $\blacktriangleleft\blacktriangleright$ skips DVD chapter

REW rewinds/reverses a videotape/DVD

FF fast forwards a videotape/DVD

TOP MENU accesses the DVD TOP menu

REC starts recording a videotape

CLEAR clears input data in DVD mode

TV/VCR toggles between TV and VCR modes when viewing while recording

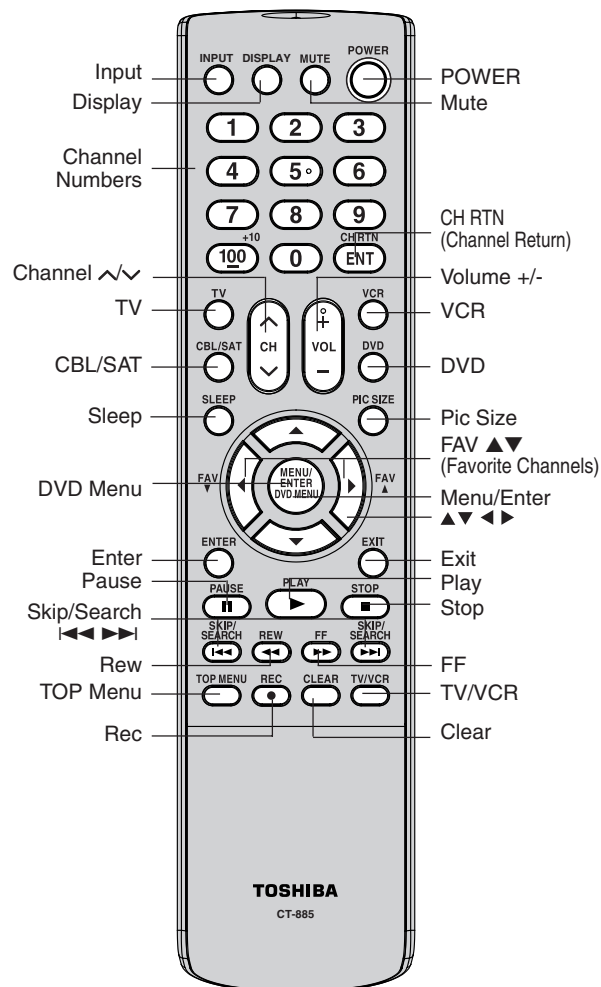

Remote control effective range

- Aim the remote control at the TV's remote sensor (see illustration) and press the buttons to operate.
- Operate the remote control within a 30 degree angle on either side of the remote sensor, up to a distance of approx. 16 ft. (5m.)

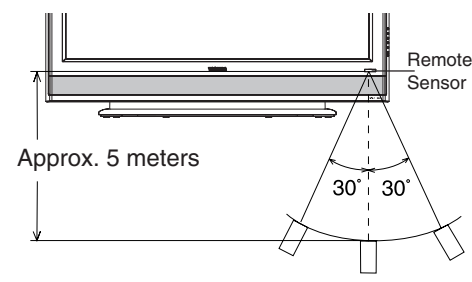



Starting setup

The STARTING SETUP feature appears the first time you turn on the TV, and helps you select the menu language, specify the TV/CABLE setting, and program channels automatically.

IMPORTANT: Make sure that the antenna or cable TV system is connected.

1. Press TV to select the TV mode.
2. Press POWER to turn on the TV. The STARTING SETUP function begins and the language setup menu appears on the screen. Press ▲ or ▼ to select your desired language, then press ENTER.
3. Press ▲ or ▼ to select TV or CABLE, then press ENTER.
4. Press ▲ or ▼ to select START, and then press ENTER, which starts the AUTO SETUP.

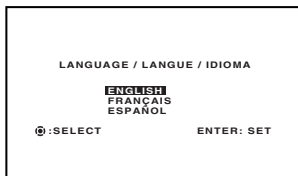

Note:

To cancel the setup and return to the regular TV screen, press ▲ or ▼ to select CANCEL and press ENTER.

5. When the AUTO SETUP is complete, the regular TV screen appears.

Notes:

- AUTO SETUP of channels may take 15–30 minutes to complete, depending on your regional cable service.
- To cancel the AUTO SETUP and return to the regular TV screen, press EXIT.

After you have installed the batteries and programmed the remote control, you need to set some preferences on the TV using the menu system. You can access the menu system with the buttons on the remote control.

- When you make a menu selection, your changes are immediate. You do not have to press MENU or EXIT to save your changes.
- After one minute, the menu screen will automatically close if you do not make a selection. Your changes will still be saved.
- When you are finished programming the menus, press EXIT.

Changing the on-screen display language

You can choose from three different languages (English, French and Spanish) for the on screen displays. Adjustment menus and messages will appear in the language of your choice.

To select a language:

1. Press TV to select the TV mode.
2. Press MENU, then press ◀ or ▶ until the SETUP menu appears.

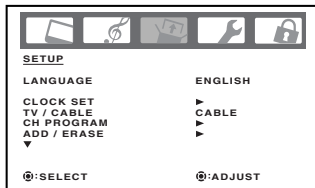

3. Press ▲ or ▼ to highlight LANGUAGE.

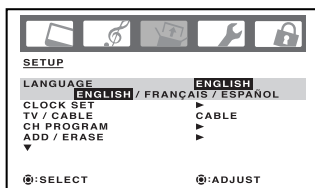

4. Press ◀ or ▶ to highlight your desired language.

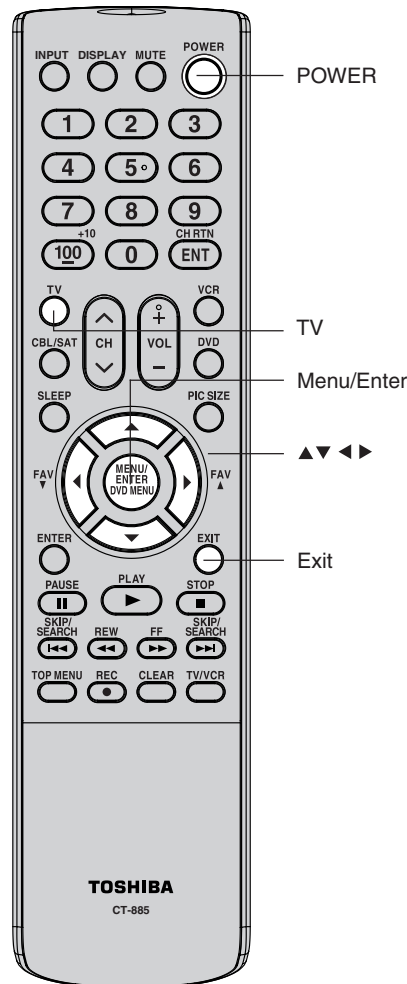

Introduction

Connecting your TV

Setting up your TV

Using the TV's Features

Appendix

Note:

The position and size of the on-screen menus may change for some program formats (such as 1080i or 720p.)

Note:

If the remote control does not operate your TV, press the "TV" button on the remote control and try again.



Adding channels to the TV's memory

When you press CH \wedge or \vee , your TV will stop only on the channels you have programmed into the TV's channel memory. Follow the steps below to program channels into the channel memory.

Programming channels automatically

Your TV can automatically detect all active channels and store them in its memory. After the TV has stored the channels in its memory automatically, you can add or erase channels manually.

To add channels automatically:

1. Press TV to select the TV mode.
2. Press MENU, then press \leftarrow or \rightarrow to display the SETUP menu.
3. Press \blacktriangle or \blacktriangledown until the TV/CABLE selection is highlighted.
4. Press \leftarrow or \rightarrow to highlight either TV or CABLE, depending on which you use.
If you use an antenna, choose TV.
If you use cable, choose CABLE.
5. Press \blacktriangledown until the CH PROGRAM selection is highlighted.
6. Press \rightarrow to start channel programming. The TV will automatically cycle through all the TV or Cable channels (depending on which you selected), and store all active channels in the channel memory. While the TV is cycling through the channels, the message "PROGRAMMING NOW PLEASE WAIT" appears.
7. When channel programming is complete, the message "COMPLETED" appears.
8. Press CH \wedge or \vee to view the programmed channels.

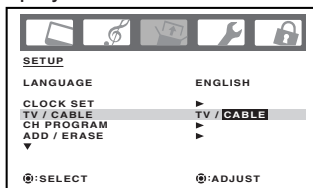

Adding and erasing channels manually

After you have programmed the channels automatically, you can add or erase specific channels manually.

To add or erase channels manually:

1. Press TV to select the TV mode.
2. Press MENU, then press \leftarrow or \rightarrow to display the SETUP menu.
3. Press \blacktriangle or \blacktriangledown to highlight ADD/ERASE.
4. Press \rightarrow to display the ADD/ERASE menu.
5. Select the desired channel to be memorized or deleted using \blacktriangle or \blacktriangledown . Press \leftarrow or \rightarrow to select either ADD or ERASE.
6. Repeat step 5 for other channels you want to add or erase, then press ENTER.
7. Press EXIT to return to the normal screen.

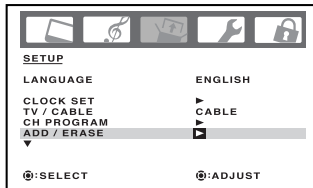

To add a digital channel you are watching:

Select a channel you want to add. Press \blacktriangle or \blacktriangledown to select ADDING CHANNEL in step 4 above, then press \rightarrow .

To erase all channels from the channel memory:

Press \blacktriangle or \blacktriangledown to select CLEAR ALL in step 4 above, then press \rightarrow . All channels are erased from the channel memory. (You can still use the Channel Numbers on the remote control to tune a channel.)

Changing channels

To change to the next programmed channel:

Press Channel \blacktriangle / \blacktriangledown on the TV or CH \wedge / \vee on the remote control.

To change to a specific channel (programmed or unprogrammed):

Press the Channel Number buttons (0-9) on the remote control. For example, to select channel 125, press 1, 2, 5.

To change to a specific digital channel:

Press the first 3 digits, then press 100, followed by the remaining 3 digits. For example, to select channel 015-001, press 0, 1, 5, 100, 0, 0, 1.

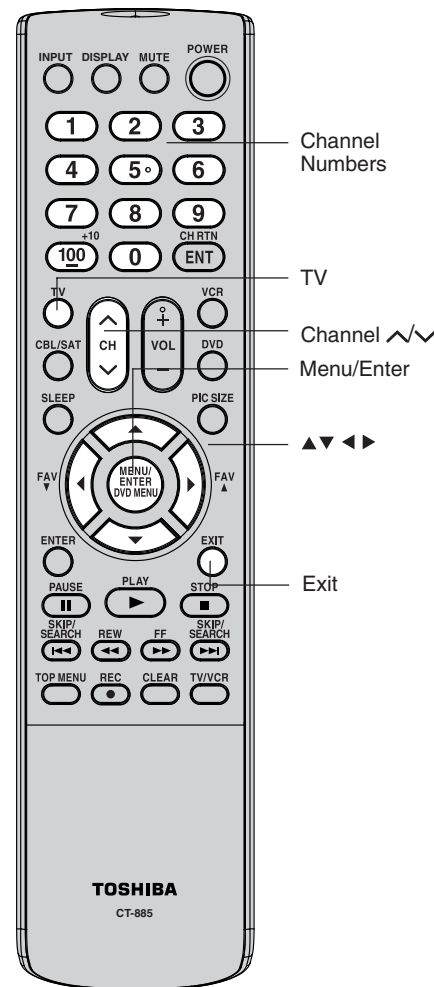

In addition to cycling through your programmed channels, the Channel \wedge or \vee buttons will also cycle through the video input sources (page 31) in the order illustrated below.

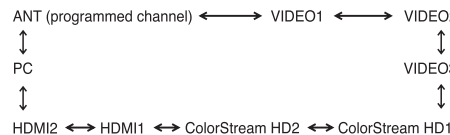

Note:

Digital cable channels may be represented by channel numbers that include a "dash" (e.g., 85-002.) These digital channel numbers may not match the numbers in the channel line-up provided by your cable company. This is not a malfunction.

Note:

If the remote control does not operate your TV, press the "TV" button on the remote control and try again.



Using the V-Chip (parental control) feature

The Motion Picture Association of America (MPAA) uses a rating system to qualify motion picture content. Television broadcasters also employ a rating system to qualify the content of television programs. The TV and MOVIE ratings work with the V-Chip feature and allow you to block programs according to the rating limits you set.

To use the V-Chip to block programs by rating:

1. Press TV to select the TV mode.
2. Press MENU, then press ◀ or ▶ to display the LOCKS menu.
3. Press ▲ or ▼ to display the password entering mode.
4. Use the Channel Number buttons (0-9) to enter your password. Press ENTER. The LOCKS menu appears.
5. Press ▲ or ▼ to highlight V-CHIP.
 - Press ◀ or ▶ to highlight ON to enable V-Chip program blocking by rating.
 - Press ◀ or ▶ to highlight OFF to disable V-Chip program blocking by rating.
6. Press ▲ or ▼ to highlight V-CHIP SET. Then, press ◀ or ▶ to display the V-CHIP SET menu.
7. Press ▲ or ▼ to highlight TV RATING. Then, press ◀ or ▶ to display the desired rating.

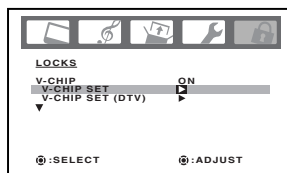
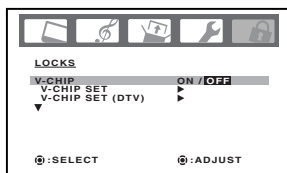

- OFF** : TV RATING is not set
- TV-Y** : All children
- TV-Y7** : 7 years old and above
- TV-G** : General audience
- TV-PG** : Parental guidance
- TV-14** : 14 years old and above
- TV-MA** : 17 years old and above

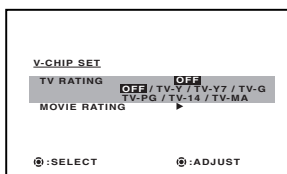

- When you select TV-Y7, TV-PG, TV-14 or TV-MA, press DISPLAY to explain the rating. Press ▲ or ▼ to select the desired rating you want. Press ◀ or ▶ to select the setting ON or OFF, then press ENTER.
8. Press ▲ or ▼ to highlight MOVIE RATING. Then, press ◀ or ▶ to display the RATING SET menu. Press ▲ or ▼ to select the desired rating, then press ◀ or ▶ to select ON or OFF.

- G** : All ages
- PG** : Parental guidance
- PG-13** : Parental guidance less than 13 years old
- R** : Under 17 years old Parental guidance suggested
- NC-17** : 17 years old and above
- X** : Adult only

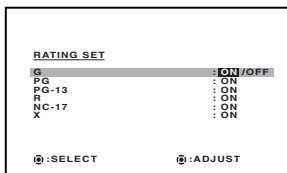

9. When you are done selecting the ratings, press EXIT to return to normal viewing.

When you try to view a program with a ratings block, a message will appear listing the program's ratings. The program can still be viewed if you press MUTE and then enter your password to temporarily pass the block.

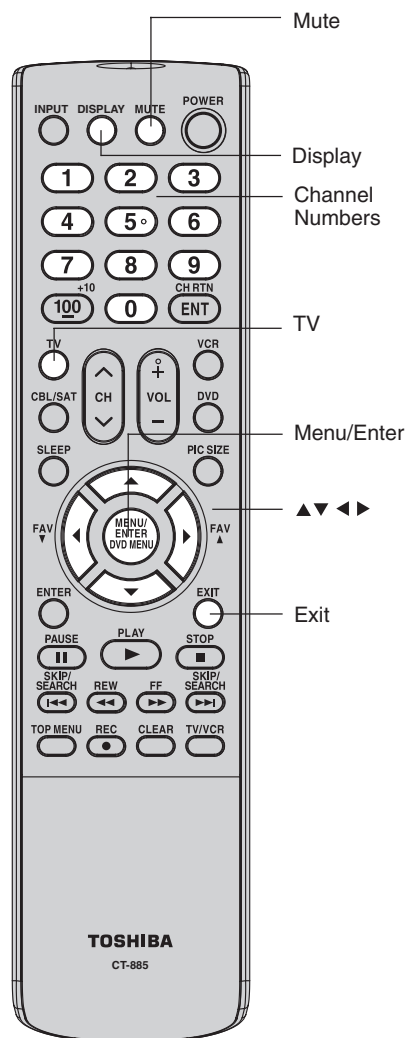

Introduction

Connecting your TV

Setting up your TV

Using the TV's Features

Appendix

Note:

- If the remote control does not operate your TV, press the "TV" button on the remote control and try again.
- You can use V-CHIP SET (DTV) function when the digital broadcasting with a new rating system is received on the TV.



Locking channels

With the CH LOCK feature, you can lock specific channels. You will not be able to tune locked channels unless you clear the setting. You can choose to lock up to nine TV channels and nine cable channels.

1. Press TV to select the TV mode.
2. Use the Channel Number buttons (0-9 and 100) to display the television channel you wish to lock.
3. Press MENU, then press ◀ or ▶ to display the LOCKS menu.
4. Press ▲ or ▼ to display the password entering mode.

5. Use the Channel Number buttons (0-9) to enter your password, then press ENTER. The LOCKS menu appears.

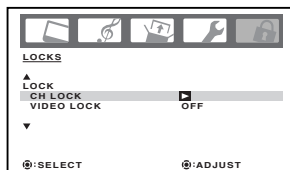

6. Press ▲ or ▼ to highlight CH LOCK and press ▶ to display the CH LOCK menu.

7. Press ◀ or ▶ to select the following:
 - **SET:** to set the channel as one to be locked. Then press ENTER.
 - **CLEAR:** to clear all channels from the list of locked channels. Then press ENTER.

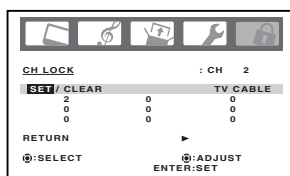

8. Repeat steps 1 through 7 to lock other channels. When you are finished locking channels, press EXIT to return to normal viewing.

If you try to tune a locked channel, the TV will not display it, but will display the nearest unlocked channel.

To unlock channels:

1. Press TV to select the TV mode.
2. Press MENU, then press ◀ or ▶ to display the LOCKS menu.
3. Press ▲ or ▼ to display the password entering mode.
4. Use the Channel Number buttons (0-9) to enter your password, then press ENTER. The LOCKS menu appears.
5. Press ▲ or ▼ to highlight CH LOCK and press ▶ to display the CH LOCK menu.
6. Press ◀ or ▶ to highlight CLEAR and clear all channels from the list of locked channels. Press ENTER.
7. Press EXIT to return to normal viewing.

Locking the video inputs

With the VIDEO LOCK feature, you can lock out the input sources (VIDEO-1~3, ColorStream HD-1/2, HDMI-1/2, PC) and channels 3 and 4. You will not be able to select the input sources with the INPUT button or Channel Number buttons unless you clear the setting.

To set up the video lock:

1. Press TV to select the TV mode.
2. Press MENU, then press ◀ or ▶ to display the LOCKS menu.
3. Press ▲ or ▼ to display the password entering mode.
4. Use the Channel Number buttons (0-9) to enter your password, then press ENTER. The LOCKS menu appears.
5. Press ▲ or ▼ to highlight VIDEO LOCK.
6. Press ◀ or ▶ to select:
 - **OFF:** Unlocks all video input sources.
 - **VIDEO:** Locks VIDEO-1~3, ColorStream HD-1/2, HDMI-1/2, PC.
 - **VIDEO +:** Locks VIDEO-1~3, ColorStream HD-1/2, HDMI-1/2, PC, channel 3 and channel 4. This option should be used if you use the antenna terminal to play a video tape.
7. Press EXIT to return to normal viewing.

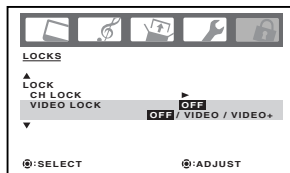

To unlock the video inputs:

Select OFF in step 6, above.

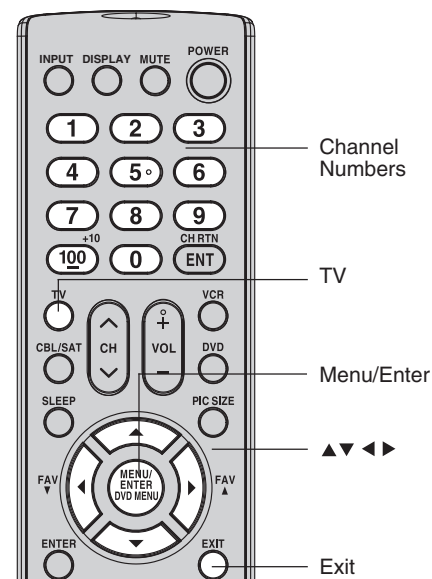

Note:

After programming CH LOCK, change channels before turning off the television.

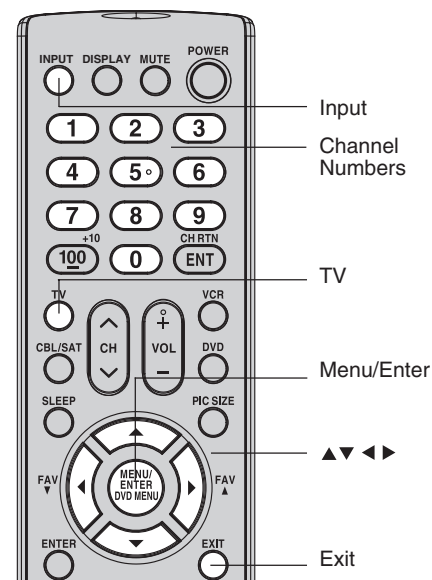

Note:

After programming VIDEO LOCK, change channels or press INPUT before turning off the television.

Note:

If the remote control does not operate your TV, press the "TV" button on the remote control and try again.



Setting the GameTimer™

With the GameTimer™ feature, you can automatically activate the VIDEO LOCK feature (VIDEO setting) to set a time limit for playing a video game (30, 60, 90 or 120 minutes.)

To set up the GameTimer:

1. Press TV to select the TV mode.
2. Press MENU, then press ◀ or ▶ to display the LOCKS menu.
3. Press ▲ or ▼ to display the password entering mode.
4. Use the Channel Number buttons (0-9) to enter your password, then press ENTER. The LOCKS menu appears.
5. Press ▲ or ▼ to highlight GAME TIMER.
6. Press ◀ or ▶ to select a time limit (30 minutes, 60 minutes, 90 minutes, 120 minutes or OFF.)
7. Press EXIT to return to normal viewing.

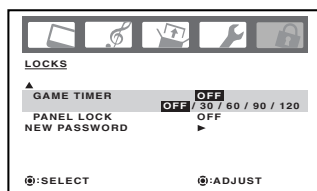

After the GameTimer is programmed, the display will appear briefly every ten minutes to remind you that the GameTimer is operating.

When the programmed time is reached, the TV will change channels automatically and enter VIDEO LOCK mode.

To deactivate the GameTimer and unlock the VIDEO LOCK:

Set the VIDEO LOCK to OFF (see "Locking the video inputs", page 28.)

Using the panel lock feature

You can lock the right side panel controls to prevent your settings from being changed accidentally (by children, for example.) When the panel lock is in ON, all control buttons on the TV side panel (except POWER) do not operate.

To lock the right side panel controls:

1. Press TV to select the TV mode.
2. Press MENU, then press ◀ or ▶ to display the LOCKS menu.
3. Press ▲ or ▼ to display the password entering mode.
4. Use the Channel Number buttons (0-9) to enter your password, then press ENTER. The LOCKS menu appears.
5. Press ▲ or ▼ to highlight PANEL LOCK and press ◀ or ▶ to highlight ON.
6. Press EXIT to return to normal viewing.

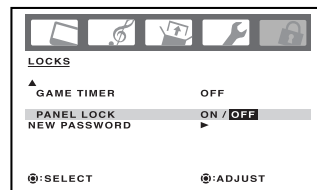

If a button on the side panel is pressed, the message "NOT AVAILABLE" appears.

To unlock the right side panel controls using the menus:

Select OFF in step 5, above.

To unlock the right side panel controls using the TV controls:

Press and hold the VOLUME ◀ button on the TV right side panel for about 10 seconds until the message "PANEL LOCK:OFF" appears on-screen.

Note:

You can enjoy playing video games on this Plasma TV; however, certain video games that utilize so-called "light gun" joysticks for shooting at on-screen targets may not work with this Plasma TV.

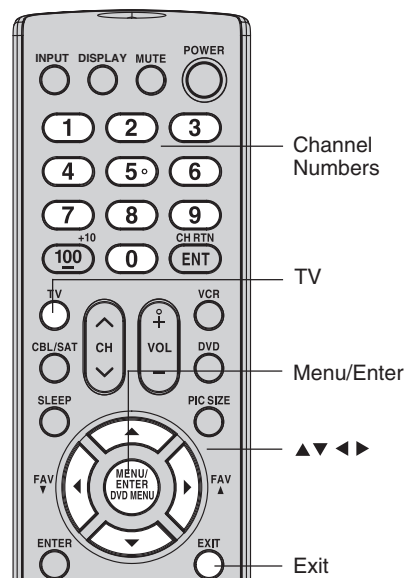

TV right side panel

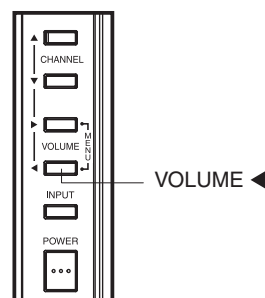

Introduction

Connecting your TV

Setting up your TV

Using the TV's Features

Appendix



Labeling channels

Channel labels appear above the on-screen channel number display each time you turn on the TV, select a channel, or press the DISPLAY button. You can choose any four characters to create a channel label.

To create channel labels:

1. Press TV to select the TV mode.
2. Select a channel you want to label.
3. Press MENU, then press ◀ or ▶ until the OPTION menu appears.
4. Press ▲ or ▼ to highlight CH LABEL.
5. Press ▶ to display the CH LABEL menu. SET/CLEAR will be highlighted.
6. Press ◀ or ▶ to highlight SET.
7. Press ENTER to highlight LABEL.
8. Repeatedly press ◀ or ▶ until the character you want appears. Press ENTER.

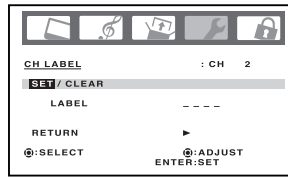
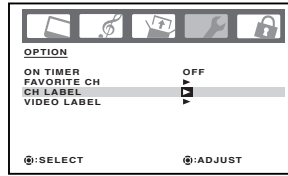

Note:

The character will change as follows:

- ↔ 0...9 ↔ A...Z
 ↔ SPACE ↔ + ↔ -

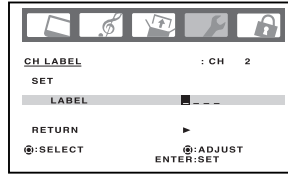

9. Repeat step 8 to enter the rest of the characters.
If you would like a blank space in the label name, you must choose an empty space from the list of characters; otherwise, a dash will appear in that space.
10. Repeat steps 1-9 for other channels. You can assign a label to each channel.
11. Press EXIT to return to normal viewing.

To erase channel labels:

1. Press TV to select the TV mode.
2. Tune the TV to the channel whose label you want to erase.
3. Press MENU, then press ◀ or ▶ until the OPTION menu appears.
4. Press ▲ or ▼ to highlight CH LABEL.
5. Press ▶ to display the CH LABEL menu. SET/CLEAR will be highlighted.
6. Press ◀ or ▶ to highlight CLEAR.
7. Press ENTER.
8. Repeat steps 1-7 to erase other channel labels.

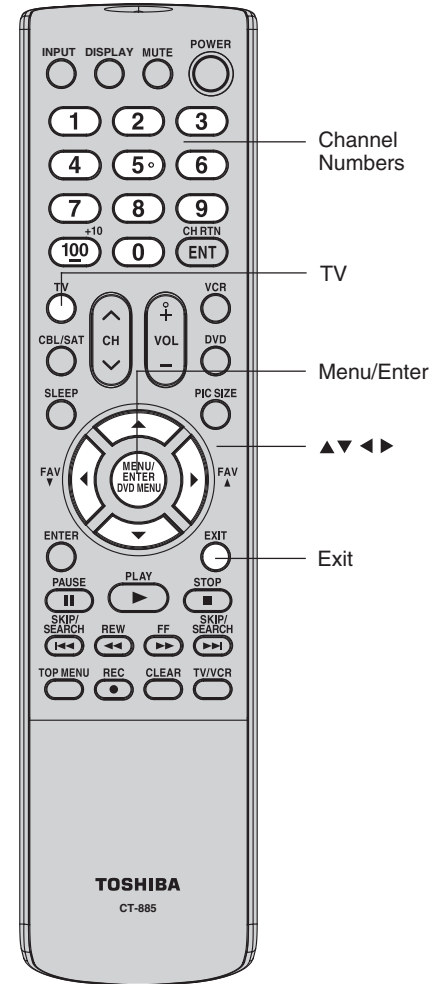

Note:

If the remote control does not operate your TV, press the "TV" button on the remote control and try again.



Selecting the video input source

Press INPUT to view a signal from another device connected to your TV, such as a VCR or DVD player. You can select ANT, VIDEO1, VIDEO2, VIDEO3, ColorStream HD1, ColorStream HD2, HDMI1, HDMI2 or PC, depending on which input jacks you used to connect your devices (see "Connecting your TV" on page 8.)

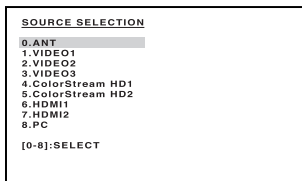

Pressing INPUT on the remote control displays the current signal source (press INPUT again or 0-8 to change)

You also can use the Channel \wedge/\vee buttons to select the video input source. In addition to cycling through your programmed channels (page 24), the Channel \wedge/\vee buttons will also cycle through the video input sources, in the order illustrated below.

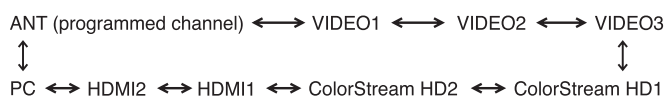

Labeling the video input sources

The video label feature allows you to label each input source for your TV from the following preset list of labels:

- : Uses the default label name
- VCR : Video cassette recorder
- DVD : DVD video
- DTV : Digital TV set-top box
- SAT : Satellite box
- CBL : Cable box
- HD : HDMI device

To label the video input sources:

1. Press TV to select the TV mode.
2. Press MENU, then press \leftarrow or \rightarrow to display the OPTION menu.
3. Press \blacktriangle or \blacktriangledown to highlight VIDEO LABEL.
4. Press \rightarrow to display the VIDEO LABEL menu.
5. Press \blacktriangle or \blacktriangledown to highlight the video source you want to label.
6. Press \leftarrow or \rightarrow to select the desired label for that input source.
7. Press EXIT to return to normal viewing.

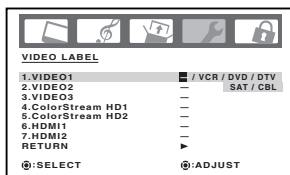
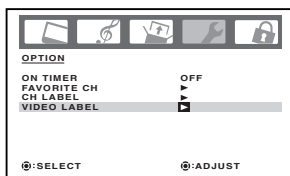

Setting the clock

You must set the clock before you can program the ON timer.

To set the clock:

1. Press TV to select the TV mode.
2. Press MENU, then press \leftarrow or \rightarrow to display the SETUP menu.
3. Press \blacktriangle or \blacktriangledown to highlight CLOCK SET, then press \rightarrow .
4. Press \leftarrow or \rightarrow to set the MONTH, then press \blacktriangledown .
5. Set the DAY, YEAR and TIME as in step 4. After setting the clock, the date and time function starts automatically.
6. Press EXIT to return to the normal screen.

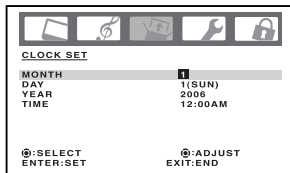
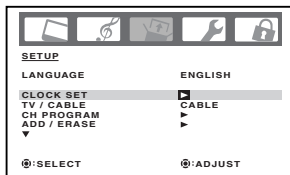

Please note the following regarding the HDMI1 and HDMI2 source selections:



NOTE: DO NOT CONNECT A PC USING ONE OF THE HDMI INPUTS.

ALWAYS use the VGA port provided to connect a PC.

See "Connecting an HDMI™ or DVI device" on page 14 and "Connecting a PC" on page 17 for details.

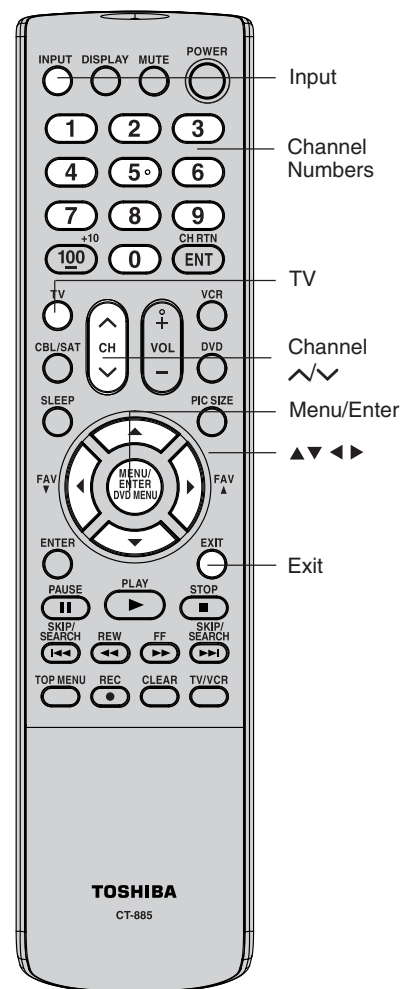

Introduction

Connecting your TV

Setting up your TV

Using the TV's Features

Appendix



Setting the ON timer

This feature allows you to program the TV to turn on automatically at a set time. If you program the ON TIMER to "DAILY," the TV will turn on every day at the same time to the same channel until you clear the ON TIMER.

To set the ON timer: (Example: Turning on the TV to channel 2 at 6:30 AM, DAILY)

1. Press TV to select the TV mode.
2. Set the clock, if you have not already done so (see page 31.)
3. Press MENU, then press ◀ or ▶ to display the OPTION menu.
4. Press ▲ or ▼ to highlight ON TIMER.
5. Press ◀ or ▶ to highlight SET, then press ENTER. The ON TIMER menu appears. Press ▶ to set the time.
6. Press ▲ or ▼ to set the desired hour, then press ▶.

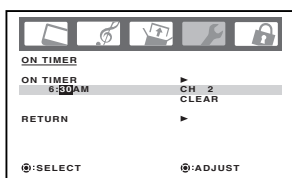

7. Set the desired minutes and channel, as in step 6.
8. Press ◀ or ▶ to select ONCE or DAILY, then press ENTER.

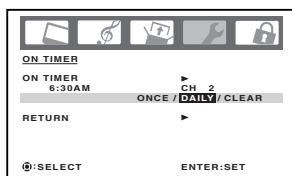

9. Press EXIT to return to normal viewing.

To cancel the on timer:

Select CLEAR in step 8, above.

Setting the sleep timer

You can use the sleep timer to automatically turn off the TV at a set time.

To set the sleep timer:

Repeatedly press SLEEP on the remote control to set the length of time until the TV turns off. The clock will increase 10 minutes for each press of the SLEEP button (0h00m, 0h10m, ...1h50m, 2h00m.) After the sleep timer is programmed, the display will appear briefly every ten minutes to remind you that the sleep timer is operating.

To confirm the sleep timer setting:

Press SLEEP one time. The remaining time will be momentarily displayed.

To cancel the sleep timer:

Repeatedly press SLEEP until the display turns to 0h00m.

Note:

After a power failure or disconnection of the power, the timer settings will be lost.

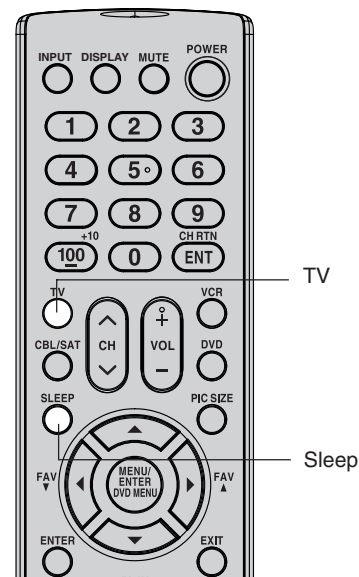
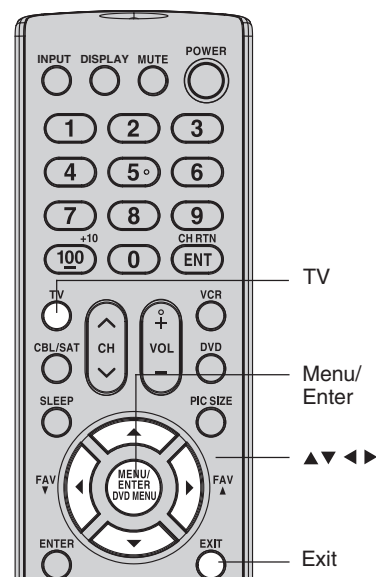

Note:

If the remote control does not operate your TV, press the "TV" button on the remote control and try again.



Viewing the wide-screen picture formats (480i and 480p signals only)

You can view 480i and 480p format programs in a variety of picture sizes—Natural, TheaterWide 1, TheaterWide 2, TheaterWide 3, and Full.

The way the image displays in any of the picture sizes will vary depending on the format of the program you are viewing. Select the picture size that displays the current program the way that looks best to you.

Selecting the picture size

1. Press TV to select the TV mode.
2. Press PIC SIZE on the remote control.
3. Press the corresponding number button (0-4) to select the desired picture size, as described below and on the next page.

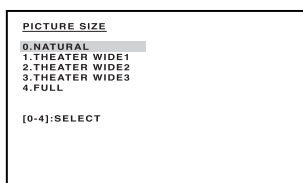

Natural picture size

- The image is displayed close to its originally formatted proportion. Some program formats will display with side bars and/or bars at the top and bottom.

Natural picture size example: The way the image displays will vary depending on the format of the program you are currently watching.

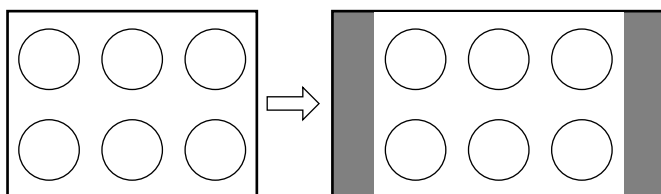

Conventional (4:3) picture on a conventional TV screen

Conventional (4:3) picture in Natural size on your wide-screen TV

TheaterWide 1 picture size (for 4:3 format programs)

- The center of the picture remains close to its original proportion, but the left and right edges are stretched wider to fill the screen.
- The top and bottom edges of the picture may be hidden; however, this mode cannot be scrolled.

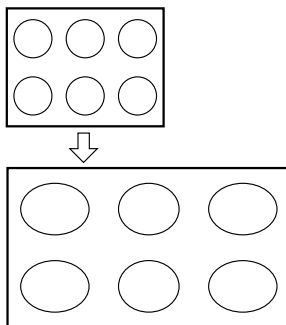

TheaterWide 1 picture size example

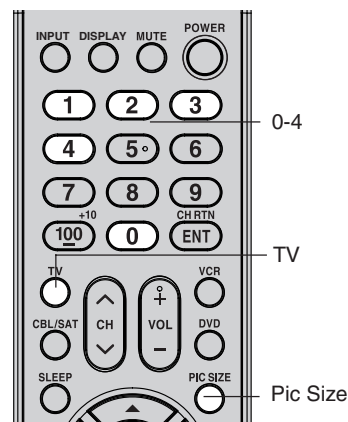

Note:

You also can change the picture size by selecting PICTURE SIZE in the SETUP menu.

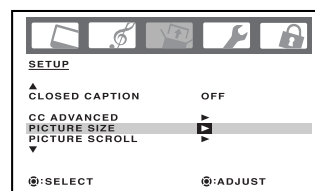

Note:

The PICTURE SIZE feature is not available for some program formats (such as 1080i or 720p.) Such formats will display in Natural picture size.

NOTICE OF POSSIBLE ADVERSE EFFECTS ON PLASMA DISPLAY

Avoid displaying stationary images on your Plasma display for extended periods of time. Fixed (non-moving) patterns or images (including but not limited to PIP/POP windows, closed captions, video game patterns, TV station logos, stock tickers, websites, and special formats that do not use the entire screen) can become permanently ingrained in the Plasma display and cause subtle but permanent ghost images. **This type of damage is NOT COVERED BY YOUR WARRANTY.**

Using these functions to change the picture size (i.e., changing the height/width ratio) for any purpose other than your private viewing may be prohibited under the Copyright Laws of the United States and other countries, and may subject you to civil and criminal liability.

Note:

If the remote control does not operate your TV, press the "TV" button on the remote control and try again.



TheaterWide 2 picture size (for letter box programs)

- The picture is stretched the same amount both wider and taller (retains its original proportion.)
- The top and bottom edges of the picture may be hidden. To view the hidden areas, see “Scrolling the TheaterWide picture” on the next page.

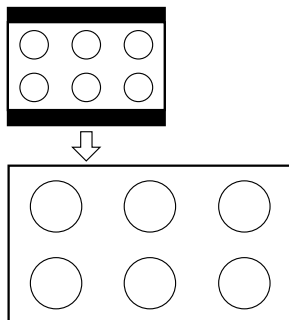

TheaterWide 2 picture size example

Note:

If you select TheaterWide 2 or 3, the top and bottom edges of the picture may be hidden. To see the hidden edges, either scroll the picture (see page 35) or try viewing the program in Full picture size.

TheaterWide 3 picture size (for letter box programs with subtitles)

- The picture is stretched wider to fill the width of the screen, but only slightly stretched taller.
- The top and bottom edges of the picture may be hidden. To view the hidden areas (such as subtitles or captions), see “Scrolling the TheaterWide picture” on the next page.

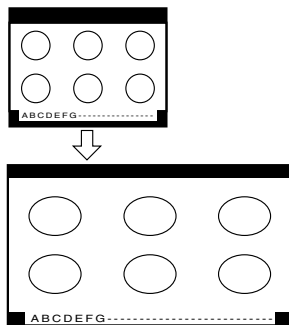

TheaterWide 3 picture size example

Full picture size (for 16:9 source programs)

- If receiving a 16:9 format program, the picture is displayed in its original proportion.
- If receiving a 4:3 format program, the picture is stretched wider to fill the width of the screen, but not stretched taller.
- None of the picture is hidden.

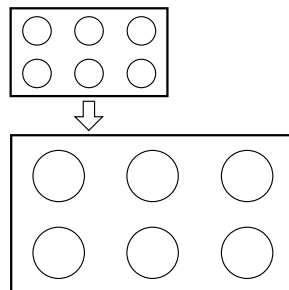

Full picture size example

NOTICE OF POSSIBLE ADVERSE EFFECTS ON PLASMA DISPLAY

Avoid displaying stationary images on your Plasma display for extended periods of time. Fixed (non-moving) patterns or images (including but not limited to PIP/POP windows, closed captions, video game patterns, TV station logos, stock tickers, websites, and special formats that do not use the entire screen) can become permanently ingrained in the Plasma display and cause subtle but permanent ghost images. **This type of damage is NOT COVERED BY YOUR WARRANTY.**

Using these functions to change the picture size (i.e., changing the height/width ratio) for any purpose other than your private viewing may be prohibited under the Copyright Laws of the United States and other countries, and may subject you to civil and criminal liability.

Note:

If the remote control does not operate your TV, press the “TV” button on the remote control and try again.



Scrolling the TheaterWide® picture (TheaterWide 2 and 3 only)

1. Press PIC SIZE to select the TheaterWide 2 or 3 mode.
2. Press MENU, and then press ◀ or ▶ until the SETUP menu appears.
3. Press ▲ or ▼ to highlight PICTURE SCROLL.

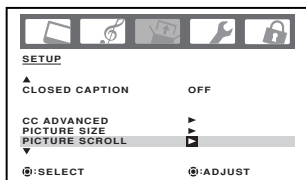

4. Press ◀ or ▶ to display the Scroll Adjustment mode.

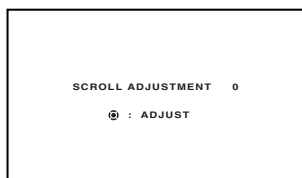

5. Press ▲ or ▼ to adjust the vertical position of the picture.

- Normal (center) position

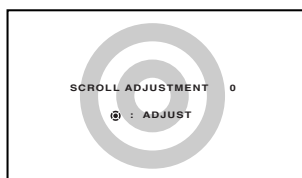

- To raise the picture, press ▲.

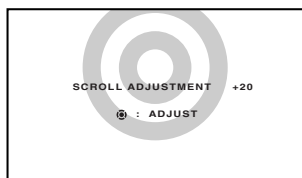

- To lower the picture, press ▼.

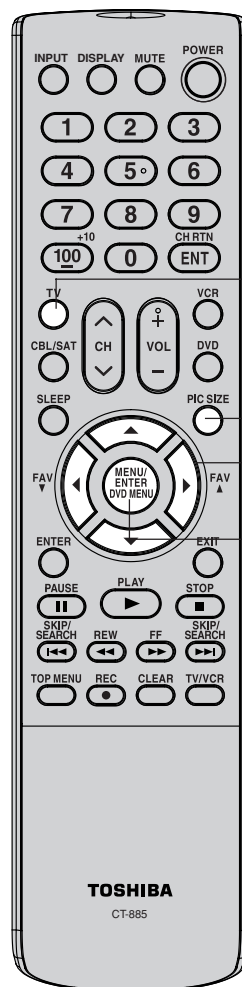
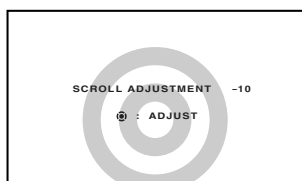

Introduction

Connecting your TV

Setting up your TV

Using the TV's Features

Appendix

Note:

You can scroll the picture in TheaterWide 2 and TheaterWide 3 only. The scroll amounts are as follows:

- 480i/480p signal source:
 - Wide 1 : Not adjustable
 - Wide 2 : -10 to +20
 - Wide 3 : -10 to +10

Note:

If the remote control does not operate your TV, press the "TV" button on the remote control and try again.



Selecting the cinema mode

When you view a DVD movie (3:2 pulldown processed) from a DVD player connected to the ColorStream (component video) inputs on the TV, smoother and more natural motion can be obtained by setting the CINEMA MODE to FILM.

To set the CINEMA MODE to FILM:

1. Press TV to select the TV mode.
2. Press MENU, then press ◀ or ▶ until the SETUP menu appears.
3. Press ▲ or ▼ to highlight CINEMA MODE.

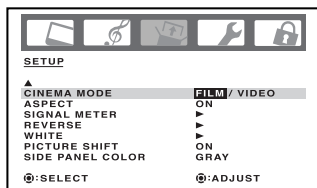

4. Press ◀ or ▶ to highlight FILM.
5. Press EXIT to return to normal viewing.

To set the CINEMA MODE to VIDEO (off):

Highlight VIDEO in step 4, above.

Using the ASPECT feature

When the ASPECT feature is set to ON and the TV receives a 480i signal, the picture size is automatically selected (as described in the following table.)

Aspect ratio of signal source	Automatic aspect size (automatically selected when ASPECT is ON)
4:3 Normal	Natural
16:9 Full	Full
4:3 Letter box	TheaterWide
Not defined	User-set mode

If the signal does not include aspect information, the picture size you selected on page 33 is displayed.

To turn on the ASPECT feature:

1. Press TV to select the TV mode.
2. Press MENU, then press ◀ or ▶ until the SETUP menu appears.
3. Press ▲ or ▼ to highlight ASPECT.

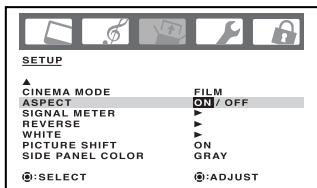

4. Press ◀ or ▶ to highlight ON.
5. Press EXIT to return to normal viewing.

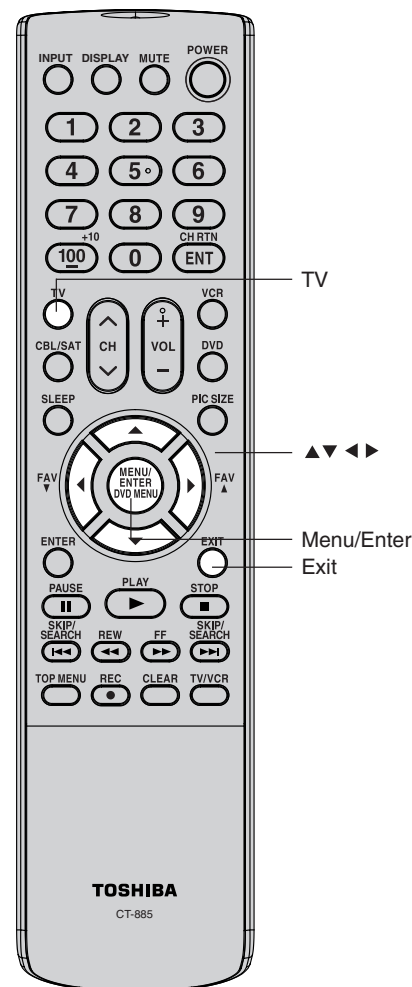

Note:

If the remote control does not operate your TV, press the "TV" button on the remote control and try again.



Using the closed caption feature

The Closed Caption feature has two options:

- Captions—An on-screen display of the dialogue, narration, and sound effects of programs and videos that are closed-captioned (usually identified as “CC”.)
- Text—An on-screen display of information not related to the program, such as weather or stock data (if available in your viewing area.)

To view captions or text:

1. Press TV to select the TV mode.
2. Tune the TV to the desired program.
3. Press MENU, then press ◀ or ▶ to display the SETUP menu.
4. Press ▲ or ▼ to highlight CLOSED CAPTION.

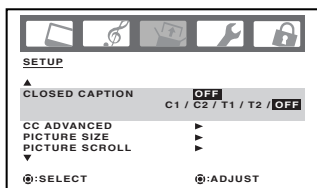

5. Press ◀ or ▶ to select the desired Closed Caption mode, as follows:
 - To view captions, select C1 or C2 (C1 displays translation of the primary language in your area.)
Note: If the program or video you selected is not closed-captioned, no captions will display on-screen.
 - To view text, select T1 or T2.

Important Note:

If text is not available in your viewing area, a black rectangle may appear on-screen. If this happens, set the Closed Caption feature to OFF.

Note:

When a digital signal is received, you can choose from CS1, CS2, CS3, CS4, CS5, CS6, C1, C2, C3, C4, T1, T2, T3, T4, and OFF.

6. Press EXIT to return to normal viewing.

To turn off the Closed Caption feature:

Select OFF in step 5, above.

Using the CC advanced feature

This feature is designed to customize digital captions only.

1. Tune the TV to the desired program.
2. Press MENU, and then press ◀ or ▶ to display SETUP menu.
3. Press ▲ or ▼ to highlight CC ADVANCED, then press ▶.
4. Press ▲ or ▼ to select the desired item to adjust, then press ◀ or ▶.
5. Press ▲ or ▼ to select the desired setting, then press ENTER.

You can select from among the following items and parameters.

- TEXT SIZE:** AUTO, SMALL, STANDARD, LARGE
- TEXT TYPE:** AUTO, DEFAULT, MONO W. SERIF, PROP. W. SERIF, MONO W/O SERIF, PROP. W/O SERIF, CASUAL, CURSIVE, SMALL CAPITALS
- TEXT COLOR:** AUTO, BLACK, WHITE, RED, GREEN, BLUE, YELLOW, MAGENTA, CYAN
- TEXT EDGE:** AUTO, NONE, RAISED, DEPRESSED, UNIFORM, LEFT DROP SHADOW, RIGHT DROP SHADOW
- BACKGROUND COLOR:** AUTO, BLACK, WHITE, RED, GREEN, BLUE, YELLOW, MAGENTA, CYAN

6. Press EXIT to return to normal viewing.

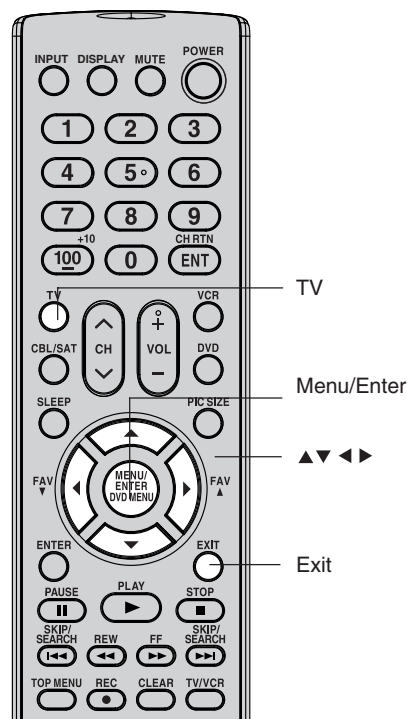

Note:

- A closed caption signal may not be decoded in the following situations:
 - when a video tape has been dubbed
 - when the signal reception is weak
 - when the signal reception is non-standard
- Do not set the Closed Caption “Text Color” and “Background Color” as the same color or you will not be able to see the text.

NOTICE OF POSSIBLE ADVERSE EFFECTS ON PLASMA DISPLAY

Avoid displaying stationary images on your Plasma display for extended periods of time. Fixed (non-moving) patterns or images (including but not limited to PIP/POP windows, closed captions, video game patterns, TV station logos, stock tickers, websites, and special formats that do not use the entire screen) can become permanently ingrained in the Plasma display and cause subtle but permanent ghost images. **This type of damage is NOT COVERED BY YOUR WARRANTY.**

Note:

If the remote control does not operate your TV, press the “TV” button on the remote control and try again.

Introduction

Connecting your TV

Setting up your TV

Using the TV's Features

Appendix



Using the Long Life feature

The long life settings (Reverse, White, Picture Shift, Side Panel color) help to reduce the risk of phosphor burn-in of the plasma screen.

Reverse

The picture is displayed alternately between positive image and negative image to reduce the risk of phosphor burn-in of the screen. This function is effective for a still pattern image.

1. Press TV to select the TV mode.
2. Press MENU, then press ◀ or ▶ to display the SETUP menu.
3. Press ▲ or ▼ to highlight REVERSE, and then press ▶.

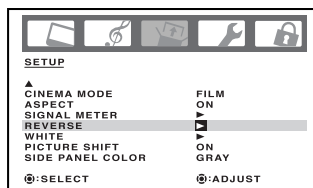

To return to the normal picture:
Press any button.

White

A white pattern is displayed on the whole screen. This function can help in the recovery of minor phosphor burn-in of the plasma screen. This function is also recommended when you want to listen to the TV but not watch it.

1. Press TV to select the TV mode.
2. Press MENU, then press ◀ or ▶ to display the SETUP menu.
3. Press ▲ or ▼ to highlight WHITE, and then press ▶.

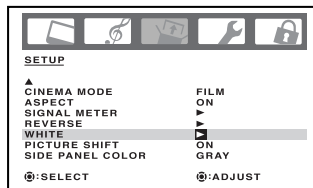

To return to the normal picture:
Press any button.

Picture shift

With Picture shift set to ON, the picture imperceptibly moves around the screen intermittently to reduce the risk of phosphor burn-in of the plasma screen.

Note: To reduce the risk of phosphor burn-in, the default setting for the Picture shift function is ON.

1. Press TV to select the TV mode.
2. Press MENU, then press ◀ or ▶ to display the SETUP menu.
3. Press ▲ or ▼ to highlight PICTURE SHIFT, then press ◀ or ▶ to highlight ON.

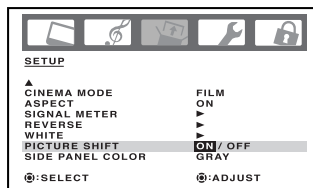

Side panel color

The gray level feature will set the sidebar to two different levels of darkness. Sidebars are the blank spaces on either side of a 4:3 viewing area. Using the GRAY side panel color will help reduce screen burn-in.

1. Press TV to select the TV mode.
2. Press MENU, then press ◀ or ▶ to display the SETUP menu.
3. Press ▲ or ▼ to highlight SIDE PANEL COLOR, then press ◀ or ▶ to highlight GRAY or BLACK.

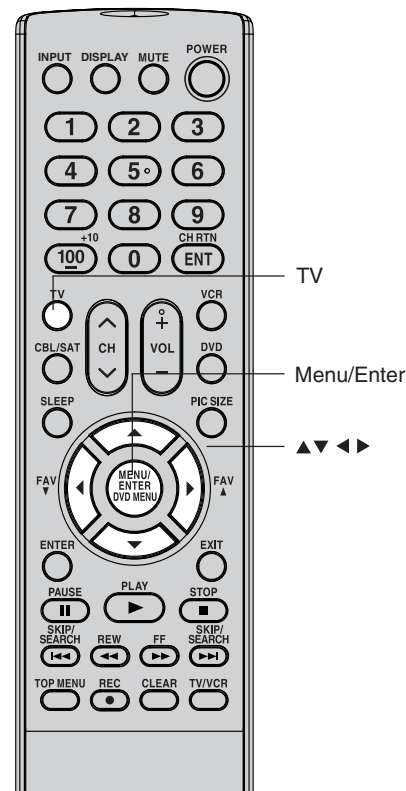
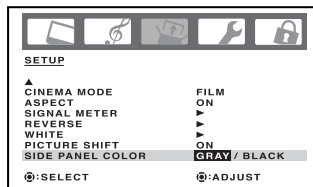

NOTICE OF POSSIBLE ADVERSE EFFECTS ON PLASMA DISPLAY

Avoid displaying stationary images on your Plasma display for extended periods of time. Fixed (non-moving) patterns or images (including but not limited to PIP/POP windows, closed captions, video game patterns, TV station logos, stock tickers, websites, and special formats that do not use the entire screen) can become permanently ingrained in the Plasma display and cause subtle but permanent ghost images. **This type of damage is NOT COVERED BY YOUR WARRANTY.**

Note:

SIDE PANEL COLOR is fixed to GRAY in PC input mode.

Note:

If the remote control does not operate your TV, press the "TV" button on the remote control and try again.



Adjusting the picture

Selecting the picture mode

You can select from four picture modes—Sports, Standard, Movie, and Memory—as described in the following table:

Mode	Picture Quality
SPORTS	Bright and dynamic picture (factory-set)
STANDARD	Standard picture quality (factory-set)
MOVIE	Movie-like picture setting (factory-set)
MEMORY	Your personal preferences (set by you; see “Adjusting the picture quality”)

To select the picture mode:

1. Press TV to select the TV mode.
2. Press MENU, then press ◀ or ▶ to display the PICTURE menu.
3. Press ▲ or ▼ to highlight MODE.

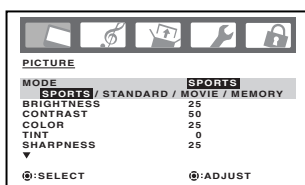

4. Press ◀ or ▶ to highlight the mode you prefer.
5. Press EXIT to return to normal viewing.

Adjusting the picture quality

You can adjust the picture quality to your personal preferences, including the brightness, contrast, color, tint, and sharpness. The qualities you choose will be stored automatically in the PICTURE menu’s MEMORY mode, so you can recall them at any time.

To adjust the picture quality:

1. Press TV to select the TV mode.
2. Press MENU, then press ◀ or ▶ to display the PICTURE menu.
3. Press ▲ or ▼ until the item you want to adjust is highlighted.

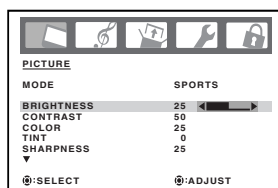

4. Press ◀ or ▶ to adjust the level.

Selection	◀ Pressing	▶
BRIGHTNESS	darker	lighter
CONTRAST	lower	higher
COLOR	paler	deeper
TINT	reddish	greenish
SHARPNESS	softer	sharper

5. Press EXIT to return to normal viewing.

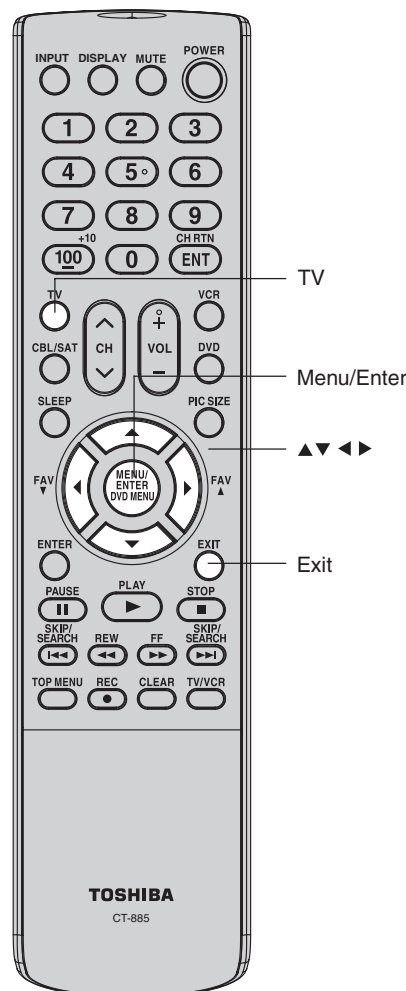

Introduction

Connecting your TV

Setting up your TV

Using the TV's Features

Appendix

Note:

If the remote control does not operate your TV, press the “TV” button on the remote control and try again.



Using the CableClear® feature

CableClear® reduces visible interference in your TV picture. This is useful when receiving a broadcast with a weak signal (especially a Cable channel) or playing a video cassette or disc damaged by repeated use.

To turn on the CableClear® feature:

1. Press TV to select the TV mode.
2. Press MENU, then press ◀ or ▶ to display the PICTURE menu.
3. Press ▲ or ▼ to highlight CableClear.
4. Press ◀ or ▶ to highlight ON.
5. Press EXIT to return to normal viewing.

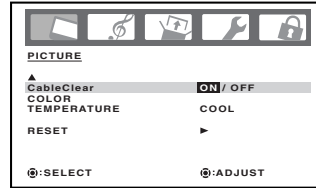

To turn off the CableClear® feature:

Highlight OFF in step 4, above.

Selecting the color temperature

Change the picture quality by selecting from three preset color temperatures—cool, medium, and warm—as described in the following table:

Mode	Picture Quality
COOL	Blueish
MEDIUM	Neutral
WARM	Reddish

To select the color temperature:

1. Press TV to select the TV mode.
2. Press MENU, then press ◀ or ▶ to display the PICTURE menu.
3. Press ▲ or ▼ to highlight COLOR TEMPERATURE.
4. Press ◀ or ▶ to highlight the mode you prefer.
5. Press EXIT to return to normal viewing.

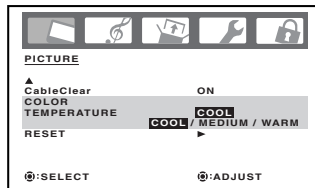

Resetting your picture adjustments

The RESET function returns your picture quality adjustments to the following factory settings:

Mode sports Tint center (0)

Brightness center (25) Sharpness center (25)

Contrast max (50) Color temperature cool

Color center (25)

To reset your picture adjustments:

1. Press TV to select the TV mode.
2. Press MENU, then press ◀ or ▶ to display the PICTURE menu.
3. Press ▲ or ▼ to highlight RESET, and then press ▶.

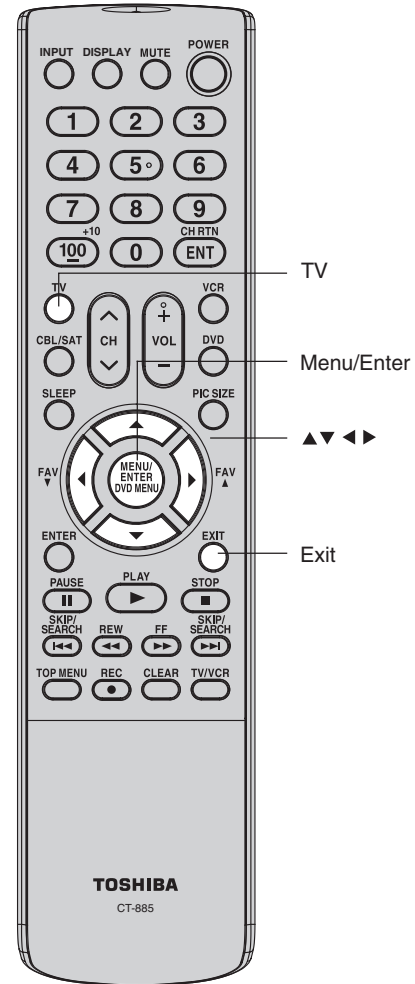
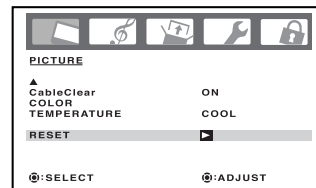

Note:

If the remote control does not operate your TV, press the "TV" button on the remote control and try again.



Adjusting the sound

Muting the sound

Press MUTE to temporarily turn off the sound. While the sound is off, the screen will display the word MUTE in the lower right-hand corner. To restore the sound, either press MUTE again or VOL +/-.

Selecting stereo/SAP broadcasts

The multi-channel TV sound (MTS) feature provides high-fidelity stereo sound. MTS also can transmit a second audio program (SAP) containing a second language or other audio information (when available.)

Note: The MTS feature is not available in VIDEO mode.

When the TV receives a stereo or SAP broadcast, the word "STEREO" or "SAP" displays on-screen every time you turn on the TV, change the channel, or press DISPLAY.

To listen to stereo sound:

1. Press TV to select the TV mode.
2. Press MENU, then press ◀ or ▶ to display the AUDIO menu.
3. Press ▲ or ▼ to highlight MTS.
4. Press ◀ or ▶ to highlight STR (stereo.)

Notes:

- In general, you can leave your TV in stereo mode because the TV automatically outputs the type of sound being broadcast (stereo or mono.)
- If the stereo sound is noisy, select MONO to reduce the noise.

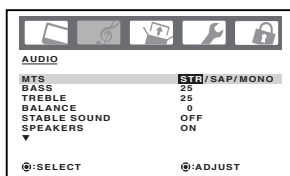

5. Press EXIT to return to normal viewing.

To listen to a second audio program (SAP):

1. Press TV to select the TV mode.
2. Press MENU, then press ◀ or ▶ to display the AUDIO menu.
3. Press ▲ or ▼ to highlight MTS.
4. Press ◀ or ▶ to highlight SAP. The TV speakers will output the second audio program instead of normal audio.
5. Press EXIT to return to normal viewing.

Adjusting the sound quality

You can change the sound quality of your TV by adjusting the bass, treble, and balance.

To adjust the sound quality:

1. Press TV to select the TV mode.
2. Press MENU, then press ◀ or ▶ to display the AUDIO menu.
3. Press ▲ or ▼ to highlight the item you want to adjust.

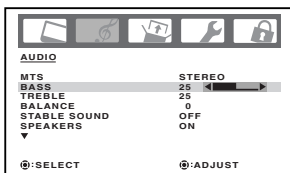

4. Press ◀ or ▶ to adjust the level.
 - ◀ makes the sound quality weaker or increases the balance in the left channel, depending on the item selected.
 - ▶ makes the sound quality stronger or increases the balance in the right channel, depending on the item selected.

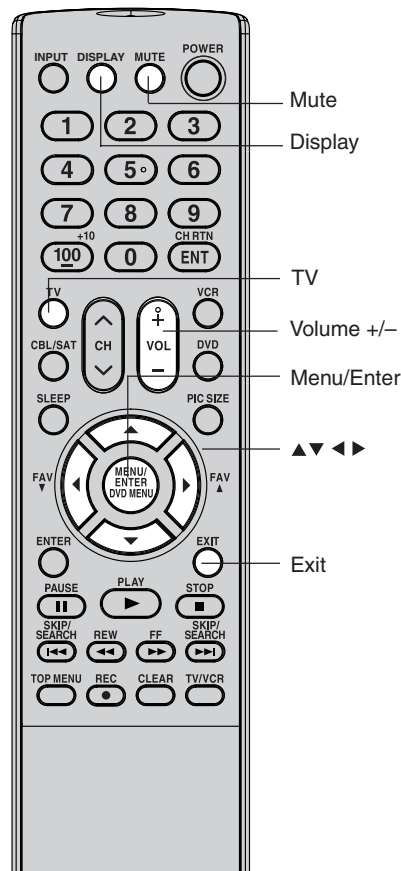

Note:

A second audio program (SAP) can be heard only on those TV stations that offer it. For example, a station might broadcast music as a second audio program. If you have SAP on, you will see the current program on the screen but hear music instead of the program's normal audio. However, if you have SAP on, and the station you are watching is not currently broadcasting a second audio program, the station's normal audio will be output; however, occasionally there is no sound at all in SAP mode. If this happens, set the MTS feature to STEREO mode.

Note:

Adjusting the sound quality (bass, treble, and balance) does not affect the sound that is output from the variable audio OUT jack.

Note:

If the remote control does not operate your TV, press the "TV" button on the remote control and try again.

Introduction

Connecting your TV

Setting up your TV

Using the TV's Features

Appendix



Resetting your audio adjustments

The RESET function returns your audio adjustments to the following factory settings:

Bass center (25) Treble center (25)

Balance center (0)

To reset your audio adjustments:

1. Press TV to select the TV mode.
2. Press MENU, then press ◀ or ▶ to display the AUDIO menu.
3. Press ▲ or ▼ to highlight RESET, and then press ▶.

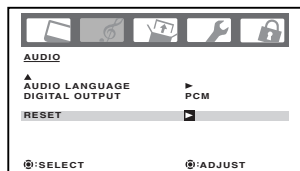

Turning off the built-in speakers

Use this feature to turn off the TV speakers when you connect an audio system (see “Connecting an analog audio system” on page 15.)

To turn off the built-in speakers:

1. Press TV to select the TV mode.
2. Press MENU, then press ◀ or ▶ to display the AUDIO menu.
3. Press ▲ or ▼ to highlight SPEAKERS.

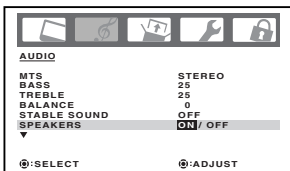

4. Press ◀ or ▶ to highlight OFF.
5. Press EXIT to return to normal viewing.

To turn on the built-in speakers:

Highlight ON in step 4, above.

Using the StableSound® feature

The StableSound feature limits the highest volume level to prevent extreme changes in volume when the signal source is changed.

To turn on the StableSound® feature:

1. Press TV to select the TV mode.
2. Press MENU, then press ◀ or ▶ to display the AUDIO menu.
3. Press ▲ or ▼ to highlight STABLE SOUND.

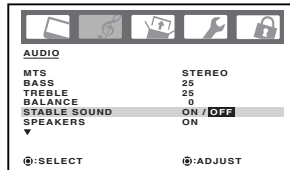

4. Press ◀ or ▶ to highlight ON.
5. Press EXIT to return to normal viewing.

To turn off the StableSound® feature:

Highlight OFF in step 4, above.

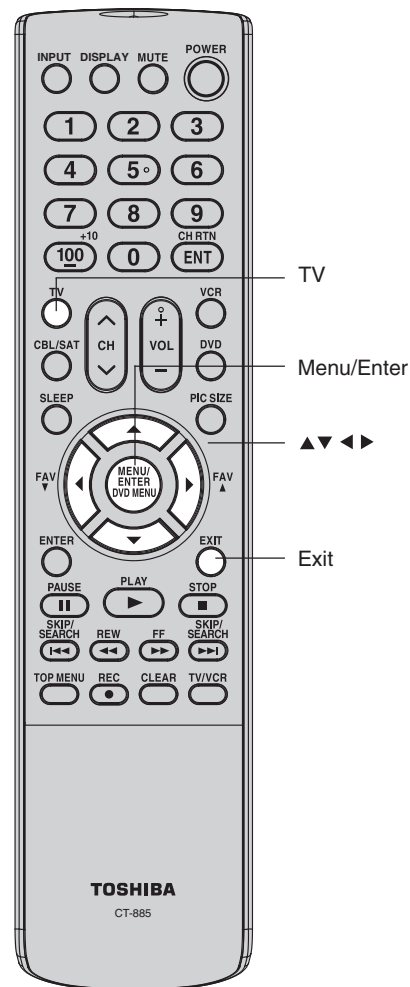

Note:

If the remote control does not operate your TV, press the “TV” button on the remote control and try again.



Using the SRS WOW™ surround sound feature

WOW is a special combination of SRS Labs audio technologies that creates a thrilling surround sound experience with deep, rich bass from stereo sound sources. Your TV's audio will sound fuller, richer, and wider. WOW consists of three features: SRS 3D, FOCUS, and TruBass.

To adjust the WOW feature:

1. Press TV to select the TV mode.
2. Select STEREO mode (see "Selecting stereo/SAP broadcasts" on page 41.)
3. Press MENU, then press ◀ or ▶ to display the AUDIO menu.
4. Press ▼ or ▲ to highlight the desired WOW feature you want to adjust.
 - SRS 3D — To turn on or off the surround sound effect.
 - FOCUS — To turn on or off the vocal emphasis effect.
 - TruBass — To select your desired bass expansion level (HIGH, LOW or OFF.)

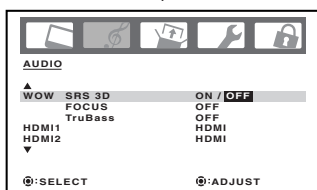

5. Press ◀ or ▶ to adjust the item.
6. Press EXIT to return to normal viewing.

WOW, SRS and ● symbol are trademarks of SRS Labs, Inc.
WOW technology is incorporated under license from SRS Labs, Inc.

Selecting the HDMI audio input source

See "Connecting an HDMI™ or DVI device" on page 14 for connection information.

If you connect a DVI device, to hear audio you must also connect the analog audio cables to the HDMI audio IN jacks (see page 14.) Set the HDMI audio input setting to "DVI" with this connection.

If you connect an HDMI device and play media with digital audio output, to hear digital audio, set the HDMI audio input setting to "HDMI" with this connection.

If you connect an HDMI device but play media with analog audio output (for example, certain CDVs do not output digital audio), to hear audio you must also connect the analog audio cables to the HDMI audio IN jacks (see page 14.) Set the HDMI audio input setting to "DVI" with this connection.

To select the HDMI audio input source:

1. Press TV to select the TV mode.
2. Press MENU, and then press ◀ or ▶ to display the AUDIO menu.
3. Press ▼ or ▲ to highlight HDMI1 (or HDMI2.)

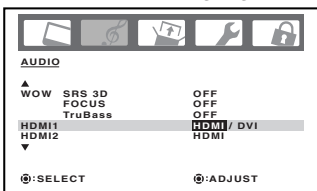

4. Press ◀ or ▶ to select HDMI or DVI.
5. Press EXIT to return to normal viewing.

Note:

If the broadcast is monaural, the SRS 3D effect will not work.

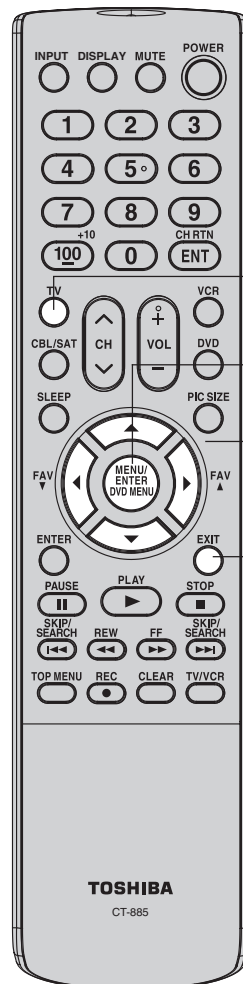

TV

Menu/Enter

▲▼▶▶

Exit

Introduction

Connecting your TV

Setting up your TV

Using the TV's Features

Appendix



Selecting the audio languages

When two or more audio languages are included in a digital signal, you can select one of the audio languages.

To select the audio language:

1. Press TV to select the TV mode.
2. Press MENU, then press ◀ or ▶ to display the AUDIO menu.
3. Press ▲ or ▼ to highlight AUDIO LANGUAGE, then press ▶.
4. Press ▲ or ▼ to select the desired language, then press ENTER.
5. Press EXIT to return to normal viewing.

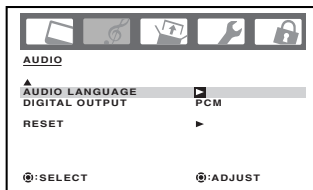

Selecting the digital output format

You can choose the format of the digital audio output signal.

To select the digital output format:

1. Press TV to select the TV mode.
2. Press MENU, then press ◀ or ▶ to display the AUDIO menu.
3. Press ▲ or ▼ to highlight DIGITAL OUTPUT, then press ▶.
4. Press ◀ or ▶ to highlight PCM or DOLBY* DIGITAL.
5. Press EXIT to return to normal viewing.

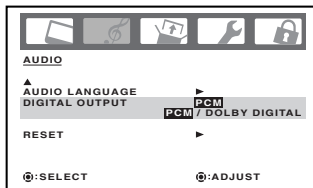

* Manufactured under license from Dolby Laboratories. Dolby and the double-D symbol are trademarks of Dolby Laboratories.

Checking the digital signal strength

You can check the strength of the digital signal by viewing the digital signal meter.

To view the digital signal meter:

1. Press TV to select the TV mode.
2. Press MENU, then press ◀ or ▶ to display the SETUP menu.
3. Press ▲ or ▼ to highlight SIGNAL METER.
4. Press ◀ or ▶ to check the digital-signal strength.
5. Press EXIT to return to the normal screen.

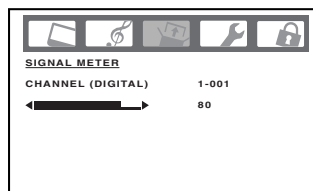

Displaying TV status information on-screen

Press DISPLAY to display the following information on-screen:

Analog channel:

- Clock
- Channel number or VIDEO mode selected
- Channel label (if set)
- Stereo or SAP (second audio program) audio status
- Content rating
- On timer, Sleep timer (if set)
- Picture size, Picture format

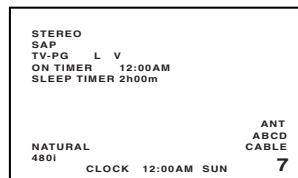

Digital channel:

- Clock
- Channel number, station name, program name
- Remaining time
- Content rating
- Closed Caption mark
- Audio language
- HD or SD mark
- V-Chip mark

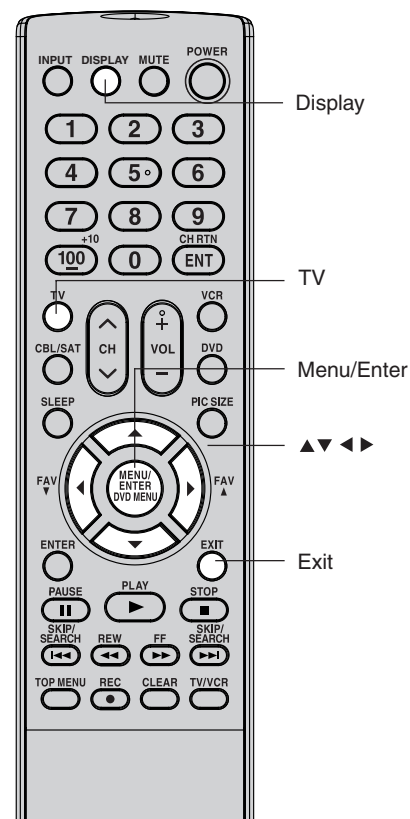
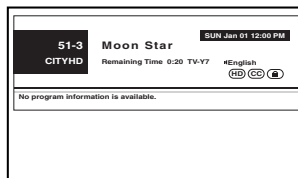

Note:

- The signal meter feature is not available for analog channels.
- After approximately 4 minutes, the SIGNAL METER screen will return to normal TV operation automatically.
- When you select a vacant channel, the signal meter may react.

Note:

- Analog channel status will display on the screen for approx. 4 seconds.
- Digital channel status will display on the screen for approx. 10 seconds. Press RECALL again, the analog channel status will display.

Note:

If the remote control does not operate your TV, press the "TV" button on the remote control and try again.



Picture/Audio adjustments in PC mode

There are a number of picture settings you can adjust to optimize the performance of the TV in PC mode.

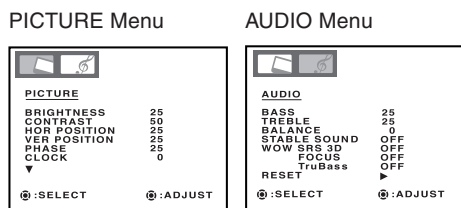

Example: Adjust the contrast.

1. Press TV to select the TV mode.
2. During PC mode, press MENU, then press ◀ or ▶ to display the PICTURE menu.
3. Press ▲ or ▼ to highlight CONTRAST.
4. Press ◀ or ▶ to adjust the contrast level.
5. Press EXIT to return to normal viewing.

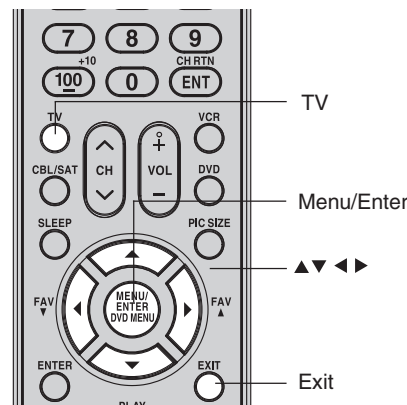

Note:

- If you wish to change the on-screen language, follow the steps 1-4 on page 23.
- If no buttons are pressed for more than approx. 60 seconds, the PC Monitor Menu screen will return to normal Monitor screen automatically.
- The PC Monitor Menu settings are not effective for normal TV mode or external input modes.

PICTURE menu settings:

BRIGHTNESS:	To adjust the brightness of PC Monitor screen.
CONTRAST:	To adjust the contrast of PC Monitor screen.
HOR POSITION:	To adjust the horizontal position of the image on the PC Monitor screen. Each video standard will require a different value for this setting.
VER POSITION:	To adjust the vertical position of the image on the PC Monitor screen. Each video standard will require a different value for this setting.
PHASE:	This must be adjusted after the frequency has been set to optimize picture quality.
CLOCK:	To minimize any vertical bars or stripes visible on the screen background.
RED/GREEN/BLUE:	To adjust the color temperature of the PC Monitor screen.
WVGA INPUT:	Set to ON, when you select the WVGA mode on the PC.
WXGA INPUT:	Set to ON, when you select the WXGA mode on the PC.

AUDIO menu settings:

BASS/TREBLE/BALANCE:	To adjust the sound quality of PC mode.
STABLE SOUND:	To turn on or off the StableSound® feature in PC mode.
WOW SRS 3D:	To turn on or off the surround effect in PC mode.
WOW FOCUS:	To turn on or off the vocal emphasis effect in PC mode.
WOW TruBass:	To select your desired bass expansion level (HIGH, LOW or OFF) in PC mode.

Resetting your picture/audio adjustments in PC mode

The RESET function returns your picture quality adjustments to the following factory settings:

PICTURE menu	AUDIO menu
Brightness center (25)	Bass center (25)
Contrast center (50)	Treble center (25)
Red center (25)	Balance center (0)
Green center (25)	
Blue center (25)	

To reset your picture/audio adjustments:

1. Press TV to select the TV mode.
2. Press MENU during PC mode.
3. Press ◀ or ▶ to select the desired menu.
4. Press ▲ or ▼ to highlight RESET, and then press ▶.

Note:

If the remote control does not operate your TV, press the "TV" button on the remote control and try again.



Auto power off

The TV will automatically turn off after approximately 15 minutes if it is tuned to a vacant channel or a station that completes its broadcast for the day and stops broadcasting on that channel. This feature does not work in video input mode.

Understanding the Power Return feature

If the power is cut off while you are viewing the TV and the power is resupplied, the Power Return feature will turn the TV on automatically.

If the power is going to be off for a long time or you are going to be away from the TV for a long time, unplug the power cord from the wall outlet to prevent the TV from turning on in your absence.

Appendix Troubleshooting

Before calling a service technician, please check the following table for a possible cause of the symptom and some solutions.

Symptom	Solution
Black box on screen	<ul style="list-style-type: none"> Select OFF in the Closed Caption menu to turn off the Closed Caption Text mode.
TV will not turn on	<ul style="list-style-type: none"> Make sure the power cord is plugged in, then press POWER. The remote control batteries may be dead. Replace the batteries.
No picture, no sound	<ul style="list-style-type: none"> Check the antenna/cable connections.
No sound, picture OK	<ul style="list-style-type: none"> The sound may be muted. Press VOLUME. The station may have broadcast difficulties. Try another channel. The MTS feature may be in SAP mode. Select STR or MONO in the MTS menu.
Poor sound, picture OK	<ul style="list-style-type: none"> The station may have broadcast difficulties. Try another channel. The MTS feature may be in SAP mode. Select STR or MONO in the MTS menu.
Poor picture, sound OK	<ul style="list-style-type: none"> Check the antenna connections. The station may have broadcast difficulties. Try another channel. Adjust the PICTURE menu.
Picture and sound are out of sync	<ul style="list-style-type: none"> As with all products that contain a digital display, in rare instances, when viewing certain content (e.g., television broadcasts, video games, DVDs), you may notice that the sound and picture are slightly out of sync. This phenomenon can be caused by various factors including, without limitation, video processing within the TV, video processing in an attached gaming system, and video processing/different compression rates used by broadcasters in their programming. You may want to try one or more of the following suggestions, which may help to reduce the effect of this phenomenon: <ul style="list-style-type: none"> If the TV is connected to an A/V receiver that has a programmable audio delay feature, use this feature to help synchronize the sound to the picture. If you notice this phenomenon only on certain TV channels, please contact your local broadcast, cable, or satellite provider to inform them of this issue.
Poor reception of broadcast channels	<ul style="list-style-type: none"> The station may have broadcast difficulties. Try another channel. Check the antenna connections. If you are using a video input, make sure the INPUT button is set correctly.
Cannot receive above channel 13	<ul style="list-style-type: none"> Make sure the TV/CABLE feature in the SETUP menu is set to "CABLE."



Symptom

Solution

Unable to select a certain channel	<ul style="list-style-type: none"> The channel may be blocked by the V-Chip feature or CH LOCK feature, or erased with the add/erase feature.
Cannot access signal input sources (VIDEO-1, VIDEO-2, VIDEO-3, ColorStream HD-1, ColorStream HD-2, HDMI-1, HDMI-2 and PC) and/or Channels 3 and 4	<ul style="list-style-type: none"> Check the VIDEO LOCK feature.
Multiple images	<ul style="list-style-type: none"> The station may have broadcast difficulties. Try another channel. Use a highly directional outdoor antenna.
Poor color or no color	<ul style="list-style-type: none"> The station may have broadcast difficulties. Try another channel. Adjust the TINT and/or COLOR in the PICTURE menu.
No stereo or SAP sound from a known MTS broadcast	<ul style="list-style-type: none"> Make sure the MTS feature (in the AUDIO menu) is set properly.
The V-Chip password does not work (U.S. V-Chip system only)	<ul style="list-style-type: none"> Change or reset your password.
The remote control does not operate	<ul style="list-style-type: none"> Make sure the TV • CBL/SAT • VCR • DVD mode is set properly on the remote control. Remove all obstructions between the remote control and the TV. The remote control batteries may be dead. Replace the batteries.
The side panel buttons do not operate	<ul style="list-style-type: none"> Check the PANEL LOCK feature.
Digital broadcasting screen problem	<ul style="list-style-type: none"> Check the digital signal strength.
Closed Caption box appears with no text	<ul style="list-style-type: none"> Make sure the Closed Caption "Text Color" and "Background Color" are not set to the same color (see page 37.)

Introduction

Connecting your TV

Setting up your TV

Using the TV's Features

Appendix



Specifications

- This model complies with the specifications below.
- Design and specifications are subject to change without notice.
- This model may not be compatible with features and/or specifications that may be added in the future.

PDP size	49.95 in. diagonal (1,268.7 mm) (approx.)
Pixel	1,366 (H) x 768 (V)
Television system	NTSC standard, ATSC standard (8VSB), QAM
Channel coverage	VHF: 2–13 UHF: 14–69 Cable TV: 4A, A-5–A-1, A-I, J–W, W+1–W+84
Power source	120V AC, 60 Hz
Power consumption	520 W
Operating temperature	0°C ~ 35°C (32°F ~ 95°F)
Operating humidity	Less than 80% RH
Audio power	10 W + 10 W
Speaker type	Main: 2-3/16 x 5 in. (55.9 x 127mm) x 2 pcs. Tweeter: 2 in. (50.8mm) x 2 pcs.
Video/Audio terminals	S-VIDEO INPUT Y-INPUT: 1V (p-p), 75 ohm, negative sync., Mini DIN 4 pin x 3 C-INPUT: 0.286V (p-p) (burst signal), 75 ohm VIDEO/AUDIO INPUT VIDEO: 1V (p-p), 75 ohm, negative sync., pin jack x 3 AUDIO: 300 mV (rms) (60% modulation equivalent, 35k ohm), pin jack (L/R) x 6 ColorStream® (component video) HD INPUT Y: 1V (p-p), 75 ohm PR: 0.7V (p-p), 75 ohm PB: 0.7V (p-p), 75 ohm VIDEO/AUDIO OUTPUT VIDEO: 1V (p-p), 75 ohm, negative sync., pin jack x 1 AUDIO: 300 mV (rms) (60% modulation equivalent, 1k ohm), pin jack (L/R) x 1 COAXIAL DIGITAL AUDIO OUTPUT AUDIO: 0.5V (p-p), 75 ohm OPTICAL DIGITAL AUDIO OUTPUT Optical connector x 1 PC INPUT Mini-Dsub 15 pin x 1 HDMI INPUT: HDMI compliant (type A connector) HDCP compliant E-EDID compliant Suggested scan rates: 1080i, 480p, 480i, 720p HDMI Audio: 2-channel PCM 32/44.1/48 kHz sampling frequency 16/20/24 bits per sample
Dimensions	Width: 49-7/16 in. (1,255 mm) Depth: 15-3/8 in. (391 mm) Height: 34-3/16 in. (869 mm)
Weight	113.5 lbs. (51.5 kg)
Supplied accessories	Remote control (CT-885) with two size “AAA” batteries AC cord



Limited United States Warranty for Plasma Televisions

Toshiba America Consumer Products, L.L.C. ("TACP") makes the following limited warranties to original consumers in the United States. **THESE LIMITED WARRANTIES EXTEND TO THE ORIGINAL CONSUMER PURCHASER OR ANY PERSON RECEIVING THIS PLASMA TELEVISION AS A GIFT FROM THE ORIGINAL CONSUMER PURCHASER AND TO NO OTHER PURCHASER OR TRANSFEREE.**

PLASMA TELEVISIONS PURCHASED IN THE U.S.A. AND USED ANYWHERE OUTSIDE OF THE U.S.A., INCLUDING, WITHOUT LIMITATION, CANADA AND MEXICO, ARE NOT COVERED BY THESE WARRANTIES.

PLASMA TELEVISIONS PURCHASED ANYWHERE OUTSIDE OF THE U.S.A., INCLUDING, WITHOUT LIMITATION, CANADA AND MEXICO, AND USED IN THE U.S.A., ARE NOT COVERED BY THESE WARRANTIES.

Limited One (1) Year Warranty on Parts and Labor

TACP warrants this Plasma Television and its parts against defects in materials or workmanship for a period of one (1) year after the date of original retail purchase. **DURING THIS PERIOD, TACP WILL, AT TACP'S OPTION, REPAIR OR REPLACE A DEFECTIVE PART WITH A NEW OR REFURBISHED PART WITHOUT CHARGE TO YOU FOR PARTS OR LABOR.** During this period, TACP Authorized Service Station personnel will come to your home when warranty service is required. Depending on the type of repair required, the service will either be performed in your home or the Plasma Television will be taken to a TACP Authorized Service Station for repair and returned to your home at no cost to you.

Rental Units

The warranty for Plasma Television rental units begins on the date of the first rental or thirty (30) days after the date of shipment to the rental firm, whichever comes first.

Limited Warranty for Commercial Units

TACP warrants Plasma Televisions that are sold and used for commercial purposes as follows: all parts are warranted against defects in materials or workmanship for a period of ninety (90) days after the date of original retail purchase. **DURING THIS PERIOD, TACP WILL, AT TACP'S OPTION, REPAIR OR REPLACE A DEFECTIVE PART WITH A NEW OR REFURBISHED PART WITHOUT CHARGE TO YOU.**

Owner's Manual and Product Registration Card

Read this owner's manual thoroughly before operating this Plasma Television.

Complete and mail the enclosed product registration card or register your Plasma Television online at www.tacp.toshiba.com/service as soon as possible. By registering your Plasma Television you will enable TACP to bring you new products specifically designed to meet your needs and help us to contact you in the unlikely event a safety notification is required under the U.S. Consumer Product Safety Act. Failure to complete and return the product registration card does not diminish your warranty rights.

Your Responsibility

THE ABOVE WARRANTIES ARE SUBJECT TO THE FOLLOWING CONDITIONS:

- (1) You must retain your original bill of sale or provide other proof of purchase.
- (2) All warranty servicing of this Plasma Television must be performed by an Authorized TACP Service Station.
- (3) The warranties from TACP are effective only if this Plasma Television is purchased and operated in the Continental U.S.A. or Puerto Rico.

- (4) Labor service charges for set installation, setup, adjustment of customer controls, and installation or repair of antenna systems are not covered by this warranty. Reception problems caused by inadequate antenna systems, misaligned satellite dishes, cable television distribution, VCRs, DVD players/recorders, personal computer level IEEE-1394 devices, and any other connected signal source device are your responsibility.
- (5) Warranties extend only to defects in materials or workmanship as limited above, and do not extend to any Plasma Television or parts that have been lost or discarded by you or to damage to the Plasma Television or parts caused by fires, misuse, accident, Acts of God (such as lightning or fluctuations in electric power), improper installation, improper maintenance, or use in violation of instructions furnished by TACP; use or malfunction through simultaneous use of this Plasma Television and connected equipment; or to units that have been modified or had the serial number removed, altered, defaced, or rendered illegible.

How to Obtain Warranty Service

If, after following all of the operating instructions in this manual and reviewing the section entitled "Troubleshooting," you find that service is needed:

- (1) To find the nearest TACP Authorized Service Station, visit TACP's website at www.tacp.toshiba.com/service or contact TACP's Consumer Solution Center toll free at 1-800-631-3811.
- (2) You must present your original bill of sale or other proof of purchase to the TACP Authorized Service Station.

For additional information, visit TACP's web site:
www.tacp.toshiba.com.

ALL WARRANTIES IMPLIED BY THE LAW OF ANY STATE OF THE U.S.A., INCLUDING THE IMPLIED WARRANTIES OF MERCHANTABILITY AND FITNESS FOR A PARTICULAR PURPOSE, ARE EXPRESSLY LIMITED TO THE DURATION OF THE LIMITED WARRANTIES SET FORTH ABOVE. WITH THE EXCEPTION OF ANY WARRANTIES IMPLIED BY THE LAW OF ANY STATE OF THE U.S.A. AS HEREBY LIMITED, THE FOREGOING WARRANTY IS EXCLUSIVE AND IN LIEU OF ALL OTHER WARRANTIES, GUARANTEES, AGREEMENTS, AND SIMILAR OBLIGATIONS OF TACP WITH RESPECT TO THE REPAIR OR REPLACEMENT OF ANY PARTS. IN NO EVENT SHALL TACP BE LIABLE FOR CONSEQUENTIAL OR INCIDENTAL DAMAGES (INCLUDING, BUT NOT LIMITED TO, LOST PROFITS, BUSINESS INTERRUPTION, OR MODIFICATION OR ERASURE OF RECORDED DATA CAUSED BY USE, MISUSE OR INABILITY TO USE THIS PLASMA TELEVISION).

No person, agent, distributor, dealer, or company is authorized to change, modify, or extend the terms of these warranties in any manner whatsoever. The time within which an action must be commenced to enforce any obligation of TACP arising under the warranty or under any statute or law of the United States or any state thereof is hereby limited to ninety (90) days from the date you discover, or should have discovered, the defect. This limitation does not apply to implied warranties arising under the law of any state of the U.S.A.

THIS WARRANTY GIVES YOU SPECIFIC LEGAL RIGHTS AND YOU MAY ALSO HAVE OTHER RIGHTS WHICH MAY VARY FROM STATE TO STATE IN THE U.S.A. SOME STATES OF THE U.S.A. DO NOT ALLOW LIMITATIONS ON THE DURATION OF AN IMPLIED WARRANTY, WHEN AN ACTION MAY BE BROUGHT, OR THE EXCLUSION OR LIMITATION OF INCIDENTAL OR CONSEQUENTIAL DAMAGES. THEREFORE, THE ABOVE PROVISIONS MAY NOT APPLY TO YOU UNDER SUCH CIRCUMSTANCES.

Introduction

Connecting your TV

Setting up your TV

Using the TV's Features

Appendix



Memo

A series of horizontal dotted lines for writing.



Memo

A large area of horizontal dotted lines for taking notes.

Introduction

Connecting your TV

Setting up your TV

Using the TV's Features

Appendix



TOSHIBA AMERICA CONSUMER PRODUCTS, L.L.C.

Head Office

82 Totowa Road, Wayne, NJ 07470

National Service Division

1420B Toshiba Drive, Lebanon, TN 37087

CableClear, ColorStream, TheaterWide and StableSound are registered trademarks of Toshiba America Consumer Products, L.L.C.
GameTimer is a trademark of Toshiba America Consumer Products, L.L.C.

TOSHIBA



PRINTED IN THAILAND