

**Return your Product Registration Card or register online at
www.philips.com/usasupport today to get the very most from your purchase.**

Registering your model with PHILIPS makes you eligible for all of the valuable benefits listed below, so don't miss out. Complete and return your Product Registration Card at once to ensure:

*** Proof of Purchase**

Returning the enclosed card guarantees that your date of purchase will be on file, so no additional paperwork will be required from you to obtain warranty service.

*** Product Safety Notification**

By registering your product you'll receive notification - directly from the manufacturer - in the rare case of a product recall or safety defect.

*** Additional Benefits of Product Ownership**

Registering your product guarantees that you'll receive all of the privileges to which you're entitled, including special money-saving offers.

PHILIPS

Congratulations on your purchase, and welcome to the "family!"

Dear PHILIPS product owner:

Thank you for your confidence in PHILIPS. You've selected one of the best-built, best-backed products available today. We'll do everything in our power to keep you happy with your purchase for many years to come.

As a member of the PHILIPS "family," you're entitled to protection by one of the most comprehensive warranties and outstanding service networks in the industry. What's more, your purchase guarantees you'll receive all the information and special offers for which you qualify, plus easy access to accessories from our convenient home shopping network.

Most importantly, you can count on our uncompromising commitment to your total satisfaction.

All of this is our way of saying welcome - and thanks for investing in a PHILIPS product.

P.S. To get the most from your PHILIPS purchase, be sure to complete and return your Product Registration Card at once, or register online at:

www.philips.com/usasupport

**Know these
safety symbols**

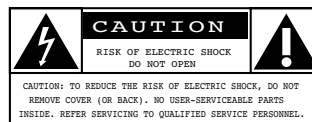

This "bolt of lightning" indicates **t** uninsulated material within your unit may cause an electrical shock. For the safety of everyone in your household, please do not remove product covering.

The "exclamation point" calls attention **S** to features for which you should read the enclosed literature closely to prevent operating and maintenance problems.

WARNING: To reduce the risk of fire or electric shock, this apparatus should not be exposed to rain or moisture and objects filled with liquids, such as vases, should not be placed on this apparatus.

CAUTION: To prevent electric shock, match wide blade of plug to wide slot, fully insert.

ATTENTION : Pour éviter les chocs électriques, introduire la lame la plus large de la fiche dans la borne correspondante de la prise et pousser jusqu'au fond.

For Customer Use

Enter below the Serial No., which is located on the rear of the cabinet. Retain this information for future reference.

Model No. _____
Serial No. _____



PHILIPS

Visit our World Wide Web Site at <http://www.philips.com/usasupport>

IMPORTANT SAFETY INSTRUCTIONS

Read before operating equipment

1. Read these instructions.
2. Keep these instructions.
3. Heed all warnings.
4. Follow all instructions.
5. Do not use this apparatus near water.
6. Clean only with a dry cloth.
7. Do not block any of the ventilation openings. Install in accordance with the manufacturers instructions.
8. Do not install near any heat sources such as radiators, heat registers, stoves, or other apparatus (including amplifiers) that produce heat.
9. Do not defeat the safety purpose of the polarized or grounding-type plug. A polarized plug has two blades with one wider than the other. A grounding type plug has two blades and a third grounding prong. The wide blade or third prong are provided for your safety. When the provided plug does not fit into your outlet, consult an electrician for replacement of the obsolete outlet.
10. Protect the power cord from being walked on or pinched particularly at plugs, convenience receptacles, and the point where they exit from the apparatus.
11. Only use attachments/accessories specified by the manufacturer.
12.  Use only with a cart, stand, tripod, bracket, or table specified by the manufacturer, or sold with the apparatus. When a cart is used, use caution when moving the cart/apparatus combination to avoid injury from tip-over.
13. Unplug this apparatus during lightning storms or when unused for long periods of time.
14. Refer all servicing to qualified service personnel. Servicing is required when the apparatus has been damaged in any way, such as power-supply cord or plug is damaged, liquid has been spilled or objects have fallen into apparatus, the apparatus has been exposed to rain or moisture, does not operate normally, or has been dropped.
15. This product may contain lead or mercury. Disposal of these materials may be regulated due to environmental considerations. For disposal or recycling information, please contact your local authorities or the Electronic Industries Alliance: www.eiae.org.
16. **Damage Requiring Service** - The appliance should be serviced by qualified service personnel when:
 - A. The power supply cord or the plug has been damaged; or
 - B. Objects have fallen, or liquid has been spilled into the appliance; or
 - C. The appliance has been exposed to rain; or
 - D. The appliance does not appear to operate normally or exhibits a marked change in performance; or
 - E. The appliance has been dropped, or the enclosure damaged.
17. **Tilt/Stability** - All televisions must comply with recommended international global safety standards for tilt and stability properties of its cabinets design.
 - Do not compromise these design standards by applying excessive pull force to the front, or top, of the cabinet which could ultimately overturn the product.
 - Also, do not endanger yourself, or children, by placing electronic equipment/toys on the top of the cabinet. Such items could unsuspectingly fall from the top of the set and cause product damage and/or personal injury.
18. **Wall or Ceiling Mounting** - The appliance should be mounted to a wall or ceiling only as recommended by the manufacturer.
19. **Power Lines** - An outdoor antenna should be located away from power lines.
20. **Outdoor Antenna Grounding** - If an outside antenna is connected to the receiver, be sure the antenna system is grounded so as to provide some protection against voltage surges and built up static charges. Section 810 of the National Electric Code, ANSI/NFPA No. 70-1984, provides information with respect to proper grounding of the mats and supporting structure grounding of the lead-in wire to an antenna-discharge unit, size of grounding connectors, location of antenna-discharge unit, connection to grounding electrodes and requirements for the grounding electrode. See Figure below.
21. **Objects and Liquid Entry** - Care should be taken so that objects do not fall and liquids are not spilled into the enclosure through openings.
 - a) **Warning:** To reduce the risk of fire or electric shock, this apparatus should not be exposed to rain or moisture and objects filled with liquids, such as vases should not be placed on this apparatus.
22. **Battery Usage CAUTION** - To prevent battery leakage that may result in bodily injury, property damage, or damage to the unit:
 - Install all batteries correctly, with + and - alignment as marked on the unit.
 - Do not mix batteries (old and new or carbon and alkaline, etc.)
 - Remove batteries when the unit is not used for a long time.

EXAMPLE OF ANTENNA GROUNDING AS PER NATIONAL ELECTRICAL CODE (NEC)

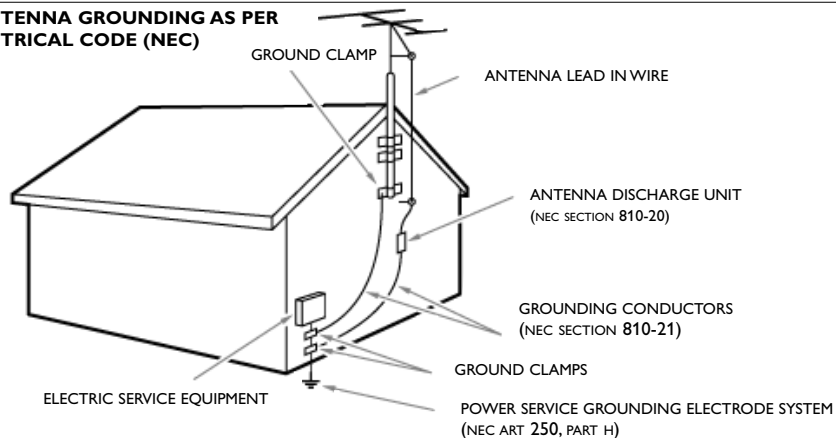

Note to the CATV system installer: this reminder is provided to call the CATV system installer's attention to Article 820-40 of the NEC that provides guidelines for proper grounding and, in particular, specifies that the cable ground shall be connected to the grounding system of the building, as close to the point of cable entry as practical.

About this User Manual

This manual contains all information you will need to initially install and operate your new TV. Also read the help texts which are being displayed at the bottom of the screen.

Help?

If this instruction manual does not give an answer or if 'Before Calling Service' does not solve your TV problem, you can call your Local Philips Customer or Service Centre. See the supplied World-wide guarantee booklet. Please, have the Model and Serial number which you can find at the back of your television set or on the packaging, ready, before calling the Philips helpline 1-888-PHILIPS (744-5477)

Model: 37-42-50PF9431D/37 - 47PF9631D - 63PF9631D

Serial No:

English
User Manual

Contents

Safety warnings	2	Connect:	
Getting started	3	a VCR or DVD recorder	38
Use of the remote control RC4345	6	a recorder and other A/V devices	39
My content	10	a recorder and Cable box with RF output	40
Buttons on the right side of the TV	10	a satellite receiver or Cable box with A/V outputs	41
Turn the TV on	11	a recorder and satellite receiver or Cable box with A/V outputs	42
First time installation	11	a DVD player, or other accessory digital source devices	43
How to navigate through the menus	12	a device to the HDMI connector	44
How to search for and store TV channels	13	a Digital Surround receiver	45
Use of the Setup menu	17	Record with your recorder	45
Use of the TV menu settings	23	Select connected equipment	45
Adjust picture menu settings	24	Audio and video equipment buttons	46
Adjust sound menu settings	26	Before calling service	47
Adjust feature menu settings	27	Glossary	48
Control TV channels' special functions	28	Annex 1 - Philips TV software upgrade with portable memory	49
Multimedia Browser	32	Annex 2 - Philips TV-Slideshow Format with background music	51
To make video and audio connections	35	Annex 3 - Philips TV - Digital camera and USB issues	53
Side panel overview	36	Annex 4 - Issues referring to connected peripherals with a HDMI connector	54
Rear panel overview	37	Index	55
		Recycling	56
		Product information	57

Français
Mode d'emploi

Español
Manual de instrucciones



310431525711



Safety warnings

General

Do not insert the power plug in a wall socket or hang the TV to the wall before all connections are made.

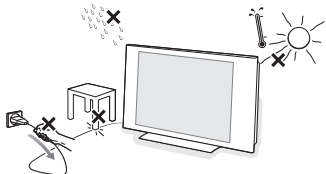

- Place or hang the TV wherever you want, but make sure that air can circulate freely through the ventilation slots. Leave at least 4" to 6" free all around the TV.
- Do not place the TV on a carpet.
- Do not install the TV in a confined space such as a book case or a similar unit.
- To prevent any unsafe situations, no naked flame sources, such as lighted candles, should be placed in the vicinity.
- Avoid heat, direct sunlight and exposure to rain or water.
- The equipment shall not be exposed to dripping or splashing.
- To prevent damaging the power (AC) cord which could cause a fire or electric shock, do not place the TV on the cord.

Care of the screen

Do not touch, push or rub or strike the screen with anything hard as this may scratch, mar or damage the screen permanently.

Warning concerning stationary images on the TV screen

A characteristic of Plasma Display Panels is that displaying the same image for a long time can cause a permanent after-image to remain on the screen. This is called phosphor burn in. Normal use of the TV should involve the showing of pictures that contain constantly moving and changing images that fill the screen.

Examples of stationary images (this is not an all-inclusive list, you may encounter others in your viewing):

- **TV menus;**
- **Black bars:** when black bars appear at the left and right side of the screen, it is recommended to change to a picture format so that the picture fills the entire screen;
- **TV channel logo:** present a problem if they are bright and stationary. Moving or low-contrast graphics are less likely to cause uneven aging of the screen;
- **Stock market stickers:** presented at the bottom of the TV screen;
- **Shopping channel logos and pricing displays:** bright and shown constantly or repeatedly in the same location on the TV screen.

Examples of still pictures also include logos, computer images, time display, teletext and images displayed in 4:3 mode, static images or characters, etc.

Notes:

- reduce contrast and brightness when viewing
- **once burn-in occurs it will never disappear completely.**

And please do not rub with dust clothes with chemical treatment. Do not touch the surface with bare hands or greasy cloth (some cosmetics are detrimental to the screen). Unplug the TV before cleaning the screen. When the surface becomes dusty, please wipe gently with absorbent cotton or other soft materials like chamois soaks. Do not use acetone, toluene and alcohol because they cause chemical damage. Do not use liquid cleaners or aerosol cleaners. Wipe off saliva or water drops as soon as possible. Their long time contact with the screen causes deformations and color fading.

Caution

Installing the TV requires special skills that should only be performed by qualified personnel. You should not attempt to do the work yourself. Philips bears no responsibility for improper mounting or mounting that results in accident or injury. Make sure that the wall mount is being fixed securely enough so that it meets safety standards.

Mounting the TV on the wall

This TV provides the VESA mounting interface (not supplied) and is VESA compatible with the 4 supplied VESA studs to be inserted in the back of the TV.

Getting started

Before you start

Warning: do not insert the power plug into the mains at the bottom of the TV and in a wall socket before all connections are made.

Before installing your TV or before hanging it on the wall, first connect your accessory devices. See To make video and audio connections, p. 35.

Overview of the rear connector panel

There is a wide range of audio and video devices that can be connected to your TV. See To make audio and video connections, p. 35.

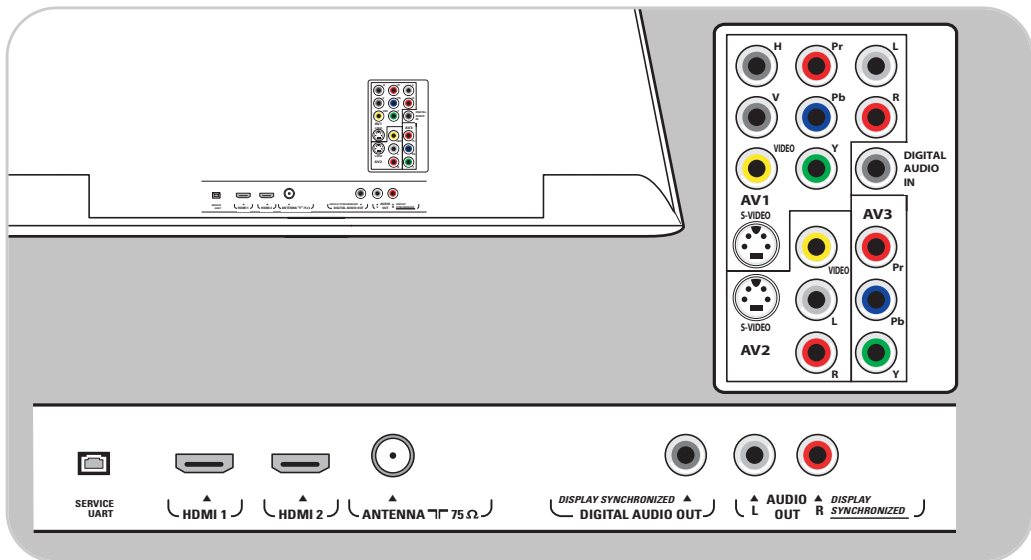

AV1 can handle YPbPr, VIDEO, S-VIDEO, RGB-HV and L/R Audio,

AV2 can handle VIDEO, S-VIDEO and L/R Audio,

AV3 can handle YPbPr,

HDMI 1 and **2** can handle Digital video and audio,

Side can handle VIDEO or S-VIDEO, L/R Audio and USB,

Service UART : For use only by authorized service personnel.

Note for installers/integrators : Do not connect RS232 without level shifter.

Supported video formats: 480i, 480p, 720p, 1080i.

Warning: disconnect all power sources before making any connections.

Getting started (Continued)

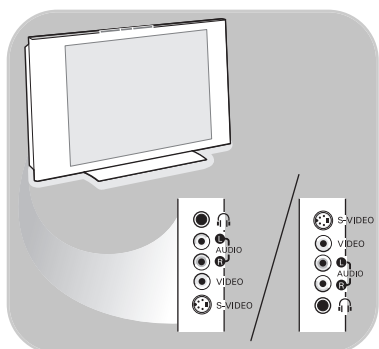

Overview of the side connector panel

- To connect a camera, camcorder or game, see To make video and audio connections, p. 36.
- To connect a headphone, see To make video and audio connections, p. 36.
- To connect a USB device, see Multimedia browser, p. 32.

Connect to the TV

Your Philips Digital TV will allow you to enjoy digital programs directly from your cable or off air.

Connect directly to the TV or connect via your current cable box or Satellite Receiver box.

- **Directly to the TV** (you will not be able to receive pay channels)

1. Connect the cable TV signal or the incoming antenna signal to the **CABLE/ANTENNA 75 Ω** jack at the bottom of the TV.
2. See page 14 for details on using Autoprogram to store channels in the TV's memory.

Notes:

- Broadcasters are in the middle of a transition from analog to digital TV. This means that a given broadcaster will have two channels on the air, one analog and one digital.
- This connection will supply stereo sound to the TV if it is being broadcast by the station you are watching.

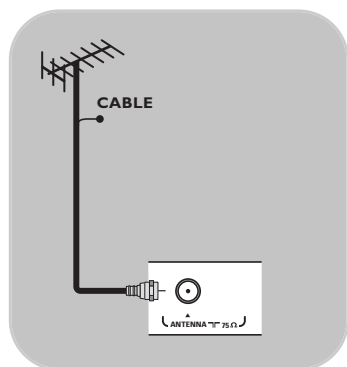

- **Via a cable box or Satellite box**

1. Maintain the connection of the TV cable of your home into your cable box (or satellite receiver box).
2. Connect your Cable box (or satellite receiver box) to the back of the TV using the best connection options. See to make audio and video connections, p. 35.
3. Select the source using the **AV+** button on the remote control.
4. Press the **OK** button to confirm your selection.

For more information, please refer to your cable box (or satellite receiver box) manual.

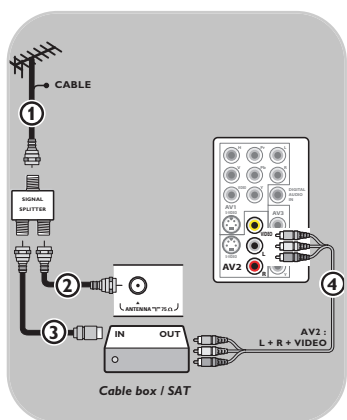

Getting started (Continued)

Note: Watching Cable TV programs that don't require the cable box

Since you've connected the cable TV signal directly to the TV's tuner, you can also watch the unscrambled programs by simply tuning to the desired channel. You must first use Autoprogram, however, to store channels in the TV's memory. See page 14. This connection will supply stereo sound to the TV if it is being broadcast by the station you are watching.

Connect the mains

- Insert the power cord supplied into the mains at the bottom of the TV and in the wall socket.

Warning: verify that the power supply voltage corresponds to the voltage printed on the sticker at the back of the TV. Contact your local dealer if your power supply is different.

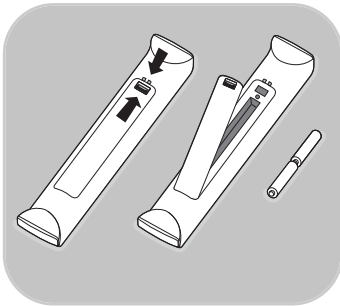

Remote control

- Insert the 2 batteries supplied (Type R6-1,5V). Be sure the (+) and (-) ends of the batteries line up correctly (inside of case is marked.)

For most buttons pressing a button once will activate the function. Pressing a second time will de-activate it.

Use of the remote control RC4345

Note: For most buttons pressing a button once will activate the function. Pressing a second time will de-activate it. When a button enables multiple options, a small list will be shown. Press repeatedly to select the next item in the list. The list will be removed automatically after 6 seconds or press **OK** to remove immediately.

Attention: this remote control can not be programmed to work accessory devices.



POWER

Press to turn on/off the TV from or to standby mode.

Attention: the TV is never powered off completely unless it is physically unplugged.

DVD/R CBL TV VCR AUX

Press the **SELECT** button repeatedly to select one of the system modes in which the remote control can be used. If no action is being undertaken within 60 seconds, the remote control returns to TV mode.

After an action in the selected system mode the remote control will remain in this mode for 60 seconds and will then return to TV mode.



- Audio and Video equipment buttons. See p. 46.
- Multimedia browser functional buttons. See p. 33.

DEMO Demo on/off See p. 13.

CLOCK on/off

Time display (for max. 10 minutes)

Color buttons

When functions are attached to the color buttons, the color buttons are shown on screen.

MY CONTENT

Press to display the My Content menu on or off, see p. 10.

○ no function

Cursor buttons

Press the cursor buttons up/down, left/right to navigate through the menus.

Note: If necessary, you can adjust the picture position to the center of the screen with the cursor buttons.

- OK** - to activate a setting
- to display the list of channels stored (according to the selection made in the Installation mode - Antenna or Cable, p. 14.)
 - starts playing content in the Multimedia Browser application, p. 32.

Use of the remote control RC4345 (Continued)



MENU Settings menu on/off. See p. 12.

PIP HDMI Dual screen/PIP. See p. 17

To watch a broadcast and a HDMI source simultaneously.

VOL Volume

Press + or - to adjust the volume.

MUTE Interrupt the sound or restore it.

CH/PAGE Channel selection

- To browse through the TV channels or sources stored and marked in the Preferred channels list (see p. 31);
- To select between Antenna or Cable TV channels, first make your selection in the Settings menu, see p. 14.

Note: You don't have to start the installation again once you have searched for and stored the available TV channels.

Numeric buttons

To select a TV channel.

AV+ Press repeatedly to select **AV1, AV2, AV3, HDMI 1, HDMI 2, Side** or **TV** when in TV mode, according to where you connected the accessory devices (p. 45).

- Type the dash (-) for digital channels.

A/CH

Press to alternate between the currently viewed channel and the previously viewed channel.

INFO

Display information: Press to display (when available) information about the selected TV channel and program or accessory device.

● **RECORD** no function

FAVORITES

- **VIEW** To display a list of all channels marked as favorite (incl. subchannels).
- **3** To add or remove a channel in the favorite list of TV channels.

Use of the remote control RC4345 (Continued)



FORMAT

Press this button to summon a list of available display formats (depending on the receiving signal). This lets you choose the display format of your preference. Press this button repeatedly to select another picture format: Automatic, Super zoom, 4:3, Movie expand 14:9, 16:9 subtitle or Wide screen.

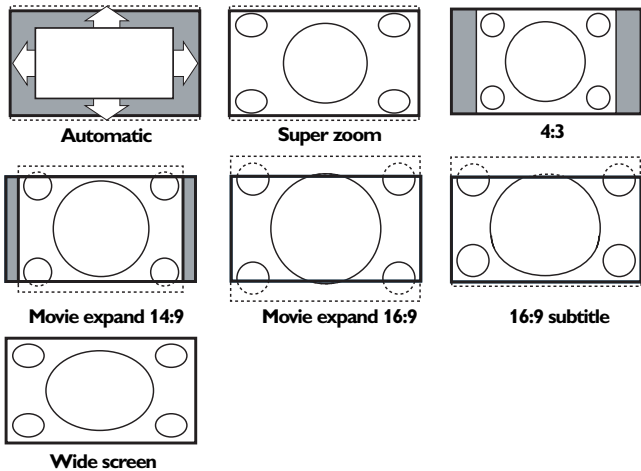

Automatic makes the picture fill the screen as much as possible.

Super zoom removes the black bars on the sides of 4:3 programs with minimal distortion.

When in Movie expand 14:9, Movie expand 16:9 or Super zoom picture format, you can make subtitles visible with the cursor up/down.

Note: With HD sources not all screen formats will be available.

Use of the remote control RC4345 (Continued)

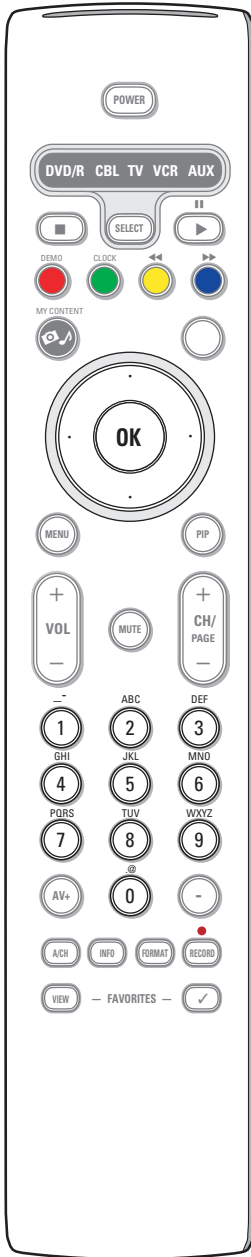

Alphanumeric buttons on the remote control

The alphanumeric buttons on the remote control can be used to enter digits and text.

Multi-tap entry can be used to enter alphanumeric information when necessary.

The characters displayed are dependent on the language selected in the Installation menu. See p. 13.

Text is entered similar to the method used for entering text messages on a cellular phone.

When a letter or number has been entered, the cursor automatically advances to the next character position after the specified time out or by pressing the cursor right.

RC button	Default Multi-tap Alphanumeric entry order
1	<space> _ - 1 <space> _ - 1 (etc.)
2	a b c A B C 2 a b c (etc.)
3	d e f D E F 3 d e f (etc.)
4	g h i G H I 4 g h i (etc.)
5	j k l J K L 5 j k l (etc.)
6	m n o M N O 6 m n o (etc.)
7	p q r s P Q R S 7 p q r s (etc.)
8	t u v T U V 8 t u v (etc.)
9	w x y z W X Y Z 9 w x y z (etc.)
0	. @ 0 . @ 0 (etc.)

Also the cursor up/down can be used to enter alphanumeric information.

When finished, press the **OK** button to confirm the entry. Move to the left panel.

Button	Default RC_CURSOR_UP/RC_CURSOR_DOWN Alphanumeric Entry Order
RC_CURSOR_UP	a b c d ... A B C D ... 1 2 3 ... 0 <space> _ - . @
RC_CURSOR_DOWN	@ . - _ <space> 0 9 8 7 ... Z Y X ... z y x ... c b a

My Content

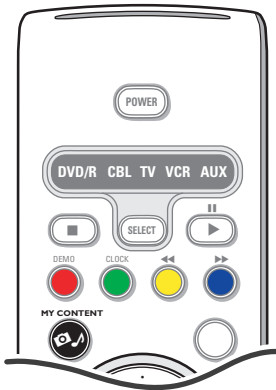

The My Content menu (and the underlying Multimedia content browser) is intended to contain all content, services, applications you are interested to consume.

1. Press the button to activate.
2. Press the cursor up/down to move the highlight up and down in the list of menu items.
3. Press the cursor right to go deeper into the structure.

• Television:

- **TV menu** allows you to access the Settings menu. See How to navigate through the menus, p. 12.
- **TV channels** leading to the list of TV channels; the left panel will contain the analog channel numbers, the one-part channel numbers and the major channel numbers in case of two-part digital channels. The right panel will contain the available subchannels associated with the major channel that is currently highlighted on the left panel. If there are no subchannels associated with the currently selected channel in the left panel, the right panel will remain empty.

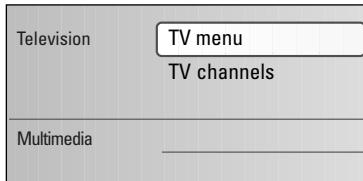

• Multimedia:

- Allows you to access the Multimedia browser application. It lets you display your personal multimedia files. Multimedia is only present when a USB device is connected. See Multimedia browser, p. 32.

Buttons on the right of the TV

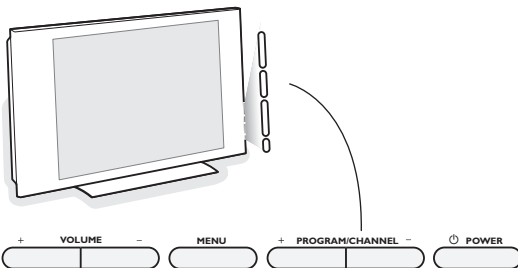

Should your remote be lost or broken you can still change some of the basic settings with the buttons on the right side of your TV.

Press the power switch to switch the TV on.



The **MENU** button can be used to summon the Settings menu without the remote control.

Use:

- the **VOLUME +** and - buttons and the **PROGRAM/CHANNEL +** and - buttons to select menu items;
- the **MENU** button to confirm your selection.

Note: When activated via the **MENU** button on the right side of the TV, only **Exit** lets you dismiss the menu. Navigate to **Exit** and press the **MENU** button.

Turn the TV on

- Press the power switch  at the right side of the TV.
 - An indicator on the front of the TV lights up.
- Press the **+CH/PAGE-** button or the **POWER**  button on the remote control.

Note: the first time (and only the first time) you turn on your TV, you see a Welcome screen followed by the installation procedure. See First time installation below.

First time installation

1. After an introduction screen, you are asked to select a language of the TV's on-screen-menus. (The text of the header and the info on screen continuously change language.)
2. Press the cursor up/down to highlight your language.
3. Press the **OK** button.
4. Follow the on-screen instructions to proceed.

Notes:

- Once you completed the initial installation procedure you can access the screens from the Settings menu. See p. 23.
- If the TV has already been installed before and/or you want to change the First time installation settings, proceed with How to navigate through the menus, p. 12.

How to navigate through the menus

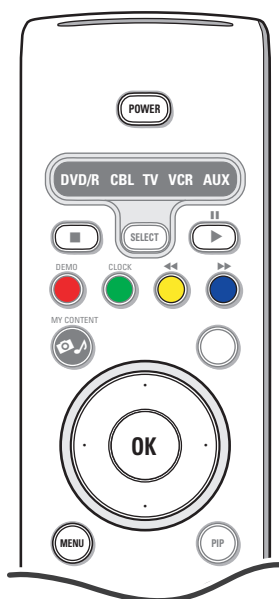

Introduction

A lot of guiding instructions, help texts and messages will be displayed on your TV when using the menus or when trying to execute an action.

Please, follow the instructions and read the help texts which are being displayed on the specific item highlighted.

The color buttons refer to different actions which may be executed depending on the activated device. Press the corresponding color button on the remote control to perform the required action.

1. Press the **MENU** button on the remote control
 - ▷ The Settings menu appears on the screen. This menu allows you to access and change settings and preferences.
 - **TV** allows you to adjust your preferred picture and sound .
 - **Setup** allows you to control the settings of special TV functions, features and accessory devices.
 - **Installation** allows you
 - to select your menu language
 - to search for and store your TV channels
 - to do a weak ATSC digital channel installation
 - to upgrade your TV software
 - **Demo** allows you to get an idea of the features that are part of the television.
2. Use the cursor up/down to highlight and select a menu item on the left panel.
 - ▷ The right panel shows the content of the highlighted menu item in the left panel.

Note: Sometimes not all the menu items are visible on the screen. Use the cursor down to reveal all items.

3. Use the cursor right to enter the right panel.
 - ▷ The content of the right panel is moved to the left panel and the right panel shows the content of the newly highlighted item in the left panel.

Note: In some cases it is important that the picture can be watched while adjusting the settings. This means that when the highlight is on the right side panel, the other menu items hide away. When the cursor left is pressed again, the hidden menu items re-appear and the highlight moves to the left panel.

Settings	TV
TV	Picture
Setup	Sound
Installation	Features
Demo	Channels
Exit	
Info	

Settings	TV	Picture
	Picture	Auto picture
	Sound	Contrast
	Features	Brightness
	Channels	Color
		Sharpness
		Color temperature
	
Info		

General:

- Press the **OK** button on the highlighted item to activate and to dismiss the menu.
- Press the cursor left to go one menu level up again.
- Press the **MENU** button to exit the Settings menu.

Note: The menu is also dismissed by pressing one of the color buttons (if present) referring to certain actions which may be executed.

How to navigate through the menus (continued)

Settings	Demo
TV	Pixel Plus
Setup	Active Control
Installation	
Demo	
Exit	
Info	

Demo

The Demo menu allows the user to get an idea of the features that are part of the television.

1. Select **Demo** in the Settings menu and press the cursor right.
2. Highlight a desired demo with the cursor up/down.
3. Press **OK** to start playing the highlighted demo.
4. Press the green color button to automatically run all demos in sequence.
Press the red color button to stop the auto run function.
Press the red color button again to exit the demo and to return to TV mode.

Notes:

- The selected demo is played once.
- The demos require no user interaction except for starting the demo.

How to search for and store TV channels

Tip: You will need this chapter only if you want to change the installation settings.

Settings	Installation
TV	Language
Setup	Autoprogram
Installation	Weak channel inst.
Demo	Software upgrade
Exit	
Info	

Installation menu

This menu will adjust settings related to the installation of the TV channels.

1. Press the **MENU** button on the remote control.
 - The **Settings** menu appears.
2. Select **Installation** and press the cursor right.

Select your language

1. Select **Language** and press the cursor right.
 - A list of available languages appears.
2. Select your language and press the **OK** button to confirm your selection.
3. Proceed with the Installation menu.

How to search for and store TV channels (continued)

Settings	
Installation	Autoprogram
Language	
Autoprogram	Start now
Weak channel ins.	
Software upgrade	
Info	

Television installation	
Installation mode	
Antenna	Please select your installation mode.
Cable	
<input checked="" type="radio"/> Previous <input checked="" type="radio"/> Next <input type="radio"/> <input type="radio"/>	

Store TV channels

After language is set correctly, you can now search for and store the TV channels.

1. Select **Autoprogram** in the Installation menu.
2. Press the cursor right.
3. Press the **OK** button.
4. Select **Cable** or **Antenna** in the Installation mode.
 - ▷ When **Antenna** is selected, the TV will detect antenna signals and will search for antenna TV (NTSC and ATSC) channels available in your local area.
 - ▷ When **Cable** is selected, the TV will detect cable company supplied signals and will search for cable TV (NTSC, ATSC, QAM modulated) channels available in your area.

Note: Make sure that registration with your cable TV provider and connection of equipment are completed.

5. Press the green corresponding color button on the remote control for **“Next”**.

Note: All channels must be unlocked in order to autoprogram. If requested, enter your PIN code to unlock all channels. See Adjust Menu preferences in the Settings, TV menu, p. 21.

6. Press the green corresponding color button on the remote control for **“Start”** to start autoprogramming.
 - ▷ The menu screen disappears and the progress of autoprogramming is displayed. The progress bar indicates the number of analog and digital TV channels found.
 - ▷ When Autoprogramming is complete, a message appears confirming the completion and the TV switches to the first installed TV channel.

Notes:

- When you have locked TV channels while initiating autoprogram, a message appears asking to enter your PIN code in order to complete autoprogramming.
- When interrupted, the updated channel information is retained as well as the not yet updated old channel information.
- Background autoprogramming occurs only when the TV is turned on.
- Channel information of an ATSC channel is updated only for the ATSC channel currently tuned.
- Once you have searched for as well the available Antenna as well as the Cable TV channels, they are stored in the memory.

Channel tuning

Important: After the installation of the TV channels has been done, always make a selection in the Installation menu between Antenna or Cable whether you want to watch Antenna TV channels or Cable TV channels.

Note: Do not start Autoprogram but press the red color button. Then press the **MENU** button.
If you make use of a signal splitter do not forget to put the switch in the corresponding position.

Available channels:

- Cable (analog NTSC or digital QAM): max. from 1 to 135
- Terrestrial (analog NTSC or digital ATSC): max. from 2 to 69

If a tuned channel is not yet in the master channel map, the TV will attempt to tune the channel and it will be added to the map.

If the channel is not acquired, a message will appear that the channel is not available.

When you tune an audio-only digital subchannel, a display appears with the message **Audio only**.

Notes:

- Subchannel selections

The new standards employed with digital broadcasting make it possible to receive multiple program channels under a single major channel number which can be selected by pressing the digit remote control direct-access channel number entry.

- Digital Channel selection delay

Due to the tuning complexity of subchannel digital programming, the time to select and view a digital channel may take slightly longer than what the viewer is normally accustomed to (as compared to analog channel programs). Digital channel broadcasts contain program and system data information that must be processed before the channel selection can be displayed.

How to search for and store TV channels (continued)

Settings	Installation
TV	Language
Setup	Autoprogram
Installation	Weak channel inst.
Demo	Software upgrade
Exit	
Info	

Weak channel installation

This allows you to manually tune weak ATSC channels in order to adjust the antenna and thus optimize signal quality for that channel.
 This is only available for TV channels installed via an antenna connection (see p. 4).

1. Select a channel in the displayed list of TV channels (in the antenna mode).
2. The signal strength is displayed and updated continuously as you rotate the antenna.

Settings	Installation
TV	Language
Setup	Autoprogram
Installation	Weak channel inst.
Demo	Software upgrade
Exit	
Info	

How to upgrade the TV software

This menu allows you to upgrade your TV software using a USB device.

The USB device must be filled with the appropriate upgrade image (and structure) which can be found on the www.philips.com/support website.
 How to upload a new software version on your portable memory device, see Annex 1, p. 49.

Use of the Setup menu

Settings	Setup
TV	Preferences
Setup	Source
Installation	Clock
Demo	
Exit	
Info	

Settings	Setup	Preferences
	Preferences	Picture/sound pref.
	Source	Features prefer.
	Clock	Menu preferences
		Reset AV settings
Info		

This menu is used to control the settings of special TV functions, features and accessory devices.

The **Preferences** menu allows you to change settings that will typically be accessed only occasionally.

The **Source** menu allows you to select a source.

The **Clock** menu allows you to use your TV as a clock. This setup is necessary for the correct working of the Lock after feature.

Set your preferences

1. Press the **MENU** button.
2. Select **Setup** with the cursor down and press the cursor right to select the Preferences menu.
3. Press the cursor right again to select **Picture/sound preferences**.
4. Press the cursor right once more to enter the Picture/sound preferences menu.

Adjust picture/sound preferences

PIP format

This menu allows you to select the preferred format (PIP or Dual screen) which can then be displayed toggling the **PIP** button on the remote control On or Off.

1. Select **PIP format**.
2. Press the cursor right.
3. Select **PIP** or **Dual screen** with the cursor up/down.

Now, when the **PIP** button on the remote control is pressed and when

 - **PIP** is selected, the TV shows a full screen of video with a pip window of video on top of it.
 - **Dual screen** is selected, the TV splits the screen into two equally sized screens.

Remind: Dual screen/PIP functionality, also called HDMI PIP, is a function used to watch a broadcast and a HDMI source simultaneously.

- A broadcast can be analog or digital, cable or antenna.
- An external HDMI device (DVD, DVD-R, Set Top Box, A/V receiver,...) must be connected to **HDMI 1** or **HDMI 2**.

Note: PIP format:

PC formats via HDMI will always be displayed full screen.

4. Press the cursor left/right to highlight the PIP window or the left/right screen in Dual screen.
5. Press the **-CH/PAGE+** button to change the broadcast channel or the **AV+** button to change the HDMI source in the highlighted screen.

Note: Audio only plays from the main, when PIP has been selected, or the left screen, when Dual screen has been selected.

Use of the Setup menu (Continued)

Settings/Setup	
Preferences	Picture/sound pref.
Picture/sound pr.	PIP format
Features prefer.	Auto surround
Menu preferences	
Reset AV settings	
Info	

Define the position of the PIP screen

1. Press the cursor right to highlight the PIP screen.
2. Press the red color button on the remote control to select **Position**.

Note: If no action has been undertaken, the function buttons at the bottom of the screen will disappear after a few seconds.

3. Use the cursor keys to define the position of the PIP screen.

Auto surround

Sometimes the broadcaster transmits special signals for Surround sound encoded programs.

- ▷ When selected **Auto surround On**, the TV automatically switches to the best surround sound mode.

Adjust features preferences

Caption service

This allows you to select the Closed Captions service levels of analog broadcasting to be displayed.

Closed Captioning allows you to read the voice content of television programs on the TV screen. Designed to help the hearing impaired, this feature uses on-screen 'text boxes' to show dialogue and conversations while the TV program is in progress. Captions will appear on the screen during captioned broadcasts.

1. Select **Caption service**.
2. Press the cursor right.
3. Select the desired Caption service:
 - ▷ **CC 1, 2, 3 or 4**
Dialogue (and descriptions) for the action on the captioned TV program shows on screen. Usually CC 1 is the most used. CC 2 may be used for alternate languages if they are being transmitted.
 - ▷ **T 1, 2, 3 or 4**
Often used for channel guide, schedules, bulletin board information for Closed Captions programs, news, weather informations or stock market reports.
Not all Caption services are necessarily being used by a TV channel during the transmission of a Closed Caption program.
4. See Closed Caption in the TV, Features menu, see p. 27, to turn the Caption service On or Off.

Settings/Setup	
Preferences	Features preferen.
Picture/sound pr.	Caption service
Features prefer.	Digital caption opt.
Menu preferences	Digital caption serv
Reset AV settings	Downloaded rat....
Info	

Notes:

- This television provides display of television closed captioning conforming with the EIA-608 standard and in accordance with Sections 15.119 of the FCC rules.
- The captions do not always use correct spelling and grammar. Not all TV programs and product commercials are made for broadcast with Closed Caption informations included. Refer to your area's TV program listings for the TV channels and times of Closed Caption shows. The captioned programs are usually noted in the TV listings with service marks such as 'CC'.

Use of the Setup menu (continued)

Digital caption service

This allows you to configure the way you choose to view the digital captioning.

- Select one of the digital service channels made available by the caption provider. There are 6 standard services.
 - Service 1 is designated as the Primary Caption Service. This service contains the verbatim, or near-verbatim captions for the primary language being spoken in the accompanying program audio.
 - Service 2 is designated as the Secondary Language Service. This service contains captions in a secondary language which are translations of the captions in the primary Caption Service.
 - The other service subchannels are not pre-assigned. It is up to the discretion of the individual caption provider to utilize the remaining service channels.

Settings/Setup/Preferences	
Features prefer.	Dig. caption options
Caption service	Reset to default
Dig. caption serv.	Size
Dig. caption opt.	Style
Downloaded ratin...	Text
	Background
Info	

Digital caption options

This allows you to modify how digital captions are displayed on your TV.

- Select from the following options to change the visual characteristics of your TV's digital captioning.
 - **Reset to default**
Select this option to reset the digital caption options back to the captions provider default settings.
 - Press the cursor right and press the **OK** button to confirm.
 - **Size**
Select this option to select the size of caption display according to your own preference.
 - Select **Default** (Automatic), **Small**, **Standard** or **Large** and press the **OK** button to confirm.
 - **Style**
Select this option to select the font style of caption display according to your own preference.
 - Select **Default**, **Monospaced serif**, **Serif**, **Monospaced sans serif**, **Sans serif**, **Casual**, **Cursive** or **Small caps**.
 - **Text**
Select this option to select the text color or the opacity of the text box of caption display according to your own preference.
 - Select a color and one of the opacity options.
 - **Background**
Select this option to select the character background color or one of the background opacity options of caption display according to your own preference.
 - Select a color and one of the opacity options.

Settings/Setup/Preferences	
Features prefer.	Downloaded ratin...
Caption service	On
Dig. caption serv.	Off
Dig. caption opt.	
Downloaded ratin...	
Info	

Downloaded rating table

This allows you to add region ratings lock options next to your current ones.

Caution: Before activating, please ensure regional ratings are broadcasted.

Use of the Setup menu (continued)

Settings/Setup	
Preferences	Menu preferences
Picture/sound pr.	OSD
Features prefer.	Show emergency..
Menu preferences	Change PIN
Reset AV settings	
Info	

Adjust menu preferences

OSD

1. Select **OSD**.
2. Press the cursor right to select **Minimum** or **Normal**.
Minimum to activate the temporarily display of the channel number/input source when either channel or input are changed.
Normal to activate the temporarily display of the volume bar, after a volume adjustment, as well as of the channel number/input source when either channel or input are changed.

Show emergency alerts (EAS)

This allows you to select the alert priority level of the information disseminated by the cable operator. The standard SCTE18 defines an Emergency Alert signalling method for use by cable TV systems to signal emergencies to digital devices such as digital Cable boxes, digital TVs and digital VCRs. The Emergency alert signalling scheme defined in the standard allows a cable operator to disseminate emergency alert information related to state and local-level emergencies and warnings in a cost-effective and efficient way, while minimizing disruption of programming.

An Emergency alert message will have one of the following priorities: Low, Medium, High or Maximum.

The Emergency alert message with priority High or Maximum will always be presented. Low or Medium will be present or ignored depending on the selected setting.

Important: When the TV clock is undefined (See Setup menu, Clock, p. 22), the Emergency Alerts will be ignored.

The Emergency Alert message display will contain following information:

- The Emergency Alert text
- The start time + date
- The end time + date.

1. Select **Show Emergency Alerts** in the Menu preferences menu.
2. Press the cursor right and select one of the Emergency alerts options:
 - **Always**, when you always want the Emergency alert messages to be displayed when available;
 - **Skip low priority**, when you want the messages with low level to be ignored;
 - **Skip low/medium priority**, when you only want the messages with high priority to be displayed.

Notes:

- Emergency Alert Signalling is not possible:
 - when content browsing;
 - with analogue video sources.
- You always have the possibility to remove the message from the screen.
- The message display will overlap whatever menu element or other message is on the screen.

Use of the Setup menu (continued)

Set/Change PIN

This allows you to set or change the personal 4-digit access code that is used in the different lock functions of the TV.

1. Select **Set** or **Change PIN** with the cursor down.
 - ▷ If no PIN-code exists yet, the menu item is set to **Set PIN**. Follow the instructions on screen.
 - ▷ If a PIN-code has previously been entered, the menu item is set to **Change PIN**. Follow the instructions on screen.
2. Enter your PIN with the digit buttons.
All number combinations from 0000 tot 9999 are valid numbers.
3. The **Menu preferences** menu reappears with a message confirming that the PIN has been created.

Important: you have forgotten your PIN!

1. Select **Change PIN** in the Menu preferences menu and press the cursor right.
2. Press the cursor right to enter the overriding PIN code 0-7-1-1.
3. Press the cursor again and enter a new personal 4-digit PIN code. The previous code is erased and the new PIN-code is stored.

Settings/Setup	
Preferences	Reset AV settings
Picture/sound pr.	
Features prefer.	start now
Menu preferences	
Reset AV settings	
Info	

Reset the AV settings

This allows you to reset most of the picture and sound settings to their predefined factory states.

1. Select **Reset AV settings** with the cursor down.
2. Press the cursor right.
3. Press the **OK** button to erase settings and reset them to their default values.

Use of the Setup menu (continued)

Settings	
Setup	Source
Preferences	AV1
Source	AV2
Clock	AV3
	HDMI 1
	HDMI 2
	Side
	Digital Audio In
Info	

Select your source

This menu allows you to identify the accessory devices you have connected to the external inputs/outputs.

1. Select **Source** in the Setup menu.
2. Press the cursor right to enter the list of types of external inputs.
3. Select the appropriate input with the cursor up/down.
 - When you select **AV1**, **AV2**, **AV3**, **HDMI 1**, **HDMI 2** or **Side**, a list appears allowing you to identify which type of accessory device is attached to this input.
4. Press the cursor right again to enter the list of types of devices connected to the selected input.
5. Select the accessory device with the cursor up/down.

Digital Audio

If an accessory device has a digital audio output, you can connect this with a single cable to the TV's **Digital Audio in** jack.

In the Source menu, assign the Digital Audio in to the corresponding external input to which your accessory device is connected

The TV can output Digital audio via the **DIGITAL AUDIO OUT** connector to an external amplifier or receiver.

If your amplifier or receiver has a matching connector for Digital Audio In, you can connect it with a single cable to the TV's **DIGITAL AUDIO OUT**.

See To make Video and Audio connections, Digital Surround receiver, p. 45.

Settings	
Setup	Clock
Preferences	Auto clock mode
Source	Auto clock channel
Clock	Time
	Day
	Time zone
	Daylight saving
Info	

Set your clock

This allows you to use your TV as a clock.

Note: Adjusting the clock is necessary for the correct working of Lock after (See TV settings, Channels, p. 28) features.

Auto clock mode

1. Select **Clock** in the Setup menu.
2. Press the cursor right to select the **Auto clock mode**.
3. Press the cursor right to instruct the TV to get the time automatically or manually.

Note: Most of the TV channels are not transmitting clock information. There are few cable channels but they are at the end of the channel ring. There is no clock transmission in antenna channels. In such cases either clock extraction is taking a long time or there is no clock.

Use of the Setup menu (continued)

Auto clock channel (only available when Auto clock mode is set to Automatic)

With the cursor buttons, select the channel number where time can be found by the TV. Typically time can be found on PBS (Public Broadcasting System) as well as some other channels.

Time - Day (only available when Auto clock mode is set to Manual)

With the cursor buttons, select and enter the correct time and day.

If **Auto clock mode Manual** has been selected, and no clock search has been done, the system will keep the entered time and day.

Time zone (only available when Auto clock mode is set to Automatic)

This function allows you to select your local time zone. Broadcasted time information will correct the clock display for your local time.

1. Select **Time zone** with the cursor down.
2. Press the cursor right to select your local time zone.

Daylight saving (only available when Auto clock mode is set to Automatic)

Daylight saving time is automatically set by specially broadcasted signals. This menu item allows you to disable the automatic setting of daylight saving time. This is useful if you live in an area or state where daylight saving is not applied, but you receive channels from other areas where daylight saving signals are broadcasted.

1. Select **Daylight saving** with the cursor down.
2. Press the cursor right to select **Automatic** for automatic clock correction for daylight saving time, based on specially broadcasted signals.
3. Select **Off** to disable automatic clock correction based on the specially broadcasted signals.

Note: Changes in Clock settings are only activated after switching to standby.

Use of the TV menu settings

Settings	TV
TV	Picture
Setup	Sound
Installation	Features
Demo	Channels
Exit	
Info	

This menu allows you to adjust your preferred picture and sound settings and to control the settings of special TV features and functions.

Note: Dependent on the input signal, one or more menu items may not be selectable.

1. Press the **MENU** button on the remote control.
 - ▷ The **Settings** menu appears on the screen.
2. Select **TV** and press the cursor right.
 - ▷ The TV menu is displayed and gives an overview of the menu items you can select.

Adjust Picture menu settings

Settings	TV
TV	Picture
Setup	Sound
Installation	Features
Demo	Channels
Exit	
Info	

Settings	TV	Picture
Picture	Auto picture	
Sound	Contrast	
Features	Brightness	
Channels	Color	
	Sharpness	
	Color temperature	
	Digital processing	
	
Info		

The Picture menu contains the settings that affect the quality of the picture.

Note: Some menu items are not available in case of HD sources.

1. Select **Picture** and press the cursor right.
 > The Picture menu is moved to the left panel.
2. Select the menu items with the cursor up/down.
3. Adjust the settings with the cursor left/right or enter the list of submenu items with the cursor right.
 Select a submenu item with the cursor up/down.

Auto picture

Select **Auto picture** to display a list of predefined picture settings, each corresponding with specific factory settings.

Personal refers to the personal preference settings of picture in the picture menu.

Note: This Philips TV has been set at the factory to look best in bright store environments which typically use fluorescent lighting. As your home will likely not be as well lit as a store, we recommend that you cycle through the various auto picture modes to find the one that best suits your own viewing conditions. Most consumers will find that **Natural** is the correct choice.

Contrast

Adjusts the intensity of bright parts in the picture but keeps the dark parts unchanged.

Brightness

Adjusts the light output of the complete picture, which will mainly affect the darker areas of the picture.

Color

Adjusts the saturation level of the colors to suit your personal preference.

Sharpness

Adjusts the sharpness of fine details in the picture.

Color temperature

Increases or decreases **Warm** (red) and **Cool** (blue) colors to suit personal preferences.

- o Select **Cool** to give the white colors a blue, **Normal** to give the white colors a neutral, **Warm** to give the white colors a red tint.

Adjust Picture menu settings (continued)

Digital processing

- **Standard** = line doubling eliminates the flicker.
- **Pixel Plus** = for everyday viewing, Pixel Plus is the most ideal setting, as it fully processes the image to make every single pixel the best it can be, improving contrast, sharpness, picture depth, and color reproduction and brilliance from every source, including High Definition.

Standard mode is recommended only for very noisy or poorly mastered sources or for those who find the smoothness of Pixel Plus (which eliminates judder in the picture) unsettling.

Dynamic contrast

Automatically makes the contrast in the darker and the brighter picture areas more noticeable as the image on the screen changes.

- o Normally select **Medium**. It may be preferred to select **Minimum**, **Maximum** or **Off**.
- o Select one of the settings with the cursor up/down.

DNR (Digital Noise Reduction)

Automatically filters out and reduces the image noise and improves picture quality when receiving weak video signals.

- o Select **Off**, **Minimum**, **Medium** or **Maximum** according to the image noise in the picture.

Color enhancement

Automatically controls green enhancement and blue stretch. It makes the colors more vivid.

- o Select **On** or **Off** in order to activate/de-activate.

Tint

Allows you to select the color mix (hue) of the picture.

Picture format

This menu item performs the same as the **FORMAT** button on the remote control. See Use of the remote control, p. 8.

Active Control

The TV continuously measures and corrects all incoming signals in order to provide the best picture possible.

1. Select **Active Control**.
2. Press the cursor right to enter the list of Active Control values.
3. Press the cursor right repeatedly to select the Active Control values **Off**, **Minimum**, **Medium** or **Maximum**.
 - ▷ The picture settings are being optimized continuously. Those menu items can not be selected.
4. Press the **OK** button or wait for the time out to dismiss the Active Control display.

Settings/TV	
Picture	Active Control
.....	Off
Digital processing	Minimum
Dynamic contrast	Medium
DNR	Maximum
Color enhancem.	
Tint	
Picture format	
Active Control	
Info	

Adjust Sound menu settings

Settings	TV
TV	Picture
Setup	Sound
Installation	Features
Demo	Channels
Exit	
Info	

Settings	TV	Sound
Picture		Auto sound
Sound		Volume
Features		Balance
Channels		Headphone volume
		Sound mode
		Alternate audio
		Dig.Audio language
		Mono/Stereo
		AVL
		Delta volume
Info		



Manufactured under license from Dolby Laboratories.
 'Dolby' 'Pro Logic' and the double-D symbol are trademarks of Dolby Laboratories.

The Sound menu contains the settings that affect the quality of the the sound.

1. Press the **MENU** button on the remote control.
 - The **Settings** menu appears on the screen.
2. Select **TV** and press the cursor right.
 - The **TV** menu is displayed and gives an overview of the menus you can select.
3. Select **Sound** and press the cursor right.
 - The Sound menu is moved to the left panel.
4. Select the menu items with the cursor up/down. Adjust the settings with the cursor left/right.

Note: Remember, control settings are at normal mid-range levels when the bar scale is entered.

Auto sound

Select **Auto sound** to display a list of predefined sound settings, each corresponding with specific factory settings of Treble and Bass.

Personal refers to the personal preference settings of sound in the sound menu.

Note: The moment you are in a predefined Auto sound setting and you modify a setting in the Sound menu, all values of the menu will overwrite the previously made personal setting.

Volume

Allows you to adjust the sound output level.

Balance

Allows you to adjust the output of the right and left speakers to obtain the best stereo reproduction for your listening position.

Headphone volume

Allows you to control the level of sound through the headphones.

Sound mode

Allows you to select the modes for more spatial or surround sound reproduction dependent on the broadcast signals or signals from external inputs received.

Alternate audio (only selectable with analog broadcast signals)

Gives you the possibility to swap between the **Main** and **Second audio Program (SAP)** when it is available.

Adjust Sound menu settings (continued)

Digital Audio language (only selectable with digital broadcast signals)

Allows you to select your language preference in case of multilingual audio track programs if available with digital broadcast signal.

Note: The default language for the digital channels is the installed menu language.

Mono/Stereo

Allows you to select, per TV channel, Mono or Stereo sound when analog stereo broadcasts are available.

AVL (Automatic Volume Leveler) (only available with analog broadcast and non-Digital signals)

Automatically reduces the volume differences between channels and programs, providing a more constant overall level. This will also reduce the dynamics of sound.

Delta volume

Allows you to correct for any permanent volume differences between TV channels or external sources.

Adjust Features menu settings

Settings	
TV	Features
Picture	Closed captions
Sound	Sleeptimer
Features	
Channels	
Info	

The Features menu allows you to control the settings of special features.

1. Press the **MENU** button on the remote control.
 - ▷ The **Settings** menu appears on the screen.
2. Select **TV** and press the cursor right.
 - ▷ The **TV** menu is displayed and gives an overview of the menus you can select.
3. Select **Features** and press the cursor right.
 - ▷ The Features menu is moved to the left panel.
4. Select the menu items with the cursor up/down. Adjust the settings with the cursor left/right.

Closed captions

This displays the transmitted CC- or CS-text on the screen according to your chosen CC or CS service in the Setup, Features preferences menu, p. 18. This text can either be permanently displayed (assuming that the service is available in the broadcast) or only when mute is active.

1. Press the cursor right after having selected **Closed captions**.
2. Select **On**, **Off** or **On during mute**.

Sleeptimer

This sets a time period after which the TV automatically turns to standby.

1. Select **Sleeptimer**.
2. Press the cursor right.
3. Select a value with the cursor up/down. The list will have values from **0** to **180 minutes**. You can always turn off your TV earlier or select another time set.

Control TV channels' special functions

Settings	
TV	Channels
Picture	Lock after
Sound	Channels lock
Features	TV ratings lock
Channels	Movie ratings lock
	Preferred channels
	Region ratings lock
	Clear region ratings
Info	

Settings/TV	
Channels	Lock after
Lock after	Timer
Channels lock	Time
TV ratings lock	
Movie ratings lock	
Preferred channels	
Region ratings lock	
Clear region ratings	
Info	

Age-based rating	Content-based rating
All	none
None	none
TV-Y	none
TV-Y7	(FV) Fantasy Violence
TV-G	none
TV-PG	(D) Dialog (L) Language (S) Sex (V) Violence
TV-14	(D) Dialog (L) Language (S) Sex (V) Violence
TV-MA	(L) Language (S) Sex (V) Violence

This menu allows you to control special functions for the TV channels.

1. Press the **MENU** button on the remote control.
 - The **Settings** menu appears on the screen.
2. Select **TV** and press the cursor right.
 - The **TV** Menu is displayed and gives an overview of the menu items you can select.
3. Select **Channels** and press the cursor right.
 - The **Channel** menu is moved to the left panel.
4. Select the menu items with the cursor up/down.

Lock after

Note: Lock after is only selectable if time and date are known. See Setup, Clock menu, p. 22.

This allows you to prevent the viewing of the selected channel after a selectable time delay. Locked channels can still be tuned, but the picture is blanked and the audio is muted.

1. Press the cursor right and select **Timer On** or **Off**.
 - When set to **On** this allows you to set the clock.
 - When having selected **Timer On**, you will be summoned to enter your PIN (See Set/Change PIN, p. 21). Follow the instructions on screen.
2. Select **Time** and press the cursor right.
 - This allows you to set the time after which the lock is set.
3. Select **AM** or **PM** to select the correct period of the day.
4. Enter the time with the digit or the cursor buttons.

Channel lock

This allows you to completely lock a certain TV channel or external source.

- Select the channels or subchannels you want to lock.

TV ratings lock

Your TV is equipped with a V-chip. This allows you to control access to individual programs based on their movie and TV ratings. All settings apply to all AV inputs, except HDMI. The program content advisory data are sent by the broadcaster or program provider.

1. Select **TV ratings lock** with the cursor down.
 - A list appears, showing the age-based TV ratings and a corresponding content-based ratings list.
2. Press the cursor right to enter the list.
3. Select an age-based TV rating with the cursor up/down, and enter, if present, the list with content-based ratings with the cursor right, and select one content-based rating.
4. Press **OK** to activate/de-activate the selected rating. You are asked to enter your PIN-code (see Set/Change PIN, p. 21). If the code is correct, the TV ratings lock menu reappears.
5. Select another content-based rating if you like and press **OK** again.

Control TV channels' special functions (continued)

When **All** has been selected, all items in the age-based and in the contents-based lists are locked.

If, while **All** is selected, any other item, either an age-based or content-based item, is unselected, then **All** is automatically unselected.

No rating is the selection for items that either have no rating information or have a rating of None. Both will be locked.

When an item on the age-based list is selected, all items below that item of the same group are locked as well.

When you select a content-based rating, all identical content-based ratings in the older age-based categories are also selected.

Notes:

- You can lock/unlock any number of ratings on the list without re-entering your code.
- Each ratings item has a box-graphic in front of it to indicate whether or not programs carrying that rating are currently locked.

TV ratings

TV-Y	appropriate for children of all ages with themes and elements suitable for children aged 2-6
TV-Y7	programs designed for children age 7 and older
TV-Y7-FV	programs include fantasy violence more intense than other programs in the TV-Y7 category
TV-G	programs suitable for all ages. These programs contain little or no violence, no strong language and little or no sexual dialogue or situations
TV-PG	programs contain elements that some parents may find unsuitable for younger children and which may need parental guidance. The program may contain moderate violence, sexual dialogue and/or situations and some strong language.
TV-14	programs contain elements that may not be suitable for children under 14 years of age. These programs include one or more of the following: intense violence, intense sexual situations, suggestive dialogue and strong language.
TV-MA	programs are designed to be viewed by adults and may be unsuitable for children under the age of 17. These programs may contain graphic violence, explicit sexual activity and/or crude or indecent language.

Control TV channels' special functions (continued)

Settings/TV	
Channels	Movie ratings lock
Lock after	
Channels lock	Please enter your
TV ratings lock	PIN
Movie ratings lock	
Preferred channels	
Region ratings lock	
Clear region ratings	
Info	

Movie ratings lock

This function allows you to control access to individual movies based on their MPAA ratings (Motion Picture Association of America).

1. Select **Movie ratings lock** with the cursor down. A list appears, showing all valid MPAA content ratings.
2. Press the cursor right to enter the list. You are asked to enter your code. (See Set/Change PIN, p. 21.) If the code is correct, the Movie ratings lock menu reappears.
3. Select a movie rating with the cursor up/down.
4. Press **OK** to activate/de-activate the selected rating.

Each rating item has a box-graphic in front of it to indicate whether or not programs carrying that rating are currently locked.

When **All** has been selected, all items on the movie ratings list become selected. (All movies are locked.)

If, while **All** is selected, any other item is unselected, then **All** is automatically unselected.

When **NR** has been selected, no other item is selected.

When any other item has been selected, all ratings below are selected as well, thus all movies with those ratings will be locked.

Movie ratings

NR	not rated
G	movies with a mild content, suitable for all ages
PG	movies for which parental guidance is recommended. They may contain a few racy or violent scenes or maybe some bad language
PG-13	movies for which parental guidance may be recommended if under age 13
R	restricted. The movies usually contain offensive sex or bad language and may be unsuitable for children under the age of 17. Parental guidance or permission needed.
NC-17	even with parental permission, forbidden under age 17. More offensive sex, violence or bad language.
X	movies which generally focus on sex, violence and/or bad language. Also known as pornography.

Control TV channels' special functions (continued)

Settings/TV	
Channels	Preferred channels
Lock after	Channel 1
Channels lock	Channel 2
TV ratings lock	
Movie ratings lock	
Preferred channels	
Region ratings lock	
Clear region ratings	
Info	

Preferred channels

After having finished to search for and to store TV channels, all the installed, non-scrambled, TV channels are marked as preferred by default.

With the **-CH/PAGE+** button on the remote control you can browse through the list of the TV channels. Only those channels which are in the preferred list will be displayed. In this menu you can skip TV channels from the preferred list, or add again.

1. Select **Preferred channels** and press the cursor right.
 - ▷ A list appears with all TV channel numbers.
2. Select the channel you want to remove from the preferred list (or add again);
3. Press **OK** to confirm.
4. Repeat for every channel you want to make preferred or non-preferred.

Region ratings lock (if present)

This allows you to control access to individual programs based on their broadcasted regional rating.

1. Select **Region ratings lock** with the cursor down.
 - ▷ A list appears, showing all valid region ratings.
2. Press the cursor right to enter the list.
 - ▷ You are asked to enter your PIN code. See Set/Change PIN, p. 21).
 - ▷ If the code is correct, the Region ratings lock menu reappears.
3. Select a region rating with the cursor up/down.
4. Press the **OK** button to activate the selected rating.
5. Select another region rating if you like and press **OK** again.
6. Press the cursor left to return to the **Channels** menu.

Clear region ratings

This allows you to clear the complete content of the Region ratings lock menu.

1. Select **Clear region ratings** with the cursor down.
2. Press the cursor right.
 - ▷ You are asked to enter your PIN code. See Set/Change PIN, p. 21.)
3. Press the **OK** button to activate.
4. press the cursor left to return the **Channels** menu.

Multimedia Browser

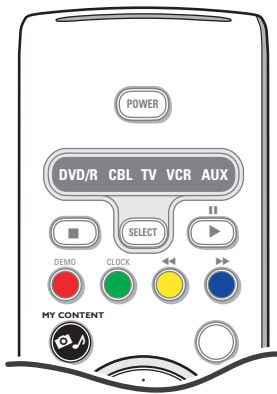

The Multimedia browser lets you display pictures or play audio files stored on a USB device. The Multimedia browser application is invoked from the My Contents menu when a USB device is inserted.

1. Press the  button on the remote control.
2. Press the cursor down to select **Multimedia**.
3. Press the cursor right and select the USB device inserted into the USB connector at the side of the TV.
4. Press the cursor right and select a content type.

- Following file formats can be reproduced:
 - for pictures: JPEG
 - for audio: MP3, MP3 Pro, LPCM
- Only FAT/DOS-formatted memory devices are supported.
- Philips can not be held responsible if your USB device is not supported.

To view content from a USB device

Tip: if your USB device does not fit into the USB connector at the side, use an USB extend cable to connect the USB device to the USB port. Ask your dealer for more information.

To insert a USB device

Note: USB devices are not supplied with this TV.

- o Insert a USB device to the USB connector at the left side of the TV.
When a USB device is inserted, the Multimedia browser menu is displayed automatically. See further.

To remove the USB device







1. First switch off the My Content menu. To do so, navigate to the Multimedia browser menu and press the my  button to exit the menu.
2. Remove the USB device.

Television	TV menu
	TV channels
Multimedia	

USBDevice 1	Picture
Music	London 2005
Picture	The Beatles
	Xmas2004.alb
	arnold.jpg

USBDevice 1	
Picture	London 2005
London2005	pic001.jpg
The Beatles	pic002.jpg
Xmas2004.alb	pic003.jpg
arnold.jpg	pic004.jpg

USBDevice 1/Picture/London2005	
London2005	pic001.jpg
pic001.jpg	
pic002.jpg	
pic003.jpg	
pic004.jpg	

USBDevice 1/Picture/London2005	
London2005	pic001.jpg
	
	
	pic001.jpg
	
Press OK to play.	

Multimedia Browser menu

1. Insert a USB device.
2. Select the USB device under Multimedia with the cursor up/down.
 - ▷ The Multimedia browser allows you to browse content stored on the inserted USB device.
 - ▷ The 2-panel browser will be shown with the left panel containing the content types (Music, Pictures).
 - ▷ The right panel will display the content that is available of the selected content type.
3. Press the cursor up/down to select a content type.
4. Press the cursor right to enter the content.
5. Press the cursor up/down to select a file or a directory.

Note: press the green color button to display all the image files in the current directory as thumbnails when browsing pictures. Press the green button again to display the image files in a list.

6. In case a **file** is selected, press the **OK** button to display a picture file or to play an audio file. In case a **directory, album** or **playlist** is selected, press the cursor right to enter the content or press the **OK** button to start a slide show or a loop playback of the files present.
7. Press the cursor left to keep music playing and switch back to the Multimedia menu.
8. Press one of the color buttons on the remote control to perform the corresponding function mentioned at the bottom of the screen.





Tip: the blue color button can, if necessary, be used to let the color buttons reappear.

9. To stop playing content, press the  button on the remote control.

Notes:

- your TV supports slide shows with background music. See Annex 2, Philips TV-slideshow format with background music, p. 51;
- the playback will continue to play even if temporarily switched to browser screens. The audio will be stopped when another song starts playing, or when the end has been reached;
- more technical remarks can be found in Annex 4, Philips TV-Digital camera and USB issues, p. 54.

Following icons may appear:

- | | | | |
|---|----------|---|--------------------------|
|  | folder |  | music |
|  | pictures |  | self made playlist/album |

Multimedia Browser (Continued)

Function buttons at the bottom of the screen

Details	to display a description of the selected file or directory
Transitions	to select if you like to apply a transition during a slide show
Slide time	to select the duration a picture will be displayed in a slide show
Rotate	to rotate a picture
Repeat one/all	to repeat the playback of a music file
Shuffle	to shuffle music collections in a random way

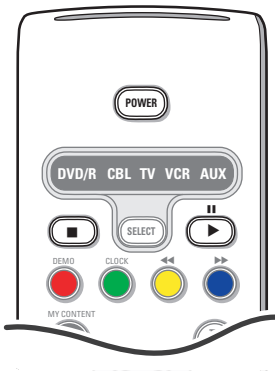

Multimedia function buttons on the remote control

- to stop playing content
- || - to pause playing content
- ▶ - to play a single file, start a slide show, playback of a folder or other collection

To make video and audio connections









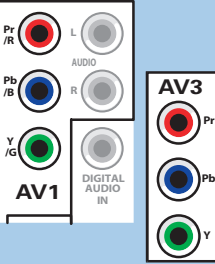
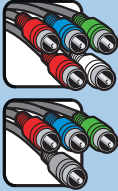
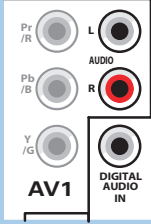
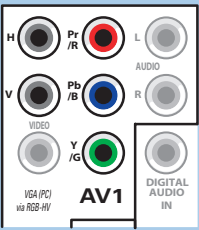

Tips:

- use the inputs that are available on your equipment that provide the best video or audio performance, as below;
- if you experience a discolored line on the left or right side of the set, adjust the picture position to the centre of the screen with the cursor buttons.

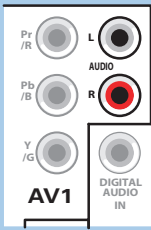
Note:

- your TV comes with all types of connectors with the exception of the DVI connector but some of your equipment may be equipped with this type. In this case you'll need a DVI to HDMI adapter or a HDMI to DVI cable and separate audio cables, all available at your local dealer.
- be sure to connect the DVI output connector first, then connect to the HDMI input on your TV.

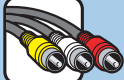

	Connector cable	Audio connection required
 HDMI	HDMI (High-definition Multimedia Interface) 	No
	Component video (480p/720p/480i/1080i) - Analogue audio (AV1) - Digital audio (AV1 or AV3) 	 AUDIO L / R DIGITAL AUDIO IN
	RGB H/V 	 AUDIO L / R AV1 DIGITAL AUDIO IN
 S-VIDEO	S-Video 	AUDIO L / R : L AV1 AUDIO AV2 R SIDE
 VIDEO	Video 	AUDIO L / R : L AV1 AUDIO AV2 R SIDE
 75 Ω	RF/Coaxial 	No

Warnings: in case you notice scrolling images, wrong colors or no color, no picture, or even combinations of these on your screen, verify if the connections are done in the correct way and if the resolution and the signal standard of the connected equipment are set in the right way. See the handbook for your equipment.

To make video and audio connections (Continued)

Notes:

- Cables are often color-coded to connectors. Connect red to red, white to white....
- Component video (YPbPr) connection is necessary to view video sources, for example digital broadcastings coming from a settop box, in 1080i, 720p, 480i or 480p;
- The labels for the component video sockets may differ depending on the DVD player or the device connected. Although the abbreviations may vary, the letters B and R stand for the blue and red component signals, respectively, and Y indicates the luminance signal. Refer to the DVD player's or devices instructions for use for definitions and connection details;
- This television is designed to accept high definition signal standards 480p, 720p and 1080i as specified by the Electronic Industries Association standard EIA770.3.
Digital devices from different manufacturers have the possibility of differing output standards which may cause difficulties for the television to properly display.

Side panel overview

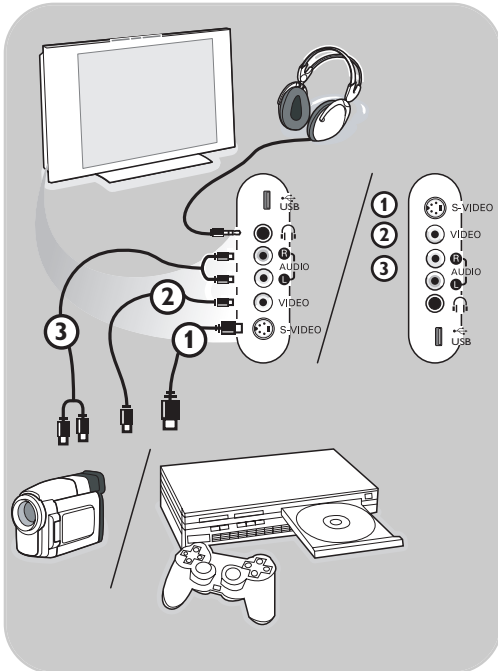

Camera, Camcorder, Game

1. Connect your camera, camcorder or game as shown.
2. Connect to **VIDEO** ② and **AUDIO L** ③ for mono equipment. For stereo equipment also connect **AUDIO R** ③.

S-VHS quality with an S-VHS camcorder is obtained by connecting the S-VHS cables with the **S-VIDEO** input ① and **AUDIO** inputs ③.

Warning: do not connect cable ① and ② at the same time. This may cause picture distortion !

Headphone

1. Insert the plug into the headphone socket as shown.
2. The headphone impedance must be between 8 and 4000 Ohm. The headphone socket has a 3.5 mm jack.

In the Sound menu select **Headphone volume** to adjust the headphone volume.

Tip: Press  on the remote control to switch off the internal loudspeakers of the TV.

USB

See Multimedia browser, p. 32.

Rear panel overview

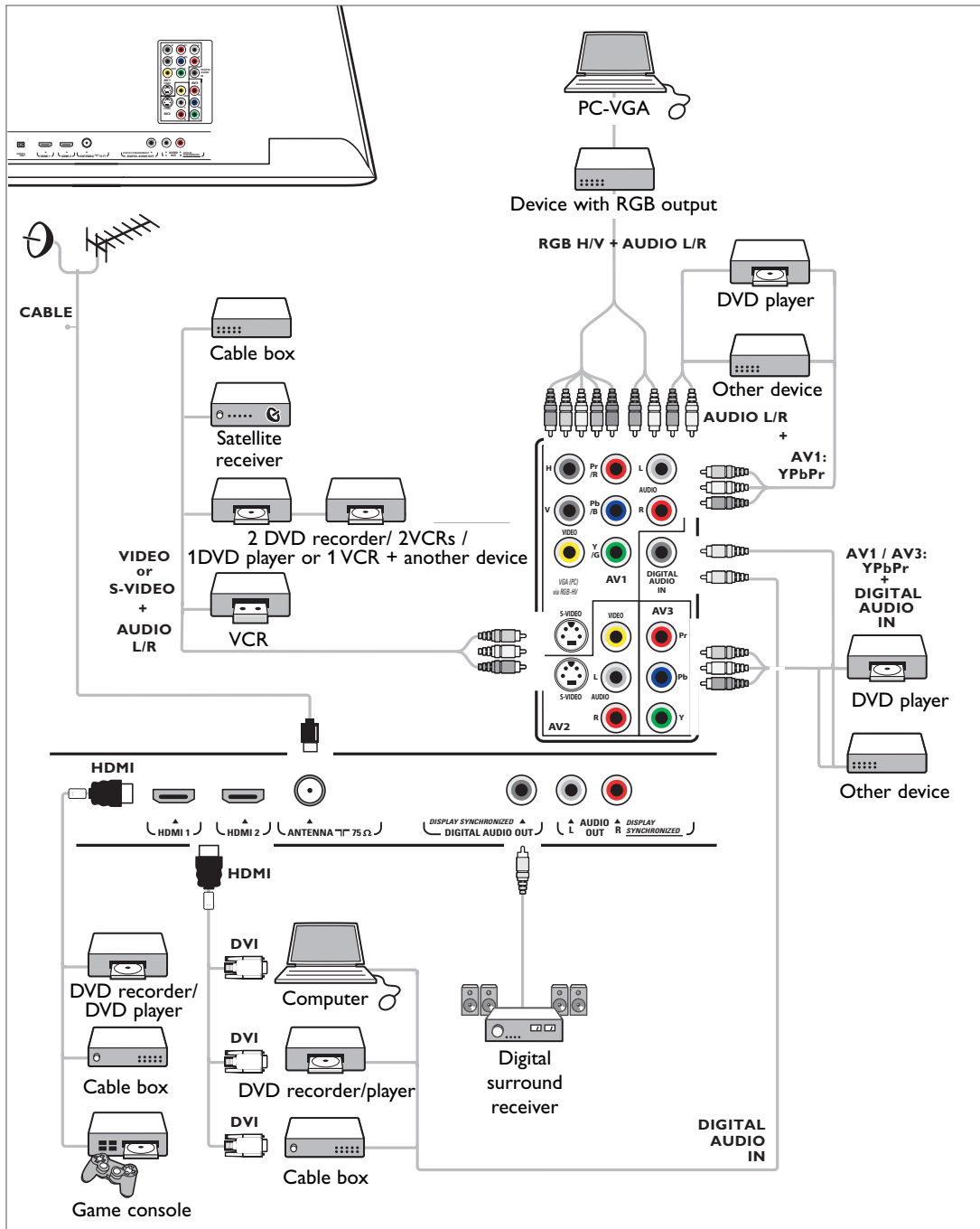

Note:

- Due to possible digital image distortion when displaying signals from connected digital equipment, automatically the Auto picture setting **Soft** is selected, if you selected Digital STB in the Source menu. See Adjust Picture menu settings, Auto picture, p. 24. Changing this setting during reviewing will not be stored as **Personal** setting after switch off.

Connect a VCR or DVD recorder

Warning: do not place your recorder too close to the screen as some recorders may be susceptible for signals from the display. Keep a minimum distance of 0,5 m from the screen.

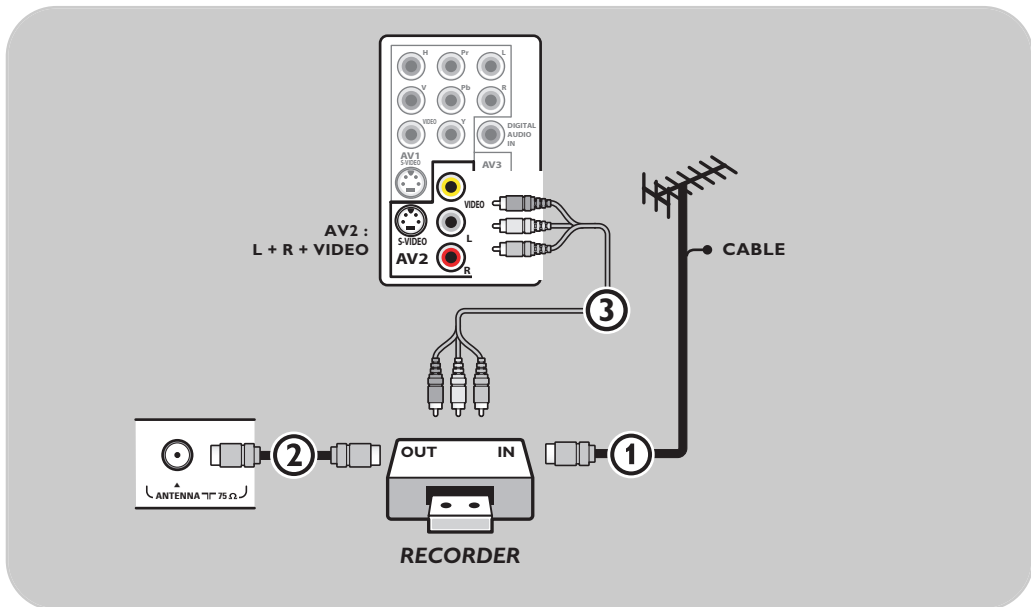

1. Connect the RF Antenna or Cable TV cable (eventually via an optional two-way signal splitter and/or Cable TV converter box) ① to the **RF IN** socket of your recorder.
2. Connect another RF cable ② from the output **OUT** of your recorder to the TV's **CABLE/ANTENNA 75 Ω** jack.
3. Better playback quality can be obtained if you also connect the Video, Audio Left and Right (only for stereo devices) AV cables ③ to the **VIDEO**, **AUDIO L** and **R** input jacks of **AV2**.
4. Select the equipment you have connected in the **Setup** menu, **Select your source**, p. 22 and link them to the **AV** connectors you have connected your equipment to.

Notes:

- cables are often color-coded to connectors. Connect red to red, white to white....
- if your recorder has an S-VHS video jack:
For improved picture quality, connect an S-video cable with the **S-VIDEO** input and connect the audio cables to the **AUDIO L** and **R** input jacks of **AV2**.
When using the **S-VIDEO** connector do not connect any device to the **AV2 VIDEO** jack.
- in case of mono equipment, only the left loudspeaker reproduces sound.
Use a mono to stereo adapter (not supplied) for sound reproduction via all internal loudspeakers.

Connect a recorder and other A/V devices

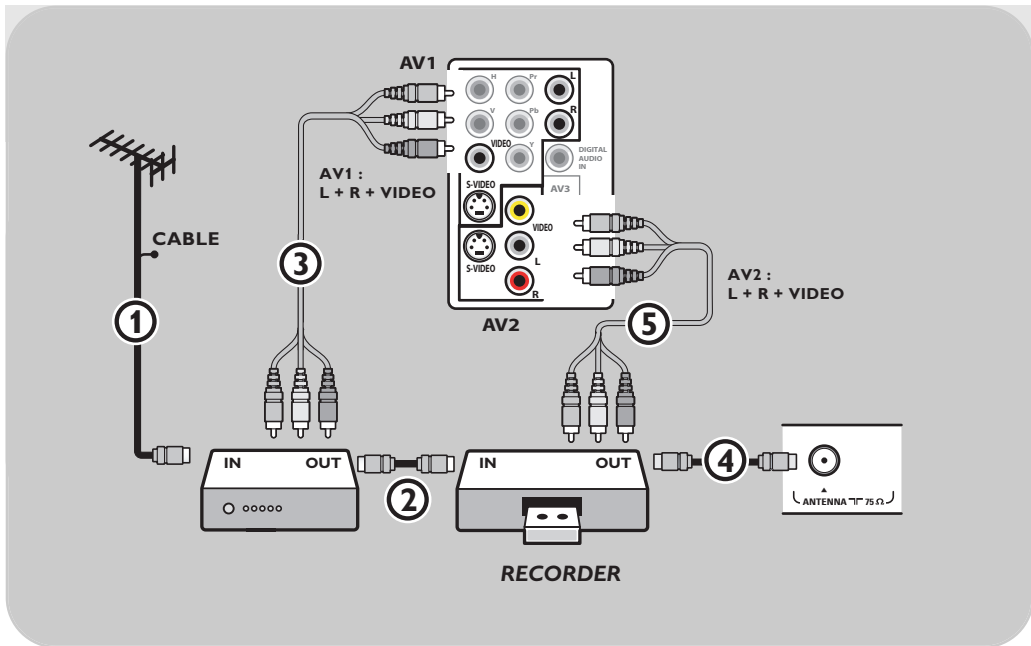

1. Connect the RF antenna cable ① of the **RF IN** socket of your other AV device.
2. Connect the RF output of the AV device to the RF input of the recorder ②.
3. Connect another RF cable ④ from the output **OUT** of your recorder to the TV's input **CABLE/ANTENNA 75 Ω** jack.
4. To obtain better quality, also connect the Video, Audio left and Audio right cables of both devices to **AV1** or **AV2** (**VIDEO**, **AUDIO L** and **R**.) ③ and ⑤.
5. Select the equipment you have connected in the **Setup** menu, **Select your source**, p. 22 and link them to the **AV** connectors you have connected your equipment to.

Notes:

- cables are often color-coded to connectors. Connect red to red, white to white....
- if your recorder has an S-VHS video jack:
For improved picture quality, connect an S-video cable with the **S-VIDEO** input of **AV1** or **AV2** and connect the audio cables to the **AUDIO L** and **R** input jacks of **AV1** or **AV2**.
When using the **S-VIDEO** connector do not connect any device to the **AV1** or **AV2** **VIDEO** jack;
- in case of mono equipment, only the left loudspeaker reproduces sound.
Use a mono to stereo adapter (not supplied) for sound reproduction via all internal loudspeakers.

Connect a recorder and Cable box with RF output

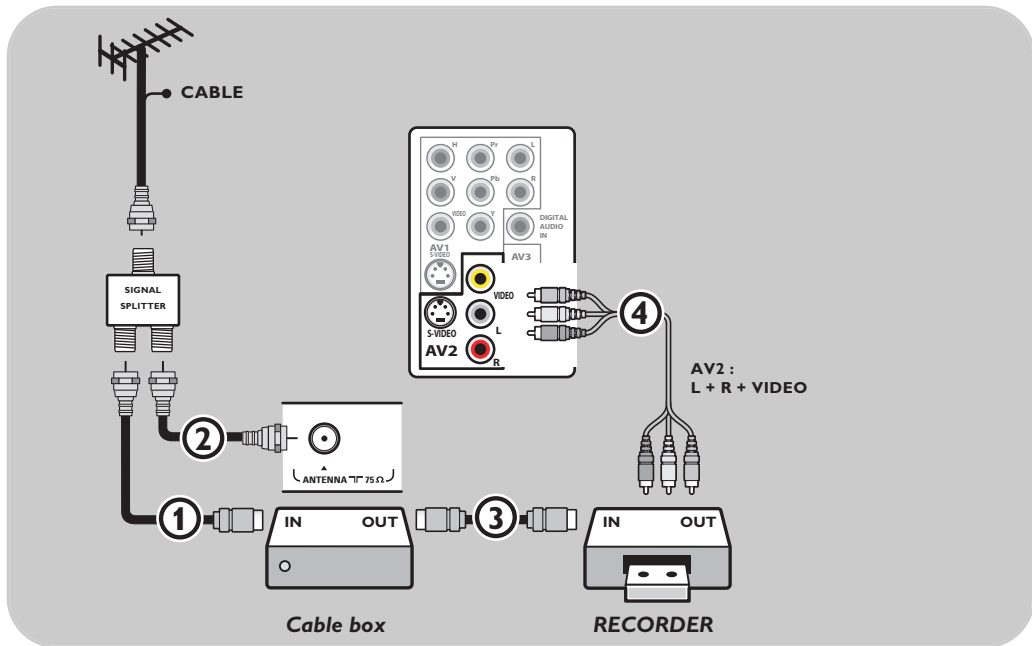

1. Use an optional signal splitter.
2. Connect one of the cable TV signal splitter outputs ① to the cable box's **IN** jack.
3. Connect the other cable TV signal splitter output ② to the **CABLE/ANTENNA 75 Ω** plug on the bottom of the TV.
4. Connect the cable box's **OUT** jack ③ to the recorder's **RF IN** socket.
5. Connect the Video, Audio Left and Right (only for stereo sound) recorder AV cables ④ to the **VIDEO**, **AUDIO L** and **R** input **AV2** jacks on the TV.
6. Select the equipment you have connected in the **Setup** menu, **Select your source**, p. 22 and link it to the **AV** connector you have connected your equipment to.

Notes:

- cables are often color-coded to connectors. Connect red to red, white to white....
- if your recorder has an S-VHS video jack:
For improved picture quality, connect an S-video cable with the **S-VIDEO** input of **AV2** and connect the audio cables to the **AUDIO L** and **R** input jacks of **AV2**.
When using the **S-VIDEO** connector do not connect any device to the **AV2 VIDEO** jack;
- in case of mono equipment, only the left loudspeaker reproduces sound.
Use a mono to stereo adapter (not supplied) for sound reproduction via all internal loudspeakers.

Connect a satellite receiver or Cable box with A/V outputs

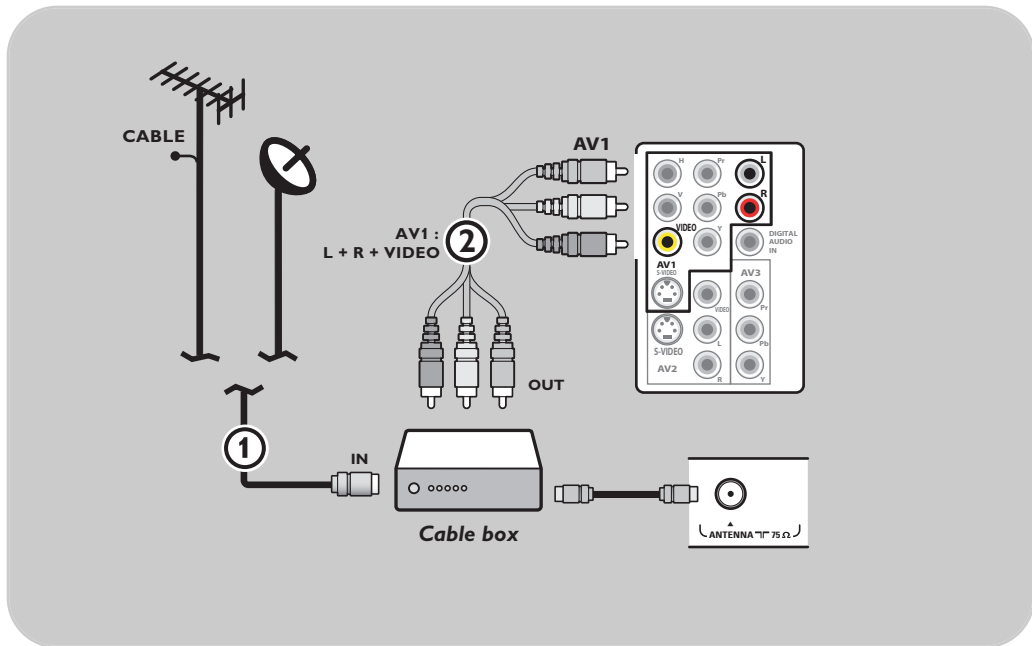

1. Connect the satellite antenna cable or the Cable TV cable ① to the satellite receiver's or cable box's **IN** jack.
2. Connect another RF cable ② from the output **OUT** of the satellite receiver or cable box to the TV's **CABLE/ANTENNA 75 Ω** jack.
3. Connect the Video, Audio left and right AV cables ③ to the **VIDEO**, **L** and **R** audio input jacks of **AV1**.
4. Select the equipment you have connected in the **Setup** menu, **Select your source**, p. 22 and link it to the **AV** connector you have connected your equipment to.

Notes:

- cables are often color-coded to connectors. Connect red to red, white to white....
- if your satellite receiver or cable box has an S-VHS video jack:
For improved picture quality, connect an S-video cable with the **S-VIDEO** input of **AV1** and connect the audio cables to the **AUDIO L** and **R** input jacks of **AV1**.
When using the **S-VIDEO** connector do not connect any device to the **AV1 VIDEO** jack;
- in case of mono equipment, only the left loudspeaker reproduces sound.
Use a mono to stereo adapter (not supplied) for sound reproduction via all internal loudspeakers.

Connect a recorder and satellite receiver or Cable box with AV outputs

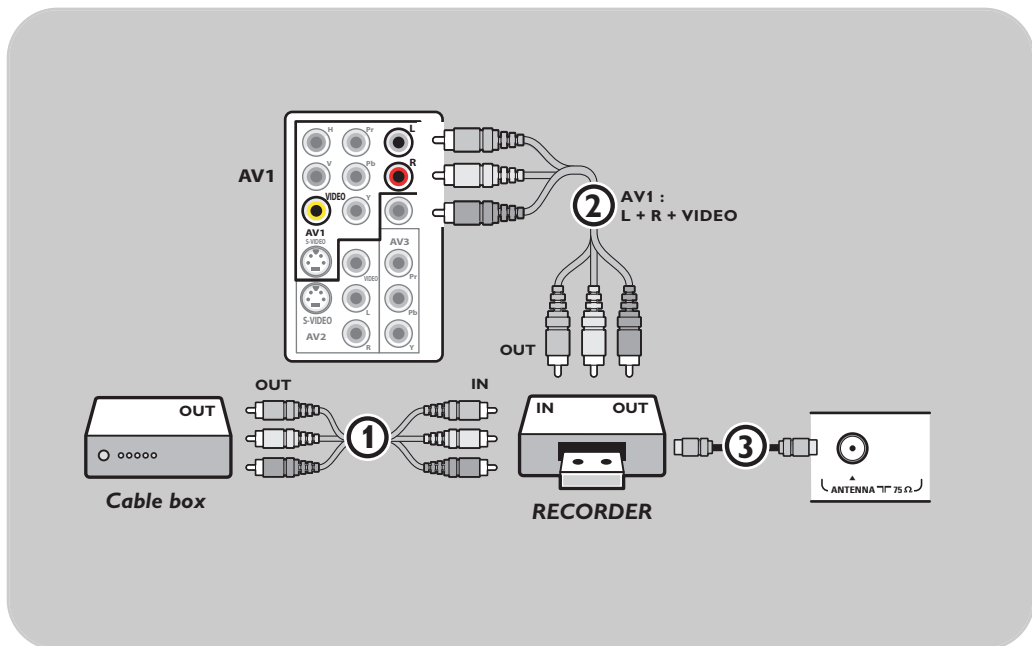

1. Connect the satellite antenna cable or the Cable TV cable ① to the satellite receiver's or cable box's **IN** jack.
2. Connect the AV cables ② to the satellite receiver's or cable box's **AV OUT** jacks and to the recorder's **AV IN** jacks.
3. Connect the Video, Audio Left and Right (only for stereo sound) recorder AV cables ④ to the **VIDEO**, **AUDIO L** and **R** input **AV1** jacks on the TV.
4. Connect another RF cable ③ from the output out of your recorder to the TV's input **CABLE/ANTENNA 75 Ω** jack.
5. Select the equipment you have connected in the **Setup** menu, **Select your source**, p. 22 and link it to the **AV** connector you have connected your equipment to.

Notes:

- cables are often color-coded to connectors. Connect red to red, white to white....
- if your recorder has an S-VHS video jack:
For improved picture quality, connect an S-video cable with the **S-VIDEO** input of **AV1** and connect the audio cables to the **AUDIO L** and **R** input jacks of **AV1**.
When using the **S-VIDEO** connector do not connect any device to the **AV1 VIDEO** jack;
- in case of mono equipment, only the left loudspeaker reproduces sound.
Use a mono to stereo adapter (not supplied) for sound reproduction via all internal loudspeakers.

Connect a DVD Player or other accessory digital source devices

Note: This TV is capable of displaying 1080i, 720p and 480p DTV signals when connected to a DTV tuner cable box. Select the output of the cable box to either 1080i, 720p or 480p. A DTV signal must be available in your area.

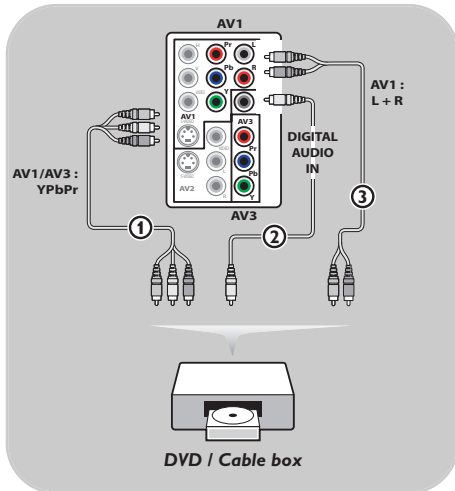

Devices with Component Video Output Connectors (YPbPr)

1. Connect the three separate component video cables ① to the device having component video outputs (YPbPr), such as cable boxes, DVD-players, laser-disc players, videogame players, satellite receivers or other equipment, and to the **Y, Pb** and **Pr** jacks of **AV1** or **AV3** on the TV.
2. Connect to the **Y, Pb** and **Pr** jacks of **AV1** in case of devices with analog audio signals.
3. Connect to the **Y, Pb** and **Pr** jacks of **AV3** in case of devices with digital audio signals.
4. Select the equipment you have connected in the **Setup** menu, **Select your source**, p. 22 and link it to the **AV** connector you have connected to.

Devices with RGB Output

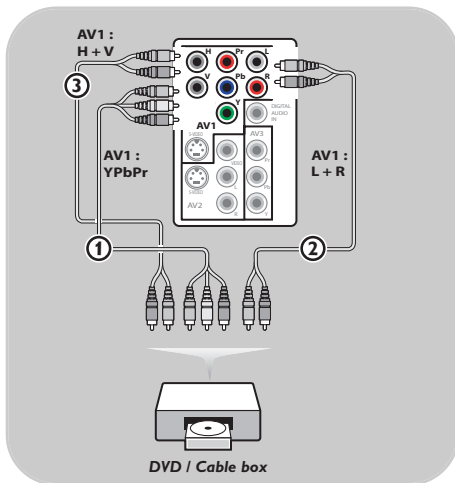

1. Connect the device with RGB output with separate Horizontal and Vertical sync to the **Pr/R, Pb/B** and **Y/G** input ① jacks and to the **H** and **V** jacks of **AV1** ②.
2. Connect the audio cables to the **L** and **R AUDIO** jacks of **AV1** ③.
3. Select the equipment you have connected in the **Setup** menu, **Select your source**, p. 22 and link it to **AV1**.

Devices with an S-Video connector

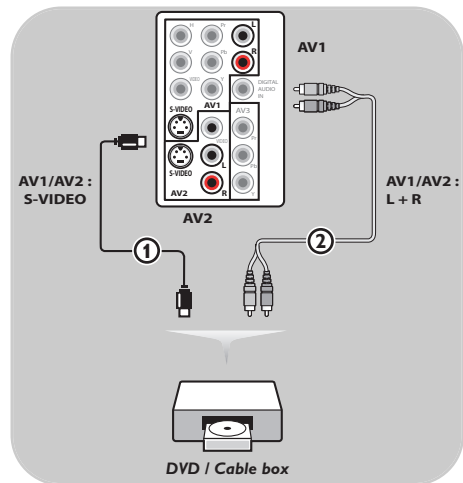

1. Connect an S-Video cable to the **AV1** or **AV2 S-VIDEO** input ①.

Tip: When using the **S-VIDEO** connector do not connect any device to the **AV VIDEO** input that you are using.

2. Connect the audio cables to the device's **AUDIO L** and **R** jacks and to the **L** and **R AUDIO AV1** or **AV2** jacks ② on the TV accordingly to where you connected the S-Video cable.
3. Select the equipment you have connected in the **Setup** menu, **Select your source**, p. 22 and link it to the **AV** connector you have connected to.

Connect a device to the HDMI (High Definition Multimedia interface) connector

Notes:

- HDMI is the leading new standard for Digital video and audio interconnection. To the **HDMI** connector you can connect HDMI devices such as a Cable box or compatible DVD-R or DVD player with HDMI, or DVI-equipped devices like a computer.
- If the accessory device has DVI output only, use a DVI to HDMI adapter cable (not supplied) to connect to the **HDMI** connector. (Then also connect the audio cables to AV1 AUDIO L and R.)
- If necessary, you can adjust the picture position to the center of the screen with the cursor buttons.

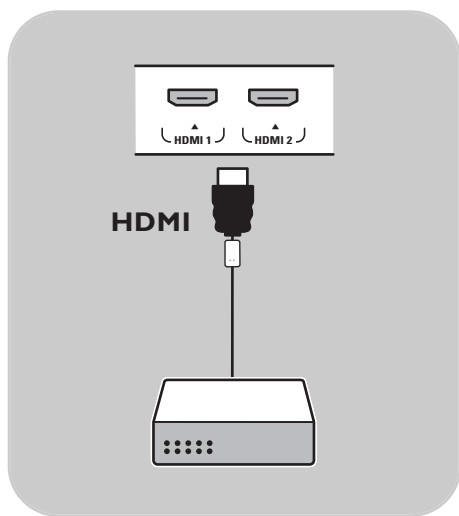

Devices with a HDMI connector:

1. Connect your HDMI device with the **HDMI** connector.
2. Select the equipment you have connected in the **Setup** menu, **Select your source**, p. 22 and link it to **HDMI 1** or **2**.

Note: in case of any problems, see Annex 4: Issues referring to connected equipment with a HDMI connector, p. 54.

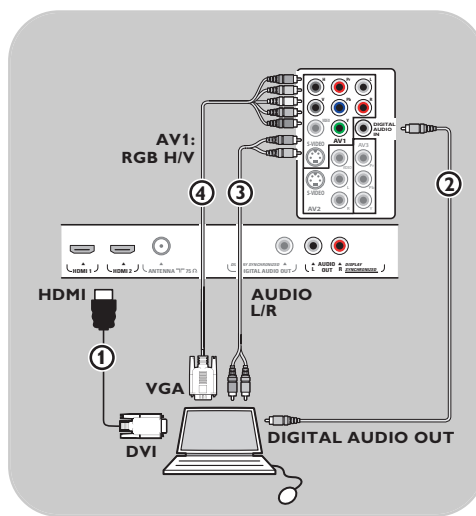

PC equipped with a DVI connector:

1. Use a DVI to HDMI cable to connect to one of the **HDMI** connectors of your TV ①.
2. Connect the audio cable ② to the PC's Digital Audio out jack and to the **DIGITAL AUDIO IN** jack on the TV.
3. Select the computer you have connected in the **Setup** menu, **Select your source**, p. 22 and link it to **HDMI 1** or **2**.
4. Also select **Digital Audio In** in the same Source menu.

PC equipped with a VGA connector:

1. Use a VGA to RGB H/V cable ④ to connect to the **RGB H/V** connectors of your TV.
2. Connect the audio cable ③ to the **AUDIO R** (right) and **L** (left) inputs of **AV1**.
3. Select the equipment you have connected in the **Setup** menu, **Select your source**, p. 22 and link it to **AV1**.

Connect a Digital Surround receiver

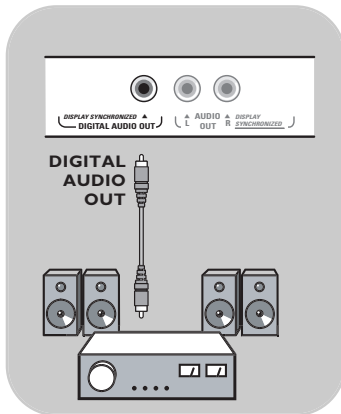

- Connect a MultiChannel Surround receiver to the **DIGITAL AUDIO OUT** connector at the bottom of the TV.

Note: Due to legal requirements, it is possible that with certain copy protected PCM audio qualities from a peripheral equipment connected to the **HDMI** input, the Digital audio output signal is muted.

Record with your recorder

Record a TV program

You can record a TV program using your recorders tuner without affecting your TV.

1. Select the channel number on your recorder.
2. Set your recorder to record.
See the handbook for your recorder.

Note: When recording analog programs, switching channel numbers on your TV does not disturb recording !

Select connected equipment



Before operating your connected equipment you have to make a selection in the **Setup, Select your source** menu, p. 22.

1. Press the **AV+** button repeatedly or select **Source** in the **Setup** menu (see p. 22) to select **AV1, AV2, AV3, HDMI 1, HDMI 2, Side** or **TV**, according to where you connected your devices.
2. Press the cursor up/down.
3. Press **OK**.

Audio- and video equipment buttons

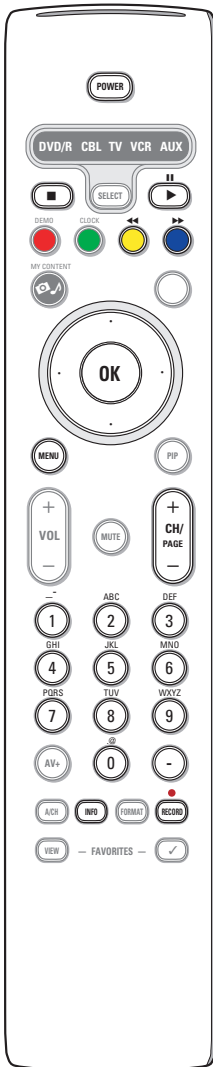

Most of the audio and video equipment from our range of products can be operated with the remote control of your TV. Press one of the buttons after you pressed the **SELECT** button repeatedly according to the equipment you want to operate with this remote control.

See Use of the Remote control, p. 7-8.

If no action is being undertaken within 60 seconds, the remote control returns to TV mode.

POWER to switch to standby

|| for pause,

● for record,

◀◀ for rewind (**VCR, CD**);
search down (**DVD, AMP**)

■ for stop,

▶ for play,

▶▶ for fast forward (**VCR, CD**);
search up (**DVD/AMP**)

INFO display information

MENU to switch the menu on or off

- **CH/PAGE +** for chapter, channel, track selection
0 to 9 digit entry,

- tape index (**VCR**),
select a DVD chapter,
select a frequency (**AMP**)

cursor up/down

to select the next or the previous disc (**CD**)

cursor left/right

to select the previous or following track (**CD**)

Notes:

- If no action is being undertaken within 60 seconds, the remote control returns to TV mode.
- After an action in the selected system mode, the remote control will remain in this mode for 60 seconds and will then return to TV mode or press the Select button to return to TV mode immediately.

Before Calling Service

Symptoms	Items to Check and Actions to follow
“Ghost” or double images	<ul style="list-style-type: none"> This may be caused by obstruction to the antenna due to high rise buildings or hills. Using a highly directional antenna may improve the picture.
No power	<ul style="list-style-type: none"> Check that the TV's AC power cord is plugged into the mains socket. Unplug the television, wait for 60 seconds. Then re-insert plug into the mains socket and turn on the television again.
No picture	<ul style="list-style-type: none"> Check antenna connections at the bottom of the TV to see if they are properly connected to the TV. Possible broadcast station trouble. Try another channel. Adjust the contrast and brightness settings. Try another auto picture setting. Check the Closed Captions control. Some TEXT modes could block the screen. Check if you selected the correct AV source.
No picture and power switched on	<ul style="list-style-type: none"> Your TV has a protective mode in case there is too much heat build-up. Check the clearance around the vents of the device to be certain there are no blocking walls or cabinets which would limit the air flow.
Picture position adjustment	<p>When displaying a High Definition signal from the YPbPr inputs or HDMI input, if necessary, you can adjust the picture position to the center of the screen with the cursor left/right or up/down buttons on the remote control. This may be needed due to slight differences in output signals from different brands and types of HD sources boxes.</p> <p><i>Note: Most High Definition receiver boxes also have picture-positioning controls in their menu systems. If the TV cursor controls run out of range before the picture is correctly positioned, the receiver box controls will need to be adjusted.</i></p>
No photo, music or video play or in poor quality only	<ul style="list-style-type: none"> Check if the source complies with a supported code.
No sound	<ul style="list-style-type: none"> Increase the VOLUME. Check that the TV is not muted, press the mute button on the remote control. When no signal is detected, the TV automatically switches off the sound. This is proper operation and does not indicate a malfunction.
Good sound but poor color or no picture	<ul style="list-style-type: none"> Adjust the contrast, color, tint and brightness setting. Try another auto picture setting.
Snowish picture and noise	<ul style="list-style-type: none"> Check the antenna connection.
Television not responding to remote control	<ul style="list-style-type: none"> Check whether the batteries are working. Replace if necessary. Clean the remote control sensor lens on the monitor. Operating range between TV and the remote control should not be > 240". You can still use the buttons at the right side of your TV. Check if the remote control is in the correct mode.
Control of accessory devices	<ul style="list-style-type: none"> The infrared signals of the screen may influence the reception sensibility of other peripherals Solution: replace the batteries of the remote control of other devices. E.g. keep away a wireless headphone from within a radius of 50".

Before Calling Service (continued)

Symptoms	Items to Check and Actions to follow
The software will not install	Possibly the operating system is wrong. Go to www.philips.com/support to see which operating systems are supported.
No stable or not synchronized VGA picture	Check if you have selected the correct VGA mode in your PC. See Annex 4, Issues referring to connected equipment with a HDMI connector, p. 54.
Standby	Your TV consumes energy in standby mode. Energy consumption contributes to air and water pollution.
After improper shutdown	If your TV has been shutdown in an improper way (e.g. power drop, power cord plug out), starting up the TV again will take a longer time than usual.

If your problem is not solved

Turn your TV off and then on again once.

Never attempt to repair a defective TV yourself.

Check with your dealer or call a TV technician.

Telephone number Philips Customer Care Center: 1-888-PHILIPS (744-5477)

Please, have the Model and Product number which you can find at the back of your television set ready, before calling.

Glossary

- 1080i** Provides 1080 lines of resolution. Displays images using interlaced scanning. 1080i is one of the formats used by HDTV (via HDMI, YPbPr, 1394...).
- 720p** Displays images using progressive scanning.
- CS** Digital Caption Service
- CC** Analog Caption Service
- DTV** A new technology for transmitting and receiving broadcast television signals. DTV provides higher resolution and improved sound quality over analog television.
- DV** Digital Video (from a camera)
- DVCR** Digital Video Recorder
- EAS** Emergency Alert System
Method for use by cable TV systems to signal emergencies to digital terminal devices such as digital STV, digital TV receivers and digital VCRs. It allows a cable operator to disseminate emergency alert information related to state and local-level emergencies and warnings.
- NTSC** Analog signals
- PBS** Public Broadcast System

Introduction

Philips offers software upgrade capability for your TV using portable memory. After you have completed a software upgrade, your TV will typically perform better.

What improvements are made depends on the upgrade software you are using as well as the software your TV contained before the upgrade.

You can execute the software upgrade procedure yourself. Be aware that the content of this document is addressing technical or software skilled users.

To prepare a USB device for software upgrade

For the procedure you will require:

- a personal computer with web browsing capability;
- an archive utility that supports the ZIP-format (e.g. WinZip for Windows or Stuffit for Mac OS);
- a preferably empty USB memory stick.

New software can be obtained from your dealer or can be downloaded from the www.philips.com/support website:

1. Go to www.philips.com/support using the web browser on your PC.
2. Follow the procedure to find the information and the software related to your TV.
3. Select the latest software upgrade file and download it to your PC.
4. Decompress the ZIP-file and copy the file "autorun.upg" to the root directory of the USB portable memory.

Note: only use software upgrades that can be found on the www.philips.com/support web site.

To verify the version of the TV software

Before you start the software upgrade procedure, it is advised to check what the current TV software is.

1. Select **Software Upgrade** in the Installation menu.
2. Press the cursor right.
 - ▷ The Software Upgrade menu moves to the left panel.
3. Select **Current Software Info** to observe the version and the description of the current software.

Note: It is possible to upload a software version equal or lower than the current version. In this case only a manual software upgrade procedure is possible. See p. 51.

Settings	
Installation	Software upgrade
Language	Current softw. info
Autoprogram	Local upgrades
Weak channel inst.	
Software upgrade	
Info	

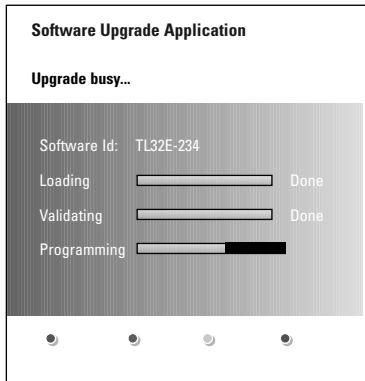

Automatic software upgrade procedure

1. Turn off your TV and remove all memory devices.
2. Insert the portable memory that contains the downloaded software upgrade.
3. Switch on your TV with the **POWER** button on your remote control.
4. At startup the TV will scan the portable memory until it finds the update content. The TV will automatically go to the upgrade mode. After a few seconds it will display the status of the upgrade procedure.

Warning:

- you are not allowed to remove the portable memory during the software upgrade procedure;
- in case of a power drop during the upgrade procedure, don't remove the portable memory from the TV. The TV will continue the upgrade as soon as the power comes back;
- if an error occurs during the upgrade you should retry the procedure or contact your dealer.

5. When the software upgrade was successful, remove the portable memory and restart your TV with the **POWER** button on your remote control. Your TV will start up with the new software.

Note: once the upgrade is finished use your PC to remove the TV software from your portable memory.

Settings	
Installation	Software upgrade
Language	Current softw. info
Autoprogram	Local upgrades
Weak channel inst.	
Software upgrade	
Info	

Manual software upgrade procedure

For a manual software upgrade copy the "autorun.upg" file in a directory called "Upgrades" located in the root of the portable memory.

1. Insert the portable memory that contains the downloaded software upgrade.
2. Select **Software Upgrade** in the Installation menu. Go to **Local upgrades**. The TV will list all compatible software available on the portable memory and display the data for each selected upgrade version.
3. Select the correct upgrade version and press the red color button to start the upgrade. Your TV will restart and will automatically go to the upgrade mode. After a few seconds it will display the status of the upgrade procedure.

Warning: if you try to upgrade to a software version equal or lower than the current version, a confirmation will be asked. Downgrading to older software should only be done in case of real necessity.

4. When the software upgrade was successful, remove the portable memory and restart your TV with the **POWER** button on your remote control. Your TV will start up with the new software.



Annex 2 - Philips TV-Slideshow Format with background music

Notes:

- the latest version of this document can be found on the Philips support website (www.philips.com/support).
Use the type number of your TV to find this documentation and other related files.
- Philips can't be held responsible for any problems that may occur as a result of the content in this document. Errors reported to Philips will be adapted and published on the Philips support website as soon as possible.

Introduction

This document explains how to make a Philips slideshow file with background audio. Be aware that the content of this document is addressing technical or software skilled users. To start the slideshow open the slideshow file in the Multimedia browser of your TV.

1. Press the  button on the remote control after having inserted a USB device and switched on the TV.
2. Select **Multimedia** and press the cursor right.
3. Go to where you stored the slideshow file (.alb) on your portable memory.
4. Select the slideshow file and press the **OK** button to start the slide show.
5. To stop a slide show, press the  button.

General Rules

- The slideshow will use plain ASCII XML syntax to allow the creation and editing of the slideshow files using simple tools.
- All references to network content must be based on the global address of the content.
- Content on a Portable Memory (PM) doesn't have a global address; as a result content from a PM can never be referenced from a slideshow not stored on the PM itself.
- To maintain portability, a slideshow stored on a PM should **ONLY** reference content on the same PM. Referencing global addresses can result in inconsistencies if the PM is used on a non-networked CE device. The latter is however not forbidden, it is only a recommendation.
- It is preferable that URL's referencing PM content are based on a relative path starting from the directory where the slideshow is stored. This path includes the device or drive name of the PM. An absolute path to content will also be supported.
 - relative path: pictures\test1.jpg, tamper.jpg, ..\new\bird.jpg, ...
 - absolute path: USB1:\pictures1\foo_bar.jpg, C:\f1.jpg, \organization.jpg, ...

General Format

The format and syntax below will be used to create the slideshow file (simple ascii text) with the extension .alb (.ALB). Examples: slshow1.alb, summer_holiday_2004.ALB, test.alb, ...
The following syntax should be used to create the text file:

```
<?xml version="1.0" encoding="ISO-885h9-1" ?>
<philips-slideshow version="1.0" >
  <title>Title of the slideshow</title>
  <audio>audio_url</audio>
  <slide-duration>30</slide-duration>
  <slides>
    <slide>slide_1_url</slide>
    <slide>slide_2_url</slide>
    <slide>slide_3_url</slide>
    <slide>slide_4_url</slide>
    <slide>slide_5_url</slide>
    <slide>slide_6_url</slide>
    ...
    <slide>slide_N-1_url</slide>
    <slide>slide_N_url</slide>
  </slides>
</philips-slideshow>
```

Annex 2 (Continued)

Supported XML-tags

The following table gives a description of the XML syntax.

Tag Name	Use	Description
philips-slideshow	mandatory	Philips slideshow signature including the version.
title	optional	The title of the playlist.
audio	optional	The audio-URL following this tag will define the music playing in the background during the slideshow. A single song or playlist (.m3u & .pls) are the only valid audio references. Other reference will not result in any audio playback. If a single song is referenced the song will be repeated forever. If a playlist is referenced the playlist will be played in sequence with a repeat at the end of the playlist.
slide-duration	optional	The default display time (in 0,1 second) of a slide. The TV application isn't obliged to support this tag. The TV application can force the use of one or multiple predefined display times.
slides	mandatory	Identifies the slides to show.
slide	optional	Identifies the URL of the individual slide.

Notes:

- the latest version of this document can be found on the Philips support website (www.philips.com/support);
- the software of your TV is upgradeable. If you have problems first check if you have the latest software installed on your TV. The latest software, together with instructions, can be found on the Philips support website. Use the type number of your TV to find this documentation and other related files.
- Philips can't be held responsible neither for any errors in the content of this document nor for any problems as a result of the content in this document. Errors reported to Philips will be adapted and published on the Philips support website as soon as possible.

Digital Camera Issues

If a USB connection between your digital camera and the TV isn't working, you can try the solutions below to resolve your problem.

- o Make sure your digital camera is switched on and verify if the configuration of your digital camera is correct (see the manual of your digital camera for more information).
- o Some digital cameras allow you to switch off the USB interface. Make sure that the USB interface is switched on before connecting to the TV.
- o If you have a digital camera with only internal memory (no removable memory) you can try to copy the content manually to a USB memory device using a personal computer.
- o Some digital cameras allow you to switch between PTP (Picture Transfer Protocol) or "PC Link" and USB Mass Storage. Make sure that you select USB Mass Storage or "PC Drive" on your digital camera.
- o If your camera supports different interface settings be sure to try them one by one or contact the reseller of your camera to find out the correct setting.

USB Memory Device Issues

- o Devices connected to the USB port of your TV must be "Mass Storage Class" compliant. If your device (digital camera, MP3 player, portable harddisk, ...) is not "Mass Storage Class" compliant it will not be detected by the content browser of the TV.
- o The following subsets of the Mass Storage Class specification are supported:
 - The implementation of the TV is based on the "Universal Serial Bus Mass Storage Class Specification Overview" (v1.2, June 23, 2003) including all documents referenced by the document. The document can be found on the USB standardization website (www.usb.org).
 - Full support of the USB Mass Storage Class Bulk-Only Transport (bInterfaceProtocol = 50h).
 - Full support of SubClass Code = 05h; SFF-8070i spec.
 - Full support of SubClass Code = 06h; SCSI transparent command set.
- o For large USB memory devices, when you are in the Content Browser, it may take a long time before you can access your files.
- o When using a USB portable harddisk: Due to the high power consumption of the harddisk, it is advised to use the external power supply of the portable harddisk to guarantee proper working under all conditions.

Annex 4 - Issues referring to connected equipment with a HDMI connector

The **HDMI IN** connector allows the following TV and monitor display modes:

HD	Standard Definition TV (SDTV)	640x480i 720x480i
	Enhanced Definition TV (EDTV)	640x480p 720x480p
	High Definition TV (HDTV)	1920x1080i 1280x720p
PC	VGA	640x480
	SVGA	800x600
	XGA	1024x768

- If necessary, you can adjust the picture position to the centre of the screen with the cursor buttons.
- Due to legal requirements, it is possible that with certain copy protected PCM audio qualities from a peripheral equipment connected to the **HDMI** input, the Digital audio output signal is muted.
- Your TV supports HDCP (High-bandwidth Digital Content Protection). This is a system for protecting DVD content outputted via HDMI from being copied. It provides a secure digital link between a video source (DVD, PC, etc.) and your TV. Content is encrypted at the source peripheral equipment to prevent unauthorised copies from being made.
- Proper working is only guaranteed with HDMI compliant consumer products.
- Digital peripheral equipments from different manufacturers have the possibility of differing output standards which may cause difficulties for the television to properly display.
- In case no signal is detected from your HDMI equipment, turn off the HDMI equipment and then on again.

To get an optimal viewing, it is advised to switch your DVD player, Blu-Ray or HD cable box to the highest possible supported display modes.

Index

active control.....	25	favorite button.....	7	source.....	22
adjust picture menu settings ..	24	first time installation	11	standby button.....	6
adjust sound menu settings.....	26	game.....	36	store channels.....	14
adjust features menu settings.....	27	getting started.....	3-4	time zone selection	23
alternate audio	26	glossary	48	tint.....	25
antenna	4	HDMI connector	44,54	turn the tv on.....	11
audio/video equipment		headphone.....	36	tv menu settings.....	23
buttons	46	headphone volume	26	tv ratings lock.....	28
audio/video connections	35	installation menu	13	usb connector.....	36
autoprogram	14	kensington security lock.....	57	usb device.....	32
auto picture.....	24	language.....	13	volume.....	7
auto surround.....	18	lock after.....	28	vcr	38
auto sound	26	menu button	12	weak channel installation	16
avl (audio volume leveller).....	27	movie ratings lock	30		
balance.....	26	multimedia browser	32		
batteries.....	5,57	mute button	7		
before calling service	47	navigate through the			
brightness	24	menus	12-13		
cable	4	ok button	6		
camera.....	36	pc.....	44		
camcorder	36	picture format	8,25		
captions service.....	18	pin code	21		
captions options.....	19	pixel plus.....	25		
care of the screen.....	2	preferences menu	17		
change pin.....	21	preferred channels.....	31		
channel list.....	33	rating table	19		
channel lock	28	rear panel overview	37		
channel tuning.....	15	record a TV program	46		
clear regions ratings	31	recorder	38-40,42		
clock	6, 22	recycling	56		
closed captions.....	27	region ratings lock.....	31		
code setup.....	21	remote control	5-8		
color	24	reset av settings	21		
color enhancement.....	25	safety warnings	2		
color buttons	6	satellite receiver	41,42		
color temperature	24	select your connections	35		
comp. video connectors	38-44	select connected devices	45		
connections	36	set pin.....	21		
contrast.....	24	side connectors.....	36		
cursor buttons.....	7	sharpness	24		
daylight saving	23	sleeptimer.....	27		
delta volume.....	27	slideshow format.....	51		
demo.....	13	software upgrade.....	16,49		
digital audio language	27	sound mode	26		
digital processing.....	25				
digital surround receiver	45				
DNR	25				
DVD player.....	43				
DVD recorder	38				
dynamic contrast.....	25				
emergency alert signalling.....	20				

Recycling

Recycling

 The packaging of this product is intended to be recycled. Apply to the local authorities for correct disposal.

Disposal of your old product

Your product is designed and manufactured with highly quality material and components, which can be recycled and reused.

Please inform yourself about the local separate collection system for electrical and electronic products. Please act according to your local rules and do not dispose of your old products with your normal household waste.

The correct disposal of your old product will help prevent potential negative consequences for the environment and human health.

Disposal of batteries

The batteries supplied do not contain the heavy metals mercury and cadmium. Please check on how to dispose of exhausted batteries according to local regulations.

Regulatory Notices - Federal Communications Commission Notice

This equipment has been tested and found to comply with the limits for a Class B digital device, pursuant to part 15 of the FCC Rules. These limits are designed to provide reasonable protection against harmful interference in a residential installation. This equipment generates, uses, and can radiate radio frequency energy and, if not installed and used in accordance with the instructions, may cause harmful interference to radio communications. However, there is no guarantee that interference will not occur in a particular installation. If this equipment does cause harmful interference to radio or television reception, which can be determined by turning the equipment off and on, the user is encouraged to try to correct the interference by one or more of the following measures:
Reorient or relocate the receiving antenna.
Increase the separation between the equipment and the receiver.
Connect the equipment into an outlet on a circuit different from that to which the receiver is connected.
Consult the dealer or an experienced radio or television technician for help.

Modifications -

The FCC requires the user to be notified that any changes or modifications made to this device that are not expressly approved by Philips Consumer Electronics may void the user's authority to operate the equipment.

Cables -

Connections to this device must be made with shielded cables with metallic RFI/EMI connector hoods to maintain compliance with FCC Rules and Regulations.

Canadian notice -

This Class B digital apparatus meets all requirements of the Canadian Interference-Causing Equipment Regulations.

Avis Canadien -

Cet appareil numérique de la classe B respecte toutes les exigences du Règlement sur le matériel brouilleur du Canada.

- Specifications: see the product leaflet on www.philips.com/support.
- If you need further assistance, please call the customer support service in your country.
The corresponding telephone numbers and addresses are given in the supplied Worldwide guarantee booklet.

Plasma display characteristics

A Plasma display is designed to be used at altitudes up to 6562 ft above sea level (and/or local air pressure equal or above

800 hPa). Operating this set at higher altitude (lower air pressure) is possible. However, at high altitudes (or local air pressure equal or below 800 hPa) the picture on this display may become unstable and picture performance can deteriorate. In addition, the plasma display may produce a humming sound in these conditions.

These possible adverse effects relate to the altitude and are common of all plasma displays. Once the set is brought below approx 6562 ft (and/or local air pressure equal or above 800 hPa) its function will most likely return to normal.

Note: Transportation at high altitudes has no negative effect on the set or picture performance.



Kensington Security Slot (if present)

Your TV is equipped with a Kensington Security Slot, to prevent it from getting stolen. An anti-theft Kensington lock has to be purchased separately. The Kensington lock is a plastic-coated steel cable with a lock. One end has to be fixed to the opening of the TV and locked with a special button. The other end is attached to a fixed point.

® Kensington and MicroSaver are registered US trademarks of ACCO World Corporation with issued registrations and pending applications in other countries throughout the world. All other registered and unregistered trademarks are the property of their respective owners.

PHILIPS LIMITED WARRANTY ONE (1) YEAR

WARRANTY COVERAGE:

PHILIPS warranty obligation is limited to the terms set forth below.

WHO IS COVERED:

Philips warrants the product to the original purchaser or the person receiving the product as a gift against defects in materials and workmanship as based on the date of original purchase ("Warranty period") from an Authorized Dealer. The original sales receipt showing the product name and the purchase date from an authorized retailer is considered such proof.

WHAT IS COVERED:

The Philips warranty covers new products if a defect arises and a valid claim is received by Philips within the Warranty Period.

At its option, Philips will either (1) repair the product at no charge, sing new or refurbished replacement parts, or (2) exchange the product with a product that is new or which has been manufactured from new, or serviceable used parts and is at least functionally equivalent or most comparable to the original product in Philips current inventory, or (3) refund the original purchase price of the product.

Philips warrants replacement products or parts provided under this warranty against defects in materials and workmanship from the date of the replacement or repair for ninety (90) days or for the remaining portion of the original product's warranty, whichever provides longer coverage for you. When a product or part is exchanged, any replacement item becomes your property and the replaced item becomes Philips' property.

When a refund is given, your product becomes Philips' property.

Note: Any product sold and identified as refurbished or renewed carries a ninety (90) day limited warranty.

Replacement product can only be sent if all warranty requirements are met. Failure to follow all requirements can result in delay.

WHAT IS NOT COVERED - EXCLUSIONS AND LIMITATIONS

This Limited Warranty applies only to the new products manufactured by or for Philips that can be identified by the trademark, trade name, or logo affixed to it. This Limited Warranty does not apply to any non-Philips hardware product or any software, even if packaged or sold with the product. Non-Philips manufacturers, suppliers, or publishers may provide a separate warranty for their own products packaged with the bundled product.

Philips is not liable for any damage to or loss of any programs, data, or other information stored on any media contained within the product, or any non-Philips product or part not covered by this warranty. Recovery or reinstallation of programs, data or other information is not covered under this Limited Warranty.

This warranty does not apply (a) to damage caused by accident, abuse, misuse, misapplication, or non-Philips product, (b) to damage caused by service performed by anyone other than Philips or Philips Authorized Service Location, (c) to a product or a part that has been modified without the written permission of Philips, or (d) if any Philips serial number has been removed or defaced, or (e) product, accessories or consumables sold "AS IS" without warranty of any kind by including refurbished Philips product sold "AS IS" by some retailers.

This Limited Warranty does not cover:

- Shipping charges to return defective product to Philips.
- Labor charges for installation or setup of the product, adjustment of customer controls on the product, and installation or repair of antenna systems outside of the product.
- Product repair and/or part replacement because of improper installation, connections to improper voltage supply, abuse, neglect, misuse, accident, unauthorized repair or other cause not within the control of Philips.
- Damage or claims for products not being available for use, or for lost data or lost software.
- Damage occurring to product during shipping.
- A product that requires modification or adaptation to enable it to operate in any country other than the country for which it was designed, manufactured, approved and/or authorized, or repair of products damaged by these modifications.
- A product used for commercial or institutional purposes (including but not limited to rental purposes).
- Product lost in shipment and no signature verification receipt can be provided.
- Failure to operate per Owner's Manual.

TO OBTAIN ASSISTANCE IN THE U.S.A., PUERTO RICO, OR U.S. VIRGIN ISLANDS....

Contact Philips Customer Care Center at:
1-888-PHILIPS (1-888-744-5477)

TO OBTAIN ASSISTANCE IN CANADA....

1-800-661-6162 (French speaking)
1-888-PHILIPS (1-888-744-5477) (English or Spanish speaking)

REPAIR OR REPLACEMENT AS PROVIDED UNDER THIS WARRANTY IS THE EXCLUSIVE REMEDY FOR THE CONSUMER. PHILIPS SHALL NOT BE LIABLE FOR ANY INCIDENTAL OR CONSEQUENTIAL DAMAGES FOR BREACH OF ANY EXPRESS OR IMPLIED WARRANTY ON THIS PRODUCT. EXCEPT TO THE EXTENT PROHIBITED BY APPLICABLE LAW, ANY IMPLIED WARRANTY OF MERCHANT ABILITY OR FITNESS FOR A PARTICULAR PURPOSE ON THIS PRODUCT IS LIMITED IN DURATION TO THE DURATION OF THIS WARRANTY.

Some states do not allow the exclusions or limitation of incidental or consequential damages, or allow limitations on how long an implied warranty lasts, so the above limitations or exclusions may not apply to you.

This warranty gives you specific legal rights. You may have other rights which vary from state/province to state/province.

Philips, P.O. Box 671539, Marietta, GA. 30006-0026