



DLP Projection TV OWNER'S MANUAL

**MODELS: 52SX4D / 62SX4D
52SX4D-UB / 62SX4D-UB**



Please read this manual carefully and completely before operating your TV.

Retain this manual for future reference.

Record model number and serial number of the TV in the spaces provided below.

See the label attached on the back cover and relate this information to your dealer if you require service.

Model Number :

Serial Number :

Warning/Caution



WARNING/CAUTION
RISK OF ELECTRIC SHOCK
DO NOT OPEN



WARNING/CAUTION:

TO REDUCE THE RISK OF ELECTRIC SHOCK DO NOT REMOVE COVER (OR BACK). NO USER SERVICEABLE PARTS INSIDE. REFER TO QUALIFIED SERVICE PERSONNEL.



The lightning flash with arrowhead symbol, within an equilateral triangle, is intended to alert the user to the presence of uninsulated "dangerous voltage" within the product's enclosure that may be of sufficient magnitude to constitute a risk of electric shock to persons.



The exclamation point within an equilateral triangle is intended to alert the user to the presence of important operating and maintenance (servicing) instructions in the literature accompanying the appliance.

WARNING/CAUTION:

TO PREVENT FIRE OR SHOCK HAZARDS, DO NOT EXPOSE THIS PRODUCT TO RAIN OR MOISTURE.

POWER CORD POLARIZATION:

CAUTION: TO PREVENT ELECTRIC SHOCK, MATCH WIDE BLADE OF PLUG TO WIDE SLOT, FULLY INSERT.

ATTENTION: POUR ÉVITER LES CHOCS ÉLECTRIQUES, INTRODUIRE LA LAME LA PLUS LARGE DE LA FICHE DANS LA BORNE CORRESPONDANTE DE LA PRISE ET POUSSER JUSQU'AU FOND.

NOTE TO CABLE/TV INSTALLER:

This reminder is provided to call the CATV system installer's attention to Article 820-40 of the National Electric Code (U.S.A.). The code provides guidelines for proper grounding and, in particular, specifies that the cable ground shall be connected to the grounding system of the building, as close to the point of the cable entry as practical.

REGULATORY INFORMATION:

This equipment has been tested and found to comply with the limits for a Class B digital device, pursuant to Part 15 of the FCC Rules. These limits are designed to provide reasonable protection against harmful interference in a residential installation. This equipment generates, uses and can radiate radio frequency energy and, if not installed and used in accordance with the instructions, may cause harmful interference to radio communications. However, there is no guarantee that interference will not occur in a particular installation. If this equipment does cause harmful interference to radio or television reception, which can be determined by turning the equipment off and on, the user is encouraged to try to correct the interference by one or more of the following measures:

- Reorient or relocate the receiving antenna.
- Increase the separation between the equipment and receiver.
- Connect the equipment into an outlet on a circuit different from that to which the receiver is connected.
- Consult the dealer or an experienced radio/TV technician for help.

Any changes or modifications not expressly approved by the party responsible for compliance could void the user's authority to operate the equipment.

CAUTION:

Do not attempt to modify this product in any way without written authorization from LG Electronics. Unauthorized modification could void the user's authority to operate this product.

COMPLIANCE:

The responsible party for this product's compliance is:

LG Electronics U.S.A., Inc

1000 Sylvan Avenue, Englewood Cliffs, NJ 07632

1-800-243-0000

<http://www.lgusa.com>

TV Guide On Screen Notices for U.S.A.

Trademark Notice

In the United States, TV GUIDE and other related marks are registered marks of Gemstar-TV Guide International, Inc. and/or one of its affiliates. In Canada, TV GUIDE is a registered mark of Transcontinental Inc., and is used under license by Gemstar-TV Guide International, Inc.

Aux Etats Unis TV GUIDE et d'autres marques relatives sont des marques déposées de Gemstar-TV Guide International, Inc. et/ou d'une de ses sociétés affiliées. Au Canada TV GUIDE est une marque déposée de Transcontinental Inc., utilisée sous licence de Gemstar-TV Guide International, Inc.

License Notice

The TV Guide On Screen system is manufactured under license from Gemstar-TV Guide International, Inc. and/or one of its affiliates.

Le système TV Guide On Screen est fabriqué sous licence de Gemstar-TV Guide International, Inc. et/ou d'une de ses sociétés affiliées.

Patent Notice

The TV Guide On Screen system is protected by one or more of the following issued United States patents 6,498,895, 6,418,556, 6,331,877; 6,239,794; 6,154,203; 5,940,073; 4,908,713; 4,751,578; 4,706,121.

Le système TV Guide On Screen est protégés par un ou plusieurs brevets émis aux Etats Unis, comme le 6,498,895, 6,418,556, 6,331,877; 6,239,794; 6,154,203; 5,940,073; 4,908,713; 4,751,578; 4,706,121.

Use of the CableCARD™ TradeMark.

“CableCARD™ is a trademark of Cable Television Laboratories, Inc.”

Digital Cable Compatibility

This digital television is capable of receiving basic analog, digital basic and digital premium cable television programming by direct connection to a cable system providing such programming. A security card provided by your cable operator is required to view encrypted digital programming. Certain advanced interactive digital cable services such as video-on-demand, cable operator enhanced program (For example, electronic program guide provided by the cable operator), and data enhanced television service may require the use of a set top box. For more information contact your local cable operator.

Safety Instructions

IMPORTANT SAFETY INSTRUCTIONS

Important safety instructions shall be provided with each apparatus. This information shall be given in a separate booklet or sheet, or be located before any operating instructions in an instruction for installation for use and supplied with the apparatus. This information shall be given in a language acceptable to the country where the apparatus is intended to be used. The important safety instructions shall be entitled "Important Safety Instructions". The following safety instructions shall be included where applicable, and, when used, shall be verbatim as follows. Additional safety information may be included by adding statements after the end of the following safety instruction list. At the manufacturer's option, a picture or drawing that illustrates the intent of a specific safety instruction may be placed immediately adjacent to that safety instruction :

1. **Read these instructions.**
2. **Keep these instructions.**
3. **Heed all warnings.**
4. **Follow all instructions.**
5. **Do not use this apparatus near water.**
6. **Clean only with dry cloth.**
7. **Do not block any ventilation openings. Install in accordance with the manufacturer's instructions.**
8. **Do not install near any heat sources such as radiators, heat registers, stoves, or other apparatus (including amplifiers) that produce heat.**
9. **Do not defeat the safety purpose of the polarized or grounding-type plug. A polarized plug has two blades with one wider than the other. A grounding type plug has two blades and a third grounding prong. The wide blade or the third prong are provided for your safety. If the provided plug does not fit into your outlet, consult an electrician for replacement of the obsolete outlet.**
10. **Protect the power cord from being walked on or pinched particularly at plugs, convenience receptacles, and the point where they exit from the apparatus.**
11. **Only use attachments/accessories specified by the manufacturer.**
12. **Use only with the cart, stand, tripod, bracket, or table specified by the manufacturer, or sold with the apparatus. When a cart is used, use caution when moving the cart/apparatus combination to avoid injury from tip-over.**



PORTABLE CART WARNING

13. Unplug this apparatus during lightning storms or when unused for long periods of time.

14. Refer all servicing to qualified service personnel. Servicing is required when the apparatus has been damaged in any way, such as power-supply cord or plug is damaged, liquid has been spilled or objects have fallen into the apparatus, the apparatus has exposed to rain or moisture, does not operate normally, or has been dropped.

15. CAUTION concerning the Power Cord :

Most appliances recommend they be placed upon a dedicated circuit; that is, a single outlet circuit which powers only that appliance and has no additional outlets or branch circuits. Check the specification page of this owner's manual to be certain.

Do not overload wall outlets. Overloaded wall outlets, loose or damaged wall outlets, extension cords, frayed power cords, or damaged or cracked wire insulation are dangerous. Any of these conditions could result in electric shock or fire. Periodically examine the cord of your appliance, and if its appearance indicates damage or deterioration, unplug it, discontinue use of the appliance, and have the cord replaced with an exact replacement part by an authorized servicer.

Protect the power cord from physical or mechanical abuse, such as being twisted, kinked, pinched, closed in a door, or walked upon. Pay particular attention to plugs, wall outlets, and the point where the cord exits the appliance.

16. Outdoor Use Marking :

WARNING - To Reduce The Risk Of Fire Or Electric Shock, Do Not Expose This Appliance To Rain Or Moisture.

17. Wet Location Marking :

Apparatus shall not be exposed to dripping or splashing and no objects filled with liquids, such as vases, shall be placed on the apparatus.

Contents

| | |
|--|----------|
| Warnings/Caution | .2 |
| Digital Cable Compatibility | .3 |
| Safety Instructions | .4~5 |
| Introduction | |
| Controls | .7 |
| Connection Options | .8~9 |
| Remote Control Key Functions | .10~11 |
| Installation | |
| External Equipment Connections | .12~30 |
| Antenna or Cable Connection | .12 |
| VCR Setup | .13 |
| External A/V Source Setup | .14 |
| DVD Setup | .14 |
| CableCARD™ Setup | .15 |
| HDSTB Setup | .15 |
| Monitor Out Setup | .15 |
| PC Setup | .16 |
| Digital Audio Output | .17 |
| External Stereo | .17 |
| HDMI | .18~20 |
| TV Guide On Screen Setup | .21~30 |
| IEEE 1394 Functions | .31~37 |
| TV Guide On Screen™ System | .38~56 |
| Operation | |
| Turning the TV On | .57 |
| TV Setup | |
| On-screen Menus Language Selection | .58 |
| Setup Menu Options | |
| EZ Scan (Channel Search) | .59 |
| Manual Scan | .59 |
| Channel Edit | .60 |
| DTV Signal Strength | .60 |
| Channel Label Setup | .61 |
| Main Picture Source Selection | .61 |
| Input Label | .61 |
| Video Menu Options | |
| EZ Picture | .62 |
| Manual Picture Control (Custom Option) | .62 |
| Color Temperature Control | .62 |
| Video Reset | .62 |
| Audio Menu Options | |
| Audio Language | .63 |
| EZ SoundRite / EZ Sound | .63 |
| Manual Sound Control (Custom Option) | .63 |
| Front Surround | .64 |
| TV Speakers On/Off Setup | .64 |
| Stereo/SAP Broadcasts Setup | .64 |
| Time Menu Options | |
| Auto Clock Setup | .65 |
| Manual Clock Setup | .65 |
| On/Off Timer Setup | .65 |
| Sleep Timer / Auto Off | .66 |
| Option Menu Options | |
| Aspect Ratio Control | .67 |
| Cinema 3:2 Mode Setup | .67 |
| Caption | .68 |
| Caption / Text | .68 |
| Caption Option | .69 |
| EZ Demo | .69 |
| Lock Menu Options | |
| Parental Lock Setup | .71 |
| CableCARD™ Function | |
| Cable menu options | .72 |
| Scrambled channel | .72 |
| Cable Channel List | .73 |
| Emergency Alert Message | .73 |
| XSTUDIO | |
| Notes on Memory Card | .74~77 |
| JPEG File Viewing Options | .78~82 |
| MP3 File Playing Operation | .83~86 |
| Remote Control | |
| PIP (Picture-in-Picture)/POP/Twin Picture | .87 |
| Watching PIP/POP/Twin Picture | .87 |
| Selecting an Input Signal Source for PIP/Twin Picture .. | .87 |
| Swapping the PIP/Twin Picture | .87 |
| TV Program Selection for PIP | .87 |
| Moving the PIP sub picture | .88 |
| Adjusting Main and Sub Picture Sizes for Twin Picture .. | .88 |
| POP (Picture-out-of-Picture: Channel Scan) .. | .88 |
| APM(Adaptive Picture Mode) | .89 |
| Brief Info. | .90 |
| EZ Mute | .91 |
| Freeze & Magnify | .91 |
| Screen Setup for PC mode | .92 |
| Programming the Remote | .93 |
| Programming Codes | .94~95 |
| Troubleshooting Checklist | .96~98 |
| Maintenance | .99 |
| Product Specifications | .100 |
| Warranty | .103~104 |

After reading this manual, keep it handy for future reference.

Introduction

Controls

- This is a simplified representation of a front panel.
- Here shown may be somewhat different from your TV.

Front Panel Controls

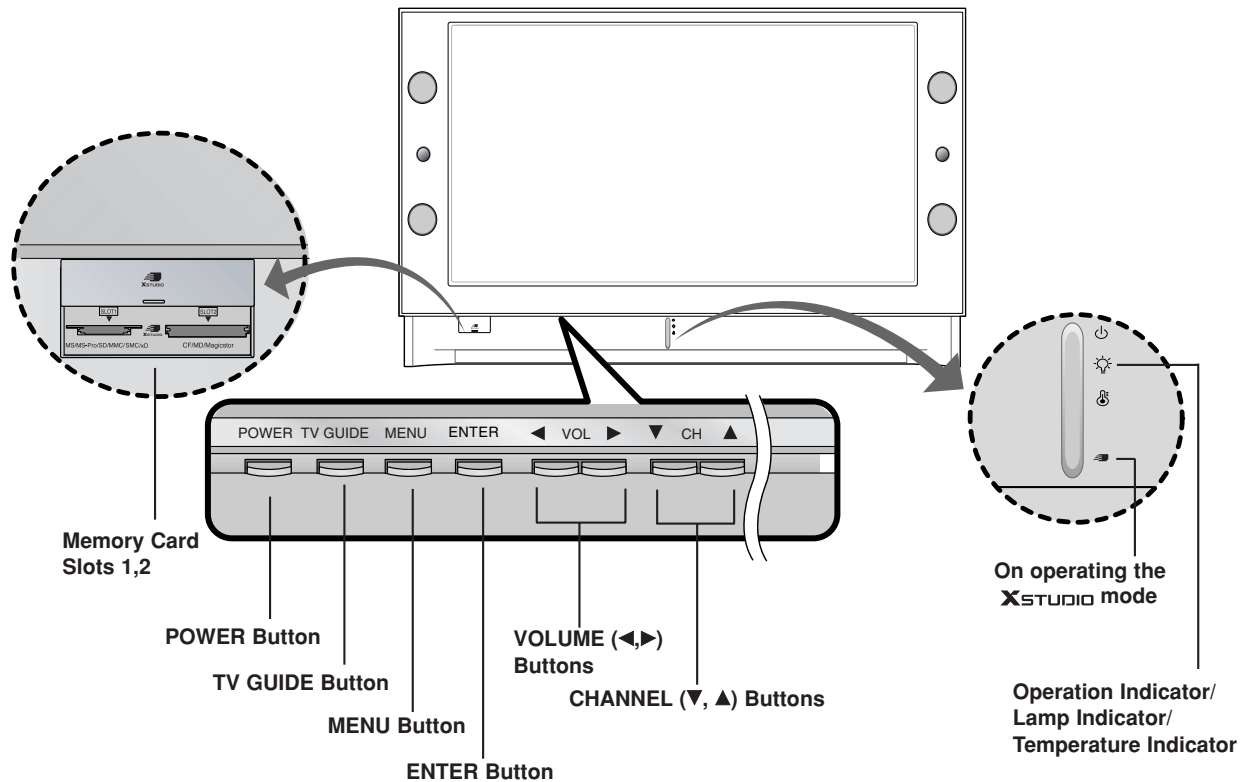

Function Status Indicators

- Lamp indicator, operation indicator, and temperature indicator located below the front panel controls, reveal the operating status of the DLP projection TV.

| | | |
|-----------------------|-----------------|--|
| Operation Indicator | Off | Power Cord is not connected. |
| | Red | Power Cord is connected, TV is in standby mode. |
| | Green | TV turns on. |
| | Red (blinking) | Power Cord is connected, TV is in booting sequence. |
| Lamp Indicator | White (Rolling) | Preparing operation in standby mode. |
| | Orange | Projection lamp is reaching the end of its life and needs to be replaced with a new lamp. Contact your service center. |
| | Red (blinking) | There is a problem with the lamp or around it. Contact an authorized service center. |
| Temperature Indicator | Green | The lamp cover is not closed. |
| | Orange | The projection TV is overheating. Check the blocked vents of the Projection TV . |
| | Red | The projection TV shuts down due to overheating. |
| | Red (blinking) | The projection TV shuts down, check the cooling fan. Contact your service center. |

Connection Options

Back Connection Panel

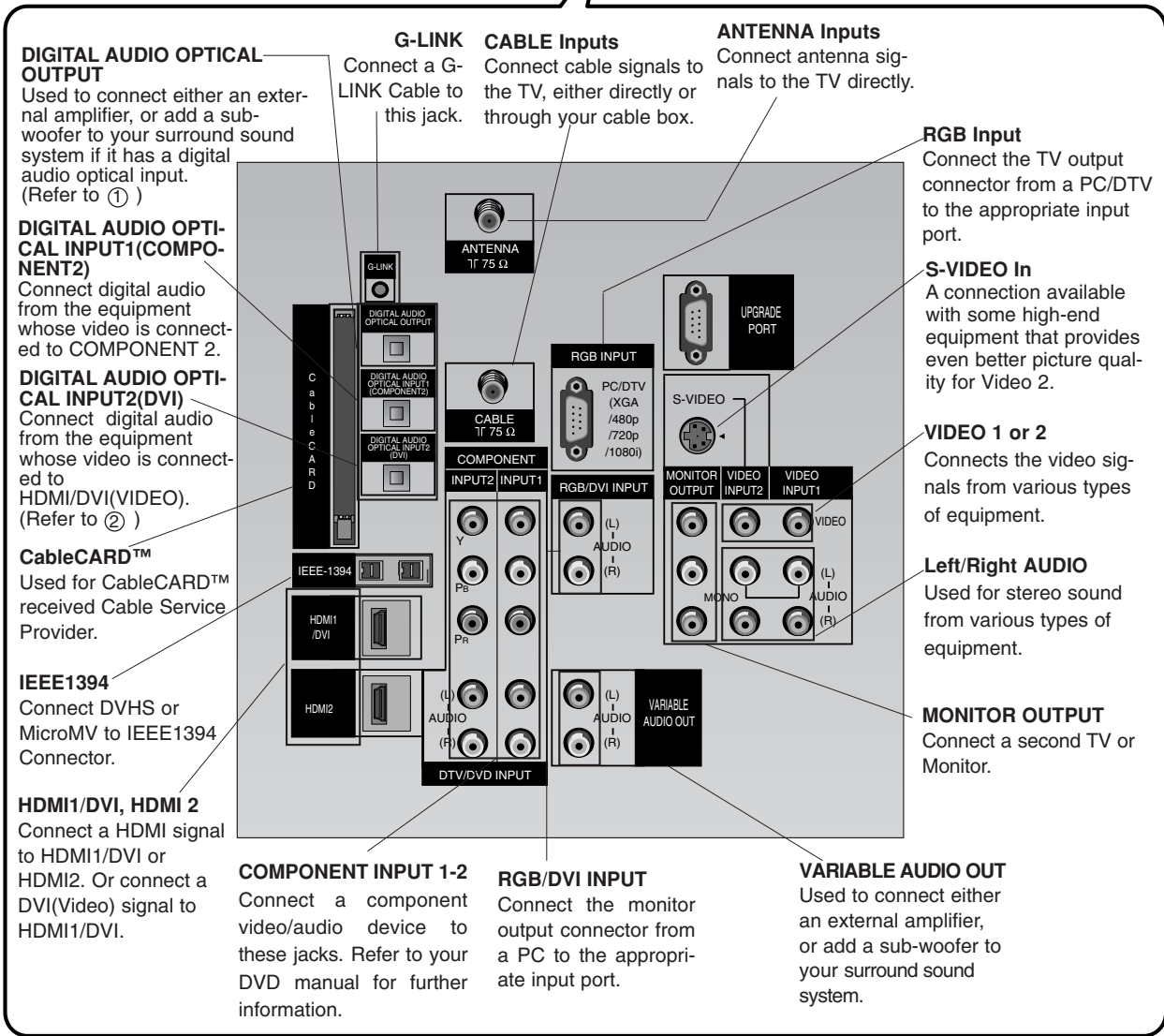
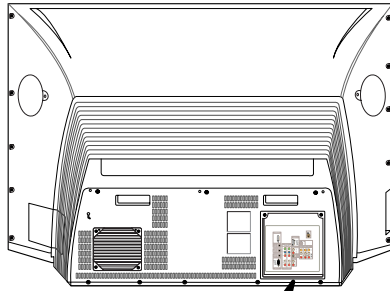

Notes: ① In standby mode, these port will not work.

② If the video is connected through HDMI-TO-HDMI cable, you don't need to connect digital audio. This port is used only when the video connected through DVI-TO-HDMI cable.

Front Connection Panel

There are four jacks on the left side on your projection TV that make connecting Audio/Video devices like video games and camcorders very simple.

The jacks are like those found on the back jack connection panel. This means that most equipment that connects to those types of jacks on the rear jackpack, may be connected to the front connection panel.

To use the side jacks as the signal source, select them using Main Input menu as described on page 61. They will be named "Front Video" in the Main Input menu.

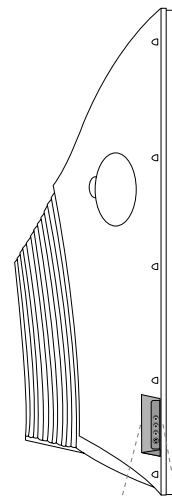

If you input both Front Video and S-Video, only the S-Video will work.



If you're connecting a video game device, make sure to change the picture settings with the EZ Picture option in the Video menu (see page 62).

LEFT/RIGHT AUDIO

Used for stereo sound from various types of equipment.

VIDEO

Connects the video signals from any piece of equipment.

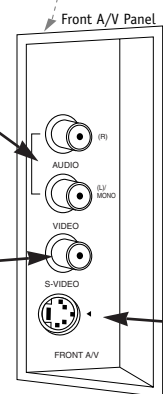

S-VIDEO

A connection available on some very high-end equipment that provides better picture quality than video input.

Mini glossary

A/V CABLES Audio/Video cables. Three cable connector—Right audio (red), Left audio (white), and Video (yellow). A/V cables are used for stereo playback of videocassettes and for higher quality picture and sound from other A/V devices.

A/V DEVICE Any device that produces video or sound (VCR, DVD, cable box, or television).

Remote Control Key Functions

- When using the remote control, aim it at the remote control sensor on the TV.

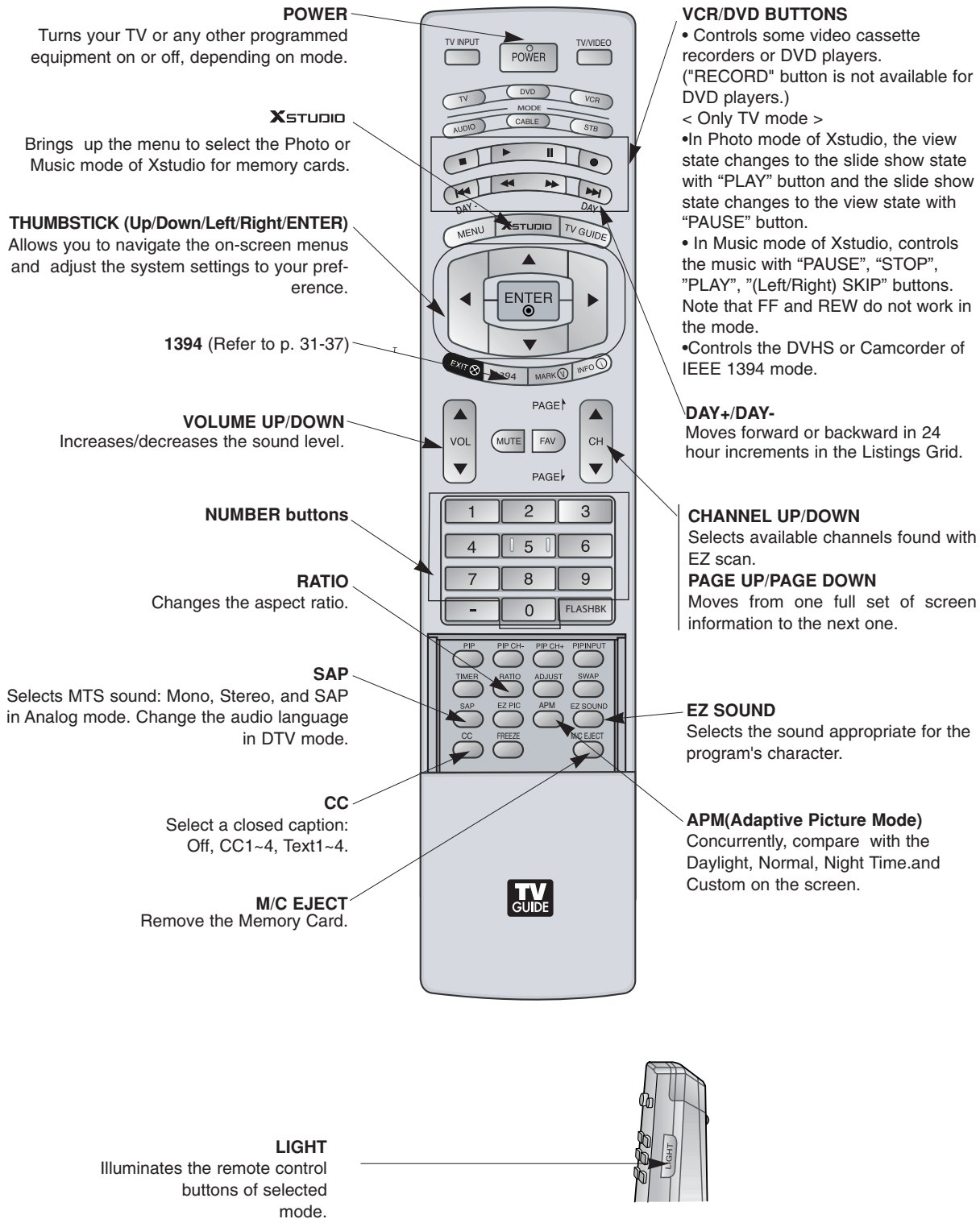

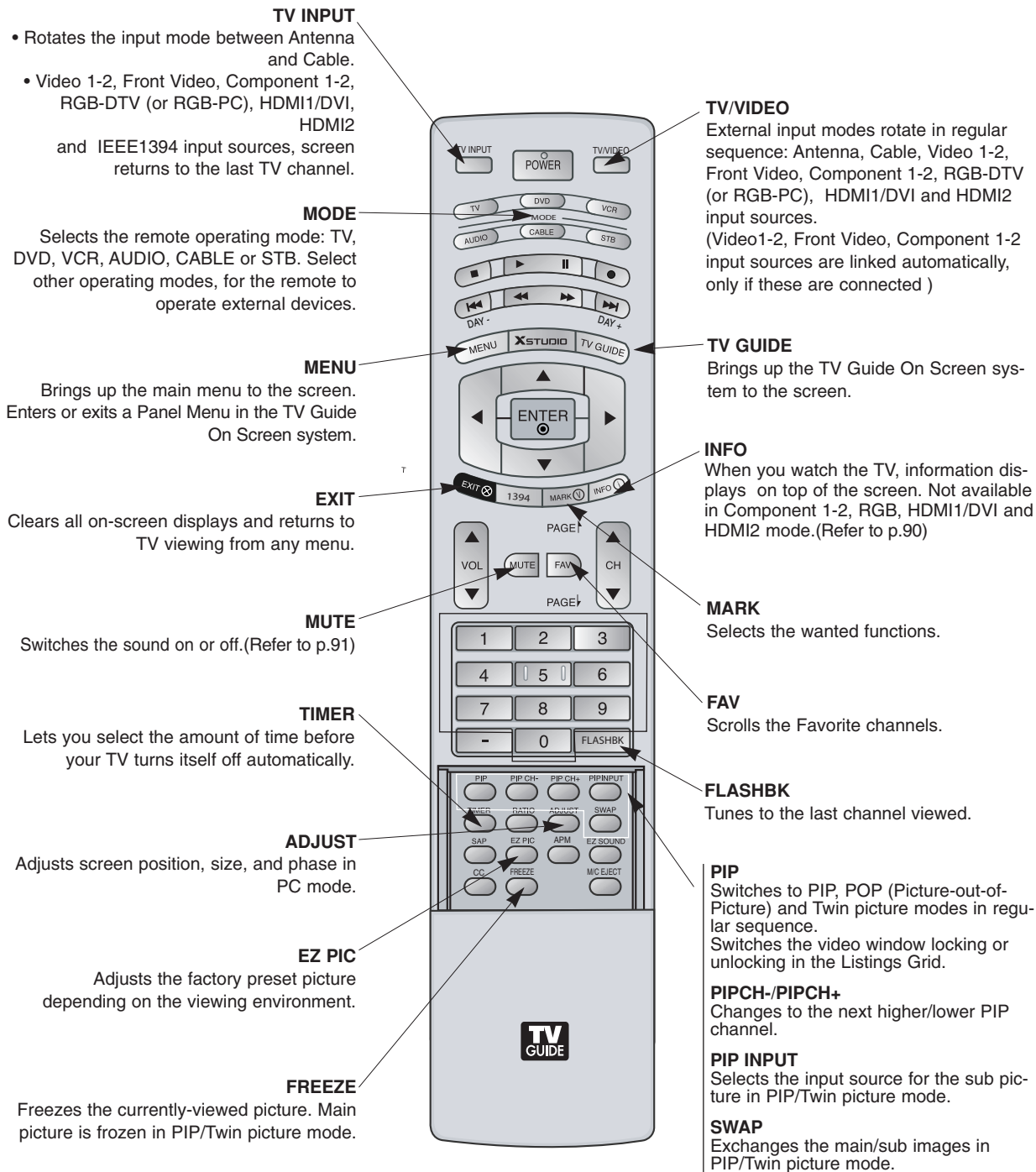

Installing Batteries

- Open the battery compartment cover on the back side and install the batteries matching correct polarity (+ with +, - with -).
- Install two 1.5V AA batteries. Don't mix old or used batteries with new ones. Replace cover.

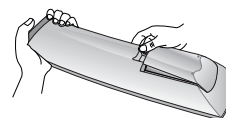

Installation

External Equipment Connections

Antenna or Cable Connection

1. Analog and Digital TV signals provided on antenna

- Wall Antenna Socket or Outdoor Antenna without a Cable Box Connections
- For optimum picture quality, adjust antenna direction if needed.

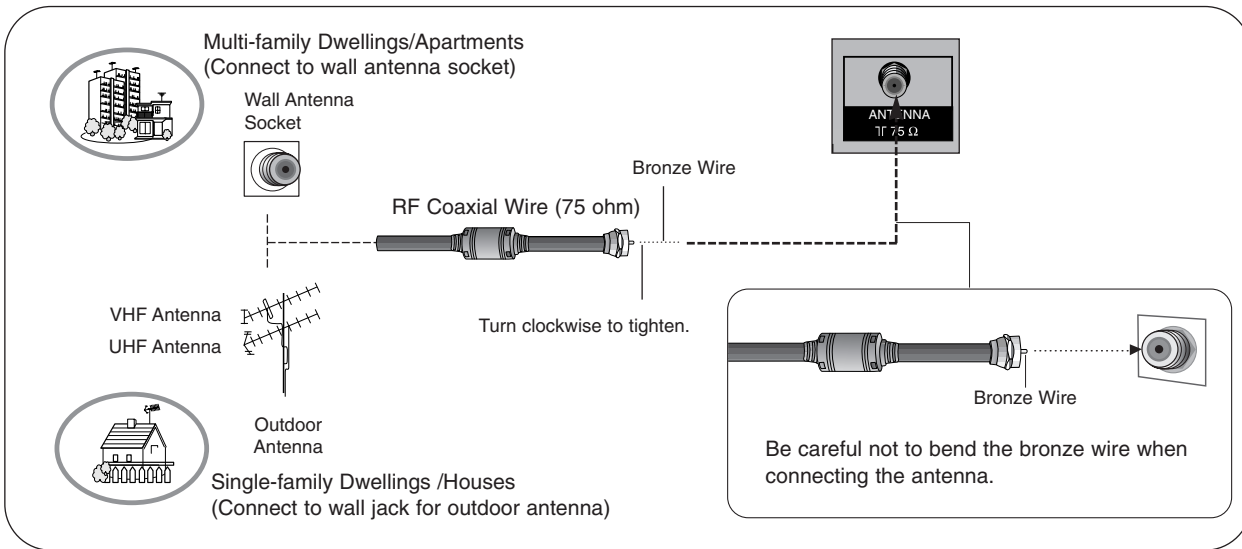

2. Analog and Digital TV signals provided on cable

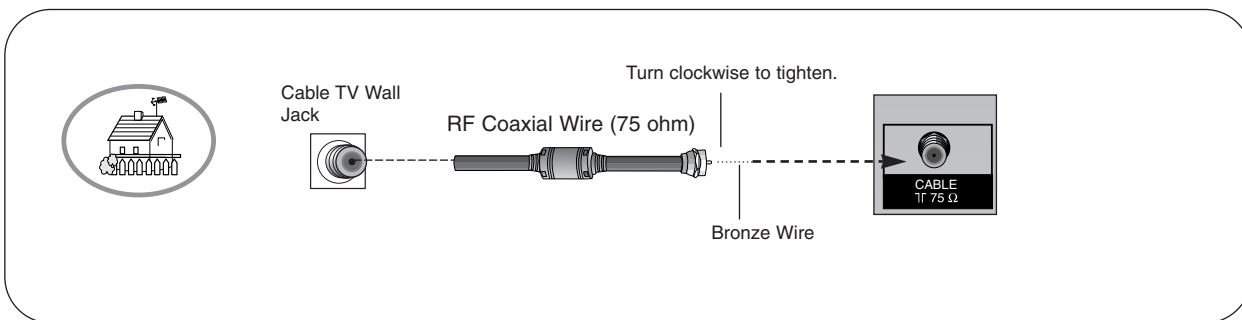

3. Analog and Digital TV signals provided on cable and antenna

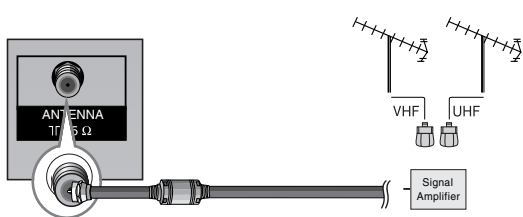
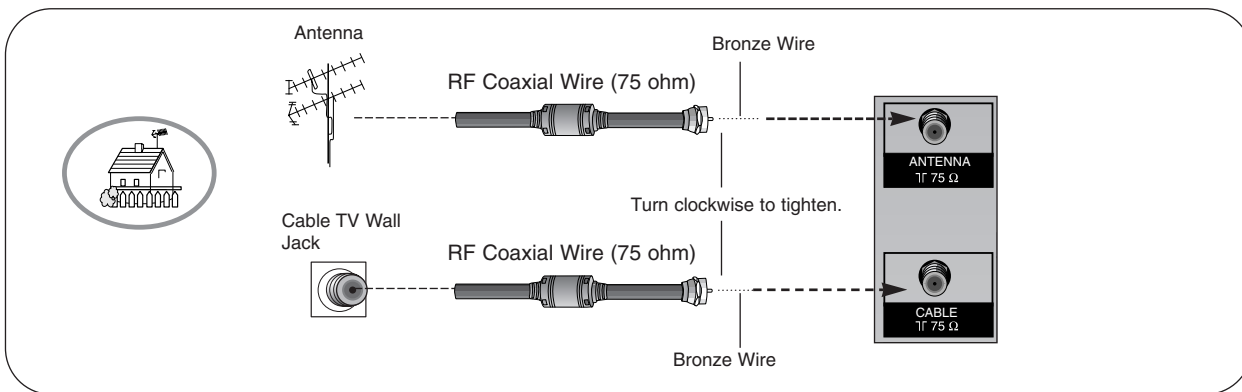

- To improve the picture quality in a poor signal area, please purchase a signal amplifier and install properly.
- If the antenna needs to be split for two TV's, install a "2-Way Signal Splitter" in the connections.
- If the antenna is not installed properly, contact your dealer for assistance.

Note: The TV will let you know when the TV(analog antenna), DTV(digital antenna), CATV(analog cable) and CADTV(digital cable) channel scans are complete.

VCR Setup

Connection Option 1

Set VCR output switch to channel 3 or 4 and then tune the TV to the same channel number.

Connection Option 2

1. Connect the audio and video cables from the VCR's output jacks to the TV input jacks, as shown in the figure. When connecting the TV to VCR, match the jack colors (Video = yellow, Audio Left = white, and Audio Right = red). If you connect an S-VIDEO output from VCR to the S-VIDEO input, the picture quality is improved; compared to connecting a regular VCR to the Video input.
2. Insert a video tape into the VCR and press PLAY on the VCR. (Refer to the VCR owner's manual.)
3. Select the input source with using the **TV/VIDEO** button on the remote control. Note that this TV finds the connected input sources automatically for Video, Front Video and Component 1-2. It is presumed that RGB, HDMI1/DVI and HDMI2 sources are connected.



Do not connect to both Video and S-Video at the same time. In the event that you connect both Video and the S-Video cables, only the S-Video will work.)

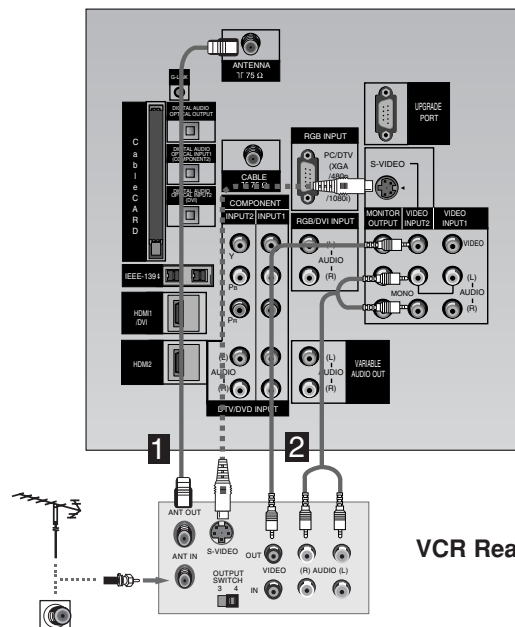

External A/V Source Setup

How to connect

Connect the audio and video cables from the external equipment's output jacks to the TV input jacks, as shown in the figure.

When connecting the TV to external equipment, match the jack colors (Video = yellow, Audio Left = white, and Audio Right = red).

How to use

1. Select the input source with using the **TV/VIDEO** button on the remote control. Note that this TV finds the connected input sources automatically for Video 1-2 and Component 1-2. It is presumed that RGB, HDMI1/DVI and HDMI2 sources are connected.
2. Operate the corresponding external equipment. For connection instructions for operating the TV Guide On Screen system, see page 21~22.

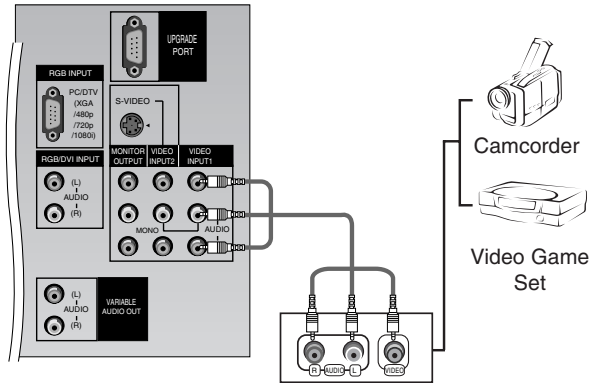

DVD Setup

How to connect

1. Connect the DVD video outputs (Y, P_B, P_R) to the COMPONENT (Y, P_B, P_R) INPUT jacks on the TV and connect the DVD audio outputs to the AUDIO INPUT jacks on the TV, as shown in the figure.
2. If your DVD only has an S-Video output jack, connect this to the S-VIDEO input on the TV and connect the DVD audio outputs to the AUDIO INPUT jacks on the TV, as shown in the figure.

Note: If your DVD player does not have component video output, use S-Video.

How to use

1. Turn on the DVD player, insert a DVD.
2. Use the **TV/VIDEO** button on the remote control to select **Component 1** or **Component 2**. (If connected to S-VIDEO, select the **Video** or **Front Video** external input source.)
3. Refer to the DVD player's manual for operating instructions.

Component Input ports

To get better picture quality, connect a DVD player to the component input ports as shown below.

| Component ports on the TV | Y | P _B | P _R |
|----------------------------------|---|----------------|----------------|
| Video output ports on DVD player | Y | P _b | P _r |
| | Y | B-Y | R-Y |
| | Y | P _B | P _R |

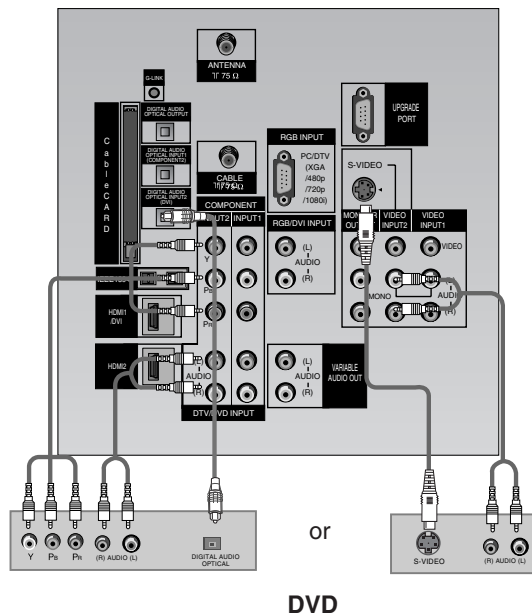

Notes:

- Digital Audio will not work for Component 1 input source.
- Digital Audio operation has priority if Digital Audio and AUDIO L/R are connected at the same time.

CableCARD™ Setup

How to use

Insert the CableCARD™ received from the cable service provider to the CableCARD™ slot of TV back panel.
If the pairing information about this TV and the CableCARD is automatically displayed on the screen, contact with the cable service provider by phone.

Note :

- CableCARD™ have the types of Motorola, Scientific Atlanta, SCM etc..
These 3 types of CableCARD™ can be used for this DLP Projection TV.



Caution: When removing the CableCARD™, do not drop it as this may cause impact to the CableCARD™.

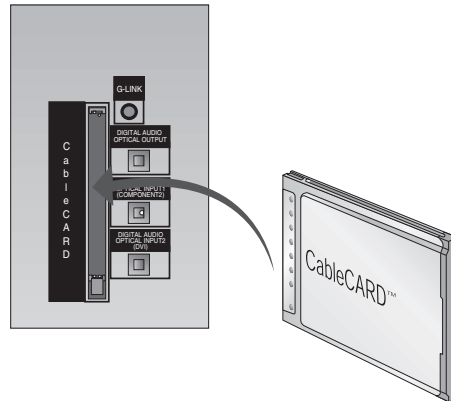

HDSTB Setup

- This TV can receive Digital Over-the-air/Cable signals without an external digital set-top box. However, if you do receive Digital signals from a digital set-top box or other digital external device, refer to the figure as shown below.
- This TV supports HDCP (High-bandwidth Digital Contents Protection) protocol for Digital Contents (480p,720p,1080i).

How to connect

Use the TV's COMPONENT (Y, P_B, P_R) INPUT, RGB, HDMI1/DVI or HDMI2 jack for video connections, depending on your set-top box connector. Then, make the corresponding audio connections.

Note: HDMI(High Definition Multimedia Interface): Input that accepts uncompressed digital signal and multi channel digital audio signal.

| Signal | Component 1/2 | RGB-DTV,HDMI/DVI |
|--------|---------------|------------------|
| 480i | Yes | No |
| 480p | Yes | Yes |
| 720p | Yes | Yes |
| 1080i | Yes | Yes |

How to use

1. Turn on the digital set-top box. (Refer to the owner's manual for the digital set-top box.)
2. Use **TV/VIDEO** on the remote control to select **Component 1, Component 2, RGB-DTV, or HDMI/DVI** source.

Monitor Out Setup

The TV has a special signal output capability which allows you to hook up a second TV or monitor.

Connect the second TV or monitor to the TV's MONITOR OUTPUT. See the Operating Manual of the second TV or monitor for further details regarding that device's input settings.

Note

- Component, RGB-PC/RGB-DTV, HDMI1/DVI,HDMI2, DTV input sources cannot be used for Monitor out.

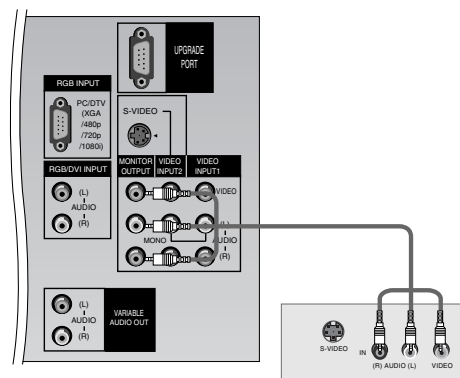

PC Setup

- This TV provides Plug and Play capability, meaning that the PC adjusts automatically to the TV's settings.
- The TV perceives 640x480, 60Hz as DTV 480p based on the PC graphic card, change the screen scanning rate for the graphic card accordingly.

<When the PC supports DVI>

How to connect

1. Connect the PC to HDMI1/DVI port of this TV with an HDMI-to-DVI cable(not supplied with this product).
If you do not need to connect audio, HDMI2 port is also available for the DVI video connection.
2. If the PC(or the sound card of the PC) has a fiber optic digital audio output connector, connect the PC's audio output to DIGITAL AUDIO(OPTICAL) port for DVI INPUT.
3. If the PC(or the sound card of the PC) has an analog audio output connector, connect the PC's audio output to AUDIO INPUT port located on the right side of RGB INPUT port.

How To Use

1. To get the best picture quality, adjust the PC graphics card to 1024x768, 60Hz.
2. Select HDMI1/DVI input source in main input option of SETUP menu.(Refer to P.61)
TV/VIDEO button is also available for this purpose.
3. Check the image on your TV. There may be noise associated with the resolution, vertical pattern, contrast or brightness in PC mode. If noise is present, change the PC output to another resolution, change the refresh rate to another rate or adjust the brightness and contrast on the VIDEO menu until the picture is clear. If the refresh rate of the PC graphic card can not be changed, change the PC graphic card or consult the manufacturer of the PC graphic card.

<When the PC supports RGB>

How to connect

1. Connect the PC to RGB INPUT port of this TV with a RGB cable(not supplied with this product).
2. If the PC(or the sound card of the PC) has an analog audio output connector, connect the PC's audio output to AUDIO INPUT port located on the right side of RGB INPUT port.

How To Use

1. To get the best picture quality, adjust the PC graphics card to 1024x768, 60 Hz.
2. Select **RGB-PC** input source in main input option of SETUP menu.(Refer to P.61)
Once you select **RGB-PC** in main input option of SETUP menu, **TV/VIDEO** button is also available for this purpose.
3. Check the image on your TV. There may be noise associated with the resolution, vertical pattern, contrast or brightness in PC mode. If noise is present, change the PC output to another resolution, change the refresh rate to another rate or adjust the brightness and contrast on the VIDEO menu until the picture is clear. If the refresh rate of the PC graphic card can not be changed, change the PC graphic card or consult the manufacturer of the PC graphic card.

Monitor Display Specifications (RGB-PC or HDMI/DVI Mode)

| Resolution | Horizontal Frequency(KHz) | Vertical Frequency(Hz) |
|------------|---------------------------|------------------------|
| 640x350 | 31.468 | 70.09 |
| | 31.469 | 59.94 |
| 640x480 | 37.861 | 72.80 |
| | 37.500 | 75.00 |
| 800x600 | 35.156 | 56.25 |
| | 37.879 | 60.31 |
| | 48.077 | 72.18 |
| | 46.875 | 75.00 |
| 1024x768 | 48.363 | 60.00 |
| | 56.476 | 70.06 |
| | 60.023 | 75.02 |

Digital Audio Output

Send the TV's audio to external audio equipment (stereo system) via the Digital Audio Output (Optical) port.

How to connect

1. Connect one end of an optical cable to the TV Digital Audio (Optical) Output port.
2. Connect the other end of the optical cable to the digital audio (optical) input on the audio equipment.
3. Set the " **TV Speaker** " option - **Off** " in the AUDIO menu. Refer to page 64.
See the external audio equipment instruction manual for operation.



Caution: Do not look into the optical output port. Looking at the laser beam may damage your vision.

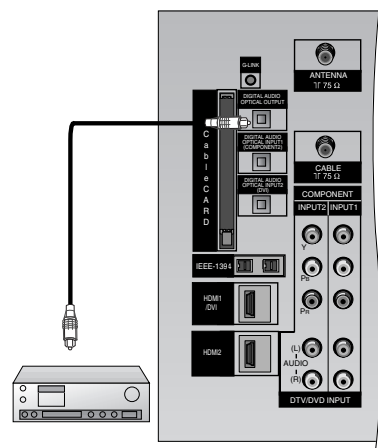

External Stereo

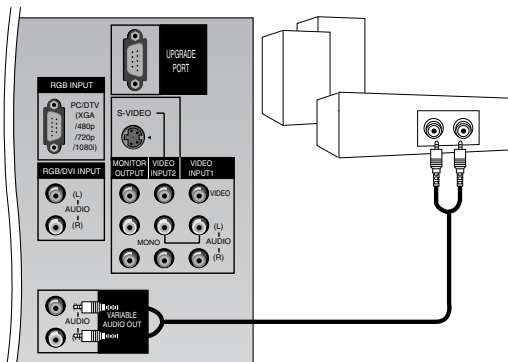

Hook up Variable Audio Output, L-Audio-R to Amplifier system for Left/Right front speaker sound.

How to connect

1. Locate the Variable Audio Out jacks on the back of your TV and the Input jacks on the back of your stereo's amplifier.
2. Connect the two jacks, making sure that the right and left channels are connected correctly.
3. Set up your speakers through your analog stereo amplifier, according to the instructions provided with the amplifier.

HDMI



- HDMI™, the HDMI logo and High-Definition Multimedia Interface is a trademark or registered trademark of HDMI Licensing.
- This TV can receive the High-Definition Multimedia Interface(HDMI) or the Digital Visual Interface(DVI).
- This TV supports HDCP(High-bandwidth Digital Contents Protection) Protocol for 720x480p, 1280x720p, and 1920x1080i resolution.
- When you connect this TV with a source device(DVD player, Set Top Box or PC) supporting Auto HDMI/DVI function, the output resolution of the source device will be automatically set to 1280x720p.
- If the source device does not support Auto HDMI/DVI, you need to set the output resolution appropriately.
To get the best picture quality, adjust the DVD Player or Set Top Box's output resolution to 1280x720p, and the PC graphics card's output resolution to 1024x768, 60Hz.
- If the source device has an HDMI output, no other audio connection is necessary because HDMI-to-HDMI connection includes both video and audio.
- If the source device has a DVI output and no HDMI output, a separated audio connection is necessary.

<When the source device(DVD player or Set Top Box) supports HDMI>

How To Connect

1. Connect the source device to HDMI1/DVI or HDMI2 port of this TV with an HDMI cable(not supplied with this product).
2. No separated audio connection is necessary.

How To Use

- If the source device supports Auto HDMI function, the output resolution of the source device will be automatically set to 1280x720p.
- If the source device does not support Auto HDMI, you need to set the output resolution appropriately.
To get the best picture quality, adjust the output resolution of the source device to 1280x720p.
- Select HDMI1/DVI or HDMI2 input source in main input option on the SETUP menu.(Refer to P.61)
TV/VIDEO button is also available for this purpose.

<When the source device(DVD player or Set Top Box) supports DVI>

How To Connect

1. Connect the source device to HDMI1/DVI port of this TV with a HDMI-to-DVI cable(not supplied with this product).
Do not use HDMI2 port for DVI connection if you want to connect audio.
2. A separated audio connection is necessary.
3. If the source device has a fiber optic digital audio output, connect the audio output to DIGITAL AUDIO(OPTICAL) port for DVI INPUT.
4. , connect the PC's audio output to AUDIO INPUT port located on the right side of RGB INPUT port.

How To Use

- If the source device supports Auto DVI function, the output resolution of the source device will be automatically set to 1280x720p.
- If the source device does not support Auto DVI, you need to set the output resolution appropriately.
To get the best picture quality, adjust the output resolution of the source device to 1280x720p.
- Select HDMI1/DVI input source in main input option on the SETUP menu.(Refer to P.61)
TV/VIDEO button is also available for this purpose.

Reference

Cable sample

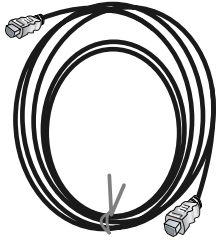

HDMI Cable
(not supplied with the product)

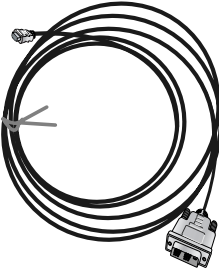

HDMI to DVI Cable
(not supplied with the product)

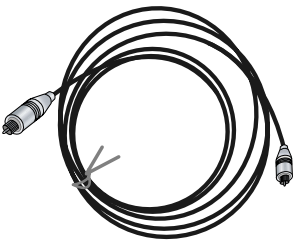

Fiber Optic Digital Audio Cable
(not supplied with the product)



Analog Audio Cable(RCA type)
(not supplied with the product)

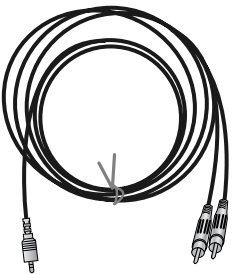

Analog Audio Cable(Stereo to RCA type)
(not supplied with the product)

How to use

1. Connect the HDMI1/DVI Source Devices(DVD Player or Set Top Box or PC) and the TV SET.
2. Turn on the display by pressing the POWER button on the TV SET and HDMI1/DVI Source Devices remote control.
3. Select HDMI1/DVI Input source in Main Input option on the SETUP menu.(Refer to P.61)
4. Check the image on your TV SET. There may be noise associated with the resolution, vertical pattern, contrast or brightness in HDMI1/DVI Source Devices. If noise is present, change the HDMI1/DVI Source Devices to another resolution, change the refresh rate or adjust the brightness and contrast on the menu until the picture is clear. If the refresh rate of the PC graphics card can not be changed, change the PC graphics card or consult the manufacturer of the PC graphics card.

Notes:

- Depending on the graphics card, DOS mode may not work if a HDMI to DVI Cable is in use.
- Avoid keeping a fixed image on the screen for a long period of time. The fixed image may become permanently imprinted on the screen.
- When Source Devices connected with HDMI1/DVI Input, output PC Resolution(VGA, SVGA, XGA), Position and Size may not fit to Screen. As shown in the picture below, press the **ADJUST** button to adjust the screen Position of TV SET and contact a PC graphics card service center.
- When Source Devices connected with HDMI1/DVI Input, output TV SET Resolution(480p, 720p, 1080i) and TV SET Display fit EIA/CEA-861-B Specification to Screen. If not, refer to the Manual of HDMI1/DVI Source Devices or contact your service center.
- In case HDMI1/DVI Source Devices is not connected Cable or poor cable connection, "NO SIGNAL" OSD display in HDMI1/DVI Input. In case that Video Resolution is not supported TV SET output in HDMI1/DVI Source Devices, "INVALID FORMAT" OSD display. Refer to the Manual of HDMI1/DVI Source Devices or contact your service center.

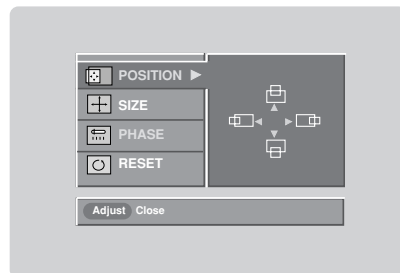

PC mode

In This Mode, the Supported TV Set Resolution Specification

- 1920 x 1080 | @ 59.94Hz / 60Hz, 16:9
- 1280 x 720 P @ 59.94Hz / 60Hz, 16:9(preferred format)
- 720 x 480 P @ 59.94Hz / 60Hz, 16:9
- 720 x 480 P @ 59.94Hz / 60Hz, 4:3

In This Mode, the Supported PC Resolution Specification

- 640 x 350 @ 70Hz
- 640 x 480 @ 60Hz
- 640 x 480 @ 72Hz
- 640 x 480 @ 75Hz
- 800 x 600 @ 56Hz
- 800 x 600 @ 60Hz
- 800 x 600 @ 72Hz
- 800 x 600 @ 75Hz
- 1024 x 768 @ 60Hz(preferred format)
- 1024 x 768 @ 70Hz
- 1024 x 768 @ 75Hz

TV Guide On Screen Setup

- The TV Guide On Screen system uses Setup information to provide you with show listings and lineups in your area—which are updated several times a day.
- Once you set up the TV according to manufacturer's instructions, you are ready to set up the TV Guide On Screen system.
- To download program listings the TV Guide On Screen system needs to be able to change channels on your cable box when the TV is not in use. Please connect the supplied G-LINK cable to the G-LINK jack of the TV. After you connect the G-LINK cable you will be able to control your cable box using the TV's remote.

Note: The TV Guide On Screen system interactive program guide provides listings for cable-ready, cable box, and digital cable services as well as over-the-air broadcast. It does not provide listings for satellite services.

How to connect VCR and Cable Box

1. Antenna Service

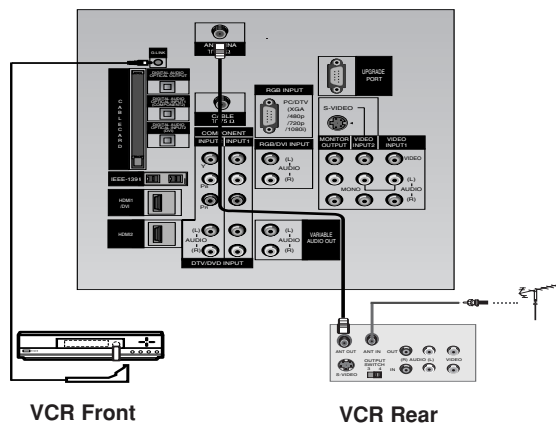

2. Cable Service without a Cable Box

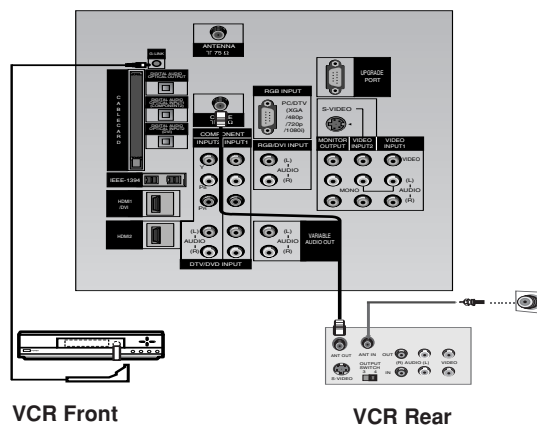

3. Cable Service without a Cable Box

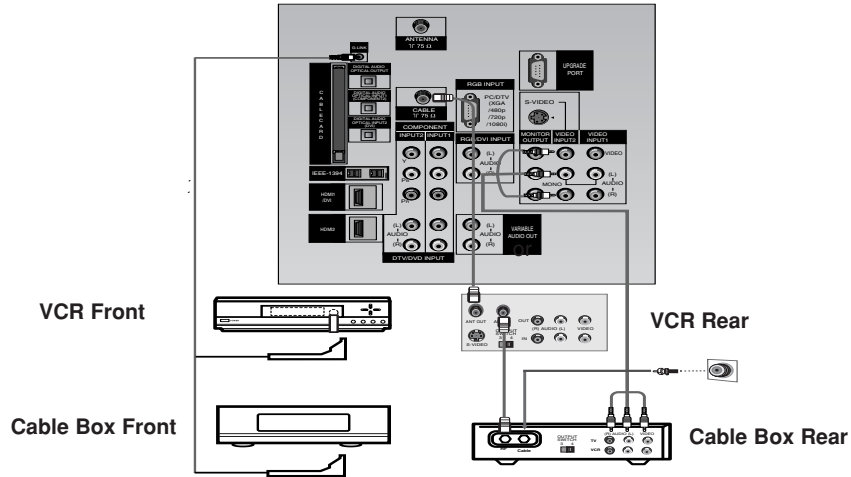

4. Antenna and Cable Service without a Cable Box

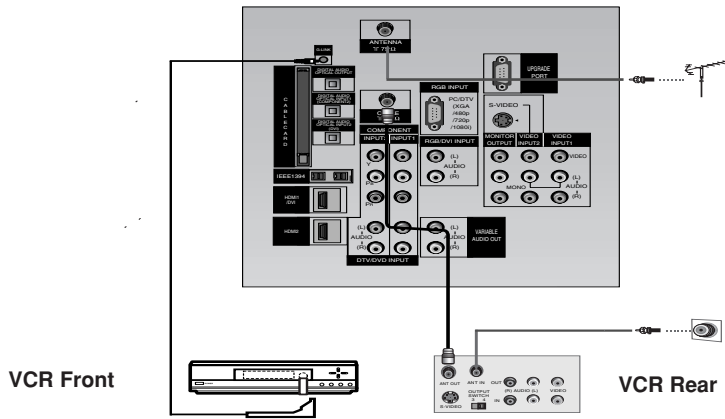

5. Antenna and Cable Service with a Cable Box

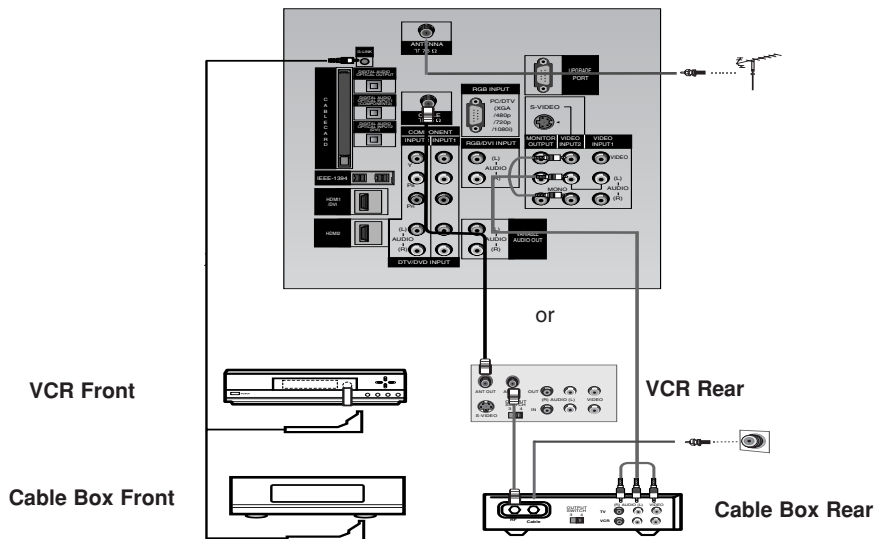

Note: The G-LINK cable is necessary for the TV Guide On Screen system to work with your Cable Box and VCR. See Page 21~22 for G-LINK connection instructions.

TV Guide On Screen Setup

1. Welcome Screen

The TV Guide On Screen system's Welcome Screen appears:

- by pressing the TV Guide key
- when you power On your TV if you previously skipped "Set up TV Guide On Screen now" on the Reminder Screen.

The Welcome Screen highlights features of the TV Guide On Screen system.

Press **ENTER** to begin Setup.



2. Reminder Screen

The TV Guide On Screen system's Reminder Screen appears:

- after initial TV set up
- if you power Off the TV and then power it back On

To make a selection, use the ▲ / ▼ buttons to highlight to an option, and press **ENTER**.

- "Set up TV Guide On Screen now," displays the Welcome Screen. Press **ENTER** to begin Setup.
- "Remind me to set up later" returns you to watching TV.
- "Don't remind me again" returns you to watching TV and stops the reminder screen from appearing upon power On.

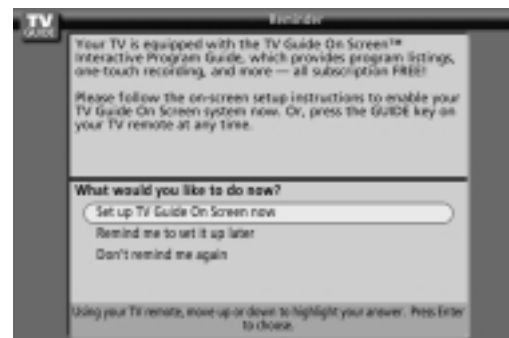

How to use

1. Screen 1: Country

- This screen asks you the location of your TV.
- Use the ▲ / ▼ button to highlight a country.
- Press **ENTER** to display Screen 2.

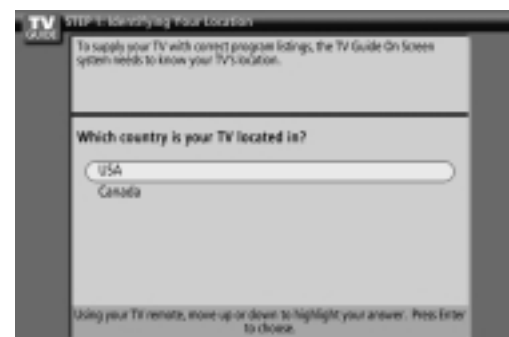

2. Screen 2: Enter Zip or Postal Code

Option 1

- If you selected USA in Screen 1, you see the ZIP Code screen.
- You input numbers by either pressing the number keys on the remote or using the ▲ / ▼ button to display a number, and then the ◀ / ▶ button to move to another field.
- Press **ENTER** to display Screen 3.

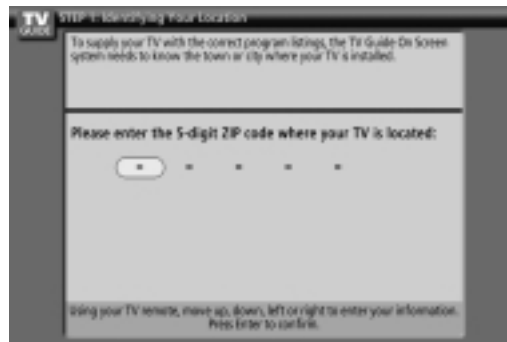

Option 2

- If you selected Canada in Screen 1, you see the Postal Code screen.
- You input characters by using the ▲ / ▼ button, and then the ◀ / ▶ button to move to another field.
- Press **ENTER** to display Screen 3.

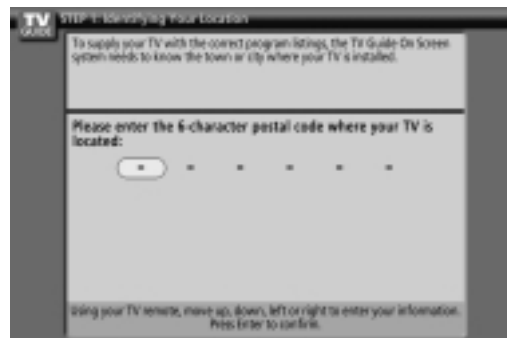

3. Screen 3: Do you have Cable Service connected?

- If you select Yes, you see Screen 4.
- If you select No, you see Screen 12.

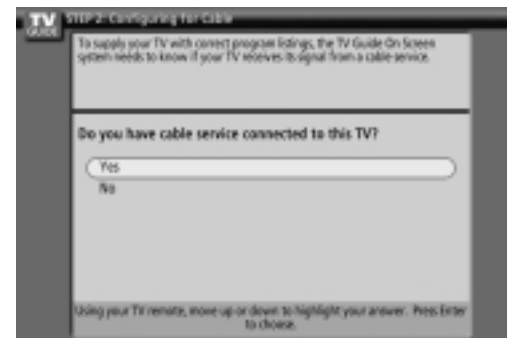

4. Screen 4: Do you have a Cable Box?

- If you select Yes, you see Screen 5.
- If you select No, you see Screen 12.

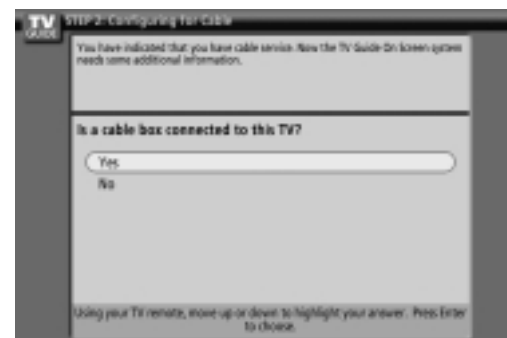

5. Screen 5: Which TV input is the cable box plugged into?

- If you select Cable, you see Screen 6.
- If you make any other choice, you see Screen 7 .

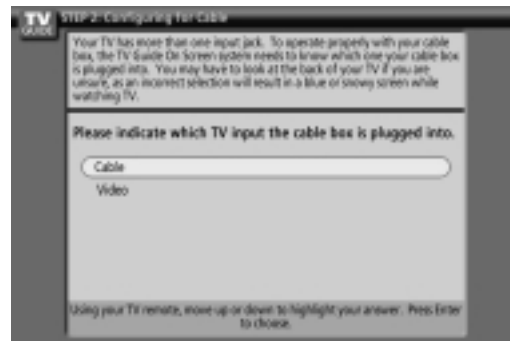

6. Screen 6: Cable Box Tuning Channel

- Select the channel used for the cable box.
- Press **ENTER** to display Screen 7.

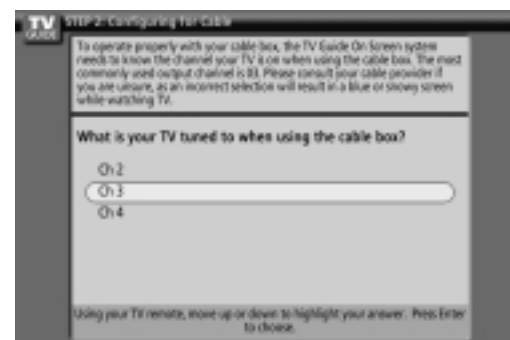

7. Screen 7: Cable Box Configuration Diagram

- The diagram shows the correct way to install the G-LINK Cable from the back of the device to the cable box.
- **Make sure the G-LINK™ Cable is properly installed.**
- Press **ENTER** to display Screen 8.

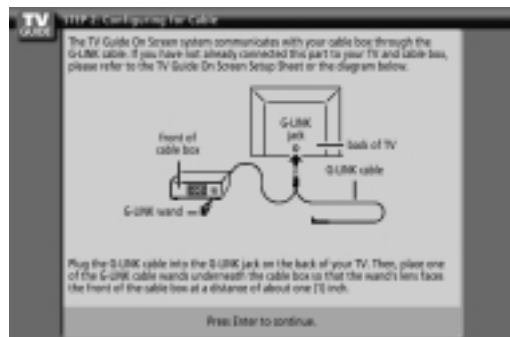

8. Screen 8: Cable Box Brand Name

- Use the ▲ / ▼ button to select a cable box brand.
- Press **ENTER** to display Screen 9.

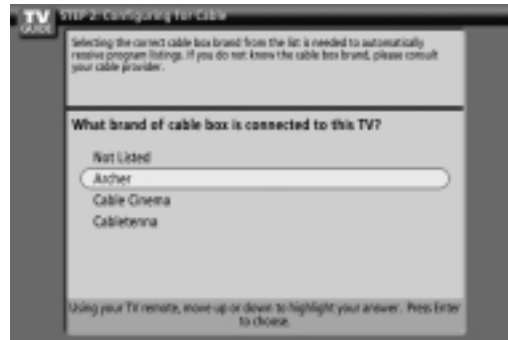

9. Screen 9: Cable Box Preparation

- Follow the on-screen instructions, and press **ENTER** to display Screen 10.

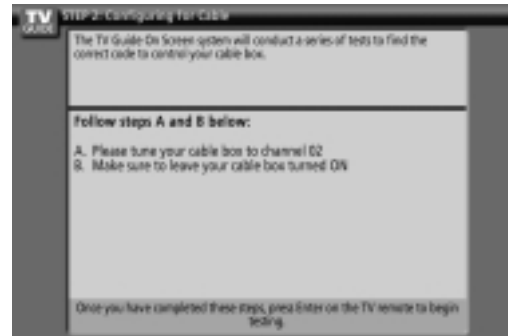

10. Screen 10: Cable Box Code Testing

- When testing is done, Screen 11 displays automatically.

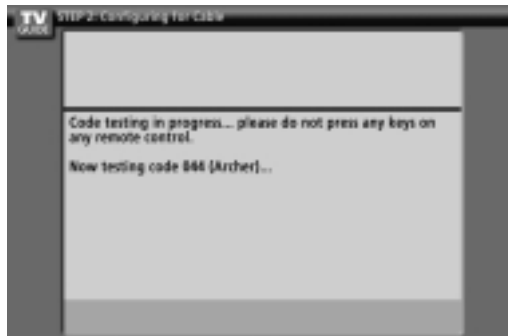

11. Screen 11: Cable Box Tuned to Channel 9?

- If you select Yes, you see Screen 12.
- If you select No, a different code is tested in Screen 10.

Note:

- Many Cable Boxes require testing more than one code.
- If you select Test this code again, the same code is tested again in Screen 10.

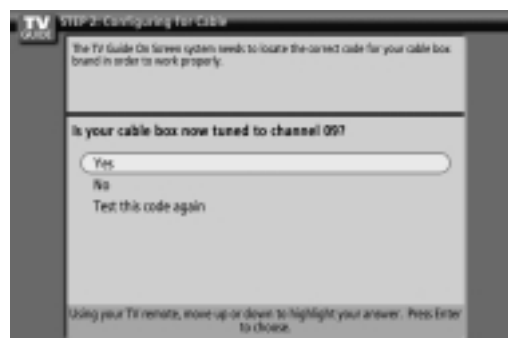

12. Screen 12: Do you have an antenna connected?

- If you select Yes, you see Screen 13.

Note:

- If you selected No in Screen 3 then you must select Yes in this screen to receive a channel lineup and listings.
- If you select No, you see Screen 13.

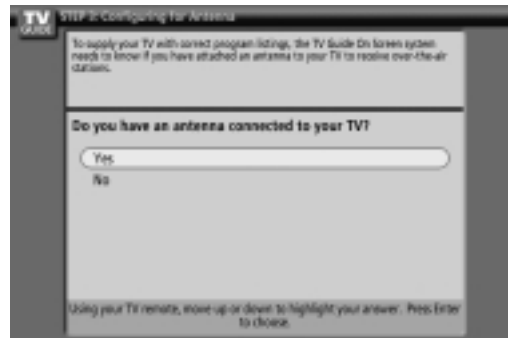

13. Screen 13: Are your basic settings correct?

- If you select Yes, you see Screen 14.
- If you select No, you see Screen 1.

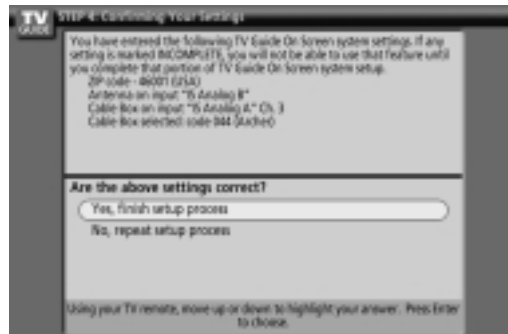

14. Screen 14: Congratulations

- Press **ENTER** to display Screen 15.



15. Screen 15: Is a VCR Connected?

- If you select Yes, you see Screen 16.
- If you select No, you see Screen 21.

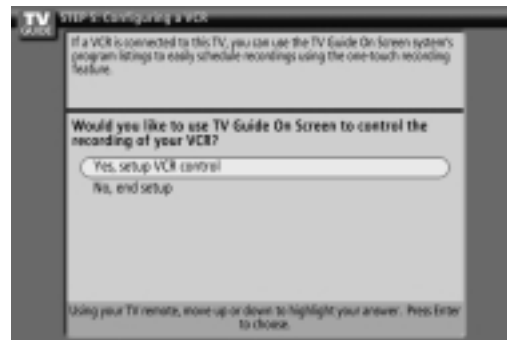

16. Screen 16: VCR Configuration Diagram

- This screen shows the correct way to install the G-LINK™ Cable from the back of the TV to the Recording device.
- **Make sure the G-LINK™ Cable is properly installed.**
- Press **ENTER**, and you see Screen 17.

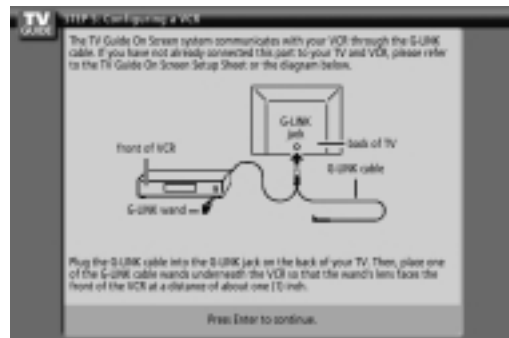

17. Screen 17: VCR Brand Name

- Use the ▲ / ▼ button to select the brand of the recording device.
- Press **ENTER**, and you see Screen 18.

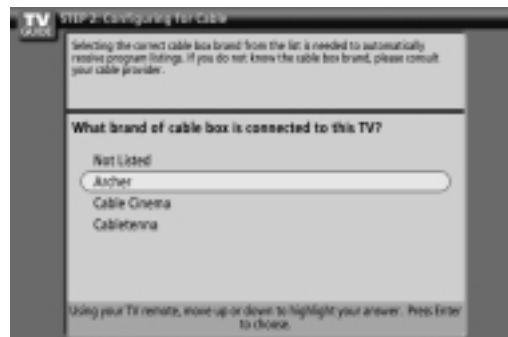

18. Screen 18: VCR Preparation

- Follow the on-screen instructions, and press **ENTER** to display Screen 19.

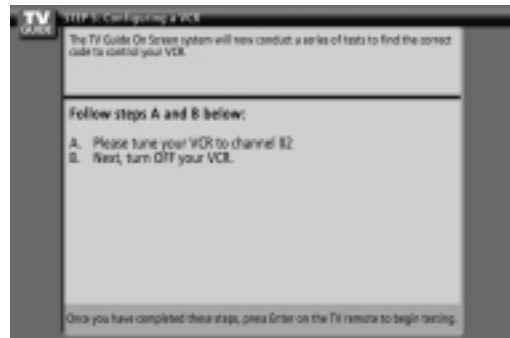

19. Screen 19: VCR Code Testing

- When testing is done, Screen 20 displays automatically.

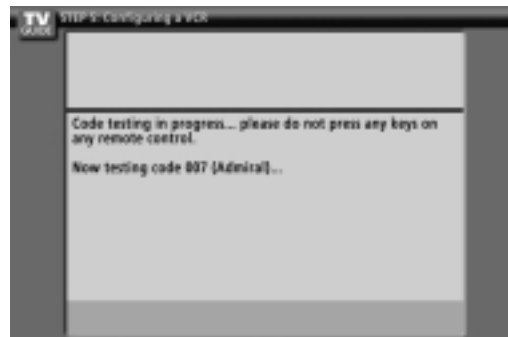

20. Screen 20: VCR Tuned to Channel 9?

- If you select Yes, you see Screen 21.
- If you select No, a different code is tested in Screen 19.

Notes :

- Many VCRs require testing more than one code.
- If you select Test this code again, the same code is tested again in Screen 19.

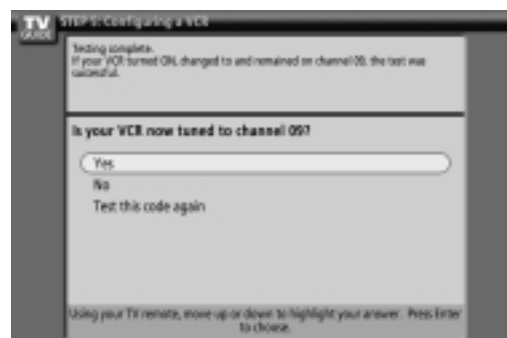

21. Screen 21: Confirming Your Settings

- Verify the Setup information is correct.
- If it is, select Yes, end setup, and you see Screen 22.
- If it is not, select No, repeat setup process, and you see Screen 1.

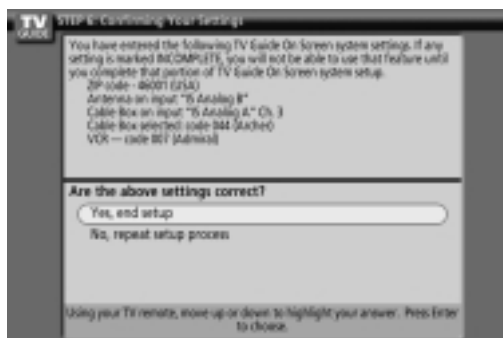

22. Screen 22: Congratulations

- You have successfully completed Setup!
- Press ENTER and you see Screen 23.

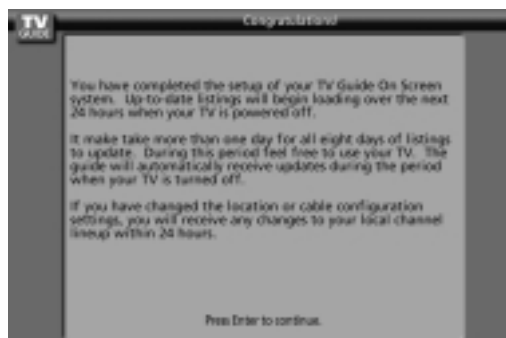

23. Screen 23: Helpful Information

- This screen tells you valuable information on using your TV Guide On-Screen system
- Press ENTER to watch TV.



Notes:

The TV Guide On-Screen system receives program listings data through your cable or over-the-air video signal. In order to receive regular program listings, please remember to do the following:

1. Turn OFF your TV when it is not in use. (Do not unplug the power cord.)
2. If you have a Cable box connected, leave it ON.
3. If you have a VCR connected, turn it OFF when not in use. (Do not unplug the power cord.)
4. If you have more than one Cable system in your area, you may be prompted to select which Cable system's program data to download. If so prompted, please follow the on-screen instructions.

IEEE 1394 Functions

- It's available to communicate to either direction and you can give and take a image, sound, or each control command with one cable.

◆ How to connect the 1394

•To operate the IEEE1394, these methods are available as shown below.

1. When connecting the DVHS or the MicroMV Camcorder, as shown in the (a) or (b) figure, press the  button to show the control panel.

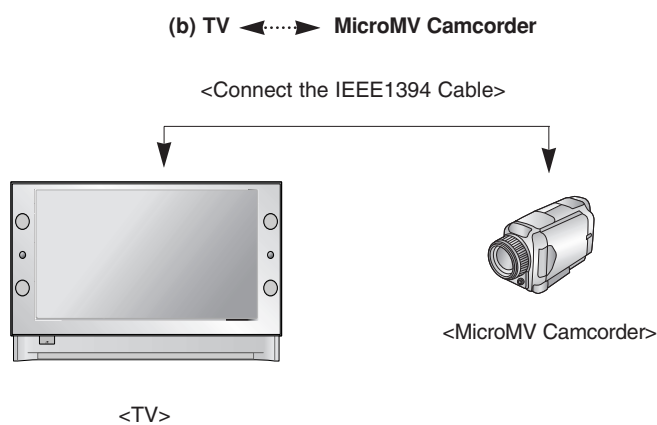
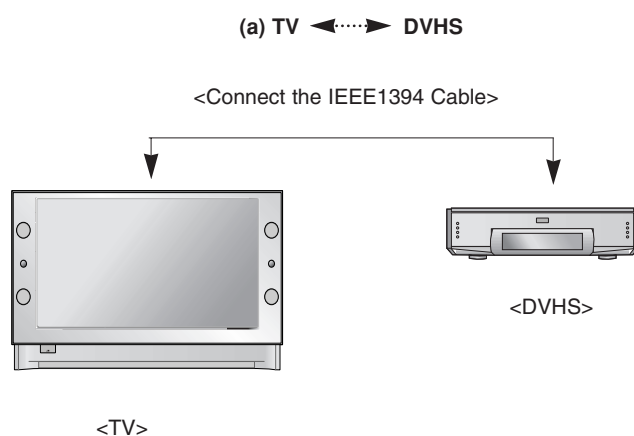

Note: When connecting the DVHS and the MicroMV Camcorder, in case of showing 'input error', it's okay.

IEEE 1394 Functions

2. When connecting the DVHS and the MicroMV Camcorder, as shown in the (c) or (d) figure, press the  button to show the control panel and then select the DVHS or the MicroMV Camcorder.

(c) TV ◀-----▶ DVHS + MicroMV Camcorder

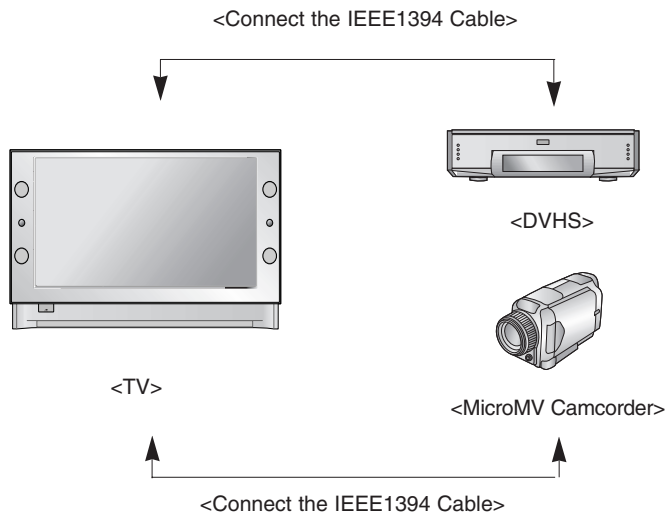

(d) Daisy Chain Connection

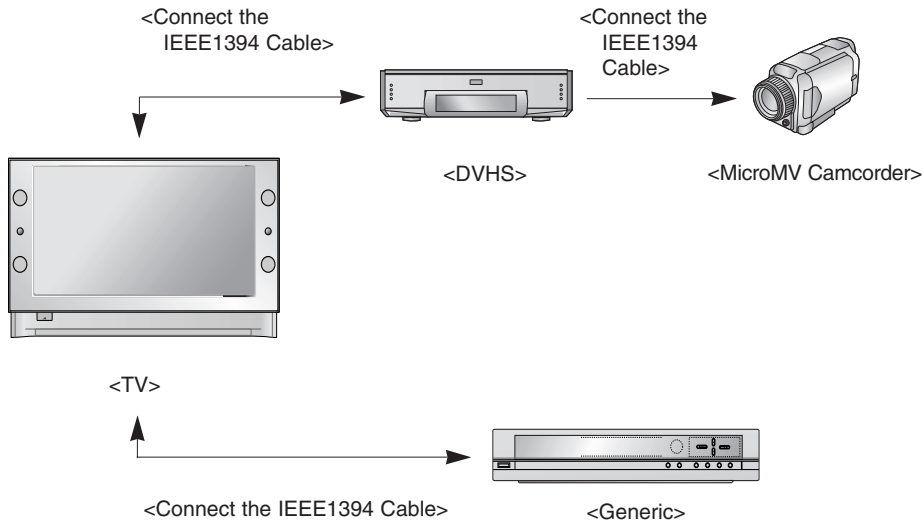

- When connecting the 1394 and then playing, you must use the original DVHS tape. If not, it may occur errors.
- If the operation normally doesn't work on Daisy Chain connection, please change an arrangement of connected device.

DVHS

◆ How to play the DVHS

1. Connect the IEEE 1394 jack at the TV to the IEEE 1394 jack at the DVHS with IEEE 1394 Cable.

2. When watching the TV, press the  button.

<Connect the IEEE1394 Cable>

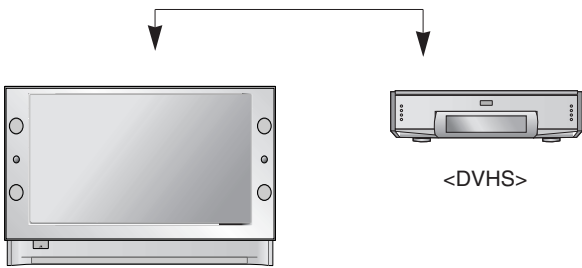

<TV>

<DVHS>

• Show the control panel of DVHS.



• The control panel of DVHS

-Depending on the connected equipment, marked control panel may be different.

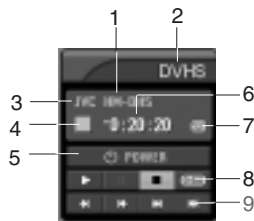

1. DVHS Model
2. Connected Equipment to the 1394
3. DVHS Company
4. DVHS Operating Status
5. Power On/Off
6. DVHS Play Time
7. Tape Status
 - Tape shape Icon - Tape in or not
 - Lock shape Icon - Writable or not
8. Initializing Play Time
9. DVHS Play, Pause, Stop, Search, Skip.

(Notes:

- Skip- This function is for a fast search. It searches the program's start point and then plays. On skipping, Search (◀▶), Pause (||) and Play (▶) are displayed on the Control Panel. In some models, it's not available to operate the Skipping (◀▶) function.

* Supported DVHS List

- JVC(HM-DH40000K)
- JVC(HM-DH40000U)
- JVC(HM-DH5U)
- mitsubishi(HV-HD1000)
- PANASONIC(NV-DH2)

Notes:

- In case the DVHS have a incorrect recognition to Generic, the power of DVHS is completely pull out and then connect again.
- When searching the screen(◀▶), the DVHS may be strangely seen. And also the DVHS may late respond by devices.

IEEE 1394 Functions

MicroMV Camcorder

◆ How to play the MicroMV Camcorder

1. Connect the IEEE 1394 jack at the TV to the IEEE 1394 jack at the MicroMV Camcorder with IEEE 1394 Cable.

2. When watching the TV, press the  button.

<Connect the IEEE1394 Cable>

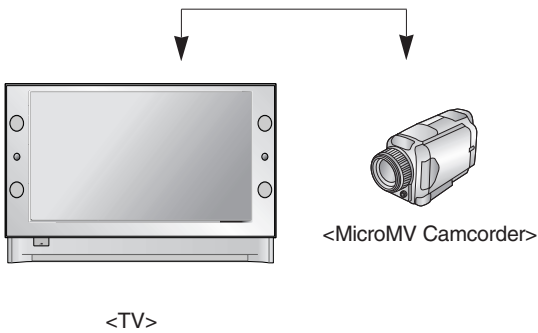

• Show the control panel of MicroMV Camcorder.



• In camera mode of MicroMV Camcorder, this control panel is showed.

• The control panel of MicroMV Camcorder
-Depending on the connected equipment, marked control panel
-may be different.

• Show the control panel of CAM.

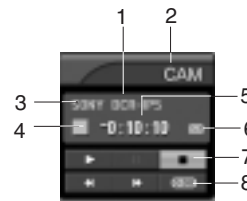

* Supported MicroMV Camcorder List

SONY DCR IP-1
SONY DCR IP-5
SONY DCR IP-45
SONY DCR IP-210

1. MicroMV Camcorder Model
2. Connected Equipment to the 1394
3. MicroMV Camcorder Company
4. MicroMV Camcorder Operating Status
5. MicroMV Camcorder Play Time
6. Tape Status
 - Tape shape Icon - Tape in or not
 - Lock shape Icon - Writable or not
7. MicroMV Camcorder Play, Search, Pause or Stop
8. Initializing Play Time

Notes:

- In memory mode of MicroMV Camcorder, it doesn't apply to connect the IEEE1394.
- Regardless of a mode of MicroMV Camcorder, if the tape is ejected, it doesn't apply to connect the IEEE1394.

MicroMV Camcorder and DVHS

◆ How to play the MicroMV Camcorder and DVHS

1. Synchronously, connect the IEEE 1394 jack of the TV to the IEEE 1394 jack of the DVHS and the MicroMV Camcorder with IEEE 1394 Cable.

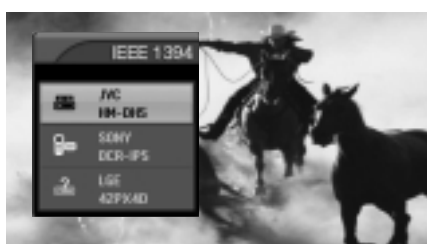

2. Press the ▲ / ▼ button to select device, then press **ENTER** button to play it . And then selected device will be showed OSD.

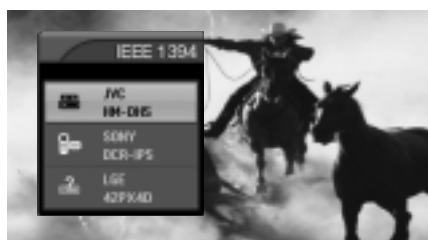

IEEE 1394 Functions

DTV Link : DTV Link applies to 1394 connection of device labeled DTV Link logo.





* What's the **DTV Link**?

It is normal standard of CEA which restricts by a remote and displays OSD and plays to stream of a remote control by using a connection of IEEE1394.

◆ How to play the DTV Link

1. Connect the IEEE 1394 jack of the TV to the IEEE 1394 jack of the DTV Link supported device IEEE 1394 Cable.

2. When watching the TV, press the  and then  /  buttons to select the DTV Link supported device and then use the **ENTER** button.

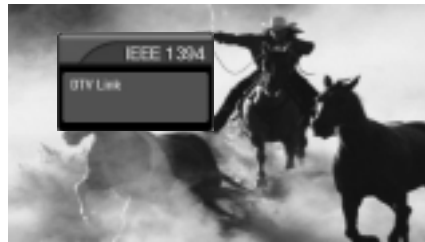
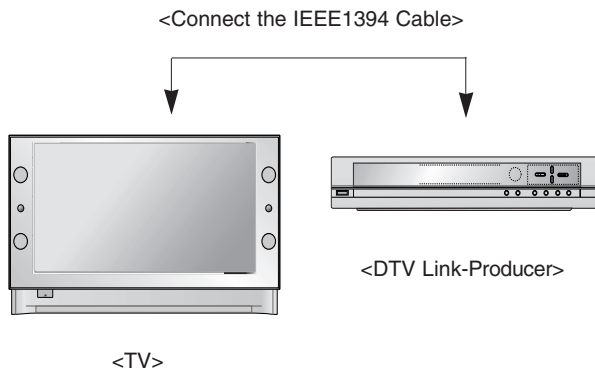

3. Press the **TV INPUT** button to stop the IEEE1394 function.

Note: On a condition of connecting the IEEE 1394, you can control the DTV Link device while watching the OSD through DTV and DTV remote control.
(ex: change of channel, play, record, a show of recording list etc.)

◆ Don't connect !

- When connecting with these 2 methods, the **IEEE1394** will not work properly.

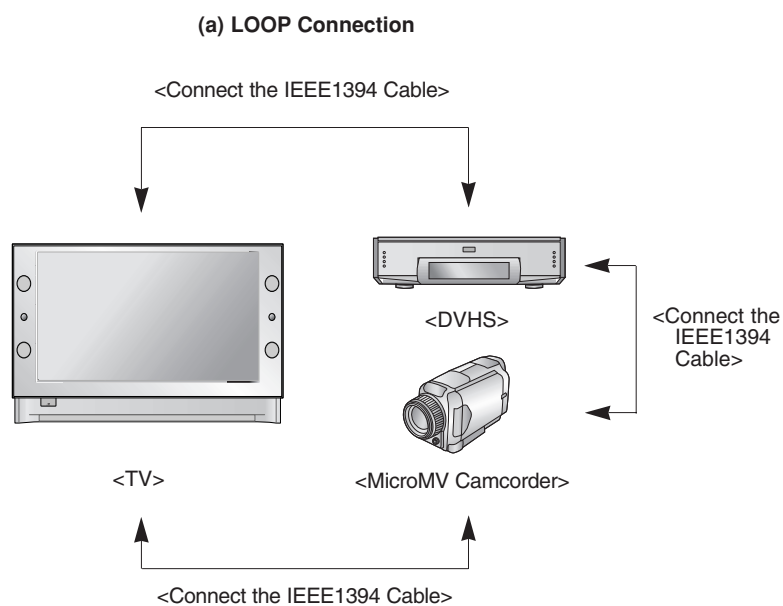

- (b) When connecting the 4 devices and over, the 1394 will not work properly.

Notes:

- On a condition of connecting the IEEE 1394, you can control the DTV Link device while watching the OSD through DTV and DTV remote control.
(ex: change of channel, play, record, a show of recording list etc.)
- Analog channel is not supported.

TV Guide On Screen™ System

Overview

- Your new TV contains the TV Guide On Screen Interactive Program Guide.
- The TV Guide On Screen system has features that help you get the most out of your viewing experience.

TV Guide On Screen Overview

The TV Guide On Screen system has the following features:

- Three 30-minute time periods in a 16x9 aspect ratio.
- Eight days of show listings (today plus seven days).
- Icons that indicate show rating, stereo, HDTV, new episode, etc.
- Intuitive up/down/left/right navigation using your remote control.
- Set shows to Record.
- Schedule show Reminders.
- Search shows by category (e.g., Movies, Sports, Children, etc.).
- Search for shows based on keywords or alphabetically by title.
- Direct tuning to a channel.
- Show information while watching TV.
- Streamlined System Setup and default setting options.
- Channel lineup customization.
- Help screens while in the Guide.

Screen Components

- The screens displayed in the TV Guide On Screen system share many of the same components, as shown in the following figure:

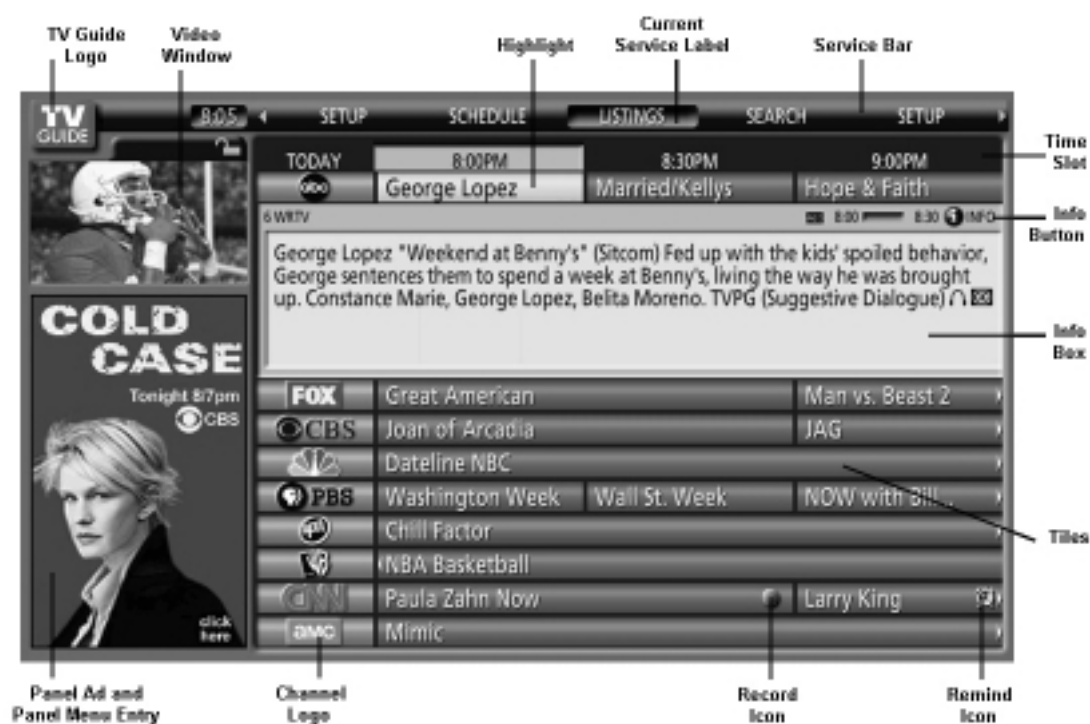

- Video Window** - displays TV video while the Guide is displayed
- Service Bar** - provides access to the 4 main Guide Services
- Current Service Label** - indented to indicate current Service displayed
- Tile** - displays show title
- Highlight** - indicates an active tile
- Info Box** - provides information for a highlighted item
- Info Button** - cycles through the various Info Box sizes
- Channel Logo** - identifies network
- Record/Remind Icons** - indicates a show is set to Record or set as a Reminder
- Panel Ad** - location where show- or product-specific information appears (and also where Panel Menu appears)

TV Guide On Screen™ System

Panel Menu



- A Panel Menu appears when the Menu key is pressed on a highlighted tile and additional options are available. It also appears when you press **ENTER** on a show starting in the future.
- When a Panel Menu appears, the highlighted tile changes color to indicate the Panel Menu relates to this tile.
- The Panel Menu displays below the Video Window.
- Help is available for a displayed Panel Menu by pressing the **INFO** button.
- The **▲ / ▼** buttons move between the options within the Panel Menu.
- The left and right arrows move to adjacent options unless the highlight is on an odometer, where these arrows change the odometer choice.
- Pressing **ENTER** from an odometer or number entry box moves the highlight to the default command button of that Panel Menu, for example, Schedule Reminder.
- Pressing **ENTER** from a highlighted command button executes the action and closes the Panel Menu (e.g., Schedule Reminder, Cancel).
- Select Cancel to cancel any changes and press **ENTER** to close this menu.
- Pressing Menu is a shortcut to Cancel. Press Menu to cancel any changes and close the menu.
- If a Panel Menu contains more menu options than can be displayed on a single screen, **▲ / ▼** buttons appear at the top or bottom of a menu. Simply scroll down to access these options.

Main Services

Listings

- Access Listings by pressing the TV Guide button on your remote or on the front panel of your TV.
- Listings is always the first Service displayed in the Guide.
- With Listings highlighted, press the Info button to display a Help screen.
Press the Info button again to close the screen.

Use the ▲ / ▼ / ◀ / ▶ buttons to move the highlight within Listings to:

- View 8 days of show listings
- Read show descriptions
- Tune directly to a show currently airing
- Set a show to Remind
- Set a show to Record
- Lock and unlock the Video Window
- Access Panel and Channel Ads

Notes: There may be times when the TV Guide On Screen system could display partial or no program listings. The reasons for this include:

- Program schedule information was not provided to TV Guide On Screen.
- The transmission of the program listings was interrupted.

The phrase "No Listings" will be replaced with program information during the next transmission, which should occur within the next 24 hours.

Please remember to turn off your TV when not in use in order to receive program listings.

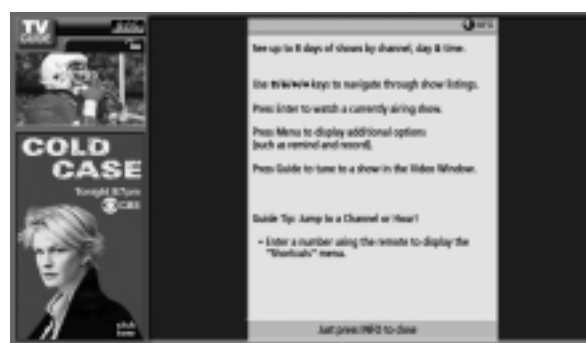

TV Guide On Screen™ System

Search

- Search lets you find shows by category (Alphabetical, Movies, Sports, Children, Educational, News, Variety, Series, HDTV) or by Keyword.
- With Search highlighted, press the Info button to display a Help screen.
Press the Info button again to close the screen.

•Category Search Example: Movies

1. From Search, use the ▼ button to highlight Movies.

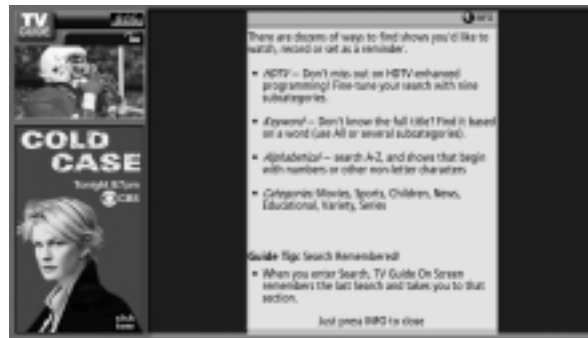

2. Use the ▼ button to highlight a subcategory (for example, All).

3. Press **ENTER** to display a list of all Movies, organized by date and time.



4. Highlight a show and press **ENTER** to watch (if on now) or the Menu key to display the Episode Options menu.



You can choose to set a recording, a reminder, or tune to the channel.

Go to Service Bar - closes the menu, changes no information, and returns to the Search Service Bar.

Tune to Channel - exits the Guide and tunes to the channel of the highlighted show (show airs in the future).

Note: This option reads *Watch Now* if the show is currently airing.

Set Recording - displays the Record Options menu, from which you can set frequency, start and end time, etc.

Set Reminder - displays the Remind Options menu, from which you can set frequency, start and end time, automatically power On, and auto-tune the TV.

Cancel - closes the menu, changes no information, and returns to the highlighted show.

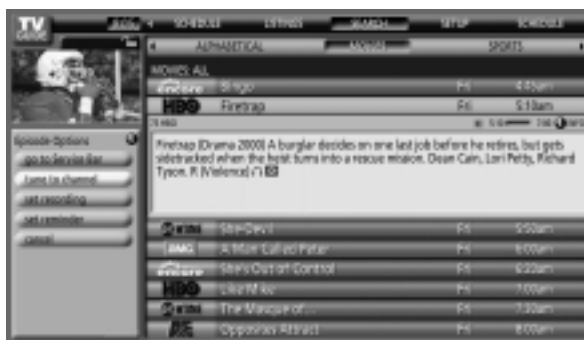

TV Guide On Screen™ System

• Keyword Search

- **Keyword search** lets you enter a word(s) to look for a particular show by category or for every show title that matches.

1. Highlight the Keyword navigation label, and press **ENTER** button to display the Keyword **Search** menu.
2. Highlight New Search, and press **ENTER** button.



3. The Search Options menu is displayed.
4. Highlight Category, and use the ◀ / ▶ buttons to select a category to search (e.g. All, HDTV, Children, Sports, etc.). When finished, use the ▼ button to highlight Enter Keyword.
5. Highlight Enter Keyword, and press **ENTER**. Then the keyboard is displayed.



6. Use the ▲ / ▼ / ◀ / ▶ buttons to highlight a character, and press **ENTER** to display it. When complete, highlight Done and press **ENTER**.



7. A list of all matching shows for that keyword is displayed.

Like the Category Search Example, you can highlight a show, and press **ENTER** to display all airings. You can then highlight a specific listing and press **ENTER** to watch (if On now) or the Menu key to display the Episode Options menu.

From the Episode Options menu, choose to set a recording, a reminder, or tune to the channel, as previously described.



The Guide stores all the keywords you create. To edit or delete a keyword, highlight the keyword and press the Menu key. A Search Options menu is displayed.

Go to Service Bar - closes the menu, changes no information, and returns to the Search Service Bar.

Edit Search - displays the keyboard, where you can change the keyword.

Delete Search - A Confirm menu is displayed.

- **Yes** - deletes the Search

- **No** - closes the panel menu

Cancel - closes the menu, changes no information, and returns to the highlighted show.

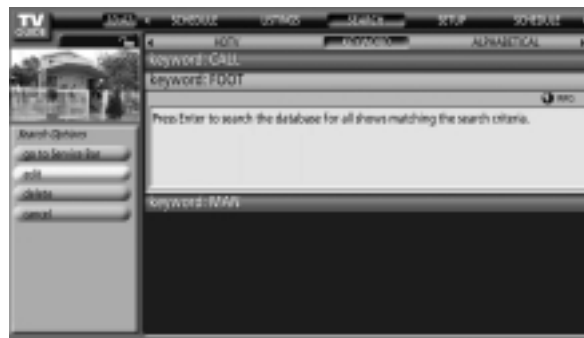





TV Guide On Screen™ System

Schedule





- Schedule lets you review, edit, or delete Record and Remind events that you set previously.
- With Schedule highlighted, press the **Info** button to display a Help screen. Press the **Info** button again to close the screen.
- An icon identifies the event type:

Record

- ◆ Once —records the show one time
- ◆ Regularly  , Daily —records the show every time the show airs on the same channel and starts at the same time
- ◆ Weekly —records the show each time the show airs on the same day of the week, on the same channel and starts at the same time
- ◆ Off —keeps the show in the list but will not record this show until the frequency is changed.



Remind

- ◆ Once —sets a show reminder one time
- ◆ Regularly  , Daily —sets a show reminder every time the show airs on the same channel and starts at the same time
- ◆ Weekly —sets a show reminder each time the show airs on the same day of the week, on the same channel and starts at the same time
- ◆ Off —keeps the show in the list but will not remind until the frequency is changed

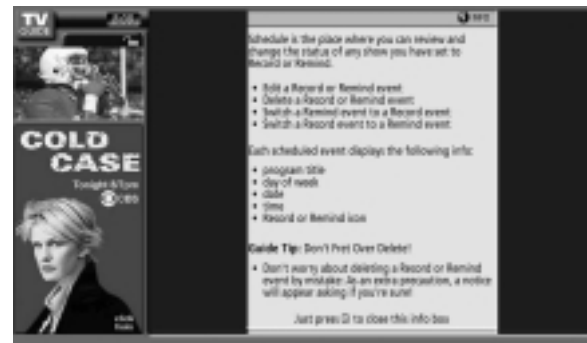

Highlight an event, and press the Menu key for options.

Go to Service Bar - closes the menu, changes no information, and returns to the Schedule Service Bar.

Tune to channel - exits the TV Guide On Screen system and tunes to the highlighted show.

Delete Recording - removes the recording from the Schedule, after a Confirm screen.

Edit Recording - opens a menu from which you can change existing recording information.

Set Reminder - opens a menu from which you can set a Reminder for the show (Record is not cancelled).

Cancel - closes the menu, changes no information, and returns to the highlighted show.



Setup

- After you complete the TV Guide On Screen system setup, you can come back and change its settings in the following areas:

- Change System Settings
- Change Channel Display
- Change Default Options

Highlight a choice, press **ENTER**, and follow the on-screen instructions.



With Setup highlighted, press the **Info** button to display a Help screen. Press the **Info** button again to close the screen.

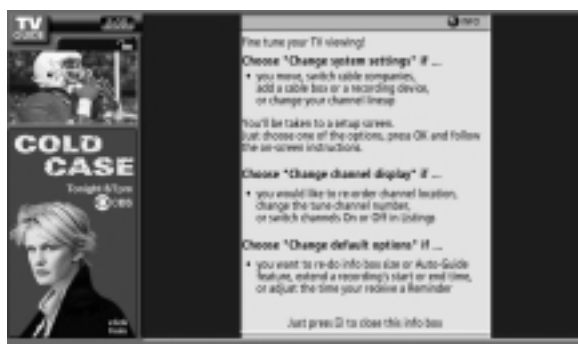

• Change System Settings

This option appears after you have completed the initial Guide Setup process.

Press **ENTER** to display the Confirming Your Settings screen. You see your current settings.

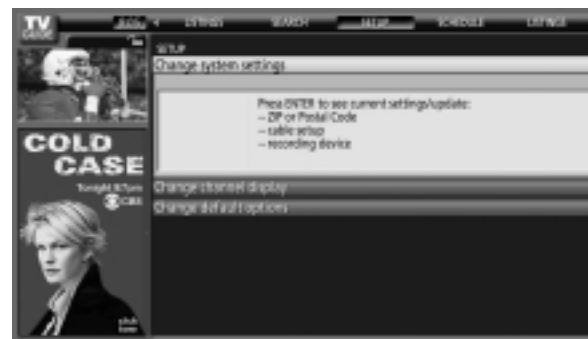

Choose one of the options, press **ENTER**, and follow the on-screen instructions.

Notes:

- If the stations in the Listings grid don't match the channel numbers in your area, choose the option "Yes, but my channel lineup is incorrect" to view more channel lineups available in your area.
- If none of the lineups listed match your lineup, use the Change Channel Display option to correct the stations and their corresponding tune channels.

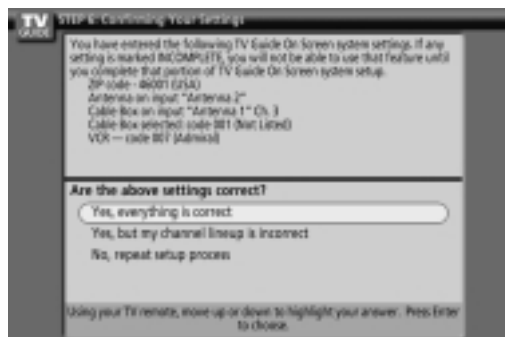

TV Guide On Screen™ System

• Change Channel Display

Change Channel Display lets you edit channel information that appears in Listings. With Change Channel Display you can:

- Change the position number to indicate where in the Listings the channel displays.
- Change the tune channel number
- Switch a channel
 - ◆ On - the channel is always displayed
 - ◆ Off - the channel is never displayed
 - ◆ Auto-Hide - the channel is only displayed when program information is available.

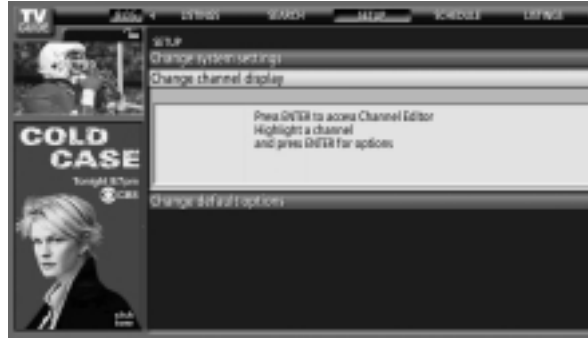

Press **ENTER** to display the Channel Editor screen.

Then, highlight a channel and press Menu. A Grid Options menu is displayed.

Highlight Go Back to Setup to close the menu, change no information, and return to the Setup Service Bar.

Or make changes and when finished, press **ENTER** to highlight Done. Press **ENTER** again to close the menu and accept the changes.



Highlight Cancel to close the menu, change no information, and return to the highlighted channel.

• **Change Default Options**

Change Default Options lets you change default settings in the following categories:

- General Default Options
- Record Defaults
- Remind Defaults

Highlight Change Default Options, and press **ENTER**.



<General Default Options>

General Default Options lets you set defaults for the following:

- The initial Info Box size when the TV Guide On Screen system is entered.
Choices are No, Small, Large, and Last Used (Default = Last Used).
- The Info Box size rotation when the Info key is pressed while in the TV Guide On Screen system.
Choices are No only, Small only, Large only, No & Small, No & Large, Small & Large, All (Default = All)
- Automatic entry into the TV Guide On Screen system (Auto-Guide) when the TV is powered On.
Choices are On and Off (Default = On).

Highlight General Default Options, and press the Menu key to display the General Default Options menu.

Highlight Go to Service Bar to close the menu, change no information, and return to the Setup Service Bar.

When finished, press **ENTER** to highlight Done. Press **ENTER** again to close the menu and accept the changes.

Highlight Cancel to close the menu, change no information, and return to the highlighted option.



TV Guide On Screen™ System

< Record Defaults>

Record Default Options lets you set defaults for the following:

- When to start the record event. Choices are 120 minutes early to 120 minutes late, to On time. (Default = On time)
- When to end the record event. Choices are 120 minutes early to 120 minutes late, to On time. (Default = On time)
- Recorder choice: Please choose the VCR only. This TV does not support other devices with a recording feature.



Highlight Record Defaults, and press the Menu key to display the Record Default Options menu.

Highlight Go to Service Bar to close the menu, change no information, and return to the Setup Service Bar.



< Remind Defaults>

Remind Default Options lets you set defaults for the following:

- Power On the TV, if Off, when a Reminder is scheduled. Choices are Yes and No. (Default = No)
- Automatically tune the TV to the channel (TV must be On), when a Reminder is scheduled. Choices are Yes and No. (Default = No)
- When to display the reminder screen. Choices are 30 seconds to 15 minutes early, to 30 seconds to 15 minutes late, to On time. (Default = 1 min early)

Highlight Remind Defaults, and press the Menu key to display the Remind Default Options menu.

Highlight Go to Service Bar to close the menu, change no information, and return to the Setup Service Bar.

When finished, press **ENTER** to highlight Done. Press **ENTER** again to close the menu and accept the changes.

Highlight Cancel to close the menu, change no information, and return to the highlighted option.

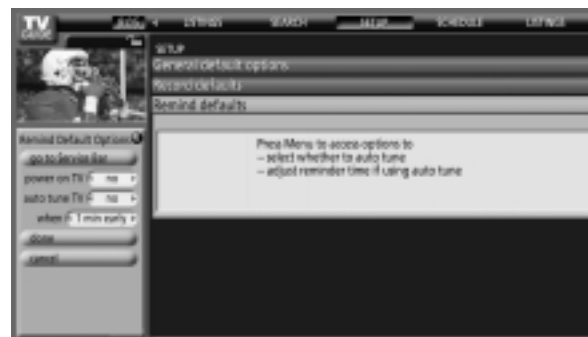

Record And Remind Features

Record

You can set a show to Record in Listings, Search, and Schedule or change Record settings for a show in Schedule.

There are 3 ways to set a show to Record:

1) Using the Record Button on the Remote





- Press the Record button on the remote to record the show Once with current default settings (Start and End recording On Time). Each time you press the Record button, you change the record frequency (but not the default settings) among Once (default), Regularly, Weekly, Off, and then Cancel.

Note: The proper Record icon appears on the show tile, as the Record button is pressed.

2) From a Panel Menu

- Highlight a show, and press Menu to display the Episode Options menu.
- Highlight Set Recording, and press **ENTER** to display the Record Options menu.
- Highlight the Frequency option, and use the left and right arrows to choose among Once, Regularly, Weekly, and Off, as previously described.
- Recorder choice: Please choose the VCR only. This TV does not support other devices with a recording feature.

Note: Video Window Lock is switched to on or off using PIP button in Listings mode.

- ◆ **Once** —records the show one time
- ◆ **Regularly** —records the show every time the show airs on the same channel and starts at the same time
- ◆ **Weekly** —records the show each time the show airs on the same day of the week, on the same channel and starts at the same time
- ◆ **Off (not cancel)** —keeps the show in the list but will not record this show until the frequency is changed
- ◆ **Cancel (no icon displayed)**—does not record



TV Guide On Screen™ System

When finished, press **ENTER** to highlight Schedule Recording.

Press **ENTER** again to close the menu. You see a Record icon for the selected frequency next to the show title.

Highlight Cancel to close the menu, change no information, and return to the highlighted show.



3) Manual Recording





- Highlight the Schedule Service label, and press Menu to display the Schedule Options menu.
- Use the **▲ / ▼ / ◀ / ▶** buttons to move through the options. Use the number or the **▲ / ▼ / ◀ / ▶** buttons to change the information, as necessary.
- Highlight New Manual Recording and press **ENTER** to display the Record Options menu.



- Current information (i.e., date, start and end times, channel, input) is displayed.
- Recorder choice: Please choose the VCR only. This TV does not provide other devices with a recording feature.



•Use the ◀ / ▶ buttons to choose among Once, Daily, Weekly, and Off, as follows.

- ◆ Once  —records the time, channel, input, recorder combination one time.
- ◆ Daily  —records the time, channel, input, recorder combination Monday through Friday.
- ◆ Weekly  —records the time, channel, input, recorder combination once a week on this selected day of the week
- ◆ Off (not cancel)  —keeps the time, channel, input, recorder combination in the list without recording until the frequency is changed.



When finished, press **ENTER** to highlight Schedule Recording.

Press **ENTER** again to close the menu. You see a Record icon for the selected frequency next to the show title.

Note: Manual recording is listed by channel number.

Highlight Cancel to close the menu, change no information, and return to the highlighted show.

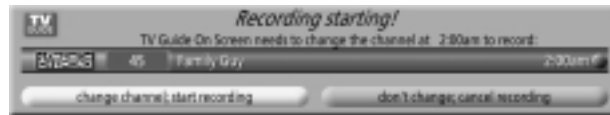

Before a recording begins, a notification screen appears if you are using a Cable box and your TV is On. At that time, you can choose to start or cancel recording. If the TV is not On, the recording occurs as scheduled. If there is no activity for 3 minutes, the notification screen automatically closes and completes the highlighted item.

Record Conflict

A conflict message appears for the following reasons:

- a show set to Record overlaps with any part of another show previously set to Record,
- a show set to Record overlaps with a show previously set to auto-tune

Select one of these options:

- ◆ record anyway - this show will override an existing show set to Record or auto-tune
- ◆ don't record this show - cancel the Recording

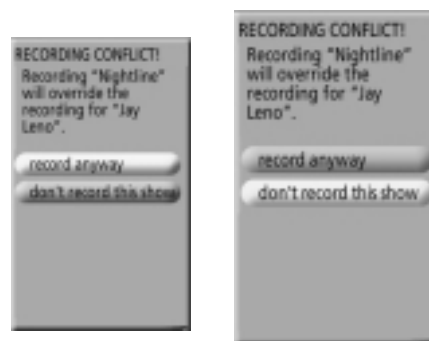

TV Guide On Screen™ System

Remind

You can set a show Reminder in Listings, Search, and Schedule or change Reminder settings for a show in Schedule. There are 2 ways to set a show Reminder:

1) From a Panel Menu

- Highlight a show, and press Menu to display the Episode Options menu.
- Highlight Set Reminder, and press **ENTER** to display the Remind Options menu.



- Highlight the Frequency option, and use the left and right arrows to choose among:

- ◆ Once —sets a show reminder one time
- ◆ Regularly —sets a show reminder every time the show airs on the same channel and starts at the same time
- ◆ Weekly —sets a show reminder each time the show airs on the same day of the week, on the same channel and starts at the same time
- ◆ Off —keeps the show in the list but will not remind until the frequency is changed



- Power On the TV, if Off, when a Reminder is scheduled. Choices are Yes and No. (Default = No)
- Automatically tune the TV to the channel (TV must be On), when a Reminder is scheduled. Choices are Yes and No. (Default = No)
- When to display the reminder screen. Choices are 30 seconds to 15 minutes early, to 30 seconds to 15 minutes late, to On time. (Default = 1 min early)



When finished, press **ENTER** to highlight Schedule Reminder. Press **ENTER** again to close the menu. You see a Remind icon for the selected frequency next to the show title. Highlight Cancel to close the menu, change no information, and return to the highlighted show.

2) Manual Reminder

- Highlight the Schedule Service label, and press the Menu key to display the Schedule Options menu.
- Use the ▲ / ▼ / ◀ / ▶ buttons to move through the options. Use the number or ▲ / ▼ / ◀ / ▶ buttons to change the information, as necessary.
- Highlight New Manual Reminder and press the ENTER key to display the Remind Options menu.
- Current information (i.e., date, start and end times, channel, input, frequency, etc.) is displayed.
- Highlight the Frequency option, and use the ◀ / ▶ buttons to choose among Once, Daily, Weekly, and Off, as follows.



- ◆ Once —sets a show reminder for the time, channel, input, destination combination one time
 - ◆ Daily —reminds for the time, channel, input, destination combination Monday through Friday
 - ◆ Weekly —sets a show reminder for the time, channel, input, destination combination once a week on this selected day of the week
 - ◆ Off (not cancel) —keeps the time, channel, input, destination combination in the list without reminding until the frequency is changed
- Power On the TV, if Off, when a Reminder is scheduled. Choices are Yes and No (Default =No).

- Automatically tune the TV to the channel (TV must be On), when a Reminder is scheduled. Choices are Yes and No (Default = No).

When finished, press ENTER to highlight Schedule Reminder. Press ENTER again to close the menu. You see a Remind icon for the selected frequency next to the show title.

Note: Manual reminder is listed by channel number.

Highlight Cancel to close the menu, change no information, and return to the highlighted show.

● TV Guide On Screen™ System

Based on your option settings, a notification screen will appear, if your TV is On at the reminder time. You can then choose to hide the reminder, or highlight the show, and press **ENTER** to tune to the show. If there is no activity for 3 minutes, the notification screen automatically closes and completes the highlighted item (hide reminders).

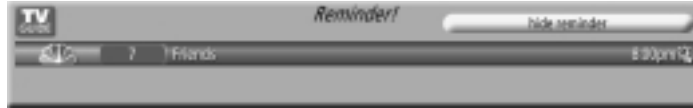

If you choose Hide Reminders, the window closes for the show or shows, but does not affect other Reminders you set.

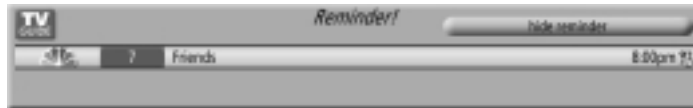

Note: If more than 2 reminders are set for the same time, arrows appear on the Reminder screen. Use the ▲ / ▼ buttons to view the shows.

Remind Conflict

A conflict message appears for the following reasons:

- a show set with an Auto-Tune Reminder has the same start time as an existing Auto-Tune Reminder.
- If you are using a cable box, a show set with an Auto-Tune Reminder overlaps with a Recording already scheduled.

Select one of these options:

- ◆ auto-tune anyway - this show will override an existing show set to auto-tune
- ◆ proceed, no auto-tune - set the show as a Reminder but do not auto-tune
- ◆ don't set this reminder - cancel the Reminder

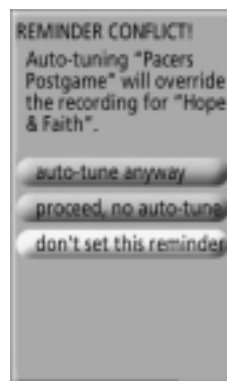
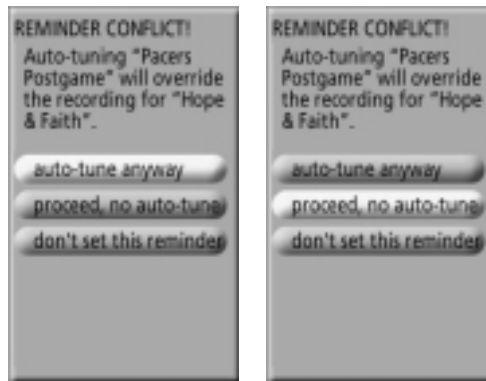

Operation

Turning the TV On

* In this manual, the OSD (On Screen Display) may be different from your TV's because it is just an example to help you with the TV operation.

Turning on the TV just after installation

1. Connect power cord correctly.
2. Press the **POWER** button on the TV. At this moment, the TV is switched to standby mode. Press the **TV INPUT**, **TV/VIDEO**, **CH (▲ / ▼)**, **Number (0 ~ 9)** button on the remote control or press the **CH (▲ / ▼)** button on the TV front panel and then the TV will switch on.

Turning on the TV (power cord is still connected)

1. If the TV was turned off with indicators on the TV

- Check the power cable.

2. If the TV was turned off with the remote control and the **POWER** button on the TV

- Press the **POWER** button on the TV or press the **POWER**, **TV/VIDEO**, **CH (▲ / ▼)**, **Number (0 ~ 9)** button on the remote control to turn the TV on.

Notes:

- If you intend to be away on vacation, disconnect the power plug from the wall power outlet.
- The TV Guide On Screen and any CableCARD™ Software upgrades work while the TV is in standby mode. If you pull the power plug cord the TV Guide On Screen will not update its listings and no CableCARD™ Software upgrades will occur.
- After turning on the TV, it could take up to a week for the TV Guide On Screen system to receive full listings data.

● TV Setup

On-screen Menu Language Selection

- The menus can be shown on the screen in the selected language. First select your language.

1. Press the **MENU** button and then use ▲ / ▼ button to select the **OPTION** menu.
2. Press the ► button and then use ▲ / ▼ button to select **Language**.
3. Press the ► button and then use ▲ / ▼ button to select your desired language. From this point on, the on-screen menu will be shown in the selected language.
4. Press **EXIT** button to return to TV viewing or press **MENU** button to return to the previous menu.



Setup Menu Options

EZ Scan (Channel Search)

- Automatically finds all channels available through antenna or cable inputs, and stores them in memory on the channel list.
- Run EZ Scan again after any Antenna/Cable connection changes.
- A password is required to gain access to EZ Scan menu if the Lock System is turned on.

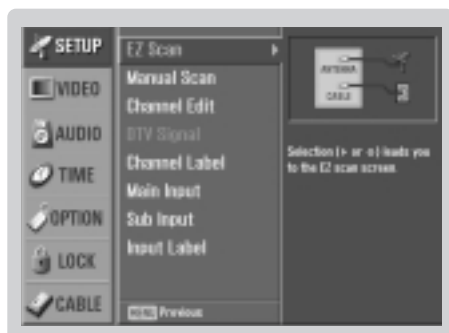

1. Press the **MENU** button and then use **▲ / ▼** button to select the **SETUP** menu.
2. Press the **▶** button and then use **▲ / ▼** button to select **EZ Scan**.
3. Press the **▶** button or **ENTER** button to begin the channel search.
Allow EZ Scan to complete the channel search cycle for TV, DTV, CATV, and CADTV.

Manual Scan

- A password is required to gain access to Manual Scan menu if the Lock System is turned on.

1. Press the **MENU** button and then use **▲ / ▼** button to select the **SETUP** menu.
2. Press the **▶** button and then use **▲ / ▼** button to select **Manual Scan**.
3. Press the **▶** button and then use **▲ / ▼** button to select TV/CADTV/CATV/DTV.
4. Press the **▶** button and then use **▲ / ▼** button to select channel number you want to add or delete.
5. Press the **ENTER** button to add or delete for the channel number.
6. Press **EXIT** button to return to TV viewing or press **MENU** button to return to the previous menu.

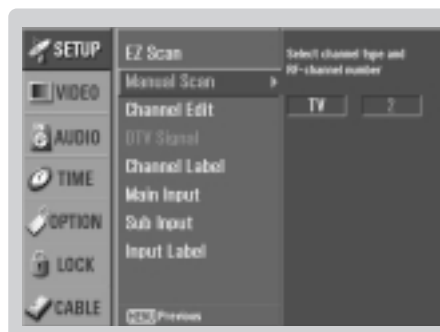

Notes

- This channel number is a physical channel number, which is different from the normal channel number shown in Channel Edit.
- When a cable box connects to the physical channel 2, 3 or 4 in the TV Guide On Screen system Setup, cable channels (CATV or CADTV) will not be scanned by EZ Scan or Manual Scan.
- When CableCARD™ is inserted, CATV and CADTV is not working in EZ Scan and Manual Scan.

Setup Menu Options

Channel Edit

- Create two different types of channel lists in memory: "Custom List" and "Favorite List" from the default channel list created from the EZ Scan channel search.
- A Custom List can be created by toggling each channel on or off with **ENTER** button. The channels in the Custom List are displayed in black color, and the channels deleted from the Custom List are displayed in gray color. Once a channel is highlighted you can add or delete the channel by referring to the small window at the top-left corner of the screen. You can create your own Favorite List.
Use the **FAV** button on the remote control when a channel is highlighted and then you can add or delete the channel to/from the Favorite List.



1. Press the **MENU** button and then use **▲ / ▼** button to select the **SETUP** menu.
2. Press the **▶** button and then use **▲ / ▼** button to select **Channel Edit**.
3. Press the **▶** button. You will now see a screen filled with channel numbers and a preview picture.
4. Use **▲ / ▼ / ◀ / ▶** button to select a channel and then use the **ENTER** button to add or delete it. Press **FAV** to add or delete the channel to the Favorite List.
5. Press **EXIT** button to return to TV viewing or press **MENU** button to return to the previous menu.



Note:

- When a cable box connects to the physical channel 2, 3, or 4 in TV Guide On Screen Setup, cable channels(CATV or CADTV) will not be editable by Channel Edit. Instead, use the cable box's Channel Edit if available.

DTV Signal Strength

- Shows how strong your DTV signal is and whether you need to adjust your antenna or digital cable input. The higher the signal strength, the less likely you are to experience picture degradation.
- DTV Signals: When input signals are DTV, CADTV, this function is available.

1. Press the **SIGNAL** button.
2. View the on-screen signal strength monitor to see the quality of the signal being received.
 - You can also check the **DTV Signal** strength with the **SETUP** menu.

Channel Label Setup

- Choose preset labels for your channels.
- If a channel label is provided on the signal from the broadcasting station, the TV displays a short name for a DTV channel - even if you didn't preset a label for the channel.

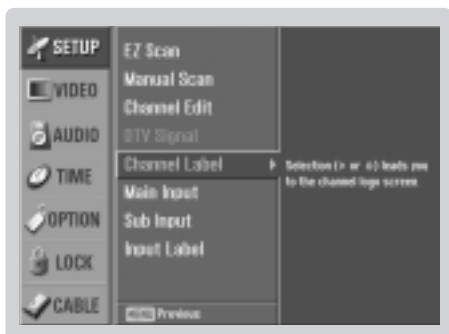

1. Press the **MENU** button and then use **▲ / ▼** button to select the **SETUP** menu.
2. Press the **▶** button and then use **▲ / ▼** button to select **Channel Label**.
3. Press the **▶** button. You will now see a screen filled with Labels and a preview screen.
4. Use the **CH ▲ / ▼** button to select a channel to Label.
5. Use **▲ / ▼ / ◀ / ▶** button to select the appropriate label for the channel, then press **ENTER** button to set the Label to the selected channel.

- If you press **ENTER** button in TV viewing mode, you will see the channel banner. -----▶



Main Picture Source Selection

- Changes the picture source so you can watch your off-air TV, cable TV, VCR, DVD, or any other devices that are connected to your TV.

1. Press the **MENU** button and then use **▲ / ▼** button to select the **SETUP** menu.
2. Press the **▶** button and then use **▲ / ▼** button to select **Main Input**.
3. Press the **▶** button and then use **▲ / ▼** button to select the source: Antenna, Cable, Video1, Video2, Front Video, Component1, Component2, RGB-DTV (or RGB-PC), HDMI1/DVI or HDMI2.
4. Press **EXIT** button to return to TV viewing or press **MENU** button to return to the previous menu.

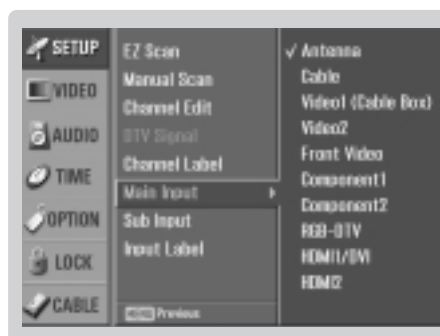

Input Label

1. Press the **MENU** button and then use **▲ / ▼** button to select the **SETUP** menu.
2. Press the **▶** button and then use **▲ / ▼** button to select **Input Label**.
3. Press the **▶** button and then use **▲ / ▼** button to select the source: Video1, Video2, Front Video, Component1, Component2, RGB, HDMI1/DVI or HDMI2.
4. Press **EXIT** button to return to TV viewing or press **MENU** button to return to the previous menu.

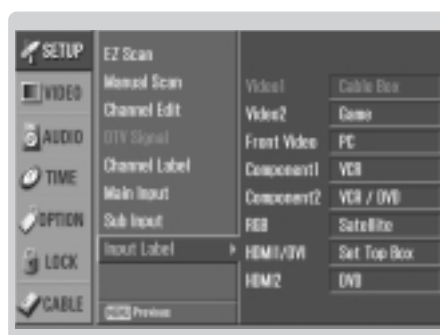

Video Menu Options

EZ Picture

- EZ Picture adjusts the TV for the best picture appearance. Select the preset value in the EZ Picture menu based on the program category.
- When adjusting Video menu options (contrast, brightness, color, sharpness, tint, and color temperature) manually, EZ Picture automatically changes to **Custom**.
- **Daylight, Normal, Night Time, Movie, Video Game**, and **Sports** settings are preset for optimum picture quality at the factory and are not adjustable.

1. Press the **EZ PIC** button repeatedly to select the picture appearance setup option as shown below:
Custom (your own settings), **Daylight, Normal, Night Time, Movie, Video Game**, and **Sports**.
 • You can also use the **VIDEO** menu to adjust **EZ Picture**.
2. Press the **EXIT** button to save and return to TV viewing.

Manual Picture Control (**Custom** option)

- Adjust the picture appearance to suit your preference and viewing situations.

1. Press the **MENU** button and then use **▲ / ▼** button to select the **VIDEO** menu.
2. Press the **▶** button and then use **▲ / ▼** button to select the desired picture option (**Contrast, Brightness, Color, Sharpness, or Tint**).
3. Press the **▶** button and then use **◀ / ▶** button to make appropriate adjustments.
4. Press **EXIT** button to return to TV viewing or press **MENU** button to return to the previous menu.



Color Temperature Control

- Choose one of three automatic color adjustments. Set to warm to enhance hotter colors such as red, or set to cool to see less intense colors with more blue.

1. Press the **MENU** button and then use **▲ / ▼** button to select the **VIDEO** menu.
2. Press the **▶** button and then use **▲ / ▼** button to select **Color Temperature**.
3. Press the **▶** button and then use **▲ / ▼** button to select either **Cool, Medium, or Warm**.
4. Press **EXIT** button to return to TV viewing or press **MENU** button to return to the previous menu.



Video Reset

- Use to quickly reset all the Video menu options to their original factory preset values.

1. Press the **MENU** button and then use **▲ / ▼** button to select the **VIDEO** menu.
2. Press the **▶** button and then use **▲ / ▼** button to select **Video Reset**.
3. Press the **▶** button to reset the Video menu options to original values.



Audio Menu Options

Audio Language

- Other languages may be available if a digital signal is provided by the broadcasting station.

1. Press the **MENU** button and then use **▲ / ▼** button to select the **AUDIO** menu.
2. Press the **▶** button and then use **▲ / ▼** button to select **Audio Language**.
3. Press the **▶** button and then use **▲ / ▼** button to select: English, Spanish, or French.
4. Press **EXIT** button to return to TV viewing or press **MENU** button to return to the previous menu.

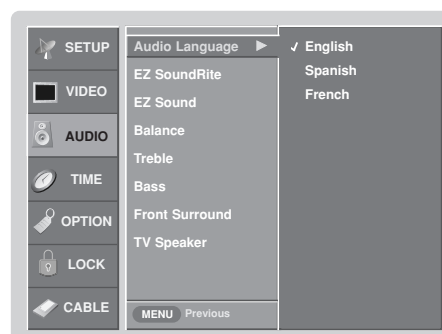

EZ SoundRite

- Scans for changes in sound level during commercials, then adjusts the sound to match the specified audio level. SoundRite makes sure that the volume level remains consistent whether you are watching a commercial or a regular TV program.

1. Press the **MENU** button and then use **▲ / ▼** button to select the **AUDIO** menu.
2. Press the **▶** button and then use **▲ / ▼** button to select **EZ SoundRite**.
3. Press the **▶** button and then use **▲ / ▼** button to select **On** or **Off**.
4. Press **EXIT** button to return to TV viewing or press **MENU** button to return to the previous menu.

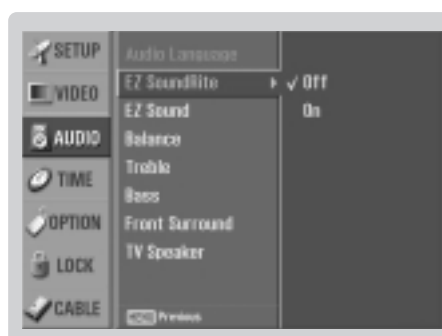

EZ Sound

- EZ Sound lets you enjoy the best sound without any special adjustment because the TV sets the appropriate sound options based on the program content.
- When adjusting sound options (treble, bass, and front surround) manually, EZ Sound automatically switches **Custom**.
- **Normal, Stadium, News, Music** and **Theater** are preset for good sound quality at the factory and are not adjustable.

1. Press the **EZ SOUND** button repeatedly to select the appropriate sound setup as shown below:
 - **Custom** (your own settings), **Normal, Stadium, News, Music** and **Theater**.
 - You can also adjust **EZ Sound** in the **AUDIO** menu.
2. Press **EXIT** button to save and return to TV viewing.

Manual Sound Control (**Custom** option)

- Adjust the sound to suit your taste and room situations.

1. Press the **MENU** button and then use **▲ / ▼** button to select the **AUDIO** menu.
2. Press the **▶** button and then use **▲ / ▼** button to select the desired sound option (**Balance, Treble, or Bass**).
3. Press the **▶** button and then use **◀ / ▶** button to make appropriate adjustments.
4. Press **EXIT** button to return to TV viewing or press **MENU** button to return to the previous menu.



Audio Menu Options

Front Surround

-  is a trademark of SRS Labs, Inc.
- TruSurround XT technology is incorporated under license from SRS Labs, Inc.
- Manufactured under license from Dolby Laboratories. "Dolby" and the double-D symbol are trademarks of Dolby Laboratories.

1. Press the **MENU** button and then use **▲ / ▼** button to select the **AUDIO** menu.
2. Press the **▶** button and then use **▲ / ▼** button to select **Front Surround**.
3. Press the **▶** button and then use **▲ / ▼** button to select **Off**, **3D EchoSound System** or **SRS** (Sound Retrieval System) **TruSurround XT**.

• 3D EchoSound System

Creates a stunning simulated stereo effects from any mono sound and a realistic three-dimensional sound with a very wide and deep sound stage into stereo sound

• SRS TruSurround XT

Takes advantage of any multi-channel format without needing to add extra speakers or equipment. Dialog clarity, bass enrichment, and the addition of stereo audio enhancement that produces an immersive sound experience from standard stereo material.

4. Press **EXIT** button to return to TV viewing or press **MENU** button to return to the previous menu.



TV Speaker On/Off Setup

- Turn TV speaker off if using external audio equipment. Feature turns the TV Speaker option On or Off.

1. Press the **MENU** button and then use **▲ / ▼** button to select the **AUDIO** menu.
2. Press the **▶** button and then use **▲ / ▼** button to select **TV Speaker**.
3. Press the **▶** button and then use **▲ / ▼** button to select **On** or **Off**.
4. Press **EXIT** button to return to TV viewing or press **MENU** button to return to the previous menu.



Stereo/SAP Broadcasts Setup

- This TV can receive MTS stereo programs and any SAP (Secondary Audio Program) that accompanies the stereo program; if the station transmits an additional sound signal as well as the original one.
- When having selected Stereo or SAP button on the remote control, this TV can only receive the signal in case that the TV station transmits the proper signals.
- Mono sound is automatically received if the broadcast is only in Mono; even though Stereo or SAP has been selected.
- Select Mono if you want to listen to the mono sound in remote fringe areas during stereo/SAP broadcasting.
- Stereo or SAP can be received in Analog channel.

1. Use the **SAP** button to select your desired MTS mode in analog signal. Each time you press the **SAP** button, **Mono**, **Stereo**, or **SAP** appear in turn.
 - If other languages available on the digital signal, select them with the **SAP** button.
2. Press **EXIT** button to save and return to TV viewing.

Time Menu Options

Auto Clock Setup

- The time is set automatically from a digital channel signal.
- The digital channel signal includes information for the current time provided by the broadcasting station.
- Set the clock manually, if the current time is set incorrectly by the auto clock function.
- When you set up TV Guide, **Auto Clock** menu is not selected.

1. Press the **MENU** button and then use **▲ / ▼** button to select the **TIME** menu.
2. Press the **▶** button and then use **▲ / ▼** button to select **Auto Clock**.
3. Press the **▶** button and then use **▲ / ▼** button to select **On**.
4. Press the **▶** button and then use **▲ / ▼** button to select your viewing area time zone: **Eastern, Central, Mountain, Pacific, Alaska, or Hawaii**.
5. Press the **▶** button and then use **▲ / ▼** button to set Daylight Saving **Auto, Off** or **On**, depending on whether or not your viewing area observes Daylight Savings Time.
6. Press **EXIT** button to return to TV viewing or press **MENU** button to return to the previous menu.

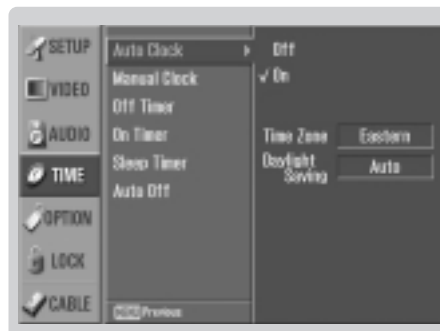

Manual Clock Setup

- If current time setting is wrong, reset the clock manually.
- When you set up TV Guide, **Manual Clock** menu is not worked.

1. Press the **MENU** button and then use **▲ / ▼** button to select the **TIME** menu.
2. Press the **▶** button and then use **▲ / ▼** button to select **Manual Clock**.
3. Press the **▶** button and then use **◀ / ▶** button to select either the year, date, or time option. Once selected, use the **▲ / ▼** button to set the year, date, and time options.
4. Press **EXIT** button to return to TV viewing or press **MENU** button to return to the previous menu.



On/Off Timer Setup

- Timer function operates only if current time has been set.
- Off-Timer function overrides On-Timer function if they are both set to the same time.
- The TV must be in standby mode for the On-Timer to work.
- If you do not press any button within 2 hours after the TV turns on with the On Timer function, the TV will automatically revert to standby mode.

1. Press the **MENU** button and then use **▲ / ▼** button to select the **TIME** menu.
2. Press the **▶** button and then use **▲ / ▼** button to select **Off Timer** or **On Timer**.
3. Press the **▶** button and then use **▲ / ▼** button to select **On**.
 - To cancel **On/Off timer** function, select **Off**.
4. Press the **▶** button and then use **▲ / ▼** button to set the hour.
5. Press the **▶** button and then use **▲ / ▼** button to set the minutes.
6. **For only On timer function**
 - Press the **▶** button and then use **▲ / ▼** button to select the channel at turn-on.
 - Press the **▶** button and then use **▲ / ▼** button to set the sound level at turn-on.
7. Press **EXIT** button to return to TV viewing or press **MENU** button to return to the previous menu.



Time Menu Options

Sleep Timer

- The Sleep Timer turns the TV off at the preset time. Note that this setting is cleared when the TV is turned off.
 - You can also set up the **Sleep Timer** in the **TIME** menu.
1. Press the **TIMER** button repeatedly to select the number of minutes. First the **Off** option appears on the screen, followed by the following sleep timer options: 10, 20, 30, 60, 90, 120, 180, and 240 minutes.
 2. When the number of minutes you want is displayed on the screen, press the **OK** button. The timer begins to count down from the number of minutes selected.
 3. To check the remaining minutes before the TV turns off, press the **TIMER** button once.
 4. To cancel the Sleep Timer, press the **TIMER** button repeatedly to select **Off**.

Auto Off

- If set to on and there is no input signal, the TV turns off automatically after 10 minutes.
1. Press the **MENU** button and then use **▲ / ▼** button to select the **TIME** menu.
 2. Press the **▶** button and then use **▲ / ▼** button to select **Auto Off**.
 3. Press the **▶** button and then use **▲ / ▼** button to select **On** or **Off**.
 4. Press **EXIT** button to return to TV viewing or press **MENU** button to return to the previous menu.



Option Menu Options

Aspect Ratio Control

- Lets you choose the way an analog picture with a 4:3 aspect ratio is displayed on your TV with a 16:9 ratio picture format. When you receive an analog picture with a 4:3 aspect ratio on your 16:9 TV, you need to specify how the picture is to be displayed.
- If you are viewing a picture with a 16:9 aspect ratio, you can't use the Horizon aspect ratio option.
- Horizon aspect ratio is not available for Component 1-2 (720p/1080i)/RGB-DTV (720p/1080i)//HDMI1/DVI-DTV (720p/1080i)/DTV(720p/1080i), HDMI2-DTV(720p/1080i) input source.
- RGB-PC/DVI-PC input source use 4:3 or 16:9 aspect ratio.

1. Press the **RATIO** button repeatedly to select the desired picture format. You can also adjust **Aspect Ratio** in the **OPTION** menu.

• Set By Program

Selects the proper picture proportion to match the source's image. (4:3 → 4:3, 16:9 → 16:9)

• 4:3

Choose **4:3** when you want to view a picture with an original 4:3 aspect ratio, with black bars appearing at both the left and right sides.

• 16:9

Choose **16:9** when you want to adjust the picture horizontally, in a linear proportion to fill the entire screen.

• Horizon

Choose **Horizon** when you want to adjust the picture in a non-linear proportion, that is, more enlarged at both sides, to create a spectacular view.

• Zoom 1

Choose **Zoom 1** when you want to view the picture without any alteration. However, the top and bottom portions of the picture will be cropped.

• Zoom 2

Choose **Zoom 2** when you want the picture to be altered, both horizontally extended and vertically cropped. The picture taking a halfway trade off between alteration and screen coverage.

• Cinema Zoom

Choose **Cinema Zoom** when you want to enlarge the picture in correct proportion. Note: When enlarging or reducing the picture, the image may become distorted.

You can adjust the enlarge proportion of Cinema Zoom using ▲ / ▼ button. The adjustment range is 1~16.

Cinema 3:2 Mode Setup

Set up the TV for the best picture appearance for viewing movies.

1. Press the **MENU** button and then use ▲ / ▼ button to select the **OPTION** menu.
2. Press the ► button and then use ▲ / ▼ button to select **Cinema 3:2 Mode**.
3. Press the ► button and then use ▲ / ▼ button to select **On** or **Off**.
4. Press **EXIT** button to return to TV viewing or press **MENU** button to return to the previous menu.



Option Menu Options

Caption

1. Press the **MENU** button and then use **▲ / ▼** button to select the **OPTION** menu.
2. Press the **▶** button and then use **▲ / ▼** button to select **Caption**.
3. Press the **▶** button and then use **▲ / ▼** button to select **On** or **Off**.
4. Press **EXIT** button to return to TV viewing or press **MENU** button to return to the previous menu.

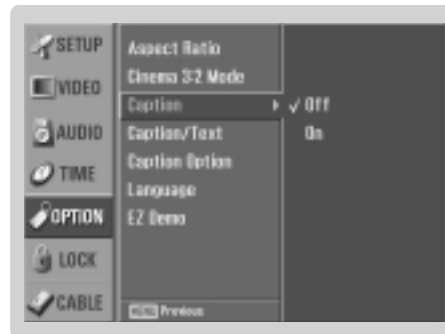

Caption/Text

Analog Broadcasting System Captions

- Select a caption mode for displaying captioning information if provided on a program.
- Analog caption displays information at any position on the screen usually the program's dialog.
- Text displays information, usually at the bottom position and is used for a data service, generally not program related.
- Caption/Text, if provided by the broadcaster, would be available for both digital and analog channels on the Antenna/Cable.
- This TV is programmed to remember the caption/text mode it was last set to, when you turn the power off.

1. Use the **CC** button repeatedly to select Caption **CC1, CC2, CC3, CC4, Text1, Text2, Text3, or Text4**.
 - **EZ Mute** shows the selected captions option (if available on program) when the TV sound is muted
2. Press **EXIT** button to save and return to TV viewing.

• You can also use the **OPTION** menu to select **Caption/Text**.

1. Press the **MENU** button and then use **▲ / ▼** button to select the **OPTION** menu.
2. Press the **▶** button and then use **▲ / ▼** button to select **Caption/Text**.
3. Press the **▶** button and then use **▲ / ▼** button to select caption: **CC1, CC2, CC3, CC4, Text1, Text2, Text3, or Text4**.

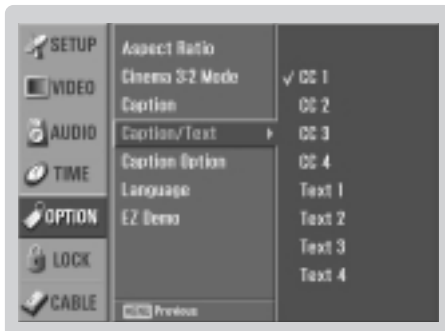

• CAPTION

The term for the words that scroll across the bottom of the TV screen; usually the audio portion of the program provided for the hearing impaired.

• TEXT

The term for the words that appear in a large black frame and almost cover the entire screen; usually messages provided by the broadcaster.

4. Press **EXIT** button to return to TV viewing or press **MENU** button to return to the previous menu.

Digital Broadcasting System Captions

- Choose the language you want the DTV/CADTV Captions to appear in.
- Languages can be chosen for digital sources only if they are included on the program.

1. Press the **MENU** button and then use **▲ / ▼** button to select the **OPTION** menu.
2. Press the **▶** button and then use **▲ / ▼** button to select **Caption/Text**.
3. Press the **▶** button and then use **▲ / ▼** button to select available caption languages: **English, Spanish, or French**.
4. Press **EXIT** button to return to TV viewing or press **MENU** button to return to the previous menu.

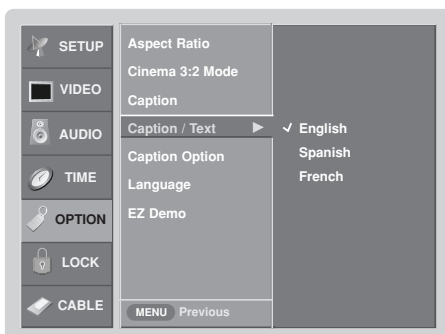

Caption Option

- Customize the DTV/CADTV captions that appear on your screen.

1. Press the **MENU** button and then use ▲ / ▼ button to select the **OPTION** menu.
2. Press the ► button and then use ▲ / ▼ button to select **Caption Option**.
3. Press the ► button and then use ◀ / ▶ button to select **Custom**.

4. Use ▲ / ▼ button to customize the Style, Font, etc., to your preference. A preview icon is provided at the bottom of the screen, use it to see the caption language.



- **Size:** Set the size the words will appear in.
- **Font:** Select a typeface for the words.
- **Text Color:** Choose a color for the text.
- **Text Opacity:** Specify the opacity for the text color.
- **Bg (Background) Color:** Select a background color.
- **Bg (Background) Opacity:** Select the opacity for the background color.
- **Edge Type:** Select an edge type.
- **Edge Color:** Select a color for the edges.

5. Press **EXIT** button to return to TV viewing or press **MENU** button to return to the previous menu.

EZ Demo

Shows you how to navigate the TV's on-screen menus.

EZ Demo Use to scan the features and menu options available on your TV.

1. Press the **MENU** button and then use ▲ / ▼ button to select the **OPTION** menu.
2. Press the ► button and then use ▲ / ▼ button to select **EZ Demo**, then use the ► button to start EZ Demo.
3. Press **EXIT** button to stop EZ Demo.

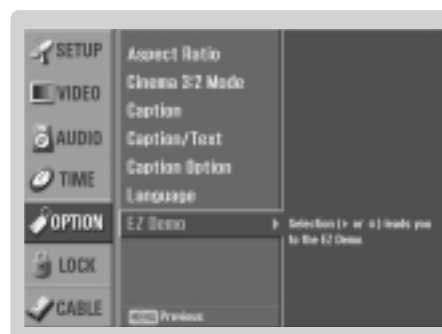

Lock Menu Options

Parental Control can be used to block specific channels, ratings and other viewing sources.

The Parental Control Function (V-Chip) is used to block program viewing based on the ratings sent by the broadcasting station. The default setting is to allow all programs to be viewed. Viewing can be blocked by the type of program and by the categories chosen to be blocked. It is also possible to block all program viewing for a time period. To use this function, the following must be done :

1. Set ratings and categories to be blocked.
2. Specify a password
3. Enable the lock

V-Chip rating and categories

Rating guidelines are provided by broadcasting stations. Most television programs and television movies can be blocked by TV Rating and/or Individual Categories. Movies that have been shown at the theaters or direct-to-video movies use the Movie Rating System (MPAA) only.

Ratings for Movies previously shown in theaters:

Movie Ratings :

- Blocking Off (Permits all programs)
- G (General audience)
- PG (Parental guidance suggested)
- PG-13 (Parents strongly cautioned)
- R (Restricted)
- NC-17 (No one 17 and under admitted)
- X (Adult only)

If you set PG-13 : G and PG movies will be available , PG-13, R, NC-17 and X will be blocked.

Ratings for Television programs including made-for-TV movies :

- TV-G (General audience)
- TV-PG (Parental guidance suggested)
- TV-14 (Parents strongly cautioned)
- TV-MA (Mature audience only)
- TV-Y (All children)
- TV-Y7 (Children 7 years older)

TV Rating Children:

- Age (applies to TV-Y, TV-Y7)
- Fantasy Violence (applies to TV-Y7)

TV Rating General:

- Age (applies to TV-G, TV-PG, TV-14, TV-MA)
- Dialogue - sexual dialogue (applies to TV-PG, TV-14)
- Language - adult language (applies to TV-PG, TV-14, TV-MA)
- Sex - sexual situations (applies to TV-PG, TV-14, TV-MA)
- Violence (applies to TV-PG, TV-14, TV-MA)

Input Block

- Video 1, 2, Front Video (On, Off)
- Component 1, 2 (On, Off)
- RGB, HDMI1/DVI or HDMI2 (On, Off)

Parental Lock Setup

- Set up blocking schemes to block specific channels, ratings, and external viewing sources.
- A password is required to gain access to this menu.

1. Press the **MENU** button and then use **▲ / ▼** button to select the **LOCK** menu. Then, press the **►** button

- Enter the password as requested.
- The TV is set up with the initial password "0-0-0-0".

2. Use the **▲ / ▼** button to choose from the following Lock Menu options. Once the option is selected, change the settings to your preference.

- **Lock System:** Activates or disables the blocking scheme you set up previously.
- **Set Password:** Change the password by inputting a new password twice.
- **Block Channel:** Blocks any channels that you do not want to watch or that you do not want your children to watch.
- **Movie Rating (MPAA):** Blocks movies according to the movie ratings limits specified, so children cannot view certain movies. You can set the ratings limit by blocking out all the movies with the ratings above a specified level. Keep in mind that the movie ratings limit only applies to movies shown on TV, not TV programs, such as soap operas.
- **TV Rating-Children:** Prevents children from watching certain children's TV programs, according to the ratings limit set. The children rating does not apply to other TV programs. Unless you block certain TV programs intended for mature audiences in the TV Rating - sub menu, your children can view those programs.
- **TV Rating-General:** Based on the ratings, blocks certain TV programs that you and your family do not want to view.
- **Input Block:** Enables you to select a source to block from the external source devices you have hooked up.

3. Press **EXIT** button to return to TV viewing or press **MENU** button to return to the previous menu.

Note : If you ever forget your password, key in '7', '7', '7', '7' on the remote control.

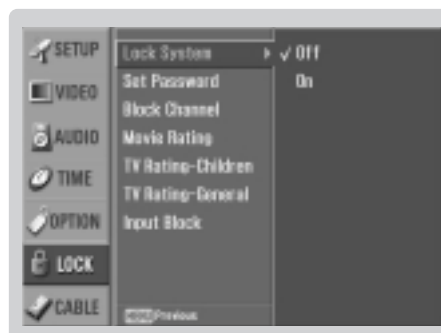

CableCARD™ Function

* In this manual, the OSD (On Screen Display) may be different from your TV's because it is just example to help the TV operation.

Cable menu options

- The Cable sub menu displays when inserting the CableCARD™ to the TV.
- The CableCARD™ type is Motorola, Scientific Atlanta (SA), or SCM etc. The OSD (On screen display) is different from your TV according to your CableCARD™ type.

1. Press the **MENU** button and then use ▲ / ▼ button to select the **CABLE** menu.
2. Press the ► button and then use ▲ / ▼ button to select your desired item.
3. Press the ► button.
4. Press **EXIT** button to return to TV viewing.

In case of Scientific Atlanta CableCARD™

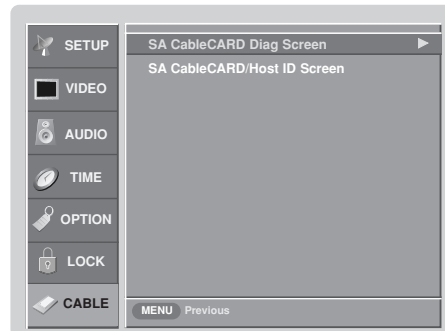

i.e) CableCARD™/ Host ID Screen

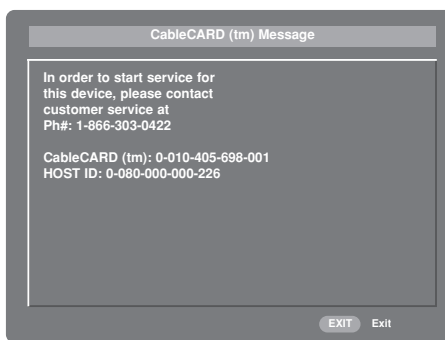

As shown, the pairing number means your TV and CableCARD™ ID. For further information regarding cable TV service, contact your local cable TV service provider(s).

Scrambled channel

- Insert the CableCARD™. If you do it at first, it takes about 1 minute to exchange the data between the TV and the CableCARD™. Then, TV screen displays as shown right.
- Let your cable TV service provider know CableCARD™ ID and Host ID.
- If your cable TV service provider is registered CableCARD™ ID and Host ID, you can watch the premium or high value channel.
- If you ever registered to the cable TV service provider, you can watch the premium or high value channel without a message.

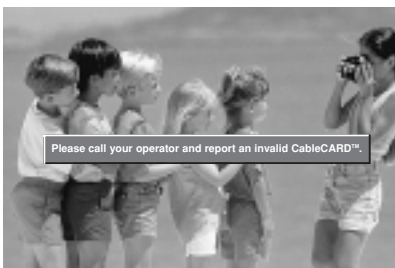
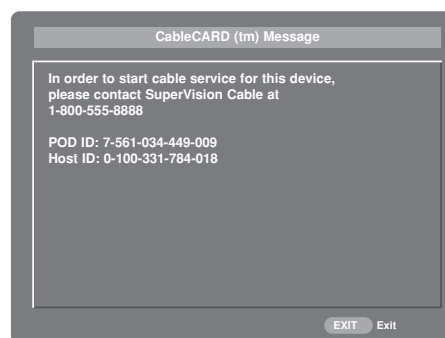

- If the certificate doesn't match between the TV and the cableCARD™, the OSD (On screen display) displays as shown left.

Cable Channel List

- 

1. The TV Setup menu is shown with 'Channel Edit' selected. A note indicates that pressing the right arrow key leads to the EZ Scan screen.
- 

2. The TV Setup menu is shown with 'Channel Edit' selected. A sub-note indicates that pressing the right arrow key leads to the channel edit screen.
- 

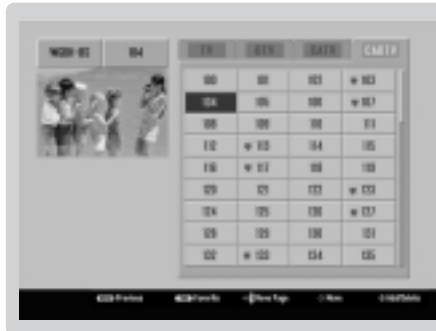
3. The Cable Channel List screen is shown. It displays a grid of channels with their respective numbers and names. The channels are listed in a grid format with columns for 'CABLE', 'SATV', 'SATV', and 'CABLE'.
- 

4. The Cable Channel List screen is shown after inserting the CableCARD. The grid of channels is updated to reflect the new cable channel list.

1. If you enter the **Channel Edit** after running the EZ Scan without CableCARD™, you can see the cable channel list as the picture 3 above.
2. Insert the CableCARD™. Then, the TV receive a new cable channel list which is usually one part channel. It takes about 2~3 minutes to gather the cable channel list after inserting the CableCARD™ as the picture 4 above. (Occasionally more than that time)

Note:

- As data gathering of CableCARD™, it may make a noise by fan in standby mode.

Emergency Alert Message

- If an emergency situation occurs during watching the TV/DTV/CATV/CADTV, you can receive a message from cable TV service provider(s).
- When receiving an emergency message, the message is displayed on the screen as shown below or the channel is changed automatically to a channel that maintains the emergency message. The message will automatically disappear after some time.





- You can use the JPEG and MP3 file by memorizing to Memory card in **XSTUDIO** mode.

Notes on Memory Card

Memory Card

This is a device equipment to communicate the data between AV external equipment. It's used to a digital camera, camcorder, MP3 player, notebook or PDA.

Precaution for Using the Memory Card

- Please be sure to insert the correct memory card type in the right direction.
(Confirm between the two memory slots before insertion.)
- Don't insert the metal substances into the slots of the memory card.
- Do not bend, drop or apply strong shock to memory card.
- After pulling the memory card out from the TV, please keep the memory stick in a appropriate case to prevent it from static shock.
- The stored data may be changed or lost as a result of misuse, static electricity.
- Do not turn the power off while the memory card is in operation.
- Don't eject the memory card while in use. Otherwise, it may cause a data loss or card damage.
- Insert only one card to each slot.
- To prevent a change or loss for stored data, don't misuse the TV or don't let static electricity or electrical noise for TV.
- This Company takes no responsibility for problems such as the damage or malfunction that occurs while using the TV set, inappropriate TV settings, or any other reasons, except for defects or malfunctions intrinsic to the product.
- Ensure to use a memory card that lists the manufacturers name and serial number.
- The manufacturer will not be responsible for any data damage. Making back up data is strongly recommended.
- Make sure to comply with the following steps when ejecting a memory card.
- Each Memory Card is complied with standard.

Available Memory Card

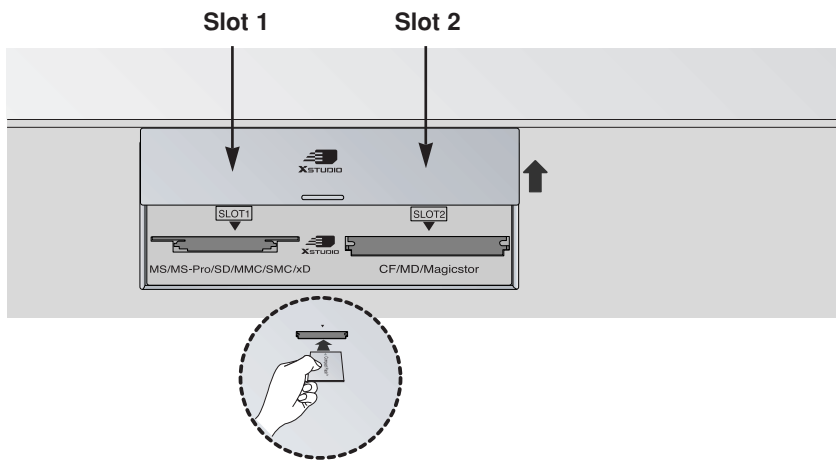

Memory Card type

- Use the specified card based on the slot location.
- 8 types of Memory Card can be used for this set.
- NTFS file system is not supported.

| Slot 1 | | | | | Slot 2 | | |
|--------------------------|------------------------|---------------------------|-------------------------|---|----------------------|--------------------|-----------|
| | | | | | | | |
| MMC (MultiMedia Card) | SD (Secure Digital) | SMC (Smart Media Card) | XD (xD-Picture Card) | MS / MS pro (Memory Stick /Memory Stick Pro) | CF (CompactFlash) | MD (Microdrive) | Magicstor |





Available file in XSTUDIO mode

| A sort of file | Photo Image (JPEG) | Music File (MP3) |
|-----------------------------|--|---|
| Compatibility | *.jpg | *.mp3 |
| Memory card capacity | CF: 2GB Microdrive: 2GB Magicstor: 2.2GB MMC: 256MB SD: 512MB - Some MagicStor Plus card is not complied with the TV. An error may occur if you use a memory card with greater than the specified capacity. | SMC: 128MB XD: 512MB MS: 128MB MS PRO: 1GB |
| Unsupported or damaged file | Unsupported or damaged JPEG or MP3 files can cause errors. Do not try to change the file extension of unsupported file types to the file extension of supported file types. | |

- Playback speed can vary dependent on the card type.
- You can assign 8 characters for the file name of the card. If the file name is longer than 8 characters, it will be truncated at 6 digits and "~1, 2, 3, and 4" will be appended to the 7-8th position.

Notes on Memory Card



The JPEG Decoding/The Image Preview Supplied Spec

| | Compression Method | | Colour format | | |
|------------------------------|---|---|---|--|---|
| | Baseline | Progressive | 4:4:4 11:11:11 (Y, Cb, Cr) | 4:2:2 21:11:11 (Y, Cb, Cr) 12:11:11 (Y, Cb, Cr) | 4:2:0 22:11:11 (Y, Cb, Cr) |
| JPEG Decoding Support | ○ | X | X | ○ | ○ |
| Image Display | Image | invalid format | invalid format | Image | Image |
| Preview Image Display | Display  when there is no thumbnail. |  |  | Display  when there is no thumbnail. | Display  when there is no thumbnail. |

- If a error occur when decoding the JPEG, "**Corrupted file**" is displayed on screen.

How to insert and eject the card

◆ Inserting a Card

1. Insert the card into the Slot 1 and/or Slot 2 with the hand softly and slowly.
2. Press the  button to enter the **XSTUDIO** mode.
Press the  button again to exit the **XSTUDIO** mode.

◆ Ejecting a card

1. Press the **M/C EJECT** button on the remote control.
2. Press **▲** / **▼** button to Select the **Memory 1 Eject** or **Memory 2 Eject** based on the inserted card location.
If selecting **Cancel**, OSD is disappeared.
3. Eject the card with the hand.

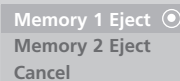

Notes:

- Screen saver will be work if you don't eject the memory card with the hand after operating the eject function.
- When entering the photo or music media at first, the **M/C EJECT** button doesn't work.
It's possible to use the **M/C EJECT** button during using the photo or music media.







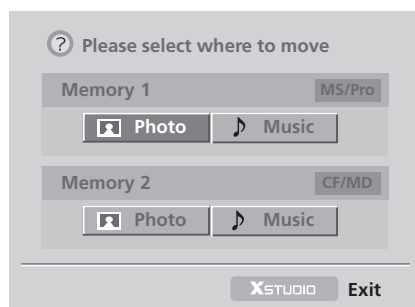

Caution: Press the **M/C EJECT** button of remote control before removing the memory card.
Failure to do so may damage the card.

* In this manual, the OSD (On Screen Display) may be different from your TV's because it is just an example to help you with the TV operation.

Select the Photo or Music Media

- When you plug a memory card or press the  button, the below screens will be displayed.



1. Press  /  /  /  button to select photo or music for slot1/2.
2. Press the **ENTER** button to enter the photo or music media.
3. Press the  button to exit the **XSTUDIO** mode.

Notes:

- The OSD of the ejected card slot is inactivated when ejecting the card with the hand.
- If there is any error in a memory card, it's impossible to enter **XSTUDIO** mode.

JPEG File Viewing Options

- When you select **Photo** in entry menu, you will now see a screen filled with thumbnail photo media.

* In this manual, the OSD (On Screen Display) may be different from your TV's because it is just an example to help you with the TV operation.

Screen Components

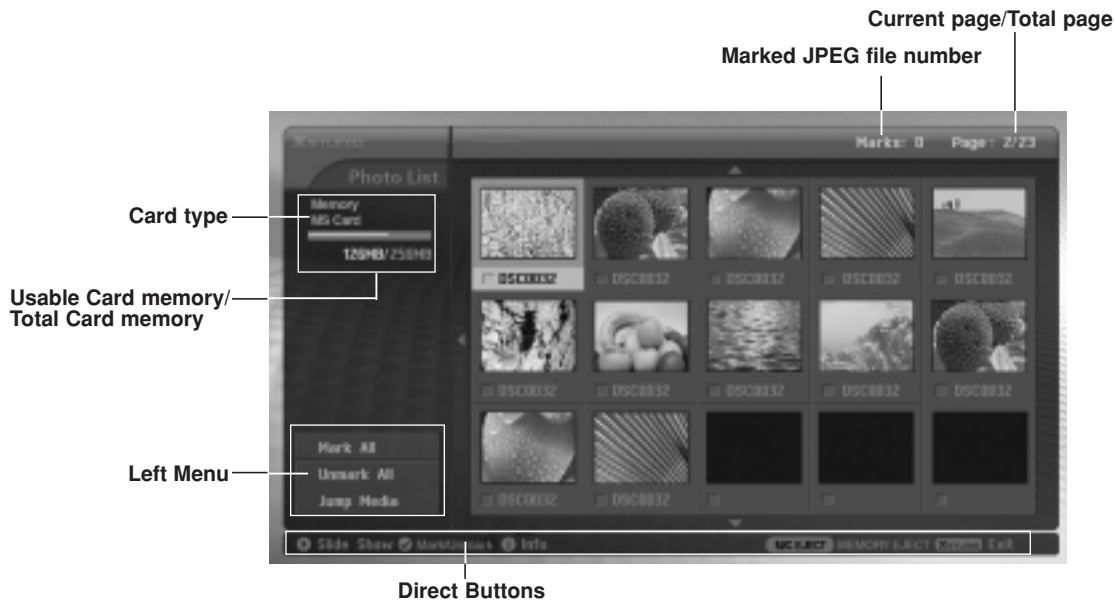
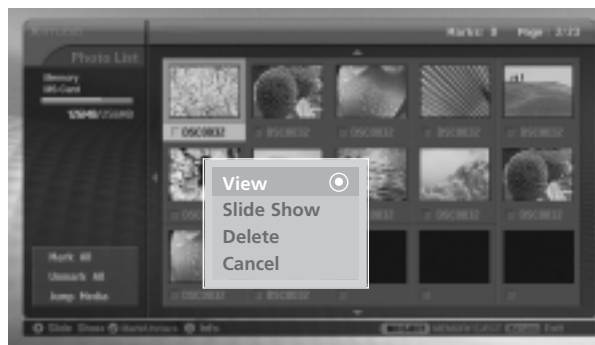

Photo Selection and PopUp menu

- Select your desired image file.



1. Insert the memory card to Slot 1 and/or Slot 2 on the TV front panel.
2. Press the **XSTUDIO** button.
3. Use **▲ / ▼ / ◀ / ▶** button to select photo media for slot1 or slot 2.
4. Press the **ENTER** button to enter the photo media.
Note: It's possible to display 15 JPEG files per page.
5. Press the **▲ / ▼ / ◀ / ▶** button to select JPEG file and then press the **ENTER** button.
6. Press the **▲ / ▼** button to select **View** and then press the **ENTER** button. The selected image will display on entire screen.

Mark/Unmark for JPEG file

- You can mark/unmark the file to view the desired file or use slide show for desired file conveniently.
 - The selected file displays orange colour.
- When press the **ENTER** button after marking some file, the marked file displays green colour.



◆ Mark/Unmark for all files

1. In photo media, repeatedly press ◀ button to enter the left menu.
2. Press the ▲ / ▼ button to select **Mark All** or **Unmark All**.
 - If you select **Mark All**, every file is selected.
 - If you select **Unmark All**, the selection for every file is released.
3. Press the **ENTER** button and then ▶ button to return to the photo list.

◆ Mark/Unmark for some file

Press the **MARK** button repeatedly to mark or unmark some JPEG file.

Jump Media

- Use this function to jump to other media during using photo media.

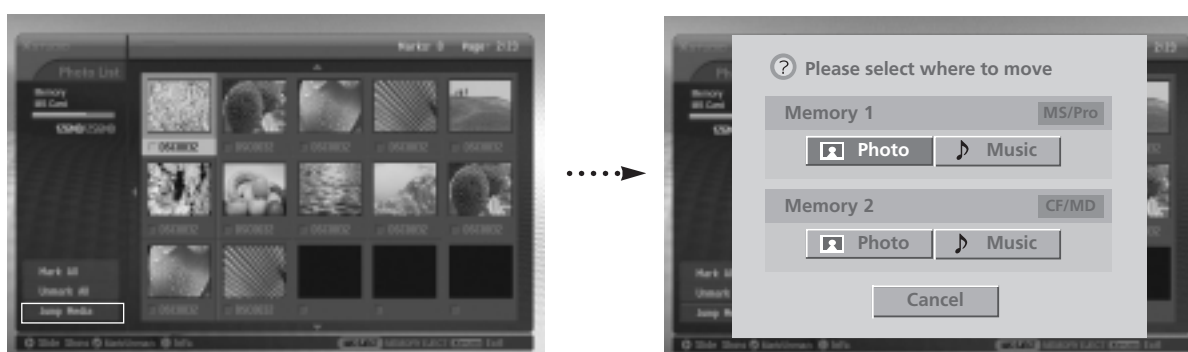

1. In photo media, press ◀ button repeatedly to enter the left menu.
2. Press the ▲ / ▼ button to select **Jump media** and then press the **ENTER** button.
3. Press the ▲ / ▼ / ◀ / ▶ button to select desired media and then press the **ENTER** button. The screen displays each media list.

JPEG File Viewing Options

The Image Adjustment

- You can display the selected image on entire screen and do the various adjustment for the JPEG file.



1. Press the ▲ / ▼ / ◀ / ▶ button to select JPEG file and then press the **ENTER** button.
2. Press the ▲ / ▼ button to select **View** and then press the **ENTER** button. The selected image will display on entire screen.
3. Adjust the JPEG file.



| | |
|------------------------------|--|
| Image selection | <ul style="list-style-type: none"> • Press the ▶ button to select next image. • Press the ◀ button to select previous image. • If you mark for a file, you can see only the marked image. |
| Image Rotation | <ul style="list-style-type: none"> • Press the ▲ / ▼ button to rotate the image. • ▲: Rotate clockwise • ▼: Rotate counterclockwise • It's unavailable to rotate the enlarged image. |
| Image Zoom In/Out | <ul style="list-style-type: none"> • Press the CH ▲ / ▼ button to enlarge or reduce the image 2 or 4 times. • Press the ▲ / ▼ / ◀ / ▶ button to move the enlarged image. |
| Image Deletion | <ul style="list-style-type: none"> • Press the MARK button to delete the current image. |
| Go to the Menu | <ul style="list-style-type: none"> • Press the EXIT button to return to the photo list. |
| Shown/Hidden the menu | <ul style="list-style-type: none"> • Each press the ENTER button, the menu is toggle hidden or shown. • The OSD menu is automatically disappear after a while. |

Slide Show

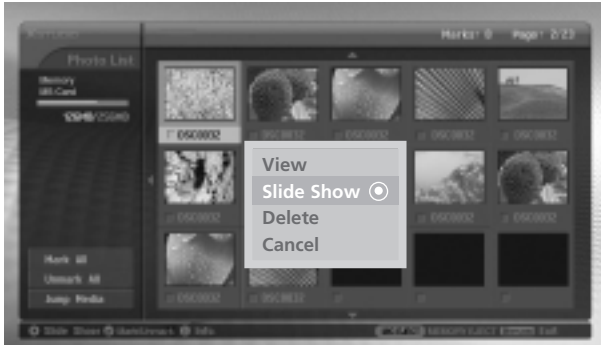

1. Press the ▲ / ▼ / ◀ / ▶ button to select JPEG file and then press the **ENTER** button.
2. Press the ▲ / ▼ button to select **Slide Show** or **Show Marked** and then press the **ENTER** button. (If you mark the file with using **MARK** button, **Show Marked** is displayed on screen.)



3. You can choose the slide show delayed time and effect. Press the ▲ / ▼ / ◀ / ▶ button to choose the slide show delayed time and effect.
4. Press the ▲ / ▼ / ◀ / ▶ button to select **OK**. Slide show start.

Notes:

- You can also operate the **Slide Show** or **Show Marked** with  button directly as shown.
- If you mark for a file, slide show works only the marked image.



| | |
|---|--|
| <p>Next / previous Image Selection</p> | <ul style="list-style-type: none"> • Press the ▶ button to select next image. • Press the ◀ button to select previous image. |
| <p>Image Pause</p> | <ul style="list-style-type: none"> • Press the button to pause the current image. • Press the  button to restart the slide show. • By pressing ◀ / ▶ button, you can also select the next or previous image during pausing the image. |
| <p>Go to the menu</p> | <ul style="list-style-type: none"> • Press the EXIT button to return to the photo list. |
| <p>Shown/Hidden the menu</p> | <ul style="list-style-type: none"> • Each press the ENTER button, the menu is toggle hidden or shown. • The OSD menu is automatically disappear after a while. |

JPEG File Viewing Options

JPEG file Deletion and Cancel

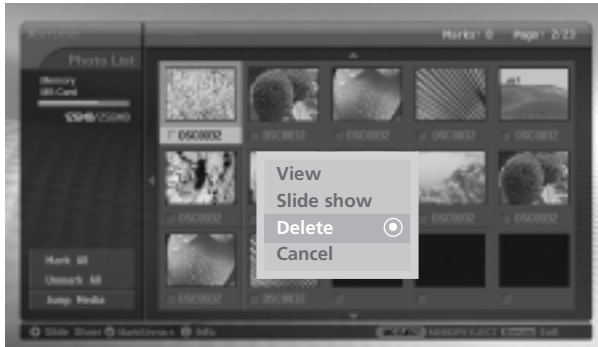

1. Use the ▲ / ▼ / ◀ / ▶ button to select JPEG file and then press the **ENTER** button.
2. To delete the file, press the ▲ / ▼ button to select **Delete** and then press the **ENTER** button. When “Do you want to delete the file?” message is displayed, select **Yes (Yes or No)** with ◀ / ▶ button. The file is deleted, all the following files are shifted up one position.



* If you select **Delete** after marking some file, all of the marked file is deleted.
 But in case MS,SMC,SD memory card setted the write protection, “ Protection Mode. Please push the **OK** button.” message is displayed. When you select the **OK**, the screen is returned to the photo list.(Release the write protection to delete a JPEG file.)

3. To return to the photo list, press the ▲ / ▼ button to select **Cancel** and then press the **ENTER** button.

File Information

- Use it to check information for selected JPEG file.

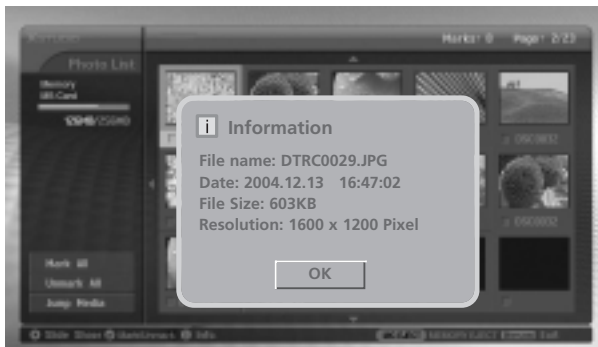

1. In photo media, select your desired JPEG file.
2. Press the **INFO** button. The file information for selected JPEG file is displayed.
 If JPEG file has no information, you can't check it.
3. Press the **ENTER**, **EXIT** or **INFO** button to return to the photo list.

Screen Saver

- If you don't press any button about 30 seconds while displaying the photo list, the screen saver is worked.



* The '**Screen Saver**'?
 Screen saver is to prevent screen pixel burning caused by long time still picture.



- Press the ▲ / ▼ / ◀ / ▶, **EXIT**, ▶(play), ⏸, ■, ◀◀, ▶▶, **INFO**, **CH** ▲ / ▼, **MARK** buttons to release the screen saver.

MP3 File Playing Operation

- Purchased MP3/music files may contain copyright restrictions. Playback of these files may not be supported by this model.

Screen Components

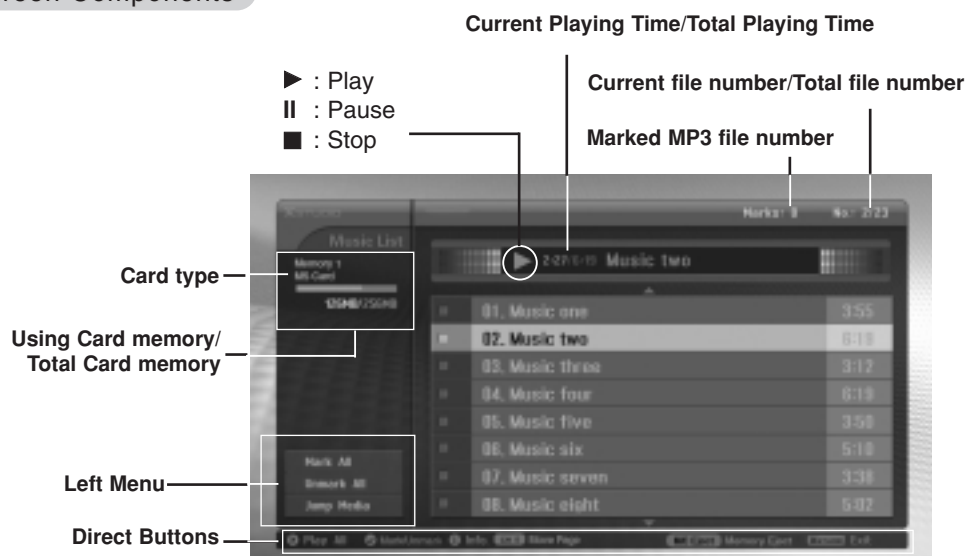

MP3 File Selection and Playback

- MP3 file Selection and deletion function don't work while playing the music.
- If pressing any button except , , button on the remote control while playing the music, the music playing is stopped.
- Moves from the current 8 files list to the next files list with **CH ▲ / ▼** button.

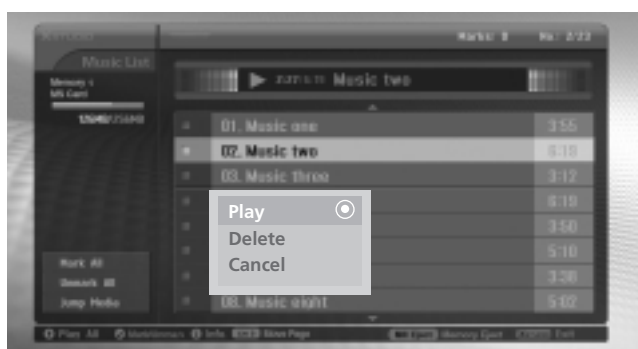

1. Insert the memory card to Slot 1 and/or Slot 2 on the TV front panel.
2. Press the **XSTUDIO** button.
3. Use **▲ / ▼ / ◀ / ▶** button to select music media for slot1 or slot 2.
4. Press the **ENTER** button to enter the music media.
Note: It's possible to display 8 MP3 files per page.
5. Press the **▲ / ▼** button to select desired MP3 file and then press the **ENTER** button.
6. Press the **▲ / ▼** button to select **Play** or **Play Marked** and then press the **OK** button.(If you mark the file with using **MARK** button, **Play Marked** is displayed on screen.)

Notes:

- You can also play the music with button directly.
- The current playing MP3 file displays in front of the title.
- While playing the music, press the **I◀◀** or **▶▶I** button to select the previous or next music directly.
- If you press the **I◀◀** button while playing the music, the MP3 replay from beginning.
(If you press the **I◀◀** button within 1~2 seconds after playing the music, the MP3 plays previous file.)

MP3 File Playing Operation

* In this manual, the OSD (On Screen Display) may be different from your TV's because it is just an example to help you with the TV operation.

Stop/Pause Playback

◆ Stop Playback

Press the **■** button to stop playback.

Note: If you replay the MP3 file after stopping, the highlighted MP3 file on menu will play.

◆ Pause Playback

1. Press the **||** button to pause playback.
2. Press the **||** or **▶** button to starts from the point of your paused part.

Mark/Unmark for MP3 file

- You can mark/unmark the file to play the desired file only.
- It's available to use left menu during stopping the music.



◆ Mark/Unmark for all files

1. In music media, press the **◀** button.
2. Press the **▲ / ▼** button to select **Mark All** or **Unmark All**.
 - If you select **Mark All**, every file is selected.
 - If you select **Unmark All**, the selection for every file is released.
3. Press the **ENTER** button and then **▶** button to return to the music list.

◆ Mark/Unmark for some file

Press the **MARK** button repeatedly to mark or unmark some MP3 file.

Jump Media

- Use this function to jump to other media during using music media.

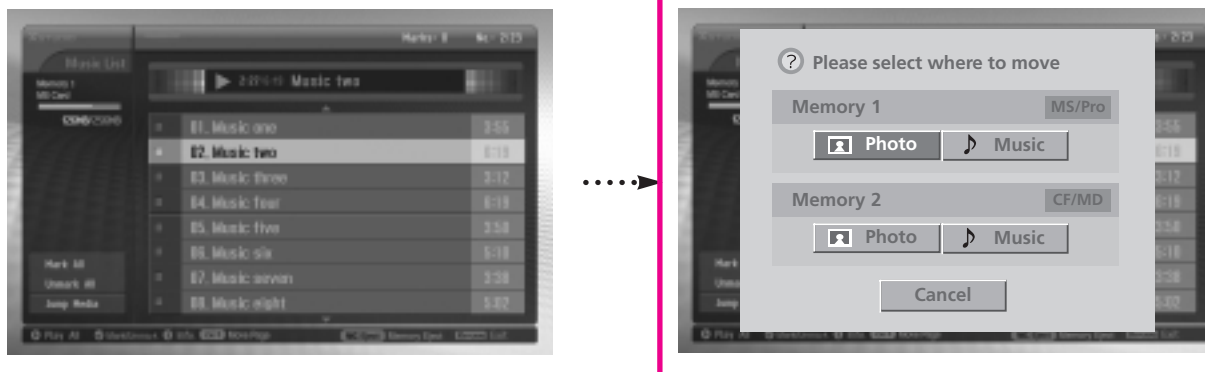

1. In music media, press the ◀ button.
2. Press the ▲ / ▼ button to select **Jump media** and then press the **ENTER** button.
3. Press the ▲ / ▼ / ◀ / ▶ button to select desired media and then press the **ENTER** button. The screen displays each media list.

Screen Saver

- If you don't press any button about 30 seconds, the screen saver is worked.

◆ During playing the MP3



* The 'Screen Saver'?
Screen saver is to prevent screen pixel burning caused by long time still picture.



- Press the ◀, ▶, ⏮, ⏭ buttons. The screen saver is released but the MP3 is continued.
- ◀, ⏮ : Return to a initial portion of the playback MP3.
- ⏭ : Playback the next MP3.
- If you press other button, the screen saver is released and the MP3 is stopped.

◆ During stopping the MP3



- Press the ▲ / ▼ / ◀ / ▶, **EXIT**, ▶(play), II, ■, ⏮, ⏭, **INFO**, **CH ▲ / ▼**, **MARK** buttons to release the screen saver.

MP3 File Playing Operation

MP3 file deletion and Cancel

- It's impossible to delete the music during playback.

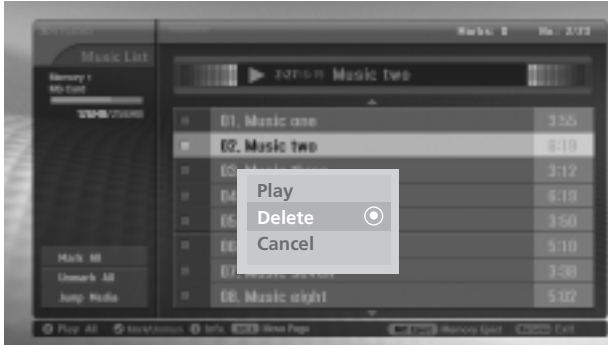

1. Use the ▲ / ▼ button to select MP3 file and then press the **ENTER** button.
2. To delete the file, press the ▲ / ▼ button to select **Delete** and then press the **ENTER** button. When "Do you want to delete the file?" message is displayed, select **Yes (Yes or No)** with ◀ / ▶ button. The file is deleted, all the following files are shifted up one position.



* If you select **Delete** after marking some file, all of the marked file is deleted.
 But in case MS,SMC,SD memory card setted the write protection, "Protection Mode. Please push the **OK** button." message is displayed. When you select the **OK**, the screen is returned to the photo list.(Release the write protection to delete a MP3 file.)

3. To return to the music list, press the ▲ / ▼ button to select **Cancel** and then press the **ENTER** button.

File Information

- Use it to check information for selected MP3 file.

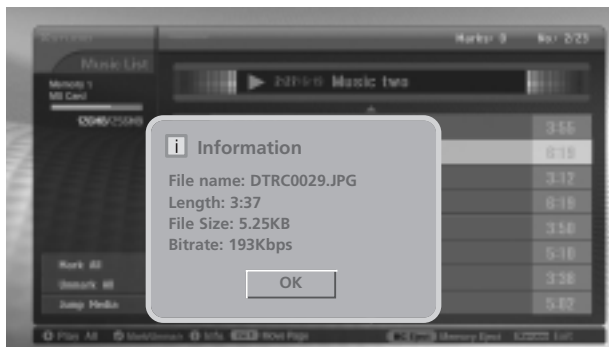

1. In music media, select your desired MP3 file.
2. Press the **INFO** button. The file information for selected MP3 file is displayed.
 If MP3 file has no information, you can't check it.
3. Press the **ENTER**, **EXIT** or **INFO** button to return the previous menu.

Remote Control

PIP (Picture-In-Picture) / POP / Twin Picture

- PIP lets you view 2 different inputs (sources) on your TV screen at the same time. One source will be large, and the other source will show a smaller inset image.
- Twin Picture mode splits the screen into 2, allowing 2 picture sources to be shown on the TV screen at the same time. Each source is given half the screen.
- If you set the block/rating for Lock menu options in PIP/Twin Picture mode, "Rating Blocked" doesn't display on screen.

Watching PIP/POP/Twin Picture

Press the PIP button to access the sub picture. Each press of PIP changes the PIP options as shown below.

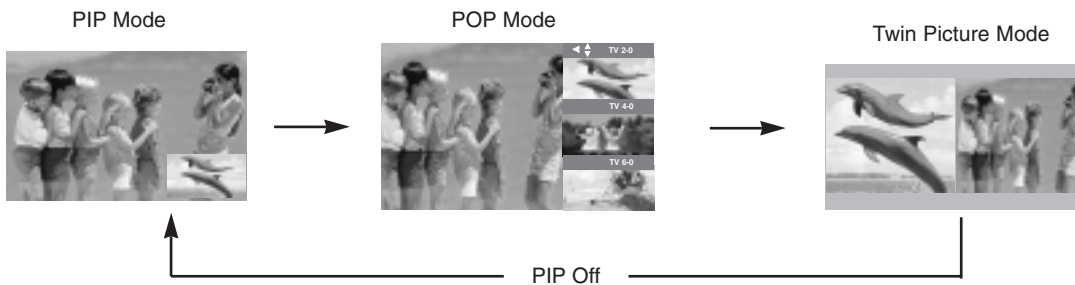

Selecting an Input Signal Source for PIP/Twin Picture

Use the **PIP INPUT** button to select the input source for the sub picture. Each press of **PIP INPUT** button changes the PIP source. You can also select sources for the **Sub Input** in the **SETUP** menu.

| Main Picture Source | Available Sub Picture Sources |
|---------------------|-------------------------------------|
| DTV | Analog, Video, and Front Video |
| Analog | DTV, Analog, Video, and Front Video |

Swapping the PIP/Twin Picture

Repeatedly, use the **SWAP** button to switch the main and sub pictures.

- Component 1, Component 2, RGB-PC (or RGB-DTV), HDMI/DVI input sources for the main picture can't be used to swap the main and sub pictures.

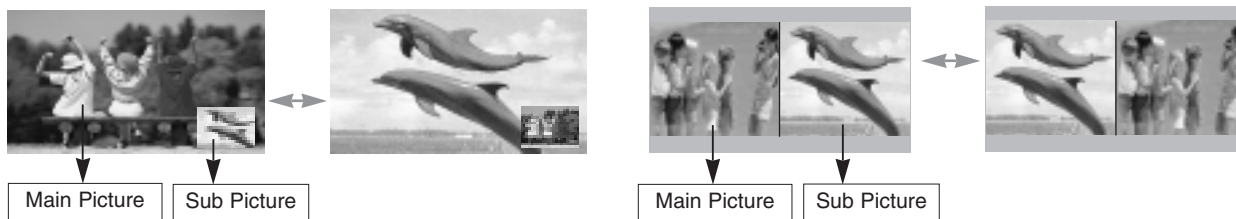

TV Program selection for PIP

1. Press the **PIP** button.
2. Select the Antenna or Cable option on the Sub input menu or with the **PIP INPUT** button. Use the **PIPCH+** / **PIPCH-** button to select a channel for the sub picture. (You can't select DTV for main and sub picture simultaneously).

Moving the PIP sub picture

In PIP mode, press the ▲ / ▼ / ◀ / ▶ button to move the sub picture to a different location on the screen.



Adjusting Main and Sub Picture Sizes for Twin Picture

Use the ▲ / ▼ / ◀ / ▶ button to change main and sub picture sizes in Twin Picture mode.

- i.e)  If screen is adjusted to the maximal size, the large screen appears the black part at both the up and down sides.

POP (Picture-out-of-Picture: Channel Scan)

- Use POP to search the programs of all the memorized channels one-by-one on the 3 PIP screen display, (while the main picture source remains the current channel). The pictures of all the programmed channels are searched with the 3 POP screen.

- **Notes:**

- Run EZ Scan channel search before using POP mode.
- When Sub pictures are changed from the TV/DTV to CATV/CADTV in POP mode, it may make a noise from the Tuner switch.

1. Press the **PIP** button to activate the POP mode while in PIP mode.

- **Channel selection:** Use ◀ button to enlarge the selected channel being searched on the PIP screen to shift it for viewing on the Main screen.
- **PIP selection:** Use ▲ / ▼ button to select one of 3 PIP screen pictures in POP mode.
- When watching TV on Main picture, TV or DTV on Sub pictures are in channel scanning. However, when watching DTV on Main picture, only TV on Sub picture is in channel scanning.

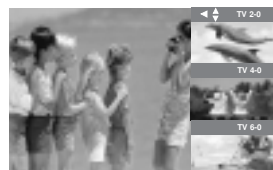

2. Press the **EXIT** button to cancel POP mode.

APM (Adaptive Picture Mode)

- Allows a viewer to select their preferred picture mode after comparing the four different picture (**Daylight**, **Normal**, **Night Time** and **Custom**) settings.



1. Press the **APM** button at once. As shown below, the screen is divided to 4-split.
2. Use the **▲ / ▼ / ◀ / ▶** button to navigate 4 EZ Pictures.
3. By pressing the **ENTER** button, you can select the desired mode.
4. Press **EXIT** button to return to TV viewing.

Notes:

- While operating the 4-split, any button except **APM**, **ENTER**, **EXIT**, **VOLUME ▲ / ▼**, **MUTE** button on the remote control are not available.
- If you don't press any button for 30 seconds, APM screen is disappeared, automatically.

Brief Info.

- Operation:
- Watching TV/DTV/CATV/CADTV
 - Watching Video1, Video2, Video3
 - Watching IEEE 1394
 - In Component1, Component2, RGB, HDMI/DVI modes, **INFO** button is not working.

- Function:
- Show the present screen information.
 - On Watching with the upper Input signal, press the **INFO** button.
 - Press the **INFO** button or **EXIT** button to exit.

A: Banner information

B: Program title

C: Day, Month, Year





D: Program start time

E: Program finish time

F: Show the processing rate

G: Present time

H: Added information. Refer to the icon explanation.

| | |
|---|--|
|  | Screen Ratio of Input Signal 4:3 |
|  | Screen Ratio of Input Signal 16:9 |
| 480i | Resolution of Input Signal 720x480i |
| 480p | Resolution of Input Signal 720x480p |
| 720p | Resolution of Input Signal 1280x720p |
| 1080i | Resolution of Input Signal 1920x1080i |
|  | Multilingual : Input Signal have over two Audio information. Press the SAP button to select wanted Audio. |
|  | Caption: Input Signal have over one Close service. Press the CC button to select wanted Closed caption. |
|  | Input Signal has rating information . Refer to the <Lock Menu>. D (Dialogue), L (Language), S (Sex), V (Violence), FV (Fantasy Violence) |

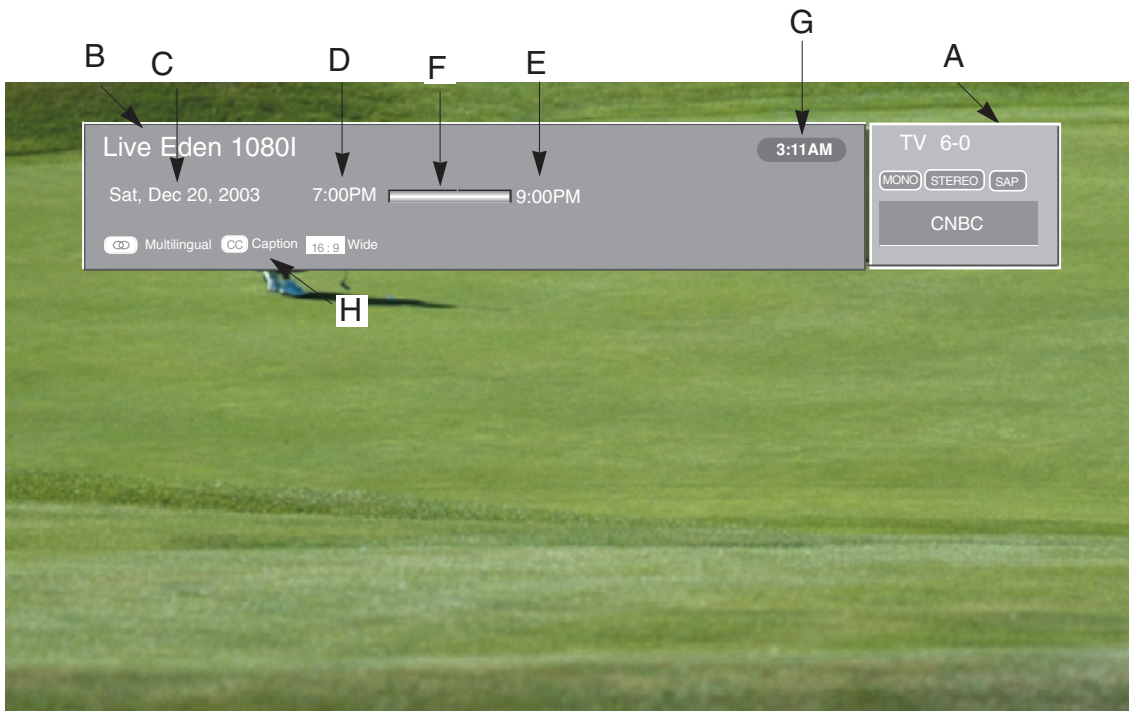

EZ Mute

- If you set the Caption on, nothing to do with **MUTE** button, Caption function operates as Caption on or off.
- When you repeatedly press the **MUTE** button, the screen is displayed in turn. (Refer to the lower picture)

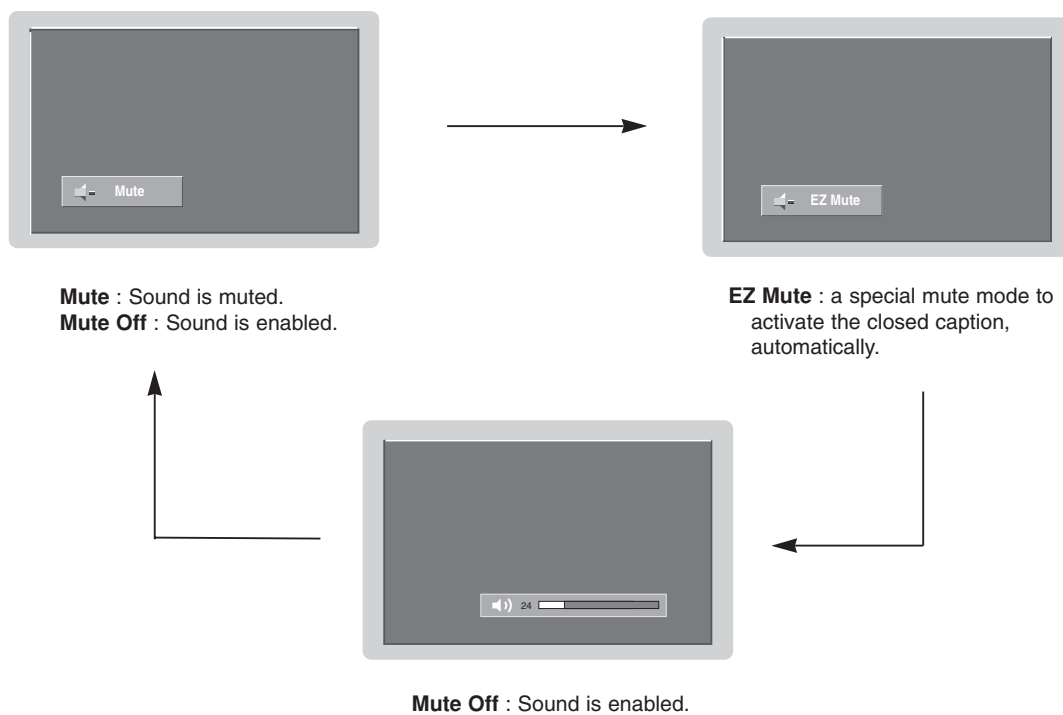

Note: EZ Mute only operates in DTV/Analog/Video/Front Video.

Freeze & Magnify

- Enlarges the picture with correct proportions.
- When enlarging the picture, the image may become distorted.

1. Press the **FREEZE** button in DTV 720p, or 1080i modes.
2. Use the **▲** / **▼** / **◀** / **▶** buttons to select the screen split zoom section.
3. To return to normal viewing, press the **FREEZE** button again.



Screen Setup for PC mode

Operation

- When RGB connect to PC input and select the RGB-PC in Main Input, this function is used.
- When HDMI/DVI connect to PC input and select HDMI/DVI input, this function is used.
- In RGB-DTV mode, SIZE and PHASE is not available.

Adjustment for screen Position, Size, Phase, Reset

- After connecting RGB-PC or HDMI/DVI to PC input and checking the screen quality.
 - Display PC Adjust Menu using **ADJUST** button.
 - Position : Adjust the screen position. After displaying the Adjust, select the screen position.
 - Size : Adjust the screen size.
 - Phase : Adjust the phase of Pixel clock.
(Only available in RGB-PC mode)
 - Reset : Initializing Size, Position, Phase adjustment .

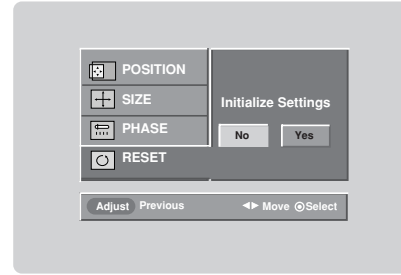
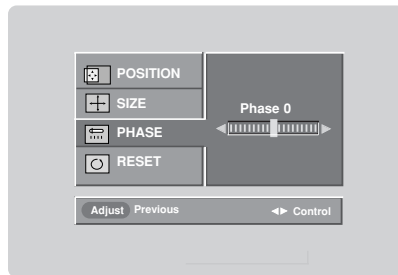
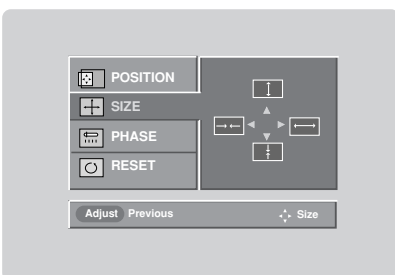
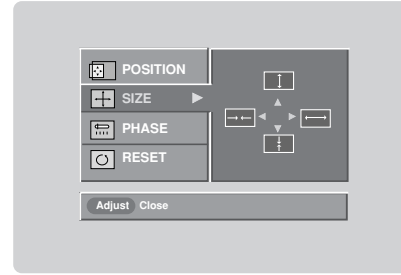
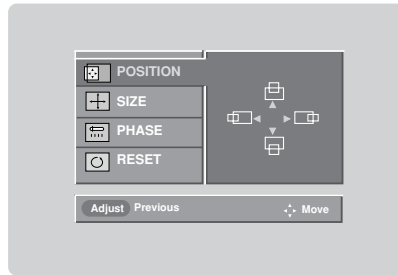
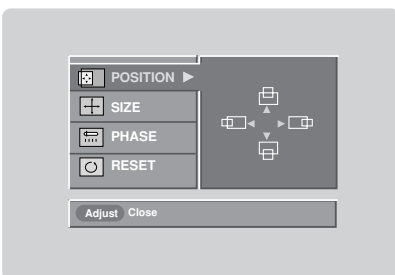

Programming the Remote

- ▶ The remote is a multi-brand or a universal remote . It can be programmed to operate most remote-controllable devices of other manufacturers.
Note that the remote may not control all models of other brands.

Programming a code into a remote mode

1. To find out whether your remote can operate the device without programming, turn on the device such as a VCR and press the corresponding device button on the remote.
After that, press the **POWER** button. If the device is turned off then it responds properly and the remote need not to be programmed. If not, the remote should be programmed to operate the device. The programming procedures are explained below.
2. Press the **MENU** and **MUTE** button continuously at the same time for 2 seconds, the current selected device button will be illuminated.
If you don't press any button for 20 seconds, the light on the device button will be turned off. In that case, you have to repeat from step 2.
4. Enter code numbers using the number button on the remote by referring the code table on the following pages. When pressing the button, the light blinks at a time. If the device turned off, the programming is successful.
5. Press the **MENU** button to store the code. After blinking twice, this code is stored.
6. Test the remote functions to see if the device responds properly. If not, repeat from step 2.

Programming Codes

VCRs

| Brand | Codes | Brand | Codes | Brand | Codes | Brand | Codes |
|----------------|--|---------------|---|-----------|--|-----------------|---|
| AIWA | 034 | KENWOOD | 014 034 039 043 | PORTLAND | 108 | TATUNG | 039 043 |
| AKAI | 016 043 046 124 125 146 | | 047 048 | PULSAR | 072 | TEAC | 034 039 043 |
| AMPRO | 072 | LG (GOLDSTAR) | 001 012 013 020 101 106 114 123 | QUARTZ | 011 014 | TECHNICS | 031 033 070 |
| ANAM | 031 033 103 | LLOYD | 034 | QUASAR | 033 066 075 145 | TEKNIKA | 019 031 033 034 101 |
| AUDIO DYNAMICS | 012 023 039 043 | LXI | 003 009 013 014 | RCA | 013 020 033 034 040 041 062 063 107 109 140 144 145 147 | THOMAS | 034 |
| BROKSONIC | 035 037 129 | MAGIN | 017 034 101 106 | REALISTIC | 003 008 010 014 031 033 034 040 053 054 101 | TMK | 006 |
| CANON | 028 031 033 | MAGNAVOX | 031 033 034 041 067 068 | RICO | 058 | TOSHIBA | 008 013 042 047 059 082 112 131 |
| CAPEHART | 108 | MARANTZ | 012 031 033 067 | RUNCO | 148 | TOTEVISION | 040 101 |
| CRAIG | 003 040 135 | MARTA | 101 | SALORA | 014 | UNITECH | 040 |
| CURTIS MATHES | 031 033 041 | MATSUI | 027 030 | SAMSUNG | 032 040 102 104 105 107 109 112 113 115 120 122 125 | VECTOR RESEARCH | 012 |
| DAEWOO | 005 007 010 064 065 108 110 111 112 116 117 119 | MEI | 031 033 | SCOTT | 017 037 112 129 131 | VICTOR | 048 |
| DAYTRON | 108 | MEMOREX | 003 010 014 031 033 034 053 072 101 102 134 139 | SEARS | 003 008 009 010 013 014 017 020 031 042 073 081 101 | VIDEO CONCEPTS | 012 034 046 |
| DBX | 012 023 039 043 | MGA | 045 046 059 | SHARP | 031 054 149 | VIDEOSONIC | 040 |
| DYNATECH | 034 053 | MINOLTA | 013 020 | SHINTOM | 024 | WARDS | 003 013 017 024 031 033 034 040 053 054 131 |
| ELECTROHOME | 059 | MITSUBISHI | 013 020 045 046 049 051 059 061 151 | SONY | 003 009 031 052 056 057 058 076 077 078 149 | YAMAHA | 012 034 039 043 |
| EMERSON | 006 017 025 027 029 031 034 035 036 037 046 101 129 131 138 153 | MTC | 034 040 | SYLVANIA | 031 033 034 059 067 | ZENITH | 034 048 056 058 072 080 101 |
| FISHER | 003 008 009 010 | MULTITECH | 024 034 | | 067 | | |
| FUNAI | 034 | NEC | 012 023 039 043 048 | | 034 | | |
| GE | 031 033 063 072 107 109 144 147 | NORDMENDE | 043 | | 010 034 | | |
| GO VIDEO | 132 136 | OPTONICA | 053 054 | | | | |
| HARMAN KARDON | 012 045 | PANASONIC | 066 070 074 083 133 140 145 | | | | |
| HITACHI | 004 018 026 034 043 063 137 150 | PENTAX | 013 020 031 033 063 | | | | |
| INSTANTREPLAY | 031 033 | PHILCO | 031 034 067 | | | | |
| JCL | 031 033 | PHILIPS | 031 033 034 054 067 071 101 | | | | |
| JCPENNY | 012 013 015 033 040 066 101 | PILOT | 101 | | | | |
| JENSEN | 043 | PIONEER | 013 021 048 | | | | |
| JVC | 012 031 033 043 048 050 055 060 130 150 152 | | | | | | |

CATV

| Brand | Codes | Brand | Codes | Brand | Codes | Brand | Codes |
|--------------|--------------------------------|----------------|------------------------------------|--------------------|--------------------------------|--------------|------------------------------------|
| ABC | 003 004 039 042 046 052 053 | GOLDEN CHANNEL | 030 | PIONEER | 065 085 090 034 051 052 063 | SPRUCER | 047 078 |
| AJIN | 112 | HAMLIN | 049 050 055 | POST NEWS WEEK | 016 | STARCOM | 002 004 008 009 |
| ANTRONIK | 014 | HITACHI | 052 055 | PRUCER | 059 | STARGATE | 008 030 |
| ARCHER | 005 007 014 024 | HOSPITALITY | 070 077 | PTS | 011 048 071 072 073 074 | TADIRAN | 030 |
| CABLE STAR | 026 | JERROLD | 002 003 004 008 009 010 052 069 | PULSAR | 100 | TAEKWANG | 110 |
| CENTURION | 092 | LG (GOLDSTAR) | 001 106 101 005 | RCA | 047 | TAIHAN | 105 |
| CENTURY | 007 | M-NET | 037 | REGAL | 049 050 | TANDY | 017 |
| CITIZEN | 007 | MACOM | 033 | REGENCY | 057 | TEXSCAN | 029 |
| COLOUR VOICE | 065 090 | MAGNAVOX | 010 012 064 079 | REMBRANT | 025 | TOCOM | 039 040 056 |
| COMBANO | 080 081 | MEMOREX | 100 | SAMSUNG | 102 107 030 068 | TOSHIBA | 100 |
| COMTRONICS | 019 030 | MOVIE TIME | 028 032 | SCIENTIFIC ATLANTA | 003 011 041 042 043 045 046 | UNIKA | 007 014 024 |
| DIAMOND | 023 | NSC | 015 028 038 071 073 | SHERITECH | 022 | UNITED CABLE | 004 053 |
| EAGLE | 020 030 040 | OAK | 016 031 037 053 | SIGNAL | 030 | UNIVERSAL | 005 007 014 024 026 027 032 035 |
| EASTERN | 057 062 066 | PANASONIC | 044 047 | SIGNATURE | 052 | VIEWSTAR | 012 015 018 086 087 088 089 |
| ELECTRICORD | 032 | PARAGON | 100 | SL MARX | 030 | ZENITH | 100 114 060 093 |
| GE | 072 | PHILIPS | 006 012 013 020 | | | | |
| GEMINI | 008 022 025 054 | | | | | | |
| GI | 052 074 | | | | | | |

HDSTB

| Brand | Codes | Brand | Codes | Brand | Codes | Brand | Codes |
|----------------|-----------------|--------------------|-----------------|----------------------|-----------------|----------|-----------------|
| ALPHASTAR DSR | 123 | | | PACE SKY SATELLITE | 143 | | 088 090 107 130 |
| AMPLICA | 050 | | | PANASONIC | 060 142 | | 137 |
| BIRDVIEW | 051 126 129 | GENERAL INSTRUMENT | 003 004 016 029 | PANSAT | 121 | TOSHIBA | 002 127 |
| CHANNEL MASTER | 013 014 015 018 | HITACHI | 139 140 | PERSONAL CABLE | 117 | UNIDEN | 016 025 042 043 |
| | 036 055 | HOUSTON TRACKER | 033 037 039 051 | PHILIPS | 071 | | 044 045 048 049 |
| CHAPARRAL | 008 009 012 077 | | 057 104 | PICO | 105 | | 078 079 080 086 |
| CITOH | 054 | HUGHES | 068 | PRESIDENT | 019 102 | VIEWSTAR | 101 135 136 |
| CURTIS MATHES | 050 145 | JANIEL | 060 147 | PRIMESTAR | 030 110 111 | | 115 |
| DRAKE | 005 006 007 010 | JERROLD | 061 | PROSAT | 072 | WINEGARD | 128 146 |
| | 011 052 112 116 | KATHREIN | 108 | RCA | 066 106 | ZENITH | 081 082 083 084 |
| | 141 | LEGEND | 057 | REALISTIC | 043 074 | | 091 120 |
| DX ANTENNA | 024 046 056 076 | LG | 001 | SAMSUNG | 123 | | |
| ECHOSTAR | 038 040 057 058 | LUTRON | 132 | SATELLITE SERVICE CO | 028 035 047 057 | | |
| | 093 094 095 096 | LUXOR | 062 144 | | 085 | | |
| | 097 098 099 100 | MACOM | 010 059 063 064 | SCIENTIFIC ATLANTA | 032 138 | | |
| | 122 | | 065 | SONY | 103 | | |
| ELECTRO HOME | 089 | MEMOREX | 057 | STARCAST | 041 | | |
| EUROPLUS | 114 | NEXTWAVE | 028 124 125 | SUPER GUIDE | 020 124 125 | | |
| FUJITSU | 017 021 022 027 | NORSAT | 069 070 | TEECOM | 023 026 075 087 | | |

Audio

| Brand | Codes | Brand | Codes | Brand | Codes | Brand | Codes |
|---------------|-----------------|-----------|-----------------|-----------|-----------------|---------|-----------------|
| AIWA | 014 028 070 096 | JVC | 004 013 141 | PHILIPS | 026 112 143 | | 147 218 |
| | 125 129 139 229 | KEC | 185 186 187 | PIONEER | 039 042 043 063 | TOSHIBA | 137 |
| | 230 | KENWOOD | 038 050 067 089 | | 065 091 093 094 | THE | 061 |
| AKAI | 163 | | 170 171 197 206 | QUASAR | 113 | VICTOR | 088 131 |
| ANAM | 003 014 017 023 | KOHEL | 030 | RCA | 080 | WARDS | 089 |
| | 059 106 189 216 | NAD | 045 046 | RCX | 092 | YAMAHA | 054 055 066 092 |
| | 217 235 236 | LOTTE | 014 016 036 098 | REALISTIC | 103 106 | | 199 |
| BURMECTER | 252 | | 100 172 173 174 | SAMSUNG | 124 145 146 182 | | |
| CARVER | 086 | | 175 176 177 178 | | 193 194 195 203 | | |
| CLARION | 199 | | 179 180 181 183 | SANSUI | 011 135 138 144 | | |
| DAEWOO | 027 053 060 084 | | 201 202 208 213 | SANYO | 019 083 234 | | |
| | 102 148 198 221 | | 214 219 223 232 | SCOTT | 106 186 | | |
| DENON | 015 075 130 143 | | 238 240 | SHARP | 031 032 051 052 | | |
| FANTASIA | 071 | LXI | 103 | | 072 082 117 119 | | |
| FINEARTS | 022 | MAGNAVOX | 111 | | 156 184 199 200 | | |
| FISHER | 089 099 | MARANTZ | 002 018 020 025 | | 206 209 | | |
| LG(GOLDSTAR) | 001 021 024 029 | | 034 041 081 090 | SHERWOOD | 005 006 158 | | |
| | 087 107 108 110 | | 097 112 | SONY | 044 045 109 114 | | |
| | 190 191 192 210 | MCINTOSH | 049 | | 118 126 248 249 | | |
| | 211 212 239 | MCS | 104 | TAEKWANG | 012 020 073 074 | | |
| HAITAI | 034 035 188 222 | MEMOREX | 107 | | 076 077 105 161 | | |
| HARMAN/KARDON | 068 | NAD | 046 | | 162 163 164 165 | | |
| INKEL | 037 058 062 069 | ONKYO | 013 040 041 047 | | 166 167 168 169 | | |
| | 078 079 095 121 | | 048 056 057 132 | | 205 231 233 242 | | |
| | 122 149 150 151 | OPTIMUS | 158 | TEAC | 010 085 106 136 | | |
| | 152 153 154 155 | PANASONIC | 007 033 064 113 | | 185 187 237 | | |
| | 157 158 159 160 | | 142 220 241 251 | TECHNICS | 101 113 128 134 | | |
| | 189 207 222 224 | PENNEY | 104 | | | | |
| | 225 226 227 243 | | | | | | |
| | 247 | | | | | | |

DVD

| Brand | Codes | Brand | Codes | Brand | Codes | Brand | Codes |
|---------------|-----------------|------------|---------|---------|---------|----------|-------------|
| APEX DIGITAL | 022 | MAGNAVOX | 013 | PHILIPS | 013 | SONY | 007 |
| DENON | 020 014 | MARANTZ | 024 | PIONEER | 004 026 | THOMPSON | 005 006 |
| GE | 005 006 | MITSUBISHI | 002 | PROCEED | 021 | TOSHIBA | 019 008 |
| HARMAN KARDON | 027 | NAD | 023 | PROSCAN | 005 006 | YAMAHA | 009 018 |
| JVC | 012 | ONKYO | 008 017 | RCA | 005 006 | ZENITH | 010 016 025 |
| LG | 001 010 016 025 | PANASONIC | 003 009 | SAMSUNG | 011 015 | | |

Troubleshooting Checklist

No picture & No sound

- Check whether the TV is turned on.
- Is the power cord inserted into wall power outlet?
- Test the wall power outlet, plug another product's power cord into the outlet where the TV's power cord was plugged in.

Picture OK & No sound

- Press the **VOLUME** (▶) button.
- Sound muted? Press **MUTE** button.

The remote control doesn't work

- Check to see if there is any object between the TV and the remote control causing obstruction.
- Are batteries installed with correct polarity (+ to +, - to -)? (Refer to p.11)
- Correct remote operating mode set: TV, VCR etc.?
- Install new batteries. (Refer to p.11)

Picture appears slowly after switching on

- This is normal, the image is muted during the TV startup process. Please contact your service center, if the picture has not appeared after five minutes.

No or poor color or poor picture

- Select **Color** in the **Picture** menu and press the ▶ button. (Refer to p.62)
- Keep a sufficient distance between the TV and the VCR.
- Activate any function to restore the brightness of the picture. (If still picture is on the screen for more than 5 minutes, the screen gets dark.)

Horizontal/vertical bars or picture shaking

- Check for local interference such as an electrical appliance or power tool.

No output from one of the speakers

- Adjust **Balance** in the **AUDIO** menu. (Refer to p.63)

Unusual sound from inside the TV

- A change in ambient humidity or temperature may result in an the DLP display is turned on or off and does not indicate a fault with the TV.

Poor TV input signal

- Check ANTENNA and CABLE connection.

Poor Video signal

- Check ANTENNA and CABLE connection.

No channel or a few channel

- Start EZ Scan.

Unsuitable Aspect Ratio

- You can adjust the **RATIO** button or **Aspect Ratio** in the **OPTION** menu.

My Guide listings disappeared after a power failure

- You should begin to receive listings again within 24 hours.

Troubleshooting Checklist

Some channel numbers in the Guide are incorrect.

- You can correct them using Change Channel Display under Setup.

I have not received any Guide listings.

- Listings usually appear within 24 hours after a successful Setup.
- It may take up to a week to fill the Listings grid with the full 8 days of listings.
- If you see a Listings grid with the message "No Listings" displayed you should start to receive updated program listings within 24 hours. To receive listings:
 - Make sure the cable box is left On, if applicable.
 - Turn off your recorder when not in use.
- If the message "No data for this screen" is displayed:
 - Check the connections between the TV, cable, antenna, and the IR cable if using a cable box.
 - Verify Setup information under Change System Settings.
 - Make sure the cable box is On, if applicable.
 - If this message is still displayed after multiple days, please contact the LG® Brand Customer Support.

A show I set to Record did not occur.

- Make sure your recorder is turned Off before the recording begins.
- Make sure there is a tape.
- Check the Schedule menu and verify that the show is listed before recording begins.
- Check the placement of the IR cable in front of your recorder.

I set a show to Auto-Tune and it did not.

- Check the Schedule menu and verify that the show is listed as a Reminder.
- Highlight the show under Listings and do the following:
 - Press the Menu key on the remote.
 - Use the down arrow to highlight Edit Reminder, and press **ENTER**.
 - Verify the Auto-Tune option reads Yes.
- The TV must be On at the scheduled time for Auto-Tune.
- If you have a cable box, check the IR cable.

I set a show with the Power On TV option and it did not.

- Check the Schedule menu and verify that the show is listed as a Reminder.
- Highlight the show under Listings and do the following:
 - Press the Menu key on the remote.
 - Use the down arrow to highlight Edit Reminder, and press **ENTER**.
 - Verify the Power On TV option reads Yes.

Maintenance

- Early malfunctions can be prevented. Careful and regular cleaning can extend the amount of time you will have your new TV. Be sure to turn the power off and unplug the power cord before you begin any cleaning.

Cleaning the Screen

1. Here's a great way to keep the dust off your screen for a while. Wet a soft cloth in a mixture of lukewarm water and a little fabric softener or dish washing detergent. Wring the cloth until it's almost dry, and then use it to wipe the screen.
2. Make sure the excess water is off the screen, and then let it air-dry before you turn on your TV.

Cleaning the Cabinet

To remove dirt or dust, wipe the cabinet with a soft, dry, lint-free cloth. Please be sure not to use a wet cloth.

Extended Absence



If you expect to leave your TV dormant for a long time (such as a vacation), it's a good idea to unplug the power cord to protect against possible damage from lightning or power surges.

Product Specifications

| MODEL | 52SX4D-UB | 62SX4D-UB |
|--------------------------|---|-----------|
| Horizontal Size (inches) | 55.7 | 63.4 |
| Height (inches) | 35.8 | 40.4 |
| Depth (inches) | 15.7 | 19.5 |
| Weight (lbs.) | 82.7 | 108 |
| Power requirement | AC120V ~ 60Hz | |
| Television System | NTSC-M, ATSC | |
| Program Coverage | VHF 2 ~ 13, UHF 14 ~ 69, CATV 1 ~ 135, CADTV 1 ~ 135. DTV 2 ~ 69 | |
| Power Consumption (W) | 260W | |
| Antenna | 75 ohm External Terminal for VHF/UHF | |
| Audio Output (W) | 20Wx2 | |
| Supplied Accessories | Remote control, 2 size AA batteries, D-sub 15 pin Cable, G-LINK cable | |

- The specifications shown above may be changed without prior notice for quality improvement.

Notes

Notes

CONCERNING PIXEL FUNCTIONALITY: Your DLP Rear Projection Television contains about 921600 individual pixels. DLP Projection displays typically contain a small number of pixels that do not function normally. Your display has been inspected and is in compliance with manufacturer's specifications, indicating that any pixel defects do not effect the operation or use of your display.

READ YOUR OPERATING GUIDE CAREFULLY SO THAT YOU UNDERSTAND THE OPERATION OF YOUR DLP REAR PROJECTION DISPLAY AND HOW TO ADJUST THE CONSUMER CONTROLS.

IMPORTANT: Please fill out and mail in your Product Registration Card or go to www.lgservice.com to register your product online. This information allows us to reach you promptly should we discover a safety or reliability problem that could affect you.

CUSTOMER ASSISTANCE NUMBERS

| | |
|---|--|
| To obtain customer assistance, product information, or Dealer or Service locations | Call 1-800-243-0000 24 hours a day, 365 days per year |
|---|--|

FOR SERVICE:

For warranty service information, please contact the LG®Brand Customer Support telephone number listed below.

When calling for service, please have your product model number, serial number and the date of purchase or the date of original installation available.

If a replacement unit is required, under some circumstances you may be asked to provide a reserve deposit to the LG®Brand Service Center against a credit card number as surety for advanced shipment. Your credit card will not be charged if you return the defective unit within 10 working days.

If a replacement unit is received, please use the carton and packaging from that unit in returning the defective unit to the LG®Brand Service Center.

Parts and service in accordance with the LG®Brand warranty is our responsibility and will be provided without charge. Other service requirements will be at the owner's expense. If you have problems in obtaining satisfactory warranty service, write or call the LG®Brand Customer Interactive Service.

To assure proper credit and avoid unnecessary charges, you must obtain a Return Authorization before returning any product to the Factory Service Center. Contact the number below or your authorized LG®Brand repair facility for details.

Before you call for warranty service, check your operating guide – you may avoid a service call.

LG®Brand Customer Interactive Center
P. O. Box 240007
201 James Record Road
Huntsville, Alabama 35824
ATTN: CIC

Telephone number: 1-800-243-0000
This number is a toll-free number
Follow menu prompts when the call is answered

Web address: www.lgservice.com

Telephone Center Hours of Operation:
24 hours a day, 365 days per year

Service for your LG®Brand Rear Projection Television is provided through LG Electronics Alabama, Inc., the authorized LG®Brand Service Center for the United States.

LG®Brand DLP Rear Projection Televisions are marketed and distributed in the United States by LG Electronics Corporation, 2000 Millbrook Drive, Lincolnshire, IL 60069.



LG® Brand
DLP Rear Projection Television
U.S. Limited Warranty

Your LG® brand DLP Rear Projection Television will be repaired or replaced as set forth below, if it proves to be defective in material or workmanship under normal use, during the warranty period ("Warranty Period") listed below, effective from the date ("Date of Purchase") of original consumer purchase of the product. This warranty is good only to the original purchaser of the product and effective only when used in the United States, excluding U.S. Territories.

| | |
|--|--|
| <p>WARRANTY PERIOD:</p> <p>LABOR: One Year from the Date of Purchase. Your unit will be repaired or replaced with a new, substitute model or factory reconditioned unit, at the manufacturer's option. If repair, parts used in the repair may be new or remanufactured.</p> <p>Parts: One Year from the Date of Purchase.</p> <p>Halogen Bulb: One Year from the Date of Purchase.</p> <p>Replacement Units and Repair Parts are warranted for the remaining portion of the original unit's warranty period.</p> <p>EFFECTIVE DATE OF WARRANTY: Your warranty period begins on the date of sale to the original consumer / end user. KEEP THE DEALER'S DATED BILL OF SALE OR PROOF OF DELIVERY as evidence of the purchase date. You will be required to submit a legible copy of your bill of sale or proof of delivery when requesting warranty service.</p> | <p>In-Home Service is available on this Unit, as provided in this Warranty. Please retain dealer's dated bill of sale or delivery ticket as evidence of the Date of Purchase for proof of warranty, and submit a copy of the bill of sale to the service person at the time warranty service is provided.</p> <p>Please call</p> <p style="text-align: center;">1-800-243-0000</p> <p>To locate your nearest LG® Brand Authorized Service Center and to schedule a service appointment.</p> <p>For further Instructions, see "For Service" below</p> |
|--|--|

THIS WARRANTY IS IN LIEU OF ANY OTHER WARRANTY, EXPRESS OR IMPLIED, INCLUDING WITHOUT LIMITATION, ANY WARRANTY OF MERCHANTABILITY OR FITNESS FOR A PARTICULAR PURPOSE. TO THE EXTENT ANY IMPLIED WARRANTY IS REQUIRED BY LAW, IT IS LIMITED IN DURATION TO THE EXPRESS WARRANTY PERIOD ABOVE. NEITHER THE MANUFACTURER NOR ITS U.S. DISTRIBUTOR SHALL BE LIABLE FOR ANY INCIDENTAL, CONSEQUENTIAL, INDIRECT, SPECIAL, OR PUNITIVE DAMAGES OF ANY NATURE, INCLUDING WITHOUT LIMITATION, LOST PROFITS, LOST OR CORRUPTED PROGRAMMING OR DATA, OR ANY OTHER DAMAGE WHETHER BASED IN CONTRACT, TORT, OR OTHERWISE. Some states do not allow the exclusion or limitation of incidental or consequential damages or limitations on how long an implied warranty lasts, so the above exclusion or limitation may not apply to you. This warranty gives you specific legal rights and you may also have other rights that vary from state to state.

THIS LIMITED WARRANTY DOES NOT APPLY TO:

| | |
|--|--|
| <ul style="list-style-type: none"> ● damage caused in shipping or transit ● service required as a result of improper installation, including incorrect or insufficient AC supply (please consult the owner's manual for power supply requirements). ● installation or repair of antenna systems, cable converters, cable company supplied equipment, or other components in a video system ● set-up or adjustment on consumer controls, or damage caused by improper adjustments ● damage caused by other system components ● any unit that has been modified or incorporated into any other product ● replacement of batteries on the remote control. ● replacement of the Halogen Bulb except within the first 90 days | <ul style="list-style-type: none"> ● damage (including cosmetic damage), failure, loss or personal injury due to misuse, abuse, negligence, improper maintenance or storage, or to acts of nature or other causes beyond our control. (Causes beyond our control include but are not limited to lightning strike, power surges, power outages and water damage.) ● repair or replacement of warranted parts by other than an LG® Brand authorized service centers. ● units purchased or serviced outside of the U.S.A. ● product where the original factory serial numbers have been removed, defaced or changed in any way. ● product sold and labeled as "as is, where is" or similar disclaimer. |
|--|--|

The cost of repair or replacement under these excluded circumstances shall be borne by the consumer.

P/N : 3828VA0540A @ (3828VB0002M)