



LCD TV

MODELS: 32LC2D
32LC2DU
37LC2D
42LC2D

PLASMA TV

MODELS: 42PC3D
42PC3DV
50PC3D
60PC1D

OWNER'S MANUAL



Internet Home Page : <http://www.lge.com>
<http://www.lg.ca>

ENERGYSTAR is a set of power-saving guidelines issued by the U.S. Environmental Protection Agency(EPA).



As an ENERGY STAR Partner LGE U. S. A.,Inc. has determined that this product meets the ENERGY STAR guidelines for energy efficiency.

- Applied models: 42PC3D/3DV/50PC3D
32/37/42LC2D, 32LC2DU

Please read this manual carefully before operating your set. Retain it for future reference. Record model number and serial number of the set. See the label attached on the back cover and quote this information to your dealer when you require service.

P/NO : 38289U0527F ©
Printed in Korea

Warning



CAUTION
RISK OF ELECTRIC SHOCK
DO NOT OPEN



WARNING:

TO REDUCE THE RISK OF ELECTRIC SHOCK DO NOT REMOVE COVER (OR BACK). NO USER SERVICEABLE PARTS INSIDE. REFER TO QUALIFIED SERVICE PERSONNEL.



The lightning flash with arrowhead symbol, within an equilateral triangle, is intended to alert the user to the presence of uninsulated "dangerous voltage" within the product's enclosure that may be of sufficient magnitude to constitute a risk of electric shock to persons.



The exclamation point within an equilateral triangle is intended to alert the user to the presence of important operating and maintenance (servicing) instructions in the literature accompanying the appliance.

NOTE TO CABLE/TV INSTALLER:

This reminder is provided to call the CATV system installer's attention to Article 820-40 of the National Electric Code (U.S.A.). The code provides guidelines for proper grounding and, in particular, specifies that the cable ground shall be connected to the grounding system of the building, as close to the point of the cable entry as practical.

REGULATORY INFORMATION

This equipment has been tested and found to comply with the limits for a Class B digital device, pursuant to Part 15 of the FCC Rules. These limits are designed to provide reasonable protection against harmful interference in a residential installation. This equipment generates, uses and can radiate radio frequency energy and, if not installed and used in accordance with the instructions, may cause harmful interference to radio communications. However, there is no guarantee that interference will not occur in a particular installation. If this equipment does cause harmful interference to radio or television reception, which can be determined by turning the equipment off and on, the user is encouraged to try to correct the interference by one or more of the following measures:

- Reorient or relocate the receiving antenna.
- Increase the separation between the equipment and receiver.
- Connect the equipment into an outlet on a circuit different from that to which the receiver is connected.
- Consult the dealer or an experienced radio/TV technician for help.

Any changes or modifications not expressly approved by the party responsible for compliance could void the user's authority to operate the equipment.

CAUTION:

Do not attempt to modify this product in any way without written authorization from LG Electronics Corporation. Unauthorized modification could void the user's authority to operate this product.

COMPLIANCE:

The responsible party for this product's compliance is:
LG Electronics U.S.A., Inc.
1000 Sylvan Avenue, Englewood Cliffs, NJ 07632
Phone: 1-800-243-0000
<http://www.lgusa.com>

Safety Instructions

WARNING :

To reduce the risk of fire or electric shock, do not expose this apparatus to rain or moisture.

Apparatus shall not be exposed to dripping or splashing and no objects filled with liquids, such as vases, shall be placed on the apparatus.

IMPORTANT SAFETY INSTRUCTIONS

1. Read these instructions.

2. Keep these instructions.

3. Heed all warnings.

4. Follow all instructions.



5. Do not use this apparatus near water.



6. Clean only with a dry cloth.

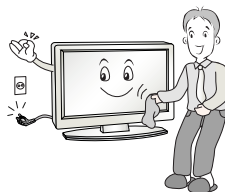

7. Do not block any of the ventilation openings. Install in accordance with the manufacturer's instructions.



8. Do not install near any heat sources such as radiators, heat registers, stoves, or other apparatus (including amplifiers) that produce heat.



9. Do not defeat the safety purpose of the polarized or grounding type plug. A polarized plug has two blades with one wider than the other. A grounding type plug has two blades and a third grounding prong. The wide blade or the third prong is provided for your safety. When the provided plug does not fit into your outlet, consult an electrician for replacement of the obsolete outlet.

10. Protect the power cord from being walked on or pinched particularly at plugs, convenience receptacles, and the point where they exit from the apparatus.

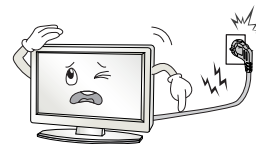

11. Only use the attachments / accessories specified by the manufacturer.

12. Use only with a cart, stand, tripod, bracket, or table specified by the manufacturer, or sold with the apparatus. When a cart is used, use caution when moving the cart / apparatus combination to avoid injury from tip-over.



14. Refer all servicing to qualified service personnel. Servicing is required when the apparatus has been damaged in any way, such as power supply cord or plug is damaged, liquid has been spilled or objects have fallen into the apparatus, the apparatus has been exposed to rain or moisture, does not operate normally, or has been dropped.

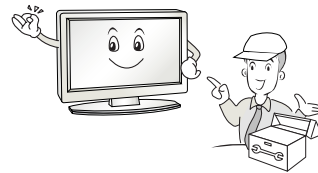

13. Unplug this apparatus during lightning storms or when unused for long periods of time.



15. DISCONNECTING DEVICE FROM MAINS
Main plug is the disconnecting device. The plug must remain readily operable.

CAUTION concerning the Power Cord

Most appliances recommend they be placed upon a dedicated circuit; that is, a single outlet circuit which powers only that appliance and has no additional outlets or branch circuits. Check the specification page of this owner's manual to be certain.

Do not overload wall outlets. Overloaded wall outlets, loose or damaged wall outlets, extension cords, frayed power cords, or damaged or cracked wire insulation are dangerous. Any of these conditions could result in electric shock or fire. Periodically examine the cord of your appliance, and if its appearance indicates damage or deterioration, unplug it, discontinue use of the appliance, and have the cord replaced with an exact replacement part by an authorized servicer.

Protect the power cord from physical or mechanical abuse, such as being twisted, kinked, pinched, closed in a door, or walked upon. Pay particular attention to plugs, wall outlets, and the point where the cord exits the appliance.

FOR LCD TV

Note

- If the TV feels cold to the touch, there may be a small "flicker" when when it is turned on. This is normal, there is nothing wrong with TV.
- Some minute dot defects may be visible on the screen, appearing as tiny red, green, or blue spots. However, they have no adverse effect on the monitor's performance.
- Avoid touching the LCD screen or holding your finger(s) against it for long periods of time. Doing so may produce some temporary distortion effects on the screen.

On Disposal

- a. The fluorescent lamp used in this product contains a small amount of mercury.
- b. Do not dispose of this product with general household waste.
Disposal of this product must be carried out in accordance to the regulations of your local authority.

Contents

| | | |
|---------------------|--------------------------------------|-----------------------------------------------------------------------------------------------------------------------------------------------------------------------------------------------------------------------------------------------------------------------------------------------------------------------------------------------------------------------------------|
| Introduction | | <p>2 Warning</p> <p>3~4 Safety Instructions</p> <p>7 Accessories</p> <p>8~11 Controls</p> <p style="padding-left: 20px;">Connection Options</p> <p>12~13 Remote Control Key Functions</p> |
| Installation | External Equipment Connections | <p>14 Attaching the TV to a wall</p> <p>15 Desktop Pedestal Installation</p> <p>16~17 Basic Connection</p> <hr style="border-top: 1px dotted #000;"/> <p>18 Antenna or Cable Connection</p> <p>19~20 VCR Setup</p> <p>20 External AV Source Setup</p> <p>21~22 DVD Setup</p> <p>23~24 HDSTB Setup</p> <p>25 AV Out Setup</p> <p>25 Digital Audio Output</p> <p>26~28 PC Setup</p> |
| Operation | Basic operation | <p>29 Turning on the TV</p> <p>29 Volume Adjustment</p> <p>29 Channel Selection</p> <p>29 On Screen Menus Language Selection</p> <p>30 On Screen Menus Selection and Adjustment</p> <hr style="border-top: 1px dotted #000;"/> |
| | Setup Menu Options | <p>31 EZ Scan (Channel Search)</p> <p>31 Manual Scan</p> <p>32 Channel Edit</p> <p>33 DTV Signal Strength</p> <p>33 Input Source</p> <p>34 Input Label</p> <hr style="border-top: 1px dotted #000;"/> |
| | Video Menu Options | <p>35 Auto Picture Control(EZ Picture)</p> <p>35~36 Color Temperature Control</p> <p>37 XD</p> <p>38 Advanced-Cinema 3:2 Mode / Black Level</p> <p>39 Video Reset</p> <hr style="border-top: 1px dotted #000;"/> |
| | Audio Menu Options | <p>40 Audio Language</p> <p>41 Auto Sound Control(EZ Sound)</p> <p>41~42 Manual Sound Control (EZ Sound-User option)</p> <p>43 Balance</p> <p>43 TV Speakers On/Off Setup</p> |

| | | | |
|-------------------|--------------------------------------------|----------------------------------------------------------------------------|---------------------|
| Operation | Time Menu Options | 44 | Manual Clock Setup |
| | Option Menu Features | 44 | Auto Clock Setup |
| | | 45 | On/Off Timer Setup |
| 45 | | Sleep Timer | |
| 46 | | Auto Off | |
| 47 | | Aspect Ratio Control | |
| 48 | | Caption/Text | |
| 49 | | Caption Option | |
| Lock Menu Options | 49 | Low Power (42PC3D/3DV, 50PC3D, 60PC1D Only) | |
| | 50 | ISM (Image Sticking Minimization) Method (42PC3D/3DV, 50PC3D, 60PC1D Only) | |
| | | 51~52 | Parental Lock Setup |
| <hr/> | | | |
| Reference | 53~58 External Control Device Setup | | |
| | 59~60 IR Codes | | |
| | 61 Programming the Remote | | |
| | 62~63 Programming Codes | | |
| | 64~65 Troubleshooting Checklist | | |
| | 65 Maintenance | | |
| | 66~67 Product Specifications | | |

Introduction

Accessories

Ensure that the following accessories are included with your TV. If any accessory is missing, please contact the dealer from where you purchased the product. User must use shielded signal interface cables(D-sub 15 pin cable) with ferrite cores to maintain standard compliance for the product.



Power Cord



75Ω Round Cable

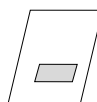

Owner's Manual

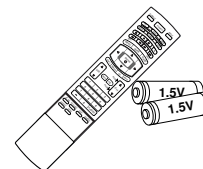
Remote Control /
Batteries

For 42PC3D/3DV, 50PC3D



2-Wall brackets



2-eye-bolts

42PC3D/3DV only

2-bolts
(Refer p.14)

Option Extras



D-sub 15 pin cable

For 32/37/42LC2D, 32LC2DU

2-TV brackets
2-Wall brackets

2-TV Bracket Bolts

Twister Holder
Arrange the wires
with the twister holder.Cable
Management
(Refer p.16)

42LC2D only

Polishing Cloth
Polish the TV with
the cloth.

32LC2D/U only

4-bolts for stand
assembly
See below for detail
information.

[Polishing Cloth]

Slightly wipe stained spot on the exterior only with the cleansing cloths for the product exterior if there is stain or fingerprint on surface of the exterior. Do not wipe roughly when removing stain. Please be cautious of that excessive power may cause scratch or discoloration.

For 60PC1D

2-TV brackets
2-Wall brackets

4- Bolts



4-RING SPACER

Polishing Cloth
Polish the TV
with the cloth.

Stand Installation for 32LC2D/U

- Carefully place the product screen side down on a cushioned surface that will protect product and screen from damage.

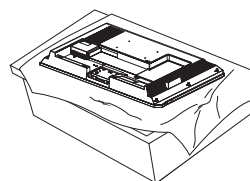

- Place the hook of the stand in the back of the product as shown.

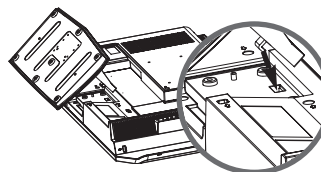

- Install the 4 bolts provided securely, in the back of the product.

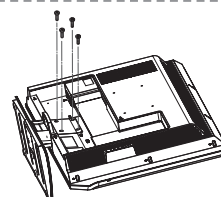

Controls (Model Name: 42PC3D/3DV, 50PC3D, 60PC1D)

- This is a simplified representation of front panel.
- This picture shown below may be somewhat different from your TV.

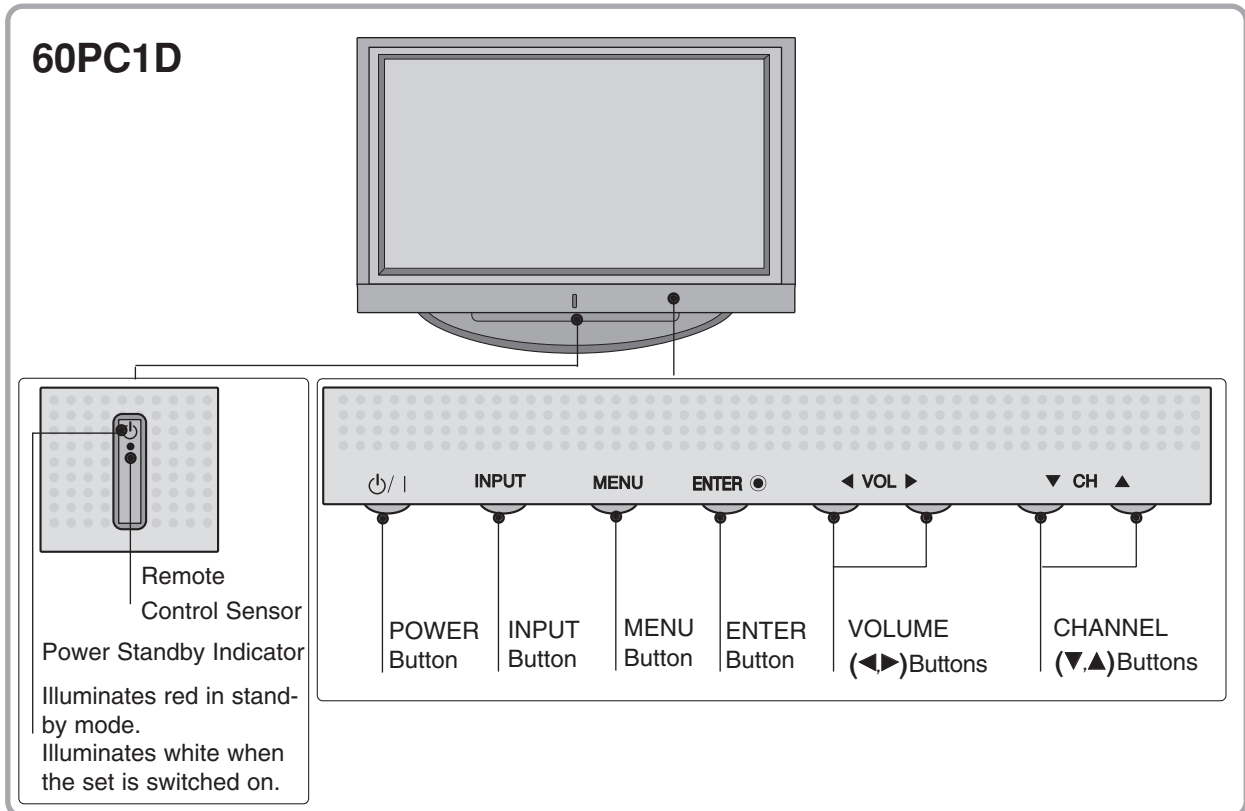
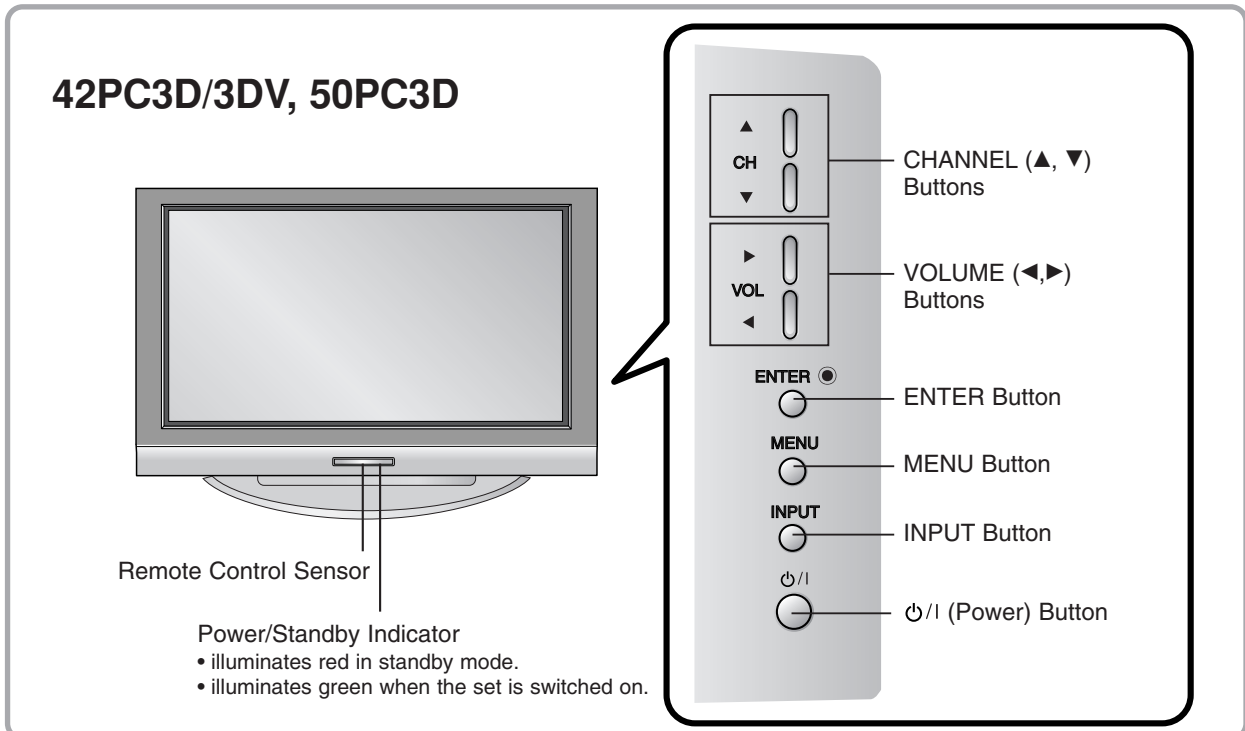

Connection Options (Model Name: 42PC3D/3DV, 50PC3D, 60PC1D)

- This picture shown below may be somewhat different from your TV.

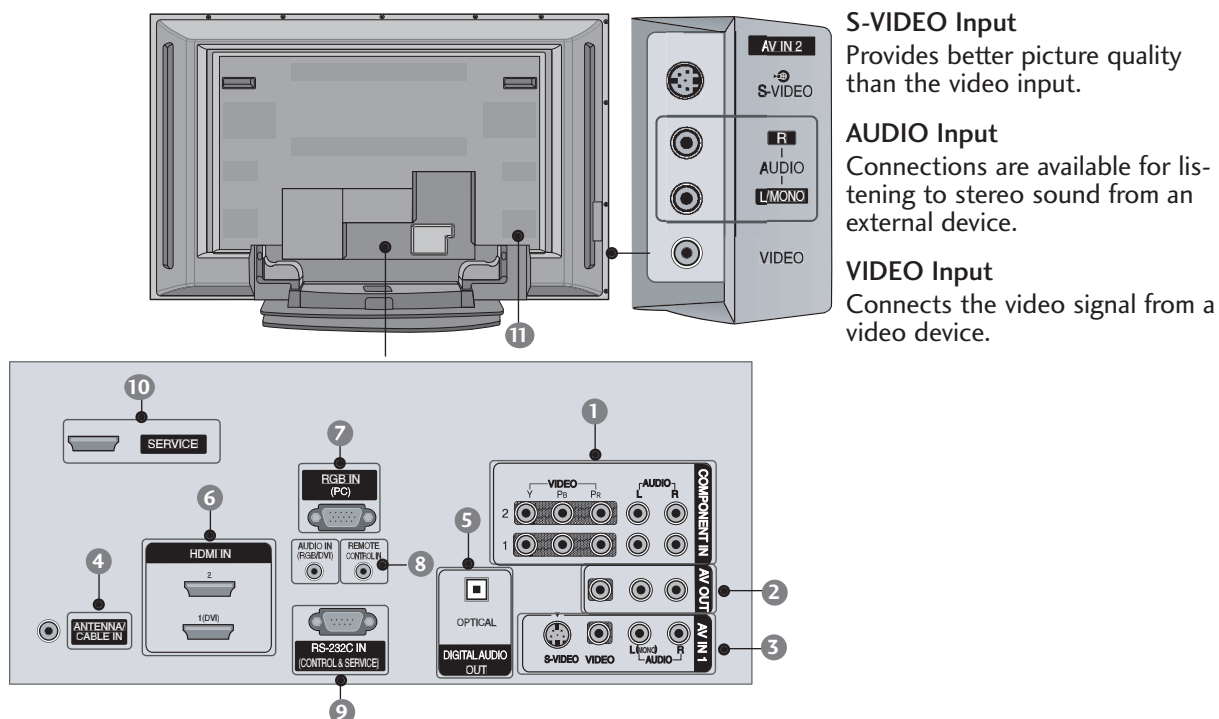

S-VIDEO Input

Provides better picture quality than the video input.

AUDIO Input

Connections are available for listening to stereo sound from an external device.

VIDEO Input

Connects the video signal from a video device.

1 COMPONENT IN

Connect a component video/audio device to these jacks.

2 AV OUT

Connect a second TV or monitor.

3 AV (Audio/Video) IN 1

Connect audio/video output from an external device to these jacks.

S-VIDEO

Connect S-Video out from an S-VIDEO device.

4 ANTENNA/CABLE IN

Connect over-the air signals to this jack.
Connect cable signals to this jack.

5 DIGITAL AUDIO OUT

Connect digital audio from various types of equipment.

Note: In standby mode, these ports do not work.

6 HDMI IN

Connect a HDMI signal to 1 (DVI) or 2.
Or DVI (VIDEO) signal to the 1 (DVI) port with a DVI to HDMI cable.

7 RGB IN (PC)

Connect the monitor output from a PC to the appropriate input port.

8 Remote Control Port

Connect your wired remote control.

AUDIO IN (RGB/DVI)

Connect the monitor output from a PC to the appropriate input port.

9 RS-232C IN (CONTROL & SERVICE) PORT

Connect to the RS-232C port on a PC.

10 SERVICE

11 Power Cord Socket

For operation with AC power.

Caution:

Never attempt to operate the TV on DC power.

Controls (Model Name: 32/37/42LC2D, 32LC2DU)

- This is a simplified representation of front panel.
- This picture shown below may be somewhat different from your TV.

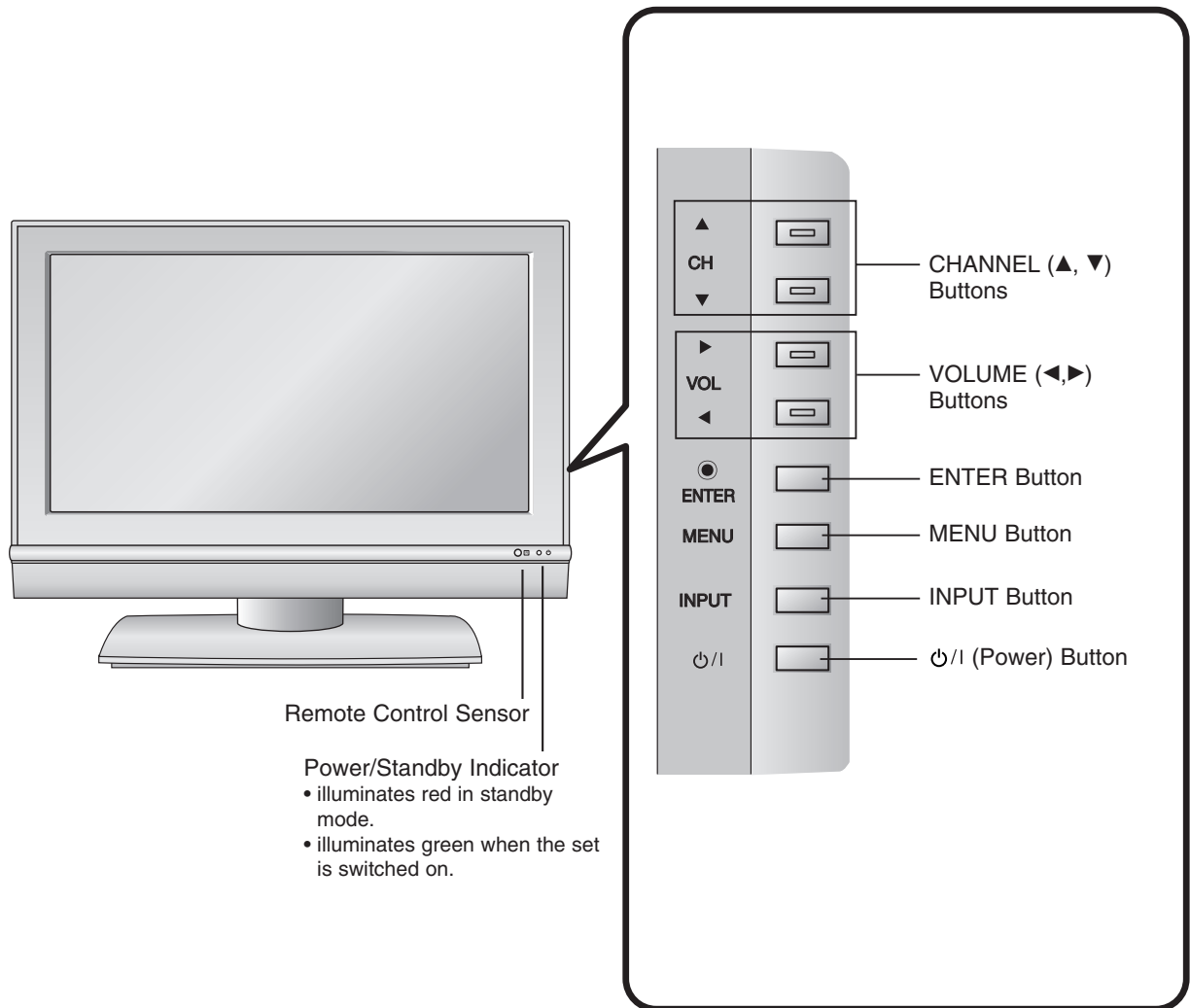

Swivel Stand (42LC2D Only)

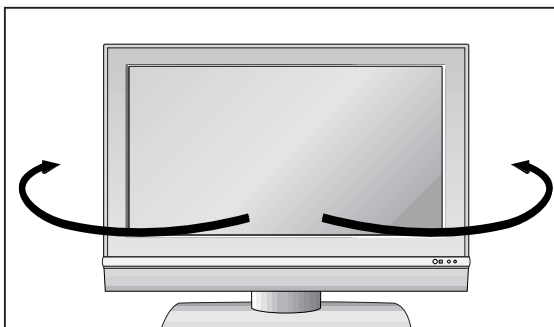

- The TV can be conveniently swivelled on its stand 30° to the left or right to provide the optimum viewing angle.

Connection Options (Model Name: 32/37/42LC2D, 32LC2DU)

- This picture shown below may be somewhat different from your TV.

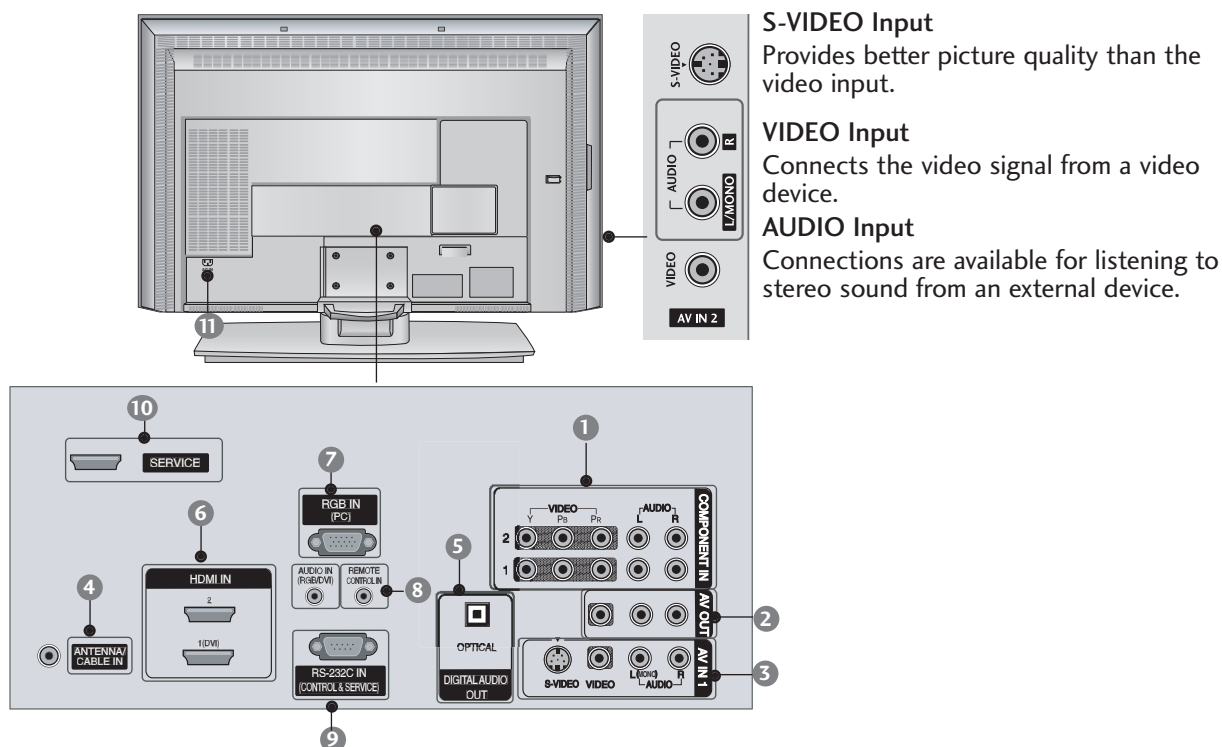

1 COMPONENT IN

Connect a component video/audio device to these jacks.

2 AV OUT

Connect a second TV or monitor.

3 AV (Audio/Video) IN 1

Connect audio/video output from an external device to these jacks.

S-VIDEO

Connect S-Video out from an S-VIDEO device.

4 ANTENNA/CABLE IN

Connect over-the air signals to this jack.
Connect cable signals to this jack.

5 DIGITAL AUDIO OUT

Connect digital audio from various types of equipment.

Note: In standby mode, these ports do not work.

6 HDMI IN

Connect a HDMI signal to 1 (DVI) or 2.
Or DVI (VIDEO) signal to the 1 (DVI) port with a DVI to HDMI cable.

S-VIDEO Input

Provides better picture quality than the video input.

VIDEO Input

Connects the video signal from a video device.

AUDIO Input

Connections are available for listening to stereo sound from an external device.

7 RGB IN (PC)

Connect the monitor output from a PC to the appropriate input port.

8 Remote Control Port

Connect your wired remote control.

AUDIO IN (RGB/DVI)

Connect the monitor output from a PC to the appropriate input port.

9 RS-232C IN (CONTROL & SERVICE) PORT

Connect to the RS-232C port on a PC.

10 SERVICE

11 Power Cord Socket

For operation with AC power.

Caution:

Never attempt to operate the TV on DC power.

Remote Control Key Functions

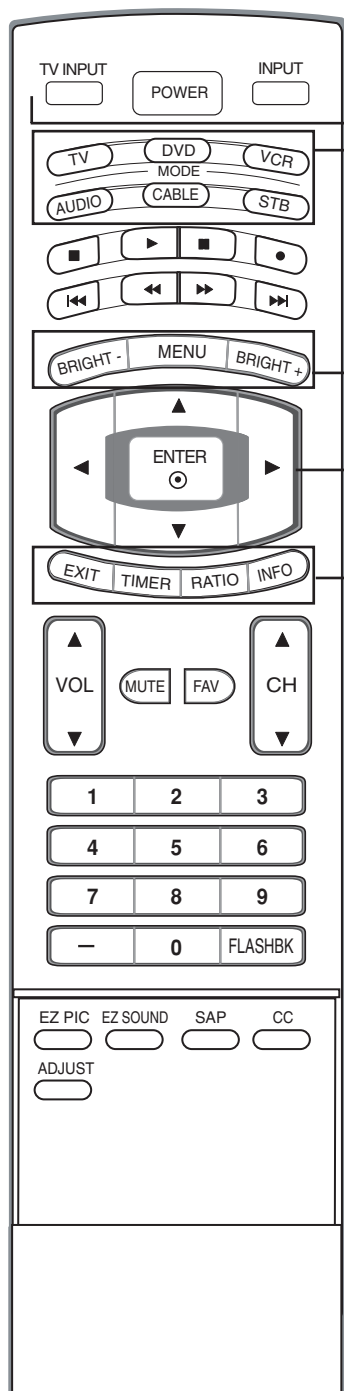

POWER

Turns your TV or any other programmed equipment on or off, depending on mode.

TV INPUT

In AV1-2, Component 1-2, or RGB-PC, HDMI1/DVI, and HDMI2 input sources, screen returns to the last TV channel.

INPUT

External input modes rotate in regular sequence: TV, AV1-2, Component 1-2, RGB-PC, HDMI1/DVI or HDMI2.

(AV 1-2, Component 1-2, RGB-PC , HDMI1/DVI or HDMI2 input sources are linked automatically, only if these are connected.)

MODE

Selects the remote operating mode: TV, DVD, VCR, AUDIO, CABLE, or STB. Select a mode other than TV, for the remote to operate an external device.

MENU

Brings up the main menu to the screen.

BRIGHT + / -

- Adjust brightness on screen.
- It turns to the default settings brightness by changing mode source.

THUMBSTICK (Up/Down/Left/Right/ENTER)

Allows you to navigate the on-screen menus and adjust the system settings to your preference.

EXIT

Clears all on-screen displays and returns to TV viewing from any menu.

TIMER ▶ p.45

Lets you select the amount of time before your TV turns itself off automatically.

RATIO ▶ p.47

Changes the aspect ratio.

INFO

When you watch the TV, information displays on top of the screen. Not available in Component 1-2, RGB, HDMI1/DVI and HDMI2 mode.

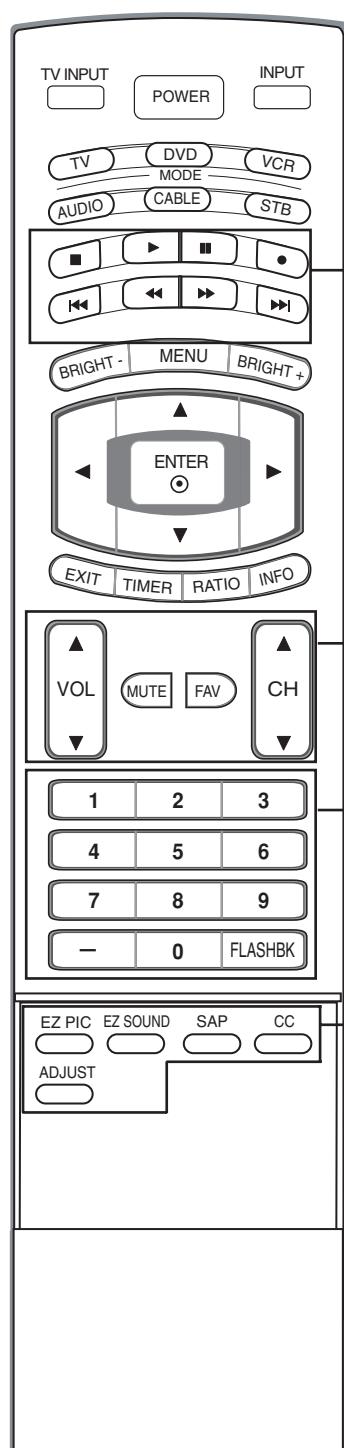
**VCR/DVD/DVHS/Camcorder BUTTONS**

Control some video cassette recorders or DVD players ("RECORD" button is not available for DVD player).

VOLUME UP/DOWN

Increases/decreases the sound level.

CHANNEL UP/DOWN

Selects available channels found with EZ scan and Manual scan.

MUTE ▶ p.29

Switches the sound on or off.

FAV

Use to scroll the Favorite channels.

NUMBER BUTTONS**— (DASH)**

Used to enter a program number for multiple program channels such as 2-1, 2-2, etc.

FLASHBK

Returns to the last channel viewed.

EZ PIC ▶ p.35

Selects a factory preset picture mode depending on the viewing environment.

EZ SOUND ▶ p.41

Selects the sound appropriate for the program's character.

SAP

Selects MTS sound: Mono, Stereo, and SAP in analog mode. Change the audio language in DTV mode.

CC ▶ p.48 (*In DTV/CADTV mode ▶ p.48)

Select a closed caption: Off, CC1~4, Text1~4.

ADJUST

Adjusts screen position, size, and phase in PC mode.

Installing Batteries

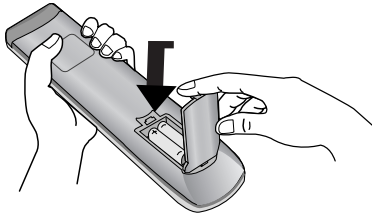

- Open the battery compartment cover on the back side and install the batteries matching correct polarity (+with +,-with -).
- Install two 1.5V AA batteries. Don't mix old or used batteries with new ones.
- Close cover.

Remote control effective range

32/37/42LC2D,
32LC2DU

42PC3D/3DV, 50PC3D

60PC1D

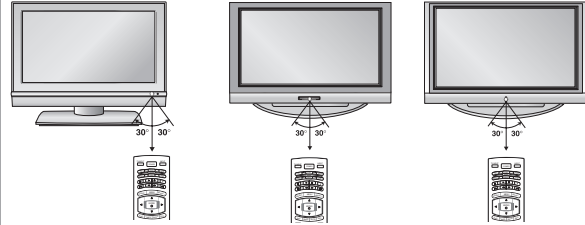

- Use a remote control up to 7 meters distance and 30 degree (left/right) within the receiving unit scope.
- Dispose of used batteries in a recycle bin to preserve environment.

ATTACHING THE TV TO A WALL

We recommend that you set up the TV close to a wall so it cannot fall over if pushed backwards. Additionally, we recommend that the TV be attached to a wall so it cannot be pulled in a forward direction, potentially causing injury or damaging the product.
Caution: Please make sure that children don't climb on or hang from the TV.

42PC3D/3DV, 50PC3D

60PC1D

32/37/42LC2D, 32LC2DU

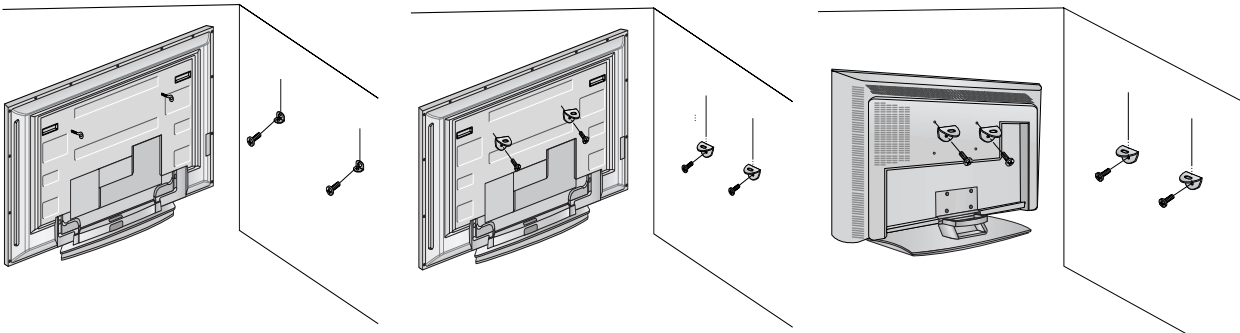

- Insert the eye-bolts (or TV brackets and bolts) to tighten the product to the wall as shown in the picture.

* If your product has the bolts in the eye-bolts position, loosen the bolts.

Secure the wall brackets with the bolts (not provided as parts of the product, must purchase separately) on the wall. Match the height of the bracket that is mounted on the wall to the holes in the product.

Ensure the eye-bolts or brackets are tightened securely.

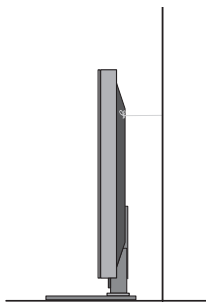

- Use a sturdy rope (not provided as parts of the product, must purchase separately) to tie the product. It is safer to tie the rope so it becomes horizontal between the wall and the product.

Installation

DESKTOP PEDESTAL INSTALLATION

For proper ventilation, allow a clearance of 4 inches on each side from the wall.

42PC3D/3DV, 50PC3D, 60PC1D

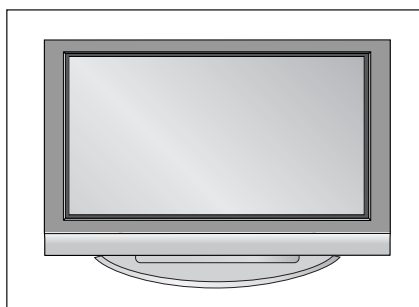

32/37/42LC2D, 32LC2DU

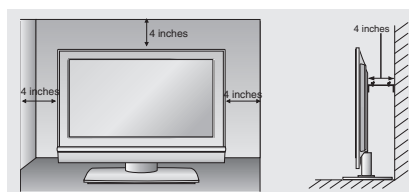
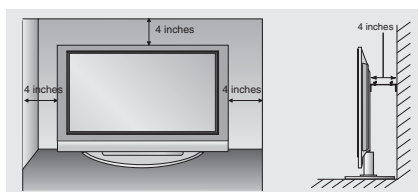
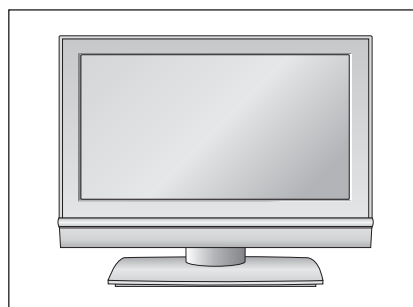

⚠ CAUTION

- ▶ Ensure adequate ventilation by following the clearance recommendations.

- This picture shown below may be somewhat different from your TV.



GROUNDING

Ensure that you connect the earth ground wire to prevent possible electric shock. If grounding methods are not possible, have a qualified electrician install a separate circuit breaker.

Do not try to ground the unit by connecting it to telephone wires, lightning rods, or gas pipes.

Basic Connection (For 32/37/42LC2D, 32LC2DU)

- 1 Connect the cables as necessary. After connecting the cables neatly, arrange the cables to the Cable Holder.

To connect an additional equipment, see the **External equipment Connections** section.

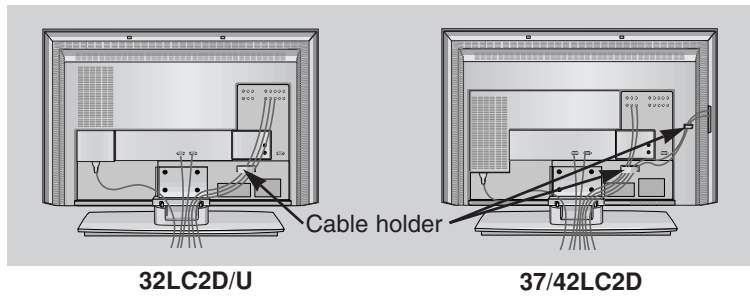

- 2 Reinstall the **CABLE MANAGEMENT** as shown.

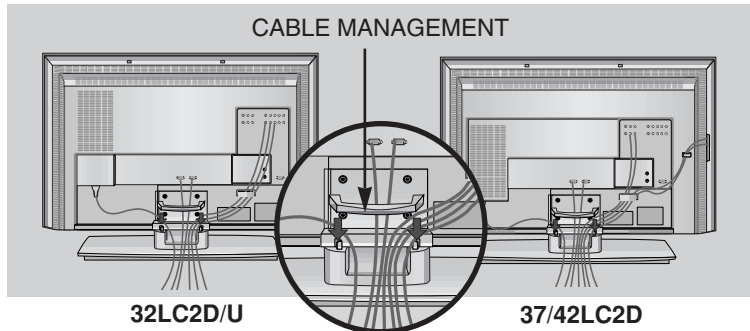

- 3 Bundle the cables using the supplied twister holder.

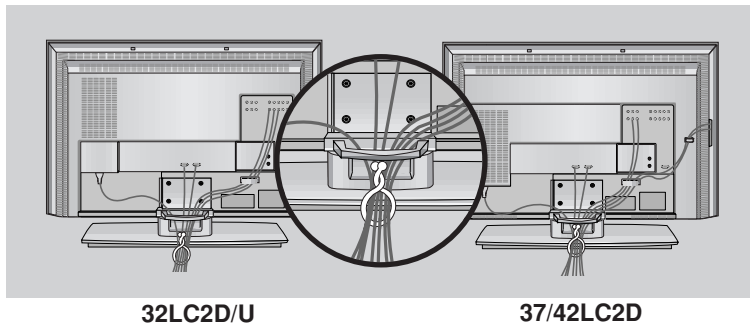

How to remove the CABLE MANAGEMENT

- Hold the **CABLE MANAGEMENT** with both hands and pull it upward.

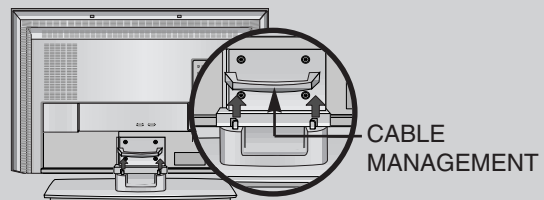

- Do not hold the **CABLE MANAGEMENT** when moving the product.
- If the product is dropped, you may be injured or the product may be broken.

Basic Connection

How to use stand (For 42PC3D/3DV)

- 1** Place the set with the screen facing down on a cushion or soft cloth as shown. Before unfolding the stand, please make sure two locks (A) on the bottom of the stand push outward.

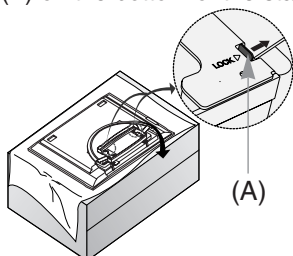

- 2** Pull the stand out as shown. After unfolding the stand, please insert and tighten the screws (provided as parts of the product) in the holes (B) on the bottom of the stand.

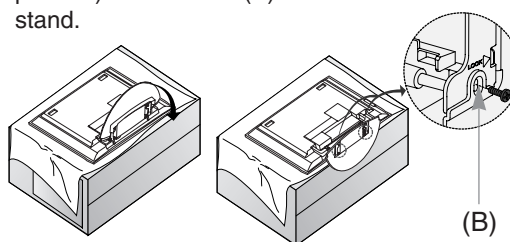

- 3** When connecting cables to the set, Do not disengage the lock (C). This may cause the set to fall, causing serious bodily injury and serious damage to the set.

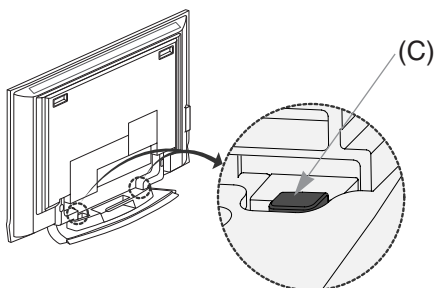

* Image shown here may be slightly different from your set.

When closing the stand for storage

- First remove the screws in the holes (B) on the bottom of the stand. And then pull two Hooks (D) of the stand bottom and fold the stand into the back of the set.
- After folding, push the two Locks (A) of the stand bottom outward.

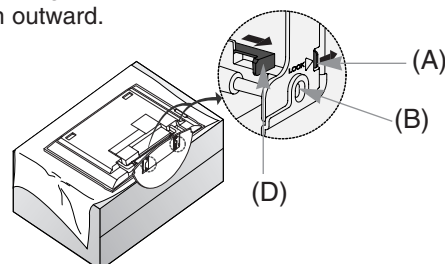

How to arrange the cable (For 50PC3D)

- 1** Hold the **CABLE MANAGEMENT** with both hands and push it as shown.

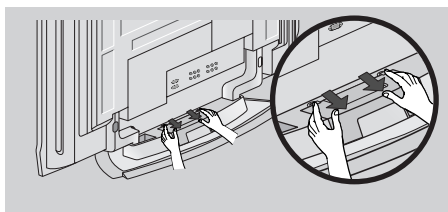

- 2** Connect the cables as necessary. To connect an additional equipment, see the **External equipment Connections** section.

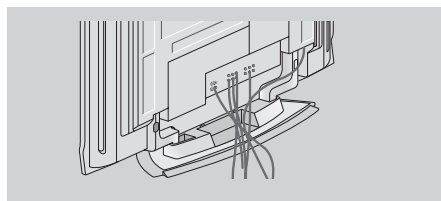

- 3** Reinstall the **CABLE MANAGEMENT** as shown.

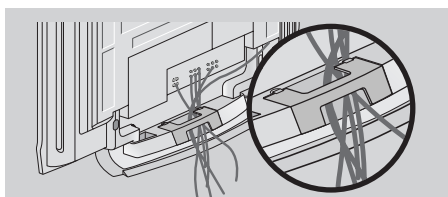

For 60PC1D, 42PC3D/3DV

Arrange the cable as shown.

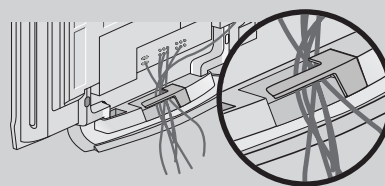

External Equipment Connections

NOTE: All cables shown are not included with the TV

Antenna Or Cable Connection

Analog and Digital TV signals provided on antenna

- Antenna or Cable Service without a Cable Box Connection.
- For optimum picture quality, adjust antenna direction if needed.



Multi-family Dwellings/Apartments
(Connect to wall antenna socket)



Wall Antenna Socket

RF Coaxial Wire (75 ohm)

VHF Antenna
UHF Antenna

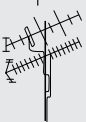

Outdoor Antenna

Turn clockwise to tighten.

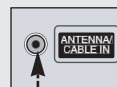

ANTENNA/
CABLE IN

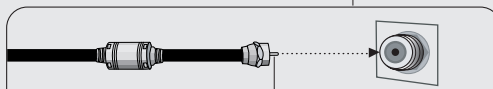

Bronze Wire

Be careful not to bend the bronze wire when connecting the antenna.



Single-family Dwellings /Houses
(Connect to wall jack for outdoor antenna)

Analog and Digital TV signals provided on cable



Cable TV Wall Jack



RF Coaxial Wire (75 ohm)



ANTENNA/
CABLE IN

Turn clockwise to tighten.

Analog and DTV signals provided on two separate antennas



Antenna

RF Coaxial Wire (75 ohm)

Bronze Wire

Turn clockwise to tighten.

Cable TV Wall Jack



RF Coaxial Wire (75 ohm)

Bronze Wire

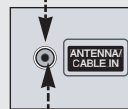

ANTENNA/
CABLE IN



VHF

UHF

signal amplifier

- In a poor signal area to improve picture quality, purchase and install a signal amplifier.
- If the antenna needs to be split for two TV's, install a "2-Way Signal Splitter" in the connections.
- If the antenna is not installed properly, contact your dealer for assistance.

VCR Setup

- To avoid picture noise (interference), leave an adequate distance between the VCR and TV.
- Typically a frozen still picture from a VCR. If the 4:3 picture format is used; the fixed images on the sides of the screen may remain visible on the screen.

When connecting with an antenna

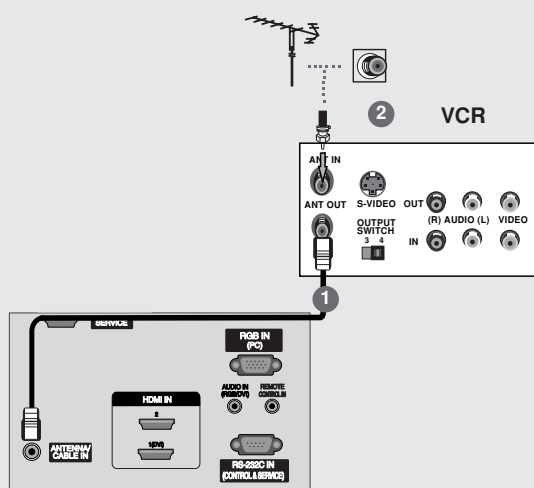

- 1 Connect the RF antenna out socket of the VCR to the **Antenna** socket on the set.
- 2 Connect the antenna cable to the RF antenna in socket of the VCR.
- 3 Set VCR output switch to 3 or 4 and then tune TV to the same channel number.
- 4 Insert a video tape into the VCR and press PLAY on the VCR. (Refer to the VCR owner's manual.)

When connecting with a RCA cable

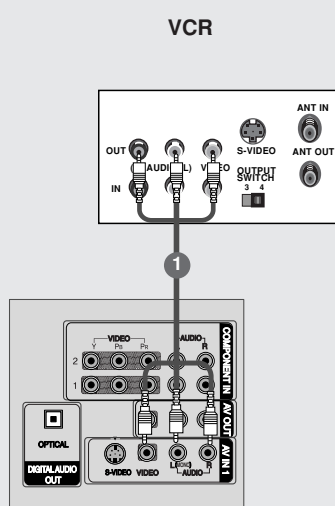

- 1 Connect the **AUDIO/VIDEO** jacks between TV and VCR. Match the jack colors (Video = yellow, Audio Left = white, and Audio Right = red)
- 2 Insert a video tape into the VCR and press PLAY on the VCR. (Refer to the VCR owner's manual.)
- 3 Select **AV1** input source using the **INPUT** button on the remote control.
 - If connected to **AV IN2**, select **AV2** input source.



- If you have a mono VCR, connect the audio cable from the VCR to the **AUDIO L/MONO** jack of the set.

When connecting with an S-Video cable

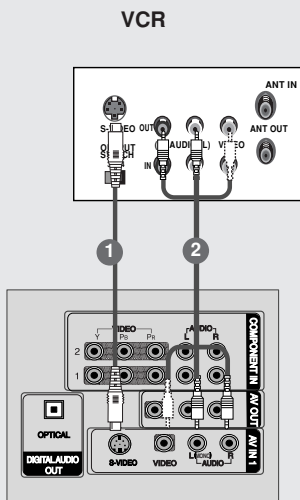

- 1 Connect the S-VIDEO output of the VCR to the **S-VIDEO** input on the set. The picture quality is improved; compared to normal composite (RCA cable) input.
- 2 Connect the audio outputs of the VCR to the **AUDIO** input jacks on the set.
- 3 Insert a video tape into the VCR and press PLAY on the VCR. (Refer to the VCR owner's manual.)
- 4 Select **AV1** input source with using the **INPUT** button on the remote control.
- If connected to **AV IN2**, select **AV2** input source.

 Do not connect to both Video and S-Video at the same time. In the event that you connect both Video and the S-Video cables, only the S-Video will work.

External AV Source Setup

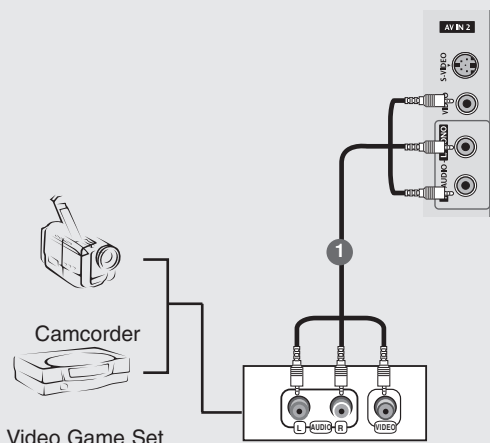

- 1 Connect the **AUDIO/VIDEO** jacks between TV and external equipment. Match the jack colors (Video = yellow, Audio Left = white, and Audio Right = red).
- 2 Select **AV2** input source with using the **INPUT** button on the remote control.
- If connected to **AV IN1** input, select **AV1** input source.
- 3 Operate the corresponding external equipment. Refer to external equipment operating guide.

 This TV finds the connected input sources automatically for AV1, AV2, Component 1-2, RGB, HDMI1/DVI and HDMI2 sources are connected.

DVD Setup

When connecting with a S-Video cable

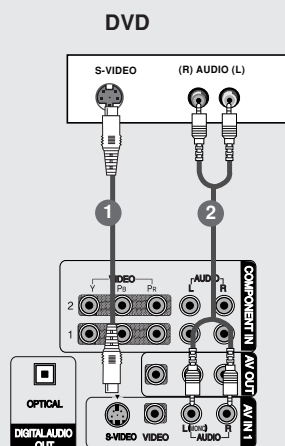

- 1 Connect the S-VIDEO output of the DVD to the **S-VIDEO** input on the set.
- 2 Connect the audio outputs of the DVD to the **AUDIO** input jacks on the set.
- 3 Turn on the DVD player, insert a DVD.
- 4 Select **AV1** input source with using the **INPUT** button on the remote control.
- If connected to **AV IN2**, select **AV 2** input source.
- 5 Refer to the DVD player's manual for operating instructions.

When connecting with a HDMI cable

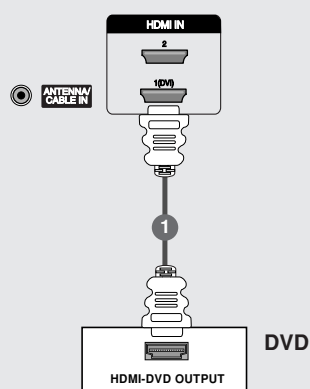

- 1 Connect the HDMI output of the DVD to the **HDMI IN 1(DVI)** or **2** jack on the set.
- 2 Select **HDMI1/DVI** or **HDMI2** input source with using the **INPUT** button on the remote control.
- 3 Refer to the DVD player's manual for operating instructions.



- TV can receive the video and audio signal simultaneously with using a HDMI cable.
- If the DVD supports Auto HDMI function, the DVD output resolution will be automatically set to 1280x720p.
- If the DVD does not support Auto HDMI, you need to set the output resolution appropriately. To get the best picture quality, adjust the output resolution of the DVD to 1280x720p.

When connecting with a component cable

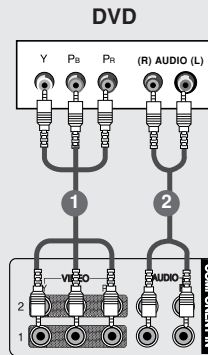

- 1 Connect the video outputs (Y, Pb, Pr) of the DVD to the **COMPONENT IN VIDEO** jacks on the set.
- 2 Connect the audio outputs of the DVD to the **COMPONENT IN AUDIO** jacks on the set.
- 3 Turn on the DVD player, insert a DVD.
- 4 Select **Component 1** input source with using the **INPUT** button on the remote control.
- If connected to **COMPONENT IN 2**, select **Component 2** input source.
- 5 Refer to the DVD player's manual for operating instructions.



• Component Input ports

To get better picture quality, connect a DVD player to the component input ports as shown below.

| | | | |
|-------------------------------------|---|-----|-----|
| Component ports on the TV | Y | Pb | Pr |
| Video output ports on DVD player | Y | Pb | Pr |
| | Y | B-Y | R-Y |
| | Y | Cb | Cr |
| | Y | PB | PR |

HDSTB Setup

- This TV can receive Digital Over-the-air/Cable signals without an external digital set-top box. However, if you do receive Digital signals from a digital set-top box or other digital external device, refer to the figure as shown below.

When connecting with a HDMI cable

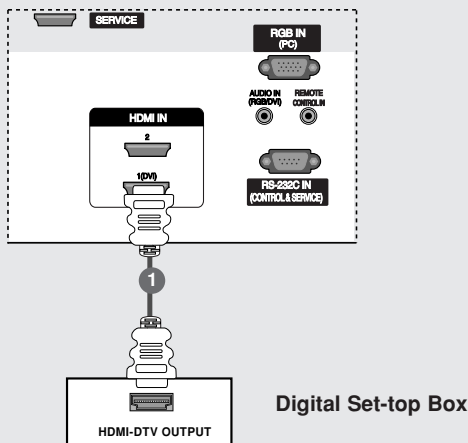

- 1 Connect the HDMI output of the digital set-top box to the **HDMI IN 1(DVI)** or **2** jack on the set.
- 2 Select **HDMI1/DVI** or **HDMI2** input source with using the **INPUT** button on the remote control.
- 3 Turn on the digital set-top box. (Refer to the owner's manual for the digital set-top box.)



- TV can receive the video and audio signal simultaneously using a HDMI cable.
- If the digital set-top box supports Auto HDMI function, output resolution of the digital set-top box will be automatically set to 1280x720p.
- If the digital set-top box does not support Auto HDMI, you need to set the output resolution appropriately. To get the best picture quality, adjust the output resolution of the digital set-top box to 1280x720p.

When connecting with a Component cable

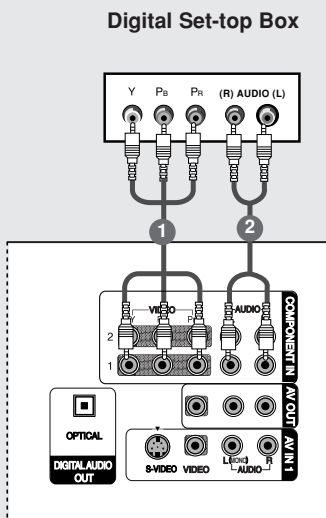

- 1 Connect the video outputs (Y, Pb, Pr) of the digital set-top box to the **COMPONENT IN VIDEO** jacks on the set.
- 2 Connect the audio output of the digital set-top box to the **COMPONENT IN AUDIO** jacks on the set.
- 3 Turn on the digital set-top box. (Refer to the owner's manual for the digital set-top box.)
- 4 Select **Component 1** input source with using the **INPUT** button on the remote control.
- If connected to **COMPONENT IN 2**, select **Component 2** input source.



| Signal | Component1/2 | HDMI1/DVI, HDMI2 |
|-----------------|--------------|------------------|
| 480i | Yes | No |
| 480p/720p/1080i | Yes | Yes |

When connecting with a HDMI to DVI cable

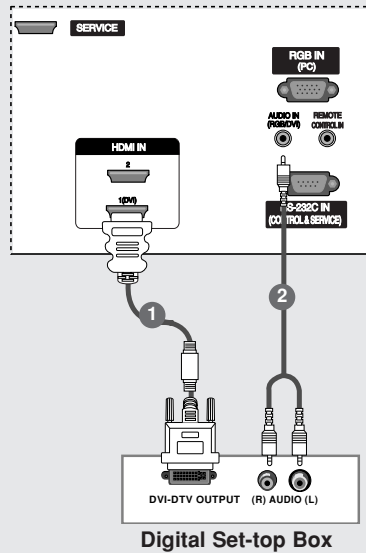

- 1 Connect the DVI output of the digital set-top box to the **HDMI IN 1(DVI)** jack on the set.
- 2 Connect the audio outputs of the set-top box to the **AUDIO IN(RGB/DVI)** jack on the set.
- 3 Turn on the digital set-top box. (Refer to the owner's manual for the digital set-top box.)
- 4 Select **HDMI1/DVI** input source with using the **INPUT** button on the remote control.



- If the digital set-top box has a DVI output and no HDMI output, a separated audio connection is necessary.
- If the digital set-top box supports Auto DVI function, the output resolution of the digital set-top box will be automatically set to 1280x720p.
- If the digital set-top box does not support Auto DVI, you need to set the output resolution appropriately. To get the best picture quality, adjust the output resolution of the digital set-top box to 1280x720p.

AV Out Setup

- The TV has a special signal output capability which allows you to hook up a second TV or monitor.

- 1 Connect the second TV or monitor to the TV's **AV OUT** jacks.
- 2 See the Operating Manual of the second TV or monitor for further details regarding that device's input settings.

- Component 1-2, RGB-PC, HDMI1/DVI, HDMI2, DTV input sources cannot be used for Monitor out.
- We recommend to use the video and audio output jacks for VCR recording.

Digital Audio Output

- Send the TV's audio to external audio equipment (stereo system) via the Digital Audio Output Optical port.

- 1 Connect one end of an optical cable to the TV Digital Audio Optical Output port.
- 2 Connect the other end of the optical cable to the digital audio optical input on the audio equipment.
- 3 See the external audio equipment instruction manual for operation.
When connecting with external audio equipments, such as amplifiers or speakers, please turn the TV speakers off. (Refer to p.43)

CAUTION
Do not look into the optical output port. Looking at the laser beam may damage your vision.

PC Setup

- This TV provides Plug and Play capability, meaning that the PC adjusts automatically to the TV's settings.

When connecting with a D-sub 15 pin cable

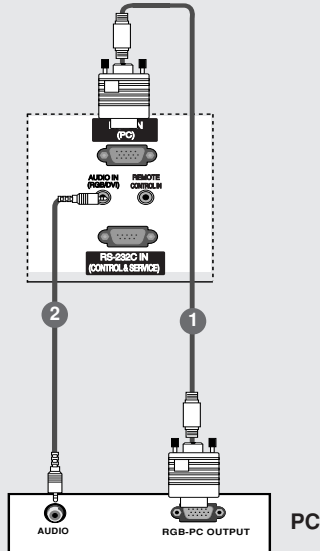

- 1 Connect the RGB output of the PC to the **RGB IN (PC)** jack on the set.
- 2 Connect the PC audio outputs to the **AUDIO IN (RGB/DVI)** jack on the set.
- 3 Turn on the PC and the set.
- 4 Select **RGB-PC** input source with using the **INPUT** button on the remote control.

When connecting with a HDMI to DVI cable

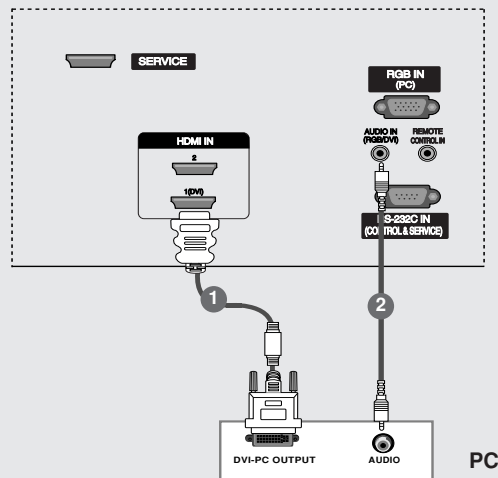

- 1 Connect the DVI output of the PC to the **HDMI IN 1 (DVI)** jack on the set.
- 2 Connect the audio outputs of the PC to the **AUDIO IN (RGB/DVI)** jack on the set.
- 3 Turn on the PC and the set.
- 4 Select **HDMI1/DVI** input source with using the **INPUT** button on the remote control.



- If the PC has a DVI output and no HDMI output, a separated audio connection is necessary.
- If the PC does not support Auto DVI, you need to set the output resolution appropriately. To get the best picture quality, adjust the output resolution of PC graphics card's to 1024x768, 60Hz.



1. Depending on the graphics card, DOS mode may not work if a HDMI to DVI Cable is in use.
2. When Source Devices connected with HDMI/DVI Input, output PC Resolution (VGA, SVGA, XGA, WXGA), Position and Size may not fit to Screen. Press the ADJUST button to adjust the screen Position of TV SET and contact an PC graphics card service center.
3. When Source Devices connected with HDMI/DVI Input, output TV SET Resolution (480p, 720p, 1080i, 1080p) and TV SET Display fit EIA/CEA-861-B Specification to Screen. If not, refer to the Manual of HDMI/DVI Source Devices or contact your service center.
4. In case HDMI/DVI Source Devices is not connected Cable or poor cable connection, "NO SIGNAL" OSD display in HDMI/DVI Input. In case that Video Resolution is not supported TV SET output in HDMI/DVI Source Devices, "INVALID FORMAT" OSD display. Refer to the Manual of HDMI/DVI Source Devices or contact your service center.
5. Check the image on your TV. There may be noise associated with the resolution, vertical pattern, contrast or brightness in PC, HDMI/DVI mode. If noise is present, change the PC or HDMI/DVI mode to another resolution, change the refresh rate to another rate or adjust the brightness and contrast on the menu until the picture is clear. If the refresh rate of the PC graphic card can not be changed, change the PC graphic card or consult the manufacturer of the PC graphic card.
6. Avoid keeping a fixed image on the TV's screen for a long period of time. The fixed image may become permanently imprinted on the screen.
7. The synchronization input form for Horizontal and Vertical frequencies is separate.

Supported Display Resolution

RGB-PC, HDMI1/DVI-PC Mode

| Resolution | Horizontal Frequency (kHz) | Vertical Frequency (Hz) | Resolution | Horizontal Frequency (kHz) | Vertical Frequency (Hz) |
|------------|----------------------------|-------------------------|-------------------|----------------------------|-------------------------|
| *640x350 | 31.469 | 70.08 | 1280x768 | 47.776 | 59.87 |
| 640x480 | 31.469 | 59.94 | 1360x768 | 47.720 | 59.799 |
| *720x400 | 31.469 | 70.08 | 1366x768 | 47.130 | 59.65 |
| 800x600 | 37.879 | 60.31 | * Only for RGB-PC | | |
| 1024x768 | 48.363 | 60.00 | | | |

HDMI1/DVI-DTV, HDMI2-DTV Mode

| Resolution | Horizontal Frequency (kHz) | Vertical Frequency (Hz) | Resolution | Horizontal Frequency (kHz) | Vertical Frequency (Hz) |
|------------|----------------------------|-------------------------|------------|----------------------------|-------------------------|
| 720x480 | 31.469 | 59.94 | 1920x1080i | 33.720 | 59.94 |
| | 31.500 | 60.00 | | 33.750 | 60.00 |
| 1280x720 | 44.960 | 59.94 | 1920x1080p | 27.000 | 24.00 |
| | 45.000 | 60.00 | | 33.750 | 30.00 |

- 42PC3DV is not supported to 1280x768, 1360x768, 1366x768, 1920x1080P.

Screen Setup for PC mode

- When RGB connect to PC input and select the RGB-PC, this function is used.
- When HDMI/DVI connect to PC input and select HDMI/DVI input, this function is used.
- After connecting RGB-PC or HDMI/DVI to PC input and checking the screen quality.

* Adjustment for screen Resolution, Position, Size, and Phase

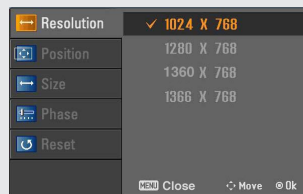
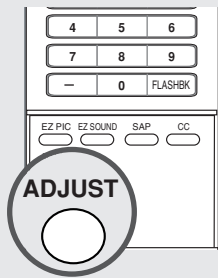

Mini Glossary

Position This function is to adjust picture to left/right and up/down as you prefer.

Size This function is to minimize any vertical bars or stripes visible on the screen background. And the horizontal screen size will also change.

Phase This function allows you to remove any horizontal noise and clear or sharpen the image of characters.

Resolution This function allows you to select Resolution of XGA/WXGA.

1 Press the **ADJUST** button and then use **▲ / ▼** button to select **Resolution, POSITION, SIZE, or PHASE.**

2 Press **ENTER** button and then use **▲ / ▼ / ◀ / ▶** buttons to make appropriate adjustments.

- The **PHASE** adjustment range is -16 ~ +16.
(In HDMI/DVI-PC mode, **PHASE** is not available.)
- The **SIZE** adjustment range is -30 ~ +30.
(In HDMI/DVI-PC mode, **SIZE** is not available.)

3 Press **ENTER** button.

*** When you change the resolution, select the proper resolution in present input to see the best picture appearance.**

* Initializing (Reset to original factory values)

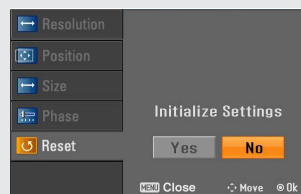
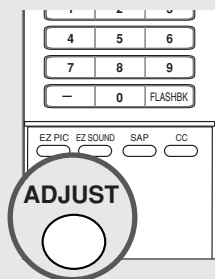

- To initialize the adjusted values

1 Press the **ADJUST** button and then use **▲ / ▼** button to select the **RESET** option.

2 Press **ENTER** button and then use **◀ / ▶** button to select **Yes.**

3 Press **ENTER** button.

Operation

Basic operation

Turning on the TV

1. First, connect power cord correctly. At this moment, the TV switches to standby mode.
In standby mode to turn TV on, press the $\odot/|$, **INPUT, CH ▲ / ▼** button on the TV or press the **POWER, TV INPUT, INPUT, CH ▲ / ▼**, Number (0 ~ 9) button on the remote control .
2. Select the viewing source by using **TV INPUT, INPUT** button on the remote control.
This TV is programmed to remember which power state it was last set to, even if the power cord is out.
3. When finished using the TV, press the **POWER** button on the remote control. The TV reverts to standby mode.

Volume Adjustment

1. Press the **VOL ▲ / ▼** button to adjust the volume.
2. If you want to switch the sound off, press the **MUTE** button.
3. You can cancel this function by pressing the **MUTE** or **VOL ▲ / ▼** button.

Channel Selection

Press the **CH ▲ / ▼** or **NUMBER** buttons to select a channel number.



- If you intend to be away on vacation, disconnect the power plug from the wall power outlet.

On Screen Menus Language Selection

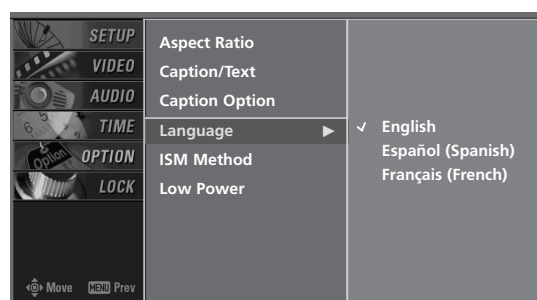
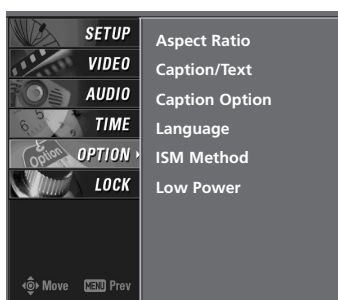

- The menus can be shown on the screen in the selected language. First select your language.

- 1 Press the **MENU** button and then use **▲ / ▼** button to select the **OPTION** menu.
- 2 Press the **▶** button and then use **▲ / ▼** button to select **Language**.
- 3 Press the **▶** button and then use **▲ / ▼** button to select your desired language. From this point on, the on-screen menus will be shown in the selected language.
- 4 Press **EXIT** button to return to TV viewing or press **MENU** button to return to the previous menu.

On Screen Menus Selection and Adjustment

How to adjust the OSD screen

1. Press the **MENU** button and then **▲** / **▼** button to select each menu.
2. Press the **▶** button and then use **▲** / **▼** / **◀** / **▶** button to display the available menus.

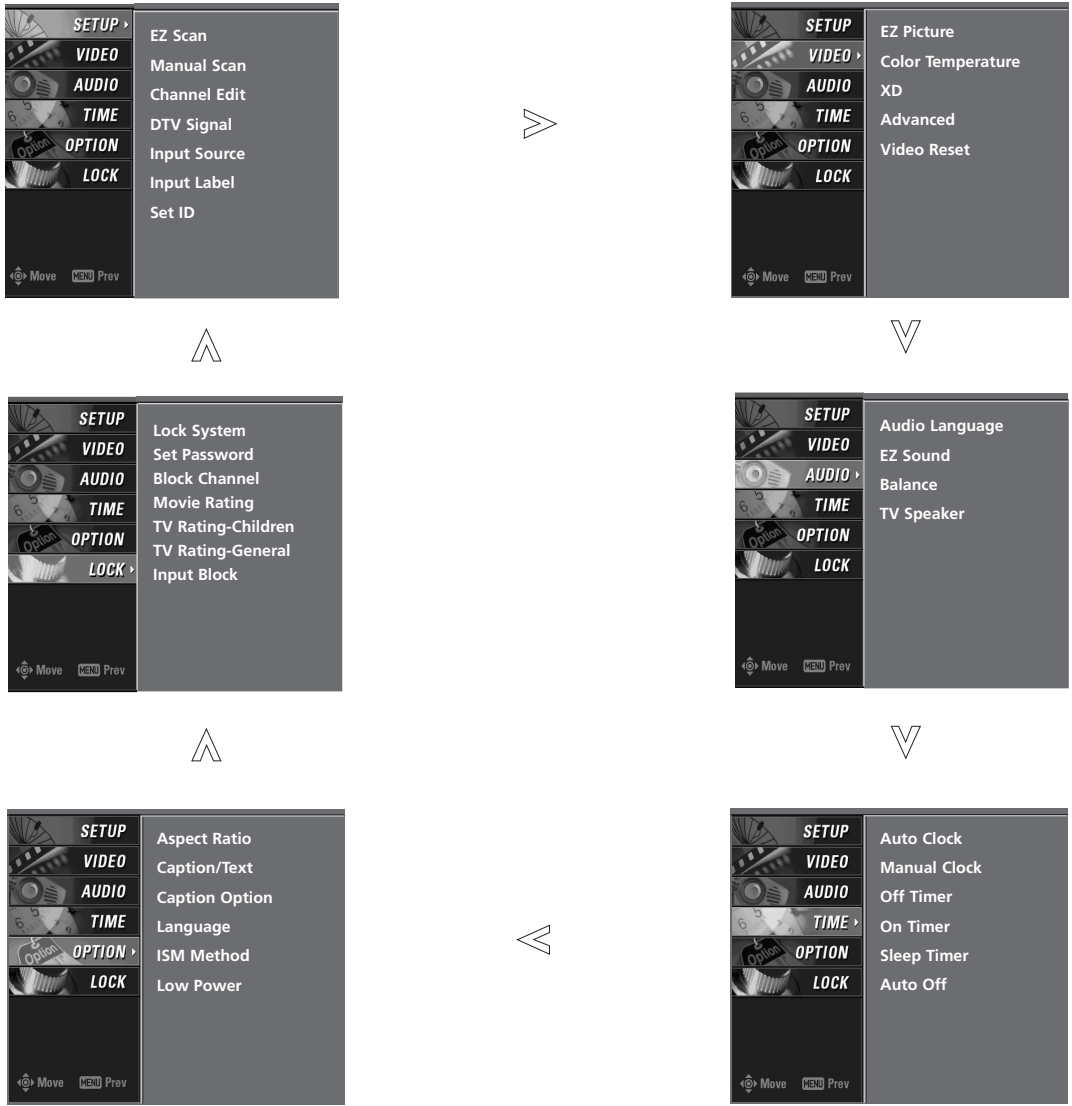

• Your TV's OSD (On Screen Display) may differ slightly from what is shown in this manual.

Setup Menu Options

EZ Scan (Channel Search)

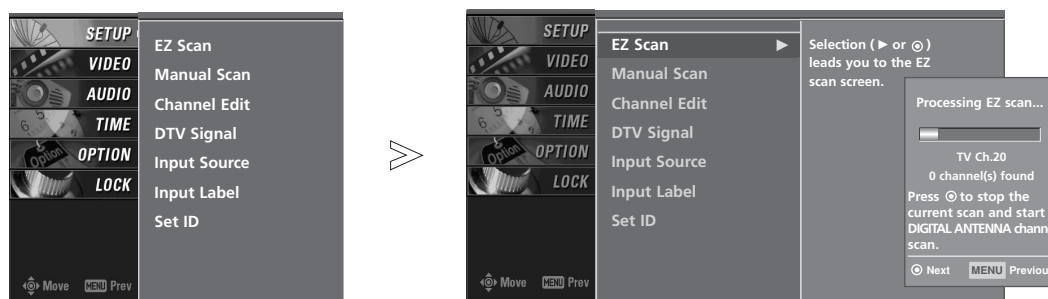

- Automatically finds all channels available through antenna or cable inputs, and stores them in memory on the channel list.
- Run EZ Scan again after any Antenna/Cable connection changes.
- A password is required to gain access to EZ Scan menu if the Lock System is turned on.

- 1 Press the **MENU** button and then use **▲** / **▼** button to select the **SETUP** menu.
- 2 Press the **▶** button and then use **▲** / **▼** button to select **EZ Scan**.
- 3 Press the **ENTER** button to begin the channel search. Allow EZ Scan to complete the channel search cycle for ANTENNA, and CABLE.

Manual Scan



- A password is required to gain access to Manual Scan menu if the Lock System is turned on.

- 1 Press the **MENU** button and then use **▲** / **▼** button to select the **SETUP** menu.
- 2 Press the **▶** button and then use **▲** / **▼** button to select **Manual Scan**.
- 3 Press the **▶** button and then use **▲** / **▼** button to select TV, DTV, CATV, and CADTV.
- 4 Press the **▶** button and then use **▲** / **▼** button to select channel number you want to add or delete.
- 5 Press the **ENTER** button to add or delete for the channel number.
- 6 Press **EXIT** button to return to TV viewing or press **MENU** button to return to the previous menu.

Channel Edit

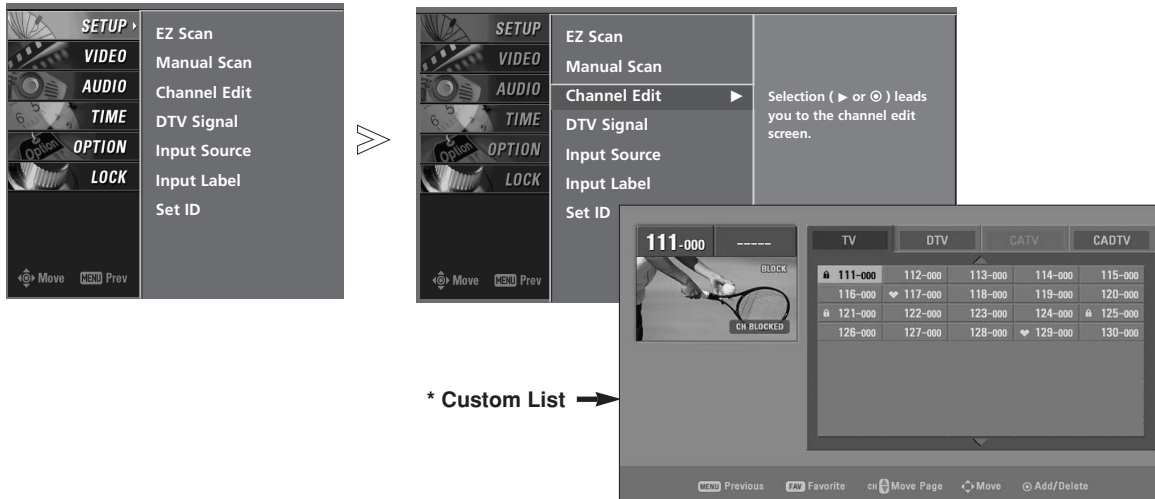

- There are two different ways in order to add or delete scanned channels. One is "Custom List" and the other is "Favorite List" in the channel list. Both of them are available after **EZ Scan** on the **SETUP** menu.

- A Custom List can be created by toggling each channel on or off with **ENTER** button. The channels in the Custom List are displayed in black color, and the channels deleted from the Custom List are displayed in gray color. Once a channel is highlighted you can add or delete the channel by referring to the small window at the top-left corner of the screen. You can create your own Favorite List. Use the **FAV** button on the remote control when a channel is highlighted and then you can add or delete the channel to/from the Favorite List.

- 1 Press the **MENU** button and then use **▲** / **▼** button to select the **SETUP** menu.
- 2 Press the **▶** button and then use **▲** / **▼** button to select **Channel Edit**.
- 3 Press the **▶** button. You will now see a screen filled with channel numbers and a preview picture.
- 4 Use **▲** / **▼** / **◀** / **▶** button to select a channel and then use the **ENTER** button to add or delete it. Press **FAV** button to add the channel to the Favorite List. The heart-mark will appear in front of that channel number.
- 5 Press **EXIT** button to return to TV viewing or press **MENU** button to return to the previous menu.

Setup Menu Options continued

DTV Signal Strength

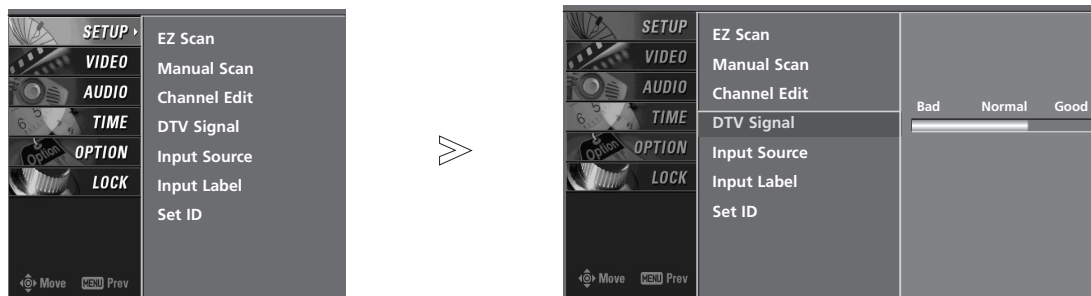

- Shows how strong your DTV signal is and whether you need to adjust your antenna or digital cable input. The higher the signal strength, the less likely you are to experience picture degradation.

- DTV Signals: Only when the input signal is DTV or CADTV, this function is available.

- 1 Press the **MENU** button and then use **▲** / **▼** button to select the **SETUP** menu.
- 2 Press the **▶** button and then use **▲** / **▼** button to select **DTV Signal**.
- 3 View the on-screen signal strength monitor to see the quality of the signal being received.
- 4 Press **EXIT** button to return to TV viewing or press **MENU** button to return to the previous menu.

Input Source



- Changes the picture source so you can watch your TV, cable TV, VCR, DVD, or any other devices that are connected to your TV.

- 1 Press the **MENU** button and then use **▲** / **▼** button to select the **SETUP** menu.
- 2 Press the **▶** button and then use **▲** / **▼** button to select **Input Source**.
- 3 Press the **▶** button and then use **▲** / **▼** button to select the source: TV, AV1, AV2, Component1, Component2, RGB-PC, HDMI1/DVI, or HDMI2.
- 4 Press **EXIT** button to return to TV viewing or press **MENU** button to return to the previous menu.

Input Label



- Sets a label to each input source or lets you skip the input source which is not in use when you press **INPUT** button.

- 1** Press the **MENU** button and then use **▲ / ▼** button to select the **SETUP** menu.
- 2** Press the **▶** button and then use **▲ / ▼** button to select **Input Label**.
- 3** Press the **▶** button and then use **▲ / ▼** button to select the source: AV1-2, Component1-2, RGB-PC, HDMI1/DVI or HDMI2.
- 4** Press the **◀ / ▶** button to select the label.
- 5** Press **EXIT** button to return to TV viewing or press **MENU** button to return to the previous menu.

Video Menu Options

Auto Picture Control (EZ Picture)

- EZ Picture adjusts the TV for the best picture appearance. Select the preset value in the EZ Picture menu based on the program category.
 - **Daylight, Normal, Night Time** settings are preset for optimum picture quality at the factory and are not adjustable.
 - In the **User 1**, and **User 2** modes only, user can directly adjust the contrast, brightness, color, sharpness, tint.
- 1** Press the **EZ PIC** button repeatedly to select the picture appearance setup option as shown below:
 - Daylight, Normal, Night Time, User 1** and **User 2**(your own settings).
 - You can also use the **VIDEO** menu to adjust **EZ Picture**.
 - 2** Press the **EXIT** button to save and return to TV viewing .

Color Temperature Control

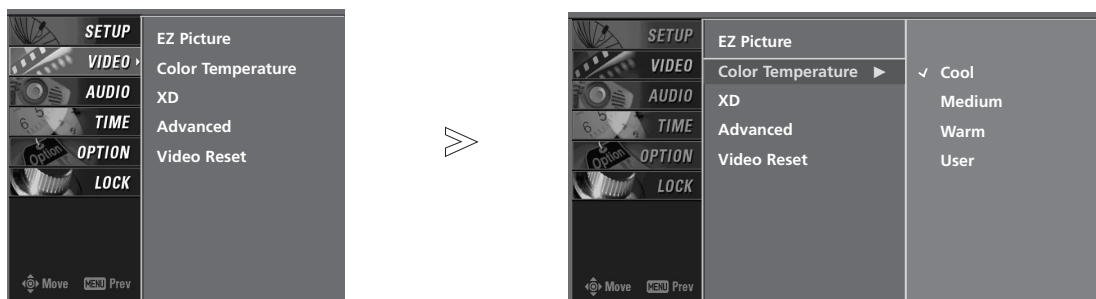

- Choose one of three automatic color adjustments. Set to warm to enhance hotter colors such as red, or set to cool to see less intense colors with more blue.

- 1** Press the **MENU** button and then use **▲ / ▼** button to select the **VIDEO** menu.
- 2** Press the **▶** button and then use **▲ / ▼** button to select **Color Temperature**.
- 3** Press the **▶** button and then use **▲ / ▼** button to select either **Cool, Medium, Warm, or User**.
- 4** Press **EXIT** button to return to TV viewing or press **MENU** button to return to the previous menu.

Manual Color Temperature Control

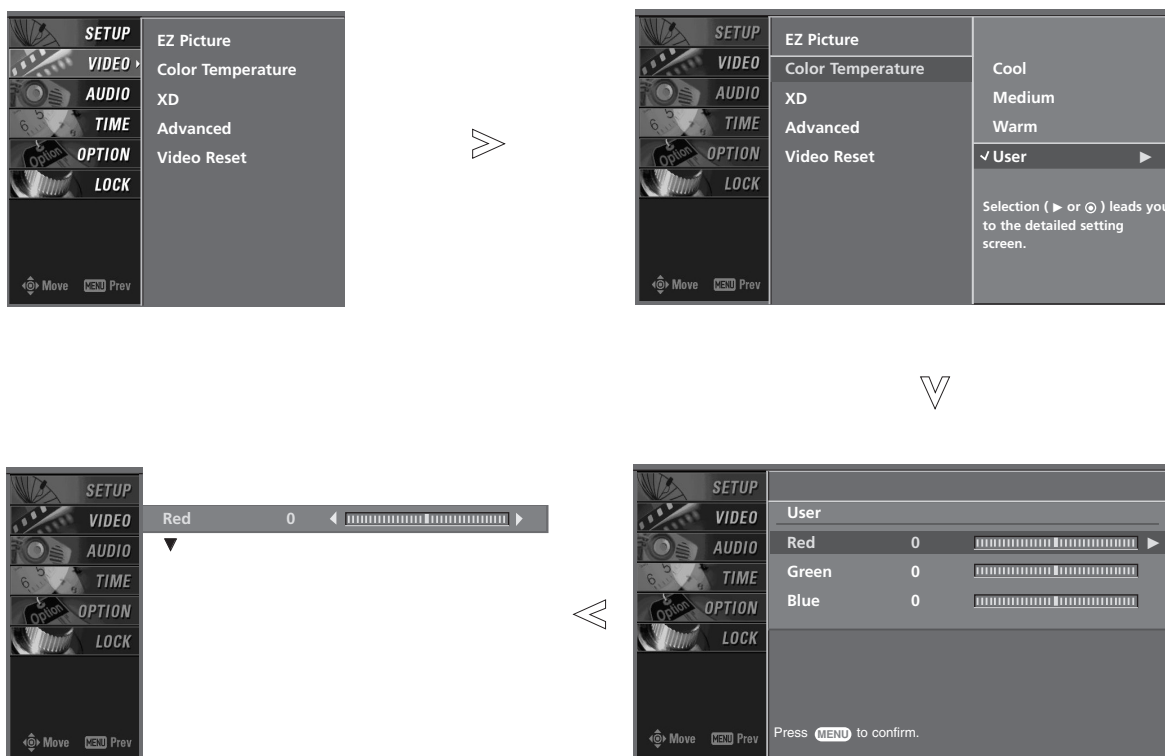

- You can also adjust the detailed settings (Red, Green, Blue) by selecting the **User** menu.

- 1 Press the **MENU** button and then use **▲** / **▼** button to select the **VIDEO** menu.
- 2 Press the **▶** button and then use **▲** / **▼** button to select **Color Temperature**.
- 3 Press the **▶** button and then use **▲** / **▼** button to select **User**.
- 4 Press the **▶** button and then use **▲** / **▼** button to select **Red**, **Green** or **Blue**.
- 5 Press the **▶** button and then use **◀** / **▶** button to make appropriate adjustments.
 - The adjustment range of **Red**, **Green** or **Blue** is -20~ +20.
- 6 Press **EXIT** button to return to TV viewing or press **MENU** button to return to the previous menu.

XD



- XD is LG Electronic's unique picture improving technology to display a real HD source through an advanced dig-ital signal processing algorithm.
- When selecting EZ Picture options (Daylight, Normal and Night time), XD is automatically change to Auto.
- When selecting EZ Picture options (User 1 and User 2), you can choose the Auto / Manual and when selecting Manual, you can adjust the XD Contrast, XD color and XD Noise.

- 1 Press the **MENU** button and then use **▲ / ▼** button to select the **VIDEO** menu.
- 2 Press the **▶** button and then use **▲ / ▼** button to select **XD**.
- 3 Press the **▶** button and then use **▲ / ▼** button to select **Auto** or **Manual**.

* Selecting the Manual

1. Press the **▶** button and then use **◀ / ▶** button to select **XD Contrast, XD Color** or **XD Noise**.

XD Contrast :Optimizing the contrast automatically according to the brightness of the reflection.

XD Color :Adjusting the colors of the reflection automatically to reproduce as closely as possible to the natural colors.

XD Noise :Removing the noise up to the point where it does not damage the original picture.

2. Use the **▲ / ▼** button to make appropriate adjustments.

- 4 Press **EXIT** button to return to TV viewing or press **MENU** button to return to the previous menu.

Advanced-Cinema 3:2 Mode / Black Level

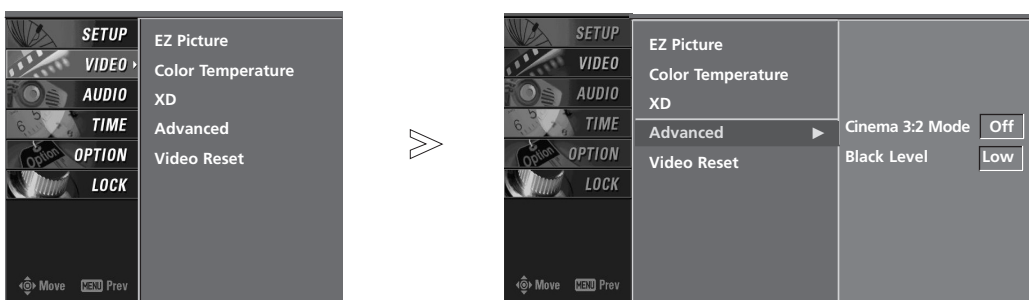

• Cinema 3:2 Mode

- Set up the TV for the best picture appearance for viewing movies. When you operate Cinema (3:2 Pull-Down Mode or Cinema Correction Mode), the TV will adjust 24 fps video from movies to 30 fps video for display (This function is only available in Analog, AV1, AV2, Component 480i mode.)

• Black level

- Adjusting the contrast and the brightness of the screen using the black level of the screen. This feature operates only in HDMI1/DVI, HDMI2 or AV1, AV2 mode.

- 1 Press the **MENU** button and then use **▲ / ▼** button to select the **VIDEO** menu.
- 2 Press the **▶** button and then use **▲ / ▼** button to select **Advanced**.
- 3 Press the **▶** button and then use **▲ / ▼** button to select **Cinema 3:2 Mode** or **Black Level**.

* Selecting the **Cinema 3:2 Mode**

- 4 Press the **▶** button and then use **▲ / ▼** button to select **On** or **Off**.

* Selecting the **Black Level**

- Press the **▶** button and then use **▲ / ▼** button to select **Low** or **High**.

Low

The reflection of the screen gets darker.

High

The reflection of the screen gets brighter.

- 5 Press **EXIT** button to return to TV viewing or press **MENU** button to return to the previous menu.

Video Reset

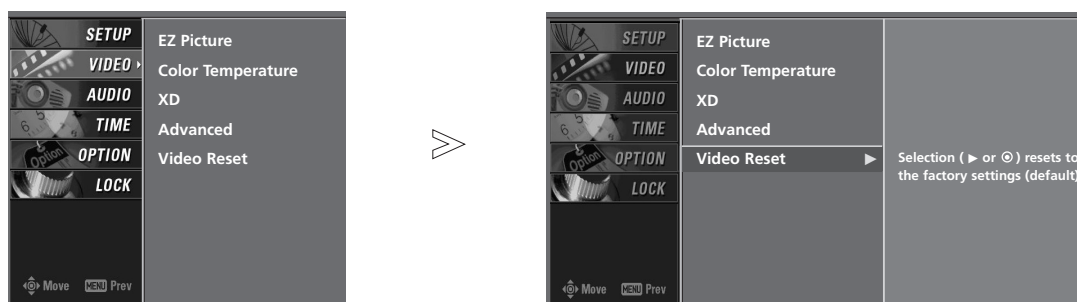

- Use to quickly reset all the Video menu options to their original factory preset values.

- 1** Press the **MENU** button and then use ▲ / ▼ button to select the **VIDEO** menu.
- 2** Press the ▶ button and then use ▲ / ▼ button to select **Video Reset**.
- 3** Press the ▶ button to reset the Video menu options to original values.

Audio Menu Options

Audio Language



- Other languages may be available if a digital signal is provided by the broadcasting station.

- 1 Press the **MENU** button and then use ▲ / ▼ button to select the **AUDIO** menu.
- 2 Press the ► button and then use ▲ / ▼ button to select **Audio Language**.
- 3 Press the ► button and then use ▲ / ▼ button to select: English, Spanish, or French.
- 4 Press **EXIT** button to return to TV viewing or press **MENU** button to return to the previous menu.

Auto Sound Control (EZ Sound)

- EZ Sound lets you enjoy the best sound without any special adjustment because the TV sets the appropriate sound options based on the program content.
 - Normal, Stadium, News, Music and Theater are preset for good sound quality at the factory and are not adjustable.
 - When you select the **Stadium** or **Theater**, the **AUDIO** menu-**Balance** option is disabled and the **Balance** option is set to 0 automatically. When **SRS** is **On**, the **Balance** option is set to 0 automatically. And when you change the other modes, the balance is restored to the original value set the user.
- 1** Press the **EZ SOUND** button repeatedly to select the appropriate sound setup as shown below :
Normal, Stadium, News, Music, Theater and **User** (your own settings) .
 - You can also adjust **EZ Sound** in the **AUDIO** menu.
 - 2** Press EXIT button to save and return to TV viewing.

Manual Sound Control (EZ Sound-User option)

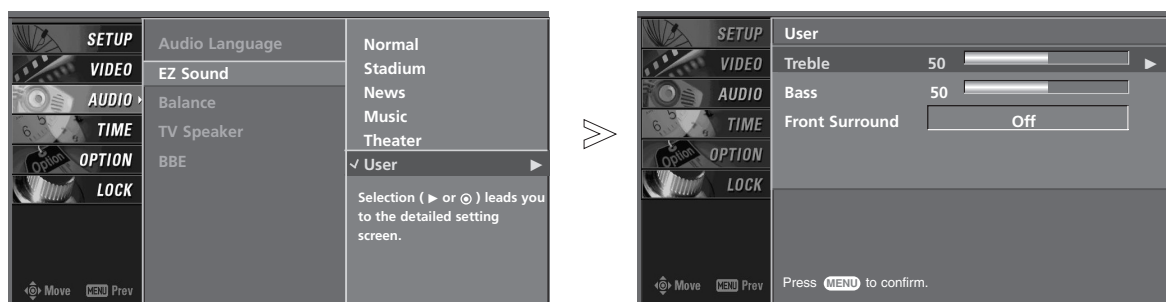

- *Adjust the sound in your preference and surrounded environment.*
- 1** Press the **MENU** button and then use **▲ / ▼** button to select the **AUDIO** menu.
 - 2** Press the **▶** button and then use **▲ / ▼** button to select **EZ Sound**.
 - 3** Press the **▶** button and then use **▲ / ▼** button to select **User**.
 - 4** Press the **▶** button and then use **▲ / ▼** button to select the desired sound option (**Treble**, **Bass** or **Front Surround**).
 - 5** Press the **▶** button and then use **◀ / ▶** button to make appropriate adjustments.

*** Selecting the Front Surround**

Press the ► button and then use ◀ / ▶ button to select **Off** or **SRS** (Sound Retrieval System) **TruSurround XT** .

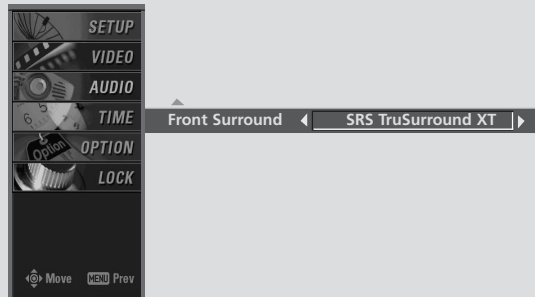

Note: When **SRS** (Sound Retrieval System) **TruSurround XT** is selected, Audio Balance function is disable and set to 0 .

When **Off** is selected, Audio Balance function is enable and reset the balance as previous.

- 6** Press **EXIT** button to return to TV viewing or press **MENU** button to return to the previous menu.

SRS TruSurround XT

Takes advantage of any multi-channel format without needing to add extra speakers or equipment. Dialog clarity, bass enrichment, and the addition of stereo audio enhancement produces an immersive sound experience from standard stereo material.

Balance

- Adjust the sound in your preference and surrounded environment.



- 1 Press the **MENU** button and then use ▲ / ▼ button to select the **AUDIO** menu.
- 2 Press the ► button and then use ▲ / ▼ button to select **Balance**.
- 3 Press the ► button and then use ◀ / ▶ button to make appropriate adjustments.
- 4 Press **EXIT** button to return to TV viewing or press **MENU** button to return to the previous menu.

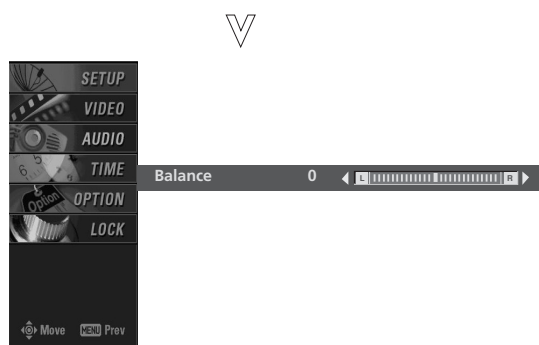

TV Speakers On/Off Setup

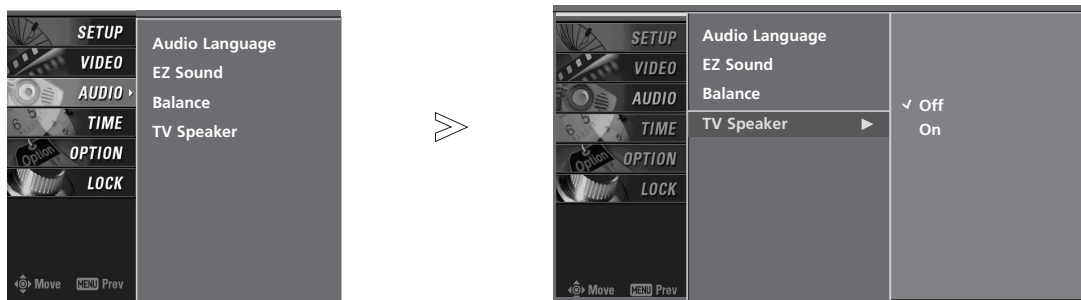

- Turn TV speakers off if using external audio equipment. Feature turns the TV Speakers option On or Off.

- 1 Press the **MENU** button and then use ▲ / ▼ button to select the **AUDIO** menu.
- 2 Press the ► button and then use ▲ / ▼ button to select **TV Speaker**.
- 3 Press the ► button and then use ▲ / ▼ button to select **Off** or **On**.
- 4 Press **EXIT** button to return to TV viewing or press **MENU** button to return to the previous menu.

Time Menu Options

Manual Clock Setup

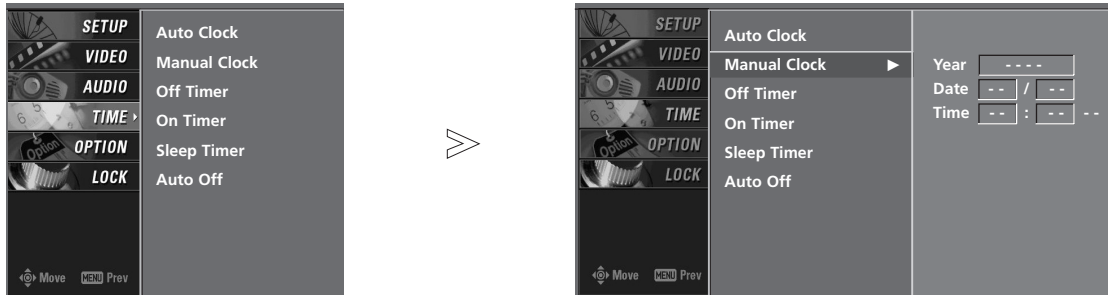

- If current time setting is wrong, reset the clock manually.

- 1 Press the **MENU** button and then use **▲ / ▼** button to select the **TIME** menu.
- 2 Press the **▶** button and then use **▲ / ▼** button to select **Manual Clock**.
- 3 Press the **▶** button and then use **◀ / ▶** button to select either the year, date, or time option. Once selected, use the **▲ / ▼** button to set the year, date, and time options.
- 4 Press **EXIT** button to return to TV viewing or press **MENU** button to return to the previous menu.

Auto Clock Setup

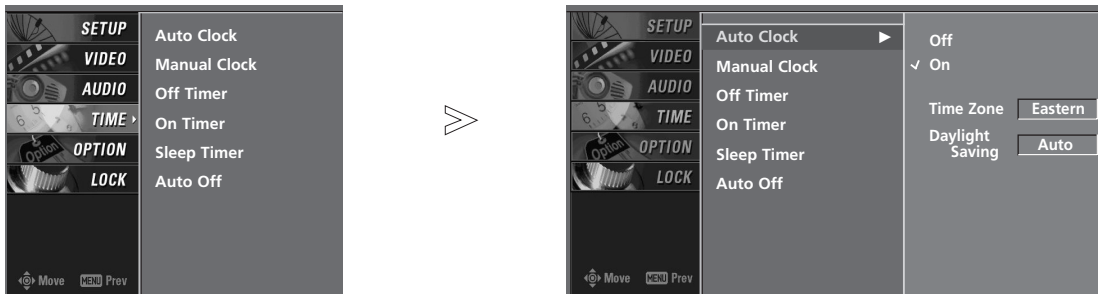

- The current time will be set automatically from a digital channel signal provided by the broadcasting station.
- Set the clock manually, if the current time is set incorrectly by the auto clock function.
- The factory default value of the **Auto Clock** is **Off**, because a clock information sent each broadcasting station is different.

- 1 Press the **MENU** button and then use **▲ / ▼** button to select the **TIME** menu.
- 2 Press the **▶** button and then use **▲ / ▼** button to select **Auto Clock**.
- 3 Press the **▶** button and then use **▲ / ▼** button to select **On**.
- 4 Press the **▶** button and then use **▲ / ▼** button to select your viewing area time zone.
 - U.S.A: **Eastern, Central, Mountain, Pacific, Alaska, or Hawaii.**
 - Canada: **Eastern, Central, Mountain, Pacific, New Fland, or Atlantic.**
- 5 Press the **▶** button and then use **▲ / ▼** button to select **Auto, Off, On**, depending on whether or not your viewing area observes Daylight Saving time.
- 6 Press **EXIT** button to return to TV viewing or press **MENU** button to return to the previous menu.

On/Off Timer Setup



- Timer function operates only if current time has been set.
- Off-Timer function overrides On-Timer function if they are set both set to the same time.
- The TV must be in standby mode for the On-Timer to work.
- If you do not press any button within 2 hours after the TV turns on with the On Timer function, the TV will automatically revert to standby mode.

- 1 Press the **MENU** button and then use ▲ / ▼ button to select the **TIME** menu.
- 2 Press the ► button and then use ▲ / ▼ button to select **Off Timer** or **On Timer**.
- 3 Press the ► button and then use ▲ / ▼ button to select **On**.
 - To cancel **On/Off Timer** function, select **Off**.
- 4 Press the ► button and then use ▲ / ▼ button to set the hour.
- 5 Press the ► button and then use ▲ / ▼ button to set the minutes.
- 6 **For only On Timer function**
 Press the ► button and then use ▲ / ▼ button to select the channel at turn-on.
 Press the ► button and then use ▲ / ▼ button to set the sound level at turn-on.
- 7 Press **EXIT** button to return to TV viewing or press **MENU** button to return to the previous menu.

Sleep Timer

- The Sleep Timer turns the TV off at the preset time. Note that this setting is cleared when the TV is turned off.
- You can also set up the **Sleep Timer** in the **TIME** menu.

- 1 Press the **TIMER** button repeatedly to select the number of minutes. First the **Off** option appears on the screen, followed by the following sleep timer options: 10, 20, 30, 60, 90, 120, 180, and 240 minutes.
- 2 When the number of minutes you want is displayed on the screen, press the **TIMER** button. The timer begins to count down from the number of minutes selected.
- 3 To check the remaining minutes before the TV turns off, press the **TIMER** button once.
- 4 To cancel the Sleep Timer, press the **TIMER** button repeatedly to select **Off**.

Time Menu Options continued

Auto Off

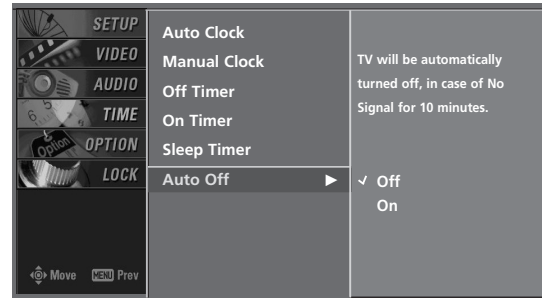

- If the TV is on and there is no input signal, the TV turns off automatically after 10 minutes.

- 1** Press the **MENU** button and then use **▲ / ▼** button to select the **TIME** menu.
- 2** Press the **▶** button and then use **▲ / ▼** button to select **Auto Off**.
- 3** Press the **▶** button and then use **▲ / ▼** button to select **Off** or **On**.
- 4** Press **EXIT** button to return to TV viewing or press **MENU** button to return to the previous menu.

Option Menu Features

Aspect Ratio Control

Set by program

Selects the proper picture proportion to match the source's image.

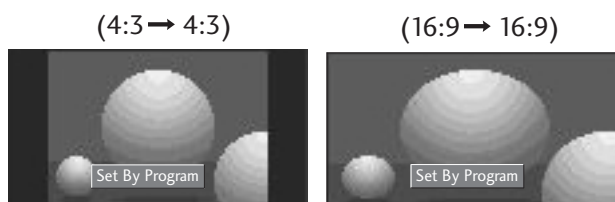

4:3

Choose 4:3 when you want to view a picture with an original 4:3 aspect ratio.



16:9

Adjust the picture horizontally, in a linear proportion to fill the entire screen.



- This feature allow an analog picture with 4:3 aspect ratio to be displayed in a different proportion. When 4:3 analog signal is received on the 16:9 TV, personally preferred aspect ratio needs to be specified.
- RGB-PC/DVI-PC input source use 4:3 or 16:9 aspect ratio.

Horizon

The screen size is, more enlarged at both sides, to create a spectacular view.

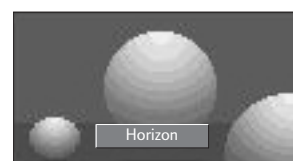

Zoom 1

Choose Zoom 1 when you want to view the picture without any alteration. However, the top and bottom portions of the picture will be cropped.

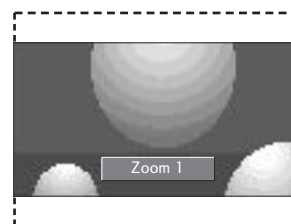

Zoom 2

Choose Zoom 2 when you want the picture to be altered, both vertically extended and cropped. The picture taking a halfway trade off between alteration and screen coverage.

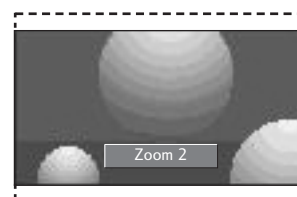

1 Press the **RATIO** button repeatedly to select the desired picture format.

- You can also adjust the **Aspect Ratio** in the **OPTION** menu.

Option Menu Features continued

Caption/Text

* Analog Broadcasting System Captions

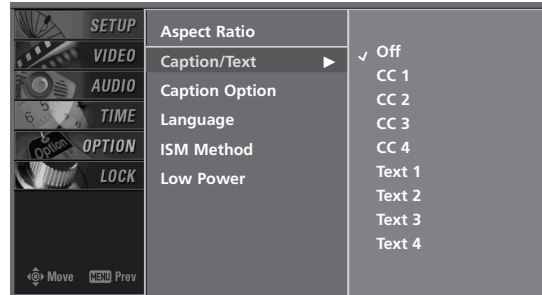
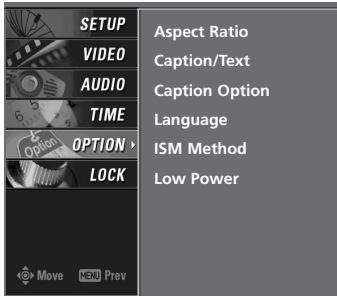

- Select a caption mode for displaying captioning information if provided on a program.
- Analog caption displays information at any position on the screen.
- Text displays information, usually at the bottom position and is used for a data service.
- Caption/Text, if provided by the broadcaster, would be available for both digital and analog channels on the Antenna/Cable.
- This TV is programmed to remember the caption/text mode it was last set to, when you turn the power off.
- When you select the **CC1-Text4**, Caption Option must be disabled.

- 1 Use the **CC** button repeatedly to select Caption **Off**, **CC1**, **CC2**, **CC3**, **CC4**, **Text1**, **Text2**, **Text3**, or **Text4**.
- 2 Press **EXIT** button to save and return to TV viewing.

- 1 Press the **MENU** button and then use **▲ / ▼** button to select the **OPTION** menu.
- 2 Press the **▶** button and then use **▲ / ▼** button to select **Caption/Text**.
- 3 Press the **▶** button and then use **▲ / ▼** button to select caption: **CC1**, **CC2**, **CC3**, **CC4**, **Text1**, **Text2**, **Text3**, or **Text4**.
 - **CAPTION**
The term for the words that scroll across the bottom of the TV screen.
 - **TEXT**
The term for the words that appear in a large black frame and almost cover the entire screen; usually messages provided by the broadcaster.
- 4 Press **EXIT** button to return to TV viewing or press **MENU** button to return to the previous menu.

* Digital Broadcasting System Captions

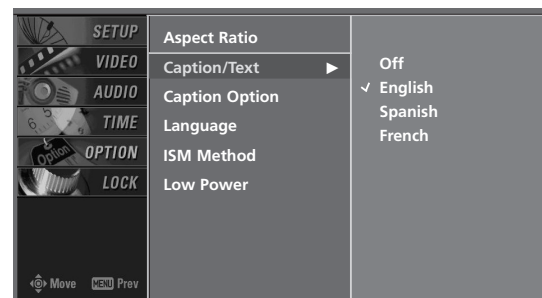
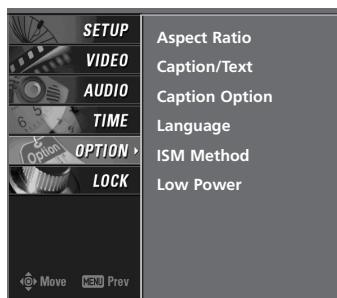

- Choose the language you want the DTV/CADTV Captions to appear in.
- Other languages can be chosen for digital sources only if they are included on the program.
- Caption may not be available depends if the service is not provided by the digital broadcaster.

- 1 Press the **MENU** button and then use **▲ / ▼** button to select the **OPTION** menu.
- 2 Press the **▶** button and then use **▲ / ▼** button to select **Caption/Text**.
- 3 Press the **▶** button and then use **▲ / ▼** button to select available caption languages: **English**, **Spanish**, or **French**.
- 4 Press **EXIT** button to return to TV viewing or press **MENU** button to return to the previous menu.

Caption Option

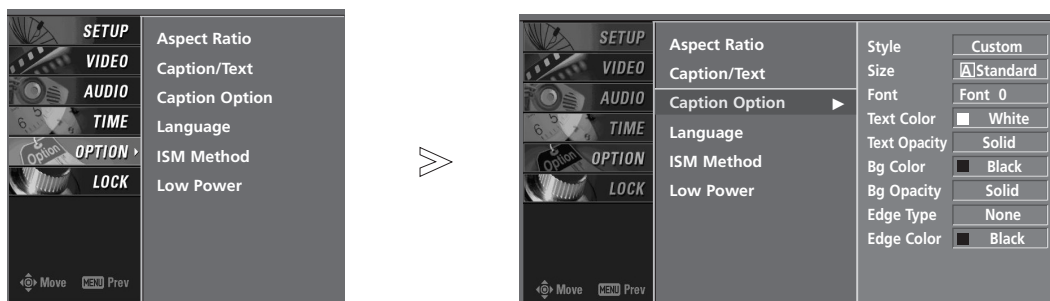

- Customize the DTV/CADTV captions that appear on your screen.

- 1 Press the **MENU** button and then use **▲** / **▼** button to select the **OPTION** menu.
- 2 Press the **▶** button and then use **▲** / **▼** button to select **Caption Option**.
- 3 Press the **▶** button and then use **◀** / **▶** button to select **Custom**.
- 4 Use **▲** / **▼** button to customize the Style, Font, etc., to your preference. A preview icon is provided at the bottom of the screen, use it to see the caption language.
 - **Size**: Set the size the words will appear in.
 - **Font**: Select a typeface for the words.
 - **Text Color**: Choose a color for the text.
 - **Text Opacity**: Specify the opacity for the text color.
 - **Bg (Background) Color**: Select a background color.
 - **Bg (Background) Opacity**: Select the opacity for the background color.
 - **Edge Type**: Select an edge type.
 - **Edge Color**: Select a color for the edges.
- 5 Press **EXIT** button to return to TV viewing or press **MENU** button to return to the previous menu.

Low Power (42PC3D/3DV, 50PC3D, 60PC1D only)

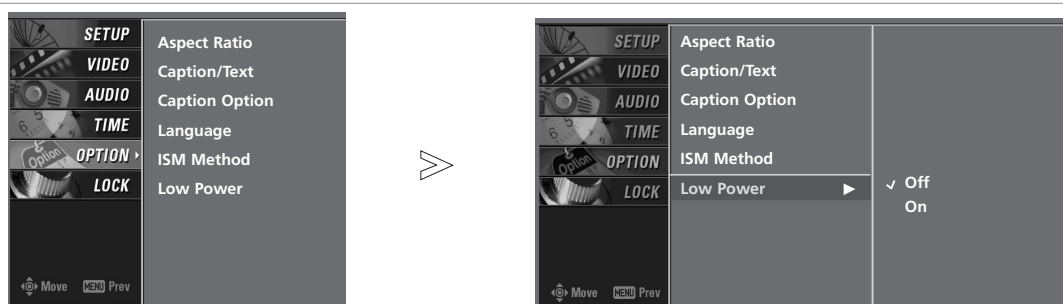

- Low power reduces the power consumption of plasma display.

- 1 Press the **MENU** button and then use **▲** / **▼** button to select the **OPTION** menu.
- 2 Press the **▶** button and then use **▲** / **▼** button to select **Low Power**.
- 3 Press the **▶** button and then use **▲** / **▼** button **On** or **Off**.
- 4 Press **EXIT** button to return to TV viewing or press **MENU** button to return to the previous menu.

Option Menu Features continued

ISM (Image Sticking Minimization) Method (42PC3D/3DV, 50PC3D, 60PC1D only)

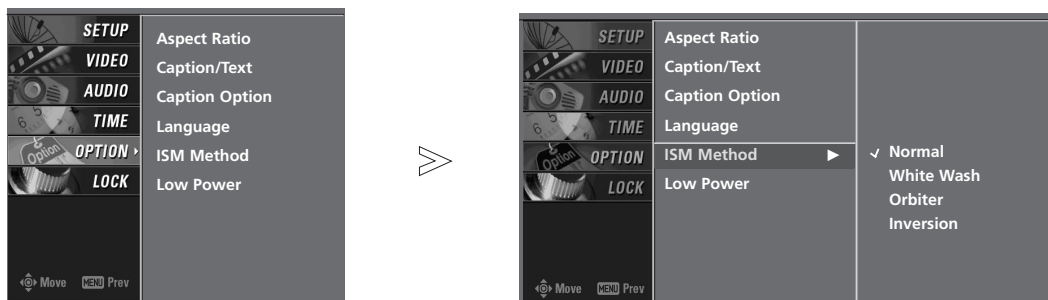

- A frozen still picture from a PC/video game displayed on the screen for prolonged periods will result in a ghost image ; even though the image is changed. Use our unique method to minimize any fixed image on the screen.

- 1 Press the **MENU** button and then use ▲ / ▼ button to select the **OPTION** menu.
- 2 Press the ► button and then use ▲ / ▼ button to select **ISM Method**.
- 3 Press the ► button and then use ▲ / ▼ button to select **Normal**, **White Wash**, **Orbiter** or **Inversion**.
 - **Normal**
If image sticking is never a problem, ISM is not necessary - set to Normal.
 - **White Wash**
White Wash removes permanent images from the screen.
Note: An excessive permanent image may be impossible to clear entirely with White Wash. To return to normal viewing, press the any button.
 - **Orbiter**
Orbiter may help prevent ghost images. However, it is best not to allow any fixed image to remain on the screen. To avoid a permanent image on the screen, the image will move once per 2 minutes: Left → Right → Upside → Downside → Right → Left → Downside → Upside.
 - **Inversion**
Inversion will automatically invert the plasma display panel color every 30 minutes.
- 4 Press **EXIT** button to return to TV viewing or press **MENU** button to return to the previous menu.

Lock Menu Options

Parental Control can be used to block specific channels, ratings and other viewing sources.

The Parental Control Function (V-Chip) is used to block program viewing based on the ratings sent by the broadcasting station. The default setting is to allow all programs to be viewed. Viewing can be blocked by the type of program and by the categories chosen to be blocked. It is also possible to block all program viewing for a time period. To use this function, the following must be done :

1. Set ratings and categories to be blocked.
2. Specify a password
3. Enable the lock

V-Chip rating and categories

Rating guidelines are provided by broadcasting stations. Most television programs and television movies can be blocked by TV Rating and/or Individual Categories. Movies that have been shown at the theaters or direct-to-video movies use the Movie Rating System (MPAA) only.

For USA

Ratings for Movies previously shown in theaters:

Movie Ratings :

- Blocking Off (Permits all programs)
- G (General audience)
- PG (Parental guidance suggested)
- PG-13 (Parents strongly cautioned)
- R (Restricted)
- NC-17 (No one 17 and under admitted)
- X (Adult only)

If you set PG-13 : G and PG movies will be available, PG-13, R, NC-17 and X will be blocked.

Ratings for Television programs including made-for-TV movies :

- TV-G (General audience)
- TV-PG (Parental guidance suggested)
- TV-14 (Parents strongly cautioned)
- TV-MA (Mature audience only)
- TV-Y (All children)
- TV-Y7 (Children 7 years and older)

TV Rating-Children:

- Age (applies to TV-Y, TV-Y7)
- Fantasy Violence (applies to TV-Y7)

TV Rating-General:

- Age (applies to TV-G, TV-PG, TV-14, TV-MA)
- Dialogue- sexual dialogue (applies to TV-PG, TV-14)
- Language- adult language (applies to TV-PG, TV-14, TV-MA)
- Sex- sexual situations (applies to TV-PG, TV-14, TV-MA)
- Violence (applies to TV-PG, TV-14, TV-MA)

Input Block

- AV1, 2 (On, Off)
- Component 1, 2 (On, Off)
- RGB-PC, HDMI1/DVI and HDMI2 (On, Off)

For Canada

TV Rating-English:

- E (Exempt)
- C (Children)
- C8+ (8 years and up)
- G (General programming. Suitable for all audiences)
- PG (Parental guidance suggested)
- 14+ (Viewers 14 years and up)
- 18+ (Adult programming)
- Blocking off (Permits all programming)

TV Rating-French:

- E (Exempt)
- G (General)
- 8 ans+ (8 years and up)
- 13 ans+ (13 years and up)
- 16 ans+ (16 years and up)
- 18 ans+ (Adults only)
- Blocking off (Permits all programming)

Input Block

- AV 1, 2 (On, Off)
- Component 1, 2 (On, Off)
- RGB-PC, HDMI1/DVI and HDMI2 (On, Off)

Parental Lock Setup

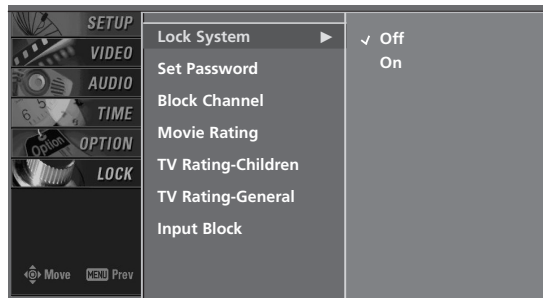
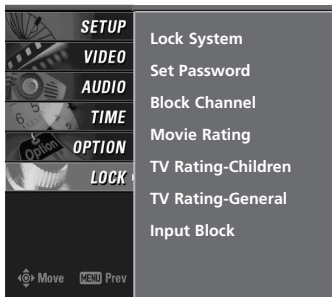

- Set up blocking schemes to block specific channels, ratings, and external viewing sources.
- A password is required to gain access to this menu if the Lock System is turned on.

- 1 Press the **MENU** button and then use **▲ / ▼** button to select the **LOCK** menu. Then, press the **▶** button
 - If **Lock** is already set, enter the password as requested.
 - The TV is set up with the initial password "0-0-0-0".
- 2 Use the **▲ / ▼** button to choose from the following Lock Menu options. Once the option is selected, change the settings to your preference.
 - **Lock System:** Activates or disables the blocking scheme you set up previously.
 - **Set Password:** Change the password by inputting a new password twice.
 - **Block Channel:** Select a channel number that you wish to block.
 - **Input block:** Enables you to select a source to block from the external source devices you have hooked up.

◆ For USA

- **Movie Rating (MPPA):** Blocks movies according to the movie ratings limits specified, so children cannot view certain movies. You can set the ratings limit by blocking out all the movies with the ratings above a specified level. Keep in mind that the movie ratings limit only applies to movies shown on TV, not TV programs, such as soap operas.
- **TV Rating-Children:** Prevents children from watching certain children's TV programs, according to the ratings limit set. The children rating does not apply to other TV programs. Unless you block certain TV programs intended for mature audiences in the TV Rating - sub menu, your children can view those programs.
- **TV Rating-General:** Based on the ratings, blocks certain TV programs that you and your family do not want to view.

◆ For Canada

- **TV Rating-English / TV Rating-French:** Selecting canadian English /French language rating system.

- 3 Press **EXIT** button to return to TV viewing or press **MENU** button to return to the previous menu.



- If you ever forget your password, key in '7', '7', '7', '7' on the remote control.

External Control Device Setup

- Connect the RS-232C input jack to an external control device (such as a computer or an A/V control system) and control the Monitor's functions externally.
- Connect the serial port of the control device to the RS-232C jack on the TV back panel.
- RS-232C connection cables are not supplied with the TV.

RS-232C Setup

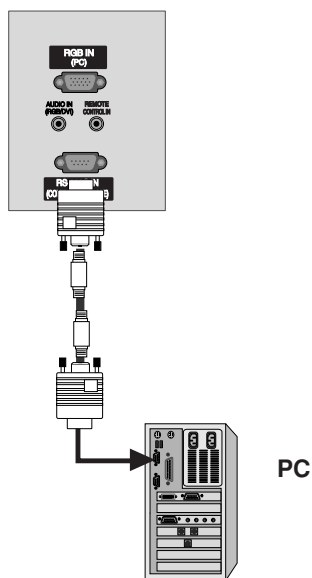

Type of Connector; D-Sub 9-Pin Male

| No. | Pin Name |
|-----|----------------------|
| 1 | No connection |
| 2 | RXD (Receive data) |
| 3 | TXD (Transmit data) |
| 4 | DTR (DTE side ready) |
| 5 | GND |
| 6 | DSR (DCE side ready) |
| 7 | RTS (Ready to send) |
| 8 | CTS (Clear to send) |
| 9 | No Connection |

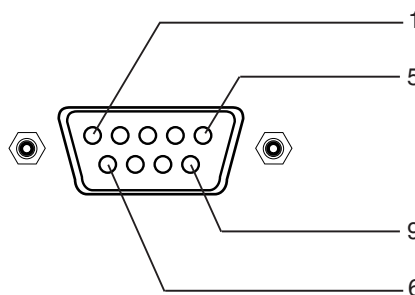

RS-232C Configurations

7-Wire Configurations (Serial female-female NULL modem cable)

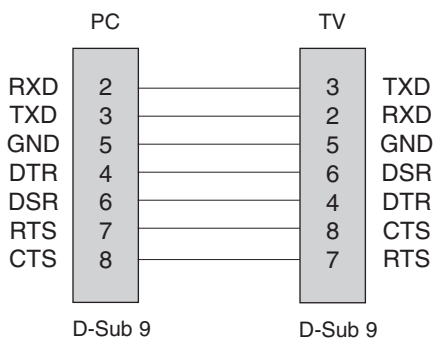

3-Wire Configurations (Not standard)

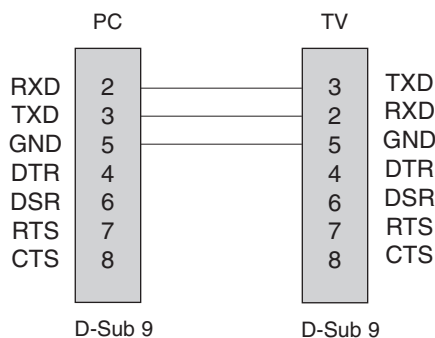

Set ID

- Use this function to specify a TV ID number.
- Refer to 'Real Data Mapping'. See page 55.

1. Press the **MENU** button and then use ▲ / ▼ button to select the **SETUP** menu.
2. Press the ► button and then use ▲ / ▼ button to select **Set ID**.
3. Press the ► button and then use ▲ / ▼ button to adjust **Set ID** to choose the desired TV ID number. The adjustment range of **Set ID** is 1 ~ 99.
4. Press **EXIT** button to return to TV viewing or press **MENU** button to return to the previous menu.

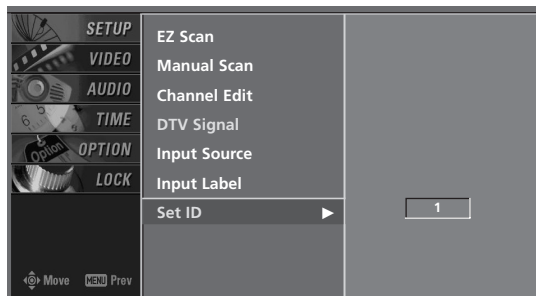

Communication Parameters

- Baud rate : 9600 bps (UART)
- Data length : 8 bits
- Parity : None
- Stop bit : 1 bit
- Communication code : ASCII code

* Use a crossed (reverse) cable.

Command Reference List

| | COMMAND 1 | COMMAND 2 | DATA (Hexadecimal) |
|------------------------------|-----------|-----------|-----------------------|
| 01. Power | k | a | 0 ~ 1 |
| 02. Input Select | k | b | * (Refer to p.55) |
| 03. Aspect Ratio | k | c | * (Refer to p.55) |
| 04. Screen Mute | k | d | 0 ~ 1 |
| 05. Volume Mute | k | e | 0 ~ 1 |
| 06. Volume Control | k | f | 0 ~ 64 |
| 07. Contrast | k | g | 0 ~ 64 |
| 08. Brightness | k | h | 0 ~ 64 |
| 09. Color | k | i | 0 ~ 64 |
| 10. Tint | k | j | 0 ~ 64 |
| 11. Sharpness | k | k | 0 ~ 64 |
| 12. OSD Select | k | l | 0 ~ 1 |
| 13. Remote Control Lock Mode | k | m | 0 ~ 1 |
| 14. Treble | k | r | 0 ~ 64 |
| 15. Bass | k | s | 0 ~ 64 |
| 16. Balance | k | t | 0 ~ 64 |
| 17. Color Temperature | k | u | 0 ~ 3 |
| 18. ISM Method | j | p | * (Refer to p.57) |
| 19. Low Power | j | q | 0 ~ 1 |

Transmission / Receiving Protocol

Transmission

[Command1][Command2][][Set ID][][Data][Cr]

- * [Command 1]: First command to control the set. (j,k,m or x)
- * [Command 2]: Second command to control the set.
- * [Set ID]: You can adjust the set ID to choose desired monitor ID number in Setup menu. Adjustment range is 1 ~ 99. When selecting Set ID '0', every connected the TV is controlled. Set ID is indicated as decimal (1~99) on menu and as Hexa decimal (0x0~0x63) on transmission/receiving protocol.
- * [DATA]: To transmit command data.
Transmit 'FF' data to read status of command.
- * [Cr]: Carriage Return
ASCII code '0x0D'
- * []: ASCII code 'space (0x20)'

OK Acknowledgement

[Command2][][Set ID][][OK][Data][x]

- * The Monitor transmits ACK (acknowledgement) based on this format when receiving normal data. At this time, if the data is data read mode, it indicates present status data. If the data is data write mode, it returns the data of the PC computer.

Error Acknowledgement

[Command2][][Set ID][][NG][Data][x]

- * The Monitor transmits ACK (acknowledgement) based on this format when receiving abnormal data from non-viable functions or communication errors.

- Data 1: Illegal Code
2: Not supported function
3: Wait more time

| | COM-MAND 1 | COM-MAND 2 | DATA 0 (Hexadecimal) | DATA 1 (Hexadecimal) | DATA 2 (Hexadecimal) | DATA 3 (Hexadecimal) | DATA 4 (Hexadecimal) | DATA 5 (Hexadecimal) |
|---------------------|------------|------------|-------------------------|-------------------------|-------------------------|-------------------------|-------------------------|-------------------------|
| 20. Channel Tuning | m | a | physical/program high | major/program low | major low | minor high | minor low | attribute |
| 21. Channel Add/Del | m | b | 00 ~ 01 | | | | | |
| 22. Key | m | c | key code | | | | | |
| 23. Input Select | x | b | * (Refer to p.58) | | | | | |

01. Power (Command2:a)

- ▶ To control Power On/Off of the TV.

Transmission

```
[k][a][ ][Set ID][ ][Data][Cr]
```

Data 0 : Power Off 1 : Power On

Acknowledgement

```
[a][ ][Set ID][ ][OK][Data][x]
```

* In a like manner, if other functions transmit 'FF' data based on this format, Acknowledgement data feedback presents status about each function.

02. Input Select (Command2:b) (Main Picture Input)

- ▶ To select input source for the TV.

Transmission

```
[k][b][ ][Set ID][ ][Data][Cr]
```

| | |
|----------------|----------------|
| Data 0: DTV | 5: Component 2 |
| 1: Analog | 7: RGB-PC |
| 2: AV1 | 8: HDMI1/DVI |
| 3: AV2 | 9: HDMI2 |
| 4: Component 1 | |

```
[b][ ][Set ID][ ][OK][Data][x]
```

Acknowledgement**03. Aspect Ratio (Command2:c) (Main picture format)**

- ▶ To adjust the screen format.
You can also adjust the screen format using the RATIO button on remote control or in the Option menu.

Transmission

```
[k][c][ ][Set ID][ ][Data][Cr]
```

| | |
|-------------|-------------------|
| Date 1: 4:3 | 4: Zoom 1 |
| 2: 16:9 | 5: Zoom 2 |
| 3: Horizon | 6: Set by program |

Acknowledgement

```
[c][ ][Set ID][ ][OK][Data][x]
```

04. Screen Mute (Command2:d)

- ▶ To select screen mute on/off.

Transmission

```
[k][d][ ][Set ID][ ][Data][Cr]
```

Data 0 : Screen mute off (Picture on)
1 : Screen mute on (Picture off)

Acknowledgement

```
[d][ ][Set ID][ ][OK][Data][x]
```

05. Volume Mute (Command2:e)

- ▶ To control volume mute on/off.
You can also adjust mute using the MUTE button on remote control.

Transmission

```
[k][e][ ][Set ID][ ][Data][Cr]
```

Data 0 : Volume mute on (Volume off)
1 : Volume mute off (Volume on)

Acknowledgement

```
[e][ ][Set ID][ ][OK][Data][x]
```

06. Volume Control (Command2:f)

- ▶ To adjust volume.
You can also adjust volume with the volume buttons on remote control.

Transmission

```
[k][f][ ][Set ID][ ][Data][Cr]
```

Data Min : 0 ~ Max : 64

- Refer to 'Real data mapping' as shown below.

Acknowledgement

```
[f][ ][Set ID][ ][OK][Data][x]
```

07. Contrast (Command2:g)

- ▶ To adjust screen contrast.
You can also adjust contrast in the Video menu.

Transmission

```
[k][g][ ][Set ID][ ][Data][Cr]
```

Data Min : 0 ~ Max : 64

- Refer to 'Real data mapping' as shown below.

Acknowledgement

```
[g][ ][Set ID][ ][OK][Data][x]
```

08. Brightness (Command2:h)

- ▶ To adjust screen brightness.
You can also adjust brightness in the Video menu.

Transmission

```
[k][h][ ][Set ID][ ][Data][Cr]
```

Data Min : 0 ~ Max : 64

- Refer to 'Real data mapping' as shown below.

Acknowledgement

```
[h][ ][Set ID][ ][OK][Data][x]
```

* Real data mapping

```
0 : Step 0
⋮
A : Step 10 (SET ID 10)
⋮
F : Step 15 (SET ID 15)
10 : Step 16 (SET ID 16)
⋮
63 : Step 99 (SET ID 99)
64 : Step 100
```

* Tint : R50 ~ G50

* Balance : L50 ~ R50

09. Color (Command2:i)

- ▶ To adjust the screen color.
You can also adjust color in the Video menu.

Transmission

[k][i][][Set ID][][Data][Cr]

Data Min : 0 ~ Max : 64

- Refer to 'Real data mapping'. See page 55.

Acknowledgement

[i][][Set ID][][OK][Data][x]

10. Tint (Command2:j)

- ▶ To adjust the screen tint.
You can also adjust tint in the Video menu.

Transmission

[k][j][][Set ID][][Data][Cr]

Data Red : 0 ~ Green : 64

- Refer to 'Real data mapping'. See page 55.

Acknowledgement

[j][][Set ID][][OK][Data][x]

11. Sharpness (Command2:k)

- ▶ To adjust the screen sharpness.
You can also adjust sharpness in the Video menu.

Transmission

[k][k][][Set ID][][Data][Cr]

Data Min: 0 ~ Max: 64

- Refer to 'Real data mapping'. See page 55.

Acknowledgement

[k][][Set ID][][OK][Data][x]

12. OSD Select (Command2:l)

- ▶ To select OSD (On Screen Display) on/off.

Transmission

[k][l][][Set ID][][Data][Cr]

Data 0: OSD off 1: OSD on

Acknowledgement

[l][][Set ID][][OK][Data][x]

13. Remote Control Lock Mode (Command2:m)

- ▶ To lock the remote control and the front panel controls on the set.

Transmission

[k][m][][Set ID][][Data][Cr]

Data 0: Lock off 1: Lock on

Acknowledgement

[m][][Set ID][][OK][Data][x]

14. Treble (Command2:r)

- ▶ To adjust treble.
You can also adjust treble in the Audio menu.

Transmission

[k][r][][Set ID][][Data][Cr]

Data Min: 0 ~ Max: 64

- Refer to 'Real data mapping'. See page 55.

Acknowledgement

[r][][Set ID][][OK][Data][x]

15. Bass (Command2:s)

- ▶ To adjust bass.
You can also adjust bass in the Audio menu.

Transmission

[k][s][][Set ID][][Data][Cr]

Data Min: 0 ~ Max: 64

- Refer to 'Real data mapping'. See page 55.

Acknowledgement

[s][][Set ID][][OK][Data][x]

16. Balance (Command2:t)

- ▶ To adjust balance.
You can also adjust balance in the Audio menu.

Transmission

[k][t][][Set ID][][Data][Cr]

Data Min: 0 ~ Max: 64

- Refer to 'Real data mapping'. See page 55.

Acknowledgement

[t][][Set ID][][OK][Data][x]

17. Color Temperature (Command2:u)

- ▶ To adjust color temperature.
You can also adjust color temperature in the Video menu.

Transmission

[k][u][][Set ID][][Data][Cr]

Data 0: Medium 1: Cool 2: Warm 3: User

Acknowledgement

[u][][Set ID][][OK][Data][x]

These functions are available in 42PC3D /3DV, 50PC3D, 60PC1D model only.

18. ISM Method (Command2:p)

► To avoid having a fixed image remain on screen.

Transmission

```
[j][p][ ][Set ID][ ][Data][Cr]
```

Data 1: Inversion
2: Orbiter
4: White Wash
8: Normal

Acknowledgement

```
[p][ ][Set ID][ ][OK][Data][x]
```

19. Low Power (Command2:q)

► To control the Low Power function on/off.
You can also adjust Low Power in Option menu.

Transmission

```
[j][q][ ][Set ID][ ][Data][Cr]
```

Data 0: Low Power off
1: Low Power on

Acknowledgement

```
[q][ ][Set ID][ ][OK][Data][x]
```

20. Tune Command (Command: m a)

► To tune channel to following physical/major/minor number

Transmission

```
[m][a][ ][Set ID][ ][Data0][ ][Data1][ ][Data2][ ][Data3][ ][Data4][ ][Data5][Cr]
```

Data 0: Physical Channel Number(Transmit by Hexadecimal code)
NTSC air:02~45
NTSC cable: 01~87
ATSC air:02~45
ATSC cable:01~87

Data 1,Data 2: Major Channel Number(two part) or Channel Number(One part)
Data1: High byte
Data2: Low byte

Two part channel number: Major number-Minor number
One part channel number: If the channel band is ATSC digital cable, it can be used. In case of using one part channel number, minor channel does not need.

Data 3, Data 4: Minor Channel Number Data3: High byte Data4: Low byte
Data 5:

| 7 | Main Picture | 6 | Two/One Part Channel | 5 | Using Physical Channel | 4 Resev ed | 3 | 2 | 1 | 0 | Step |
|---|--------------|---|----------------------|---|------------------------|------------|---|---|---|---|------------------|
| 0 | Main | 0 | Two | 0 | Use | x | 0 | 0 | 0 | 0 | NTSC Air |
| 1 | | 1 | One | 1 | No Use | x | 0 | 0 | 0 | 1 | NTSC Cable |
| | | | | | | x | 0 | 0 | 1 | 0 | ATSC Air |
| | | | | | | x | 0 | 0 | 1 | 1 | ATSC Cable_std |
| | | | | | | x | 0 | 1 | 0 | 0 | ATSC Cable_irc |
| | | | | | | x | 0 | 1 | 0 | 1 | ATSC Cable_irc |
| | | | | | | x | 0 | 1 | 1 | 0 | ATSC cable_audio |
| | | | | | | x | 0 | 1 | 1 | 1 | Reserved |
| | | | | | | x | x | x | x | x | ... |
| | | | | | | x | 1 | 1 | 1 | 1 | Reserved |

* All data are transmitted by Hexadecimal code

*Two/One part Channel: 6th bit

This bit is used in a cable-ready system.

*Using physical channel: 5th bit

If the channel band is NTSC air or NTSC cable, channel tuning can be done by only physical channel. In this case, using physical channel bit must be low(0).

But if the channel band is ATSC air or ATSC cable, there are two cases that physical channel enable or disable.

If the physical channel sending is meaningful, you should set this bit low(0). If the physical channel sending is meaningless, you should set this bit high(1).

Example)

1. Analog channel: NTSC cable, channel number(35), main picture
Command: ma 00 23 xx xx xx 01 attribute(0x01): main picture, two part(it's not mandatory), using physical channel, NTSC cable 'xx' data: don't care major and minor channel number in case analog channel tuning.
2. Digital channel: ATSC air, channel number(don't know physical channel, major(30), minor(3)), main picture
Command: ma 00 xx 00 1E 00 03 22 attribute(0x22): main picture, two part, not using physical channel, ATSC air 'xx' data: don't care analog channel number in case digital channel tuning.
3. Digital channel: ATSC air, channel number (physical(20), major (30), minor (5)), main picture
Command: ma 00 14 00 1E 00 05 02 attribute(0x02): main picture, two part, using physical channel, ATSC air.

Acknowledgement

```
[a][ ][Set ID][ ][OK][Data0][Data1][Data2][Data3][Data4][Data5][x]  
[a][ ][Set ID][ ][NG][Data0][x]
```

21. Channel Add/Del (Command: m b)

► To add and delete the channels

Transmission

```
[m][b][ ][Set ID][ ][Data][Cr]
```

Data 0: Channel Delete
1: Channel Add

Acknowledgement

```
[b][ ][Set ID][ ][OK][Data][x]
[b][ ][Set ID][ ][NG][Data][x]
```

22. Key (Command: m c)

► To send IR remote key code

Transmission

```
[m][c][ ][Set ID][ ][Data][Cr]
```

Data Key code: Refer to page 60.

Acknowledgement

```
[c][ ][Set ID][ ][OK][Data][x]
```

23. Input select(Command: x b) (Main Picture Input)

► To select input source for TV.

Transmission

```
[x][b][ ][Set ID][ ][Data][Cr]
```

Data Structure

| DATA(Hex) | INPUT |
|-----------|------------------|
| 00 | DTV (Antenna) |
| 01 | DTV (Cable) |
| 10 | Analog (Antenna) |
| 11 | Analog (Cable) |
| 20 | AV1 |
| 21 | AV2 |
| 40 | Component 1 |
| 41 | Component 2 |
| 60 | RGB PC |
| 90 | HDMI1/DVI |
| 91 | HDMI2 |

Acknowledgement

```
[b][ ][Set ID][ ][OK/NG][Data][x]
```

IR Codes

How to Connect

- ▶ Connect your wired remote control to the Remote Control port on the TV.

Remote Control IR Codes

▶ Output waveform

Single pulse, modulated with 37.917KHz signal at 455KHz

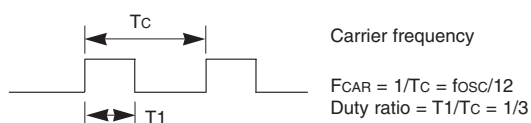

▶ Configuration of frame

- 1st frame

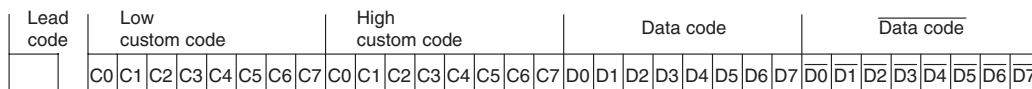

- Repeat frame

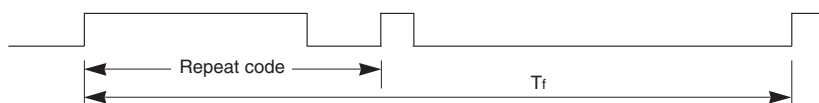

▶ Lead code



▶ Repeat code

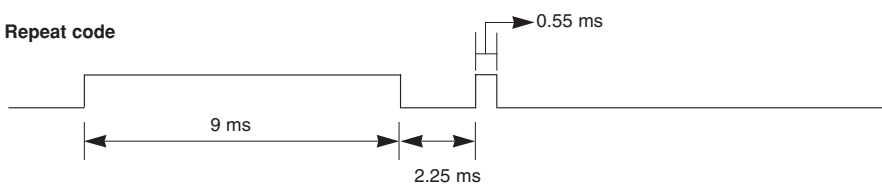

▶ Bit description

- Bit "0"

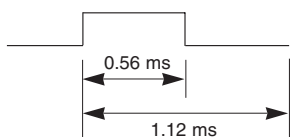

- Bit "1"

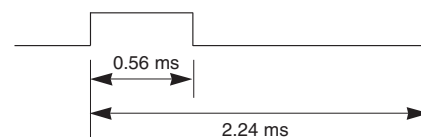

▶ Frame interval : Tf

The waveform is transmitted as long as a key is depressed.

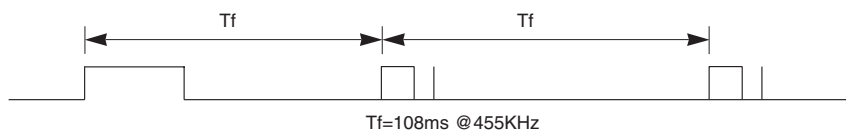

| Code (Hexa) | Function | Note |
|-------------|-----------------|-----------------------------------------------|
| 0B | INPUT | R/C Button |
| 0F | TV INPUT | R/C Button |
| 98 | MULTIMEDIA | R/C Button |
| 08 | POWER | R/C Button (Power On/Off) |
| C4 | POWER ON | Discrete IR Code (Only Power On) |
| C5 | POWER OFF | Discrete IR Code (Only Power Off) |
| 79 | RATIO | R/C Button |
| 0E | TIMER | R/C Button |
| 10 ~ 19 | Number Key 0~ 9 | R/C Button |
| 4C | - (Dash) | R/C Button |
| 1A | FLASHBK | R/C Button |
| 09 | MUTE | R/C Button |
| 02 | VOL ▲ | R/C Button |
| 03 | VOL ▼ | R/C Button |
| 00 | CH ▲ | R/C Button |
| 01 | CH ▼ | R/C Button |
| 1E | FAV | R/C Button |
| AA | INFO | R/C Button |
| 39 | CC | R/C Button |
| 40 | ▲ | R/C Button |
| 41 | ▼ | R/C Button |
| 07 | ◀ | R/C Button |
| 06 | ▶ | R/C Button |
| 44 | ENTER | R/C Button |
| 43 | MENU | R/C Button |
| 52 | EZ SOUND | R/C Button |
| 4D | EZ PIC | R/C Button |
| 5B | EXIT | R/C Button |
| 0A | SAP | R/C Button |
| CB | ADJUST | R/C Button |
| D6 | TV | Discrete IR Code (TV Input Selection) |
| 5A | AV1 | Discrete IR Code (AV1 Input Selection) |
| D0 | AV2 | Discrete IR Code (AV2 Input Selection) |
| BF | COMPONENT 1 | Discrete IR Code (Component1 Input Selection) |
| D4 | COMPONENT 2 | Discrete IR Code (Component2 Input Selection) |
| D5 | RGB-PC | Discrete IR Code (RGB-PC Input Selection) |
| CE | HDMI1/DVI | Discrete IR Code (HDMI-DVI Input Selection) |
| CC | HDMI2 | Discrete IR Code (HDMI2 Input Selection) |
| 76 | Ratio 4:3 | Discrete IR Code (Only 4:3 Mode) |
| 77 | Ratio 16:9 | Discrete IR Code (Only 16:9 Mode) |
| AF | Ratio Zoom | Discrete IR Code (Only Zoom1 Mode) |
| E1 | BRIGHT - | R/C Button |
| E0 | BRIGHT + | R/C Button |

Programming the Remote

- ▶ The remote control is a multi-brand or universal remote control. It can be programmed to operate most remote-controllable devices of other manufacturers.

Note that the remote control may not control all models of other brands.

Programming a code into a remote mode

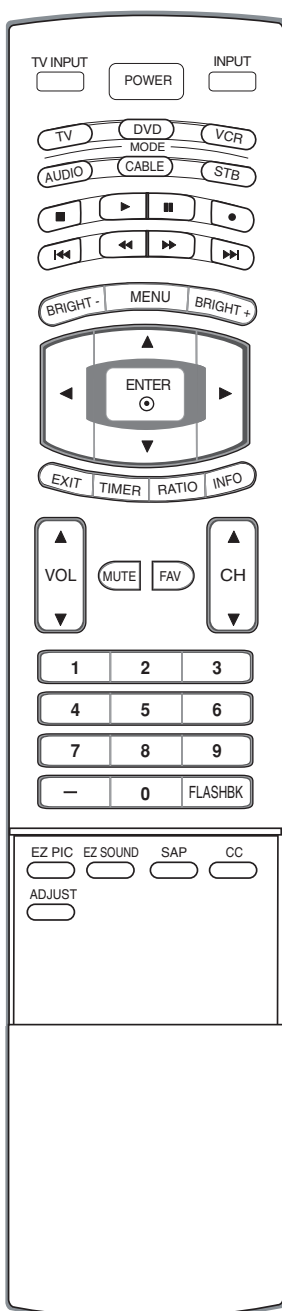

- 1** Test your remote control.
To find out whether your remote control can operate the component without programming, turn on the component such as a VCR and press the corresponding **MODE** button (VCR) on the remote control, while illuminating on the selected component. Test the **POWER** button to see if the component responds properly. If not, the remote requires programming to operate the device.
- 2** Turn on the component to be programmed, then press the corresponding **MODE** button on the remote control.
- 3** Press the **MENU** and **MUTE** buttons simultaneously for 2 seconds, the button selected component lights on the remote control. If you don't press any button for 20 seconds, the button selected component will turn off on the remote control. At a moment, you have to repeat from step 2.
- 4** Enter a code number using the number buttons on the remote. When pressing the button, the light is blinked at a time. Programming code numbers for the corresponding component can be found on the following pages. Again, if the code is correct, the device will turn off.
- 5** Press the **MENU** button to store the code. After blinking twice, this code is stored.
- 6** Test the remote control functions to see if the component responds properly. If not, repeat from step 2.

Programming Codes

VCRs

| Brand | Codes | Brand | Codes | Brand | Codes | Brand | Codes |
|----------------|-----------------|---------------|-----------------|------------|-----------------|-----------------|-----------------|
| AIWA | 034 | KENWOOD | 014 034 039 043 | PORTLAND | 108 | TATUNG | 039 043 |
| AKAI | 016 043 046 124 | | 047 048 | PULSAR | 072 | TEAC | 034 039 043 |
| | 125 146 | LG (GOLDSTAR) | 001 012 013 020 | QUARTZ | 011 014 | TECHNICS | 031 033 070 |
| AMPRO | 072 | | 101 106 114 123 | QUASAR | 033 066 075 145 | TEKNIKA | 019 031 033 034 |
| ANAM | 031 033 103 | LLOYD | 034 | RCA | 013 020 033 034 | | 101 |
| AUDIO DYNAMICS | 012 023 039 043 | LXI | 003 009 013 014 | | 040 041 062 063 | THOMAS | 034 |
| BROKSONIC | 035 037 129 | | 017 034 101 106 | | 107 109 140 144 | TMK | 006 |
| CANON | 028 031 033 | MAGIN | 040 | REALISTIC | 145 147 | TOSHIBA | 008 013 042 047 |
| CAPEHART | 108 | MAGNAVOX | 031 033 034 041 | | 003 008 010 014 | | 059 082 112 131 |
| CRAIG | 003 040 135 | | 067 068 | | 031 033 034 040 | TOTEVISION | 040 101 |
| CURTIS MATHES | 031 033 041 | MARANTZ | 012 031 033 067 | | 053 054 101 | UNITECH | 040 |
| DAEWOO | 005 007 010 064 | | 069 | RICO | 058 | VECTOR RESEARCH | 012 |
| | 065 108 110 111 | MARTA | 101 | RUNCO | 148 | VICTOR | 048 |
| | 112 116 117 119 | MATSUI | 027 030 | SALORA | 014 | VIDEO CONCEPTS | 012 034 046 |
| DAYTRON | 108 | MEI | 031 033 | SAMSUNG | 032 040 102 104 | VIDEOSONIC | 040 |
| DBX | 012 023 039 043 | MEMOREX | 003 010 014 031 | | 105 107 109 112 | WARDS | 003 013 017 024 |
| DYNATECH | 034 053 | | 033 034 053 072 | | 113 115 120 122 | | 031 033 034 040 |
| ELECTROHOME | 059 | | 101 102 134 139 | | 125 | | 053 054 131 |
| EMERSON | 006 017 025 027 | MGA | 045 046 059 | SANSUI | 022 043 048 135 | YAMAHA | 012 034 039 043 |
| | 029 031 034 035 | MINOLTA | 013 020 | SANYO | 003 007 010 014 | ZENITH | 034 048 056 |
| | 036 037 046 101 | MITSUBISHI | 013 020 045 046 | | 102 134 | | 058 072 080 101 |
| | 129 131 138 153 | | 049 051 059 061 | SCOTT | 017 037 112 129 | | |
| FISHER | 003 008 009 010 | | 151 | | 131 | | |
| FUNAI | 034 | MTC | 034 040 | SEARS | 003 008 009 010 | | |
| GE | 031 033 063 072 | MULTITECH | 024 034 | | 013 014 017 020 | | |
| | 107 109 144 147 | NEC | 012 023 039 043 | | 031 042 073 081 | | |
| GO VIDEO | 132 136 | | 048 | | 101 | | |
| HARMAN KARDON | 012 045 | NORDMENDE | 043 | SHARP | 031 054 149 | | |
| HITACHI | 004 018 026 034 | OPTONICA | 053 054 | SHINTOM | 024 | | |
| | 043 063 137 150 | PANASONIC | 066 070 074 083 | SONY | 003 009 031 052 | | |
| INSTANTREPLAY | 031 033 | | 133 140 145 | | 056 057 058 076 | | |
| JCL | 031 033 | PENTAX | 013 020 031 033 | | 077 078 149 | | |
| JCPENNY | 012 013 015 033 | | 063 | SOUNDESIGN | 034 | | |
| | 040 066 101 | PHILCO | 031 034 067 | STS | 013 | | |
| JENSEN | 043 | PHILIPS | 031 033 034 054 | SYLVANIA | 031 033 034 059 | | |
| JVC | 012 031 033 043 | | 067 071 101 | | 067 | | |
| | 048 050 055 060 | PILOT | 101 | SYMPHONIC | 034 | | |
| | 130 150 152 | PIONEER | 013 021 048 | TANDY | 010 034 | | |

Cable Box

| Brand | Codes | Brand | Codes | Brand | Codes | Brand | Codes |
|--------------|-----------------|----------------|-----------------|--------------------|-----------------|--------------|-----------------|
| ABC | 003 004 039 042 | GOLDEN CHANNEL | 030 | | 065 085 090 | SPRUCER | 047 078 |
| | 046 052 053 | HAMLIN | 049 050 055 | PIONEER | 034 051 052 063 | STARCOM | 002 004 008 009 |
| AJIN | 112 | HITACHI | 052 055 | | 076 | STARGATE | 008 030 |
| ANTRONIK | 014 | HOSPITALITY | 070 077 | POST NEWS WEEK | 016 | TADIRAN | 030 |
| ARCHER | 005 007 014 024 | JERROLD | 002 003 004 008 | PRUCER | 059 | TAEKWANG | 110 |
| CABLE STAR | 026 | | 009 010 052 069 | PTS | 011 048 071 072 | TAIHAN | 105 |
| CENTURION | 092 | | 074 | | 073 074 | TANDY | 017 |
| CENTURY | 007 | LG (GOLDSTAR) | 001 106 101 005 | PULSAR | 100 | TEXSCAN | 029 |
| CITIZEN | 007 | M-NET | 037 | RCA | 047 | TOCOM | 039 040 056 |
| COLOUR VOICE | 065 090 | MACOM | 033 | REGAL | 049 050 | TOSHIBA | 100 |
| COMBANO | 080 081 | MAGNAVOX | 010 012 064 079 | REGENCY | 057 | UNIKA | 007 014 024 |
| COMTRONICS | 019 030 | MEMOREX | 100 | REMBRANT | 025 | UNITED CABLE | 004 053 |
| DIAMOND | 023 | MOVIE TIME | 028 032 | SAMSUNG | 102 107 030 068 | UNIVERSAL | 005 007 014 024 |
| EAGLE | 020 030 040 | NSC | 015 028 038 071 | SCIENTIFIC ATLANTA | 003 011 041 042 | | 026 027 032 035 |
| EASTERN | 057 062 066 | | 073 | | 043 045 046 | VIEWSTAR | 012 015 018 086 |
| ELECTRICORD | 032 | OAK | 016 031 037 053 | SHERITECH | 022 | | 087 088 089 |
| GE | 072 | PANASONIC | 044 047 | SIGNAL | 030 | ZENITH | 100 114 060 093 |
| GEMINI | 008 022 025 054 | PARAGON | 100 | SIGNATURE | 052 | | |
| GI | 052 074 | PHILIPS | 006 012 013 020 | SL MARX | 030 | | |

Digital Cable/Satellite Box

| Brand | Codes | Brand | Codes | Brand | Codes | Brand | Codes |
|----------------|-----------------|--------------------|-----------------|----------------------|-----------------|----------|-----------------|
| ALPHASTAR DSR | 123 | | 133 134 | PACE SKY SATELLITE | 143 | | 088 090 107 130 |
| AMPLICA | 050 | GENERAL INSTRUMENT | 003 004 016 029 | PANASONIC | 060 142 | | 137 |
| BIRDVIEW | 051 126 129 | | 031 059 101 | PANSAT | 121 | TOSHIBA | 002 127 |
| CHANNEL MASTER | 013 014 015 018 | HITACHI | 139 140 | PERSONAL CABLE | 117 | UNIDEN | 016 025 042 043 |
| | 036 055 | HOUSTON TRACKER | 033 037 039 051 | PHILIPS | 071 | | 044 045 048 049 |
| CHAPARRAL | 008 009 012 077 | | 057 104 | PICO | 105 | | 078 079 080 086 |
| CITOH | 054 | HUGHES | 068 | PRESIDENT | 019 102 | | 101 |
| CURTIS MATHES | 050 145 | JANIEL | 060 147 | PRIMESTAR | 030 110 111 | UNIDEN | 135 136 |
| DRAKE | 005 006 007 010 | JERROLD | 061 | PROSAT | 072 | VIEWSTAR | 115 |
| | 011 052 112 116 | KATHREIN | 108 | RCA | 066 106 | WINEGARD | 128 146 |
| | 141 | LEGEND | 057 | REALISTIC | 043 074 | ZENITH | 081 082 083 084 |
| DX ANTENNA | 024 046 056 076 | LG | 001 | SAMSUNG | 123 | | 091 120 |
| ECHOSTAR | 038 040 057 058 | LUTRON | 132 | SATELLITE SERVICE CO | 028 035 047 057 | | |
| | 093 094 095 096 | LUXOR | 062 144 | | 085 | | |
| | 097 098 099 100 | MACOM | 010 059 063 064 | SCIENTIFIC ATLANTA | 032 138 | | |
| | 122 | | 065 | SONY | 103 | | |
| ELECTRO HOME | 089 | MEMOREX | 057 | STARCAST | 041 | | |
| EUROPLUS | 114 | NEXTWAVE | 028 124 125 | SUPER GUIDE | 020 124 125 | | |
| FUJITSU | 017 021 022 027 | NORSAT | 069 070 | TEECOM | 023 026 075 087 | | |

Audio

| Brand | Codes | Brand | Codes | Brand | Codes | Brand | Codes |
|---------------|-----------------|-----------|-----------------|-----------|-----------------|---------|-----------------|
| AIWA | 014 028 070 096 | JVC | 004 013 141 | PHILIPS | 026 112 143 | TOSHIBA | 137 |
| | 125 129 139 229 | KEC | 185 186 187 | PIONEER | 039 042 043 063 | THE | 061 |
| | 230 | KENWOOD | 038 050 067 089 | | 065 091 093 094 | VICTOR | 088 131 |
| AKAI | 163 | | 170 171 197 206 | | 115 123 127 250 | WARDS | 089 |
| ANAM | 003 014 017 023 | | 215 222 | QUASAR | 113 | YAMAHA | 054 055 066 092 |
| | 059 106 189 216 | KOHEL | 030 | RCA | 080 | | 199 |
| | 217 235 236 | NAD | 045 046 | RCX | 092 | | |
| BURMECTER | 252 | LOTTE | 014 016 036 098 | REALISTIC | 103 106 | | |
| CARVER | 086 | | 100 172 173 174 | SAMSUNG | 124 145 146 182 | | |
| CLARION | 199 | | 175 176 177 178 | | 193 194 195 203 | | |
| DAEWOO | 027 053 060 084 | | 179 180 181 183 | | 204 244 245 246 | | |
| | 102 148 198 221 | | 201 202 208 213 | SANSUI | 011 135 138 144 | | |
| DENON | 015 075 130 143 | | 214 219 223 232 | SANYO | 019 083 234 | | |
| FANTASIA | 071 | | 238 240 | SCOTT | 106 186 | | |
| FINEARTS | 022 | LXI | 103 | SHARP | 031 032 051 052 | | |
| FISHER | 089 099 | MAGNAVOX | 111 | | 072 082 117 119 | | |
| LG(GOLDSTAR) | 001 021 024 029 | MARANTZ | 002 018 020 025 | | 156 184 199 200 | | |
| | 087 107 108 110 | | 034 041 081 090 | | 206 209 | | |
| | 190 191 192 210 | | 097 112 | SHERWOOD | 005 006 158 | | |
| | 211 212 239 | MCINTOSH | 049 | SONY | 044 045 109 114 | | |
| HAITAI | 034 035 188 222 | MCS | 104 | | 118 126 248 249 | | |
| HARMAN/KARDON | 068 | MEMOREX | 107 | TAEKWANG | 012 020 073 074 | | |
| INKEL | 037 058 062 069 | NAD | 046 | | 076 077 105 161 | | |
| | 078 079 095 121 | ONKYO | 013 040 041 047 | | 162 163 164 165 | | |
| | 122 149 150 151 | | 048 056 057 132 | | 166 167 168 169 | | |
| | 152 153 154 155 | | 133 140 | | 205 231 233 242 | | |
| | 157 158 159 160 | OPTIMUS | 158 | TEAC | 010 085 106 136 | | |
| | 189 207 222 224 | PANASONIC | 007 033 064 113 | | 185 187 237 | | |
| | 225 226 227 243 | | 142 220 241 251 | TECHNICS | 101 113 128 134 | | |
| | 247 | PENNEY | 104 | | 147 218 | | |

DVD

| Brand | Codes | Brand | Codes | Brand | Codes | Brand | Codes |
|---------------|-----------------|------------|---------|---------|---------|----------|-------------|
| APEX DIGITAL | 022 | MAGNAVOX | 013 | PHILIPS | 013 | SONY | 007 |
| DENON | 020 014 | MARANTZ | 024 | PIONEER | 004 026 | THOMPSON | 005 006 |
| GE | 005 006 | MITSUBISHI | 002 | PROCEED | 021 | TOSHIBA | 019 008 |
| HARMAN KARDON | 027 | NAD | 023 | PROSCAN | 005 006 | YAMAHA | 009 018 |
| JVC | 012 | ONKYO | 008 017 | RCA | 005 006 | ZENITH | 010 016 025 |
| LG | 001 010 016 025 | PANASONIC | 003 009 | SAMSUNG | 011 015 | | |

Troubleshooting Checklist

| The operation does not work normally. | |
|----------------------------------------------|----------------------------------------------------------------------------------------------------------------------------------------------------------------------------------------------------------------------------------------------------------------------------------------------------------------------------------|
| The remote control doesn't work | <ul style="list-style-type: none"> • Check to see if there is any object between the product and the remote control causing obstruction. • Are batteries installed with correct polarity (+ to +, - to -)? • Correct remote operating mode set: TV, VCR etc.? • Install new batteries. |
| Power is suddenly turned off | <ul style="list-style-type: none"> • Is the sleep timer set? • Check the power control settings. Power interrupted • No broadcast on station tuned with Auto off activated. |

| The video function does not work. | |
|----------------------------------------------------|-----------------------------------------------------------------------------------------------------------------------------------------------------------------------------------------------------------------------------------------------------------------------------------------------------------------------------------------------------------------------------------------------------------------------------------|
| No picture & No sound | <ul style="list-style-type: none"> • Check whether the product is turned on. • Try another channel. The problem may be with the broadcast. • Is the power cord inserted into wall power outlet? • Check your antenna direction and/or location. • Test the wall power outlet, plug another product's power cord into the outlet where the product's power cord was plugged in. |
| Picture appears slowly after switching on | <ul style="list-style-type: none"> • This is normal, the image is muted during the product startup process. Please contact your service center, if the picture has not appeared after five minutes. |
| No or poor color or poor picture | <ul style="list-style-type: none"> • Adjust Color in menu option. • Keep a sufficient distance between the product and the VCR. • Try another channel. The problem may be with the broadcast. • Are the video cables installed properly? • Activate any function to restore the brightness of the picture. |
| Horizontal/vertical bars or picture shaking | <ul style="list-style-type: none"> • Check for local interference such as an electrical appliance or power tool. |
| Poor reception on some channels | <ul style="list-style-type: none"> • Station or cable product experiencing problems, tune to another station. • Station signal is weak, reorient antenna to receive weaker station. • Check for sources of possible interference. |
| Lines or streaks in pictures | <ul style="list-style-type: none"> • Check antenna (Change the direction of the antenna). |

| The audio function does not work. | |
|----------------------------------------------|--------------------------------------------------------------------------------------------------------------------------------------------------------------------------------------------------------------------------------------------------------------------------------|
| Picture OK & No sound | <ul style="list-style-type: none"> • Press the VOL or VOLUME button. • Sound muted? Press MUTE button. • Try another channel. The problem may be with the broadcast. • Are the audio cables installed properly? |
| No output from one of the speakers | <ul style="list-style-type: none"> • Adjust Balance in menu option. |
| Unusual sound from inside the product | <ul style="list-style-type: none"> • A change in ambient humidity or temperature may result in an unusual noise when the product is turned on or off and does not indicate a fault with the product. |

| There is a problem in PC mode. (Only PC mode applied) | |
|---------------------------------------------------------------------------------------------|----------------------------------------------------------------------------------------------------------------------------------------------------------------------------------------------------------------------------|
| The signal is out of range. | <ul style="list-style-type: none"> • Adjust resolution, horizontal frequency, or vertical frequency. • Check it whether the signal cable is connected or loose. • Check the input source. |
| Vertical bar or stripe on background & Horizontal Noise & Incorrect position | <ul style="list-style-type: none"> • Work the Auto configure or adjust clock, phase, or H/V position. (Option) |
| Screen color is unstable or single color | <ul style="list-style-type: none"> • Check the signal cable. • Reinstall the PC video card. |

Maintenance

- Early malfunctions can be prevented. Careful and regular cleaning can extend the amount of time you will have your new TV. Be sure to turn the power off and unplug the power cord before you begin any cleaning.

Cleaning the Screen

1. Here's a great way to keep the dust off your screen for a while. Wet a soft cloth in a mixture of lukewarm water and a little fabric softener or dish washing detergent. Wring the cloth until it's almost dry, and then use it to wipe the screen.
2. Make sure the excess water is off the screen, and then let it air-dry before you turn on your TV.

Cleaning the Cabinet

To remove dirt or dust, wipe the cabinet with a soft, dry, lint-free cloth. Please do not use a wet cloth.

Extended Absence



If you expect to leave your TV dormant for a long time (such as a vacation), it's a good idea to unplug the power cord to protect against possible damage from lightning or power surges.

Product Specifications

| | | | |
|--------------------------------|----------------------------------------|---------------------------------------------------------------------|---------------------------------------------------------|
| 60PC1D (60PC1D-UE) | Dimensions (Width x Height x Depth) | with stand | 60.8 x 40.8 x 16.0 inches 1544.0 x 1035.5 x 408.2 mm |
| | | without stand | 60.8 x 38.4 x 4.7 inches 1544.0 x 977.0 x 119.2 mm |
| | Weight | with stand | 163 pounds / 74.0 kg |
| | | without stand | 137.3 pounds / 62.26 kg |
| 42PC3D (42PC3D-UE) | Dimensions (Width x Height x Depth) | with stand | 44.4 x 29.5x 15.0 inches 1129.0 x 748.5 x 380.0 mm |
| | | without stand | 44.4 x 27.4 x 4.1 inches 1129.0 x 695 x 103.7 mm |
| | Weight | with stand | 64.4 pounds / 29.2 kg |
| | | without stand | 55.8 pounds / 25.3 kg |
| 42PC3DV (42PC3DV-UE) | Dimensions (Width x Height x Depth) | with stand | 44.4 x 29.5x 15.0 inches 1129.0 x 748.5 x 380.0 mm |
| | | without stand | 44.4 x 27.4 x 4.1 inches 1129.0 x 695 x 103.7 mm |
| | Weight | with stand | 62.6 pounds / 28.4 kg |
| | | without stand | 54.0 pounds / 24.5 kg |
| 50PC3D (50PC3D-UE) | Dimensions (Width x Height x Depth) | with stand | 51.3 x 34.3 x 14.0 inches 1302.6 x 872.0 x 355.8 mm |
| | | without stand | 51.3 x 31.9 x 4.2 inches 1302.6 x 810.0 x 107.7 mm |
| | Weight | with stand | 114.4 pounds / 51.9 kg |
| | | without stand | 95.0 pounds / 43.1 kg |
| Power requirement | | AC100-240V ~ 50/60Hz | |
| Television System | | NTSC-M, ATSC, 64 & 256 QAM | |
| Program Coverage | | VHF 2 ~ 13, UHF 14 ~ 69, CATV 1 ~ 135, CADTV 1 ~ 135, DTV 2 ~ 69 | |
| External Antenna Impedance | | 75 Ω | |
| Environmental condition | Operating Temperature | | 32 ~ 104°F (0 ~ 40°C) |
| | Operating Humidity | | Less than 80% |
| | Storage Temperature | | -4 ~ 140°F (-20 ~ 60°C) |
| | Storage Humidity | | Less than 85% |

• The specifications shown above may be changed without prior notice for quality improvement.

| | | | |
|--------------------------------------------------------------|----------------------------------------|---------------------------------------------------------------------|-------------------------------------------------------|
| 32LC2D 32LC2DU (32LC2D-UE 32LC2DU-UE) | Dimensions (Width x Height x Depth) | with stand | 31.9 x 24.8 x 9.3 inches 811 x 630 x 235 mm |
| | | without stand | 31.9 x 22.3 x 4.9 inches 811.0 x 566.8 x 123.5 mm |
| | Weight | with stand | 48.3 pounds / 21.9 kg |
| | | without stand | 40.8 pounds / 18.5 kg |
| 37LC2D (37LC2D-UE) | Dimensions (Width x Height x Depth) | with stand | 37.2 x 28.7 x 11.3 inches 944 x 729 x 286 mm |
| | | without stand | 37.2 x 26.0 x 5.1 inches 944.0 x 659.3 x 129.7 mm |
| | Weight | with stand | 65.0 pounds / 29.5 kg |
| | | without stand | 54.9 pounds / 24.9 kg |
| 42LC2D (42LC2D-UE) | Dimensions (Width x Height x Depth) | with stand | 41.5 x 32.0 x 11.9 inches 1054 x 813 x 302 mm |
| | | without stand | 41.5 x 29.4 x 5.4 inches 1054.0 x 746.0 x 136.8 mm |
| | Weight | with stand | 81.6 pounds / 37.0 kg |
| | | without stand | 67.0 pounds / 30.4 kg |
| Power requirement | | AC100-240V ~ 50/60Hz | |
| Television System | | NTSC-M, ATSC, 64 & 256 QAM | |
| Program Coverage | | VHF 2 ~ 13, UHF 14 ~ 69, CATV 1 ~ 135, CADTV 1 ~ 135, DTV 2 ~ 69 | |
| External Antenna Impedance | | 75 Ω | |
| Environmental condition | Operating Temperature | | 32 ~ 104°F (0 ~ 40°C) |
| | Operating Humidity | | Less than 80% |
| | Storage Temperature | | -4 ~ 140°F (-20 ~ 60°C) |
| | Storage Humidity | | Less than 85% |

- The specifications shown above may be changed without prior notice for quality improvement.

