

Register your product and get support at  
[www.philips.com/welcome](http://www.philips.com/welcome)

55PFL7705D  
46PFL7705D  
40PFL7705D



---

EN User manual

---

FR Manuel d'utilisation

---

ES Manual del usuario

**EN:** For further assistance, call the customer support service in your country.

- To obtain assistance in the U.S.A., Canada, Puerto Rico, or the U.S. Virgin Islands, contact Philips Customer Care Center at **1-866-309-0841**
- To obtain assistance in Mexico, contact Philips Customer Care Center at **01 800 504 62 00**

Enter below the model and serial numbers located on the back and right side of the TV cabinet.

**FR:** Pour obtenir de l'aide supplémentaire, communiquez avec le centre de service à la clientèle de votre pays.

- Pour obtenir de l'aide aux États-Unis, au Canada, à Puerto Rico ou aux Îles Vierges américaines, communiquez avec le centre de service à la clientèle Philips au : **1-866-309-0841**
- Pour obtenir l'aide au Mexique, entrez en contact avec le centre de soin de client de Philips à **01 800 504 62 00**

Entrer ci dessous le modèle et le numéro de série situés derrière à droite sur le dos du téléviseur.

**ES:** Para obtener más información, llame al servicio de soporte al cliente de su país.

- Para obtener asistencia en los Estados Unidos, en Canadá, Puerto Rico o en las Islas Vírgenes de los Estados Unidos, comuníquese con Centro de atención al cliente de Philips al **1-866-309-0841**
- Solo para México CENTRO DE ATENCIÓN A CLIENTES LADA. **01 800 504 62 00** Solo Para México.

Escriba a continuación el modelo y número de serie que están localizados en lado derecho y parte posterior de el gabinete de el televisor.

MODEL NUMBER

SERIAL NUMBER

**PHILIPS**

# Contents

<b>1 Notice</b>	4	<b>8 Update your TV software</b>	31
		Checking your current software version	31
<b>2 Important</b>	5	Preparing for the software update by USB	31
Product information	5	Updating software	31
Screen care	5		
Environmental care	5	<b>9 Connect devices</b>	33
Regulatory notices	5	Connection overview	33
		Selecting your connection quality	34
<b>3 Your TV</b>	6	Connecting your devices	35
Side controls and indicators	6	Add devices	37
Remote control	6	Remove devices	37
<b>4 Get started</b>	8	<b>10 Troubleshooting</b>	38
Supplied accessories	8	Downloading an electronic copy	38
Mounting base onto TV for 40" and 46"	8	Contact us	38
Positioning the TV	8		
Adjusting the swivel angle	8	<b>11 Product information</b>	39
Installing the remote control batteries	8		
Connecting the antenna or cable	9	<b>12 Warranty</b>	40
Managing cables	10		
Connecting the AC power cord	10	<b>13 Index</b>	41
Switching on and set up the TV	11		
<b>5 Use your TV</b>	12		
Switching your TV on or to standby	12		
Switching channels	12		
Adjusting volume	13		
Watching channels from a set-top box	13		
Watching connected devices	13		
Watching a Blu-ray Disc	13		
<b>6 Use more of your TV</b>	14		
Access TV menus	14		
Netflix operations	15		
Enjoying internet radio with vTuner	16		
Changing picture and sound settings	18		
Create and use lists of favorite channels	20		
Setting the clock	21		
Closed caption	21		
Sleeptimer	22		
Child and rating locks	22		
Use the demo mode	25		
Use Philips EasyLink	25		
EasyLink	25		
Set your location to home	26		
Network	26		
DivX® Video on Demand	27		
View photos and play music, and watch videos on a USB storage device	28		
<b>7 Install channels</b>	30		
Selecting your menu language	30		
Autoprogram	30		
Weak channel installation	30		
Installation mode	30		
Uninstall channels	30		
Return your settings to default values	30		

**Return your Product Registration Card or register online at  
www.philips.com/welcome today to get the very most from your purchase.**

Registering your model with PHILIPS makes you eligible for all of the valuable benefits listed below, so don't miss out. Complete and return your Product Registration Card at once, or register online at [www.philips.com/welcome](http://www.philips.com/welcome) to ensure:

<p><b>*Proof of Purchase</b></p> <p>Returning the enclosed card guarantees that your date of purchase will be on file, so no additional paperwork will be required from you to obtain warranty service.</p>	<p><b>*Product Safety Notification</b></p> <p>By registering your product, you'll receive notification - directly from the manufacturer - in the rare case of a product recall or safety defect.</p>	<p><b>*Additional Benefits</b></p> <p>Registering your product guarantees that you'll receive all of the privileges to which you're entitled, including special money-saving offers.</p>
---	--	--

# PHILIPS

***Congratulations on your purchase, and welcome to the "family!"***

**Dear PHILIPS product owner:**

Thank you for your confidence in PHILIPS. You've selected one of the best-built, best-backed products available today. We'll do everything in our power to keep you happy with your purchase for many years to come.

As a member of the PHILIPS "family," you're entitled to protection by one of the most comprehensive warranties and outstanding service networks in the industry. What's more, your purchase guarantees you'll receive all the information and special offers for which you qualify, plus easy access to accessories from our convenient home shopping network.

Most importantly, you can count on our uncompromising commitment to your total satisfaction.

All of this is our way of saying welcome - and thanks for investing in a PHILIPS product.

**P.S. To get the most from your PHILIPS purchase, be sure to complete and return your Product Registration Card at once, or register online at:**

**[www.philips.com/welcome](http://www.philips.com/welcome)**

Know these **safety** symbols



**⚡** This "bolt of lightning" indicates un-insulated material within your unit may cause an electrical shock. For the safety of everyone in your household, please do not remove product covering.

**⚠** The "exclamation point" calls attention to features for which you should read the enclosed literature closely to prevent operating and maintenance problems.

**WARNING:** To reduce the risk of fire or electric shock, this apparatus should not be exposed to rain or moisture and objects filled with liquids, such as vases, should not be placed on this apparatus.

**CAUTION:** To prevent electric shock, match wide blade of plug to wide slot, fully insert.

**ATTENTION:** Pour éviter les choc électriques, introduire la lame la plus large de la fiche dans la borne correspondante de la prise et pousser jusqu'au fond.

**For Customer Use**

Enter below the model and serial numbers located on the back and right side of the TV cabinet. Retain this information for future reference.

Model No. \_\_\_\_\_  
Serial No. \_\_\_\_\_

## IMPORTANT SAFETY INSTRUCTIONS

### Read before operating equipment

1. Read these instructions.
2. Keep these instructions.
3. Heed all warnings.
4. Follow all instructions.
5. Do not use this apparatus near water.
6. Clean only with a dry cloth.
7. Do not block any of the ventilation openings. Install in accordance with the manufacturer's instructions.
8. Do not install near any heat sources such as radiators, heat registers, stoves, or other apparatus (including amplifiers) that produce heat.
9. Do not defeat the safety purpose of the polarized or grounding-type plug. A polarized plug has two blades with one wider than the other. A grounding type plug has two blades and third grounding prong. The wide blade or third prong are provided for your safety. When the provided plug does not fit into your outlet, consult an electrician for replacement of the obsolete outlet.
10. Protect the power cord from being walked on or pinched particularly at plugs, convenience receptacles, and the point where they exit from the apparatus.
11. Only use attachments/accessories specified by the manufacturer.
12.  Use only with a cart, stand, tripod, bracket, or table specified by the manufacturer, or sold with the apparatus. When a cart is used, use caution when moving the cart/apparatus combination to avoid injury from tip-over.
13. Unplug this apparatus during lightning storms or when unused for long periods of time.
14. Refer all servicing to qualified service personnel. Servicing is required when the apparatus has been damaged in any way, such as power-supply cord or plug is damaged, liquid has been spilled or objects have fallen into apparatus, the apparatus has been exposed to rain or moisture, does not operate normally, or has been dropped.
15. This product may contain lead. Disposal of these materials may be regulated due to environmental considerations. For disposal or recycling information, please contact your local authorities or the Electronic Industries Alliance: [www.eiae.org](http://www.eiae.org).
16. **Damage Requiring Service** - The appliance should be serviced by qualified service personnel when:
  - A. The power supply cord or the plug has been damaged; or
  - B. Objects have fallen, or liquid has been spilled into the appliance; or

- C. The appliance has been exposed to rain; or
  - D. The appliance does not appear to operate normally or exhibits a marked change in performance; or
  - E. The appliance has been dropped, or the enclosure damaged.
- 17. Tilt/Stability** - All televisions must comply with recommended international global safety standards for tilt and stability properties of its cabinets design.
- Do not compromise these design standards by applying excessive pull force to the front, or top, of the cabinet which could ultimately overturn the product.
  - Also, do not endanger yourself, or children, by placing electronic equipment/toys on the top of the cabinet. Such items could unsuspectingly fall from the top of the set and cause product damage and/or personal injury.
- 18. Wall or Ceiling Mounting** - The appliance should be mounted to a wall or ceiling only as recommended by the manufacturer.
- 19. Power Lines** - An outdoor antenna should be located away from power lines.
- 20. Outdoor Antenna Grounding** - If an outside antenna is connected to the receiver, be sure the antenna system is grounded so as to provide some protection against voltage surges and built up static charges. Section 810 of the National Electric Code, ANSI/NFPA No. 70-1984, provides information with respect to proper grounding of the mats and supporting structure grounding of the lead-in wire to an antenna-discharge unit, size of grounding connectors, location of antenna-discharge unit, connection to grounding electrodes and requirements for the grounding electrode. See Figure below.
- 21. Objects and Liquid Entry** - Care should be taken so that objects do not fall and liquids are not spilled into the enclosure through openings.
- a) **Warning:** To reduce the risk of fire or electric shock, this apparatus should not be exposed to rain or moisture and objects filled with liquids, such as vases should not be placed on this apparatus.
- 22. Battery Usage CAUTION** - To prevent battery leakage that may result in bodily injury, property damage, or damage to the unit:
- Install all batteries correctly, with + and - alignment as marked on the unit.
  - Do not mix batteries (old and new or carbon and alkaline, etc.)
  - Remove batteries when the unit is not used for a long time.

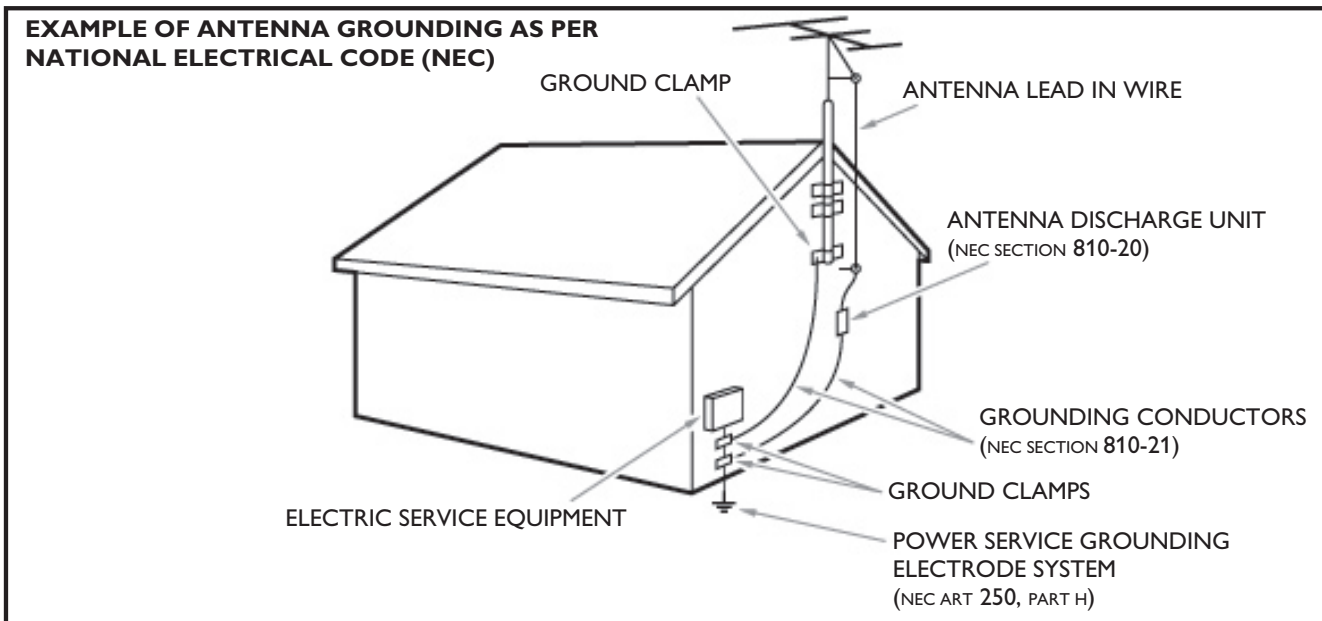

**Note to the CATV system installer:** this reminder is provided to call the CATV system installer's attention to Article 820-40 of the NEC that provides guidelines for proper grounding and, in particular, specifies that the cable ground shall be connected to the grounding system of the building, as close to the point of cable entry as practical.

# 1 Notice

2010 © Koninklijke Philips Electronics N.V. All rights reserved.

Specifications are subject to change without notice. Trademarks are the property of Koninklijke Philips Electronics N.V. or their respective owners. Philips reserves the right to change products at any time without being obliged to adjust earlier supplies accordingly.

The material in this manual is believed adequate for the intended use of the system. If the product, or its individual modules or procedures, are used for purposes other than those specified herein, confirmation of their validity and suitability must be obtained. Philips warrants that the material itself does not infringe any United States patents. No further warranty is expressed or implied.

Philips cannot be held responsible neither for any errors in the content of this document nor for any problems as a result of the content in this document. Errors reported to Philips will be adapted and published on the Philips support website as soon as possible.

## Pixel characteristics

This LCD product has a high number of color pixels. Although it has effective pixels of 99.999% or more, black dots or bright points of light (red, green or blue) may appear constantly on the screen. This is a structural property of the display (within common industry standards) and is not a malfunction.

## Warranty

No components are user serviceable. Do not open or remove covers to the inside of the product. Repairs may only be done by Philips Service Centers and official repair shops. Failure to do so shall void any warranty, stated or implied.

Any operation expressly prohibited in this manual, any adjustments, or assembly procedures not recommended or authorized in this manual shall void the warranty.

## Federal Communications Commission Notice

This equipment has been tested and found to comply with the limits for a Class B digital device, pursuant to part 15 of the FCC Rules. These limits are designed to provide reasonable protection against harmful interference in a residential installation. This equipment generates, uses, and can radiate radio frequency energy and, if not installed and used in accordance with the instructions, may cause harmful interference to radio communications. However, there is no guarantee that interference will not occur in a particular installation. If this equipment does cause harmful interference to radio or television reception, which can be determined by turning the equipment off and on, the user is encouraged to try to correct the interference by one or more of the following measures:

- Reorient or relocate the receiving antenna.
- Increase the separation between the equipment and the receiver.
- Connect the equipment into an outlet on a circuit different from that to which the receiver is connected.
- Consult the dealer or an experienced radio or television technician for help.

## Declaration of Conformity

**Trade Name:** PHILIPS  
**Responsible Party:** P&F USA, Inc.  
**Model:** 55PFL7705D, 46PFL7705D, 40PFL7705D  
**Address:** PO Box 430 Daleville, IN 47334-0430 U.S.A.  
**Telephone Number:** 1-866-309-0841

## Modifications

The FCC requires the user to be notified that any changes or modifications made to this device that are not expressly approved by Philips Consumer Electronics may void the user's authority to operate the equipment.

## Cables

Connections to this device must be made with shielded cables with metallic RFI/EMI connector hoods to maintain compliance with FCC Rules and Regulations.

## Canadian notice

Standard Television Receiving Apparatus, Canada BETS-7/NTMR-7. This Class B digital apparatus meets all requirements of the Canadian Interference-Causing Equipment Regulations.

## Copyright

All other registered and unregistered trademarks are the property of their respective owners.



ENERGY STAR® is a joint program of the U.S. Environmental Protection Agency and the U.S. Department of Energy helping us all save money and protect the environment through energy efficient products and practices.

## Consumer Notice:

This TV has been set to maximize energy efficiency while delivering the best possible picture using the factory installed home mode settings. Changing or enabling other features in this TV (e.g. brightened backlighting) will possibly increase energy consumption beyond the original ENERGY STAR® qualified limits.



SRS TruSurround HD™ creates an immersive, feature-rich surround sound experience from two speakers, complete with rich bass, high frequency detail and clear dialog.



SRS TruSurround HD is a trademark of SRS Labs, Inc. TruSurround HD technology is incorporated under license from SRS Labs, Inc.



Manufactured under license from Dolby Laboratories. Dolby and the double-D symbol are trademarks of Dolby Laboratories.



Netflix and the Netflix logo are trademarks or registered trademarks of Netflix, Inc.



vTuner is a trademark of Nothing Else Matters Software, Ltd.



DivX®, DivX Certified® and associated logos are registered trademarks of DivX, Inc. and are used under license.



VESA, FDMI and the VESA Mounting Compliant logo are trademarks of the Video Electronics Standards Association.



© Kensington and Micro Saver are registered US trademarks of ACCO World corporation with issued registrations and pending applications in other countries throughout the world.

Portions of this software are copyright © The FreeType Project ([www.freetype.org](http://www.freetype.org)).

The American Academy of Pediatrics discourages television viewing for children younger than two years of age.

## 2 Important

Registering your model with Philips makes you eligible for all of the valuable benefits listed below, so don't miss out.

Complete and return your Product Registration Card at once, or register online at [www.philips.com/welcome](http://www.philips.com/welcome) to ensure:

- **Proof of Purchase**  
Returning the enclosed card guarantees that your date of purchase is on file, so no additional paperwork is required from you to obtain warranty service.
- **Product Safety Notification**  
By registering your product you receive notification - directly from the manufacturer - in the rare case of a product recall or safety defect.
- **Additional Benefits of Product Ownership**  
Registering your product guarantees that you receive all of the privileges to which you're entitled, including special money-saving offers.

### For further assistance

For further assistance, call the customer support service in your country.

- To obtain assistance in the U.S.A., Canada, Puerto Rico, or the U.S. Virgin Islands, contact Philips Customer Care Center at **1-866-309-0841**

## Product information

This TV consumes minimal energy in standby mode to minimize environmental impact. The active power consumption is given on the type plate at the back of the TV. The model and serial numbers of your TV can be found on the back and right side of the TV as well as on the packaging.

## Screen care

- Avoid stationary images as much as possible. Stationary images are images that remain on-screen for extended periods of time. Examples include: on-screen menus, black bars and time displays. If you must use stationary images, reduce screen contrast and brightness to avoid screen damage.
- Unplug the TV before cleaning.
- Clean the TV screen and frame with a soft cloth. Never use substances such as alcohol, chemicals or household cleaners on the TV screen.
- Risk of damage to the TV screen! Never touch, push, rub or strike the screen with any object.
- To avoid deformations and color fading, wipe off water drops as soon as possible.

## Environmental care

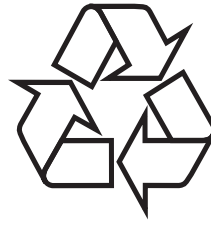

The packaging of this product is intended to be recycled. Contact your local authorities for information about how to recycle the packaging.

### End of life directives



Philips pays a lot of attention to produce environment-friendly products in green focal areas. Your new TV contains materials which can be recycled and reused. At the end of its life, specialized companies can dismantle the discarded TV to concentrate the reusable materials and to minimize the amount of materials to be disposed of. Please ensure you dispose of your old TV according to local regulations.

### Disposal of used batteries

The batteries supplied do not contain the heavy metals mercury and cadmium. Nevertheless, in many areas batteries may not be disposed of with your household waste. Please ensure you dispose of batteries according to local regulations.

## Regulatory notices



### Warning

To reduce the risk of fire or electric shock, this apparatus should not be exposed to rain or moisture. Objects filled with liquids, such as vases, should not be placed on this apparatus.



### Caution

To prevent electric shock, match the wide blade of the plug to the wide slot, fully inserted.

**Do not place the unit on the furniture that is capable of being tilted by a child and an adult leaning, pulling, standing or climbing on it. A falling unit can cause serious injury or even death.**

**This apparatus should not be placed in a built-in installation such as a bookcase or rack unless proper ventilation is provided. Make sure to leave a space of 4 inches (10cm) or more around this apparatus.**

# 3 Your TV

Congratulations on your purchase, and welcome to Philips! To fully benefit from the support that Philips offers, register your product at [www.philips.com/welcome](http://www.philips.com/welcome)

## Side controls and indicators

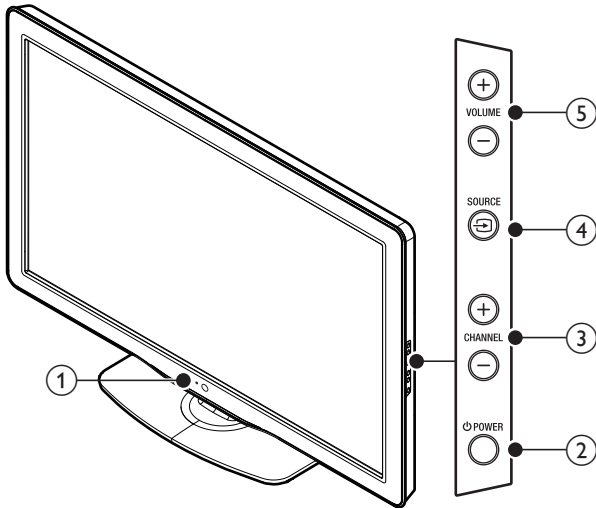

- ① Standby indicator/remote control sensor
- ② **⏻ POWER**  
Switches the TV on or off. The TV is not powered off completely unless it is physically unplugged.
- ③ **CHANNEL +/-**  
Switches to the next or previous channel.
- ④ **SOURCE**   
Selects connected devices.
- ⑤ **VOLUME +/-**  
Increases or decreases volume.

## Remote control

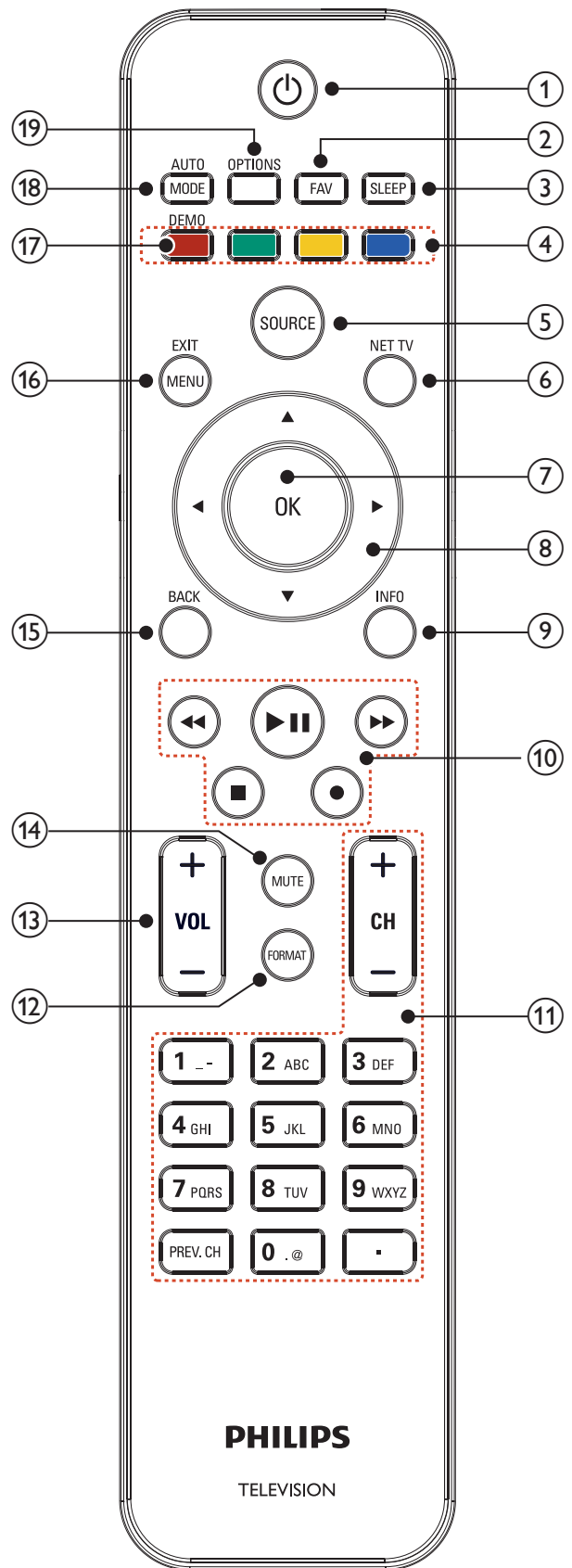

- ① **⏻ (Standby-On)**  
Switches the TV on or off. The TV is not powered off completely unless it is physically unplugged.
- ② **FAV**  
Displays a list of all channels marked as favorite.  
(Includes subchannels)
- ③ **SLEEP**  
Sets a delay after which the TV switches to standby.
- ④ **Color buttons (red/green/yellow/blue)**  
Selects tasks or options.
- ⑤ **SOURCE**  
Selects connected devices.
- ⑥ **NET TV**  
Display the Net TV menu.
- ⑦ **OK**  
Activates a selection or accesses the menu.
- ⑧ **▲▼◀▶ (Navigation buttons)**  
Navigates through the menus.
- ⑨ **INFO**  
Displays information about the TV channel or accessory device.  
The quality and accuracy of the information depends on the broadcaster. You might see a difference in broadcast time if the broadcast is from a different time zone.
- ⑩ **EasyLink buttons**
  - ◀◀ (Backward)  
Searches backward.
  - ▶▶ (Forward)  
Searches forward.
  - ▶|| (Play / Pause)  
Starts, pauses or resumes playback.
  - (Record)  
Starts or stops video recording.
  - (Stop)  
Stops playback.
- ⑪ **CH +/-**  
Switches to the next or previous channel.  
**Number buttons**  
Select a channel, page, setting or input characters.
  - (Dot)  
Press the dot (•) for digital channels.
  - PREV. CH**  
Returns to the previously viewed channel.
- ⑫ **FORMAT**  
Selects a picture format (see 'Changing picture format' on page 19).
- ⑬ **VOL +/-**  
Increases or decreases volume.
- ⑭ **MUTE**  
Mutes or unmutes audio.
- ⑮ **BACK**  
Returns to a previous screen.
- ⑯ **MENU/EXIT**  
Toggles the home menu on or off.
- ⑰ **DEMO**  
Displays the demonstration menu.
- ⑱ **AUTO MODE**  
Cycles through the preset picture and sound setting  
(see 'Using auto mode' on page 20).
- ⑲ **OPTIONS**  
Press to access the most usable items extracted from the main menu.



# 4 Get started

## Supplied accessories

- Remote control
- 2 x AAA, 1.5V batteries
- M4 x 10 double sems screw x 4 (available for 40" and 46" only)
- AC Power cord
- Cable management tie
- User manual
- Quick Start
- Netflix Box-insert

## Mounting base onto TV for 40" and 46"

Applicable to TVs without mounted bases.

1

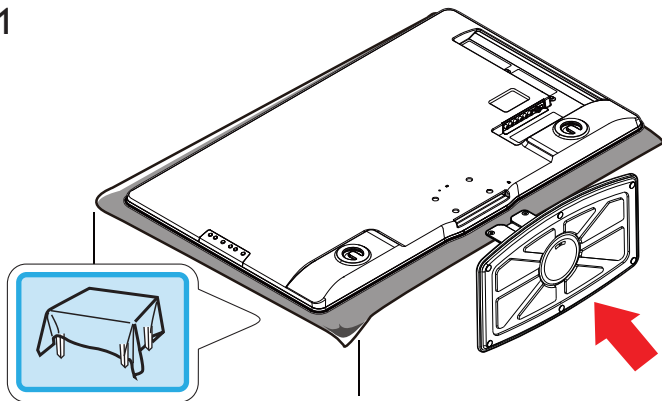

2

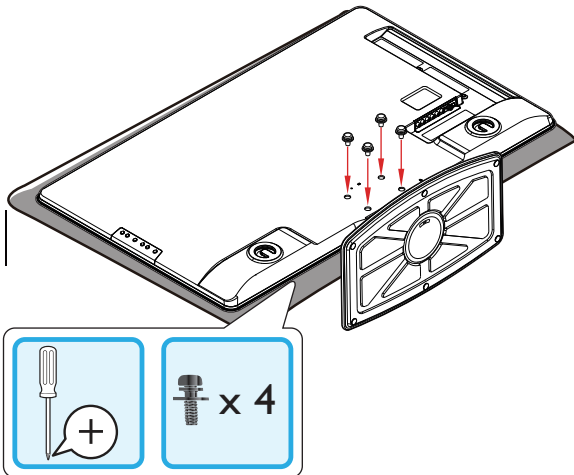

### Note

- To wall mount the TV, refer to the addendum.
- If you lose the screws, please purchase M4x10 Philips head screws at your local store.

## Positioning the TV

### Warning

- Do not insert the AC power cord into the power socket outlet before all the connections are made.
- Large screen TVs are heavy, 2 people are required to carry and handle a large screen TV.
- Before you move the TV, disconnect the cables to prevent breakage.

In addition to reading and understanding the safety instructions, consider the following before positioning your TV:

- Ensure that you always have easy access to the AC power cord or plug to disconnect the TV from the power.
- If the TV is mounted on a swivel base, ensure that no strain is placed on the AC power cord when the TV is swiveled. Strain on the AC power cord can loosen connections.
- The ideal viewing distance for watching TV is three times its screen size.
- Position the TV where light does not fall on the screen.
- Connect your devices before you position the TV.

## Using a Kensington lock

There is a Kensington security slot on the back of the TV. Prevent theft by looping a Kensington lock between the slot and a permanent object, such as a heavy table.

55"/46"

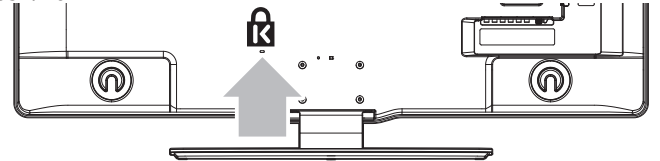

40"

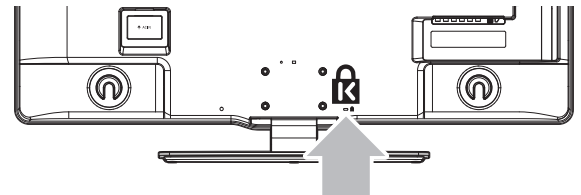

## Adjusting the swivel angle

You can adjust the viewing angle of your TV.

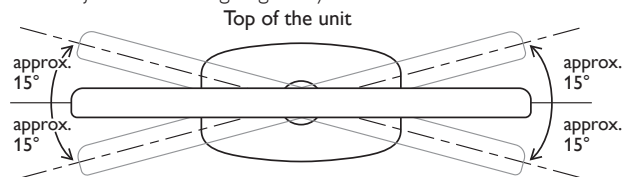

### Caution

- While adjusting the swivel angle of your TV, hold the base firmly to prevent the TV from tipping over and falling down.

## Installing the remote control batteries

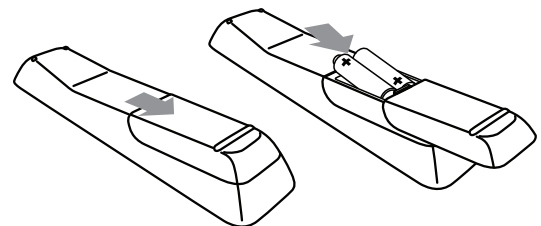

- 1 Slide the battery cover off the back of the remote control.
- 2 Insert the 2 supplied batteries (AAA, 1.5V). Be sure the + and - ends of the batteries line up with the markings inside the case.
- 3 Slide the cover back into position.

### Note

- Remove the batteries if not using the remote control for an extended period of time.

## Connecting the antenna or cable

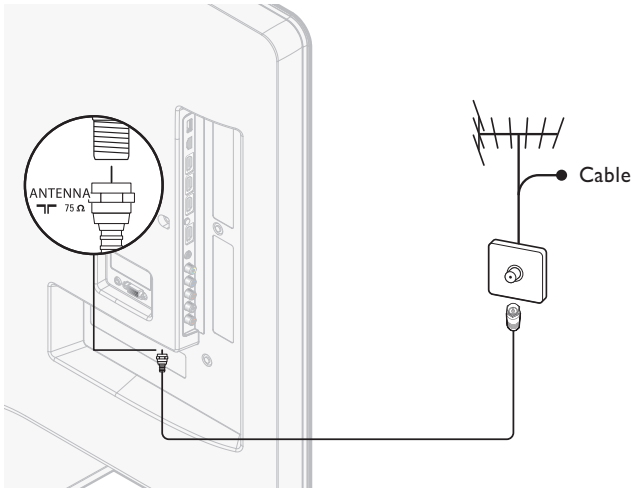

### If you connect to an antenna

Any DTV programs that are broadcast in your area can be received for free through an antenna connection.

Contact your local content provider or your local electronics retailer if you are unsure about what HDTV programs are available in your area.

Broadcasters are transitioning from analog to digital TV. This means that a given broadcaster can have channels available either in analog or in digital, or both analog and digital at the same time.

The TV produces stereo sound only if a stereo signal is broadcast.

### If you connect to a cable

When your TV is connected to the cable socket, you might receive free digital and high definition programs (depending on your cable provider). The channel number for digital and high definition channels includes a dot ".•". For example, 11.1, 46.30, 108.201. Contact your cable provider for more information.

### If you connect to a DBS (Direct Broadcast Satellite)

There are two main DBS systems: DirecTV and DishNetwork. These systems require a separate, proprietary set-top box to decode signals and send them to the TV. The set-top box contains a digital TV tuner for receiving off-air digital broadcasts.

Contact your local DBS provider for more information about the connections and the TV channels.

### If you connect to a set-top box

A cable box or satellite set-top box can be connected to the TV through the following connections:

- ANT
- A/V (Composite Video and Audio)
- YPbPr (Component Video Input)
- HDMI

For information about how to connect a set-top box, see the Quick Start provided.

### If you connect a set-top box through RF IN/OUT

If the TV is connected to a cable box or satellite set-top box via a coaxial connection, set the TV to channel 3 or 4, or to the channel specified by the service provider.

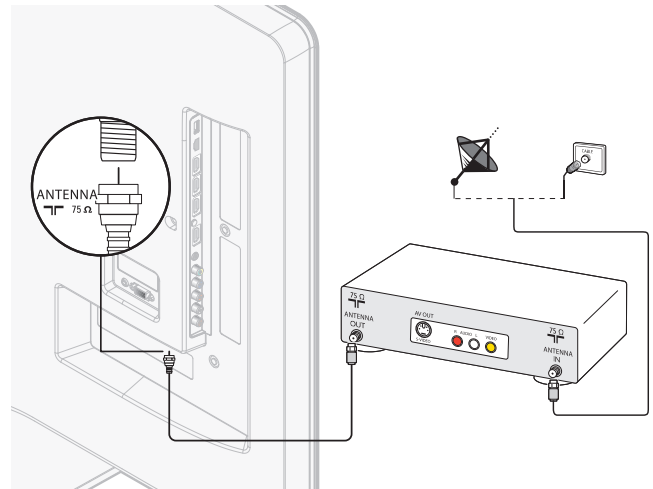

### If you connect a set-top box through HDMI

If the TV is connected to a cable box or satellite set-top box via HDMI, make sure you select the correct HDMI source by using **SOURCE** on this unit's remote control.

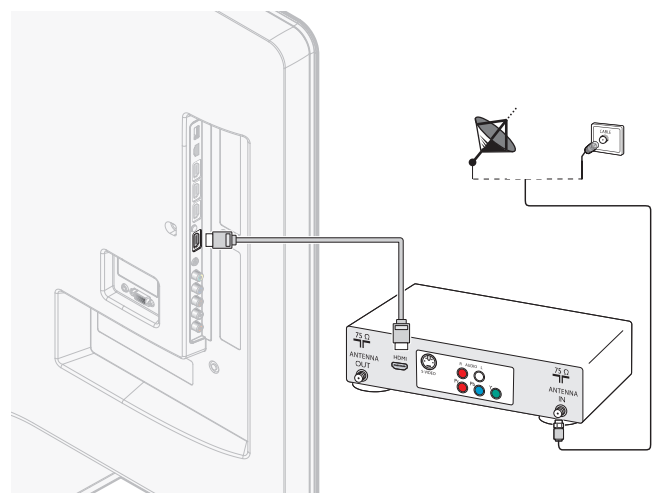

### If you connect a set-top box through component video input

If the TV is connected to a cable box or satellite set-top box via component video input, make sure you select the correct component video source by using **SOURCE** on this unit's remote control.

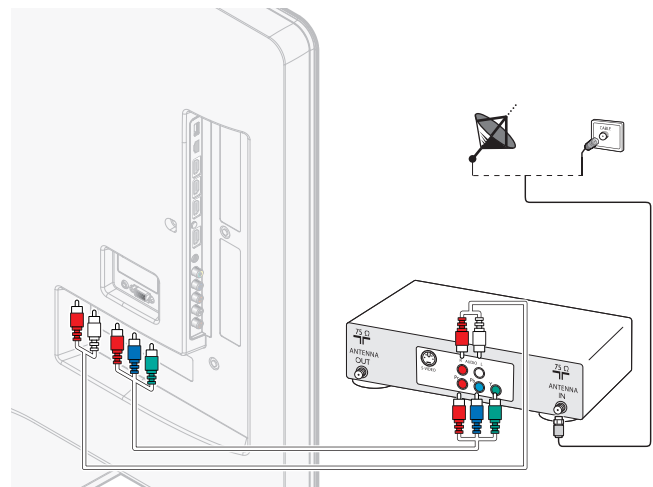

## Managing cables

Route your antenna cable and all other cables through the cable holder at the back of the TV. The holder helps keep your cables tidy and easily manageable.

- 1 Attach the cable holder as illustrated below.

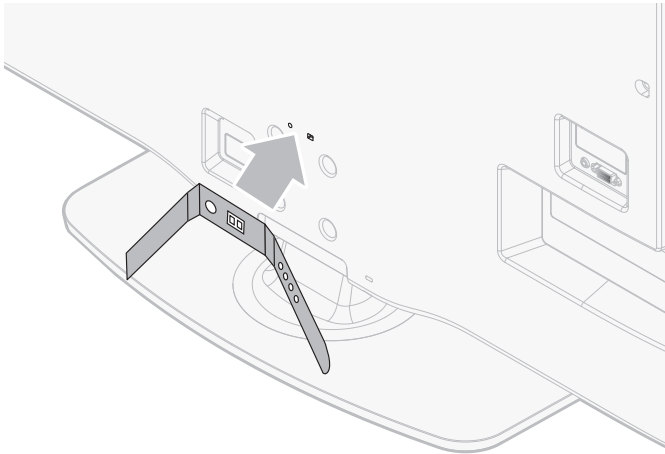

- 2 Keep the cable through this holder to avoid tangle them.

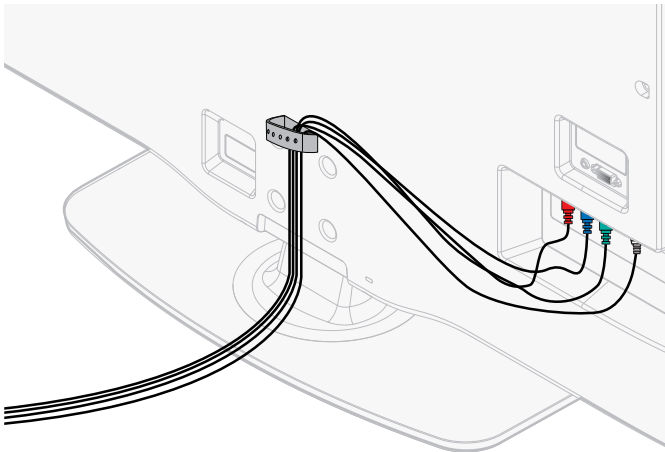

## Connecting the AC power cord

### Warning

- Verify that your power voltage corresponds with the voltage printed at the back of the TV. Do not insert the AC power cord if the voltage is different.

- 1 Locate the power connector at the back of the TV. The location of the power connector varies according to TV model.
- 2 Insert the AC power cord fully into the power connector.
- 3 Connect the AC power cord plug to the power outlet. Ensure that the cord is tightly secured at both ends.

55"/46"

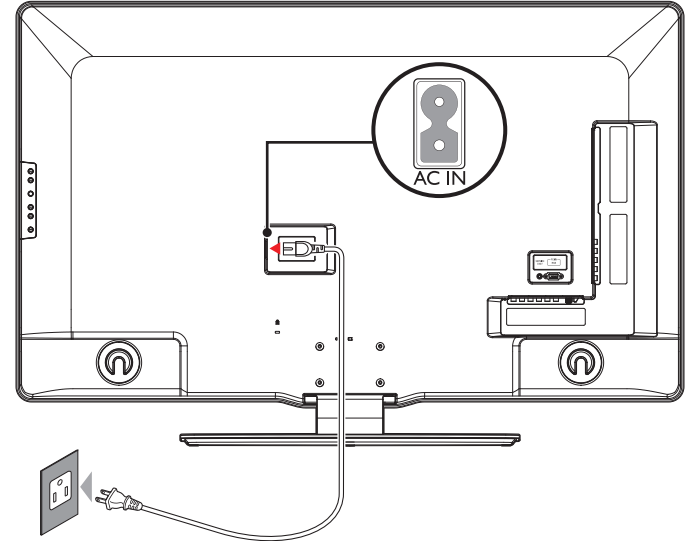

40"

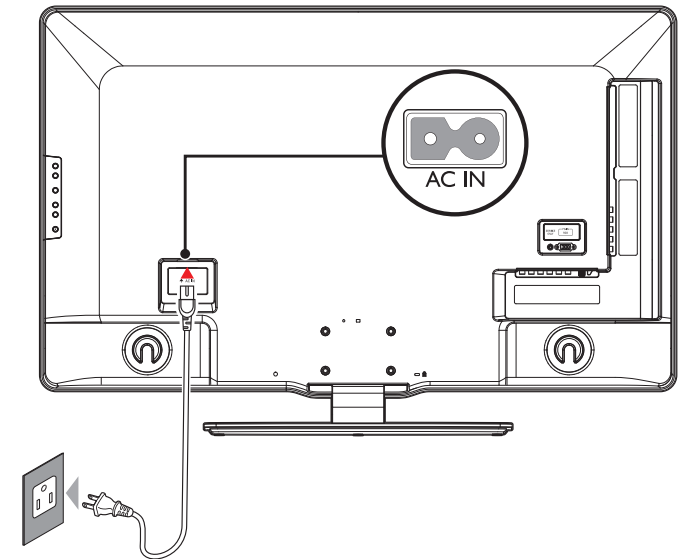

## Disconnect the TV from the power outlet

### Caution

- Pull the AC power cord by the plug; do not pull on the AC power cord.

- 1 Unplug the AC power cord from the power outlet.
- 2 Unplug the AC power cord from the power connector at the back of the TV.

## Switching on and set up the TV

Before you switch on the TV, check that the AC power cord is properly connected. Press **POWER** at the right side of the TV, or press **(Standby-On)** on the remote control. The TV normally takes 25-30 seconds to start up and the following screen appears the first time you turn on the TV.

After you read a welcome screen, follow the on-screen instructions to select your language and complete your TV setup. Installation takes approximately 20 minutes.



Press **▲** or **▼** to select the desired mode for energy saving, then press **OK**.

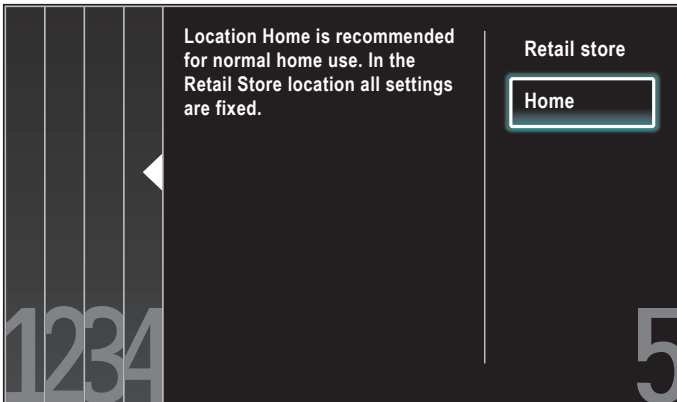

Select **[Retail store]** if you want backlight to be brighter.

Select **[Home]** to reduce the power consumption.

You must set **[Home]**. Otherwise, the settings of picture and sound quality you adjusted will not be memorized after you turn off the unit.

- Select **[Retail store]**, the unit will be set up with predefined setting for retail displays. In this setting, the power consumption may possibly exceed the limited requirement of the ENERGY STAR® qualification.
- Select **[Home]**, the unit is set to maximize the energy efficiency for home setting and it can be adjusted through a choice of picture and sound quality according to your preference.

Press **◀** or **▶** to select **[Start]**, then press **OK** to begin **[Settings assistant]**.

Settings assistant will allow you to customize your picture settings to your personal preference. You will see a series of test pictures where the right side and left side differ. Select the side that is most pleasing to you with the Left/Right buttons.

Cancel

Start

Select **[Picture A]** or **[Picture B]** by pressing **◀** or **▶** that is the most pleasing to you, then press **OK**. You see 5 different pictures to be completed.

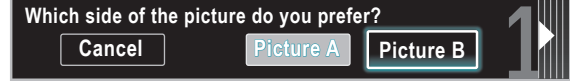

Press **◀** or **▶** to select **[Store]**, then press **OK**.



Press **OK** to finish **[Settings assistant]**.



Press **◀** or **▶** to select **[Finish]**, then press **OK**.

Finish the Setup.

### Note

- If you are not receiving a signal from your cable service, contact the CATV provider.
- If you press **POWER** during autoprogram, an installation will be canceled except the language selection.
- The initial autoprogram function can be executed for either **[Antenna]** or **[Cable]** only once. When you change the connection (Antenna/Cable), set autoprogram again. (Refer to page 30.)

# 5 Use your TV

This section helps you perform basic TV operations.

## Switching your TV on or to standby

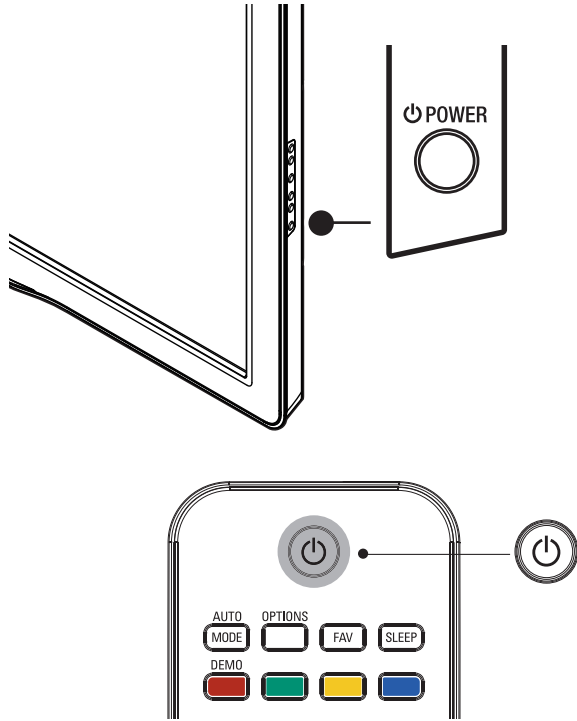

### To switch on

- Press **POWER** at the side of the TV or press **(Standby-On)** on the remote control.

### To switch to standby

- Press **POWER** at the side of the TV or press **(Standby-On)** on the remote control again.

### Note

- Energy consumption contributes to air and water pollution. When the AC power cord is plugged in, your TV consumes energy. Your TV has a very low standby power consumption.

## Switching channels

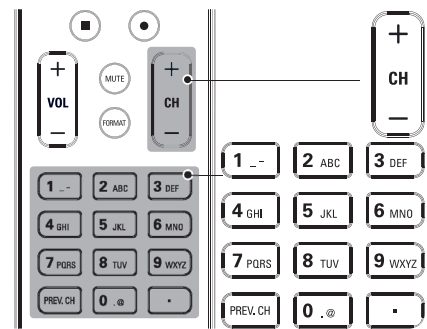
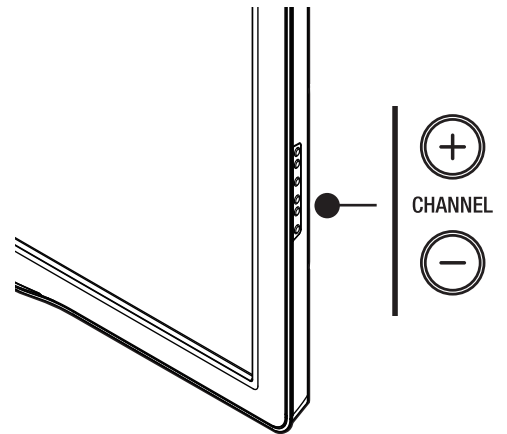

Press **CHANNEL +/-** on the side of the TV. For digital channels, press a number (1 to 999) followed by a dot “.” and then the corresponding sub channel number (1 to 999). e.g. 108.30.

- Press **CH +/-** or enter a number on the remote control.
- Press **PREV. CH** to return to the previously viewed channel.

## Adjusting volume

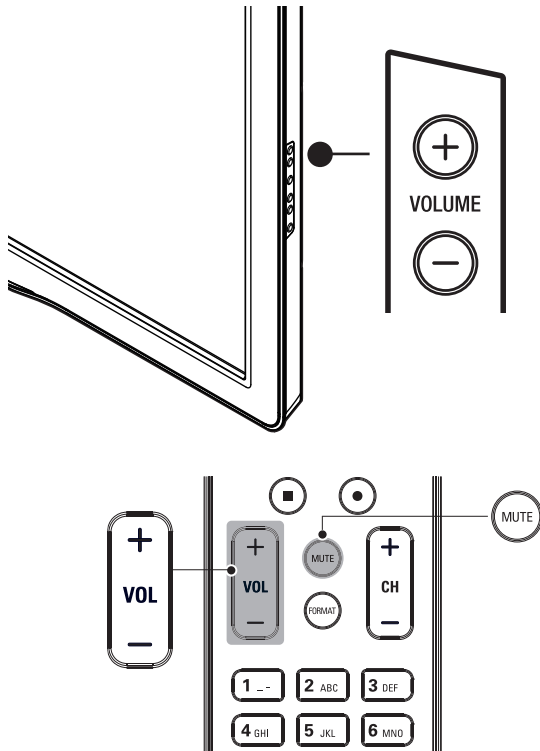

### To increase or decrease volume

- Press **VOL +/-** on the remote control or press **VOLUME +/-** on the side of the TV.

### To mute or unmute sound

- Press **MUTE** on the remote control to mute the sound.
- Press **MUTE** again or **VOL +/-** to recover the original sound.

## Watching channels from a set-top box

### To watch channels from a set-top box

- 1 Switch on the set-top box.
  - ↳ The picture from your set-top box might appear automatically on the TV screen.

- 2 Use the remote control of your set-top box to select channels.  
If the picture does not appear

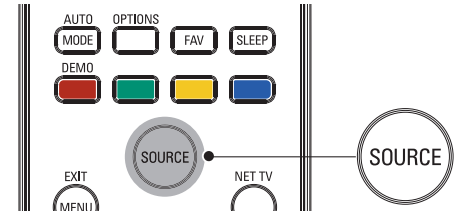

- 1 Press **SOURCE** repeatedly to select the set-top box and wait a few seconds for the picture to appear.
- 2 Use the remote control of your set-top box to select channels.

## Watching connected devices

### To watch connected devices

- 1 Switch on the connected device.
  - ↳ The picture from your connected device might appear automatically on the TV screen.

- 2 Use the remote control of the device to select channels.  
If the picture does not appear

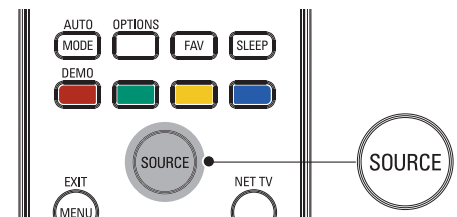

- 1 Press **SOURCE** repeatedly to select the connected device and wait a few seconds for the picture to appear.
- 2 Use the remote control of the device to select channels.

## Watching a Blu-ray Disc

### To watch a Blu-ray Disc

- 1 Insert a Blu-ray Disc into your player.
- 2 Press **▶ (play)** on the remote control of the Blu-ray Disc player to select channels.
  - ↳ The Blu-ray Disc might automatically play on the TV.

### If the picture does not appear

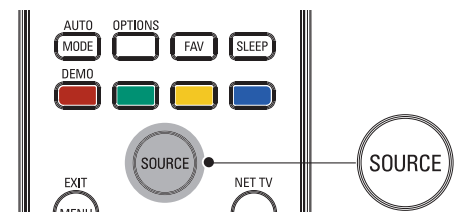

- 1 Press **SOURCE** repeatedly to select the Blu-ray Disc player and wait a few seconds for the picture to appear.
- 2 Use the remote control of the Blu-ray Disc player to play the disc.

# 6 Use more of your TV

## Access TV menus

Menus help you to install channels, change picture and sound settings then access other features.

### Access the home menu

The home menu gives you easy access to connected devices, picture and sound settings as well as other useful features.

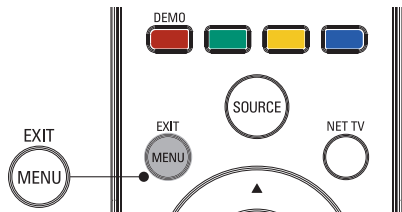

- 1 Press **MENU** on the remote control.

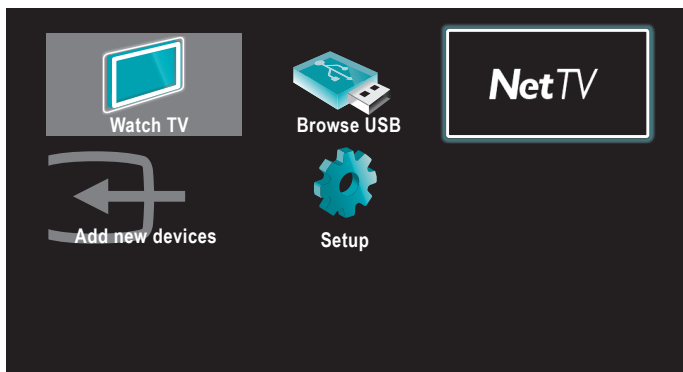

- 2 Use **▲/▼/◀/▶** to select and navigate through one of the following menus.
  - **[Watch TV]** Switches back to the antenna source if another source is selected.
  - **[Browse USB]** Accesses USB menus.
  - **[Net TV]** Access **[NETFLIX]** or **[vTuner]**.
  - **[Add new devices]** Adds new devices to the home menu.
  - **[Setup]** Accesses menus that allow you to change picture, sound and other TV settings.
- 3 Press **OK** to confirm your choice.
- 4 Press **MENU** to exit.



Tip

- After selecting **[Add new devices]**, follow the on-screen instructions to select the correct device and connector.

### Lock or unlock your device from the home menu

This section describes how to lock or unlock specified device.

- 1 Press **MENU** on the remote control.
- 2 Use **▲/▼/◀/▶** to select a device to lock or unlock.
- 3 Press **OPTIONS** on the remote control.
- 4 Use **▲** or **▼** to select **[Device lock]** or **[Device unlock]**, then press **OK**.
  - If device lock is unlocked, **[Device lock]** will be displayed.
  - If device lock is locked, **[Device unlock]** will be displayed.
  - When device lock is locked, **🔒** will be displayed at the top right of the device icons.
- 5 Enter your PIN (see 'Setting your PIN' on page 22).
  - Once you have set PIN, PIN input menu does not appear after the unit is turned on.

### Enable or disable RC key forwarding from the home menu

This section describes how to enable or disable RC key forwarding for a particular device.

- 1 Press **MENU** on the remote control.
- 2 Use **▲/▼/◀/▶** to select a device to enable or disable RC key forwarding.
- 3 Press **OPTIONS** on the remote control.
- 4 Use **▲** or **▼** to select **[Enable RC key forwarding]** or **[Disable RC key forwarding]**, then press **OK**.
  - If RC key forwarding is set to off, **[Enable RC key forwarding]** will be displayed. If RC key forwarding is set to on, **[Disable RC key forwarding]** will be displayed.
  - When you set RC key forwarding on, **🔑** will be displayed at the top left of the device icons.



Note

- This function is available only when your devices are connected to this unit through HDMI cables and assigned to an HDMI port (HDMI1 to HDMI4) with **[Add new devices]** in the home menu.

## Netflix operations

With this unit, you can watch movies and TV episodes streamed instantly from Netflix via the Internet. In order to use this feature, you must visit the following website on your PC and become a Netflix member: [www.netflix.com/Philips](http://www.netflix.com/Philips)

### Before activating the connection to Netflix

After creating a Netflix account at [www.netflix.com/Philips](http://www.netflix.com/Philips), follow the following procedure before activating the connection to Netflix.

- 1 Connect this unit to the Internet.  
(See 'Connecting the TV to the internet using an Ethernet cable' on page 36.)
- 2 Set up the necessary network connection settings.  
(See 'Network' on page 26.)

### Activating the connection to Netflix

In order to watch movies and TV episodes streamed instantly from Netflix via the Internet, you must activate the connection between this unit and your Netflix account.

- 1 Press **NET TV** on the remote control and then use **▲/▼/◀/▶** to select **[NETFLIX]**.
  - Netflix welcome screen will appear.
  - For the first time only, **[Network Service Disclaimer]** screen will appear. After confirming the content, use **◀/▶** to select **[Agree]**, then press **OK**.
- 2 Use **▲/▼** to select **[yes - activate instant streaming from Netflix]**, then press **OK**.
  - Activation screen with the activation code will appear.



- 3 On your PC, visit [www.netflix.com/activate](http://www.netflix.com/activate) and log into your account.
  - The entry screen of activation code will appear on your PC screen.
- 4 Enter the activation code which is displayed on the TV screen.
  - The Instant Queue will appear. The connection to Netflix is successfully made.
  - To browse the Instant Queue and watch movies, skip to step 2 in 'Watching streaming movies' on page 15.

### Note

- Netflix is available only in the United States.
- You cannot create a Netflix account on this unit.
- If newer version of software is required, software update screen may appear after selecting **[NETFLIX]** in step 2.  
(For software update, see 'Upgrade your TV software' on page 31.)
- You can deactivate the connection to Netflix by setting the **[Deactivation]** to **[Yes]**.  
(See 'Netflix connection' on page 27.)
- The screen image of Netflix may change after updating the firmware.
- For questions regarding the Netflix service, visit [www.netflix.com/Help](http://www.netflix.com/Help)
- When you contact the Netflix customer service, you may be asked for the ESN number, which is a serial number to identify this unit by Netflix. You can check the ESN number on the **[ESN]** screen. (See 'Netflix connection' on page 27.)

## Watching streaming movies

After you set up the connection to Netflix, you can browse the Instant Queue and watch movies on your TV.

- 1 Press **NET TV** on the remote control and then use **▲/▼/◀/▶** to select **[NETFLIX]**.
  - The Instant Queue will appear.
- 2 Use **◀/▶** to select the desired movie or TV episode, then press **▶/||** to start playback.

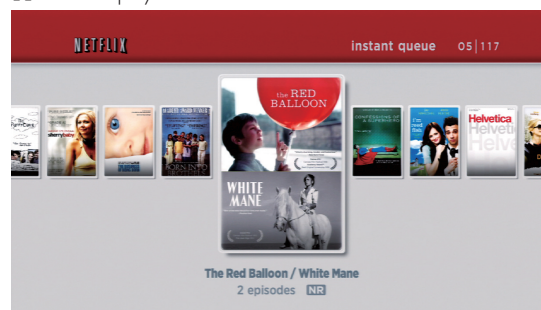

- After loading, playback of the selected movie or TV episode will start.
  - To stop the playback, press **■**.
  - To go back to the Instant Queue, press **Color buttons (red)**.
- 3 Press **MENU** to exit.

### Tip

#### About the Instant Queue

- Instant Queue is the list of movies and TV episodes you add on the Netflix website. ([www.netflix.com](http://www.netflix.com)) You can manage the movies and TV episodes in your Instant Queue from the Netflix website on your PC.
- You cannot add movies or TV episodes to your Instant Queue on this unit.
- You can remove movies or TV episodes from the Instant Queue on this unit.

### Note

- The picture quality differs depending on the speed of your Internet connection at the time of loading.



## Enjoying internet radio with vTuner

With this unit, you can enjoy Internet radio with vTuner via the Internet. In order to listen to Internet radio, you must connect this unit to the Internet.

For the network connection, see 'Connecting the TV to the internet using an Ethernet cable' on page 36.

For the network setup, see 'Network' on page 26.

### Internet radio playback

After you set up the network connection, follow the following procedure to listen to Internet radio.

- 1 Press **NET TV** on the remote control and then use **▲/▼/◀/▶** to select **[vTuner]**.
  - Category list will appear.
  - For the first time only, **[Network Service Disclaimer]** screen will appear. After confirming the content, use **◀/▶** to select **[Agree]**, then press **OK**.
- 2 In the category list, use **▲/▼** to select the desired category, then press **OK**.

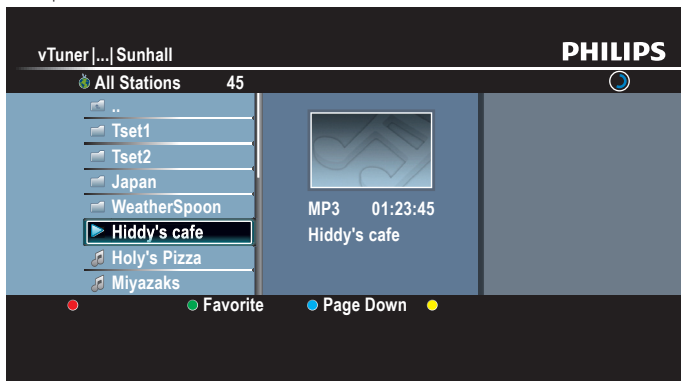

- Station/folder list of selected category will appear.
- For **[Location]** and **[Genre]**, use **▲/▼** to select the desired location or genre after selecting the category, then press **OK**.

#### **[Recently Played]**

List of stations which are recently played

#### **[Favorites]**

List of your favorite radio stations

#### **[My Added Stations]**

List of stations which are added on vTuner website (This category will appear only after you add stations on vTuner website.)

#### **[Location]**

List of stations categorized by location

#### **[Genre]**

List of stations categorized by genre

#### **[New Stations]**

List of new stations

#### **[Most Popular Stations]**

List of popular station

#### **[Get access code]**

Displays the access code, which will be required when creating a vTuner account on your PC

#### **[Reset]**

Removes all stations/folders in **[Recently Played]**, **[Favorites]** and **[My Added Stations]**

- 3 In the station/folder list, use **▲/▼** to select the desired station, then press **OK**.
  - After loading, playback of the selected station will start.
  - If you select a folder, use **▲/▼** to select the desired station in the next hierarchy, then press **OK**.
  - To stop playback, press **■**.
  - To go back to the previous or next hierarchy, press **◀/▶**.

e.g.) Location

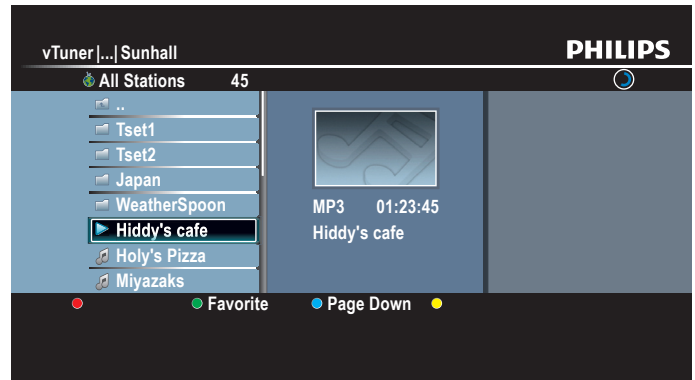

- 4 Press **MENU** to exit.

#### **Note**

- This unit cannot play back stations with audio format other than MP3 and WMA.
- For some stations, playback is not available even if the audio format is displayed as MP3 or WMA.
- Internet radio service may not be fully available with narrowband Internet connection. (e.g. 56k modem) When listening to Internet radio, use broadband Internet connection. (For details, contact your Internet service provider.)
- Depending on the bit rate of a station or the network environment, it may take a while to complete loading the station or playback may not be available.
- The streaming audio may be interrupted during playback, when the vTuner server is busy.
- Some stations cannot be displayed in the list, depending on the network environment.
- If the loading time of a station exceeds 3 minutes, the loading will be canceled.
- The order of station / folder in the list depends on the information from vTuner server and may change without notice.

## Guide to the playback screen

e.g.) Location

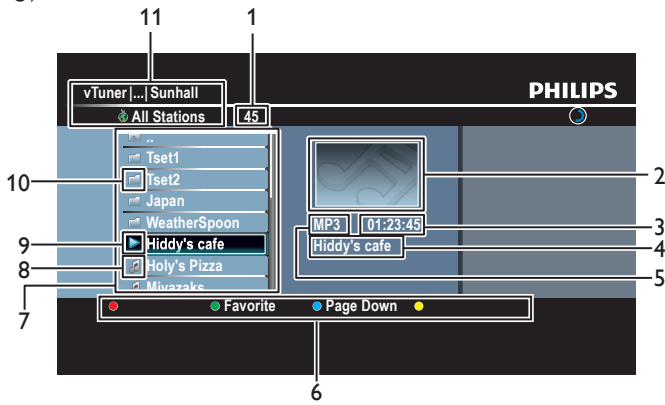

- 1 Number of stations / folders in the current hierarchy
- 2 Image
- 3 Elapsed playing time of the current station
- 4 Current station / folder name
- 5 Audio format of the current station
- 6 **Color buttons (red / green / yellow / blue) guide**
- 7 Station / folder list
- 8 Station icon
- 9 Playback status
- 10 Folder icon
- 11 Directory

### Add to favorite list

You can add your favorite stations to **[Favorites]** in the category list. To add your favorite stations, follow the following procedure.

- 1 Follow steps 1 to 3 in 'Internet radio playback' on page 16.
- 2 Use ▲ / ▼ to select the station you want to add to **[Favorites]**, then press **Color buttons (green)**.
  - The selected station is added to **[Favorites]** folder.
  - Confirmation message will appear.
  - If you select a folder, use ▲ / ▼ to select the desired station in the next hierarchy, then press **Color buttons (green)**.
- 3 Press **OK**.

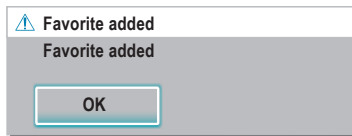

- 4 Press **MENU** to exit.

### Note

- You can also add your favorite stations to **[Favorites]** on your PC. To add your favorite stations on your PC, visit <http://go2service.vtuner.com/ph/> and create a vTuner account with the access code, which you can check from the category list. (See 'Internet radio playback' on page 16.)
- You can change folder names or order of lists in your vTuner page on the Internet.
- **[My\_Favorite]** folder will appear after you add a station to **[Favorites]** on this unit. (Your favorite station will also be added to **[My\_Favorite]** folder.)

### Remove from favorite list

- 1 Follow steps 1 to 2 in 'Internet radio playback' on page 16.
- 2 Use ▲ / ▼ to select **[Favorites]**, then press **OK**.
- 3 Use ▲ / ▼ to select the station you want to remove from **[Favorites]**, then press **Color buttons (green)**.
  - Confirmation message will appear.
- 4 Use ◀ / ▶ to select **[Yes]**, then press **OK**.
  - The selected station is removed from **[Favorites]** folder.

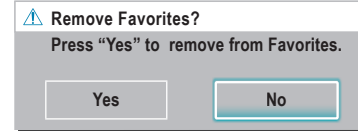

- 5 Press **MENU** to exit.

### Add stations on the vTuner website

On the vTuner website, you can add stations which are not in the vTuner station list. To add stations, you must visit <http://go2service.vtuner.com/ph/> and create a vTuner account with the access code for this unit.

- 1 Follow steps 1 to 2 in 'Internet radio playback' on page 16.
- 2 Use ▲ / ▼ to select **[Get access code]**, then press **OK**.
  - The access code for this unit will be displayed. Please take a note of the access code. (This access code will be required when creating a vTuner account.)
- 3 On your PC, visit <http://go2service.vtuner.com/ph/> and create your vTuner account.
  - Follow the instructions given on the PC screen.
- 4 Add stations by following the instructions given on the PC screen.
  - The stations will be added to **[My Added Stations]**.

### Reset the station list

You can remove all stations / folders in **[Recently Played]**, **[Favorites]** and **[My Added Stations]**.

- 1 Follow steps 1 to 2 in 'Internet radio playback' on page 16.
- 2 Use ▲ / ▼ to select **[Reset]**, then press **OK**.
- 3 Use ▲ / ▼ to select **[Yes]**, then press **OK**.
  - All stations / folders in **[Recently Played]**, **[Favorites]** and **[My Added Stations]** are removed.
- 4 Press **MENU** to exit.

## Changing picture and sound settings

You must set **[Home]** in **[Location]** (refer to page 26). Otherwise, the settings you adjusted will not be memorized after you turn off the unit.

### Changing picture settings

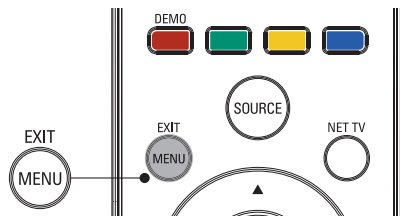

- 1 Press **MENU** on the remote control.
- 2 Use **▲/▼/◀/▶** to select **[Setup] > [Picture]**.

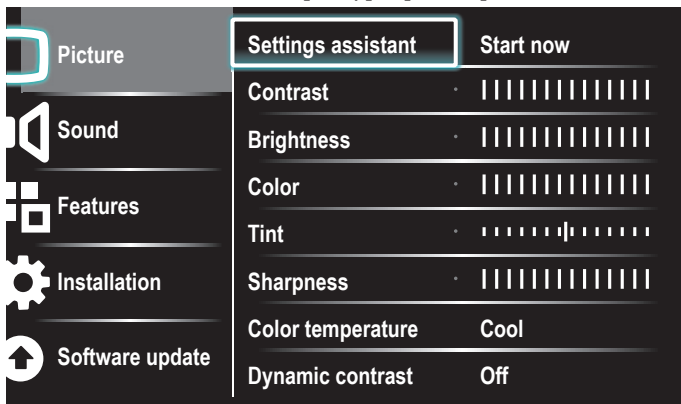

- 3 Use **▲/▼/◀/▶** to select one of the picture settings, and press **OK** to enter the setting.
- 4 Adjust the picture quality.  
The following picture settings can be configured. Depending on the format of the picture source, some picture settings are not available.

Setting items	Description	
Settings assistant	Use <b>[Settings assistant]</b> to guide you through the best picture and sound settings.	
Contrast	Adjusts the intensity of bright areas, keeping dark areas unchanged.	
Brightness	Adjusts the intensity and details of dark areas.	
Color	Adjusts color intensity.	
Tint	Adjusts the color balance in an image.	
Sharpness	Adjusts the level of sharpness in image details.	
Color temperature	Cool	More blue tones.
	Normal	Standard tones.
	Warm	More orange tones.
Dynamic contrast	Off	Sets Dynamic contrast to off.
	On	Automatically enhances contrast in an image.
Digital Natural Motion	Off	Sets Digital Natural Motion to off.
	Minimum	Makes an image smoother.
	Maximum	Makes an image smoothest.
Noise reduction	Off	Sets Noise reduction to off.
	On	Reduces noise in an image.
MPEG artifact reduction	Off	Sets MPEG artifact reduction to off.
	On	Reduces a blockiness and a blurriness and judder by digital filter.

Setting items	Description	
Color enhancement	Off	Sets Color enhancement to off.
	On	Makes colors more vivid bright colors.
Active control	Off	Sets Active control to off.
	On with Light Sensor	Adjusts backlight for the best picture quality by dynamically adjusting the backlight intensity in accordance with lighting condition in the room.
	On without Light Sensor	Adjusts backlight for best picture quality based on the incoming video signal.
Picture format	Automatic	Refer to 'Summary of picture formats' on page 19.
	Super zoom	
	4:3	
	Movie expand 14:9	
	Movie expand 16:9	
	Wide screen	
Mode selection	PC	Turns off image enhancement features which makes the TV to act purely as a monitor.
	HDTV	Enables image enhancement features to improve picture quality.
Auto adjustment	The horizontal/vertical position, clock and phase of the PC screen are automatically adjusted.	
Clock	Setting to stabilize the PC screen.	
Phase	Setting to improve the clarity of the PC screen.	
Horizontal shift	Adjusts the horizontal position of the picture for PC screen.	
Vertical shift	Adjusts the vertical position of the picture for PC screen.	

- 5 Press **MENU** to exit.

#### Note

- **[Mode selection]** will not be displayed when incoming signals are other than 720x480p 60Hz, 1280x720p 60Hz and 1920x1080p 24/30/60Hz.

## Changing picture format

- 1 Press **FORMAT** on the remote control.

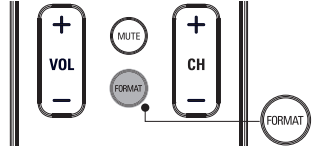

- 2 Use **▲** or **▼** to select a picture format and press **OK** to confirm your choice.

## Summary of picture formats

Display modes can be selected when the broadcasting station is sending 16:9 or 4:3 video signal. And 3 types of display modes can be selected for PC input signal.

For 16:9 (480i, 480p, 720p) video signal / 4:3 (720p) video signal

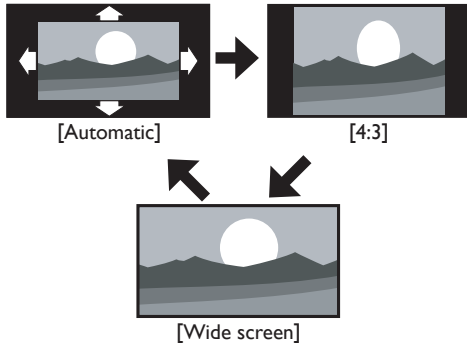

### Automatic

Enlarges the picture automatically to best fit the screen. The subtitles remain visible.

### 4:3

Display a 16:9 picture at a 4:3 size; the picture is shortened horizontally. Sidebars appear on both edges of the screen.

### Wide screen

Display a picture that is stretched horizontally and vertically.

For 16:9 (1080i, 1080p) video signal / 4:3 (1080i, 1080p) video signal

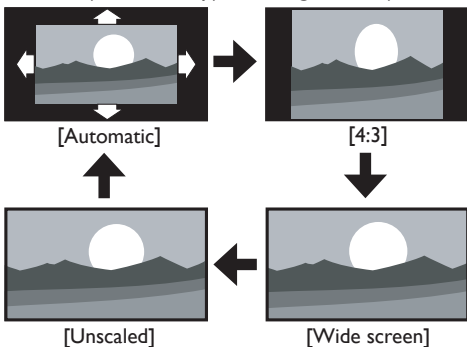

### Automatic

Enlarges the picture automatically to best fit the screen. The subtitles remain visible.

### 4:3

Display a 16:9 picture at a 4:3 size; the picture is shortened horizontally. Sidebars appear on both edges of the screen.

### Wide screen

Display a picture that is stretched horizontally and vertically.

### Unscaled

Display a 16:9 picture at its original size.

For 4:3 (480i, 480p) video signal

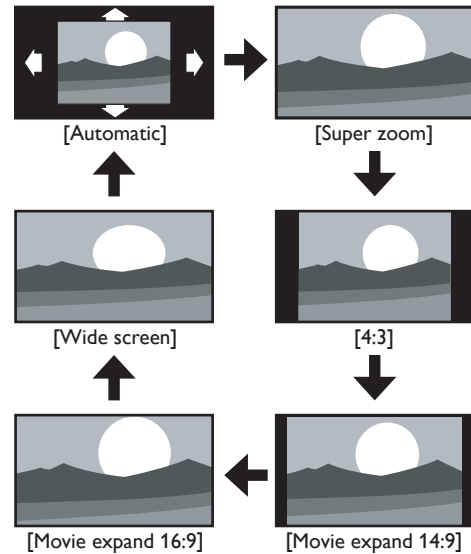

### Automatic

Enlarges the picture automatically to best fit the screen. The subtitles remain visible.

### Super zoom

Display a 4:3 picture at a 16:9 size; the picture is stretched horizontally and vertically and its left and right edges are enlarged. This crops out the top and bottom of the picture.

### 4:3

Display a 4:3 picture at its original size. Sidebars appear on both edges of the screen.

### Movie expand 14:9

Display a 4:3 picture at a 14:9 size; the picture is stretched horizontally and vertically. This crops out the top and bottom of the picture. Sidebars appear on both edges of the screen.

### Movie expand 16:9

Display a 4:3 picture at a 16:9 size; the picture is stretched horizontally and vertically. This crops out the top and bottom of the picture.

### Wide screen

Display a picture that is stretched out of proportion to fill the screen.

For PC input signal

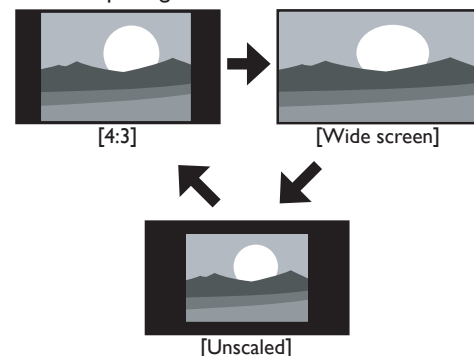

### 4:3

Display a proportionately stretched picture. Sidebars appear on both edges of the screen.

### Wide screen

Display a picture that is stretched out of proportion to fill the screen.

### Unscaled

Display a picture in its original size.

## Using your TV as a PC monitor

Use a VGA connector to connect a PC to your TV. For sound, add an audio cable with a stereo mini jack.

### ! Caution

- Before you connect your PC, set the PC monitor refresh rate to 60Hz.

## Supported screen resolutions

The following screen resolutions are supported in PC mode:

Resolution	Refresh rate
640×480	60Hz
800×600	60Hz
1024×768	60Hz
1280×768	60Hz
1360×768	60Hz
1440×900	60Hz
1280×1024	60Hz
1400×1050	60Hz
1680×1050	60Hz
1920×1080	60Hz

## Changing sound settings

- 1 Press **MENU** on the remote control and then use **▲/▼/◀/▶** to select **[Setup] > [Sound]**.

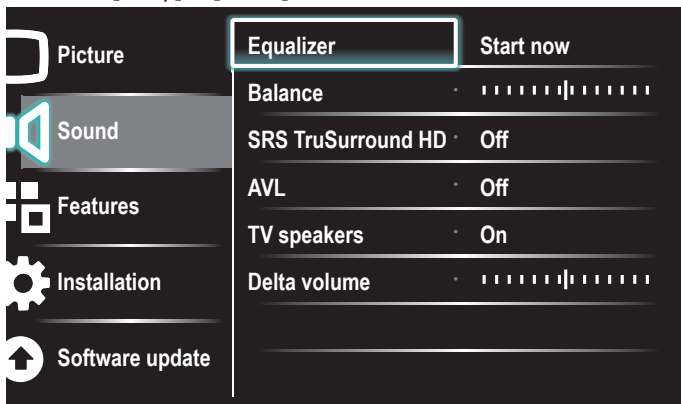

- 2 Use **▲/▼/◀/▶** to highlight a sound setting and then press **OK** to select the setting.
- 3 Adjust the following items.  
The following sound settings can be configured. Depending on the sound source, some sound settings are not available.

Setting items	Description	
Equalizer	Adjust tone quality for each frequency.	
Balance	Adjusts the balance of the right and left speakers to best suit your listening position.	
Digital audio language	Available for digital channels only, when multiple languages are broadcast. Lists available audio languages.	
Alternate audio	Main	Available for analog channels only when a main and second audio program (SAP) is broadcast. Select the main audio program.
	SAP	Available for analog channels only when a main and second audio program (SAP) is broadcast. Select the second audio program.
Mono/Stereo	Mono	Outputs mono-audio.
	Stereo	Outputs stereo-audio.

Setting items	Description		
SRS TruSurround HD	Off	Sets SRS TruSurround HD to off.	
	On	Selects available modes for surround sound.	
AVL (Auto Volume Leveling)	Off	Sets AVL to off.	
	On	Reduces sudden changes in volume, for example, during commercials or when switching channels.	
TV speakers	Off	The sound will not be output from the unit's speakers.	
	On	The sound will be output from the unit's speakers.	
	Speakers EasyLink	You can control audio output from your connected EasyLink Compliant Devices with <b>VOL +/-</b> by using this unit's remote control.	
Delta volume	If a channel or input device is:	Too Loud	Navigate to that channel or input device and set a negative delta volume level as per your personal preferences.
		Too Soft	Navigate to that channel or input device and set a positive delta volume level as per your personal preferences.

- 4 Press **MENU** to exit.

### ≡ Note

- **[Master EasyLink]** must be activated in the **[Preferences]** menu to make the **[TV Speakers]** menu available when you select **[On]** or **[Speakers EasyLink]**.

## Using auto mode

- 1 Press **AUTO MODE** to set your TV to a predefined picture and sound setting.
- 2 Use **▲** or **▼** to select one of the following settings:
  - **[Personal]**: The customized settings you defined by using the **[Picture]** menu.
  - **[Sports]**: Vivid picture settings and clear sound for high action.
  - **[Standard]**: For normal TV viewing.
  - **[Movie]**: Brilliant picture settings for a cinematic experience.
  - **[Game]**: Optimized for PCs, games consoles and playstations.
  - **[Internet Video]**: Optimized for low bitrate internet video.
  - **[Power Saver]**: Eco TV settings for lower power consumption.

## Create and use lists of favorite channels

You can create lists of your preferred TV channels and radio stations so that you can find those channels easily.

### Select a list of favorite channels

- 1 Press **FAV** on the remote control.

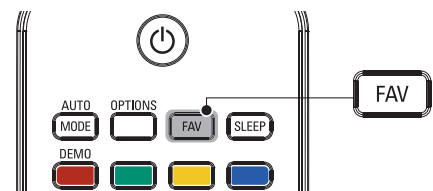

↳ Your lists of favorite channels are displayed.

- 2 Use **▲** or **▼** to highlight a list, and then press **OK** to select the list.

## Create or edit a list of favorite channels

- 1 Press **FAV** on the remote control to display your lists of favorite channels.
- 2 Use **▲** or **▼** to highlight a list, and then press **OK** to select the list.
- 3 Press **OPTIONS** to enter edit mode.  
↳ A list of channels is shown.
- 4 Use **▲** or **▼** to highlight a channel.
- 5 Press **OK** to select or deselect the highlighted channel.  
↳ The channel is added to or removed from the list of favorite channels.
- 6 Press **MENU** to exit.

## Switch to one of the channels on a list

- 1 Press **OK** on the remote control to display the last list that you selected.
- 2 Use **▲** or **▼** to highlight a channel.
- 3 Press **OK** to select the channel.  
↳ The TV switches to that channel.



Tip

- Press **CH +/-** to select channels in a list or press the numeric keys to select channels that are not in a list.

## Setting the clock

You can set the time on your TV.

### Setting the time automatically

Some digital channels transmit the time. For these channels, you can set the time automatically and choose which channel to read the time from.

- 1 Press **MENU** on the remote control and then use **▲/▼/◀/▶** to select **[Setup] > [Installation] > [Clock] > [Auto clock mode]**.
- 2 Select **[Automatic]** and then press **OK** to confirm your choice.
- 3 Select the channel from which the TV reads the time.
  - Use **▲** or **▼** and then press **OK** to enter the menu for **[Auto clock channel]**.
  - Use **▲** or **▼** to highlight a channel.
  - Press **OK** to confirm your choice.
- 4 (Optional) Select the time zone.
  - Use **▲** or **▼** and then press **OK** to enter the menu for **[Time zone]**.
  - Use **▲** or **▼** to highlight the time zone.
  - Press **OK** to confirm your choice.
- 5 (Optional) Set daylight saving.
  - Use **▲** or **▼** and then press **OK** to enter the menu for **[Daylight saving]**.
  - Use **▲** or **▼** to highlight **[Automatic]** or **[Off]**.
  - Press **OK** to confirm your choice.
- 6 Press **MENU** to exit.

## Setting the time manually

- 1 Press **MENU** on the remote control and then use **▲/▼/◀/▶** to select **[Setup] > [Installation] > [Clock] > [Auto clock mode]**.
- 2 Select **[Manual]**, and then press **OK** to confirm your choice.
- 3 Use **▲** or **▼** to select **[Time]** and then press **OK** to set the time. Use the format HH:MM. Select **[AM]/[PM]** for morning or afternoon.
- 4 Press **BACK** to confirm your choice.
- 5 Use **▲** or **▼** and then press **OK** to enter the menu for **[Day]**.
- 6 Use **▲** or **▼** to select the day.
- 7 Press **OK** to confirm your choice.
- 8 Press **MENU** to exit.

## Closed caption

Closed captioning is an assistive technology that allows persons with hearing disabilities to access television programming. Closed captioning displays the audio portion of programming as text superimposed over the video.



Note

- Closed caption will not be displayed when you are using an HDMI connection.
- The captions do not always use correct spelling and grammar. Not all TV programs and product commercials include closed caption information. Refer to your area TV program listings for the TV channels and times of closed caption shows. The captioned programs are usually noted in the TV listings with service marks such as **[CC]**.

## Display captions

- 1 Press **MENU** on the remote control and then use **▲/▼/◀/▶** to select **[Setup] > [Features] > [Caption settings] > [Closed captions]**.
- 2 Press **▲** or **▼** to select **[On]**, **[Off]** or **[On during mute]**, and press **OK** to confirm your choice.
- 3 Press **MENU** to exit.

DTV

## Selecting DTV caption services

- 1 Select a caption service for digital channels:
  - Press **MENU** on the remote control and then use **▲/▼/◀/▶** to select **[Setup] > [Features] > [Caption settings] > [Digital caption service]**.
  - Use **▲** or **▼** to select one of the listed caption services, and then press **OK** to confirm your choice.

CS-1 to CS-6

Select one of these before changing any other item in **[Caption settings]** menu. Choose **[CS-1]** under normal circumstances.

- 2 Press **MENU** to exit.

## Selecting how captions are displayed

You can choose the size, font, color, background and other characteristics of the caption text.

- 1 Press **MENU** on the remote control and then use **▲/▼/◀/▶** to select **[Setup] > [Features] > [Caption settings] > [Digital caption options]**.
- 2 Use **▲** or **▼** to highlight an option for digital captions, and press **OK** to select the option.
- 3 Use **▲** or **▼** to highlight a setting for the option, and press **OK** to confirm your choice.
- 4 Press **MENU** to exit.

## Difficulties viewing closed captions on DTV programming

If you have difficulties viewing closed captions on DTV programming, including HDTV, received from your subscription television provider, you should:

- consult any consumer information and manuals/guides on closed captions for DTV programming provided by your subscription television provider;
- ensure that the captioning function on your set-top box, if applicable, is turned on; and,
- ensure that the captioning function on your DTV is turned on.

If you are still unable to view closed captions on DTV programming, you should contact your subscription television provider for assistance.

### TV

## Selecting caption services

- 1 Select a caption service for analog channels:
  - Press **MENU** on the remote control and then use **▲/▼/◀/▶** to select **[Setup] > [Features] > [Caption settings] > [Caption service]**.
  - Use **▲** or **▼** to select one of the listed caption services, and press **OK** to confirm your choice.
- 2 Press **MENU** to exit.

### Note

- Not all caption services are used by a TV channel during the transmission of a closed caption program.

## Summary of caption services

Service	Description
CC-1 and T-1;	are the primary caption and text services. The captioning or text is displayed in the same language as the program's dialogue (up to 4 lines of script on the TV screen, where it does not obstruct relevant parts of the picture).
CC-3 and T-3;	serve as the preferred data channels. The captioning or text is often a secondary language.
CC-2, CC-4, T-2 and T-4;	are rarely available and broadcasters use them only in special conditions, such as when <b>[CC-1]</b> and <b>[CC-3]</b> or <b>[T-1]</b> and <b>[T-3]</b> are not available. <ul style="list-style-type: none"><li>• There are 3 display modes according to programs: <b>Paint-on mode:</b> Displays input characters on the TV screen immediately. <b>Pop-on mode:</b> Once characters are stored in memory, they are displayed all at once. <b>Roll-up mode:</b> Displays the characters continuously by scrolling (max. 4 lines).</li></ul>

## Sleeptimer

Sleeptimer switches the TV to standby after a pre-defined period of time. You can always switch off your TV earlier or reset the sleeptimer during the countdown.

- 1 Press **SLEEP** to set the sleeptimer. (Also, you can set the sleeptimer in **[Features]** menu.)
- 2 Use **SLEEP** or **◀** or **▶** repeatedly to change the amount of time until shut off.

You can set your unit to turn off after a set period of time (from 0 to 180 minutes).

- Each press of **SLEEP** or **▶** will increase the time by 5 minutes.
- Each press of **◀** will decrease the time by 5 minutes.
- After setup, the sleep timer display can be called up for checking by pressing **SLEEP**.

### Tip

#### To Cancel the Sleep Timer

- Press **SLEEP** or **◀** or **▶** repeatedly until "0" is displayed on the TV screen.

## Child and rating locks

You can prevent your children from watching certain programs or certain channels by locking the TV controls and by using ratings.

## Setting your PIN

- 1 Press **MENU** on the remote control and then use **▲/▼/◀/▶** to select **[Setup] > [Features] > [Child lock]**.
- 2 Enter a 4-digit PIN on the **Number buttons**, of the remote control.
  - If you have not set up your PIN, enter **[0], [0], [0], [0]**.

## Changing your PIN

- 1 Press **MENU** on the remote control and then use **▲/▼/◀/▶** to select **[Setup] > [Features] > [Change PIN]**.
- 2 Enter a 4-digit PIN on the **Number buttons** of the remote control.
  - If you have a PIN, enter your current PIN.
  - If you do not have a PIN, enter **[0], [0], [0], [0]**.
  - If you have forgotten your PIN, enter **[0], [7], [1], [1]**.
- 3 Enter your new PIN.
- 4 Enter your PIN again to confirm.
- 5 Press **MENU** to exit.

## Lock the TV

This section describes how to lock all channels on the TV. At the specified time, screen is blanked out and the audio is muted.

- 1 Ensure that the clock is set with the current time (see 'Setting the clock' on page 21).
- 2 Press **MENU** on the remote control and then use **▲/▼/◀/▶** to select **[Setup] > [Features] > [Child lock]**.
- 3 Enter your PIN (see 'Setting your PIN' on page 22).
- 4 Use **▲** or **▼** to select **[Lock after]**, then press **OK**.
- 5 Press **OK** to select **[Timer]**.
- 6 Use **▲** or **▼** to select **[On]** and activate the **[Lock after]** feature. Select **[Off]** to deactivate the feature.
- 7 Press **OK** to confirm your choice.
- 8 Use **▲** or **▼** to select **[Time]** and then press **OK** to set the time. Use the format HH:MM, and select **[AM]** / **[PM]** for morning or afternoon.
- 9 Press **BACK** to confirm the time.
- 10 Press **MENU** to exit.
- 11 Turn the TV off and on again.

## Locking a channel

This section describes how to lock specified channels. The channels can be selected but the screen is blanked out and the audio is muted.

- 1 Press **MENU** on the remote control and then use **▲/▼/◀/▶** to select **[Setup] > [Features] > [Child lock]**.
- 2 Enter your PIN (see 'Setting your PIN' on page 22).
- 3 Use **▲** or **▼** to select **[Channel Lock]**, then press **OK**.

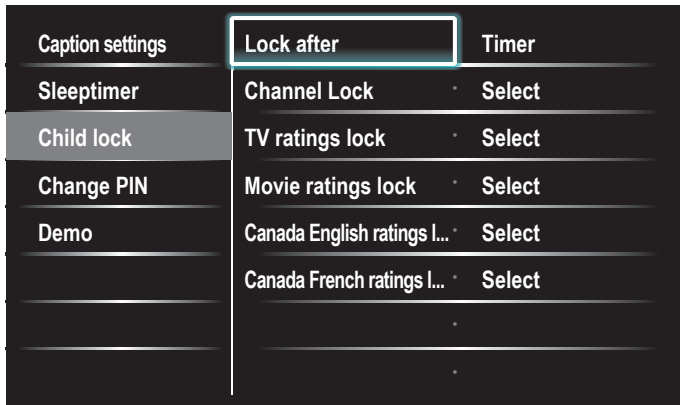

- 4 Use **▲** or **▼** and then press **OK** repeatedly to switch between locked and not locked. Each rating has a box-graphic in front of it to indicate whether it is locked:
  - A box with **x** indicates that the channel is locked.
  - An empty box indicates that the channel is not locked.
- 5 Press **MENU** to exit.

## Using the TV ratings lock

Your TV is equipped with a V-chip that allows you to control access to individual programs based on their age rating and content rating. The program content advisory data are sent by the broadcaster or by the program provider.

If you receive channels through a set-top box or cable box connected by HDMI, you cannot use the TV ratings lock. Your set-top box or cable box must be connected through RF or AV connectors.

- 1 Press **MENU** on the remote control and then use **▲/▼/◀/▶** to select **[Setup] > [Features] > [Child lock]**.
- 2 Enter your PIN (see 'Setting your PIN' on page 22).
- 3 Use **▲** or **▼** to select **[TV ratings lock]**, then press **OK**.
- 4 Use **▲** or **▼** or **◀** or **▶** and then press **OK** repeatedly to switch between locked and not locked. Each rating has a box-graphic in front of it to indicate whether it is locked:
  - A box with **x** indicates that all items in the content ratings list are locked.
  - An empty box indicates that no items in the content ratings list are locked.
  - A box with **/** indicates that some items in the content ratings are already locked and some items remain not locked.

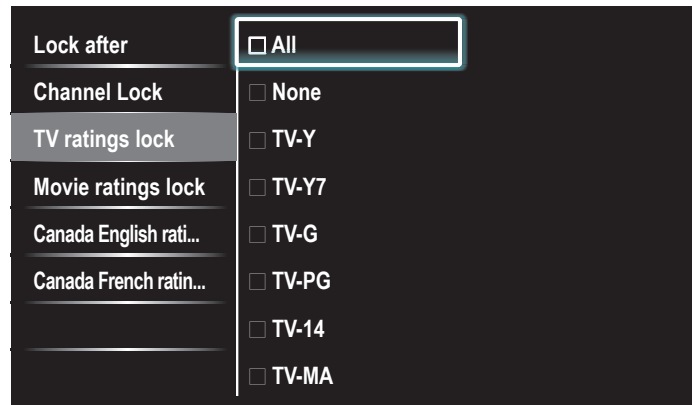

- When you select **[All]**, all items in the ratings list are locked.
- When you select **[None]**, programs with no rating and programs with a rating of none are locked.
- When you lock a rating, all ratings in the younger age categories are automatically locked.

- 5 Press **MENU** to exit.

## Summary of TV ratings

Age rating	Content rating
All	None
None	None
TV-Y: Appropriate for children of all ages with themes and elements suitable for children aged 2-6.	None
TV-Y7: Programs designed for children age 7 and older.	<b>[FantasyViolence]</b>
TV-G: Programs suitable for all ages. These programs contain little or no violence, no strong language and little or no sexual dialog or situations.	None
TV-PG: Programs contain elements that some parents may find unsuitable for younger children and which may need parental guidance. The program may contain moderate violence, sexual dialog and/or situations and some strong language.	<b>[Dialog]</b> <b>[Language]</b> <b>[Sex]</b> <b>[Violence]</b>
TV-14: Programs contain elements that may not be suitable for children under 14 years of age. These programs include one or more of the following: intense violence, intense sexual situations, suggestive dialog and strong language.	<b>[Dialog]</b> <b>[Language]</b> <b>[Sex]</b> <b>[Violence]</b>
TV-MA: Programs are designed to be viewed by adults and may be unsuitable for children under the age of 17. These programs may contain graphical violence, explicit sexual activity and/or crude or indecent language.	<b>[Language]</b> <b>[Sex]</b> <b>[Violence]</b>

### Note

- The V-Chip can block non rated programs as per "CEA-608-E sec. L3". If the option to block **[None]**, **[NR]**, **[E]** or **[E]** programs is used in **[TV ratings lock]**, **[Movie ratings lock]**, **[Canada English ratings lock]** or **[Canada French ratings lock]** accordingly "unusual results may occur; and the unit may not receive emergency bulletins or other types of programming;" · Emergency Bulletins (Such as EAS messages, weather warnings and others) · Locally originated programming · News · Political · Public Service Announcements · Religious · Sports · Weather.



## Using the movie ratings lock

You can control viewing of movies based on their MPAA (Motion Picture Association of America) rating.

1 Press **MENU** on the remote control and then use **▲/▼/◀/▶** to select **[Setup]** > **[Features]** > **[Child lock]**.

2 Enter your PIN (see 'Setting your PIN' on page 22).

3 Select one of the menus for movie ratings lock.

- In the USA, select **[Movie ratings lock]**.
- In Canada, select **[Canada English ratings lock]** or **[Canada French ratings lock]**.

The following screen shows the ratings in **[Movie ratings lock]**.

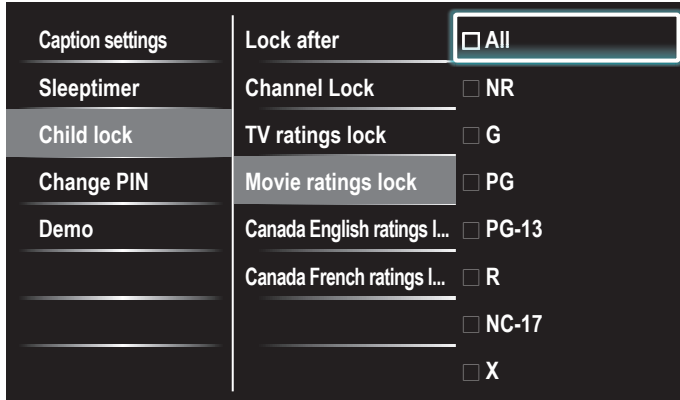

4 Use **▲** or **▼** and then press **OK** repeatedly to switch between locked and not locked. Each rating has a box-graphic in front of it to indicate whether it is locked:

- A box with **x** indicates that all items in the rating are locked.
- An empty box indicates that no items in the rating are not locked.
- When you select **[All]**, all items in the ratings list are locked.

5 Press **MENU** to exit.

## Summary of Movie ratings lock

Rating	Description
All	All items in the ratings list are locked.
NR	Not rated.
G	Movies with a mild content, suitable for all ages.
PG	Movies for which parental guidance is recommended. They may contain a few racy or violent scenes or maybe some bad language.
PG-13	Movies for which parental guidance may be recommended if under age 13.
R	Restricted. The movies usually contain offensive sex or bad language and may be unsuitable for children under the age of 17. Parental guidance or permission needed.
NC-17	Even with parental permission, forbidden under age 17. More offensive sex, violence or bad language.
X	Movies which generally focus on sex, violence and/or bad language. Also known as pornography.

## Summary of Canada English ratings lock

Rating	Description
All	All items in the ratings list are locked.
E	Exempt program.
C	Programming suitable for children under the age of 8 years. No profanity or sexual content of any level allowed. Minimal comedic violence.
C8+	Suitable for children ages 8 and over; Low intensity violence and fantasy horror allowed.
G	Movies with a mild content, suitable for all ages.
PG	Movies for which parental guidance is recommended. They may contain a few racy or violent scenes or maybe some bad language.
14+	Programming intended for children ages 14 and over. May contain intense scenes of violence, strong profanity, and depictions of sexual activity within the context of a story.
18+	Programming intended for viewers ages 18 and over. May contain strong violence, language, and sexual activity.

## Summary of Canada French ratings lock

Rating	Description
All	All items in the ratings list are locked.
E	Exempt program.
G	Appropriate for all ages with little or no violence and little to no sexual content.
8ans+	Appropriate for children 8 and up which may contain little violence, some foul language and/or little to no sexual content.
13ans+	Appropriate for children 13 and up, with moderate violence, language, and some sexual situations. Persons under 13 should be accompanied by an adult.
16ans+	Appropriate for children 16 and up, with strong violence, strong language, and strong sexual content.
18ans+	Only to be viewed by adults and contains extreme violence and graphic sexual content/pornography.

### Note

- The V-Chip can block non rated programs as per "CEA-608-E sec. L3". If the option to block **[None]**, **[NR]**, **[E]** or **[E]** programs is used in **[TV ratings lock]**, **[Movie ratings lock]**, **[Canada English ratings lock]** or **[Canada French ratings lock]** accordingly "unusual results may occur; and the unit may not receive emergency bulletins or other types of programming;" · Emergency Bulletins (Such as EAS messages, weather warnings and others) · Locally originated programming · News · Political · Public Service Announcements · Religious · Sports · Weather.

## Use the region ratings lock

You can control access to digital programs based on downloaded region ratings. Before you download a ratings table, ensure that regional ratings are broadcast.

1 Press **MENU** on the remote control and then use **▲/▼/◀/▶** to select **[Setup]** > **[Features]** > **[Child lock]**.

2 Enter your PIN (see 'Setting your PIN' on page 22).

3 Use **▲** or **▼** to select **[Region ratings lock]**, then press **OK**.

4 Use **▲** or **▼** and then press **OK** repeatedly to switch between locked and not locked. Each rating has a box-graphic in front of it to indicate whether it is locked:

- A box with **x** indicates that the rating is locked.
- An empty box indicates that the rating is not locked.

5 Press **MENU** to exit.

## Use the demo mode

You can use demonstrations to better understand the features of your TV.

- 1 Press **MENU** on the remote control and then use **▲/▼/◀/▶** to select **[Setup] > [Features] > [Demo]**. Also, you can enter the demo mode when you press **DEMO**.
- 2 Use **▲** or **▼** to highlight a demo, and press **OK** to start the demo.
- 3 Follow the on-screen instructions to enjoy the demo.
- 4 Press **MENU** to exit.

## Use Philips EasyLink

Your TV supports Philips EasyLink, which enables one-touch play and one-touch standby between EasyLink-compliant devices. Compliant devices must be connected via an HDMI connector.

### One-touch play

When you connect your TV to devices that support one-touch play, you can control your TV and the devices with one remote control. For example, when you press **▶ (play)** on your DVD remote control, your TV automatically switches to the correct channel to show the DVD content.

### One-touch standby

When you connect your TV to devices that support standby, you can use your TV remote control to put your TV and all connected HDMI devices in standby mode. You can perform one-touch standby using the remote control from any of the connected HDMI devices.

### System audio control

When you connect your TV to HDMI CEC compliant devices, your TV can switch automatically to play audio from the connected device. To use one-touch audio, you must map the audio input from the connected device to your TV. You can use the remote control from the connected device to adjust the volume.

### Remote control (RC) key forwarding

RC key forwarding allows you to control EasyLink-compliant devices using your TV remote control.

## Activate Master EasyLink

- 1 Press **MENU** on the remote control and then use **▲/▼/◀/▶** to select **[Setup] > [Installation] > [Preferences] > [EasyLink] > [Master EasyLink]**.
- 2 Use **▲** or **▼** to select **[On]**.

### Note

- Select **[Off]** to disable this function.
- Philips does not guarantee 100% interoperability with all HDMI CEC devices.
- The EasyLink-compliant device must be switched on and selected as the source.

**[Master EasyLink]** must be activated in the **[Preferences]** menu to make the **[TV Speakers]** menu available in the **[Sound]** menu.

## EasyLink

This function allows you to operate the linked functions between our brand devices with EasyLink capabilities and this unit connected via a HDMI cable.

- 1 Press **MENU** on the remote control and then use **▲/▼/◀/▶** to select **[Setup] > [Installation] > [Preferences] > [EasyLink]**.

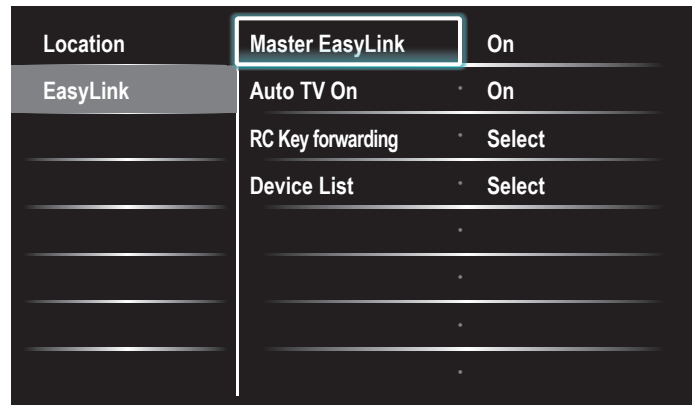

- 2 Use **▲** or **▼** to highlight the desired setting and then press **OK** to select the setting.
- 3 Adjust the following items.

### [Master EasyLink]

Set the EasyLink **[On]** or **[Off]**.

The following additional settings will disappear when you set to **[Off]**.

Use **▲** or **▼** to select the desired option, then press **OK**.

Off	Disable all EasyLink.
On	Select if you have connected an external device that is compatible with the EasyLink function.

### [Auto TV On]

The unit will turn on detected by the power on signal sending from your device.

Use **▲** or **▼** to select the desired option, then press **OK**.

Off	The unit stays off even if you turn on your connected EasyLink device.
On	The unit turns on automatically when you turn on your connected EasyLink device.

### [RC Key forwarding]

Use **▲** or **▼** to select the desired option, then press **OK**.

HDMI1 to HDMI4	Select enable or disable RC key forwarding if this unit connected through HDMI1 to HDMI4 to your EasyLink devices.
----------------	--

### [Device List]

This function lets you see the product name of connected devices. Use **▲** or **▼** to select the desired HDMI device listed on the TV screen, then press **OK**.

- 4 Press **MENU** to exit.

## Set your location to home

You can set the location of your TV to **[Home]** or **[Retail store]**.  
Choosing **[Home]** gives you full flexibility to change predefined settings for picture and sound.

- 1 Press **MENU** on the remote control and then use **▲/▼/◀/▶** to select **[Setup]** > **[Installation]** > **[Preferences]** > **[Location]**.
- 2 Select **[Home]** and then press **OK** to confirm your choice.
- 3 Press **MENU** to exit.

### Note

- You must set **[Home]**. Otherwise, the settings of picture and sound quality you adjusted will not be memorized after you turn off the unit.

## Network

Set up the network connection settings in order to use the Netflix feature, vTuner service or network update function.

### Connection test

After you made IP address/DNS settings or when a LAN cable is connected, always perform the connection test to check if the connection is correctly made.

- 1 Press **MENU** on the remote control and then use **▲/▼/◀/▶** to select **[Setup]** > **[Installation]** > **[Network]** > **[Connection test]**.  
Connection test will start automatically and the test result will appear right after the connection test finishes.
  - **[Testing...]**: The test is in progress.
  - **[Pass]**: Connection test is successfully completed.
  - **[Fail]**: Connection test failed. Check the connection settings. Press **OK** to go to the list of network status confirmation screen.
- 2 Press **MENU** to exit.

### Note

- If the connection test passes, you are ready to use Netflix feature, vTuner service or network update function using the Internet without making any extra settings.
- If the connection test fails, check the LAN cable is connected to this TV properly or the settings of your router correctly.

## IP configuration

In following cases, select **[IP configuration]** to set each setting as necessary.

- When connection test failed with the setting of **[Connection test]**.
- When instructed by your Internet service provider to make specific settings in accordance with your network environment.

- 1 Press **MENU** on the remote control and then use **▲/▼/◀/▶** to select **[Setup]** > **[Installation]** > **[Network]** > **[IP configuration]**.
- 2 Use **▲** or **▼** to select a setting and then press **OK**.

Setting items		Description
IP setting mode	Auto	Sets the IP setting automatically.
	Manual	Sets the IP setting manually.
IP address <sup>*1, 3</sup>		A set of numbers which are assigned to devices participating in a computer network.
Subnet mask <sup>*1, 3</sup>		A mask which is used to determine what subnet an IP address belongs to.
Default gateway <sup>*1, 3</sup>		IP address of the electronic devices (such as router) which provides Internet access.
DNS setting mode	Auto	Sets the DNS setting automatically.
	Manual	Sets the DNS setting manually.
Primary DNS <sup>*2, 3</sup>		A server which handles the name and IP address over the internet.
Secondary DNS <sup>*2, 3</sup>		A server which handles the name and IP address over the internet.
MAC address		An address which recognizes the devices connecting to the network. It is also called Hardware Address.

<sup>\*1</sup> Items can be selected only when **[IP setting mode]** is set to **[Manual]**.

<sup>\*2</sup> Items can be selected only when **[DNS setting mode]** is set to **[Manual]**.

<sup>\*3</sup> Use **▲/▼** or **the Number buttons** to input numbers. When you press **▲/▼** to input numbers then press **OK** or input the triple digits by using **the Number buttons**, the cursor moves to the next entry field. When you press **▲/▼** to input numbers then press **OK** or input the triple digits by using **the Number buttons** at the rightmost entry field, numbers will be stored and go back to the previous menu.

- 3 Press **MENU** to exit.

### Note

- The range of input number is between 0 and 255.
- If you enter a number larger than 255, the number will automatically be 255.
- The manually entered number will be saved even if you change the setting to **[Auto]**.
- When you enter a wrong number, press **Color buttons (red)** to cancel. (the number will be back to **[0]**.)
- If you want to enter 1 or 2 digit number in one cell, press **OK** to move on to the next cell.
- If the entered IP address or the default gateway or primary DNS number is same as the default setting, IP address setting will be set to **[Auto]**. (The manually entered number will be saved).
- When IP address setting is set to **[Manual]**, the setting of DNS setting will automatically be **[Manual]** and when IP address setting is set to **[Auto]**, you can set either **[Auto]** or **[Manual]** for DNS setting.

## Proxy configuration

- 1 Press **MENU** on the remote control and then use **▲/▼/◀/▶** to select **[Setup] > [Installation] > [Network] > [Proxy configuration]**.
- 2 Use **▲** or **▼** to select a setting and then press **OK**.
  - For default settings, select **[Do Not Use]**.
  - If you need to change the proxy setting as instructed by your Internet service provider to set the designated proxy address and port, select **[Use]**.

Setting items		Description
Proxy setting	Do not Use	Not use the proxy server.
	Use	Uses the proxy server.
Proxy address*		Selects the number or word by using <b>▲/▼/◀/▶</b> , then press <b>OK</b> . <b>[Clear]</b> : Clear the entered number or word. <b>[All clear]</b> : Clear all the entered numbers or words. <b>[a/A/@]</b> : Switch between abc, ABC and @!? <b>[Cancel]</b> : Shows the cancellation display. <b>[OK]</b> : Set the entered number or word.
Proxy port*		Use <b>▲/▼</b> or the <b>Number</b> buttons to input numbers.

\* Items can be selected only when **[Proxy port]** is set to **[Use]**.

- 3 Press **MENU** to exit.

### Note

- The range of input number for the port number is between 0 and 65535. (If you enter a number larger than 65535, it will be regarded as 65535.)
- For proxy port, the selected ports may be blocked and not be able to use depending on your network environment.
- If the proxy address is entered with blank only, proxy server setting will be set to **[Do Not Use]**.

## Setting status

You can check the status of network settings.

- 1 Press **MENU** on the remote control and then use **▲/▼/◀/▶** to select **[Setup] > [Installation] > [Network] > [Setting status]**.
  - Network setting list will be displayed.
  - MAC address of this unit will be displayed in the list.
- 2 Press **MENU** to exit.

## Disclaimer

Displays the network service disclaimer.

- 1 Press **MENU** on the remote control and then use **▲/▼/◀/▶** to select **[Setup] > [Installation] > [Network] > [Disclaimer]**.
- 2 Press **MENU** to exit.

## Netflix connection

Displays the cancellation setting of Netflix or ESN information.

- 1 Press **MENU** on the remote control and then use **▲/▼/◀/▶** to select **[Setup] > [Installation] > [Network] > [Netflix connection]**.

Setting items		Description
Deactivation	Yes	Deactivate the connection to Netflix.
	No	Activate the connection to Netflix.
ESN		Displays the ESN (Electronic Serial Number) to get any services from Netflix.

- 2 Press **MENU** to exit.

## DivX® Video on Demand

When you purchase or rent a DivX® file through the official site of DivX® video which is called DivX® Video On-Demand (VOD) services, a registration code is required every time you get the new file from the DivX® VOD services.

- 1 Press **MENU** on the remote control and then use **▲/▼/◀/▶** to select **[Setup] > [Installation] > [DivX® Video on Demand] > [Information]**.  
 ↳ Shows the registration code.

This item provides you with the DivX® VOD registration code. The DivX® registration code is required when downloading the DivX® VOD files from the Internet. To learn more about DivX® VOD, visit [www.divx.com/vod](http://www.divx.com/vod). Once you have registered the DivX® VOD registration code, you can deregister its code to use other devices or you will never see it on this unit.

Possible errors	Description
This rental has <b>0</b> views left. Do you want to use one of your <b>0</b> views now?	Some DivX® VOD files are restricted with limited playable times. You cannot play them back beyond the limit.
This TV is not authorized to play this video.	You cannot play back DivX® VOD files obtained with different registration codes on this unit.
Rental Expired	You cannot play back DivX® VOD files with the expired rental period.
This TV does not support this video format.	You cannot play back DivX® files whose image size exceeds 720 x 576.
This TV does not support this audio format.	For DivX® files with audio format other than MPEG1 audio layer 3 (MP3), MPEG1 audio layer 2 and Dolby Digital, audio will not be output and only the video will be output.
This TV does not support this video frame rate.	You cannot play back DivX® files whose frame rate exceeds 30 fps.

### Note

- A file with an extension of ".avi" and ".DivX" is called as a DivX® file. All files with the ".avi" extension are recognized as MPEG4.
- Unrecognizable characters will be replaced with "?".
- When playing back the files recorded in high bit rates, the images can be interrupted in some occasions.
- Although DivX® logo has been obtained for this unit, it may not be able to play back some data, depending on the characteristics, bit rates, or audio format settings, etc.
- If a large-sized DivX® file is selected, it may take a while to start the playback (over 20 seconds sometimes).
- For more information for DivX®, please visit <http://www.divx.com>.

## Deregistrate

- 1 Press **MENU** on the remote control and then use **▲/▼/◀/▶** to select **[Setup] > [Installation] > [DivX®: Deregistration]**.
- 2 Press **OK**.
- 3 Use **◀** or **▶** to select **[Yes]** and then press **OK**.  
 ↳ Shows **[DivX®: Deregistration code]**. This item provides you with the DivX® VOD deactivation code. The DivX® deactivation code is required when re-downloading the DivX® VOD files from the Internet after deactivating. To learn more about DivX® VOD, visit [www.divx.com/vod](http://www.divx.com/vod).

This deregistrates this unit and provides you with new registration code and deregistration code in order to download the DivX® VOD files from the Internet.

# View photos and play music, and watch videos on a USB storage device

## ! Caution

- This unit accepts USB flash memory only. Other storage devices such as external HDD by USB bus power will not work.
- Philips is not responsible if the USB storage device is not supported nor is it responsible for damage or loss of data from the device.

Your TV is fitted with a USB connection that enables you to view photos or listen to music stored on a USB storage device.

Supported formats	Not-supported formats
MP3	File name exceeding 256 characters
JPEG	Progressive JPEG files
FAT/DOS-formatted memory devices	File names containing a dot character

It is recommended that files to be played back in this unit are recorded under the following specifications:

### <MP3>

- Sampling frequency : 32 kHz or 44.1 kHz or 48 kHz
- Constant bit rate : 32 kbps - 320 kbps

### <JPEG>

- Upper limit : 16 Mpixel

### <DivX®>

Official DivX® Certified product

- Playable codec of AVI files : DivX® 3.x, DivX® 4.x, DivX® 5.x, DivX® 6.x
- Maximum size of a video : 720 x 480 30 fps  
720 x 576 25 fps
- Sampling frequency of audio : 16 kHz - 48 kHz
- Audio type : MPEG1 audio layer 3 (MP3), MPEG1 audio layer 2, DolbyDigital

### <MPEG>

- Playable codec : MPEG1, MPEG2
- Maximum size of a video : 720x480
- Audio type : AC3, MPEG, PCM

## ☰ Note

- A maximum of 1,023 folders or files can be recognized.
- Philips can not be held responsible if your USB storage device is not supported, nor will Philips accept any liability for damage or loss of stored data.
- The USB storage device is not supplied with the TV.
- ABOUT DIVX VIDEO: DivX® is a digital video format created by DivX, Inc. This is an official DivX Certified device that plays DivX video. Visit [www.divx.com](http://www.divx.com) for more information and software tools to convert your files into DivX video.
- ABOUT DIVX VIDEO-ON-DEMAND: This DivX Certified® device must be registered in order to play DivX Video-on-Demand (VOD) content. To generate the registration code, locate the DivX VOD section in the device setup menu. Go to [www.divx.com/vod](http://www.divx.com/vod) with this code to complete the registration process and learn more about DivX VOD.
- Official DivX® Certified product; Plays all versions of DivX® video (including DivX® 6) with standard playback of DivX® media files.
- USB device containing the DivX® files with the DivX® GMC (Global Motion Compensation) playback feature, which is DivX® supplemental function, cannot be played back on this unit.

## Connect a USB storage device

- 1 Turn on the TV.
- 2 Connect the USB storage device to the USB port on the side of your TV.
- 3 Use **▲/▼/◀/▶** to select **[Browse USB]**.
  - Press **OPTIONS** to display the optional menu, then press **OK** to switch between **[List]** and **[Thumbnails]**.

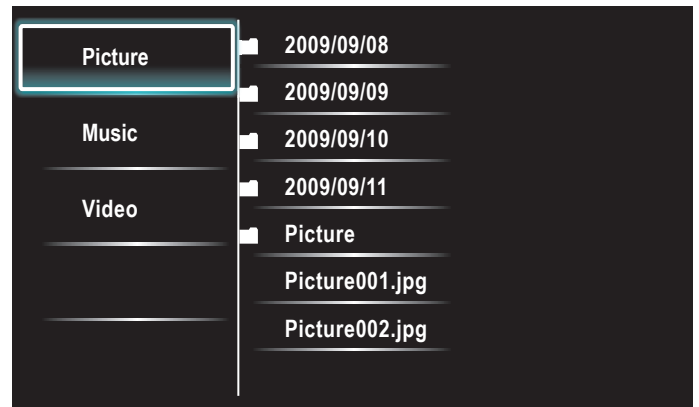

## Disconnect a USB storage device

## ! Caution

- To avoid damaging the USB storage device always exit the on-screen menu and wait 5 seconds before you remove the USB storage device.

- 1 Press **MENU** to exit the on-screen menu.
- 2 Wait 5 seconds then remove the USB storage device.

## View your picture on a USB storage device

- 1 In the USB content browser, use **▲/▼** to select **[Picture]**.
- 2 Press **▲** or **▼** to select a file or a folder on the USB storage device.

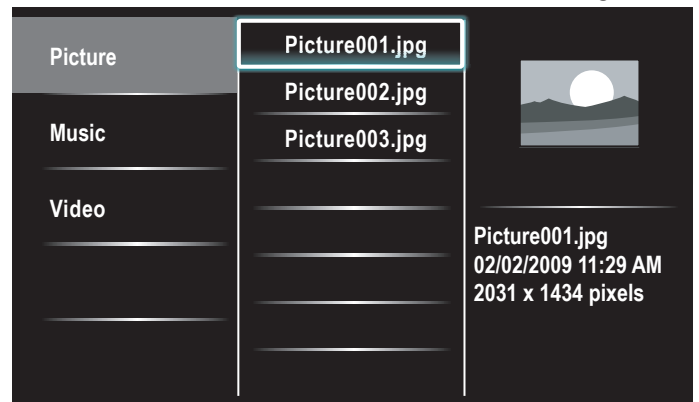

- 3 Press **OK** or **▶||** to start a slideshow of the files.
  - Press **OK** or **▶||** to pause the slide show.
    - ↳ The **||** icon appears.
  - Press **◀◀** or **▶▶** to move between images.
  - Press **BACK** or **■** to stop the slide show.
  - Press **OPTIONS** to display the optional menu, then use **▲** or **▼** to select the desired item.

Setting items	Description	
Slide time *1	Short	Switches to the next image in 5 seconds.
	Medium	Switches to the next image in 10 seconds.
	Long	Switches to the next image in 15 seconds.
Transitions *1	None	No effect when switching images.
	Dissolve	Overlaps a next image on a current image.
	Wipe right	Pushes a current image out from left.
	Wipe left	Pushes a current image out from right.
	Wipe up	Pushes a current image out from bottom.
	Wipe down	Pushes a current image out from top.
	Box in	A next image comes into the center from out.
	Box out	A next image goes to the out from center.

Setting items		Description
Rotate *2	0	Displays an image at its original direction.
	90	Rotates an image clockwise by 90 degrees.
	180	Rotates an image clockwise 180 degrees.
	270	Rotates an image clockwise 270 degrees.
Zoom *2	1x	Displays an image at its original size.
	2x	Magnifies a current image as twice.
	4x	Magnifies a current image as fourfold.

\*1 You can set [Slide time] and [Transitions] when images are in Slide show.

\*2 You can set [Rotate] and [Zoom] when Slide show is in pause mode.

## Listen to music on a USB storage device

- 1 In the USB content browser, use ▲/▼ to select [Music].
- 2 Press ▲ or ▼ to select a file or a folder on the USB storage device.

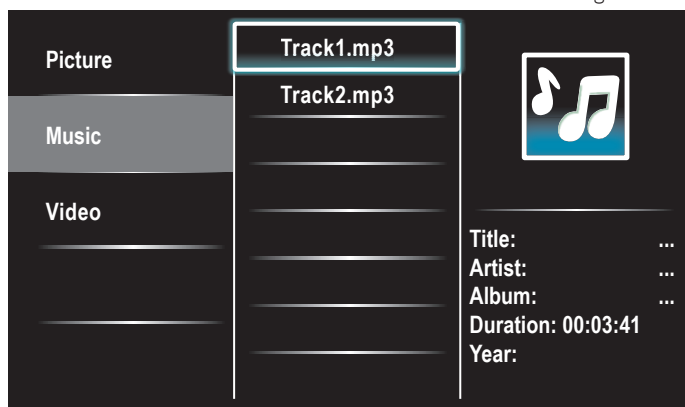

- 3 Press OK or ►|| to play the selected files.
  - Press OK or ►|| to pause, press OK or ►|| again to resume.
  - Press ►► to skip up the next file.
  - Press ◀◀ to skip down the previous file.
  - Press ■ to stop playback.
  - Press OPTIONS to display the optional menu, then use ▲ or ▼ to select the desired item.

Setting items		Description
Repeat	Off	Sets repeat playback to off.
	On	Sets repeat playback for all MP3 files in the current folder.
Shuffle	Off	Sets shuffle playback to off.
	On	Sets shuffle playback for all MP3 files in the current folder.
TV speakers	Off	The sound will not be output from the unit's speakers.
	On	The sound will be output from the unit's speakers.
	Speakers EasyLink	You can control audio output from your connected EasyLink Compliant Devices with VOL +/- by using this unit's remote control.

### Note

- [Master EasyLink] must be activated in the [Preferences] menu to make the [TV Speakers] menu available when you select [On] or [Speakers EasyLink].

## Watch your Video on a USB storage device

- 1 In the USB content browser, use ▲/▼ to select [Video].
- 2 Press ▲ or ▼ to select a file or a folder on the USB storage device.

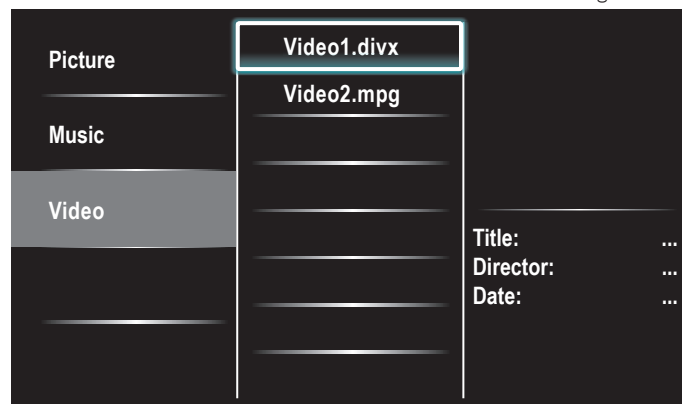

- 3 Press OK or ►|| to play the selected files.
  - Press OK or ►|| to pause, press OK or ►|| again to resume.
  - Press ►► to fast-forward search.
  - Press ◀◀ to fast-backward search.
  - Press ■ to stop playback.
    - ↳ Press ►|| to resume from the point at which playback was stopped. Press OK to play from the beginning of the file at which playback was stopped.
  - Press OPTIONS to display the optional menu, then use ▲ or ▼ to select the desired item.

Setting items		Description
Subtitle	Not available	Displays if no subtitle is available.
	Subtitle Off	Set subtitle to off.
	Subtitle 1-8	Select the desired subtitle if the DivX® file contains them.
Audio language	Not available	The unit displays if no audio language is available.
	Audio 1-8	Select the desired audio language if the DivX® file contains them.
TV speakers	Off	The sound will not be output from the unit's speakers.
	On	The sound will be output from the unit's speakers.
	Speakers EasyLink	You can control audio output from your connected EasyLink Compliant Devices with VOL +/- by using this unit's remote control.

### Note

- The resume information will be kept even when the unit is turned off.
- If you play another file while the previously viewed file is being resumed, the resume information of the previously viewed file will be deleted and the number of playback times will be decreased.
- The file or the folder in resume stop mode will be highlighted in gray on [List] or [Thumbnails].

# 7 Install channels

The first time you set up your TV, you are prompted to select a menu language and to install TV and digital radio channels (if available). This chapter provides instructions on how to reinstall and fine-tune channels.

## Selecting your menu language

- 1 Press **MENU** on the remote control and then use **▲/▼/◀/▶** to select **[Setup]** > **[Installation]** > **[Language]**.

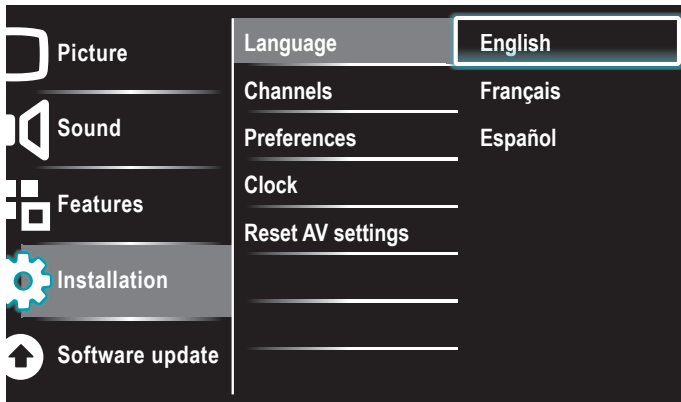

- 2 Select a language and then press **OK** to confirm your choice.
- 3 Press **MENU** to exit.

## Autoprogram

If you switch wires (e.g., between antenna and CATV) or if you move the unit to a different area after the initial setting, you will need to perform autoprogram.

- 1 Press **MENU** on the remote control and then use **▲/▼/◀/▶** to select **[Setup]** > **[Installation]** > **[Channels]** > **[Autoprogram]** > **[Start now]**.

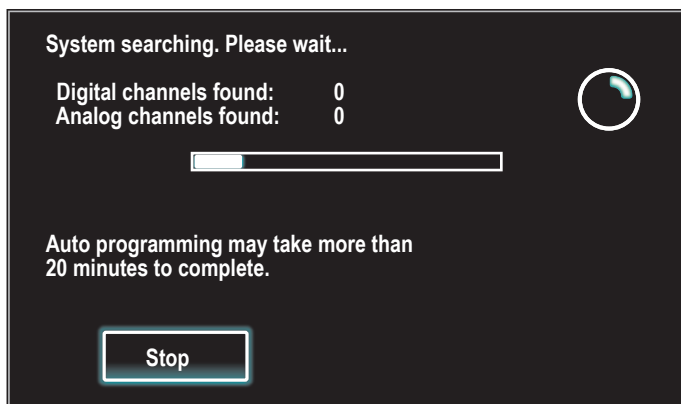

- 2 Press **OK** to start the installation.  
If you run **[Autoprogram]** when you have locked channels, a message appears asking to enter your PIN. Enter your PIN in order to complete the installation.  
If you have forgotten your PIN, reset it as described in 'Changing your PIN' on page 22.
  - When autoprogramming is complete, the lowest memorized channel will be displayed.
- 3 Follow the on-screen instructions to complete the installation.

## Weak channel installation

This function lets you add the channels that were not added by the autoprogram due to the receivable condition at the initial setup.

- 1 Press **MENU** on the remote control and then use **▲/▼/◀/▶** to select **[Setup]** > **[Installation]** > **[Channels]** > **[Weak channel Installation]**.
- 2 Use **◀** or **▶** to select channel input box, then use **▲** or **▼** to select a channel you want to memorize.
- 3 Use **◀** or **▶** to select **[Search]**, then press **OK**.
- 4 Display will be changed to **[Store]** from **[Search]** when the channel is found, then press **OK**.
- 5 Press **MENU** to exit.

### Note

- In most cases, digital channels are not broadcast on the RF channel on which they appear on your TV. To add digital channels you need to know the RF channel on which the digital channel is being broadcast. Eg. If there is a digital channel 9.1 which is being broadcast on RF channel 25, you need to enter 25 while performing a weak channel installation. To find out the RF channel on which a particular digital channel is being broadcast, please contact your local service provider.  
Installing digital channels using **[Weak channel installation]** might not work for direct cable connections and if the digital signal is too weak for the TV to process.

## Installation mode

- 1 Press **MENU** on the remote control and then use **▲/▼/◀/▶** to select **[Setup]** > **[Installation]** > **[Channels]** > **[Installation mode]**.
- 2 Use **▲** or **▼** to select, then press **OK**.
- 3 Press **MENU** to exit.

## Uninstall channels

Those channels can still be selected with the **Number** buttons.

- 1 Press **MENU** on the remote control and then use **▲/▼/◀/▶** to select **[Setup]** > **[Installation]** > **[Uninstall channels]**.
- 2 Use **▲** or **▼** to select the channel you want to remove, then press **OK**.
  - You will not be able to select the channel again using **CH +/-**.
  - To reactivate a removed channel, use **▲** or **▼** and then press **OK**.
- 3 Press **MENU** to exit.

## Return your settings to default values

When you return picture and sound settings to their default values the channel installation settings are not affected.

- 1 Press **MENU** on the remote control and then use **▲/▼/◀/▶** to select **[Setup]** > **[Installation]** > **[Reset AV settings]** > **[Start now]**.
- 2 Press **OK** to reset the picture and sound settings.
- 3 Press **MENU** to exit.

# 8 Update your TV software

Philips continuously tries to improve its products and we strongly recommend that you update the TV software when updates are available. New software can be downloaded from our website at [www.philips.com](http://www.philips.com) using the type number of your TV (e.g. 55PFL7705D) to find information.

## Checking your current software version

- 1 Press **MENU** on the remote control and then use **▲/▼/◀/▶** to select **[Setup] > [Software update] > [Current software info] > [Select]**.  
↳ The version and a description of the current software is displayed.

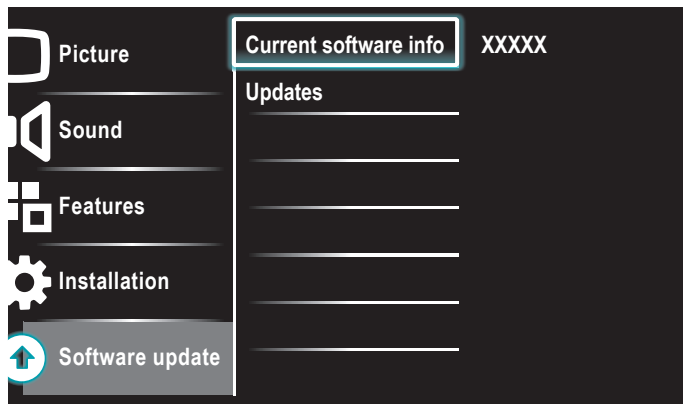

- 2 Press **MENU** to exit.

## Preparing for the software update by USB

You require the following equipment:

- A PC with web browsing capability.
- An archive utility that supports the ZIP-format (e.g. WinZip for Windows or Stuffit for Mac OS).
- A USB storage device.

### Note

- Only FAT /DOS-formatted portable memory is supported.
- New software can be downloaded from [www.philips.com](http://www.philips.com)
- Use only software updates that can be found on the Philips web site.

### Warning

- When the software update is running, don't press any buttons.
- Do not remove the USB storage device during the software update.
- If an error occurs during the update, retry the procedure or contact your dealer.

## Downloading the software

- 1 On your PC, open a web browser and go to [www.philips.com](http://www.philips.com)
- 2 Find information and software related to your TV and download the latest software update file to your PC.
- 3 Decompress the ZIP-file.
- 4 Copy the update file to the root directory of the USB storage device.

## Updating software

### USB update

You can update the software by using USB storage device.

- 1 If the TV is on, press **POWER** at the side of the TV to switch off the TV.
- 2 Connect your USB storage device with the update file to the USB port on the side of your TV.

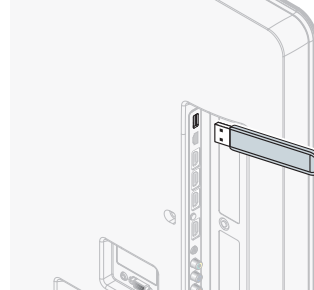

- 3 Switch on the TV.
- 4 Press **MENU** on the remote control and then use **▲/▼/◀/▶** to select **[Setup] > [Software update] > [Updates] > [USB]**.
- 5 Use **▲** or **▼** to select the desired Update file.
- 6 Use **▲** or **▼** to select **[Yes]**, then press **OK**.
- 7 Read the on-screen instructions and confirm that you want to continue with the installation.



- 8 When the software update is complete, remove the USB storage device.
- 9 Unplug the AC power cord for a few seconds from AC outlet and plug it again.
- 10 Switch on the TV.  
↳ The TV starts up with the new software.
  - The following messages are displayed without starting software update when it doesn't fulfill the update conditions.

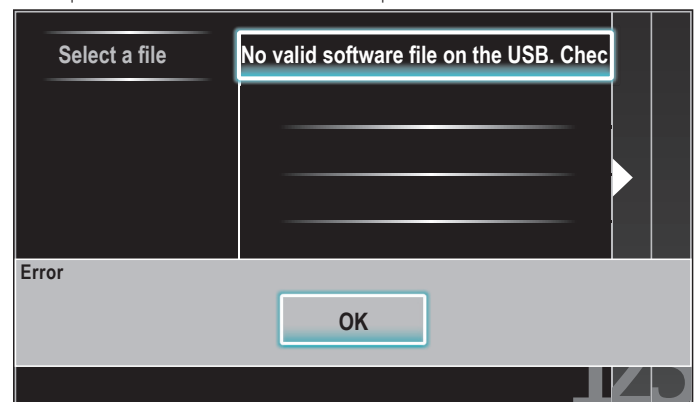



---

## Network update

You can update the software by connecting the unit to the Internet.

- 1 Follow steps 1 to 2 in 'Connection Test' on page 26.
- 2 Press **MENU** on the remote control and then use **▲/▼/◀/▶** to select **[Setup] > [Software Update] > [Updates] > [Network]**.
- 3 Use **◀/▶** to select **[Yes]**, then press **OK**.
  - This unit will then start checking for the latest firmware version.
- 4 Confirmation message will appear. Use **◀/▶** to select **[Yes]**, then press **OK**.
  - The unit will start downloading the latest firmware version.
  - The unit will start updating the firmware version.
  - It may take a while to complete the updating.
- 5 When the software update is complete, press **POWER**  at the side of the TV to switch off the TV.
- 6 Switch on the TV.
  - ↳ The TV starts up with the new software.

### Note

- In order to update the software via the Internet, you must connect the unit to the Internet and set up necessary settings.
- For the network connection, refer to 'Connecting the TV to the internet using an Ethernet cable' on page 36.
- For the network setup, refer to 'Network' on page 26.
- Please do not unplug the AC power cord or LAN cable while executing the 'Network update'.
- All settings will remain the same even if you update the software version.
- The version of Netflix will also be updated if newer version of Netflix is available when updating the firmware.

# 9 Connect devices

This section describes how to connect various devices with different connectors and supplements examples provided in the Quick Start.

## Connection overview

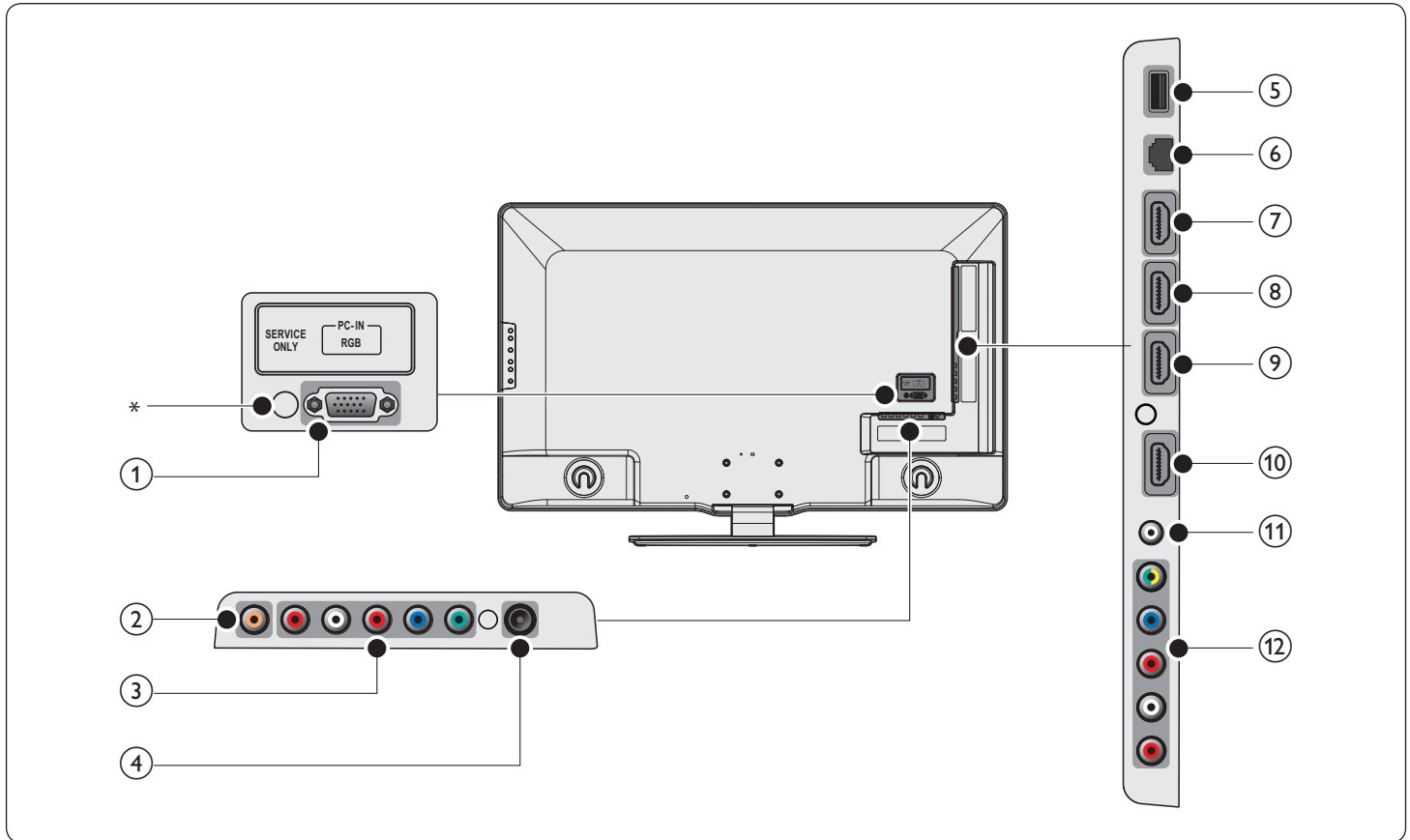

- ① **PC input jack**  
VGA cable connection for PC.
- ② **digital audio output jack**  
Digital audio output to home theaters and other digital audio systems.
- ③ **component 1 video and audio input jack**  
Video input from analog devices such as DVD, receiver, game console, etc. This connector is used with audio input.
- ④ **antenna input jack**  
Signal input from an antenna, cable or satellite.
- ⑤ **USB terminal**  
Data input from USB storage devices only. Do not connect any device to this terminal such as; digital camera, keyboard, mouse, etc.
- ⑥ **LAN**  
Telecommunications equipment with LAN cable in connector.
- ⑦ **HDMI 4 input jack**  
Digital audio and video input from high definition digital devices such as Blu-ray players.
- ⑧ **HDMI 3 input jack**  
Third HDMI in connector.

- ⑨ **HDMI 2 input jack**  
Second HDMI in connector.
- ⑩ **HDMI 1 input jack**  
First HDMI in connector.
- ⑪ **audio input jack for HDMI 1 and PC**
- ⑫ **component 2 video/composite video and audio input jack**  
Video input from analog devices such as DVD, receiver, game console, etc. This connector is used with audio input.

**\*service only**  
For use by service personnel only.

### ! Caution

- Disconnect the AC power cord before connecting devices.

### ≡ Note

- Do not use an extension cord between the USB flash memory and the unit. Always insert the USB flash memory to this unit directly.
- Different types of connectors may be used to connect a device to your TV, depending on availability and your needs.

---

## Selecting your connection quality

---

### HDMI - Highest quality

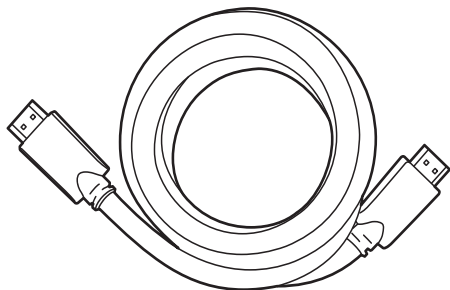

Supports high-definition signals and gives highest picture and sound quality. Video and audio signals are combined in one cable. You must use HDMI for full high-definition video and to enable Philips EasyLink.

#### Note

- Philips HDMI supports HDCP (High-bandwidth Digital Contents Protection). HDCP is a form of Digital Rights Management that protects high definition content in DVD or Blu-ray Discs.

---

### Component (Y Pb Pr) - High quality

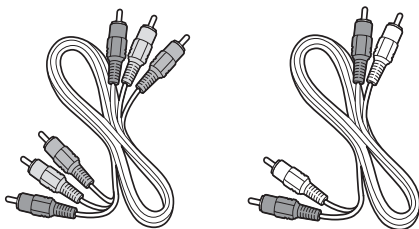

Component video cable (red/green/blue) and audio L/R cable (red/white)

Supports high-definition signals but gives lower picture quality than HDMI. Component cables combine a red/green/blue video cable with a red/white audio L/R cable. Match the cable colors when you connect to the TV.

---

### Composite - Basic quality

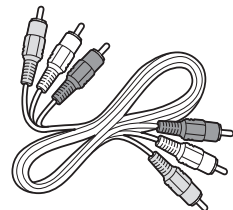

Composite video/audio cable (yellow/red/white)

For analog connections. Composite cables usually combine a yellow video cable with a red/white audio L/R cable. Note that this unit's composite video input jack is shared with a green one which is one of component 2 video input jack, you must use it when you connect your device via composite video cable (yellow jack goes to green jack). Other than composite video cable, match the audio cable colors when you connect to the TV.

## Connecting your devices

This section describes how to connect a selection of devices with different connectors. Different types of connectors can be used to connect a device to your TV. The following sections describe examples only, other configurations are possible.

### Connecting a set-top box, Blu-ray Disc player and HD game console via HDMI

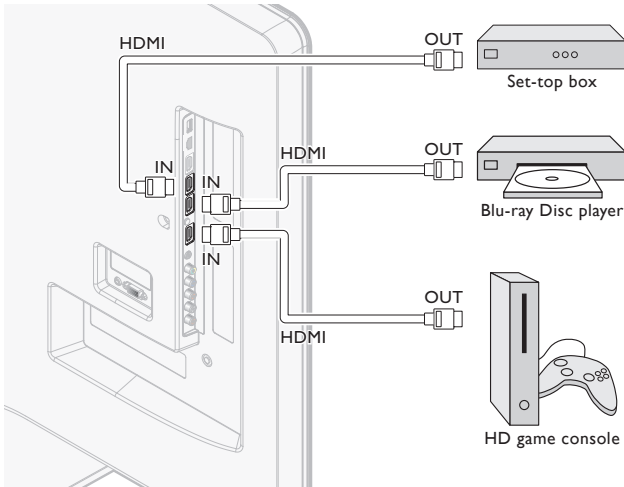

### Connecting a set-top box, DVD player/recorder via component video connectors (YPbPr) and analog audio

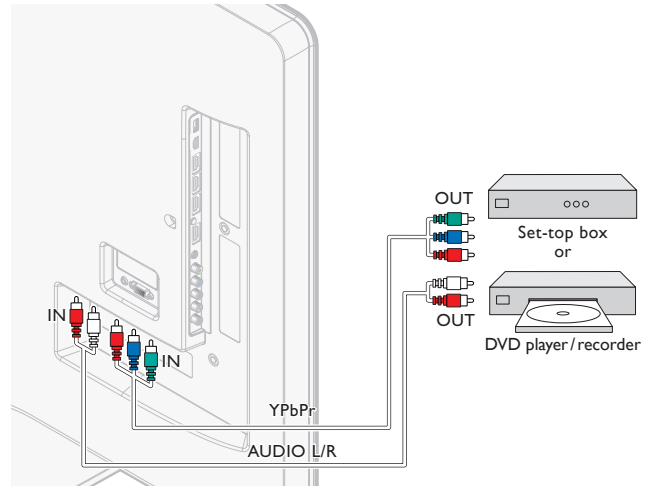

#### Note

- When you connect cables, match the cable colors to the connectors on the TV.

### Connecting a set-top box, DVD recorder via composite connectors and analog audio

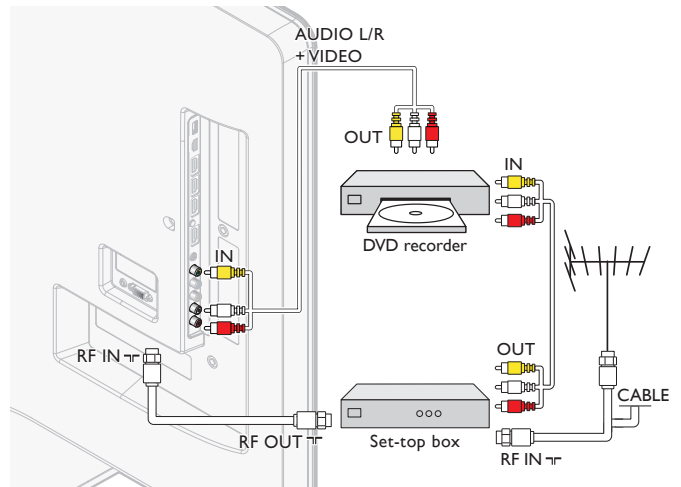

Do not place your recorder too close to the screen because some recorders can be susceptible to signals.

#### Note

- Only the left loudspeaker reproduces sound for mono equipment. Use a mono adapter (not supplied) for sound reproduction via all internal loudspeakers.
- When you connect cables, match the cable colors to the connectors on the TV.

### Connecting a DVD player/recorder via HDMI-DVI and analog audio

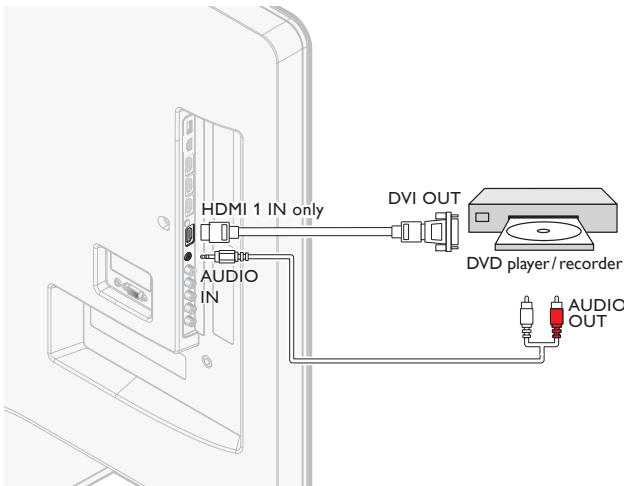

## Connecting a set-top box via a composite connector and analog audio

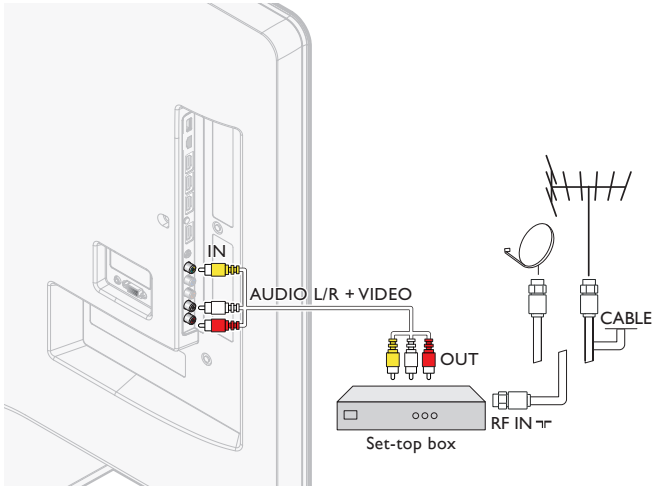

### Note

- Only the left loudspeaker reproduces sound for mono equipment. Use a mono to stereo adapter (not supplied) for sound reproduction via all internal loudspeakers.
- When you connect cables, match the cable colors to the connectors on the TV.

## Connecting a digital home theater amplifier using a digital audio coaxial cable

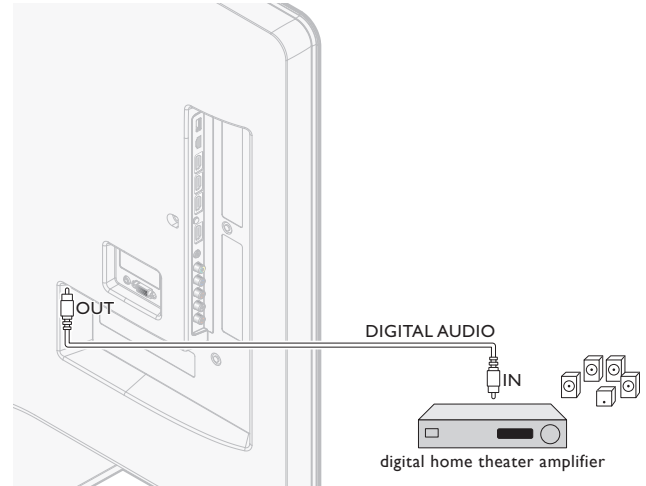

### Note

- Due to Copyright restrictions, the broadcaster may choose to mute PCM audio over Digital Audio Output for certain channels, shows or segments during the broadcast.

## Connecting the TV to the internet using an Ethernet cable

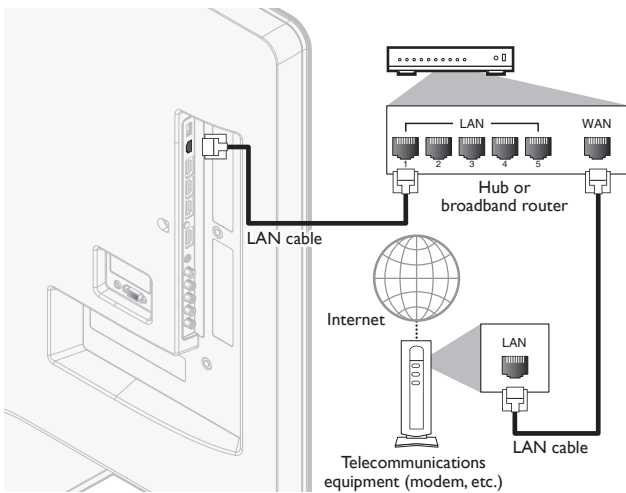

### Note

- Please purchase shielded LAN cables at your local store and use them when you connect to network equipment.
- After connecting a LAN cable, set up necessary network settings. (For the network setup, refer to 'Network' on page 26)
- Do not insert any cable other than a LAN cable to the LAN terminal to avoid damaging the unit.
- If your telecommunications equipment (modem, etc.) does not have broadband router functions, connect a broadband router.
- If your telecommunications equipment (modem, etc.) has broadband router functions but there is no vacant port, use a hub.
- For a broadband router, use a router which supports 10BASE-T/100BASE-TX.
- Do not connect your PC directly to the LAN terminal of this unit.

## Connecting a PC

If you connect a PC with a VGA connector at the back.

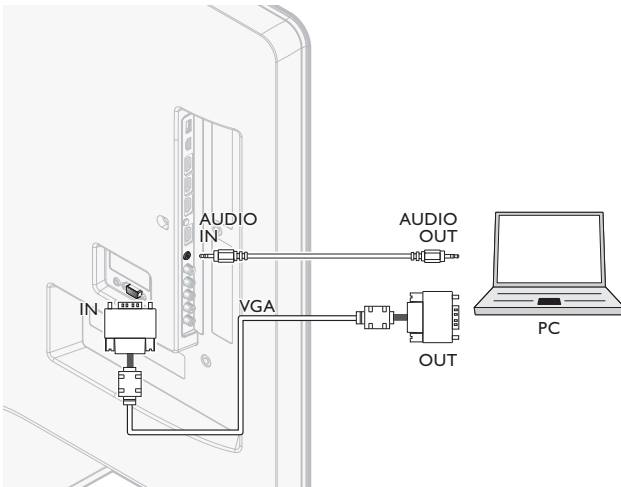

If you connect a PC with a HDMI-DVI connector.

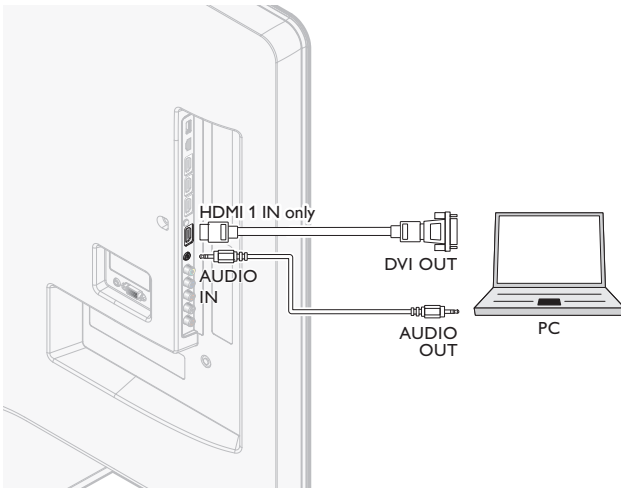

If you connect a PC with an HDMI connector.

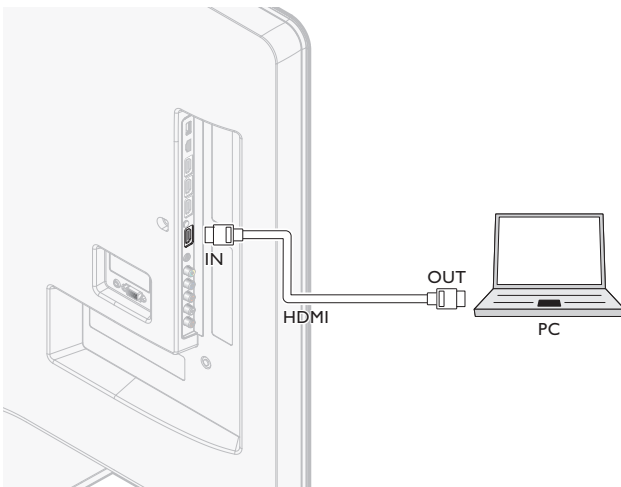

## Add devices

After connecting devices, assign the device attached to each connector. This allows you to easily identify devices connected to your TV.

- 1 Press **MENU** on the remote control and then use **▲/▼/◀/▶** to select **[Add new devices]**.
  - 2 Use **◀** or **▶** to select **[Start]**, then press **OK**.
  - 3 Use **▲** or **▼** to select a device and press **OK**.
  - 4 Use **▲** or **▼** to select the connector your device is connected to and press **OK**.
  - 5 If there is video and audio output, press **OK**.
- Repeat the procedure until all devices are correctly assigned to connectors.

## Remove devices

If a device is no longer connected to the TV, remove it from the home menu.

- 1 Press **MENU** on the remote control.
- 2 Use **▲/▼/◀/▶** to select a device to remove.
- 3 Press **OPTIONS**.
- 4 Use **▲** or **▼** to select **[Remove device]**, then press **OK**.
- 5 Use **◀** or **▶** to select **[OK]**, then press **OK**.

# 10 Troubleshooting

Problem	Possible cause and solution
No power or indicator light.	The TV is not connected to the power. Press <b>POWER</b> at the side of the TV or on the remote control. Ensure that the AC power cord is connected tightly to the TV power connector and to the power socket outlet. Remove the AC power cord from the power socket outlet, wait 60 seconds and reconnect the AC power cord. Connect the TV to a different power socket outlet.
No picture or sound is detected from the device using HDMI 1-4 input jack.	HDCP authentication fail. Ensure that your HDMI cable is certified. Press <b>SOURCE</b> on the remote control to switch to another source and then switch back to the HDMI source. Reset the accessory device and the TV. Turn on the TV. Select the HDMI channel. Turn on the accessory device. While the TV and the accessory device are powered on, unplug either end of the HDMI cable and then reinsert the cable.
No sound is detected from the PC using PC input jack.	An audio cable is not connected. Connect an audio cable to the PC/HDMI 1 AUDIO IN port on the TV. Press <b>SOURCE</b> on the remote control, and select the PC source.
No picture or sound is detected from the PC using HDMI 1 input jack.	An incorrect HDMI port is connected or an audio cable is not connected. Connect a HDMI-DVI cable to the HDMI 1 port on the TV. Connect an audio cable to the PC/HDMI 1 AUDIO IN port on the TV. Press <b>SOURCE</b> on the remote control, and select the HDMI 1 source.
TV does not respond to the remote control.	Batteries are installed incorrectly, or low battery power. Ensure that you are using the TV remote control. Ensure that the batteries are inserted correctly and do not need to be replaced. Remove the AC power cord from the power socket outlet, wait 60 seconds and reconnect the AC power cord.
The picture is distorted, stretched out, or has black bars on the side or top.	Broadcast video format. Press <b>FORMAT</b> on the remote control to select the best picture format. For some accessory devices, the picture format must be set in the accessory device.
The picture is mostly red and green, or the picture misses red when connected to an accessory device via component cables.	Insecure/incorrect connection. Ensure all the connections are made according to the color code. Push the component cables all the way into the YPbPr sockets on the TV.
No picture or sound.	No picture or sound - ensure you have selected the correct channel. Incomplete channel installation. If the TV receives channels via an AV connection, set the TV to the correct source input. If the TV is connected directly to the wall via a coaxial connection, perform the autoprogram again.
No sound on the TV loudspeaker.	Volume level is set to zero - increase the volume. Sound is muted - press <b>MUTE</b> on the remote control. Audio cable is not connected - for AV connection, ensure that the Audio L/R cable is connected as described in Connecting your devices (see 'Connecting your devices' on page 35). If you use a component cable, ensure that you have not crossed the red audio cable with the red video cable.
No sound on the TV loudspeaker.	Audio output setting for the accessory device is incorrect. For HDMI connections, some accessory devices have an HDMI audio output setting that must be turned on for HDMI to HDMI connections. Check if <b>[Sound] &gt; [TV Speakers] &gt; [Off]</b> is set to <b>[On]</b> . No sound will be output when <b>[TV Speakers]</b> is set to <b>[Off]</b> .
Bad picture quality with a coaxial connection.	Standard definition channels are not as clear as high definition channels - connect the devices via component or HDMI cables.

Cannot control your TV and connected devices with one remote control.	Confirm that the connected devices are EasyLink compliant and are connected to your TV via an HDMI cable. Not all brands of devices such as Blu-ray Disc players use the same system as Philips EasyLink. Other brands might not work with Philips EasyLink.
Cannot use Netflix feature.	Netflix is available only in the United States. Check if the network connection is properly made. Visit <a href="http://www.netflix.com/Philips">www.netflix.com/Philips</a> on your PC and become a Netflix member.
Cannot add movies or TV episodes to the Instant Queue.	Visit <a href="http://www.netflix.com">www.netflix.com</a> on your PC.
The picture quality of Netflix streaming movie is poor.	Check the speed of your Internet connection.
Even though the speed of the Internet connection improves during playback, the picture quality of Netflix streaming movie does not improve.	The picture quality does not change during playback. The picture quality differs depending on the speed of Internet connection at the time of loading.
The audio of Internet radio station interrupted.	vTuner server, station or the Internet connection is busy.
Cannot connect to the network.	Check if the LAN cable connection is properly made. Turn on the modem or broadband router. Check the network settings. Check if the broadband router and/or modem is correctly connected.
Cannot connect to the network while my PC is connected to the network.	Check the content of your Internet service contract to see if your Internet Service Provider prevents multiple terminals connecting at the same time.
Cannot play back Internet radio.	Check if the network connection is properly made. Check the firewall setting of the modem or router. For some stations, playback is not available on this unit.
The audio of Internet radio station interrupted.	The bit rate of the station is high.
The quality of the Internet radio audio is poor or noise occurs during playback of Internet station.	The bit rate of the station is low.

## Downloading an electronic copy

To obtain an electronic copy of this manual:

- 1 Point your browser to [www.philips.com/support](http://www.philips.com/support)
- 2 Choose your country of location.
- 3 Enter the model number or a keyword in the "Find your product" field. Alternatively, you can browse the catalog.
- 4 Click the description or model.
- 5 Under Product support, click "User manuals".

## Contact us

If you cannot resolve your problem, refer to the FAQ for this TV at [www.philips.com/support](http://www.philips.com/support)

If the problem remains unresolved, contact the Customer Support Center in your country.



### Warning

- Do not attempt to repair the TV yourself. This may cause severe injury, irreparable damage to your TV or void your warranty.



### Note

- Please have available your TV model and serial number before contacting us. These numbers are available on the back and side of your TV, as well as on the packaging.

# 11 Product information

## Power

Power requirements: 120V~ AC +/- 10%, 60Hz +/- 0.5%

### Note

- Product information is subject to change without prior notice.

## Picture enhancement

Type:	1080p 120Hz
Aspect Ratio:	16:9
Viewing Angles:	178° (V) by 178° (H)
Built-in digital tuner:	ATSC/QAM

## Sound enhancement

Mono/Stereo:	Mono, Stereo, SRS
Power output (RMS Watts):	20 W
Equalizer:	5 band

## Ease of use

Video modes:	Automatic, 4:3, Movie Expand 14:9, Movie Expand 16:9, Super Zoom, Wide Screen, Unscaled
PC input:	via VGA, HDMI
Photo Slide Shown:	Yes (jpeg files only)
MP3 Playback:	Yes (mp3 files only)
Video Playback:	Yes (MPEG1/2, DivX®)

## Connections

Component video input with audio L/R:	2, supporting video signals: 480i/p, 720p, 1080i 60Hz, 1080p 24/30/60Hz
Composite (shared terminal with Y of components) video input with audio L/R:	1
HDMI:	4 HDMI supporting video signals: 480i/p, 720p, 1080i 60Hz, 1080p 24/30/60Hz PC input: up to 1920x1080 60Hz
3.5mm stereo miniplug shared use for HDMI 1 and PC input:	1
PC input:	1 up to 1920x1080 60Hz
Digital audio output:	1, supporting Dolby Digital and PCM
USB:	1
LAN:	1



# 12 Warranty

## LIMITED WARRANTY ONE (1) YEAR

### WARRANTY COVERAGE:

This warranty obligation is limited to the terms as set forth below.

### WHO IS COVERED:

This product warranty is issued to the original purchaser or the person receiving the product as a gift against defects in materials and workmanship as based on the date of original purchase ("Warranty Period") from an Authorized Dealer. The original sales receipt showing the product name and the purchase date from an authorized retailer is considered such proof.

### WHAT IS COVERED:

This warranty covers new products if a defect in material or workmanship occurs and a valid claim is received within the Warranty Period. At its option, the company will either (1) repair the product at no charge, using new or refurbished replacement parts, or (2) exchange the product with a product that is new or which has been manufactured from new, or serviceable used parts and is at least functionally equivalent or most comparable to the original product in current inventory, or (3) refund the original purchase price of the product. Replacement products or parts provided under this warranty are covered against defects in materials and workmanship from the date of the replacement or repair for ninety (90) days or for the remaining portion of the original product's warranty, whichever provides longer coverage for you. When a product or part is exchanged, any replacement item becomes your property and the replaced item becomes company property. When a refund is given, your product becomes company property. Note: Any product sold and identified as refurbished or renewed carries a ninety (90) day limited warranty.

Replacement product can only be sent if all warranty requirements are met. Failure to follow all requirements can result in delay.

### WHAT IS NOT COVERED - EXCLUSIONS AND LIMITATIONS:

This Limited Warranty applies only to new company manufactured products that can be identified by the trademark, trade name, or logo affixed to it. This Limited Warranty does not apply to any hardware product or any software, even if packaged or sold with the product, as manufacturers, suppliers, or publishers may provide a separate warranty for their own products packaged with the bundled product.

The company is not liable for any damage to or loss of any programs, data, or other information stored on any media contained within the product, or other additional product or part not covered by this warranty. Recovery or reinstallation of programs, data or other information is not covered under this Limited Warranty.

This warranty does not apply (a) to damage caused by accident, abuse, misuse, neglect, misapplication, or non-supplied product, (b) to damage caused by service performed by anyone other than company approved Authorized Service Location, (c) to a product

or a part that has been modified without written company permission, or (d) if any serial number has been removed or defaced, or (e) product, accessories or consumables sold "AS IS" without warranty of any kind by including refurbished product sold "AS IS" by some retailers.

This Limited Warranty does not cover:

- Shipping charges to return defective product.
- Labor charges for installation or setup of the product, adjustment of customer controls on the product, and installation or repair of antenna/signal source systems outside of the product.
- Product repair and/or part replacement because of improper installation or maintenance, connections to improper voltage supply, power line surge, lightning damage, retained images or screen markings resulting from viewing fixed stationary content for extended periods, product cosmetic appearance items due to normal wear and tear, unauthorized repair or other cause not within the control of the company.
- Damage or claims for products not being available for use, or for lost data or lost software.
- Damage from mishandled shipments or transit accidents when returning product.
- A product that requires modification or adaptation to enable it to operate in any country other than the country for which it was designed, manufactured, approved and/or authorized, or repair of products damaged by these modifications.
- A product used for commercial or institutional purposes (including but not limited to rental purposes).
- Product lost in shipment and no signature verification receipt can be provided.
- Failure to operate per Owner's Manual.

### TO OBTAIN ASSISTANCE...

Contact the Customer Care Center at:  
1-866-309-0841

REPAIR OR REPLACEMENT AS PROVIDED UNDER THIS WARRANTY IS THE EXCLUSIVE REMEDY FOR THE CONSUMER, WITH THE ISSUING COMPANY NOT LIABLE FOR ANY INCIDENTAL OR CONSEQUENTIAL DAMAGES FOR BREACH OF ANY EXPRESS OR IMPLIED WARRANTY ON THIS PRODUCT. EXCEPT TO THE EXTENT PROHIBITED BY APPLICABLE LAW, ANY IMPLIED WARRANTY OF MERCHANTABILITY OR FITNESS FOR A PARTICULAR PURPOSE ON THIS PRODUCT IS LIMITED IN DURATION TO THE DURATION OF THIS WARRANTY.

Some states do not allow the exclusions or limitation of incidental or consequential damages, or allow limitations on how long an implied warranty lasts, so the above limitations or exclusions may not apply to you.

*This warranty gives you specific legal rights. You may have other rights which vary from state/province to state/province.*

P&F USA, Inc. PO Box 430 Daleville, IN 47334-0430

061708

# 13 Index

## A

Antenna, connect	9
Audio	20
Audio Setting	20
Auto mode	20
Auto TV on	25
Auto volume leveling	20

## C

Cables	
component	34
composite	34
connection quality	34
HDMI	34
Manage cables	10
YPbPr	34
Channels	
install	30
lock	23
Child lock	
Channel lock	23
PIN	22
ratings lock	22, 23, 24
Clock	21
Closed caption	21, 22
Connection	9, 33, 35
Customer support service	5

## D

Device List	25
Device lock	14

## E

EasyLink	25
ENERGY STAR®	4, 11
Environmental care	5
Equalizer	20

## F

FAV	20, 21
-----	--------

## H

Home mode	11, 26
-----------	--------

## I

Initial Setup	11
---------------	----

## L

Location (Retail or Home mode)	11, 26
--------------------------------	--------

## M

Master EasyLink	25
-----------------	----

## P

PC	15
Picture format	19
Picture settings	18
Product information	39

## R

Ratings	22, 23, 24
Remote control	
insert batteries	8
overview	6, 7
Retail store mode	11, 26
RC key forwarding	14, 25

## S

Settings assistant	11, 18
Side controls	6
Signal quality	34
Sleeptimer	22
Software	
update	31
version	31
Speakers EasyLink	20, 29
Standby	6, 12
Stand mount the TV	8

## T

Troubleshooting	38
TV	
as PC monitor	19, 20, 37
connections	9, 33, 35
controls	6, 7
menu	14
position	8
remote control	6, 7, 8
screen care	5
software	31
switch channels	12
switch on	11, 12
TV Speakers	20

## U

USB	28, 29
-----	--------

## V

Volume	
adjust	13
Auto Volume Leveling	20
mute	13

## W

Warranty	40
----------	----

## Y

YPbPr	34
-------	----





**P&F USA, Inc.**  
**PO Box 430 Daleville, IN 47334-0430**

**P&F Mexicana, S.A. de C.V.**  
**Av. La Palma No. 6, Col. San Fernando La Herradura,**  
**Huixquilucan Edo. de México C.P. 52787**

**TELEVISOR A COLOR DE CRISTAL LIQUIDO (LCD)**

MODELO	LCD	IMAGEN VISIBLE	ENERGIA
55PFL7705D/F7	55"(139,70cm)	138,78cm	120V ~ 60Hz 200W
46PFL7705D/F7	46"(116,84cm)	116,81cm	120V ~ 60Hz 165W
40PFL7705D/F7	40"(101,60cm)	101,60cm	120V ~ 60Hz 155W

**Comercializado por :** P&F MEXICANA, S.A. DE C.V.

**IMPORTADOR :** SOJITZ MEXICANA, S.A. DE C.V.  
Av. Paseo de las Palmas No. 239-302  
Col. Lomas de Chapultepec, C.P. 11000  
México, D.F. Tel. 52 (55) 5202 - 7222

**EXPORTADOR :** FUNAI ELECTRIC CO. L.T.D.

**PAIS DE ORIGEN :** CHINA

**GARANTIA INCLUIDA EN EL INSTRUCTIVO DE USO**



**LEA CUIDADOSAMENTE ESTE INSTRUCTIVO  
ANTES DE USAR SU APARATO.**