

Register your product and get support at  
[www.philips.com/welcome](http://www.philips.com/welcome)



52PFL7704D  
47PFL7704D  
42PFL7704D  
32PFL7704D  
52PFL6704D  
47PFL6704D  
42PFL6704D  
32PFL6704D

---

EN User manual

---

FR Manuel d'utilisation

---

ES Manual del usuario

---

**EN:** For further assistance, call the customer support service in your country.

- To obtain assistance in the U.S.A., Puerto Rico, or the U.S. Virgin Islands, contact Philips Customer Care Center at 1-866-771-4018
- To obtain assistance in Canada, contact Philips Customer Care Center at:
  - 1-800-661-6162 (French speaking)
  - 1-866-771-4018 (English speaking)
- To obtain assistance in Mexico, contact Philips Customer Care Center at 01 800 504 6200

Enter below the model and serial numbers located on the back and right side of the TV cabinet.

**FR:** Pour obtenir de l'aide supplémentaire, communiquez avec le centre de service à la clientèle de votre pays.

- Pour obtenir de l'aide aux États-Unis, à Puerto Rico ou aux Îles Vierges américaines, communiquez avec le centre de service à la clientèle Philips au : 1-866-771-4018
- Pour obtenir de l'aide au Canada, communiquez avec le centre de service à la clientèle Philips au :
  - 1-800-661-6162 (pour un service en français)
  - 1-866-771 4018 (pour un service en anglais)
- Pour obtenir l'aide au Mexique, entrez en contact avec le centre de soin de client de Philips à 01 800 504 6200

Entrer ci dessous le modèle et le numéro de série situés derrière à droite sur le dos du téléviseur.

**ES:** Para obtener más información, llame al servicio de soporte al cliente de su país.

- Para obtener asistencia en los Estados Unidos, Puerto Rico o en las Islas Vírgenes de los Estados Unidos, comuníquese con Centro de atención al cliente de Philips al 1-866-771-4018
- Para obtener asistencia en Canadá, comuníquese con Philips Customer Care Center al:
  - 1-800-661-6162 (en francés)
  - 1-866-771-4018 (en inglés)
- Solo para México CENTRO DE ATENCIÓN A CLIENTES LADA. 01 800 504 6200 Solo Para México.

Escriba a continuación el modelo y número de serie que están localizados en lado derecho y parte posterior de el gabinete de el televisor.

Model / Modèle / Modelo :  
Serial / Série / Serie:

**PHILIPS**



# Contents

<b>1 Notice</b>	4	<b>9 Connect devices</b>	28
<b>2 Important</b>	5	Connection overview	28
Product information	5	Select your connection quality	29
Screen care	5	Label your connections	29
Environmental care	5	Connect your devices	30
<b>3 Your TV</b>	6	<b>10 Troubleshooting</b>	33
Side controls and indicators	6	<b>11 Notes for the use of USB devices</b>	34
Remote control	6	<b>12 Product information</b>	35
<b>4 Get started</b>	8	<b>13 Warranty</b>	36
Position the TV	8	<b>14 Index</b>	37
Insert the remote control batteries	8		
Connect the antenna or cable	8		
Connect the power cord	9		
Manage cables	9		
Switch on and set up the TV	12		
<b>5 Use your TV</b>	11		
Switch your TV on/off or to standby	11		
Switch channels	11		
Adjust volume	11		
Watch channels from a set-top box	12		
Watch connected devices	12		
Watch a DVD	12		
<b>6 Use more of your TV</b>	13		
Use the quick access menu	13		
Change picture and sound settings	13		
Use Auto Mode	15		
Create and use lists of favorite channels	15		
Set the clock	15		
Use child control and rating locks	16		
View closed captions (subtitles)	19		
View photos, play music, and watch videos on a USB device	20		
Watch videos on a USB device	22		
Use your TV in HD mode	22		
Use your TV as a PC monitor	23		
Use Philips EasyLink	23		
Use the demo mode	24		
<b>7 Install channels</b>	25		
Select your menu language	25		
Set your location to home	25		
Automatically install channels	25		
Optimize the signal quality from your antenna	25		
Uninstall and reinstall channels	26		
Return your settings to default values	26		
Show emergency alerts (EAS)	26		
<b>8 Update your TV software</b>	27		
Check your current software version	27		
Prepare for the software upgrade	27		
Upgrade software	27		

**Return your Product Registration Card or register online at  
www.philips.com/welcome today to get the very most from your purchase.**

Registering your model with PHILIPS makes you eligible for all of the valuable benefits listed below, so don't miss out. Complete and return your Product Registration Card at once, or register online at [www.philips.com/welcome](http://www.philips.com/welcome) to ensure:

**\*Proof of Purchase**

Returning the enclosed card guarantees that your date of purchase will be on file, so no additional paperwork will be required from you to obtain warranty service.

**\*Product Safety Notification**

By registering your product, you'll receive notification - directly from the manufacturer - in the rare case of a product recall or safety defect.

**\*Additional Benefits**

Registering your product guarantees that you'll receive all of the privileges to which you're entitled, including special money-saving offers.

**PHILIPS**

***Congratulations on your purchase, and welcome to the "family!"***

**Dear PHILIPS product owner:**

Thank you for your confidence in PHILIPS. You've selected one of the best-built, best-backed products available today. We'll do everything in our power to keep you happy with your purchase for many years to come.

As a member of the PHILIPS "family," you're entitled to protection by one of the most comprehensive warranties and outstanding service networks in the industry. What's more, your purchase guarantees you'll receive all the information and special offers for which you qualify, plus easy access to accessories from our convenient home shopping network.

Most importantly, you can count on our uncompromising commitment to your total satisfaction.

All of this is our way of saying welcome - and thanks for investing in a PHILIPS product.

**P.S. To get the most from your PHILIPS purchase, be sure to complete and return your Product Registration Card at once, or register online at:**

**[www.philips.com/welcome](http://www.philips.com/welcome)**

Know these **safety** symbols



**⚡** This "bolt of lightning" indicates uninsulated material within your unit may cause an electrical shock. For the safety of everyone in your household, please do not remove product covering.

**⚠** The "exclamation point" calls attention to features for which you should read the enclosed literature closely to prevent operating and maintenance problems.

**WARNING:** To reduce the risk of fire or electric shock, this apparatus should not be exposed to rain or moisture and objects filled with liquids, such as vases, should not be placed on this apparatus.

**CAUTION:** To prevent electric shock, match wide blade of plug to wide slot, fully insert.

**ATTENTION:** Pour éviter les choc électriques, introduire la lame la plus large de la fiche dans la borne correspondante de la prise et pousser jusqu'au fond.

**For Customer Use**

Enter below the model and serial numbers located on the back and right side of the TV cabinet. Retain this information for future reference.

Model No. \_\_\_\_\_

Serial No. \_\_\_\_\_

**PHILIPS**

Visit our World Wide Web Site at <http://www.philips.com/welcome>

## IMPORTANT SAFETY INSTRUCTIONS

### Read before operating equipment

1. Read these instructions.
2. Keep these instructions.
3. Heed all warnings.
4. Follow all instructions.
5. Do not use this apparatus near water.
6. Clean only with a dry cloth.
7. Do not block any of the ventilation openings. Install in accordance with the manufacturers instructions.
8. Do not install near any heat sources such as radiators, heat registers, stoves, or other apparatus (including amplifiers) that produce heat.
9. Do not defeat the safety purpose of the polarized or grounding-type plug. A polarized plug has two blades with one wider than the other. A grounding type plug has two blades and third grounding prong. The wide blade or third prong are provided for your safety. When the provided plug does not fit into your outlet, consult an electrician for replacement of the obsolete outlet.
10. Protect the power cord from being walked on or pinched particularly at plugs, convenience receptacles, and the point where they exit from the apparatus.
11. Only use attachments/accessories specified by the manufacturer.
12.  Use only with a cart, stand, tripod, bracket, or table specified by the manufacturer, or sold with the apparatus. When a cart is used, use caution when moving the cart/apparatus combination to avoid injury from tip-over.
13. Unplug this apparatus during lightning storms or when unused for long periods of time.
14. Refer all servicing to qualified service personnel. Servicing is required when the apparatus has been damaged in any way, such as power-supply cord or plug is damaged, liquid has been spilled or objects have fallen into apparatus, the apparatus has been exposed to rain or moisture, does not operate normally, or has been dropped.
15. This product may contain lead or mercury. Disposal of these materials may be regulated due to environmental considerations. For disposal or recycling information, please contact your local authorities or the Electronic Industries Alliance: [www.eiae.org](http://www.eiae.org).
16. **Damage Requiring Service** - The appliance should be serviced by qualified service personnel when:
  - A. The power supply cord or the plug has been damaged; or
  - B. Objects have fallen, or liquid has been spilled into the appliance; or
  - C. The appliance has been exposed to rain; or
  - D. The appliance does not appear to operate normally or exhibits a marked change in performance; or
  - E. The appliance has been dropped, or the enclosure damaged.
17. **Tilt/Stability** - All televisions must comply with recommended international global safety standards for tilt and stability properties of its cabinets design.
  - Do not compromise these design standards by applying excessive pull force to the front, or top, of the cabinet which could ultimately overturn the product.
  - Also, do not endanger yourself, or children, by placing electronic equipment/toys on the top of the cabinet. Such items could unsuspectingly fall from the top of the set and cause product damage and/or personal injury.
18. **Wall or Ceiling Mounting** - The appliance should be mounted to a wall or ceiling only as recommended by the manufacturer.
19. **Power Lines** - An outdoor antenna should be located away from power lines.
20. **Outdoor Antenna Grounding** - If an outside antenna is connected to the receiver, be sure the antenna system is grounded so as to provide some protection against voltage surges and built up static charges. Section 810 of the National Electric Code, ANSI/NFPA No. 70-1984, provides information with respect to proper grounding of the mats and supporting structure grounding of the lead-in wire to an antenna-discharge unit, size of grounding connectors, location of antenna-discharge unit, connection to grounding electrodes and requirements for the grounding electrode. See Figure below.
21. **Objects and Liquid Entry** - Care should be taken so that objects do not fall and liquids are not spilled into the enclosure through openings.
  - a) **Warning:** To reduce the risk of fire or electric shock, this apparatus should not be exposed to rain or moisture and objects filled with liquids, such as vases should not be placed on this apparatus.
22. **Battery Usage CAUTION** - To prevent battery leakage that may result in bodily injury, property damage, or damage to the unit:
  - Install all batteries correctly, with + and - alignment as marked on the unit.
  - Do not mix batteries (old and new or carbon and alkaline, etc.)
  - Remove batteries when the unit is not used for a long time.

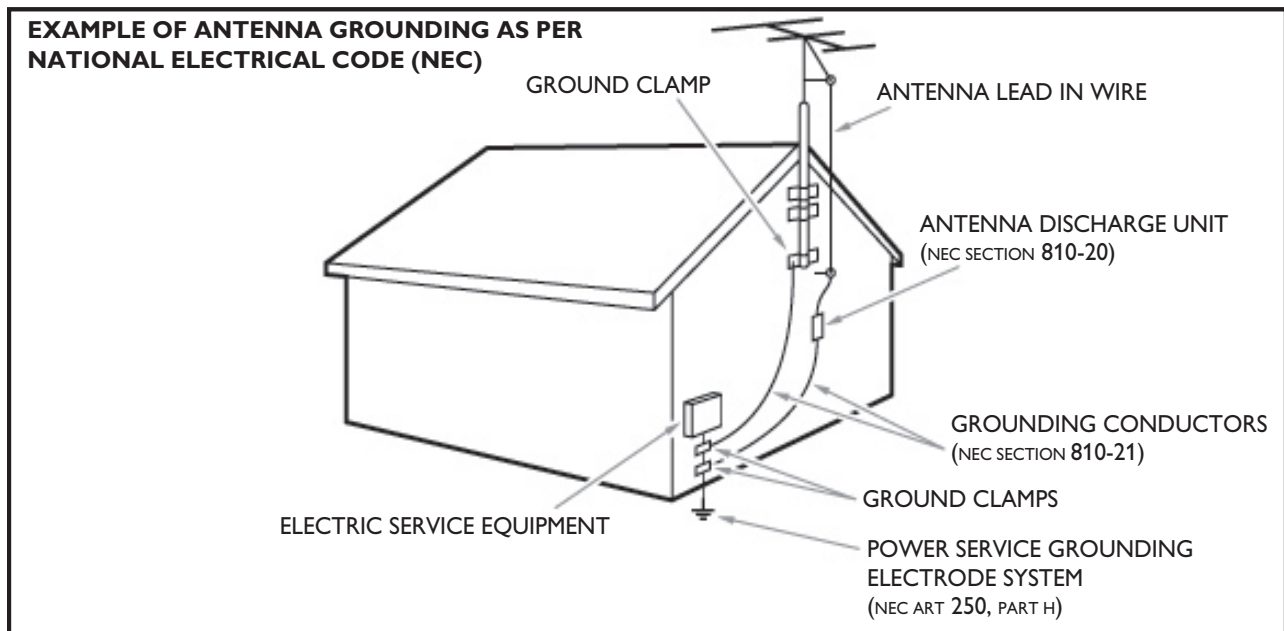

**Note to the CATV system installer:** this reminder is provided to call the CATV system installer's attention to Article 820-40 of the NEC that provides guidelines for proper grounding and, in particular, specifies that the cable ground shall be connected to the grounding system of the building, as close to the point of cable entry as practical.

# 1 Notice

2009 © Koninklijke Philips Electronics N.V. All rights reserved. Specifications are subject to change without notice. Trademarks are the property of Koninklijke Philips Electronics N.V. or their respective owners. Philips reserves the right to change products at any time without being obliged to adjust earlier supplies accordingly. The material in this manual is believed adequate for the intended use of the system. If the product, or its individual modules or procedures, are used for purposes other than those specified herein, confirmation of their validity and suitability must be obtained. Philips warrants that the material itself does not infringe any United States patents. No further warranty is expressed or implied. Philips cannot be held responsible neither for any errors in the content of this document nor for any problems as a result of the content in this document. Errors reported to Philips will be adapted and published on the Philips support website as soon as possible.

## Pixel characteristics

This LCD product has a high number of color pixels. Although it has effective pixels of 99.999% or more, black dots or bright points of light (red, green or blue) may appear constantly on the screen. This is a structural property of the display (within common industry standards) and is not a malfunction.

## Warranty

No components are user serviceable. Do not open or remove covers to the inside of the product. Repairs may only be done by Philips Service Centers and official repair shops. Failure to do so shall void any warranty, stated or implied.

Any operation expressly prohibited in this manual, any adjustments, or assembly procedures not recommended or authorized in this manual shall void the warranty.

## Federal Communications Commission Notice

This equipment has been tested and found to comply with the limits for a Class B digital device, pursuant to part 15 of the FCC Rules. These limits are designed to provide reasonable protection against harmful interference in a residential installation. This equipment generates, uses, and can radiate radio frequency energy and, if not installed and used in accordance with the instructions, may cause harmful interference to radio communications. However, there is no guarantee that interference will not occur in a particular installation. If this equipment does cause harmful interference to radio or television reception, which can be determined by turning the equipment off and on, the user is encouraged to try to correct the interference by one or more of the following measures:

- Reorient or relocate the receiving antenna.
- Increase the separation between the equipment and the receiver.
- Connect the equipment into an outlet on a circuit different from that to which the receiver is connected.
- Consult the dealer or an experienced radio or television technician for help.

## Modifications

The FCC requires the user to be notified that any changes or modifications made to this device that are not expressly approved by Philips Consumer Electronics may void the user's authority to operate the equipment.

## Declaration of Conformity

**Trade Name:** PHILIPS  
**Responsible Party:** P&F USA Inc.  
**Model:** 52PFL7704D, 47PFL7704D, 42PFL7704D, 32PFL7704D, 52PFL6704D, 47PFL6704D, 42PFL6704D, 32PFL6704D  
**Address:** PO Box 672768 Marietta, GA 30006 U.S.A.  
**Telephone Number:** 866-771-4018

## Cables

Connections to this device must be made with shielded cables with metallic RFI/EMI connector hoods to maintain compliance with FCC Rules and Regulations.

## Canadian notice

This Class B digital apparatus meets all requirements of the Canadian Interference-Causing Equipment Regulations.

## Copyright

All other registered and unregistered trademarks are the property of their respective owners.



Manufactured under license from Dolby Laboratories. "Dolby" and the double-D symbol are trademarks of Dolby Laboratories.



VESA, FDMI and the VESA Mounting Compliant logo are trademarks of the Video Electronics Standards Association.



® Kensington and Micro Saver are registered US trademarks of ACCO World corporation with issued registrations and pending applications in other countries throughout the world.



DivX® is a registered trademark of DivX, Inc., and is used under license.

Portions of this software are copyright © The FreeType Project ([www.freetype.org](http://www.freetype.org)).

## 2 Important

Registering your model with Philips makes you eligible for all of the valuable benefits listed below, so don't miss out. Complete and return your Product Registration Card at once, or register online at [www.philips.com/welcome](http://www.philips.com/welcome) to ensure:

- **Proof of Purchase**  
Returning the enclosed card guarantees that your date of purchase is on file, so no additional paperwork is required from you to obtain warranty service.
- **Product Safety Notification**  
By registering your product you receive notification - directly from the manufacturer - in the rare case of a product recall or safety defect.
- **Additional Benefits of Product Ownership**

Registering your product guarantees that you receive all of the privileges to which you're entitled, including special money-saving offers.

---

### For further assistance

For further assistance, call the customer support service in your country.

- To obtain assistance in the U.S.A., Puerto Rico, or the U.S. Virgin Islands, contact Philips Customer Care Center at 1-866-771-4018
- To obtain assistance in Canada, contact Philips Customer Care Center at:
  - 1-800-661-6162 (French speaking)
  - 1-866-771-4018 (English speaking)

---

### Product information

This TV consumes minimal energy in standby mode to minimize environmental impact. The active power consumption is given on the type plate at the back of the TV. The model and serial number of your TV can be found on the back and right side of the TV as well as on the packaging.

---

### Screen care

- Avoid stationary images as much as possible. Stationary images are images that remain on-screen for extended periods of time. Examples include: on-screen menus, black bars and time displays. If you must use stationary images, reduce screen contrast and brightness to avoid screen damage.
- Unplug the TV before cleaning.
- Clean the TV screen and frame with a soft, damp cloth. Never use substances such as alcohol, chemicals or household cleaners on the TV screen.
- Risk of damage to the TV screen! Never touch, push, rub or strike the screen with any object.
- To avoid deformations and color fading, wipe off water drops as soon as possible.

---

### Environmental care

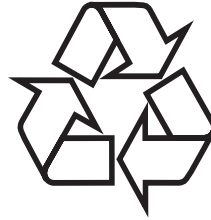

The packaging of this product is intended to be recycled. Contact your local authorities for information about how to recycle the packaging.

#### End of life directives



Like all LCD products, this set contains a lamp with mercury; please dispose of according to all local, state and federal laws. Philips pays a lot of attention to produce environment-friendly products in green focal areas. Your new TV contains materials which can be recycled and reused. At the end of its life, specialized companies can dismantle the discarded TV to concentrate the reusable materials and to minimize the amount of materials to be disposed of. Please ensure you dispose of your old TV according to local regulations.

#### Disposal of used batteries

The batteries supplied do not contain the heavy metals mercury and cadmium. Nevertheless, in many areas, batteries may not be disposed of with your household waste. Please ensure you dispose of batteries according to local regulations.

# 3 Your TV

Congratulations on your purchase, and welcome to Philips! To fully benefit from the support that Philips offers, register your product at [www.philips.com/welcome](http://www.philips.com/welcome).

## Side controls and indicators

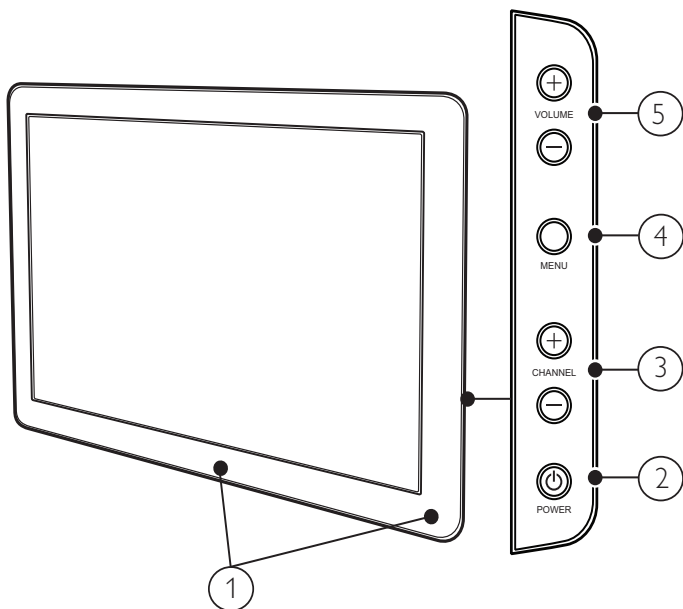

- ① Standby indicator / remote control sensor (location may vary)
- ② POWER: Switches the TV on or off. The TV is not powered off completely unless it is physically unplugged.
- ③ CHANNEL +/-: Switches to the next or previous channel.
- ④ MENU: Toggles the main menu on or off.
- ⑤ VOLUME +/-: Increases or decreases volume.

## Remote control

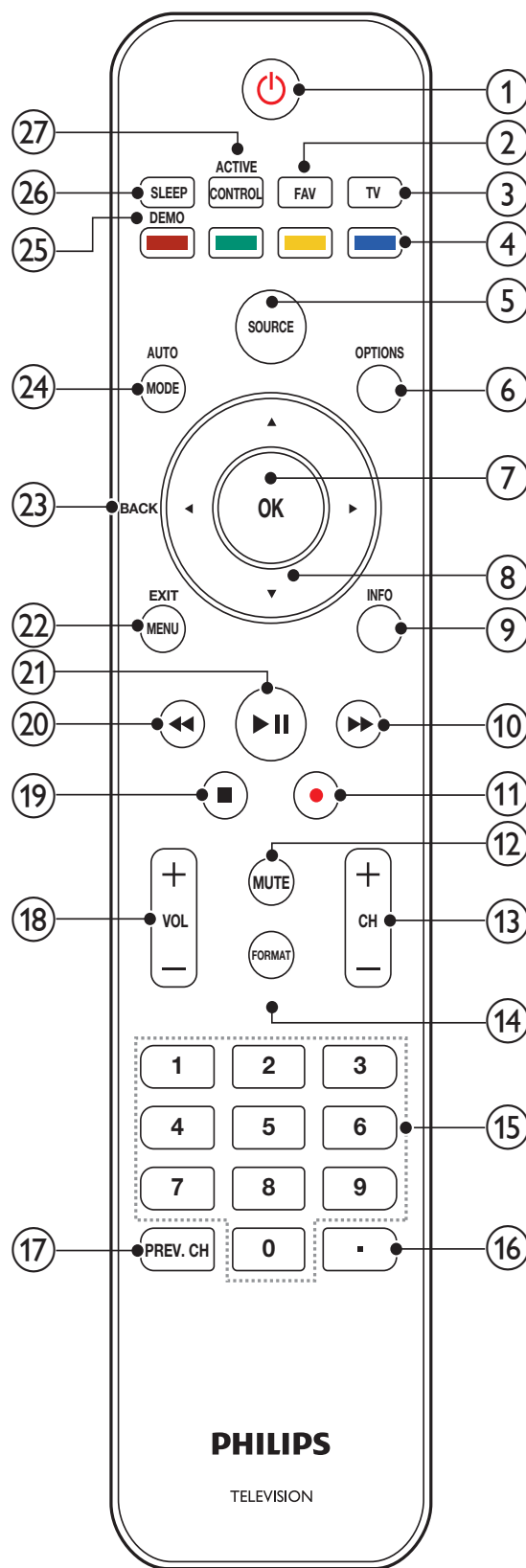

- ① **⏻ (Standby-On)**  
Switches the TV on or off. The TV is not powered off completely unless it is physically unplugged.
- ② **FAV**  
Displays a list of all channels marked as favorite.



- ③ **TV**  
Switches back to the antenna source from EasyLink mode.
- ④ **Color buttons**  
Selects tasks or options.
- ⑤ **SOURCE**  
Selects connected devices.
- ⑥ **OPTIONS**  
Activates the quick access menu (see 'Use the quick access menu' on page 13).
- ⑦ **OK**  
Activates a selection or accesses the menu.
- ⑧ **▲▼◀▶ (Navigation buttons)**  
Navigates through the menus.
- ⑨ **INFO**  
Displays information about the TV channel or accessory device.  
The quality and accuracy of the information depends on the broadcaster. You might see a difference in broadcast time if the broadcast is from a different time zone.
- ⑩ **▶▶ (Fast Forward)**  
Searches forward on your EasyLink device.
- ⑪ **● (Record)**  
Starts or stops video recording on your EasyLink device.
- ⑫ **MUTE**  
Mutes or restores audio output.
- ⑬ **CH +/-**  
Switches to the next or previous channel.
- ⑭ **FORMAT**  
Selects a picture format.
- ⑮ **Number buttons**  
Select a channel, page or setting.
- ⑯ **. (Dot)**  
Press the dot (.) for digital channels.
- ⑰ **PREV CH**  
Returns to the previously viewed channel.
- ⑱ **VOL +/-**  
Increases or decreases volume.
- ⑲ **■**  
Stops playback on your EasyLink device.
- ⑳ **◀◀**  
Searches backward on your EasyLink device.
- ㉑ **▶▶**  
Starts, pauses or resumes playback on your EasyLink device.
- ㉒ **MENU/EXIT**  
Turns the menu on or off.
- ㉓ **BACK**  
Returns to a previous screen.
- ㉔ **AUTO MODE**  
Cycles through the preset picture and sound settings (see 'Use Auto Mode' on page 15).
- ㉕ **DEMO**  
Toggles the demo menu on or off.
- ㉖ **SLEEP**  
Sets a delay after which the TV switches to standby.

- ㉗ **ACTIVE CONTROL**  
The TV continuously measures and corrects incoming signals to provide the best picture quality.

## 4 Get started

This section supplements information in the Quick Start. For information about how to mount and install your TV, refer to the Quick Start.

### Position the TV

#### Warning

- Do not insert the power plug into the wall socket before all the connections are made.
- Large screen TVs are heavy. Two people are required to carry and handle a large screen TV.
- Before you move the TV, disconnect the cables to prevent breakage.

In addition to reading and understanding the safety instructions, consider the following before positioning your TV:

- Ensure that you always have easy access to the power cord or plug to disconnect the TV from the power.
- If the TV is mounted on a swivel base, ensure that no strain is placed on the power cord when the TV is swiveled. Strain on the power cord can loosen connections.
- The ideal viewing distance for watching TV is three times its screen size.
- Position the TV where light does not fall on the screen.
- Connect your devices before you position the TV.

### Use a Kensington lock

There is a Kensington security slot on the back of the TV. Prevent theft by looping a Kensington lock between the slot and a permanent object, such as a heavy table.

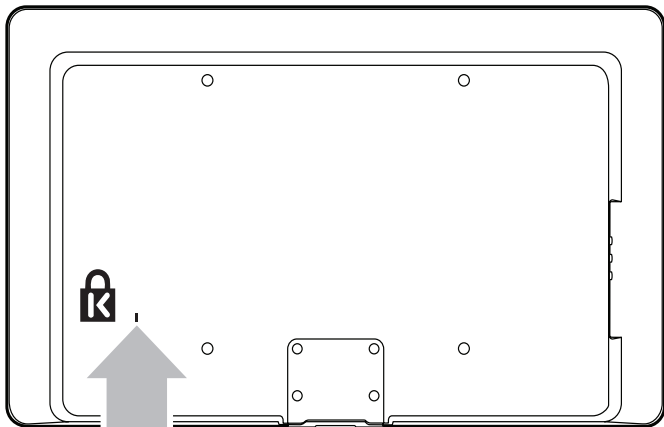

### Insert the remote control batteries

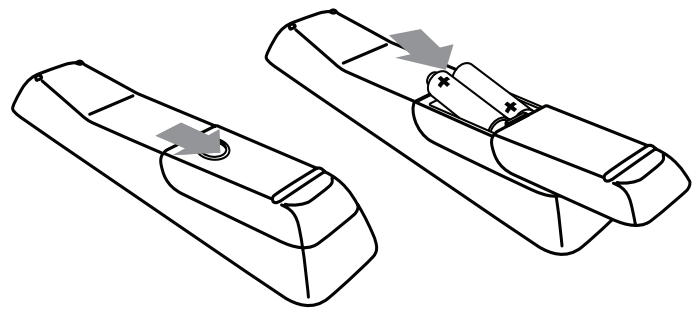

- 1 Slide the battery cover off the back of the remote control.
- 2 Insert the 2 supplied batteries (AAA). Be sure the + and - ends of the batteries line up with the markings inside the case.
- 3 Slide the cover back into position.

#### Note

- Remove the batteries if not using the remote control for an extended period of time.

### Connect the antenna or cable

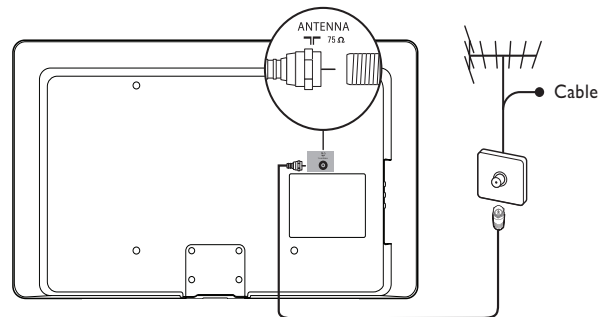

#### Connect to an antenna

Any DTV programs that are broadcast in your area can be received for free through an antenna connection.

Contact your local content provider or your local electronics retailer if you are unsure about what HDTV programs are available in your area. Broadcasters are transitioning from analog to digital TV. This means that a given broadcaster can have channels available either in analog or in digital, or both analog and digital at the same time.

The TV produces stereo sound only if a stereo signal is broadcast.

#### Connect to a cable

When your TV is connected to the cable socket, you might receive free digital and high definition programs (depending on your cable provider). The channel number for digital and high definition channels includes a dot "." For example, 11.1, 46.30, 108.201. Contact your cable provider for more information.

#### Connect to a Direct Broadcast Satellite (DBS)

There are two main DBS systems: DirecTV and DishNetwork. These systems require a separate, proprietary set-top box to decode signals and send them to the TV. The set-top box contains a digital TV tuner for receiving off-air digital broadcasts.

Contact your local DBS provider for more information about the connections and the TV channels.

### Connect to a set-top box

A cable box or satellite set-top box can be connected to the TV through the following connections:

- ANT
- A/V (Composite Video and Audio)
- S-Video
- YPbPr (Component Video Input)
- HDMI

For information about how to connect a set-top box, see the Quick Start provided.

### Connect a set-top box through RF IN/OUT

If the TV is connected to a cable box or satellite set-top box via a coaxial connection, set the TV to channel 3 or 4, or to the channel specified by the service provider.

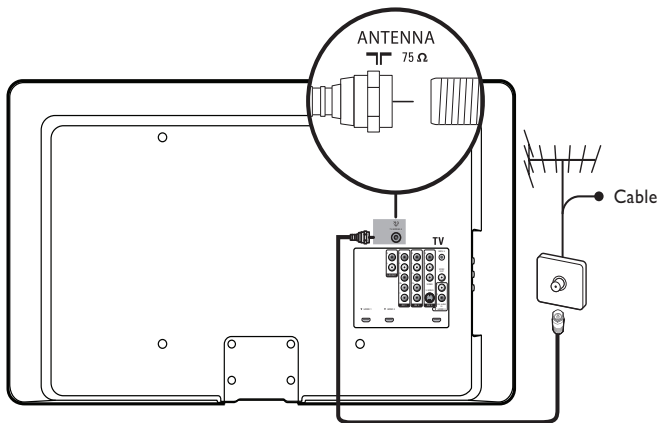

### Connect a set-top box through component video input or HDMI

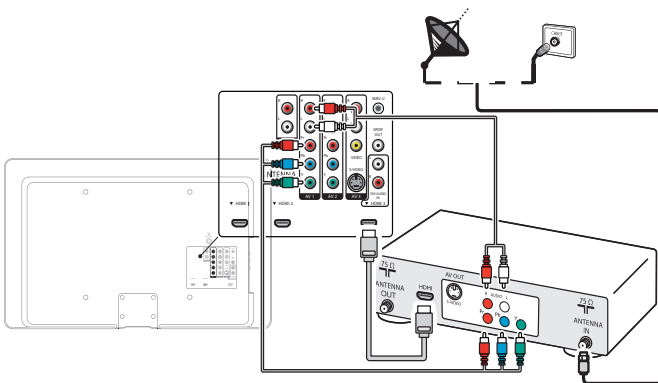

## Connect the power cord

### Warning

- Verify that your mains voltage corresponds with the voltage printed at the back of the TV. Do not insert the power cord if the voltage is different.

- 1 Locate the power connector at the back of the TV. The location of the power connector varies according to TV model.
- 2 Insert the power cord fully into the TV power connector.

- 3 Connect the power cord plug to the power outlet. Ensure that the cord is tightly secured at both ends.

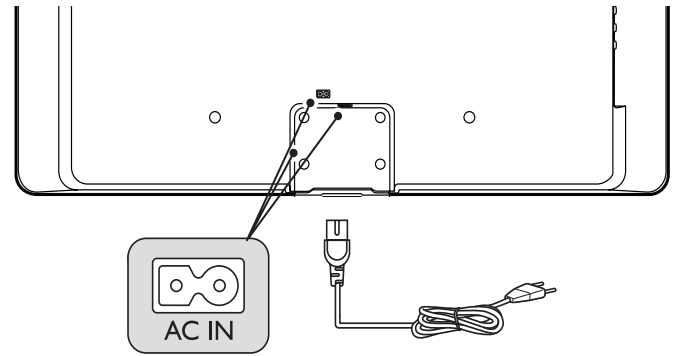

## Disconnect the TV from the power

### Caution

- Pull the power cord by the plug; do not pull on the power cord.

- 1 Unplug the power cord from the power outlet.
- 2 Unplug the power cord from the power connector at the back of the TV.

## Manage cables

### Note

- A cable holder is available in selected models only.

Route your power cord, antenna cable and all other cables through the cable holder at the back of the TV. The holder helps keep your cables tidy and easily manageable.

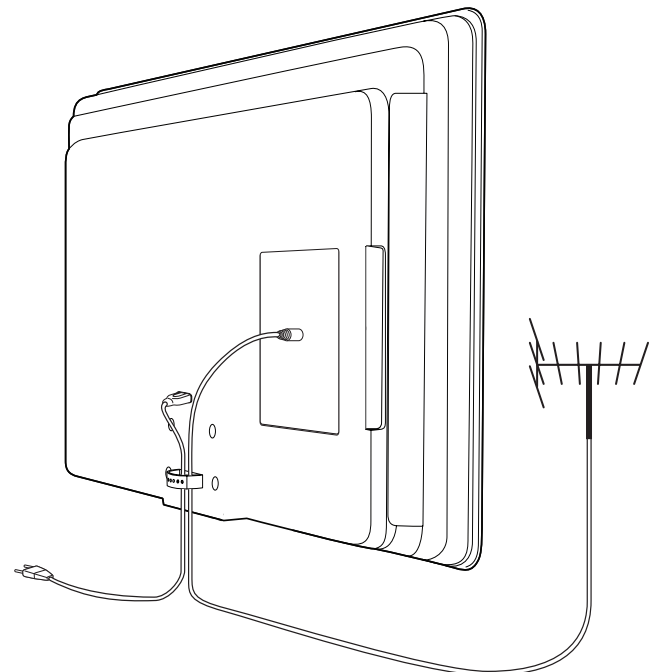

---

## Switch on and set up the TV

The TV turns on automatically after the power cord is inserted into the power connector. The following screen appears:

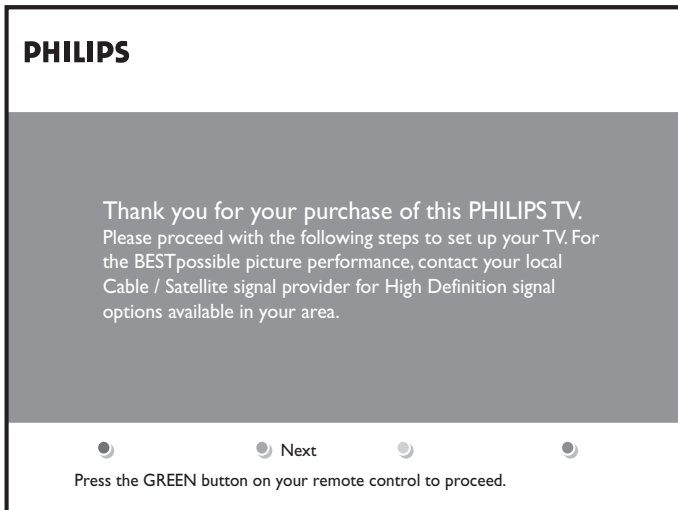

Follow the on-screen instructions to select your language and complete your TV setup. Installation takes approximately 10 minutes.

### Note

- If you connect your TV to a cable box or satellite set-top box, you do not need to install channels.

Finish the setup by selecting your location:

- If you choose **[Retail store]** your settings are erased each time you turn off the TV. Use this mode for retail store displays only.
- If you choose **[Home]** you are guided through a choice of picture display options. Press the left or right cursor buttons to select your preferred screen.

# 5 Use your TV

This section helps you perform basic TV operations.

## Switch your TV on/off or to standby

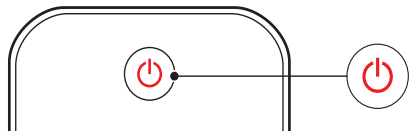
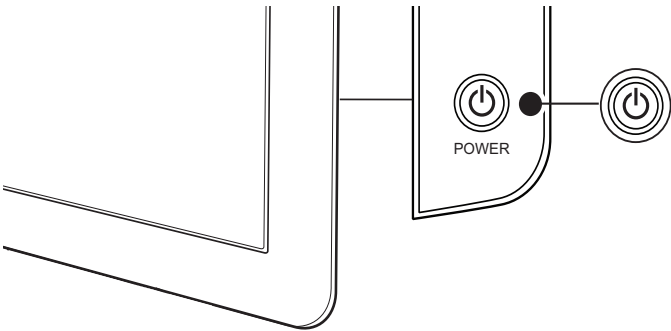

### To switch on

- Press **POWER** at the side of the TV.
- Press on the remote control.

### To switch to standby

- Press on the remote control.

### To switch off

- Press **POWER** at the side of the TV.

## Switch channels

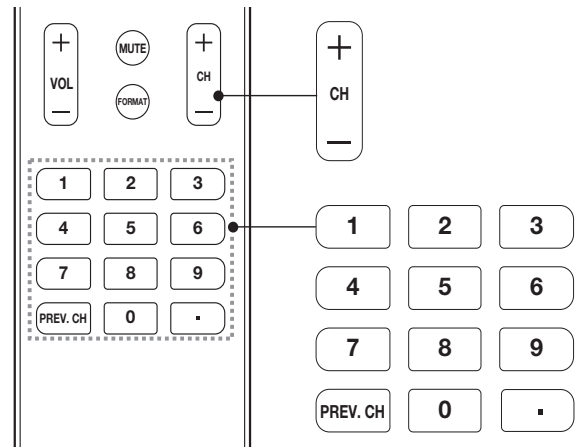
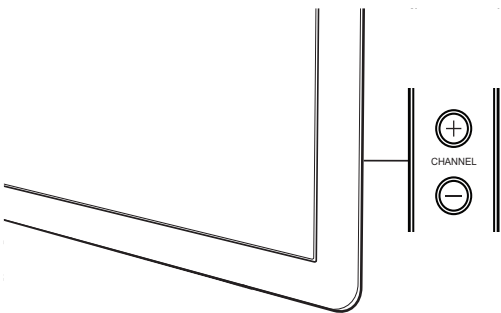

- Press **CHANNEL +/-** on the side of the TV.
- For digital channels, press a number (1 to 999) followed by a dot "." and then the corresponding sub channel number (1 to 999).  
Ex. 108.30.
- Press **CH +/-** or enter a number on the remote control.
- Press **PREV CH** to return to the previously viewed channel.

## Adjust volume

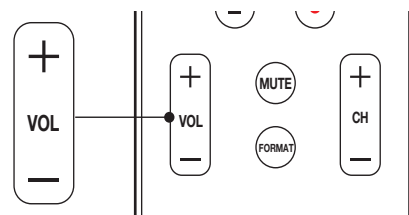
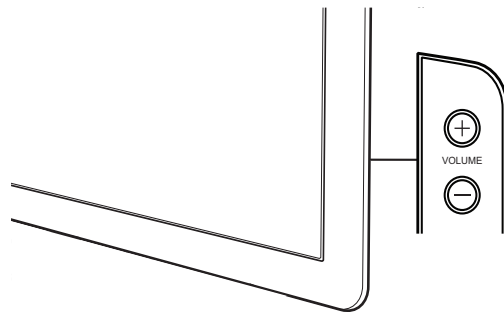

### To increase or decrease volume

- Press **VOL +/-** on the remote control or press **VOLUME +/-** on the side of the TV.

### To mute or unmute sound

- Press **MUTE** on the remote control to mute the sound.
- Press **MUTE** again to restore the sound.

### To adjust headphone volume

- Press **VOL +/-** on the remote control or press **VOLUME +/-** on the side of the TV. When headphones are plugged into the TV, the loud speakers are automatically muted.

---

## Watch channels from a set-top box

### To watch channels from a set-top box

- 1 Switch on the set-top box.
  - ↳ The picture from your set-top box might appear automatically on your screen.
- 2 Use the remote control of your set-top box to select channels.

### If the picture does not appear

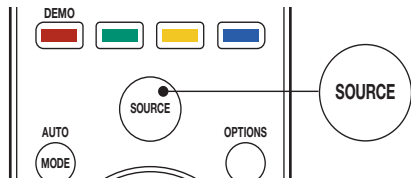

- 1 Press **SOURCE** repeatedly to select the set-top box and wait a few seconds for the picture to appear.
- 2 Use the remote control of your set-top box to select channels.

---

## Watch connected devices

### To watch connected devices

- 1 Switch on the connected device.
  - ↳ The picture from your connected device might appear automatically on the TV.
- 2 Use the remote control of the device to select channels.

### If the picture does not appear

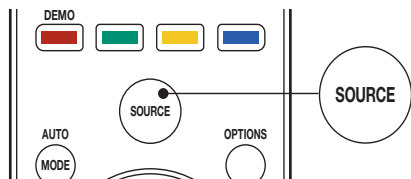

- 1 Press **SOURCE** repeatedly to select the connected device and wait a few seconds for the picture to appear.
- 2 Use the remote control of the device to select channels.

---

## Watch a DVD

### To watch a DVD

- 1 Insert a DVD disc into your player.
- 2 Press **PLAY** ► on the remote control of the DVD player.
  - ↳ The DVD might automatically play on the TV.

### If the picture does not appear

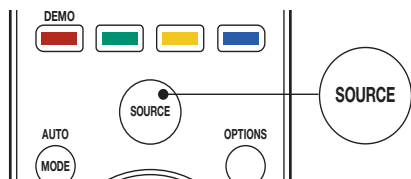

- 1 Press **SOURCE** repeatedly to select the DVD player and wait a few seconds for the picture to appear.
- 2 Use the remote control of the DVD player to play the disk.

## 6 Use more of your TV

### Use the quick access menu

The quick access menu gives direct access to some often-needed menu items.

#### Note

- When digital channels are installed and broadcast, the relevant digital options are displayed in the quick access menu.

1 Press **OPTIONS** on the remote control.

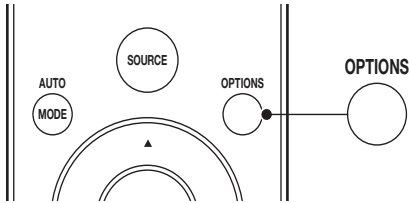

2 Press **▲** or **▼** and then **OK** to access one of the following menus:

- Audio language, for digital channels only, where multiple audio languages are broadcast.
- Closed captions (see 'View closed captions (subtitles)' on page 19).
- Picture format (see 'Summary of picture formats' on page 14).
- Equalizer (see 'Summary of sound settings' on page 15).
- Clock (see 'Set the clock' on page 15).

### Change picture and sound settings

Change picture and sound settings to suit your preferences. You can apply pre-defined settings or change settings manually.

#### Change picture settings

1 Press **MENU/EXIT** on the remote control.

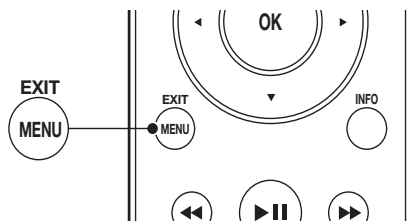

2 Press **▶** to enter the **[TV settings]** menu.

TV menu	TV settings
TV settings	Settings assistant
Features	Picture
Installation	Sound

3 Press **◀** and **▶** to select the **[Picture]** menu.

TV menu	Picture
TV Settings	Contrast
Settings assistant	Brightness
Picture	Color
Sound	Tint
	Sharpness
	Color temperature
	Dynamic contrast
	Digital Natural Motion*

\*Available in selected models

4 Press **▲** or **▼** to select one of the picture settings, and press **▶** to enter the setting.

5 Press **▲** or **▼** to adjust the setting, and press **◀** or **OK** to confirm the change.

6 Press **MENU/EXIT** to exit.

#### Change picture settings by using the setting assistant

The settings wizard helps you to configure your picture settings.

1 Press **MENU/EXIT** on the remote control.

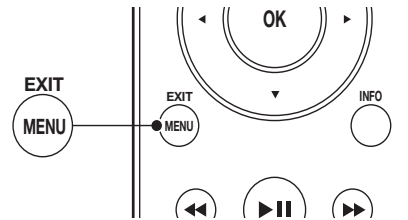

2 Press **▶** to enter the **[Settings assistant]** menu.

TV menu	Installation
TV settings	Settings assistant
Settings assistant	Start now
Picture	
Sound	

3 Press **▶** to highlight **[Start now]**, and press **OK** to start the **[Settings assistant]**.

↳ You are guided through a choice of picture display options.

4 Press the color buttons, **◀**, **▶**, and **OK** to make your selections and store your setup.

## Summary of picture settings

The following picture settings can be configured. Depending on the format of the picture source, some picture settings are not available.

- **[Contrast]:** Adjusts the intensity of bright areas, keeping dark areas unchanged.
- **[Brightness]:** Adjusts the intensity and details of dark areas.
- **[Color]:** Adjusts color saturation.
- **[Tint]:** Adjusts the color balance in an image.
- **[Sharpness]:** Adjusts the level of sharpness in image details.
- **[Color temperature]:** To set the color temperature to **[Normal]**, **[Warm]** or **[Cool]**.
- **[Dynamic contrast]:** Automatically enhances contrast in an image.
- **[Digital Natural Motion]:** In selected models only. Reduces field and line flicker to display movement smoothly.
- **[Noise Reduction]:** Automatically filters out and reduces image noise. Improves picture quality for weak video signals. You can switch DNR on or off.
- **[MPEG artifact reduction]:** Smooths out transitions on digital pictures. You can switch this feature on or off.
- **[Color enhancement]:** Makes colors more vivid and improves the resolution of details in bright colors. You can switch this feature on or off.
- **[Active Control]:** Corrects incoming signals for the best picture possible, according to lighting conditions in the room. You can switch **[Active Control]** to one of these settings: **[Off]**, **[On with light sensor]** or **[On without light sensor]**.



Tip

- Save power with Eco TV. Switch **[Active Control]** to **[On with light sensor]**. The TV will adjust the brightness according to the ambient room lighting, reducing power consumption.

- **[Picture format]:** Changes the picture format.
- **[Horizontal Shift]/[Vertical Shift]:** Adjusts the horizontal and vertical position of the picture. The availability of this settings depends on certain signals or sources.

## Change picture format

- 1 Press **FORMAT** on the remote control.

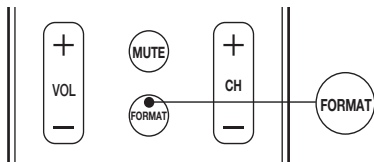

- 2 Press **▲** or **▼** to select a picture format and press **OK** to confirm your choice.

## Summary of picture formats

The following picture formats can be selected.

Depending on the format of the picture source, some picture formats are not available.

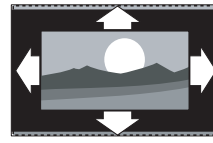

**[Automatic]:** (Not for PC mode.) Enlarges the picture automatically to best fit the screen. The subtitles remain visible.

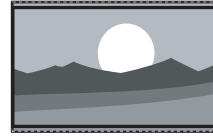

**[Super zoom]:** (Not for HD and PC mode.) Removes the black bars on the side of 4:3 broadcasts. There is minimal distortion.

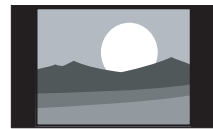

**[4:3]:** Shows the classic 4:3 format.

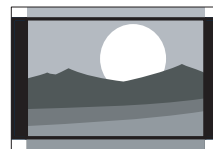

**[Movie expand 14:9]:** (Not for HD and PC mode.) Scales 4:3 format to 14:9.

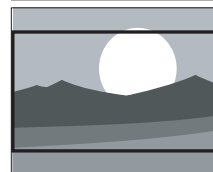

**[Movie expand 16:9]:** (Not for HD and PC mode.) Scales 4:3 format to 16:9.

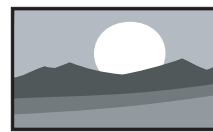

**[Wide screen]:** Stretches the classic 4:3 format to 16:9.



**[Unscaled]:** For HD and PC mode only, and in selected models only. Allows maximum sharpness. Some distortion may be present due to the broadcaster's systems. Set your PC resolution to wide screen mode for best results.

## Change sound settings

- 1 Press **MENU/EXIT** on the remote control and select **[TV settings] > [Sound]**.

TV menu	
TV Settings	Sound
Settings assistant	Equalizer
Picture	Balance
Sound	Digital audio language
	Alternate audio
	Mono/Stereo
	Incredible surround
	AVL
	TV Speakers



- 2 Press ▲ or ▼ to highlight a sound setting and press ► to select the setting.
- 3 Press ▲ or ▼ to adjust the setting, and press **OK** to confirm the change.
- 4 Press **MENU/EXIT** to exit.

## Summary of sound settings

The following sound settings can be configured. Depending on the sound source, some sound settings are not available.

- **[Equalizer]**: Adjusts individual sound frequencies.
- **[Balance]**: Adjusts the balance of the right and left speakers to best suit your listening position.
- **[Digital audio language]**: Available for digital channels only, when multiple languages are broadcast. Lists available audio languages.
- **[Alternate audio]**: Available for analog channels only, when a main and second audio program (SAP) is broadcast. Select the main or second audio program.
- **[Mono]/[Stereo]**: Selects between mono or stereo if stereo is broadcast.
- **[Incredible Surround]**: Selects available modes for surround sound.
- **[AVL] ([Auto volume leveling])**: Reduces sudden changes in volume, for example, during commercials or when switching channels. Set on or off.
- **[TV Speakers]**: Set on or off, or output sound to an EasyLink-compliant device. **[Master EasyLink]** must be activated in the **[Preferences]** menu to make the **[TV Speakers]** menu available. When **[Speakers EasyLink]** is selected, the TV speakers are disabled and TV sound outputs to the speakers of the compatible EasyLink-compliant device. Adjust the volume using the remote control of the EasyLink-compliant device.
- **[Delta volume]**: Levels out volume differences between channels or connected devices. Switch to the connected device before you change the delta volume.

## Use Auto Mode

- 1 Press **AUTO MODE** to set your TV to a predefined picture and sound setting.
- 2 Press ▲ or ▼ to select one of the following settings:
  - **[Personal]**: The customized settings you defined by using the **[Picture]** menu.
  - **[Sports]**: Vivid picture settings and clear sound for high action.
  - **[Standard]**: For normal TV viewing.
  - **[Movie]**: Brilliant picture settings for a cinematic experience.
  - **[Game]**: Optimized for PCs, games consoles and playstations.
  - **[Power Saver]**: Eco TV settings for lower power consumption.

## Create and use lists of favorite channels

You can create lists of your preferred TV channels so that you can find those channels easily.

### Select a list of favorite channels

- 1 Press the **FAV** key on the remote control.

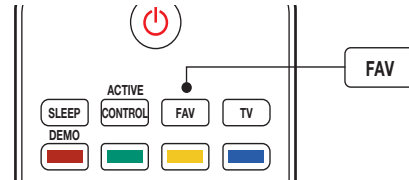

↳ Your lists of favorite channels are displayed.

- 2 Press ▲ or ▼ to highlight a list, and press **OK** to select the list.

### Create or edit a list of favorite channels

- 1 Press the **FAV** key on the remote control to display your lists of favorite channels.
- 2 Press ▲ or ▼ to highlight a list, and press **OK** to select the list.
- 3 Press the green key to enter **Edit** mode.
  - ↳ A list of channels is shown.
- 4 Press ▲ or ▼ to highlight a channel.
- 5 Press **OK** to select or deselect the highlighted channel.
  - ↳ The channel is added to or removed from the list of favorite channels.
- 6 Press the green button to exit.

### Switch to one of the channels on a list

- 1 Press **OK** on the remote control to display the last list that you selected.
- 2 Press ▲ or ▼ to highlight a channel.
- 3 Press **OK** to select the channel.
  - ↳ The TV switches to that channel.

#### Tip

- Press **CH+/-** to select channels in a list or press the numeric keys to select channels that are not in a list.

## Set the clock

You can set the time on your TV and program your TV to switch off at a specific time.

### Set the time automatically

Some digital channels transmit the time. For these channels, you can set the time automatically and choose which channel to read the time from.

- 1 Press **MENU/EXIT** on the remote control and select **[Installation] > [Clock] > [Auto clock mode]**.

- Select **[Automatic]** and press **◀** to confirm your choice.

TV menu   Installation	
Clock	Auto clock mode
Auto clock mode	Manual
Auto clock channel	Automatic
Time zone	
Daylight saving	

- (Optional) Select the channel from which the TV reads the time.
  - Press **▼** and **▶** to enter the menu for **[Auto clock channel]**.
  - Press **▲** or **▼** to highlight a channel.
  - Press **◀** to confirm your choice.
- (Optional) Select the time zone.
  - Press **▼** and **▶** to enter the menu for **[Time zone]**.
  - Press **▲** or **▼** to highlight the time zone.
  - Press **◀** to confirm your choice.
- (Optional) Set daylight saving.
  - Press **▼** and **▶** to enter the menu for **[Daylight saving]**.
  - Press **▲** or **▼** to highlight **[Automatic]** or **[Off]**.
  - Press **◀** to confirm your choice.
- Press **MENU/EXIT** to exit.

### Set the time manually

- Press **MENU/EXIT** on the remote control and select **[Installation] > [Clock] > [Auto clock mode]**.
- Select **[Manual]**, and press **◀** to confirm your choice.

TV menu   Installation	
Clock	Auto clock mode
Auto clock mode	Manual
Time	Automatic
Day	

- Press **▼** to select **[Time]** and then press **▶** to set the time. Use the format **HH:MM**. Select **[AM]/[PM]** for morning or afternoon.
- Press **OK** to confirm your choice.
- Press **▼** and **▶** to enter the menu for **[Day]**.
- Press **▲** or **▼** to select the day.
- Press **OK** to confirm your choice.
- Press **MENU/EXIT** to exit.

### Set the sleeptimer

Sleeptimer switches the TV to standby after a pre-defined period of time. You can always switch off your TV earlier or reset the sleeptimer during the countdown.

Press **SLEEP** repeatedly to select a value from 0 to 180 minutes. For example, if you select 90, the TV switches to standby in 90 minutes.

#### Tip

- To turn the sleeptimer off, select 0 minutes.

### Use child control and rating locks

You can prevent your children from watching certain programs or certain channels by locking the TV controls and by using ratings.

#### Set or change your PIN

- Press **MENU/EXIT** on the remote control and select **[Features] > [Change PIN]**.
- Enter a 4-digit PIN on the number buttons of the remote control.
  - If you have a PIN, enter your current PIN.
  - If you do not have a PIN or if you have forgotten your PIN, enter 0711.
  - You are asked to enter your new 4-digit PIN again.
- Enter your PIN again to confirm.
  - ↳ A message appears to confirm that your PIN has been changed.
- Press **MENU/EXIT** to exit.

#### Lock the TV

This section describes how to lock all channels on the TV. At the specified time, screen is blanked out and the audio is muted.

- Ensure that the clock is set with the current time (see 'Set the clock' on page 15).
- Press **MENU/EXIT** on the remote control and select **[Features] > [Child lock] > [Lock after]**.
- Enter your PIN.
- Press **▶** to select **[Timer]**.

TV menu   Features   Child lock	
Lock after	Timer
Timer	Off
Time	On

- Press **▼** to select **[On]** and activate the **[Lock after]** feature. Select **[Off]** to deactivate the feature.

- 6 Press ◀ to confirm your choice.
- 7 Press ▼ to select **[Time]** and press ▶ to set the time. Use the format HH:MM, and select **[AM]/[PM]** for morning or afternoon.
- 8 Press **OK** to confirm the time.
- 9 Press **MENU/EXIT** to exit.
- 10 Turn the TV off and on again.

## Lock a channel

This section describes how to lock specified channels. The channels can be selected but the screen is blanked out and the audio is muted.

- 1 Ensure that the clock is set with the current time (see 'Set the clock' on page 15).
- 2 Press **MENU/EXIT** on the remote control and select **[Features]** > **[Child lock]** > **[Channel lock]**.
- 3 Enter your PIN.

TV menu   Features		
Child Lock	Channel lock	
Lock after	<input type="checkbox"/> Channel 1	Sport
Channel lock	<input type="checkbox"/> Channel 2	News
TV ratings lock	<input type="checkbox"/> Channel 3	Movies
Movie ratings lock	<input type="checkbox"/> Channel 4	
Canada English ratings lock	<input type="checkbox"/> Channel 5	
Canada French ratings lock	<input type="checkbox"/> Channel 6	
Region ratings lock	<input type="checkbox"/> Channel 7	

- 4 Press ▲ or ▼ and then press **OK** to lock one or more channels or external sources.
- 5 Each channel has a box-graphic in front of it to indicate whether it is locked:
  - A box with X indicates that the channel is locked
  - An empty box indicates that the channel is not locked
- 6 Press **MENU/EXIT** to exit.

## Use the TV ratings lock

Your TV is equipped with a V-chip that allows you to control access to individual programs based on their age rating and content rating. The program content advisory data are sent by the broadcaster or by the program provider.

If you receive channels through a set-top box or cable box connected by HDMI, you cannot use the TV ratings lock. Your set-top box or cable box must be connected through RF or AV connectors.

- 1 Press **MENU/EXIT** on the remote control and select **[Features]** > **[Child lock]** > **[TV ratings lock]**.
- 2 Enter your PIN.
- 3 Press ▲ or ▼ and then press **OK** to lock or unlock one or more ratings. Each rating has a box-graphic in front of it to indicate whether programs carrying that rating are locked:
  - A box with X indicates that all items in the content ratings list are locked.
  - An empty box indicates that no items in the content ratings list are locked.

- A box with / indicates that some content ratings are deselected. For example, for rating TV-14, you can deselect one or more of the following content ratings: **[(D) Dialog]**, **[(L) Language]**, **[(S) Sex]**, or **[(V) Violence]**.

TV menu   Features   Child Lock		
TV ratings lock	TV-14	
<input type="checkbox"/> All	<input type="checkbox"/> (D)Dialog	
<input type="checkbox"/> None	<input checked="" type="checkbox"/> (L)Language	
<input type="checkbox"/> TV-Y	<input checked="" type="checkbox"/> (S)Sex	
<input type="checkbox"/> TV-Y7	<input checked="" type="checkbox"/> (V)Violence	
<input type="checkbox"/> TV-G		
<input type="checkbox"/> TV-PG		
<input checked="" type="checkbox"/> TV14		
<input checked="" type="checkbox"/> TV-MA		

When you select **[All]**, all items in the ratings list are locked. When you select **[None]**, programs with no rating and programs with a rating of None are locked. When you lock a rating, all ratings in the younger age categories are automatically locked.

- 4 Press **MENU/EXIT** to exit.

## Summary of TV ratings

Age rating	Content rating
All	None
None	None
<b>TV-Y:</b> Appropriate for children of all ages with themes and elements suitable for children aged 2-6.	None
<b>TV-Y7:</b> Programs designed for children age 7 and older.	<b>[(FV) Fantasy Violence]</b>
<b>TV-G:</b> Programs suitable for all ages. These programs contain little or no violence, no strong language and little or no sexual dialog or situations.	None
<b>TV-PG:</b> Programs contain elements that some parents may find unsuitable for younger children and which may need parental guidance. The program may contain moderate violence, sexual dialog and/or situations and some strong language.	<b>[(D) Dialog]</b> <b>[(L) Language]</b> <b>[(S) Sex]</b> <b>[(V) Violence]</b>
<b>TV-14:</b> Programs contain elements that may not be suitable for children under 14 years of age. These programs include one or more of the following: intense violence, intense sexual situations, suggestive dialog and strong language.	<b>[(D) Dialog]</b> <b>[(L) Language]</b> <b>[(S) Sex]</b> <b>[(V) Violence]</b>
<b>TV-MA:</b> Programs are designed to be viewed by adults and may be unsuitable for children under the age of 17. These programs may contain graphical violence, explicit sexual activity and/or crude or indecent language.	<b>[(L) Language]</b> <b>[(S) Sex]</b> <b>[(V) Violence]</b>

## Use the movie ratings lock

You can control viewing of movies based on their Motion Picture Association of America (MPAA) rating.

- 1 Press **MENU/EXIT** on the remote control and select **[Features]** > **[Child lock]**.
- 2 Select one of the menus for movie ratings lock.
  - In the USA, select **[Movie ratings lock]**.
  - In Canada, select **[Canada English ratings lock]** or **[Canada French ratings lock]**.
- 3 Enter your PIN.
  - ↳ The following screen shows the ratings in **[Movie ratings lock]**.

TV menu   Features	
Child Lock	Movie ratings lock
Lock after	<input checked="" type="checkbox"/> All
Channel lock	<input checked="" type="checkbox"/> NR
TV ratings lock	<input type="checkbox"/> G
Movie ratings lock	<input checked="" type="checkbox"/> PG
Canada English ratings lock	<input checked="" type="checkbox"/> PG-13
Canada French ratings lock	<input checked="" type="checkbox"/> R
Region ratings lock	<input checked="" type="checkbox"/> NC-17
	<input checked="" type="checkbox"/> X

- 4 Press **▲** or **▼** and then press **OK** to lock or unlock one or more ratings. Each rating has a box-graphic in front of it to indicate whether programs carrying that rating are locked:
  - A box with X indicates that all items in the rating are locked.
  - An empty box indicates that no items in the rating are not locked.
 When you lock a movie rating, all items for ages below that movie rating are automatically locked.
- 5 Press **MENU/EXIT** to exit.

## Use the region ratings lock

You can control access to digital programs based on downloaded region ratings. Before you download a ratings table, ensure that regional ratings are broadcast.

- 1 Press **MENU/EXIT** on the remote control and select **[Installation]** > **[Preferences]** > **[Downloaded rating table]**.

TV menu   Installation	
Preferences	Downloaded rating table
Location	Off
Show emergency alerts	On
Downloaded rating table	

- 2 Press **▲** or **▼** to select **[On]**, and press **◀** to confirm your choice. If you select Off, you choose not to download the region rating table and you cannot use the region rating lock.
- 3 Press **◀** to return to the TV menu and select **[Features]** > **[Child lock]** > **[Region ratings lock]**.

TV menu   Features	
Child Lock	Region ratings lock
Lock after	
Channel lock	Please enter your PIN
TV ratings lock	
Movie ratings lock	
Canada English ratings lock	
Canada French ratings lock	
Region ratings lock	

- 4 Enter your PIN.
- 5 Press **▲** or **▼** and then press **OK** to lock or unlock one or more ratings. Each rating has a box-graphic in front of it to indicate whether it is locked:
  - A box with X indicates that the rating locked.
  - An empty box indicates that the rating is not locked.
- 6 Press **MENU/EXIT** to exit.

## Summary of US movie ratings

Rating	Description
All	All items in the ratings list are locked.
NR	Not rated.
G	Movies with a mild content, suitable for all ages.
PG	Movies for which parental guidance is recommended. They may contain a few racy or violent scenes or maybe some bad language.
PG -13	Movies for which parental guidance may be recommended if under age 13.
R	Restricted. The movies usually contain offensive sex or bad language and may be unsuitable for children under the age of 17. Parental guidance or permission needed.
NC-17	Even with parental permission, forbidden under age 17. More offensive sex, violence or bad language.
X	Movies which generally focus on sex, violence and/or bad language. Also known as pornography.

## Summary of Canadian movie ratings

Rating	Description
All	All items in the ratings list are locked.
C	Programming suitable for children under the age of 8 years. No profanity or sexual content of any level allowed. Minimal comedic violence.
C8+	Suitable for children ages 8 and over. Low intensity violence and fantasy horror allowed.
G	Movies with a mild content, suitable for all ages.
PG	Movies for which parental guidance is recommended. They may contain a few racy or violent scenes or maybe some bad language.
14+	Programming intended for children ages 14 and over. May contain intense scenes of violence, strong profanity, and depictions of sexual activity within the context of a story.
18+	Programming intended for viewers ages 18 and over. May contain strong violence, language, and sexual activity.

## Summary of Canadian French movie ratings

Rating	Description
All	All items in the ratings list are locked.
G	Appropriate for all ages with little or no violence and little to no sexual content.
8 ans+	Appropriate for children 8 and up which may contain little violence, some foul language and/or little to no sexual content.
13 ans+	Appropriate for children 13 and up, with moderate violence, language, and some sexual situations. Persons under 13 should be accompanied by an adult.
16 ans+	Appropriate for children 16 and up, with strong violence, strong language, and strong sexual content.
18 ans+	Only to be viewed by adults and contains extreme violence and graphic sexual content/pornography.

## View closed captions (subtitles)

The caption service displays transmitted CC-, T-, and CS- text. The caption text can be displayed permanently or only when the TV is muted.

### Note

- This television provides a display of television closed captioning that conforms with the EIA-608 standard and in accordance with Sections 15.119 of the FCC rules.
- If you connect your set-top box via HDMI or component video input, you cannot select closed caption through the TV. You can select closed caption through the set-top box only.
- The captions do not always use correct spelling and grammar.
- Not all TV programs and product commercials include closed caption information. Refer to your area TV program listings for the TV channels and times of closed caption shows. The captioned programs are usually noted in the TV listings with service marks such as 'CC'.

## Closed captioning

Closed captioning is an assistive technology that allows persons with hearing disabilities to access television programming. Closed captioning displays the audio portion of programming as text superimposed over the video.

### Display captions

- 1 Press **MENU/EXIT** on the remote control and select **[Features]** > **[Caption settings]** > **[Closed captions]**.
- 2 Press **▲** or **▼** to select **[On]**, **[Off]** or **[On during mute]**, and press **◀** to confirm your choice.
- 3 Press **MENU/EXIT** to exit.

### Select caption services

- 1 Turn captions on.
- 2 Select a caption service for analog channels:
  - Press **MENU/EXIT** on the remote control and select **[Features]** > **[Caption Settings]** > **[Caption service]**.
  - Press **▶**.
  - Press **▲** or **▼** to select one of the listed caption services, and press **◀** to confirm your choice.



### Note

- Not all caption services are used by a TV channel during the transmission of a closed caption program.

- 3 Select a caption service for digital channels:
  - Press **▼** and **▶** to enter the menu for **[Digital caption service]**.
  - Press **▲** or **▼** to select one of the listed caption services, and press **◀** to confirm your choice.
- 4 Press **MENU/EXIT** to exit.

## Summary of caption services

Service	Description
CC-1, CC-2, CC-3, and CC-4	Dialog and descriptions for the action on the captioned TV program show on screen. Usually CC1 is the most used. CC 2 can be used for alternate languages if they are transmitted.
T-1, T-2, T-3 and T-4	Often used for channel guide, schedules, bulletin board information for Closed Captions programs, news, weather information, or stock market reports.
CS-1, CS-2, CS-3, CS-4, CS-5 and CS-6	Service 1 is designated as the Primary Caption Service. This service contains verbatim, or near-verbatim captions for the primary language being spoken in the accompanying program audio. Service 2 is designated as the Secondary Language Service. This service contains captions in a secondary language which are translations of the captions in the Primary Caption Service. The other service subchannels are not pre-assigned. It is up to the discretion of the individual caption provider to utilize the remaining service channels.

## Select how digital captions are displayed

You can choose the size, font, color, background and other characteristics of the caption text.

- 1 Press **MENU/EXIT** on the remote control and select **[Features]** > **[Caption settings]** > **[Digital caption options]**.
- 2 Press **▲** or **▼** to highlight an option for digital captions, and press **▶** to select the option.
- 3 Press **▲** or **▼** to highlight a setting for the option, and press **◀** to confirm your choice.
- 4 Press **MENU/EXIT** to exit.

## Difficulties viewing closed captions on DTV programming

If you have difficulties viewing closed captions on DTV programming, including HDTV, received from your subscription television provider, you should:

- consult any consumer information and manuals/guides on closed captions for DTV programming provided by your subscription television provider;
- ensure that the captioning function on your set-top box, if applicable, is turned on; and,
- ensure that the captioning function on your DTV is turned on.

If you are still unable to view closed captions on DTV programming, you should contact your subscription television provider for assistance.

## View photos, play music, and watch videos on a USB device

Your TV is fitted with a USB port that enables you to view photos, listen to music, and view videos stored on a USB device.

Further information is provided on USB devices (see 'Notes for the use of USB devices' on page 34).

Supported formats	Not-supported formats
JPEG	Progressive JPEG files
MP3	File name exceeding 128 characters
FAT/DOS-formatted memory devices	File names containing a dot character

Supported video formats		
Container	Audio codec	Video codec
ASF (.wmv)	WMA	WMV
AVI	MP3	Mpeg4, DivX311, DivX4, DivX5, Xvid
MP4	MPEG1 L3, HE-AAC	H.264
PS (.mpg)	MPEG1 L1/L2, AC3, LPCM	MPEG1, MPEG2

### Note

- Philips cannot be held responsible if your USB device is not supported, nor will Philips accept any liability for damage or loss of stored data.
- The USB device is not supplied with the TV.
- This DivX® Certified device must be registered in order to play DivX Video-on-Demand (VOD) content. Generate the DivX VOD registration code for your device and submit it during the registration process (see 'Display the DivX® registration code' on page 22).
- DivX VOD content is protected by a DivX DRM (Digital Rights Management) system that restricts playback to registered DivX Certified devices. If you try to play DivX VOD content not authorized for your device, the message "Authorization Error" will be displayed and your content will not play.

## Connect a USB storage device

- 1 Turn on the TV.
- 2 Connect the USB device to the USB port on the side of your TV.  
↳ The main menu appears automatically.

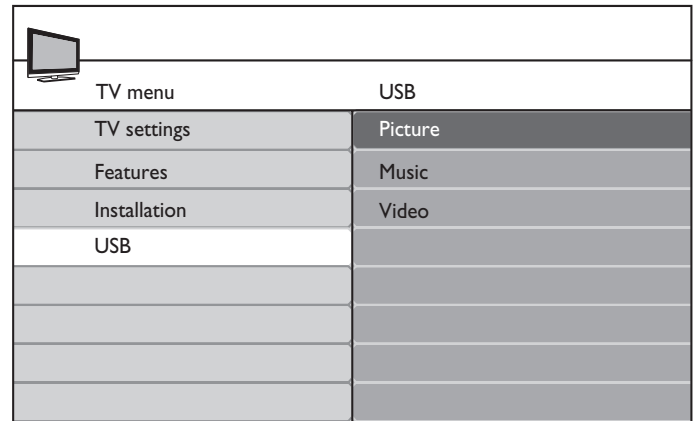

## Disconnect a USB storage device

### ! Caution

- To avoid damaging the USB device always exit the on-screen menu and wait five seconds before you remove the USB device.

- 1 Press **MENU/EXIT** to exit the on-screen menu.
- 2 Wait five seconds then remove the USB device.

## View your pictures on a USB device

- 1 Connect your USB storage device to the TV.
- 2 Press **▶** to enter the **[USB]** menu.
- 3 Press **OK**.  
↳ **[Picture]** is highlighted.

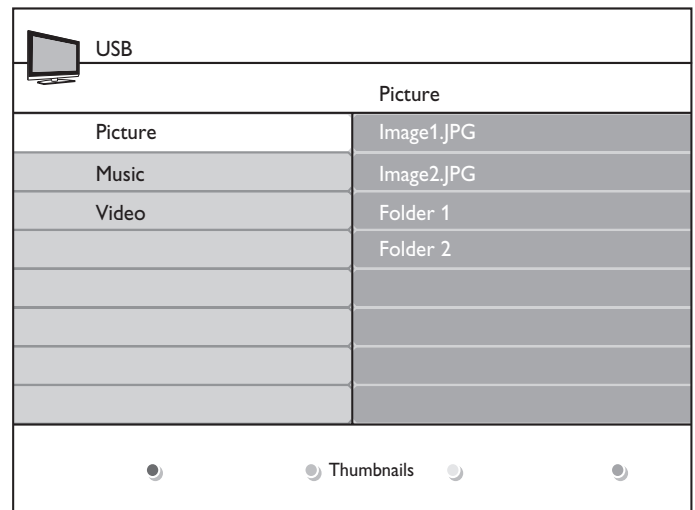

- 4 Press **▶** to enter the **[Picture]** folder.
- 5 Press **▲▼◀▶** to select a picture.  
↳ The pictures appear in a list or as thumbnails.

6 Press the green key to toggle between [List] and [Thumbnails].

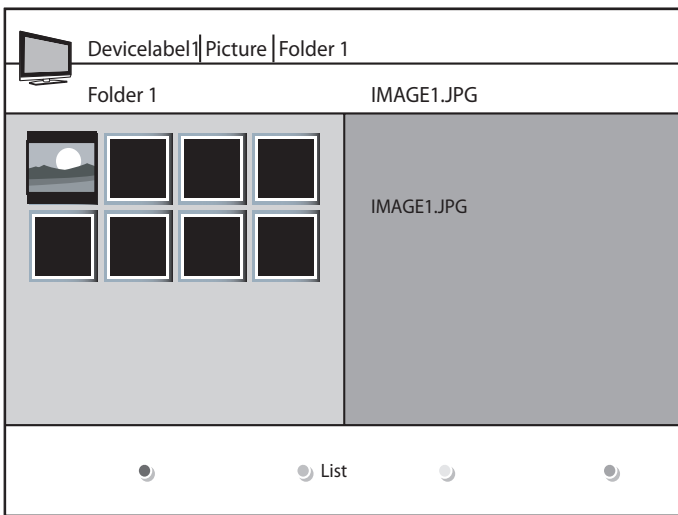
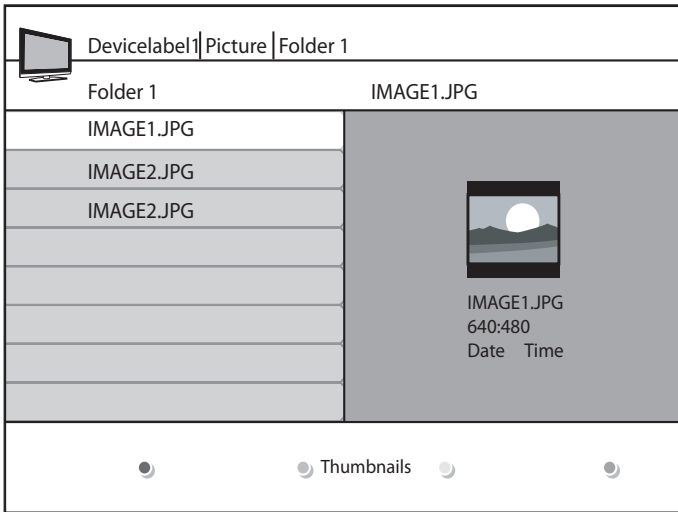

7 Press **OK** to view the picture or to start a slideshow of the pictures.

- Press the color keys on the remote control to perform the functions shown at the bottom of the screen.

#### Note

- If the function bar at the bottom of the TV screen disappears, press any color button to make it reappear.

8 Press **◀** and select another picture.

## Configure how the slideshow is played

You can configure the following features of your slideshow.

Feature	Description
[Details]/[More details]	Displays the picture name, date, size and next picture in the slide show.
[Transitions]	Displays a list of available transition styles.
[Slide time]	Sets the amount of time that a picture is shown.
[Rotate]	Rotates a picture.
[Zoom]	Displays a list of available magnifications.
[Start show]/[Stop show]	Starts or stops a slide show.

## Listen to music on a USB device

- Connect your USB storage device to the TV.
- Press **▶** to enter the [USB] menu.
- Press **OK**.
- Select [Music] and press **▶**.

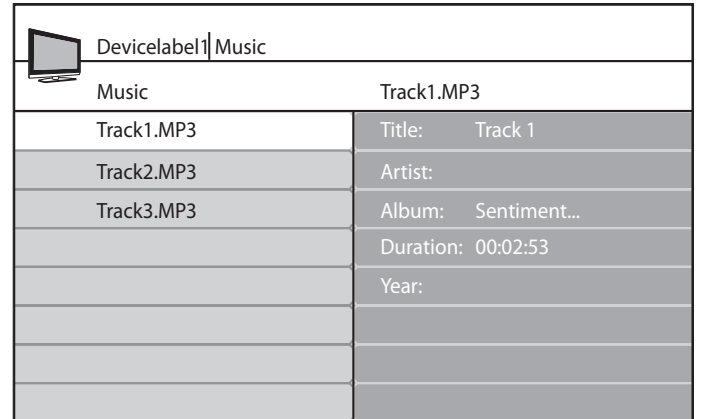

- Press **▲▼◀▶** to select a song.
- Press **OK** or **▶||** to play the selected song.
  - Press the color buttons on the remote control to perform the functions shown at the bottom of the screen.
  - Press **OK** or **▶||** to pause, press **OK** or **▶||** again to resume.
  - Press **▶▶** to fast-forward search.
  - Press **◀◀** to fast-backward search.
  - Press **■** to stop playback.

#### Note

- If the function bar at the bottom of the TV screen disappears, press any color button to make it reappear.

7 Press **◀** to select another song.

## Accompany a slideshow with music

You can accompany a slideshow with background music. The audio continues to be played even if the slideshow is stopped. The audio stops when another song is played, or when the end of the music album is reached.

- Select a music album.
- Start a slideshow.

## Display the DivX® registration code

- 1 Press **MENU/EXIT** on the remote control.
- 2 Select **[Installation] > [DivX® VOD]**.  
↳ The DivX Video On Demand registration code is displayed.

TV menu	
Installation	DivX® VOD
Language	DivX® Video on Demand  Your registration code is: XXXXXXXX  To learn more, visit <a href="http://www.divx.com/vod">www.divx.com/vod</a>
Channels	
Preferences	
Source labels	
Clock	
Current software info	
<b>DivX® VOD</b>	
Reset AV settings	

### Note

- Take note of your registration code. You will need this when you register your device before you buy or rent DivX movies.

## Watch videos on a USB device

- 1 Connect your USB storage device to the TV.
- 2 Press **▶** to enter the **[USB]** menu.
- 3 Press **OK**.
- 4 Select **[Video]** and press **▶**.

DeviceLabel1   Video	
Video	Video1.MPG
Video1.MPG	Title: Video1.MPG
Video2.MPG	Director:
Video3.MPG	Copyright:
	Date:
	Genre:
	Duration:

- 5 Press **▲▼◀▶** to select a video.
- 6 Press **OK** or **▶||** to play the selected video.
  - Press the color buttons on the remote control to perform the functions shown at the bottom of the screen.
  - Press **OK** or **▶||** to pause, press **OK** or **▶||** again to resume.
  - Press **▶▶** to fast-forward search.
  - Press **◀◀** to fast-backward search.
  - Press **■** to stop playback.

### Note

- If the function bar at the bottom of the TV screen disappears, press any color button to make it reappear.

- 7 Press **◀** to select another video.

## Use your TV in HD mode

Not all models can be configured in high definition (HD) mode. For information about your set, see the specification. When you connect an HD device to your TV, configure the display format of your TV. You might also have to configure the display format of your HD device. For information about configuring your device, see the documentation of the device.

### Supported video formats

The following video formats are supported in HD mode.

Resolution	Refresh rate
640 × 480p	60Hz
720 (1440) × 480i	60Hz
720 (1440) × 576i	50Hz
720 × 480p	60Hz
720 × 576p	50Hz
1280 × 720p	50Hz, 60Hz
1920 × 1080	50Hz, 60Hz
1920 × 1080p	24Hz, 25Hz, 30Hz, 50Hz, 60Hz

### Note

- Your TV is HDMI compliant. If you do not get a good picture, change the video format on your connected devices.

## Configure your TV in HD mode

- 1 Connect the HD device to your TV (see 'Connect your devices' on page 30).
- 2 Press **MENU/EXIT** on the remote control and select **[Features] > [Mode Selection]**.

TV menu	
Features	Mode Selection
Mode Selection	PC
Caption settings	HDTV
Sleeptimer	
Child Lock	
Change PIN	
Demo	

- 3 Select **[HDTV]** and press **◀** to confirm your choice.
- 4 If necessary, adjust the TV picture settings.
- 5 Press **MENU/EXIT** to exit.

### Note

- **[Mode Selection]** appears for the following input signals:
- 1280x720p@60 Hz
- 1920x1080p@24/25/30/50/60 Hz



## Use your TV as a PC monitor

Use an HDMI-DVI cable or an HDMI-DVI adaptor to connect a PC to your TV. For sound, add an audio cable with a stereo mini jack.

### ! Caution

- Before you connect your PC, set the PC monitor refresh rate to 60Hz.

## Supported screen resolutions

The following screen resolutions are supported in PC mode:

Resolution	Refresh rate
640 × 480	60Hz
800 × 600	60Hz
1024 × 768	60Hz
1280 × 768	60Hz
1280 × 1024	60Hz
1360 × 768	60Hz
1920 × 1080	60Hz

If necessary, adjust the picture position to the center of the screen with the cursor buttons.

## Configure your TV in PC mode

- 1 Connect the PC to your TV.
- 2 Press **MENU/EXIT** on the remote control and select **[Features]** > **[Mode Selection]**.

### ≡ Note

- **[Mode Selection]** appears for the following input signals only:
  - 720x480p@60 Hz
  - 1280x720p@60 Hz
  - 1920x1080p@24/25/30/50/60 Hz

TV menu	
Features	Mode Selection
Mode Selection	PC
Caption settings	HDTV
Sleeptimer	
Child Lock	
Change PIN	
Demo	

- 3 Select **[PC]** and press **OK** to confirm your choice.
- 4 If necessary, adjust the picture settings.

### ≡ Note

- Set the picture format to **[Unscaled]** for wide-screen PC resolutions.

- 5 Press **MENU/EXIT** to exit.

## Use Philips EasyLink

Your TV supports Philips EasyLink, which uses the HDMI CEC (Consumer Electronics Control) protocol. EasyLink-compliant devices that are connected through HDMI connectors can be controlled by a single remote control.

### ≡ Note

- Philips does not guarantee 100% interoperability with all HDMI CEC devices.

### ≡ Note

- The EasyLink-compliant device must be switched on and selected as the source.

## EasyLink features

### One-touch play

When you connect your TV to devices that support one-touch play, you can control your TV and the devices with one remote control. For example, when you press Play on your DVD remote control, your TV automatically switches to the correct channel to show the DVD content.

### One-touch standby

When you connect your TV to devices that support standby, you can use your TV remote control to put your TV and all connected HDMI devices in standby mode.

### System audio control

When you connect your TV to HDMI CEC compliant devices, your TV can switch automatically to play audio from the connected device. To use one-touch audio, you must map the audio input from the connected device to your TV. You can use the remote control from the connected device to adjust the volume.

### Remote control (RC) key forwarding

RC key forwarding allows you to control EasyLink-compliant devices using your TV remote control.

## EasyLink buttons

You can control EasyLink-compliant devices with the following buttons on the remote control of your TV.

Button	EasyLink function
(Play/Pause)	Starts, pauses or resumes playback on your EasyLink device.
(Stop)	Stops playback on your EasyLink device.
(Record)	Starts or stops video recording on your EasyLink device.
(Fast Backward)	Searches backward.
(Fast Forward)	Searches forward.
0-9 (Numeric buttons)	When EasyLink is enabled, selects a title, chapter or track.
	Navigates through the menus of the EasyLink-compliant device.
OK	Activates a selection or accesses the menu of the EasyLink-compliant device.
OPTIONS	Displays the menus of the EasyLink-compliant device. Note that when MENU/EXIT is pressed, the TV menu is displayed.
(Standby-On)	When EasyLink is enabled, switches the TV and all EasyLink devices to standby. Note that you must press and hold  (Standby-On) for at least 3 seconds for this to occur.



Tip

- Press the TV button to switch back to the antenna source from EasyLink mode.

## Enable or disable EasyLink



Note

- Do not enable EasyLink if you do not intend to use it.

- Press MENU/EXIT on the remote control.
- Select [Installation] > [Preferences] > [Master EasyLink].
- Press ▲ or ▼ to select [On] or [Off].

## Enable or disable remote control key forwarding

- Press MENU/EXIT.
- Select [Features] > [RC Key Forwarding].
- Press OK.
- Press ▲ or ▼ to highlight an HDMI connector.
- Press OK to enable RC key forwarding for the selected HDMI connector.



Note

- When RC key forwarding is enabled for an HDMI connector, the icon appears between the HDMI connector and the connection label when you press SOURCE.

## Set TV speakers to EasyLink mode

When enabled, this feature automatically turns off TV speakers when content from an EasyLink-compliant home theater system is played. Audio is played through the speakers of the home theater system.



Note

- [Master EasyLink] must be activated in the [Preferences] menu to make the [TV Speakers] menu available.

- Press MENU/EXIT.
- Press the Navigation buttons to select [TV settings] > [Sound].  
↳ The [Sound] menu appears.
- Select [TV Speakers].  
↳ The [TV Speakers] menu appears.
- Select [Speakers EasyLink].  
↳ TV speakers are set to EasyLink mode.
- Press MENU/EXIT to exit.

## Use the demo mode

You can use demonstrations to better understand the features of your TV. Some demos are not available on certain models. When a demo is available, it is displayed in the menu list.

- Press MENU on the remote control and select [Features] > [Demo].

TV menu	
Features	Demo
Caption settings	Ambilight*
Sleeptimer	120Hz*
Child lock	Pixel Plus
Change PIN	HDNM*
Demo	Power Usage

\*In selected models only

- Press ▲ or ▼ to highlight a demo, and press OK to start the demo.
- Follow the on-screen instructions to enjoy the demo.
- Press MENU/EXIT to exit.

# 7 Install channels

The first time you setup your TV, you are prompted to select a menu language and to install TV and digital radio channels (if available). This chapter provides instructions on how to reinstall and fine tune channels.

## Select your menu language

- 1 Press **MENU/EXIT** on the remote control and select **[Installation] > [Language]**.

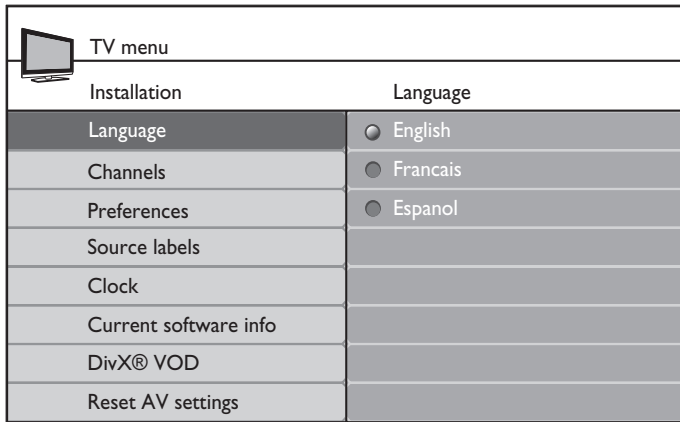

- 2 Select a language and press **OK** to confirm your choice.
- 3 Press **◀** to return to the **[Installation]** menu.

## Set your location to home

You can set the location of your TV to **home** or **retail store**. Choose **home** so that you can change the predefined settings for picture and sound.

- 1 Press **MENU/EXIT** on the remote control and select **[Installation] > [Preferences] > [Location]**.
- 2 Select **[Home]** and press **OK** to confirm your choice.
- 3 Press **◀** to return to the **[Installation]** menu.

## Automatically install channels

Before you install channels, ensure that you are registered with your cable TV provider and that your equipment is correctly connected.

- 1 Press **MENU/EXIT** on the remote control and select **[Installation] > [Channels] > [Autoprogram] > [Start now]**.

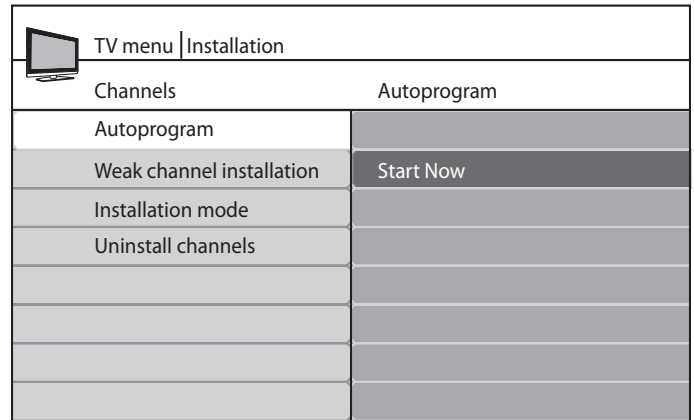

- 2 Press **OK** to start the installation.
  - If you run **[Autoprogram]** on locked channels, you must to enter your PIN code.
  - If you have forgotten your PIN, reset it.
- 3 Select **[Cable]** or **[Antenna]** and press **OK**.

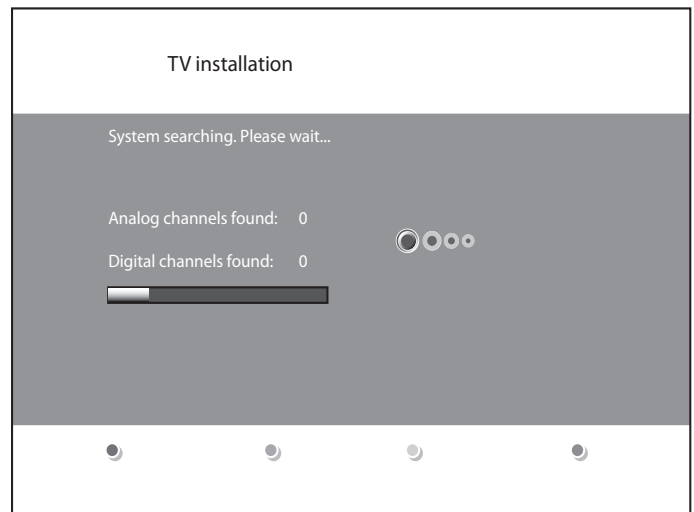

- When **[Antenna]** is selected, the TV detects antenna signals. It searches for NTSC and ATSC channels available in your area.
- When **[Cable]** is selected, the TV detects signals supplied by cable. It searches for NTSC, ATSC, and QAM modulated channels available in your area.
- When complete, this message appears **[Channel search completed.]**.

- 4 Follow the on-screen instructions to complete the installation.

## Optimize the signal quality from your antenna

You can optimize your signal quality by tuning in ATSC channels with weak signals, and adjusting the antenna.

- 1 Press **MENU/EXIT** on the remote control and select **[Installation] > [Channels] > [Installation mode]** mode.
- 2 Select **[Antenna]** and press **◀** to confirm your choice.
- 3 Press **▲** and **▶** to enter **[Weak channel installation]**.
- 4 Highlight a channel from the list of TV channels and press the green color button on the remote control.
  - ↳ The signal strength for the channel is displayed.

- 5 Adjust your antenna to maximize the signal strength.
- 6 Press **MENU/EXIT** to exit.

## Uninstall and reinstall channels

When you uninstall a channel, you remove it from the list of stored channels. Uninstalled channels are not reinstalled during an installation update.

- 1 Press **MENU/EXIT** on the remote control and select **[Installation] > [Channels] > [Uninstall channels]**.

TV menu   Installation	
Channels	Uninstall channels
Autoprogram	<input type="checkbox"/> 52
Weak channel installation	<input type="checkbox"/> 53
Installation mode	<input checked="" type="checkbox"/> 54
Uninstall channels	<input type="checkbox"/> 55
	<input type="checkbox"/> 56
	<input type="checkbox"/> 57
	<input type="checkbox"/> 58
	<input type="checkbox"/> 59

- 2 Press **▶** to enter the list of stored channels.
- 3 Press **▲** or **▼** to select the channel you want to uninstall, and press the green key on the remote control.
- 4 The channel is removed from the channel list. Press the green key again to reinstall the channel.
- 5 Press **MENU/EXIT** to exit.

## Return your settings to default values

When you return picture and sound settings to their default values the channel installation settings are not affected.

- 1 Press **MENU/EXIT** on the remote control and select **[Installation] > [Reset AV settings]**.

TV menu	
Installation	Reset AV settings
Language	
Channels	Start now
Preferences	
Source labels	
Clock	
Current software info	
Reset AV settings	

- 2 Press **▶** to highlight **[Start now]**, and press **OK** to reset the picture and sound settings.
- 3 Press **MENU/EXIT** to exit.

## Show emergency alerts (EAS)

The SCTE18 standard defines an emergency alert signaling method for use by cable TV systems. EAS can be broadcast to digital devices such as digital set-top boxes, digital TVs, and digital VCRs.

The EAS scheme allows a cable operator to disseminate information related to state and local emergencies and warnings.

EAS contain the following information:

- Emergency alert text
- Start time and date
- End time and date
- Priority

EAS with priority maximum or high are always displayed on your TV. However, you can configure your TV not to show EAS messages with medium or low priority.

EAS is not possible with a multimedia browser or with analog video sources.

You can always remove the message from the screen. The message display overlaps menus and other messages on the screen.

- 1 Press **MENU/EXIT** on the remote control and select **[Installation] > [Preferences] > [Show emergency alerts]**.

TV menu   Installation	
Preferences	Show emergency alerts
Location	Always
Show emergency alerts	Skip low priority
Downloaded rating table	Skip medium/low priority

- 2 Highlight an option:
  - **[Always]**: Displays all emergency alert messages
  - **[Skip low priority]**: Shows all messages except low priority messages
  - **[Skip medium/low priority]**: Shows maximum and high priority messages only
- 3 Press **◀** to confirm your choice.
- 4 Press **MENU/EXIT** to exit.

## 8 Update your TV software

Philips continuously tries to improve its products and we strongly recommend that you update the TV software when updates are available.

New software can be obtained from your dealer or downloaded from the [www.philips.com/welcome](http://www.philips.com/welcome) website. Use the type number of your TV (e.g. 42PFL5603D/27) to find information.

### Check your current software version

Press **MENU/EXIT** on the remote control and select **[Installation] > [Current software info]**.

- ↳ The version and a description of the current software is displayed.

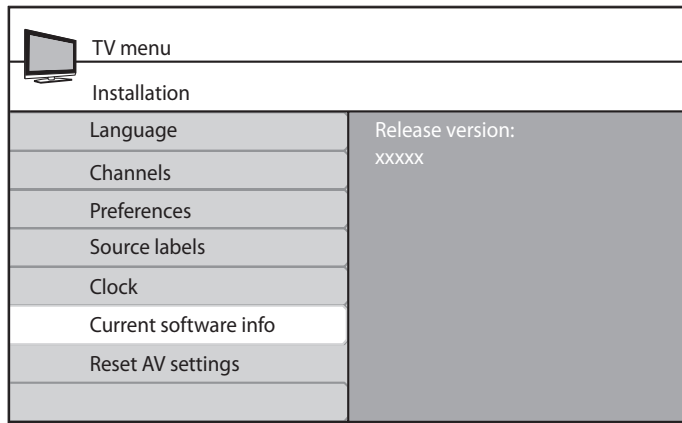

### Prepare for the software upgrade

You require the following equipment:

- A PC with web browsing capability.
- An archive utility that supports the ZIP-format (e.g. WinZip for Windows or Stuffit for Mac OS).
- A USB memory stick.

#### Note

- Only FAT/DOS-formatted portable memory is supported.
- New software can be obtained from your dealer or can be downloaded from the [www.philips.com/welcome](http://www.philips.com/welcome) website.
- Use only software upgrades that can be found on the Philips web site.

#### Warning

- Do not remove the USB device during the software upgrade.
- If there is a power drop during the upgrade, do not remove the USB device from the TV. The TV continues the upgrade as soon as the power comes back.
- If you try to upgrade to a software version lower than the current version, a confirmation message is displayed. Downgrade to older software only in case of real necessity.
- If an error occurs during the upgrade, retry the procedure or contact your dealer.

### Download the software

- 1 On your PC, open a web browser and go to [www.philips.com/welcome](http://www.philips.com/welcome).
- 2 Find information and software related to your TV and download the latest software upgrade file to your PC.
- 3 Decompress the ZIP-file.
- 4 Copy the autorun.upg file to the root directory of the USB device.

### Upgrade software

- 1 Prepare the software upgrade (see 'Prepare for the software upgrade' on page 27).
- 2 Connect your USB device to the USB port on the side of your TV.
  - ↳ The TV scans the USB device for the updated software and automatically enters upgrade mode.
- 3 Read the on-screen instructions and confirm that you want to continue with the installation.
- 4 When the software upgrade is complete, remove the USB device.
- 5 Turn the TV off and on again.
  - ↳ The TV starts up with the new software.

# 9 Connect devices

This section describes how to connect various devices with different connectors and supplements examples provided in the Quick Start.

**Caution**

- Disconnect the mains cord before connecting devices.

**Note**

- Different types of connectors may be used to connect a device to your TV, depending on availability and your needs.

## Connection overview

### Back connectors

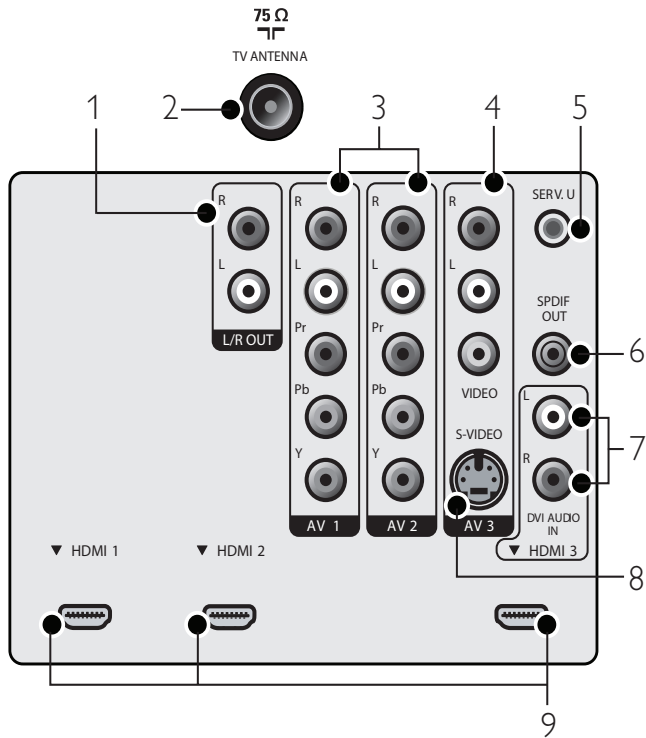

- 1 **AUDIO OUT L/R** : Analog audio output to home theaters and other audio systems.
- 2 Signal input from an antenna, cable or satellite.
- 3 **AV1 and AV2**: Video input from analog devices such as DVD, receiver, game console, etc. This connector is used with audio input.
- 4 **AV3 Composite video (back)**: Video input for analog devices such as DVD, camcorder, game console, etc. To be used with audio input.
- 5 For use by service personnel only.
- 6 Digital audio output to home theaters and other digital audio systems. For connection to home theatre systems.
- 7 Audio input for HDMI3.

- 8 **AV3S-VIDEO (back)**: S-Video (back) input connector to be used with Audio L/R connectors for camcorder, game console, etc. When you use the S-Video (back) for video signals, do not use Composite video (back) for video signals.
- 9 **HDMI 1/2/3**: Digital audio and video input from high-definition digital devices such as Blu-ray players.

### Side connectors

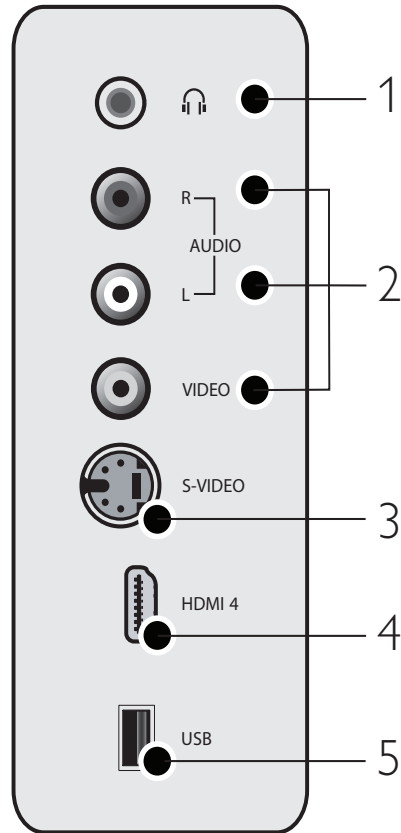

- 1 Stereo audio output to headphones or earphones.
- 2 **Composite video**: Video input for analog devices such as DVD, camcorder, game console, etc. To be used with audio input.
- 3 S-Video (side) to be used with Audio L/R connectors for camcorder, game console, etc. When you use the S-Video (side) for video signals, do not use the Composite video (side) input for video signals.
- 4 **HDMI 4 (side)**: Digital audio and video input from high-definition digital devices such as Blu-ray players.
- 5 Data input from USB storage devices.

## Select your connection quality

### HDMI - Highest quality

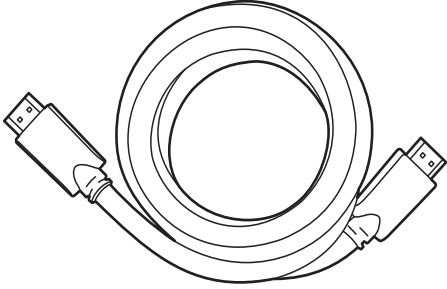

Supports high-definition signals and gives highest picture and sound quality. Video and audio signals are combined in one cable. You must use HDMI for full high-definition video and to enable Philips EasyLink.



#### Tip

- To connect to a PC without an HDMI connector, use a DVI-HDMI adaptor and a separate audio cable.



#### Note

- Philips HDMI supports Highbandwidth Digital Contents Protection (HDCP). HDCP is a form of Digital Rights Management that protects high definition content in DVD or Blu-ray Discs.

### Component (Y Pb Pr) - High quality

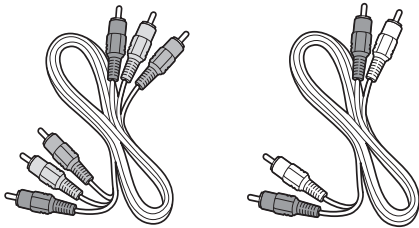

Component video cable (red/green/blue) and audio L/R cable (red/white)

Supports high-definition signals but gives lower picture quality than HDMI. Component cables combine a red/green/blue video cable with a red/white audio L/R cable. Match the cable colors when you connect to the TV.

### S-Video - Good quality

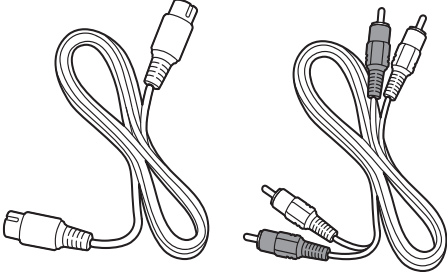

S-Video cable and audio L/R cable (red/white)

For analog connections. Use an S-Video cable together with an audio L/R cable.

### Composite - Basic quality

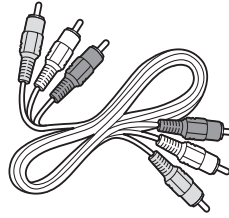

Composite video/audio cable (yellow/red/white)

For analog connections. Composite cables usually combine a yellow video cable with a red/white audio L/R cable. Match the cable colors when you connect to the TV.

## Label your connections

When you connect devices, you can label the connections to help you to identify where devices are connected.

- Press **MENU/EXIT** on the remote control and select **[Installation] > [Source labels]**.

TV menu	
Installation	Source labels
Language	AV1
Channels	AV2
Preferences	AV3
Source labels	HDMI1
Clock	HDMI2
Reset AV settings	HDMI3
Software upgrade	Side HDMI
	Side AV

- Press **▶** to enter the list of available connections.
- Press **▲** or **▼** to highlight a connection in the list.
- Press **▶** to enter the list of devices for the connection, and press **▲** or **▼** to highlight a device.
- Press **◀** to confirm your choice.
- Press **MENU/EXIT** to exit.

## Connect your devices

This section describes how to connect a selection of devices with different connectors. Different types of connectors can be used to connect a device to your TV. The following sections describe examples only, other configurations are possible.

When you connect composite or component cables, match the cable colors to the connectors on the TV.

### Connect a DVD player/recorder via composite connectors

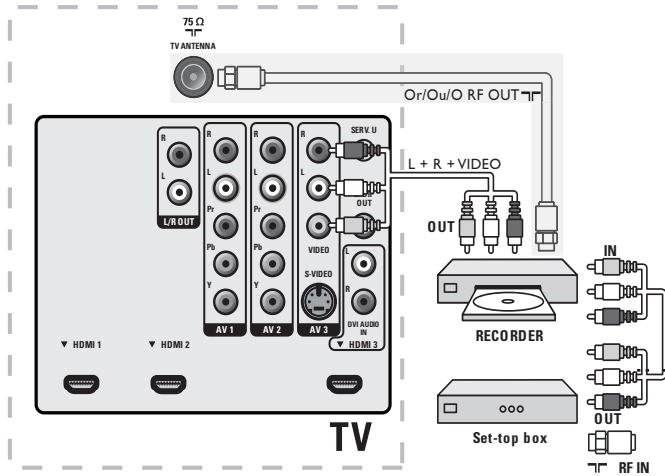

Do not place your recorder too close to the screen because some recorders can be susceptible to signals.

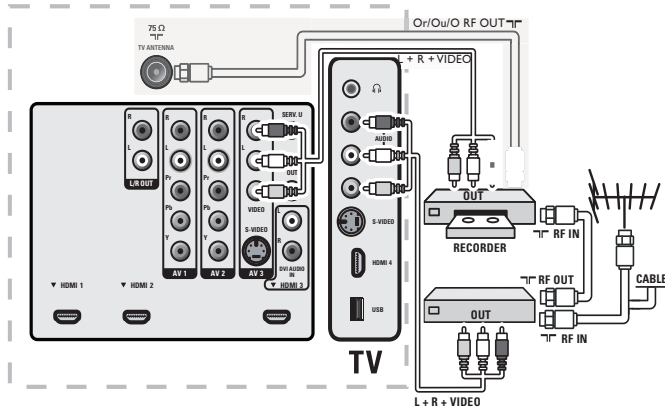

If your recorder has an S-VHS video jack: For improved picture quality, connect an S-Video cable with the S-Video input. Connect the audio cables to the audio L and R input jacks of AV3/side AV.

#### Note

- When you use an S-Video connector, do not connect any device to the AV3/side AV video jack.

If you use mono equipment, the left loudspeaker reproduces sound but the right speaker does not. Use a mono to stereo adapter (not supplied) for sound reproduction via all internal loudspeakers.

### Connect a set-top box, DVD player/recorder and game console via HDMI

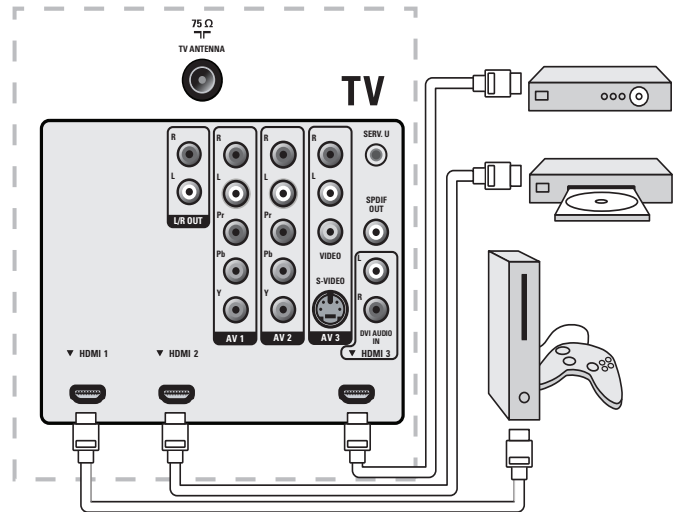

### Connect a DVD player/recorder via HDMI-DVI and DIGITAL AUDIO OUT connectors

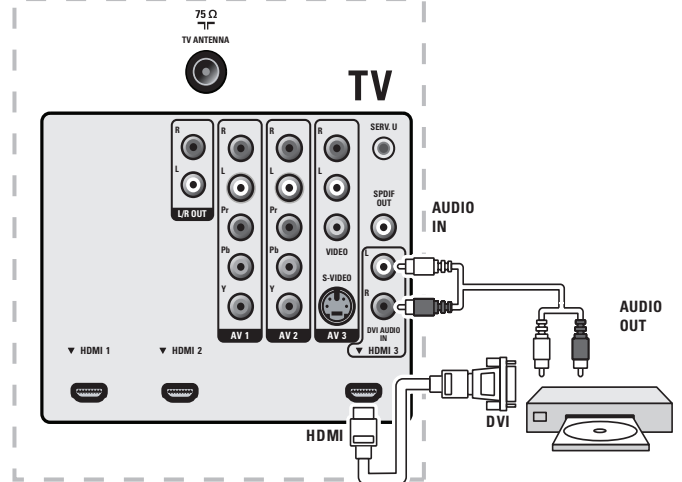

### Connect a set-top box via a composite connector

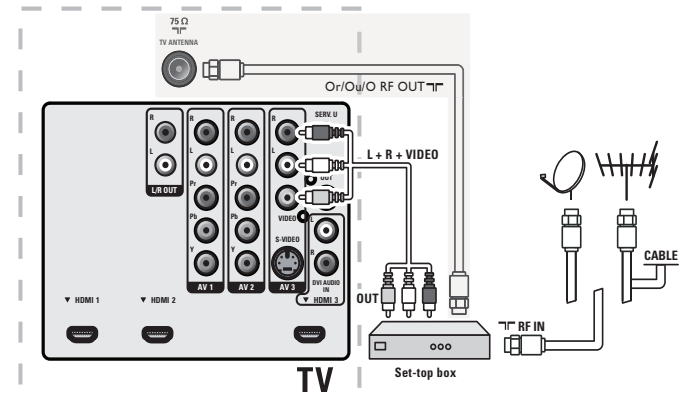

If your device has an S-VHS video jack, improve the picture quality as follows:

- Connect an S-Video cable to the S-Video input of AV3/side AV



- Connect the audio cables to the audio L and R input jacks of AV3/side AV.

When you use the S-Video connector, do not connect any device to the video jack of AV3 or the side AV.

Only the left loudspeaker reproduces sound for mono equipment. Use a mono to stereo adapter (not supplied) for sound reproduction via all internal loudspeakers.

## Connect a DVD player/recorder via component video output connectors (YPbPr) and analog audio

Selected TV models can display 1080i, 1080p, 720p and 480p DTV signals when connected to a DTV set-top box. Set the output of the cable box to either 1080i, 1080p, 720p or 480p. A DTV signal must be available in your area.

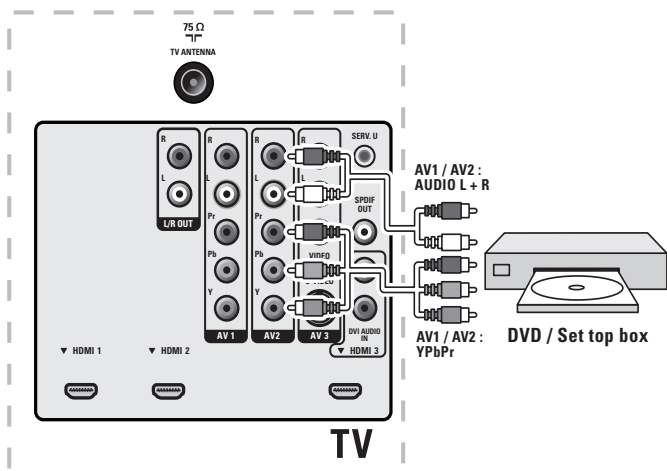

## Connect a digital home theater amplifier

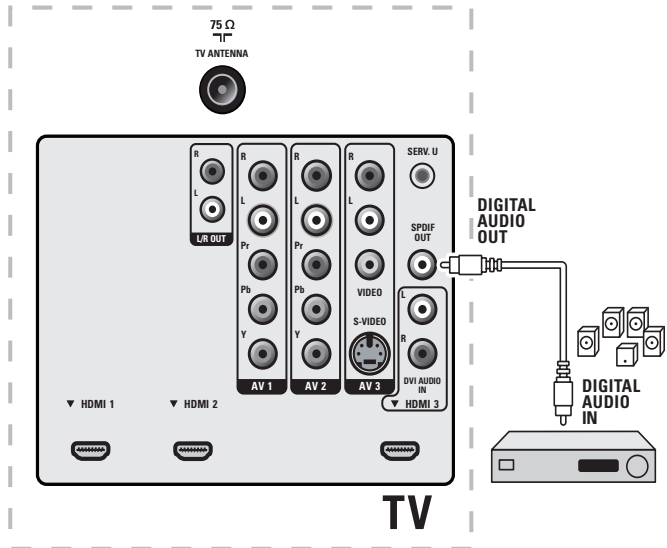

For legal reasons, the digital audio signal can be muted for copy-protected PCM audio qualities on accessory devices connected through HDMI.

## Connect a PC

Connect a PC with an S-Video connector at the back

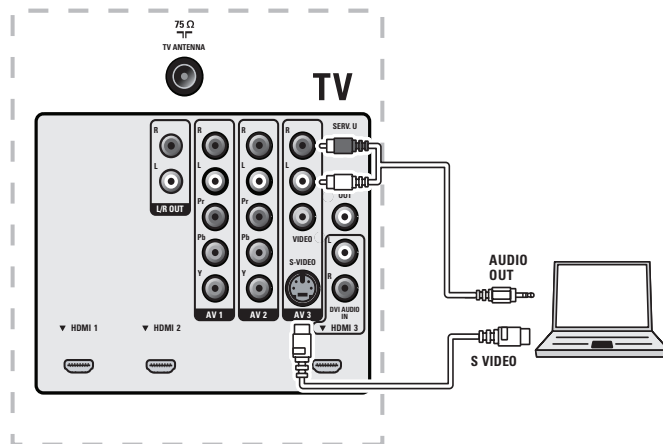

Connect a PC with an S-Video connector at the side

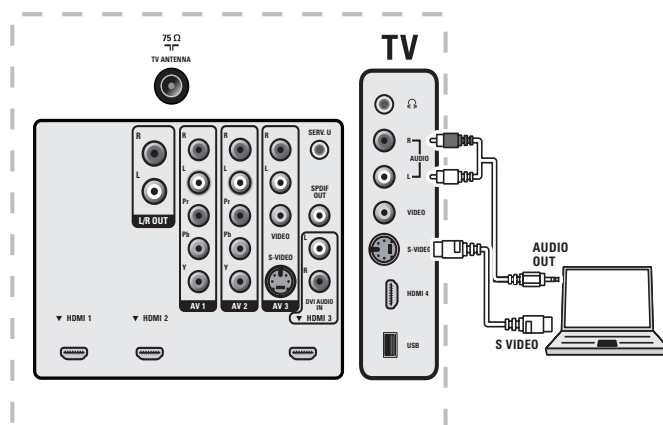

Connect a PC with a DVI connector

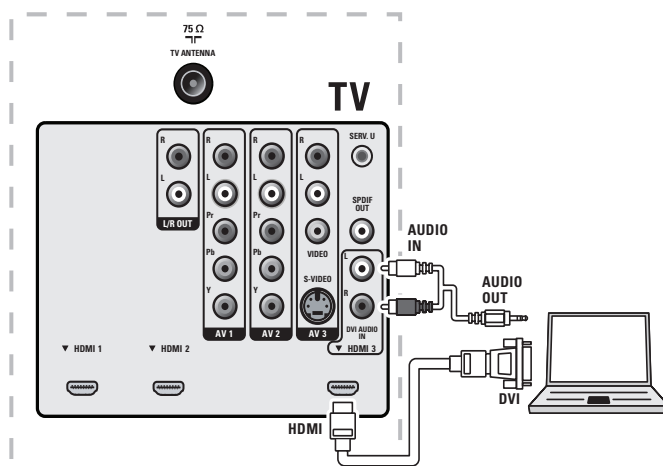

Connect a PC with an HDMI connector

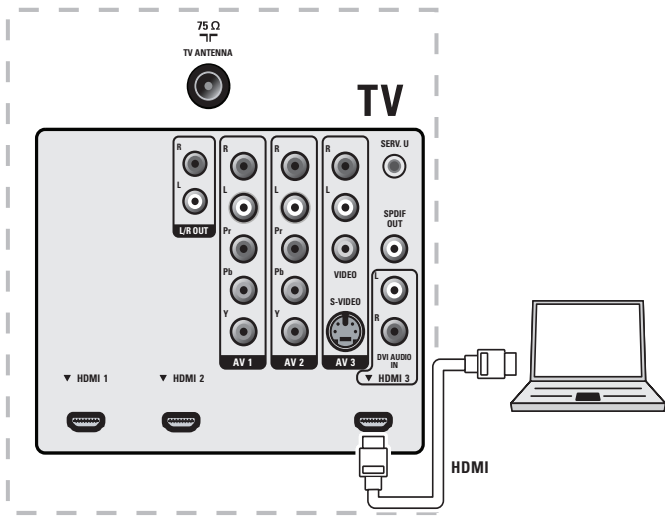

# 10 Troubleshooting

Problem	Possible cause and solution
No power or indicator light.	The TV is not connected to the power. Press <b>⏻</b> at the side of the TV or on the remote control. Ensure that the power cord is connected tightly to the TV power connector and to the power socket outlet. Remove the power cord from the power socket outlet, wait 60 seconds and reconnect the power cord. Connect the TV to a different power socket outlet.
Error message on the screen with HDMI connection.	HDCP authentication fail. Ensure that your HDMI cable is certified. Press <b>SOURCE</b> on the remote control to switch to another source and then switch back to the HDMI source. Reset the accessory device and the TV. Turn on the TV. Select the HDMI channel. Turn on the accessory device. While the TV and the accessory device are powered on, unplug either end of the HDMI cable and then reinsert the cable.
No sound is detected from the PC.	An incorrect HDMI port is connected or an audio cable is not connected. Connect a DVI-HDM cable to the HDMI 3 port on the TV. Connect an audio cable to the DVI AUDIO IN port on the TV. Press <b>SOURCE</b> on the remote control, and select the HDMI 3 source.
TV does not respond to the remote control.	Batteries are installed incorrectly, or low battery power. Ensure the indicator light on the TV blinks when you press the remote control buttons. Ensure that you are using the TV remote control. Ensure that the batteries are inserted correctly and do not need to be replaced. Remove the power cord from the power socket outlet, wait 60 seconds and reconnect the power cord.
The picture is distorted, stretched out, or has black bars on the side or top.	Broadcast video format. Press <b>FORMAT</b> on the remote control to select the best picture format. For some accessory devices, the picture format must be set in the accessory device.
The picture is mostly red and green, or the picture misses the red when connected to an accessory device via component cables.	Insecure/incorrect connection. Ensure all the connections are made according to the color code. Push the component cables all the way into the YPbPr sockets on the TV.

No sound on the TV loudspeaker.	Volume level is set to zero - increase the volume Sound is muted - press <b>MUTE</b> on the remote control. Headphones are connected - ensure that headphones are not plugged into the TV. Audio cable is not connected - for AV connection, ensure that the Audio L/R cable is connected as described in Connect your devices (see 'Connect your devices' on page 30). If you use a component cable, ensure that you have not crossed the red audio cable with the red video cable. Audio output setting for the accessory device is incorrect. For HDMI connections, some accessory devices have an HDMI audio output setting that must be turned on for HDMI to HDMI connections.
Bad picture quality with a coaxial connection.	Standard definition channels are not as clear as high definition channels - connect the devices via component or HDMI cables.
No picture or sound.	No picture or sound - ensure you have selected the correct channel. Incomplete channel installation If the TV receives channels via an AV connection, set the TV to the correct source input. If the TV is connected directly to the wall via a coaxial connection, perform the auto-installation again.
Cannot control your TV and connected remote control.	Confirm that the connected devices are EasyLink compliant and are connected to your TV via an HDMI cable. Not all brands of devices such as DVD players use the same system as Philips EasyLink. Other brands might not work with Philips EasyLink.

## Download an electronic copy

To obtain an electronic copy of this manual:

- 1 Point your browser to [www.philips.com/support](http://www.philips.com/support).
- 2 Choose your country of location.
- 3 Enter the model number or a keyword in the "Find your product" field. Alternatively, you can browse the catalogue.
- 4 Click the description or model.
- 5 Under Product support, click User manuals.

## Contact us

If you cannot resolve your problem, refer to the FAQ for this TV at [www.philips.com/support](http://www.philips.com/support).

If the problem remains unresolved, contact the Customer Support Center in your country.



### Warning

- Do not attempt to repair the TV yourself. This may cause severe injury, irreparable damage to your TV or void your warranty.



### Note

- Please have available your TV model and serial number before contacting us. These numbers are available on the back and side of your TV, as well as on the packaging.

# 11 Notes for the use of USB devices

## Digital Content Issues

- Only FAT (DOS) formatted (initialized) portable memory is supported. Errors in this formatting can result in unreadable content. If such problems appear try to re-format the card. Be aware that formatting the card will also delete all the content on it (pictures, music, ...).
- The following file types are supported: .jpg, .jpeg, .mp3, .alb, .m3u and .pls.
- Only linear JPEG picture formats are supported. Progressive JPEG and JPEG2000 encodings are not supported.
- The length of a filename or directory name is limited to the length specified by the FAT16/32 file systems.
- Max. levels of nested directories is 19.
- Never use the supported file type extensions (.jpg, .jpeg, .mp3, .alb, .m3u and .pls) as extensions for directories as these directories will be treated as corrupted files.
- The MP3 decoder does not support MPEG1 Layer 1 or Layer 2 playback.
- MP3 Pro files can be played with normal MP3 quality.
- The access and response time of the content on a device can differ depending on the type or brand of the device.
- The access and response time of the content on a device will increase the more unsupported or corrupted files are on the device.

## Digital Camera Issues

- If a USB connection between your digital camera and the TV isn't working, you can try the solutions below to resolve your problem.
- Make sure your digital camera is switched on and verify if the configuration of your digital camera is correct (see the manual of your digital camera for more information).
- Some digital cameras allow you to switch off the USB interface. Make sure that the USB interface is switched on before connecting to the TV.
- If you have a digital camera with only internal memory (no removable memory) you can try to copy the content manually to a USB memory device (e.g. Philips KEY product) using a personal computer.
- Some digital cameras allow you to switch between PTP (Picture Transfer Protocol) or "PC Link" and USB Mass Storage or "PC Drive". Make sure that you select USB Mass Storage or "PC Drive" on your digital camera.
- If your camera supports different interface settings be sure to try them one by one or contact the reseller of your camera to find out the correct setting.

## USB Memory Device Issues

- Devices connected to the USB port of your TV must be "Mass Storage Class" compliant. If your device (digital camera, MP3 player, portable hard disk, ...) is not "Mass Storage Class" compliant it will not be detected by the content browser of the TV.
- The following subsets of the Mass Storage Class specification are supported:
- The implementation of the TV is based on the "Universal Serial Bus Mass Storage Class Specification Overview" (v1.2, June 23, 2003) including all documents referenced by the document. The document can be found on the USB standardization website ([www.usb.org](http://www.usb.org)).

- Full support of the USB Mass Storage Class Bulk-Only Transport (bInterfaceProtocol = 50h).
- Full support of SubClass Code = 05h; SFF-8070i spec.
- Full support of SubClass Code = 06h; SCSI transparent command set.
- For large USB memory devices, when you are in the Content Browser, it may take a long time before you can access your files.
- When using a USB portable hard disk, and due to the high power consumption of the hard disk, it is advised to use the external power supply of the portable hard disk to guarantee proper working under all conditions

# 12 Product information

## Note

- Product information is subject to change without prior notice.

## Picture enhancement

Type:	1080p 120Hz
Brightness:	500 cd/m <sup>2</sup>
Aspect Ratio:	16:9
Viewing Angles:	178 (V) by 178 (H)
Built-in digital tuner:	ATSC/QAM
Dynamic Dimming BL:	Yes
Ambient Light Sensor:	Yes

## Sound enhancement

Mono/Stereo:	Mono, Stereo, Incredible surround
Power output (RMS Watts):	20 W
Equalizer:	5 band

## Ease of use

Video modes:	Automatic, 4:3, Movie Expand 14:9, Movie Expand 16:9, Super Zoom, Wide Screen, Unscaled
PC input:	via HDMI
Photo Slideshow:	Yes (JPEG files only)
MP3 Playback:	Yes (MP3 files only)
Video Playback:	Yes (MPEG, WMV, AVI, MP4)

## Connections

Component video input with Audio L/R:	2, supporting 480i/p, 576i/p, 720p, 1080i, 1080p @24Hz-60Hz
Composite video input with audio L/R and S-Video:	2
HDMI:	4 ver1.3a HDMI supporting video: 480i/p, 576i/p, 720p, 1080i, 1080p @24Hz-60Hz PC-input: up to WUXGA
Digital audio out:	Yes, supporting AC-3 and PCM
Headphone:	1 (on the side of TV)
USB:	1 (on the side of TV)

## Power

Auto multi-voltage:	110V-240V~/50-60 Hz
---------------------	---------------------

# 13 Warranty

## LIMITED WARRANTY ONE (1) YEAR

### WARRANTY COVERAGE:

This warranty obligation is limited to the terms as set forth below.

### WHO IS COVERED:

This product warranty is issued to the original purchaser or the person receiving the product as a gift against defects in materials and workmanship as based on the date of original purchase ("Warranty Period") from an Authorized Dealer. The original sales receipt showing the product name and the purchase date from an authorized retailer is considered such proof.

### WHAT IS COVERED:

This warranty covers new products if a defect in material or workmanship occurs and a valid claim is received within the Warranty Period. At its option, the company will either (1) repair the product at no charge, using new or refurbished replacement parts, or (2) exchange the product with a product that is new or which has been manufactured from new, or serviceable used parts and is at least functionally equivalent or most comparable to the original product in current inventory, or (3) refund the original purchase price of the product. Replacement products or parts provided under this warranty are covered against defects in materials and workmanship from the date of the replacement or repair for ninety (90) days or for the remaining portion of the original product's warranty, whichever provides longer coverage for you. When a product or part is exchanged, any replacement item becomes your property and the replaced item becomes company property. When a refund is given, your product becomes company property. Note: Any product sold and identified as refurbished or renewed carries a ninety (90) day limited warranty.

Replacement product can only be sent if all warranty requirements are met. Failure to follow all requirements can result in delay.

### WHAT IS NOT COVERED - EXCLUSIONS AND LIMITATIONS:

This Limited Warranty applies only to new company manufactured products that can be identified by the trademark, trade name, or logo affixed to it. This Limited Warranty does not apply to any hardware product or any software, even if packaged or sold with the product, as manufacturers, suppliers, or publishers may provide a separate warranty for their own products packaged with the bundled product.

The company is not liable for any damage to or loss of any programs, data, or other information stored on any media contained within the product, or other additional product or part not covered by this warranty. Recovery or reinstallation of programs, data or other information is not covered under this Limited Warranty.

This warranty does not apply (a) to damage caused by accident, abuse, misuse, neglect, misapplication, or non-supplied product, (b) to damage caused by service performed by anyone other than company approved Authorized Service Location, (c) to a product

or a part that has been modified without written company permission, or (d) if any serial number has been removed or defaced, or (e) product, accessories or consumables sold "AS IS" without warranty of any kind by including refurbished product sold "AS IS" by some retailers.

This Limited Warranty does not cover:

- Shipping charges to return defective product.
- Labor charges for installation or setup of the product, adjustment of customer controls on the product, and installation or repair of antenna/signal source systems outside of the product.
- Product repair and/or part replacement because of improper installation or maintenance, connections to improper voltage supply, power line surge, lightning damage, retained images or screen markings resulting from viewing fixed stationary content for extended periods, product cosmetic appearance items due to normal wear and tear, unauthorized repair or other cause not within the control of the company.
- Damage or claims for products not being available for use, or for lost data or lost software.
- Damage from mishandled shipments or transit accidents when returning product.
- A product that requires modification or adaptation to enable it to operate in any country other than the country for which it was designed, manufactured, approved and/or authorized, or repair of products damaged by these modifications.
- A product used for commercial or institutional purposes (including but not limited to rental purposes).
- Product lost in shipment and no signature verification receipt can be provided.
- Failure to operate per Owner's Manual.

### TO OBTAIN ASSISTANCE...

Contact the Customer Care Center at:  
1-866-771-4018

REPAIR OR REPLACEMENT AS PROVIDED UNDER THIS WARRANTY IS THE EXCLUSIVE REMEDY FOR THE CONSUMER, WITH THE ISSUING COMPANY NOT LIABLE FOR ANY INCIDENTAL OR CONSEQUENTIAL DAMAGES FOR BREACH OF ANY EXPRESS OR IMPLIED WARRANTY ON THIS PRODUCT. EXCEPT TO THE EXTENT PROHIBITED BY APPLICABLE LAW, ANY IMPLIED WARRANTY OF MERCHANTABILITY OR FITNESS FOR A PARTICULAR PURPOSE ON THIS PRODUCT IS LIMITED IN DURATION TO THE DURATION OF THIS WARRANTY.

Some states do not allow the exclusions or limitation of incidental or consequential damages, or allow limitations on how long an implied warranty lasts, so the above limitations or exclusions may not apply to you.

*This warranty gives you specific legal rights. You may have other rights which vary from state/province to state/province.*

**P&F USA, P.O. Box 672768, Marietta, GA 30006**

0908

# 14 Index

## A

Active Control	14
Antenna	8

## C

Cables	
component	29
composite	29
HDMI	29
quality	29
S-Video	29
YPbPr	29
Channels	
favorite list	15
Child lock	
lock channels	17
PIN code	16
ratings lock	17
Clock	15
Closed captions	19
Component cable	29
Composite cable	29
Connections	
antenna	8
quality	29

## D

Demo	24
DivX	20

## E

EasyLink	23
Eco TV	14, 15
Environmental care	5

## F

Favorite list	15
---------------	----

## H

HDMI cable	29
Home mode	10, 25

## L

Location	10, 25
----------	--------

## M

Menu	
child lock	16
quick access menu	13
MPEG artifact reduction	14
Music	
USB	21
with slideshow	21

## N

Noise reduction	14
-----------------	----

## P

Parental control	
child lock	16
PC	23
Picture format	14
Picture settings	14
Power	9

## R

Ratings	17, 18
Remote control	
insert batteries	8
overview	6
Retail store mode	10

## S

Settings assistant	13
Side controls	6
Sleep timer	16
Slideshow	21
Software	27
Sound settings	14, 15
Standby	6, 11
Subtitles	19
S-Video	29

## T

Technical specifications	35
Timer	15
Troubleshooting	33
TV	
as PC monitor	23
connections	8, 28, 31, 32
controls	6
in High Definition	22
menu	13
position	8
ratings	17
remote control	6, 8
screen care	5
software	27
switch channels	11
switch on	10, 11
troubleshooting	33

## U

USB	20, 34
-----	--------

## V

Video	22
Volume	
adjust	11
automatic leveling	15
delta	15
mute	11

## Y

YPbPr	29
-------	----

