



# PLASMA TV

## OWNER'S MANUAL

**MODEL: DU-50PX10/10C  
DU-42PX12X/12XC**

Please read this manual carefully and completely before operating your TV.

Retain this manual for future reference.

Record model number and serial number of the TV in the spaces provided below.

See the label attached on the back cover and relate this information to your dealer if you require service.

Model Number :

Serial Number :

# Warning



**WARNING**  
RISK OF ELECTRIC SHOCK  
DO NOT OPEN



## WARNING:

TO REDUCE THE RISK OF ELECTRIC SHOCK DO NOT REMOVE COVER (OR BACK). NO USER SERVICEABLE PARTS INSIDE. REFER TO QUALIFIED SERVICE PERSONNEL.



The lightning flash with arrowhead symbol, within an equilateral triangle, is intended to alert the user to the presence of uninsulated "dangerous voltage" within the product's enclosure that may be of sufficient magnitude to constitute a risk of electric shock to persons.



The exclamation point within an equilateral triangle is intended to alert the user to the presence of important operating and maintenance (servicing) instructions in the literature accompanying the appliance.

## WARNING:

TO PREVENT FIRE OR SHOCK HAZARDS, DO NOT EXPOSE THIS PRODUCT TO RAIN OR MOISTURE.

## POWER CORD POLARIZATION:

CAUTION: TO PREVENT ELECTRIC SHOCK, MATCH WIDE BLADE OF PLUG TO WIDE SLOT, FULLY INSERT.

## NOTE TO CABLE/TV INSTALLER:

This reminder is provided to call the CATV system installer's attention to Article 820-40 of the National Electric Code (U.S.A.). The code provides guidelines for proper grounding and, in particular, specifies that the cable ground shall be connected to the grounding system of the building, as close to the point of the cable entry as practical.

## REGULATORY INFORMATION:

This equipment has been tested and found to comply with the limits for a Class B digital device, pursuant to Part 15 of the FCC Rules. These limits are designed to provide reasonable protection against harmful interference when the equipment is operated in a residential installation. This equipment generates, uses and can radiate radio frequency energy and, if not installed and used in accordance with the instruction manual, may cause harmful interference to radio communications. However, there is no guarantee that interference will not occur in a particular installation. If this equipment does cause harmful interference to radio or television reception, which can be determined by turning the equipment off and on, the user is encouraged to try to correct the interference by one or more of the following measures:

- Reorient or relocate the receiving antenna.
- Increase the separation between the equipment and receiver.
- Connect the equipment into an outlet on a circuit different from that to which the receiver is connected.
- Consult the dealer or an experienced radio/TV technician for help.

Any changes or modifications not expressly approved by the party responsible for compliance could void the user's authority to operate the equipment.

## CAUTION:

Do not attempt to modify this product in any way without written authorization from LG Electronics. Unauthorized modification could void the user's authority to operate this product.

## COMPLIANCE:

The responsible party for this product's compliance is:

LG Electronics U.S.A., Inc

1000 Sylvan Avenue, Englewood Cliffs, NJ 07632

1-201-816-2000

<http://www.lgusa.com>

# Safety Instructions

## Important safeguards for you and your new product

Your product has been manufactured and tested with your safety in mind. However, improper use can result in electrical shock or fire hazards. To avoid defeating the safeguards that have been built into your new product, please read and observe the following safety points when installing and using your new product, and save them for future reference.

Observing the simple precautions discussed in this manual can help you get many years of enjoyment and safe operation that are built into your new product.

This product complies with all applicable U.S. Federal safety requirements, and those of the Canadian Standards Association.

### 1. Read Instructions

All the safety and operating instructions should be read before the product is operated.

### 2. Follow Instructions

All operating and use instructions should be followed.

### 3. Retain Instructions

The safety and operating instructions should be retained for future reference.

### 4. Heed Warnings

All warnings on the product and in the operating instructions should be adhered to.

### 5. Cleaning

Unplug this product from the wall outlet before cleaning. Do not use liquid cleaners or aerosol cleaners. Use a damp cloth for cleaning.

### 6. Water and Moisture

Do not use this product near water, for example, near a bath tub, wash bowl, kitchen sink, or laundry tub, in a wet basement, or near a swimming pool.

### 7. Accessories, Carts, and Stands

Do not place this product on a slippery or tilted surface, or on an unstable cart, stand, tripod, bracket, or table. The product may slide or fall, causing serious injury to a child or adult, and serious damage to the product. Use only with a cart, stand, tripod, bracket, or table recommended by the manufacturer, or sold with the product. Any mounting of the product should follow the manufacturer's instructions, and should use a mounting accessory recommended by the manufacturer.

### 8. Transporting Product

A product and cart combination should be moved with care. Quick stops, excessive force, and uneven surfaces may cause the product and cart combination to overturn.

### 9. Attachments

Do not use attachments not recommended by the product manufacturer as they may cause hazards.

### 10. Ventilation

Slots and openings in the cabinet are provided for ventilation and to ensure reliable operation of the product and to protect it from overheating, and these openings must not be blocked or covered. The openings should never be blocked by placing the product on a bed, sofa, rug, or other similar surface. This product should not be placed in a built-in installation such as a bookcase or rack unless proper ventilation is provided or the manufacturer's instructions have been adhered to.

### 11. Power Sources

This product should be operated only from the type of power source indicated on the marking label. If you are not sure of the type of power supply to your home, consult your product dealer or local power company. For products intended to operate from battery power, or other sources, refer to the operating instructions.

### 12. Power-Cord Polarization

This product is equipped with a three-wire grounding type plug, a plug having a third (grounding) pin. This plug will only fit into the grounding-type power outlet. This is a safety feature. If you are unable to insert the plug into the outlet, contact your electrician to replace your obsolete outlet. Do not defeat the safety purpose of the grounding-type plug.

### 13. Power-Cord Protection

Power-supply cords should be routed so that they are not likely to be walked on or pinched by items placed upon or against them, paying particular attention to cords at plugs, convenience receptacles, and the point where they exit from the product.



PORTABLE CART WARNING

## Safety Instructions continued

### 14. Outdoor Antenna Grounding

If an outside antenna or cable system is connected to the product, be sure the antenna or cable system is grounded so as to provide some protection against voltage surges and built-up static charges. Article 810 of the National Electrical Code (U.S.A.), ANSI/ NFPA 70 provides information with regard to proper grounding of the mast and supporting structure, grounding of the lead-in wire to an antenna discharge unit, size of grounding conductors, location of antenna-discharge unit, connection to grounding electrodes, and requirements for the grounding electrode.

#### Example of Grounding According to National Electrical Code Instructions

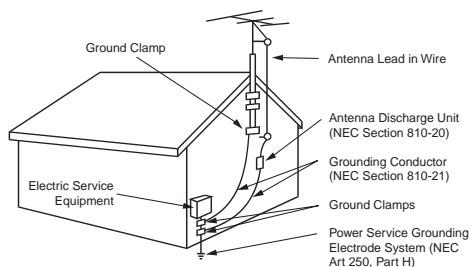

NEC - National Electrical Code

### 15. Lightning

For added protection for this product (receiver) during a lightning storm, or when it is left unattended and unused for long periods of time, unplug it from the wall outlet and disconnect the antenna or cable system. This will prevent damage to the product due to lightning and power-line surges.

### 16. Power Lines

An outside antenna system should not be located in the vicinity of overhead power lines or other electric light or power circuits, or where it can fall into such power lines or circuits. When installing an outside antenna system, extreme care should be taken to keep from touching such power lines or circuits as contact with them might be fatal.

### 17. Overloading

Do not overload wall outlets and extension cords as this can result in a risk of fire or electric shock.

### 18. Object and Liquid Entry

Never push objects of any kind into this product through openings as they may touch dangerous voltage points or short-out parts that could result in a fire or electric shock. Never spill liquid of any kind on the product.

### 19. Servicing

Do not attempt to service this product yourself as opening or removing covers may expose you to dangerous voltage or other hazards. Refer all servicing to qualified service personnel.

### 20. Damage Requiring Service

Unplug this product from the wall outlet and refer servicing to qualified service personnel under the following conditions:

- If the power-supply cord or plug is damaged.
- If liquid has been spilled, or objects have fallen into the product.
- If the product has been exposed to rain or water.
- If the product does not operate normally by following the operating instructions. Adjust only those controls that are covered by the operating instructions as an improper adjustment of other controls may result in damage and will often require extensive work by a qualified technician to restore the product to its normal operation.
- If the product has been dropped or the cabinet has been damaged.
- If the product exhibits a distinct change in performance.

### 21. Replacement Parts

When replacement parts are required, be sure the service technician has used replacement parts specified by the manufacturer or have the same characteristics as the original part. Unauthorized substitutions may result in fire, electric shock, or other hazards.

### 22. Safety Check

Upon completion of any service or repairs to this product, ask the service technician to perform safety checks to determine that the product is in proper operating condition.

### 23. Wall or Ceiling Mounting

The product should be mounted to a wall or ceiling only as recommended by the manufacturer. The product may slide or fall, causing serious injury to a child or adult, and serious damage to the product.

### 24. Heat

The product should be situated away from heat sources such as radiators, heat registers, stoves, or other products (including amplifiers) that produce heat.

# Contents

Warnings .....	2	Auto Clock Setup .....	25
Safety Instructions .....	3-4	Manual Clock Setup .....	25
		On/Off Timer Setup .....	25
		Sleep Timer / Auto Off .....	26
<b>Introduction</b>		Option Menu Features	
Controls .....	7	Aspect Ratio .....	27
Connection Options .....	8	Caption / Caption Mode .....	28
Remote Control Key Functions .....	9	Caption Option .....	29
		Cinema Mode Setup .....	29
		Demo .....	29
		ISM Method .....	30
		Low power .....	30
		Split Zoom .....	30
<b>Installation</b>		Lock Menu Options	
Installation Instruction .....	10-11	Parental Lock Setup .....	32
External Equipment Connections .....	12-16	PIP (Picture-in-Picture)/POP/Twin Picture	
Antenna Connection .....	12	Watching PIP/POP/Twin Picture .....	33
VCR Setup / Cable TV Setup .....	13	Selecting an Input Signal Source for PIP/Twin Picture ..	33
External A/V Source Setup .....	14	Swapping the PIP/Twin Picture .....	33
Monitor Out Setup / DVD Setup .....	14	TV Program Selection for PIP .....	33
HDSTB Setup / Digital Audio Output .....	15	Moving the PIP sub picture .....	34
PC Setup .....	16	Adjusting Main and Sub Picture Sizes for Twin Picture ..	34
		POP (Picture-out-of-Picture: Channel Scan) ..	34
		<b>External Control Device Setup .....</b>	<b>35-39</b>
<b>Operation</b>		<b>IR Codes .....</b>	<b>40-41</b>
Screen Setup for PC mode .....	17	<b>Programming the Remote .....</b>	<b>42</b>
Turning the TV On .....	18	<b>Programming Codes .....</b>	<b>43-44</b>
On-screen Menus Language Selection .....	18	<b>Troubleshooting Checklist .....</b>	<b>45</b>
Setup Menu Options		<b>Maintenance .....</b>	<b>46</b>
EZ Scan (Channel Search) .....	19	<b>Product Specifications .....</b>	<b>46</b>
Channel Edit .....	19	<b>Warranty .....</b>	<b>47-48</b>
DTV Signal Strength .....	20		
Channel Label Setup .....	20		
Main Picture Source Selection .....	20		
Video Menu Options			
EZ Picture .....	21		
Manual Picture Control (Off Option) .....	21		
Color Temperature Control .....	21		
Video Preset .....	21		
Audio Menu Options			
Audio Language .....	22		
EZ SoundRite / EZ Sound .....	22		
Manual Sound Control (Off Option) .....	23		
Stereo/SAP Broadcasts Setup .....	23		
Front Surround .....	23		
TV Speakers On/Off Setup .....	24		
BBE .....	24		
Time Menu Options			

## Setup and Operation Checklist

### Setup and Operation Checklist

(See pages 11-16 for available connection and operational setup options.)

1. Unpack TV and all accessories.
2. Connect all external video and audio equipment.  
see pages 14 ~ 16.
3. Install batteries in remote control.  
See page 9.
4. Turn TV on.  
See page 18.
5. Turn video source equipment on.
6. Select viewing source for TV.  
See page 20.
7. Fine-tune source image and sound to your personal preference or as required by source.  
See pages 21 ~ 24.
8. Additional features set up  
See Contents above.

After reading this manual, keep it handy for future reference.

# Introduction

## What is a Plasma Display Panel (PDP)?

A plasma display panel is the latest display technology and the best way to achieve flat panel displays with excellent image quality and large screen sizes that are easily viewable. The PDP can be thought of as a descendant of the neon lamp and it can be also be viewed as a series of fluorescent lamps.

## How does it work?

PDP is an array of cells, known as pixels, which are comprised of 3 sub pixels, corresponding to the colors red, green, and blue. Gas in a plasma state is used to react with phosphors in each sub-pixel to produce colored light (red, green, or blue). These phosphors are the same types used in Cathode Ray Tube (CRT) devices such as televisions and common computer monitors.

You get the rich, dynamic colors that you expect. Each sub-pixel is individually controlled by advanced electronics to produce over 16 million different colors. All of this means that you get perfect images that are easily viewable in a display that is less than 5 inches thick.

## 160° - Wide angle range of vision

Your flat panel plasma screen offers an exceptionally broad viewing angle -- over 160 degrees. This means that the display is clear and visible to viewers anywhere in the room who can see the screen.

## Wide Screen

The screen of the Plasma Display is so wide that your viewing experience is as if you are in a theater.

## Multimedia

Connect your plasma display to a PC and you can use it for conferencing, games, and Internet browsing. The Picture-in-Picture feature allows you to view your PC and video images simultaneously.

## Versatile

The light weight and thin size makes it easy to install your plasma display in a variety of locations where conventional TVs will not fit.

## The PDP Manufacturing Process: a few minute colored dots may be present on the PDP screen

The PDP (Plasma Display Panel), which is the display device of this product is composed of 0.9 to 2.2 million cells. A few cell defects will normally occur in the PDP manufacturing process. Several tiny, minute colored dots visible on the screen should be acceptable. This also occurs in other PDP manufacturers' products. The tiny dots appearing does not mean that this PDP is defective. Thus a few cell defects are not sufficient cause for the PDP to be exchanged or returned. Our production technology minimizes these cell defects during the manufacture and operation of this product.

## Cooling Fan Noise (DU-50PX10 only)

In the same way that a fan is used in a PC computer to keep the CPU (Central Processing Unit) cool, the PDP is equipped with cooling fans to cool the Monitor and improve its reliability. Therefore, a certain level of noise could occur while the fans are operating and cooling the PDP.

The fan noise doesn't have any negative effect on the PDP's efficiency or reliability. The noise from these fans is normal during the operation of this product. We hope you understand that a certain level of noise from the cooling fans is acceptable and is not sufficient cause for the PDP to be exchanged or returned.

# Controls

- This is a simplified representation of front panel.  
Image shown may be somewhat different from your TV.
- This manual explains the features available on the DU-50PX10 series TVs.

## Front Panel Controls

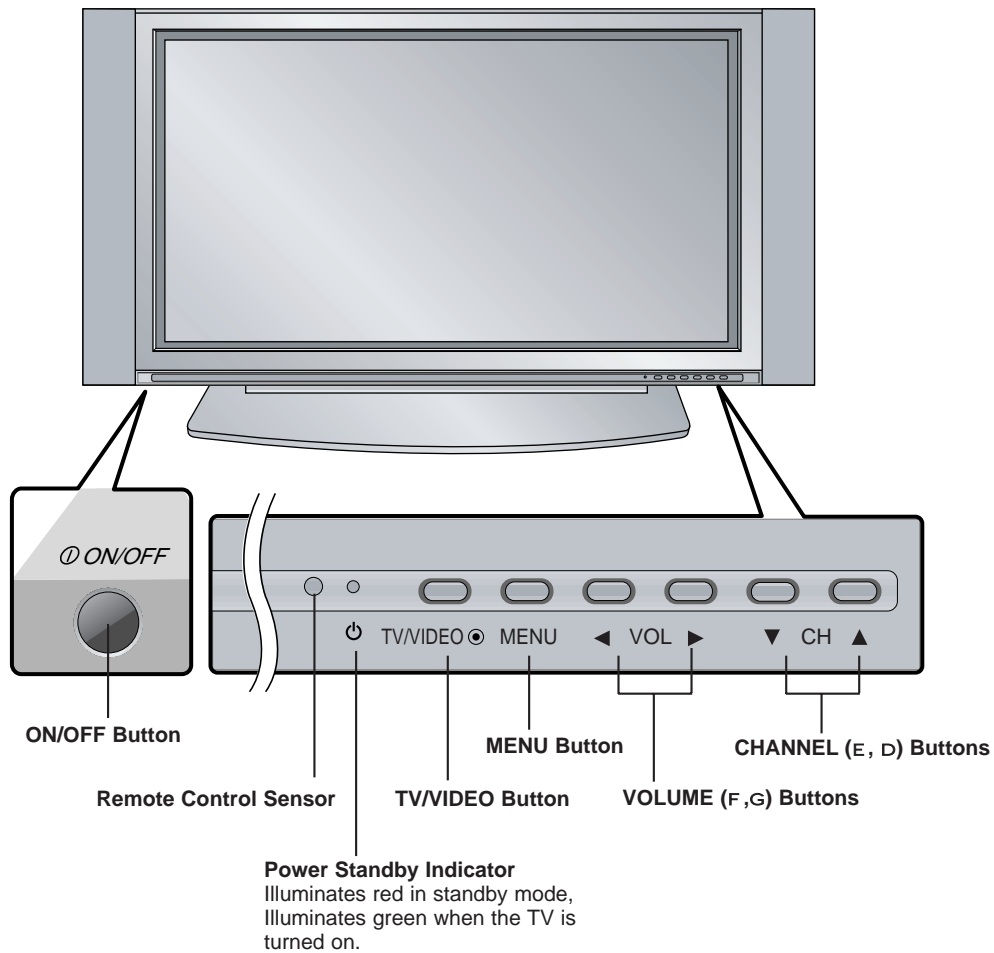

# Connection Options

## Back Connection Panel

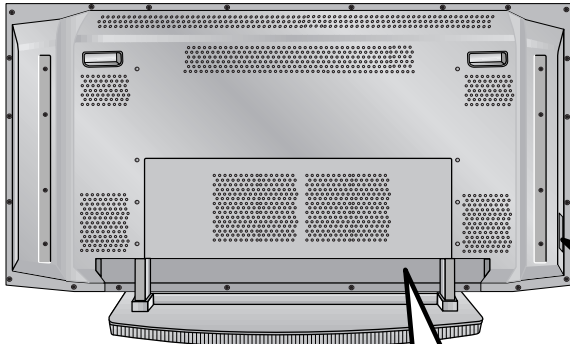

**S-VIDEO Input**  
A connection available to provide better picture quality than the video input.

**VIDEO Input**  
Connects the video signal from a video device.

**AUDIO Input**  
Use to connect to hear stereo sound from an external device.

**Remote Control Port**  
Connect your wired remote control here.

**DVI Input/Audio Input/RGB Input**  
Connect the monitor output connector from a PC to the appropriate input port.

**DVD/DTV Input (Component 1-2)**  
Connect a component video/audio device to these jacks.

**S-Video Input**  
Connect S-Video out from an S-VIDEO device to the S-VIDEO input.

**Monitor Output**  
Connect a second TV or Monitor.

**RS-232C INPUT (CONTROL/SERVICE) PORT**  
Connect to the RS-232C port on a PC.

**Digital Audio (DVI: Digital Visual Interface/Component1) Input/ Digital Audio Output**  
Connect digital audio from various types of equipment. Note: In standby mode, these ports will not work.

**Audio/Video Input 1**  
Connect audio/video output from an external device to these jacks.

**Antenna 1-2 Inputs**  
Connect cable or antenna signals to the TV, either directly or through your cable box. For DTV use Antenna 2 only.

**Power Cord Socket**  
This TV operates on an AC power. The voltage is indicated on the Specifications page. Never attempt to operate the TV on DC power.

- This manual explains the features available on the DU-50PX10 series TVs.



# Remote Control Key Functions

- When using the remote control, aim it at the remote control sensor on the TV.

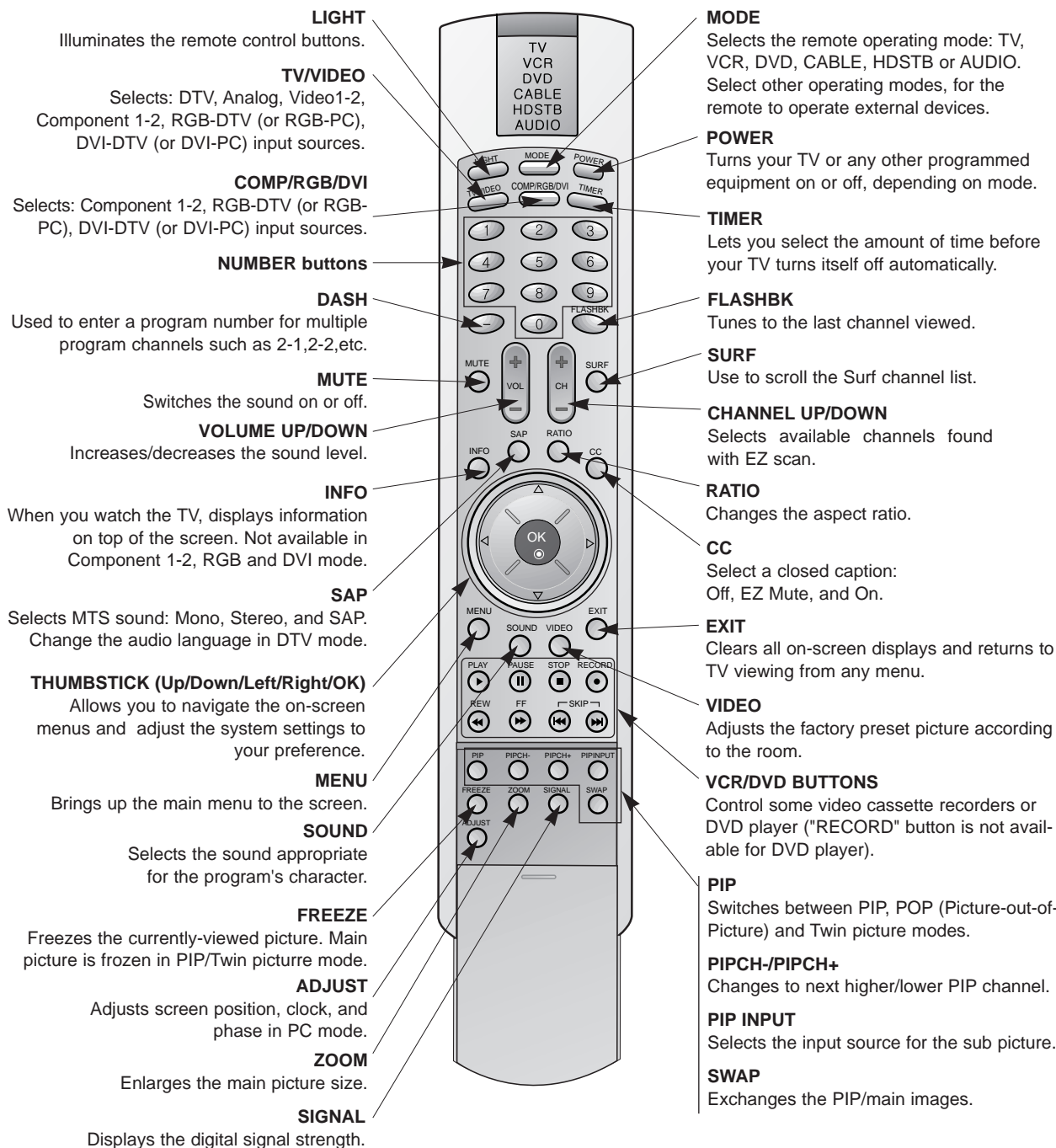

## Installing Batteries

- Open the battery compartment cover on the back side and install the batteries matching correct polarity (+ with +, - with -).
- Install two 1.5V AA batteries. Don't mix old or used batteries with new ones. Replace cover.



# Installation

Ensure that the following accessories are included with your plasma display. If an accessory is missing, please contact the dealer where you purchased the product.

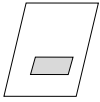

Owner's Manual

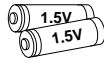

Batteries



Power Cord



75Ω Round Cable



Remote Control

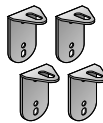

2-TV brackets  
2-Wall brackets



2-TV bracket bolts(42")  
4-TV bracket bolts(50")

## Attaching the TV assembly to the wall

- Secure the TV assembly by attaching it to a wall for additional support.

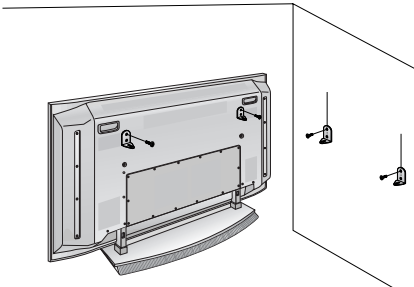

- Install the TV brackets on the TV as shown.  
Insert the 2 bolts and tighten securely, in the holes on the bracket. (42")  
After removing the existing bolts, Insert the 4 bolts and tighten securely, in the holes on the bracket.(50")  
Install the wall brackets on the wall with 4 bolts\*, (not supplied with the product), as shown.  
Match the height of the TV brackets and the wall brackets.  
Check to be sure the brackets are tightened securely.

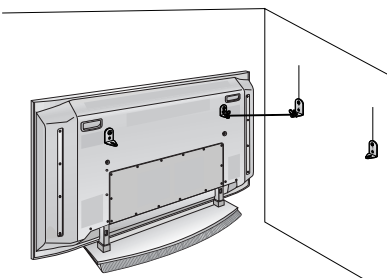

- Secure the TV assembly to the wall with strong strings or wound wire cables, (not supplied with the product), as shown.

# Installation Instructions

- The TV can be installed in various ways such as on a wall, or on a desktop etc.
- The TV is designed to be mounted horizontally. The speakers shown are optional.

## GROUNDING

Ensure that you connect the grounding / earth wire to prevent possible electric shock. If grounding methods are not possible, have a qualified electrician install a separate circuit breaker. Do not try to ground the unit by connecting it to telephone wires, lightening rods, or gas pipes.

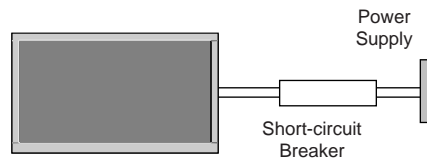

### Wall Mount: Horizontal installation

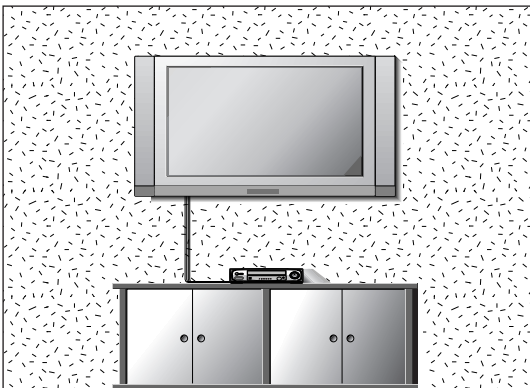

For proper ventilation, allow a clearance of 4" on each side and 2" from the wall. Detailed installation instructions are available from your dealer, see the optional Wall Mounting Bracket Installation and Setup Guide.

### Desktop Pedestal Installation

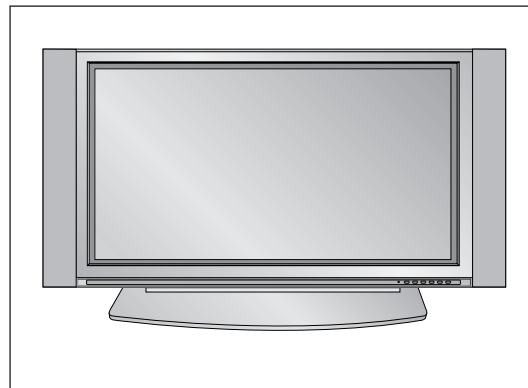

For proper ventilation, allow a clearance of 4" on each side and the top, 2.36" on the bottom, and 2" from the wall. Detailed installation instructions are included in the optional Desktop Stand Installation and Setup Guide available from your dealer.

### To Mount on a Wall

Wall mount minimum allowable clearances for adequate ventilation.

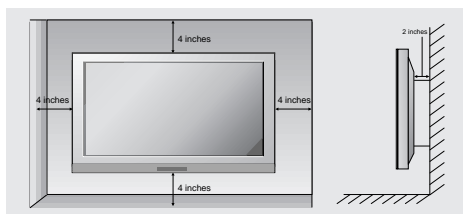

### To Install on a Desktop

Pedestal mount minimum allowable clearances for adequate ventilation.

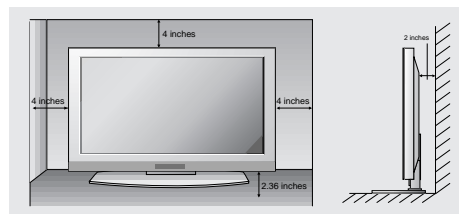

# External Equipment Connections

## Antenna Connection

### Analog and Digital TV signals provided on one antenna

- Antenna or Cable Service without a Cable Box Connections
- For optimum picture quality, adjust antenna direction if needed.

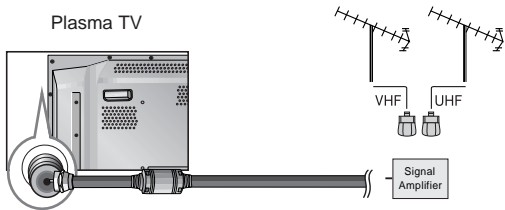
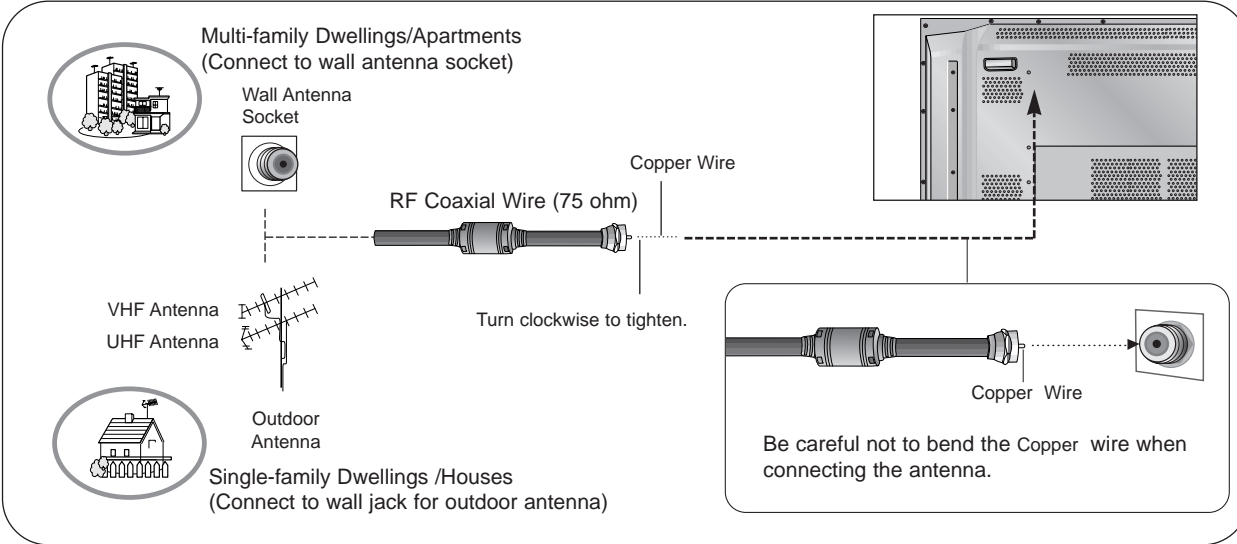

- In a poor signal area to improve picture quality, purchase and install a signal amplifier.
- If the antenna needs to be split for two TV's, install a "2-Way Signal Splitter" in the connections.
- If the antenna is not installed properly, contact your dealer for assistance.

### Analog and DTV signals provided on two separate antennas

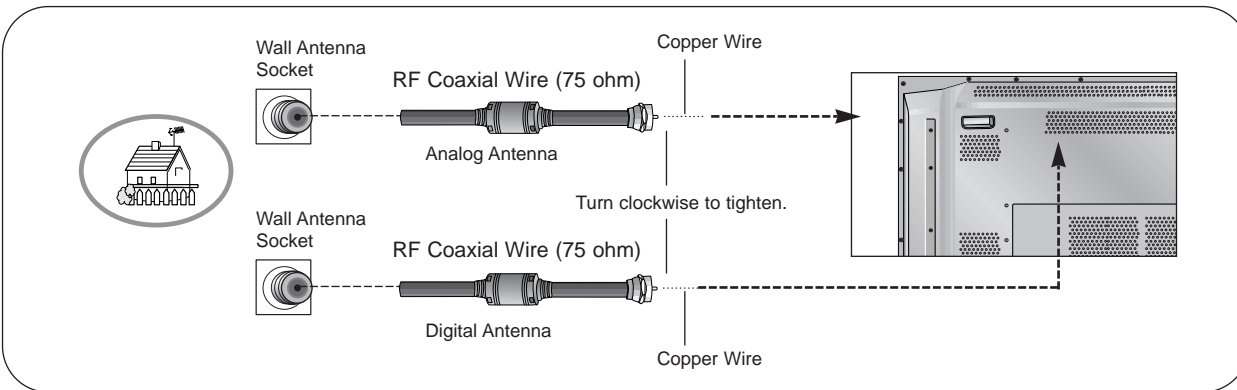

**NOTE:** If you are not sure of the type of signal(s) you are receiving, let EZ Scan complete all the channel signal-type searches. The TV will let you know when the analog, cable, and digital channel scans are complete.

**NOTE: All cables shown are not included with the TV**

### VCR Setup

- To avoid picture noise (interference), leave an adequate distance between the VCR and TV
- Use the ISM Method (on the Option menu) feature to avoid having a fixed image remain on the screen for a long period of time. Typically a frozen still picture from a VCR. If the 4:3 picture format is used; the fixed images on the sides of the screen may remain visible on the screen.

#### Connection Option 1

Set VCR output switch to 3 or 4 and then tune TV to the same channel number.

#### Connection Option 2

1. Connect the audio and video cables from the VCR's output jacks to the TV input jacks, as shown in the figure.

When connecting the TV to VCR, match the jack colors (Video = yellow, Audio Left = white, and Audio Right = red).

If you connect an S-VIDEO output from VCR to the S-VIDEO input, the picture quality is improved; compared to connecting a regular VCR to the Video input.

2. Insert a video tape into the VCR and press PLAY on the VCR. (Refer to the VCR owner's manual.)
3. Select the input source with using the **TV/VIDEO** button on the remote control. (If connected to A/V INPUT 1, select **Video 1** input source)

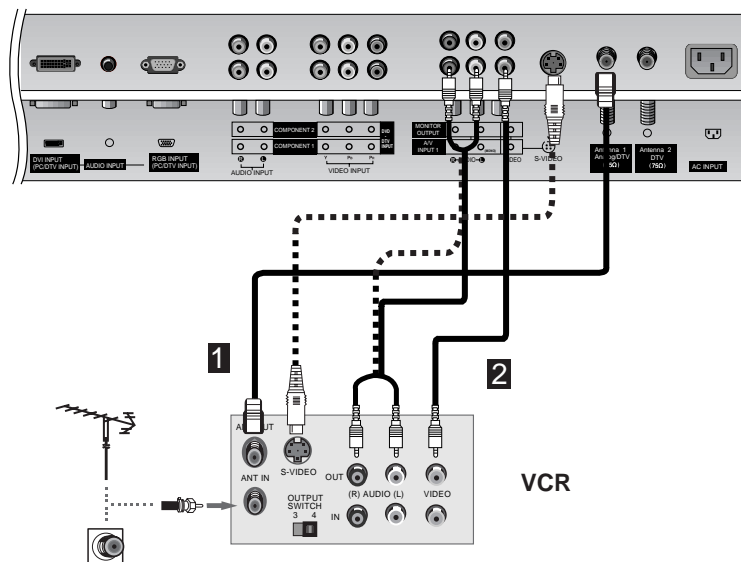

Do not connect to both Video and S-Video at the same time.

### Cable TV Setup

- After subscribing to a cable TV service from a local provider and installing a converter, you can watch cable TV programming. The TV cannot display TV programming unless a TV tuner device or cable TV converter box is connected to the TV.
- For further information regarding cable TV service, contact your local cable TV service provider(s).

#### Connection Option 1

1. Select 3 or 4 with channel switch on cable box.
2. Tune the TV channel to the same selected output channel on cable box.
3. Select channels at the cable box or with the cable box remote control.

#### Connection Option 2

1. Connect the audio and video cables from the Cable Box's output jacks to the TV input jacks, as shown in the figure. When connecting the TV to a Cable Box, match the jack colors (Video = yellow, Audio Left = white, and Audio Right = red).
2. Select the input source with using the **TV/VIDEO** button on the remote control. (If connected to A/V INPUT 1, select **Video 1** input source)
3. Select your desired channel with the remote control for cable box.

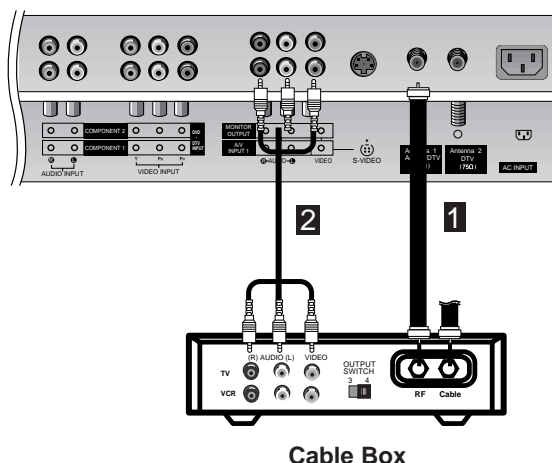

### External A/V Source Setup

#### How to connect

Connect the audio and video cables from the external equipment's output jacks to the TV input jacks, as shown in the figure.

When connecting the TV to external equipment, match the jack colors (Video = yellow, Audio Left = white, and Audio Right = red).

#### How to use

1. Select the input source with using the **TV/VIDEO** button on the remote control. (If connected to A/V INPUT 1, select **Video 1** input source).
2. Operate the corresponding external equipment. Refer to external equipment operating guide.

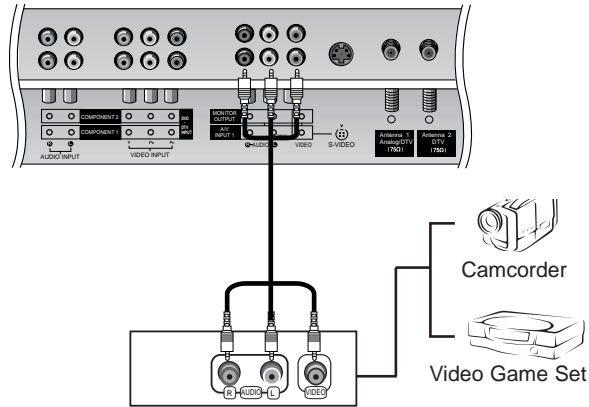

### Monitor Out Setup

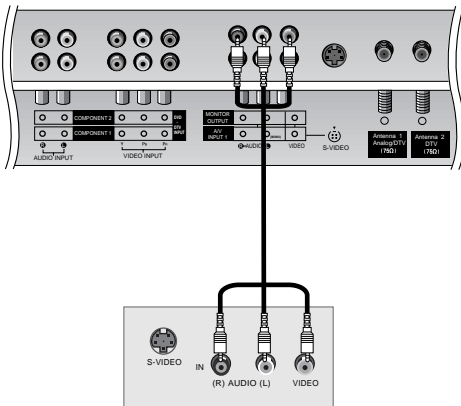

The TV has a special signal output capability which allows you to hook up a second TV or monitor.

Connect the second TV or monitor to the TV's MONITOR OUTPUT. See the Operating Manual of the second TV or monitor for further details regarding that device's input settings.

#### NOTE

- Component, RGB-PC/RGB-DTV, DVI-PC/DVI-DTV, DTV input sources cannot be used for Monitor out.

### DVD Setup

#### How to connect

1. Connect the DVD video outputs (Y, P<sub>B</sub>, P<sub>R</sub>) to the COMPONENT (Y, P<sub>B</sub>, P<sub>R</sub>) INPUT jacks on the TV and connect the DVD audio outputs to the AUDIO INPUT jacks on the TV, as shown in the figure.
2. If your DVD only has an S-Video output jack, connect this to the S-VIDEO input on the TV and connect the DVD audio outputs to the AUDIO INPUT jacks on the TV, as shown in the figure.

**NOTE:** If your DVD player does not have component video output, use S-Video.

#### How to use

1. Turn on the DVD player, insert a DVD.
2. Use the **TV/VIDEO** or **COMP/RGB/DVI** button on the remote control to select **Component 1** or **Component 2**. (If connected to S-VIDEO, select the **Video 1** or **Video 2** external input source.)
3. Refer to the DVD player's manual for operating instructions.

#### • Component Input ports

To get better picture quality, connect a DVD player to the component input ports as shown below.

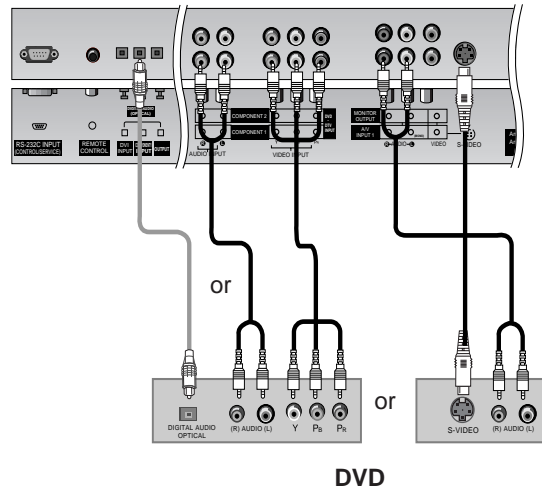

Component ports on the TV	Y	P <sub>B</sub>	P <sub>R</sub>
Video output ports on DVD player	Y	P <sub>B</sub>	P <sub>R</sub>
	Y	B-Y	R-Y
	Y	Cb	Cr
	Y	P <sub>B</sub>	P <sub>R</sub>

#### NOTES

- Digital Audio will not work for Component 2 input source.
- Digital Audio operation has priority if Digital Audio and AUDIO L/R are connected at the same time.

### HDSTB Setup

- This TV can receive Digital Over-the-air/Cable signals without an external digital set-top box. However, if you do receive Digital signals from a digital set-top box or other digital external device, refer to the figure as shown below.
- This TV supports HDCP (High-bandwidth Digital Contents Protection) protocol for DTV (480p,720p,1080i) mode.

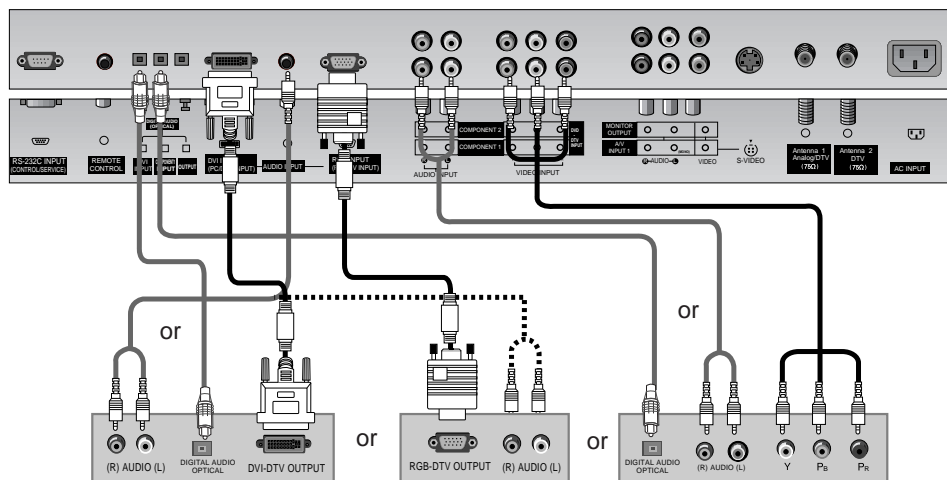

Digital Set-top Box

#### How to connect

Use the TV's COMPONENT (Y, P<sub>B</sub>, P<sub>R</sub>) INPUT, RGB or DVI jack for video connections, depending on your set-top box connector. Then, make the corresponding audio connections.

#### How to use

1. Turn on the digital set-top box. (Refer to the owner's manual for the digital set-top box.)
2. Use **TV/VIDEO** or **COMP/RGB/DVI** on the remote control to select **Component 1**, **Component 2**, **RGB-DTV**, or **DVI-DTV** source.

Signal	Component 1/2	RGB-DTV,DVI-DTV
480i	Yes	No
480p	Yes	Yes
720p	Yes	Yes
1080i	Yes	Yes

### Digital Audio Output

Send the TV's audio to external audio equipment (stereo system) via the Digital Audio Output Optical port.

#### How to connect

1. Connect one end of an optical cable to the TV Digital Audio Optical Output port.
  2. Connect the other end of the optical cable to the digital audio optical input on the audio equipment.
  3. Set the "**TV Speaker** option - **Off**" in the AUDIO menu. Refer to page 23.
- See the external audio equipment instruction manual for operation.



**Caution:** Do not look into the optical output port. Looking at the laser beam may damage your vision.

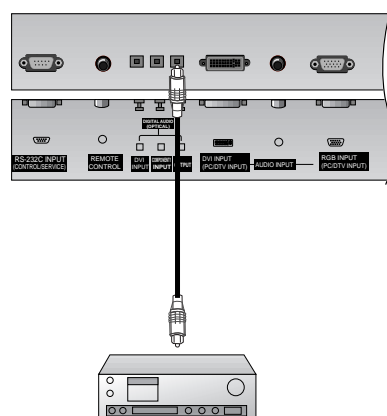

PC Setup

- This TV provides Plug and Play capability, meaning that the PC adjusts automatically to the TV's settings. The TV sends configuration information (EDID) to the PC using the Video Electronics Standard Association (VESA) Display Data Channel (DDC) protocol.
- The TV perceives 640x480, 60Hz as DTV 480p based on the PC graphic card. card, change the screen scanning rate for the graphic card accordingly.

How to connect

1. To get the best picture quality, adjust the PC graphics card to 1024x768, 60Hz.
2. Use the TV's RGB INPUT or DVI (Digital Visual Interface) INPUT port for video connections, depending on your PC connector.
  - If the graphic card on the PC does not output analog and digital RGB simultaneously, connect only one of either RGB INPUT or DVI INPUT to display the PC on the TV.
  - If the graphic card on the PC does output analog and digital RGB simultaneously, set the TV to either RGB or DVI; (the other mode is set to Plug and Play automatically by the TV.)
3. Then, make the corresponding audio connections. If using a sound card, adjust the PC sound as required.

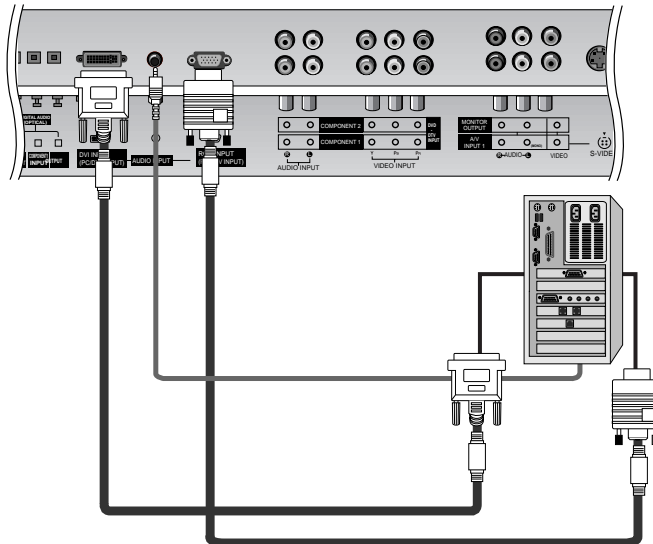

How to use

1. Turn on the PC and the TV.
2. Turn on the display by pressing the POWER button on the TV's remote control.
3. Select **RGB-PC** or **DVI-PC** input source in main input option of SETUP menu. (Refer to P.20)
4. Check the image on your TV. There may be noise associated with the resolution, vertical pattern, contrast or brightness in PC mode. If noise is present, change the PC mode to another resolution, change the refresh rate to another rate or adjust the brightness and contrast on the menu until the picture is clear. If the refresh rate of the PC graphic card can not be changed, change the PC graphic card or consult the manufacturer of the PC graphic card.

- NOTES:**
- Depending on the graphics card, DOS mode may not work if you use a DVI-I cable.
  - Avoid keeping a fixed image on the TV's screen for a long period of time. The fixed image may become permanently imprinted on the screen. Use the Orbiter screen saver when possible.
  - The synchronization input form for Horizontal and Vertical frequencies is separate.

Monitor Display Specifications (RGB-PC / DVI-PC Mode)

Resolution	Horizontal Frequency(KHz)	Vertical Frequency(Hz)	Resolution	Horizontal Frequency(KHz)	Vertical Frequency(Hz)
640x350	31.468	70.09	800x600	35.156	56.25
	37.861	85.08		37.879	60.31
720x400	31.469	70.08		48.077	72.18
	37.927	85.03		46.875	75.00
640x480	31.469	59.94		53.674	85.06
	37.861	72.80		1024x768	48.363
	37.500	75.00	56.476		70.06
	43.269	85.00	60.023		75.02



# Operation

## Screen Setup for PC mode

- Be sure to select the RGB-PC/RGB-DTV source before operation.  
(For RGB-DTV input source, Position and Reset are available.)
- In DVI-PC and DVI-DTV input source, settings are not adjustable.
- You can manually adjust picture position and minimize image shaking for the PC input source.

### Adjustment for screen Position, Clock, and Phase

1. Press the **ADJUST** button and then use **D / E** button to select **POSITION**, **CLOCK**, or **PHASE**.
2. Press **OK** button and then use **D / E / F / G** buttons to make appropriate adjustments.
  - The **PHASE** adjustment range is -16 ~ +16.
  - The **CLOCK** adjustment range is -30 ~ +30.
3. Press **OK** button.

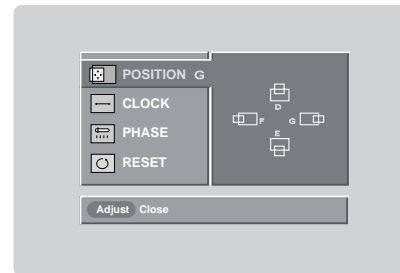

### Initializing (Reset to original factory values)

- To initialize the adjusted values
1. Press the **ADJUST** button and then use **D / E** button to select the **RESET** option.
  2. Press **OK** button and then use **F / G** button to select **Yes**.
  3. Press **OK** button

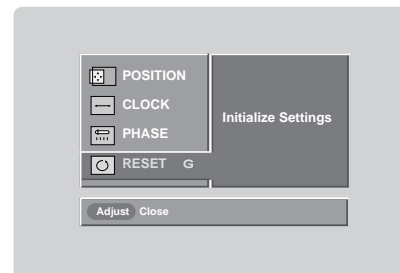

## Turning the TV On

### Turning on the TV just after installation

1. Connect power cord correctly.
2. Press the **⓪ ON/OFF** button on the TV. At this moment, the TV is switched to standby mode.  
Press the **TV/VIDEO, CH (D / E)** button on the TV or press the **POWER, TV/VIDEO, COMP/RGB/DVI, CH (+, -), Number (0 ~ 9)** button on the remote control and then the TV will switch on.

### Turning on the TV (power cord is still connected)

1. If the TV was turned off with the **⓪ ON/OFF** button on the TV
  - Press the **⓪ ON/OFF** button on the TV to turn the TV on.
2. If the TV was turned off with the remote control and then the **⓪ ON/OFF** button on the TV
  - Press the **⓪ ON/OFF** button on the TV and then press the **POWER, TV/VIDEO, COMP/RGB/DVI, CH (+, -), Number (0 ~ 9)** button on the remote control to turn the TV on.

#### NOTE

- If you intend to be away on vacation, disconnect the power plug from the wall power outlet.

## On-screen Menus Language Selection

- The menus can be shown on the screen in the selected language. First select your language.

1. Press the **MENU** button and then use **D / E** button to select the **OPTION** menu.
2. Press the **G** button and then use **D / E** button to select **Language**.
3. Press the **G** button and then use **D / E** button to select your desired language.  
From this point on, the on-screen menus will be shown in the selected language.
4. Press **EXIT** button to return to TV viewing or press **MENU** button to return to the previous menu.

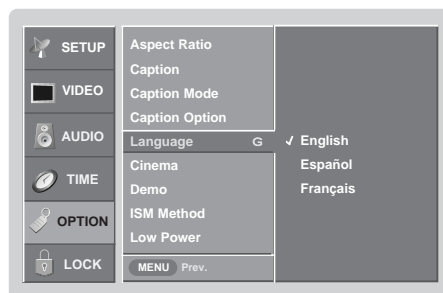

# Setup Menu Options

## EZ Scan (Channel Search)

- Automatically finds all channels available through antenna or cable inputs, and stores them in memory on the channel list.
- Run EZ Scan again after any Antenna/Cable connection changes.

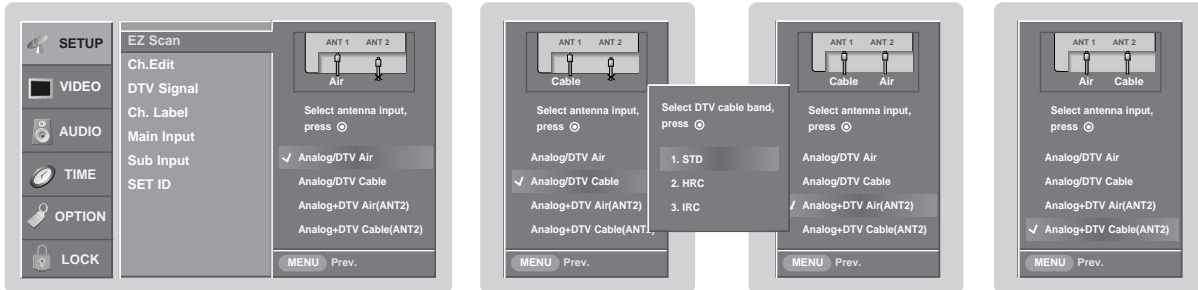

1. Press the **MENU** button and then use **D / E** button to select the **SETUP** menu.
2. Press the **G** button and then use **D / E** button to select **EZ Scan**.
3. Press the **G** button and then use **D / E** button to select antenna input (Based on your connections to antenna 1-2).
  - Analog/DTV Air:  
Watching the Over-the-air, cable, and digital over-the-air signals via antenna 1 input port
  - Analog/DTV Cable:  
Watching the Over-the-air, cable, and digital cable signals via antenna 1 input port
  - Analog+DTV Air (ANT2):  
Watching the Over-the-air, and cable signal via antenna 1 input port and the digital over-the-air signal via antenna 2 input port
  - Analog/DTV Cable (ANT2):  
Watching the Over-the-air, and cable signal via antenna 1 input port and the digital cable signal via antenna 2 input port
4. Press the **OK** button to begin the channel search.  
Allow EZ Scan to complete the channel search cycle for TV, CATV, and DTV/CADTV.

## Channel Edit

- Create two different types of channel lists in memory: "Custom list" and "Surf" (Favorite) channel list" from the default channel list created from the EZ Scan channel search.
- A custom list can be created by toggling each channel on or off with OK button. Once a channel is highlighted, you will be able to see whether the channel is currently added or deleted by referring to the small window at the top-left corner of the screen. You can create your own Surfchannel list with up to 10 channels. It appears at the bottom-left corner of the screen. Use the **SURF** button on the remote control when a channel is highlighted, to add or delete the channel from the Surf channel list.
- You can create your SURF channel list from the channel list memorized from EZ Scan.
- CATV is available for 1-125 channel.

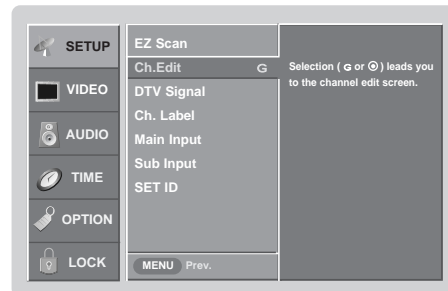

1. Press the **MENU** button and then use **D / E** button to select the **SETUP** menu.
2. Press the **G** button and then use **D / E** button to select **Ch. Edit**.
3. Press the **G** button. You will now see a screen filled with channel numbers and a preview picture.
4. Use **D / E / F / G** button to select a channel and then use the **OK** button to add or delete it. Press **SURF** to add the channel to the Surf List.
5. Press **EXIT** button to return to TV viewing or press **MENU** button to return to the previous menu.



### DTV Signal Strength

- Reveals how strong your DTV signal is and whether you need to adjust your antenna or digital cable input. The higher the signal strength, the less likely you are to experience picture degradation.
- Digital DTV Signals: May not be available in all areas, nor are broadcast on all programs.

1. Press the **SIGNAL** button.
2. View the on-screen signal strength monitor to see the quality of the signal being received.
  - You can also check the **DTV Signal** strength with the **SETUP** menu.

### Channel Label Setup

- Choose preset labels for your channels.
- If a channel label is provided on the signal from the broadcasting station, the TV displays a short name for a DTV channel - even if you didn't preset a label for the channel.

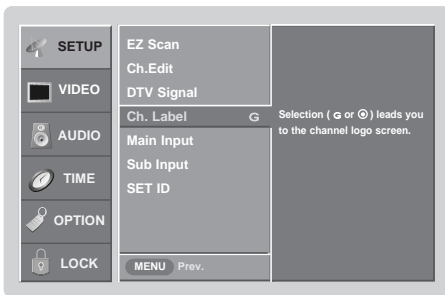

1. Press the **MENU** button and then use **D / E** button to select the **SETUP** menu.
2. Press the **G** button and then use **D / E** button to select **Ch.Label**.
3. Press the **G** button. You will now see a screen filled with Labels and a preview screen.
4. Use the **CH +/-** button to select a channel to Label.
5. Use **D / E / F / G** button to select the appropriate label for the channel, then press **OK** button to set the Label to the selected channel.
6. Press **EXIT** button to return to TV viewing or press **MENU** button to return to the previous menu.

### Main Picture Source Selection

- Changes the picture source so you can watch your off-air TV, cable TV, VCR, DVD, or any other devices that are connected to your TV.

1. Press the **MENU** button and then use **D / E** button to select the **SETUP** menu.
2. Press the **G** button and then use **D / E** button to select **Main Input**.
3. Press the **G** button and then use **D / E** button to select the source: DTV, Analog, Video1, Video2, Component1, Component2, RGB-DTV (or RGB-PC), DVI-DTV (or DVI-PC).
4. Press **EXIT** button to return to TV viewing or press **MENU** button to return to the previous menu.

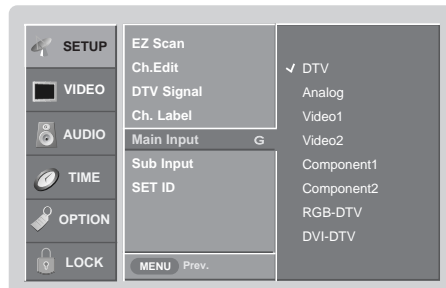

# Video Menu Options

## EZ Picture

- EZ Picture adjusts the TV for the best picture appearance. Select the preset value in the EZ Picture menu based on the program category.
  - When adjusting Video menu options (contrast, brightness, color, sharpness, tint, and color temperature) manually, EZ Picture automatically changes to **Off**.
  - **Day Light, Normal, Night Time, Movie, Video Game,** and **Sports** settings are preset for optimum picture quality at the factory and are not adjustable.
1. Press the **VIDEO** button repeatedly to select the picture appearance setup option as shown below: **Off** (your own settings), **Day Light, Normal, Night Time, Movie, Video Game,** and **Sports**.
    - You can also use the **VIDEO** menu to adjust **EZ Picture**.
  2. Press the **EXIT** button to save and return to TV viewing.

## Manual Picture Control (**Off** option)

- Adjust the picture appearance to suit your preference and viewing situations.
1. Press the **MENU** button and then use **D / E** button to select the **VIDEO** menu.
  2. Press the **G** button and then use **D / E** button to select the desired picture option (**Contrast, Brightness, Color, Sharpness,** or **Tint**).
  3. Press the **G** button and then use **F / G** button to make appropriate adjustments.
  4. Press **EXIT** button to return to TV viewing or press **MENU** button to return to the previous menu.

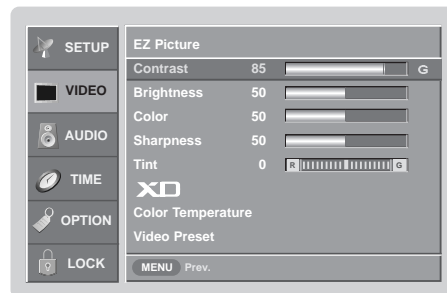

## Color Temperature Control

- Choose one of three automatic color adjustments. Set to warm to enhance hotter colors such as red, or set to cool to see less intense colors with more blue.
1. Press the **MENU** button and then use **D / E** button to select the **VIDEO** menu.
  2. Press the **G** button and then use **D / E** button to select **Color Temperature**.
  3. Press the **G** button and then use **D / E** button to select either **Warm, Medium,** or **Cool**.
  4. Press **EXIT** button to return to TV viewing or press **MENU** button to return to the previous menu.

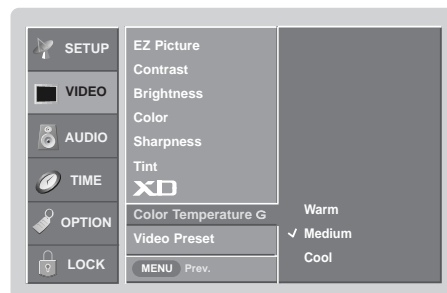

## Video Preset

- Use to quickly reset all the Video menu options to their original factory preset values.
1. Press the **MENU** button and then use **D / E** button to select the **VIDEO** menu.
  2. Press the **G** button and then use **D / E** button to select **Video Preset**.
  3. Press the **G** button to reset the Video menu options to original values.

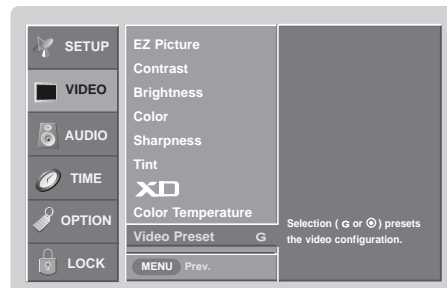

# Audio Menu Options

## Audio Language

- Other languages may be available if a digital signal is provided by the broadcasting station.

1. Press the **MENU** button and then use **D / E** button to select the **AUDIO** menu.
2. Press the **G** button and then use **D / E** button to select **Audio Language**.
3. Press the **G** button and then use **D / E** button to select: English, Spanish, or French.
4. Press **EXIT** button to return to TV viewing or press **MENU** button to return to the previous menu.

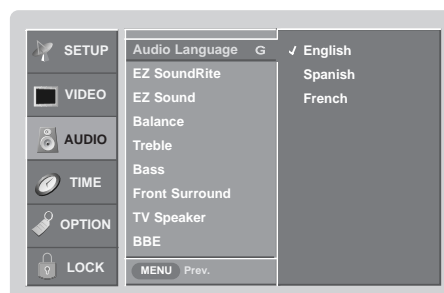

## EZ SoundRite

- Scans for changes in sound level during commercials, then adjusts the sound to match the specified audio level. SoundRite makes sure that the volume level remains consistent whether you are watching a commercial or a regular TV program.

1. Press the **MENU** button and then use **D / E** button to select the **AUDIO** menu.
2. Press the **G** button and then use **D / E** button to select **EZ SoundRite**.
3. Press the **G** button and then use **D / E** button to select **On** or **Off**.
4. Press **EXIT** button to return to TV viewing or press **MENU** button to return to the previous menu.

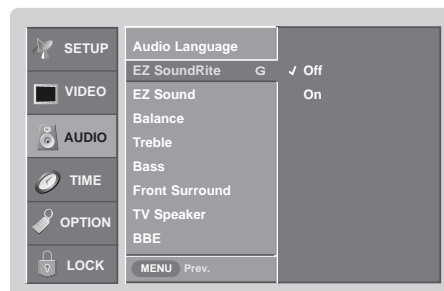

## EZ Sound

- EZ Sound lets you enjoy the best sound without any special adjustment because the TV sets the appropriate sound options based on the program content.
- When adjusting sound options (treble, bass, and front surround) manually, EZ Sound automatically switches **Off**.
- **Normal, Stadium, Theater,** and **Music** are preset for good sound quality at the factory and are not adjustable.

1. Press the **SOUND** button repeatedly to select the appropriate sound setup as shown below:
  - Off** (your own settings), **Normal, Stadium, Theater,** and **Music**.
  - You can also adjust **EZ Sound** in the **AUDIO** menu.
2. Press **EXIT** button to save and return to TV viewing.

## Audio Menu Options continued

### Manual Sound Control (**Off** option)

- Adjust the sound to suit your taste and room situations.
1. Press the **MENU** button and then use **D / E** button to select the **AUDIO** menu.
  2. Press the **G** button and then use **D / E** button to select the desired sound option (**Balance**, **Treble**, or **Bass**).
  3. Press the **G** button and then use **F / G** button to make appropriate adjustments.
  4. Press **EXIT** button to return to TV viewing or press **MENU** button to return to the previous menu.

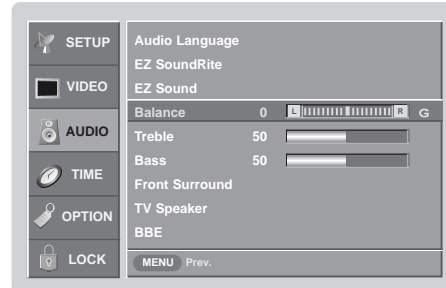

### Stereo/SAP Broadcasts Setup

- This TV can receive MTS stereo programs and any SAP (Secondary Audio Program) that accompanies the stereo program; if the station transmits an additional sound signal as well as the original one.
  - Stereo or SAP can be received only when the TV station transmits those signals even though you have selected Stereo or SAP.
  - Mono sound is automatically received if the broadcast is only in Mono; even though Stereo or SAP has been selected.
  - Select Mono if you want to listen to the mono sound in remote fringe areas during stereo/SAP broadcasting.
1. Use the **SAP** button to select your desired MTS mode in analog signal. Each time you press the **SAP** button, **Mono**, **Stereo**, or **SAP** appear in turn.
    - If other languages available on the digital signal, select them with the **SAP** button.
  2. Press **EXIT** button to save and return to TV viewing.

### Front Surround

-  is a trademark of SRS Labs, Inc.
- TruSurround XT technology is incorporated under license from SRS Labs, Inc.
- Manufactured under license from Dolby Laboratories. "Dolby" and the double-D symbol are trademarks of Dolby Laboratories.

1. Press the **MENU** button and then use **D / E** button to select the **AUDIO** menu.
2. Press the **G** button and then use **D / E** button to select **Front Surround**.
3. Press the **G** button and then use **D / E** button to select **Off**, **3D EchoSound System** or **SRS** (Sound Retrieval System) **TruSurround XT**.
  - **SRS TruSurround XT**  
Takes advantage of any multi-channel format without needing to add extra speakers or equipment. Dialog clarity, bass enrichment, and the addition of stereo audio enhancement that produces an immersive sound experience from standard stereo material.
  - **3D EchoSound System**  
Creates a stunning simulated stereo effects from any mono sound and a realistic three-dimensional sound with a very wide and deep sound stage into stereo sound.
4. Press **EXIT** button to return to TV viewing or press **MENU** button to return to the previous menu.

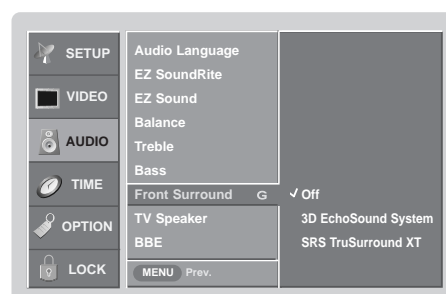

### TV Speakers On/Off Setup

- Turn TV speakers off if using external audio equipment. Feature turns the TV Speakers option On or Off.

1. Press the **MENU** button and then use **D / E** button to select the **AUDIO** menu.
2. Press the **G** button and then use **D / E** button to select **TV Speaker**.
3. Press the **G** button and then use **D / E** button to select **On** or **Off**.
4. Press **EXIT** button to return to TV viewing or press **MENU** button to return to the previous menu.

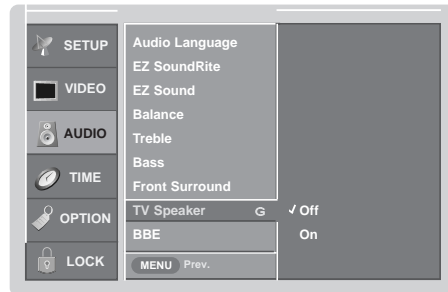

### BBE

- BBE High Definition Sound restores clarity and presence for better speech intelligibility and music realism.

1. Press the **MENU** button and then use **D / E** button to select the **AUDIO** menu.
2. Press the **G** button and then use **D / E** button to select **BBE**.
3. Press the **G** button and then use **D / E** button to select **On** or **Off**.
4. Press **EXIT** button to return to TV viewing or press **MENU** button to return to the previous menu.

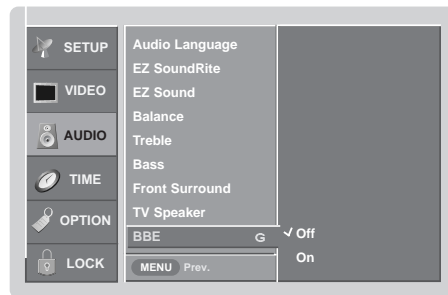



# Time Menu Options

## Auto Clock Setup

- The time is set automatically from a digital channel signal.
- The digital channel signal includes information for the current time provided by the broadcasting station.
- Set the clock manually, if the current time is set incorrectly by the auto clock function.

1. Press the **MENU** button and then use **D / E** button to select the **TIME** menu.
2. Press the **G** button and then use **D / E** button to select **Auto Clock**.
3. Press the **G** button and then use **D / E** button to select **On**.
4. Press the **G** button and then use **D / E** button to select your viewing area time zone: **Eastern, Central, Mountain, Pacific, Alaska, or Hawaii**.
5. Press **EXIT** button to return to TV viewing or press **MENU** button to return to the previous menu.

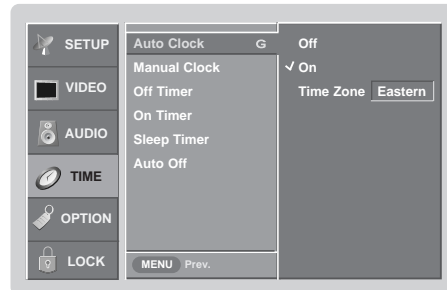

## Manual Clock Setup

- If current time setting is wrong, reset the clock manually.

1. Press the **MENU** button and then use **D / E** button to select the **TIME** menu.
2. Press the **G** button and then use **D / E** button to select **Manual Clock**.
3. Press the **G** button and then use **F / G** button to select either the year, date, or time option. Once selected, use the **D / E** button to set the year, date, and time options.
4. Press **EXIT** button to return to TV viewing or press **MENU** button to return to the previous menu.



## On/Off Timer Setup

- Timer function operates only if current time has been set.
- Off-Timer function overrides On-Timer function if they are set both set to the same time.
- The TV must be in standby mode for the On-Timer to work.
- If you do not press any button within 2 hours after the TV turns on with the On Timer function, the TV will automatically revert to standby mode.

1. Press the **MENU** button and then use **D / E** button to select the **TIME** menu.
2. Press the **G** button and then use **D / E** button to select **Off Timer** or **On Timer**.
3. Press the **G** button and then use **D / E** button to select **On**.
  - To cancel **On/Off timer** function, select **Off**.
4. Press the **G** button and then use **D / E** button to set the hour.
5. Press the **G** button and then use **D / E** button to set the minutes.
6. **For only On timer function**
  - Press the **G** button and then use **D / E** button to select the channel at turn-on.
  - Press the **G** button and then use **D / E** button to set the sound level at turn-on.
7. Press **EXIT** button to return to TV viewing or press **MENU** button to return to the previous menu.

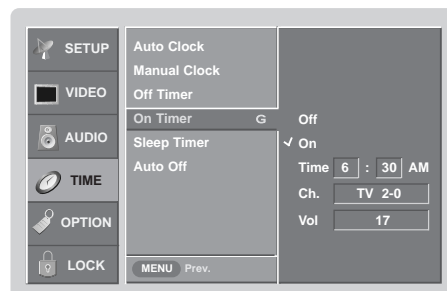

### Sleep Timer

- The Sleep Timer turns the TV off at the preset time. Note that this setting is cleared when the TV is turned off.
  - You can also set up the **Sleep Timer** in the **TIME** menu.
1. Press the **TIMER** button repeatedly to select the number of minutes. First the **Off** option appears on the screen, followed by the following sleep timer options: 10, 20, 30, 60, 90, 120, 180, and 240 minutes.
  2. When the number of minutes you want is displayed on the screen, press the **OK** button. The timer begins to count down from the number of minutes selected.
  3. To check the remaining minutes before the TV turns off, press the **TIMER** button once.
  4. To cancel the Sleep Timer, press the **TIMER** button repeatedly to select **Off**.

### Auto Off

- If set to on and there is no input signal, the TV turns off vertically after 10 minutes.
1. Press the **MENU** button and then use **D / E** button to select the **TIME** menu.
  2. Press the **G** button and then use **D / E** button to select **Auto Off**.
  3. Press the **G** button and then use **D / E** button to select **On** or **Off**.
  4. Press **EXIT** button to return to TV viewing or press **MENU** button to return to the previous menu.

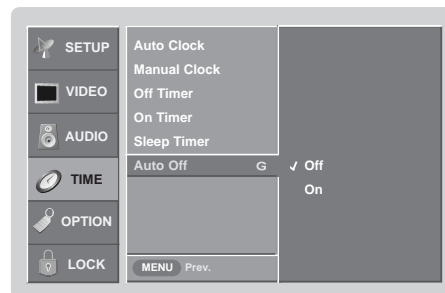

# Option Menu Features

## Aspect Ratio Control

- Lets you choose the way an analog picture with a 4:3 aspect ratio is displayed on your TV with a 16:9 ratio picture format. When you receive an analog picture with a 4:3 aspect ratio on your 16:9 TV, you need to specify how the picture is to be displayed.
- If you are viewing a picture with a 16:9 aspect ratio, you can't use the Horizon aspect ratio option.
- Horizon aspect ratio is not available for Component 1-2 (720p/1080i)/RGB-DTV (720p/1080i)/DVI-DTV (720p/1080i)/DTV(720p/1080i) input source.
- RGB-PC/DVI-PC input source use 4:3 or 16:9 aspect ratio.
- **Note:** If a fixed image is displayed on the screen for a long time, that fixed image may become imprinted on the screen and remain visible.

1. Press the **RATIO** button repeatedly to select the desired picture format.  
You can also adjust **Aspect Ratio** in the **OPTION** menu.

- **Set By Program**

Selects the proper picture proportion to match the source's image. (4:3 → 4:3, 16:9 → 16:9)

- **4:3**

Choose **4:3** when you want to view a picture with an original 4:3 aspect ratio, with black bars appearing at both the left and right sides.

- **16:9**

Choose **16:9** when you want to adjust the picture horizontally, in a linear proportion to fill the entire screen.

- **Horizon**

Choose **Horizon** when you want to adjust the picture in a non-linear proportion, that is, more enlarged at both sides, to create a spectacular view.

- **Zoom 1**

Choose **Zoom 1** when you want to view the picture without any alteration. However, the top and bottom portions of the picture will be cropped.

- **Zoom 2**

Choose **Zoom 2** when you want the picture to be altered, both horizontally extended and vertically cropped. The picture taking a halfway trade off between alteration and screen coverage.

- **Cinema Zoom**

Choose **Cinema Zoom** when you want to enlarge the picture in correct proportion. Note: When enlarging or reducing the picture, the image may become distorted.

You can adjust the enlarge proportion of Cinema Zoom using **D / E** button. The adjustment range is 1-16.

## Caption

- Use the **CC** button repeatedly to select Caption **Off**, **EZ Mute**, or **On**.
  - EZ Mute** shows the selected captions option (if available on program) when the TV sound is muted.
  - You can also use the **OPTION** menu to select **Caption**.
- Press **EXIT** button to save and return to TV viewing.

## Caption Mode

### Analog Broadcasting System Captions

- Select a caption mode for displaying captioning information if provided on a program.
- Analog caption displays information at any position on the screen usually the program's dialog.
- Text displays information, usually at the bottom position and is used for a data service, generally not program related.
- Caption/Text, if provided by the broadcaster, would be available for both digital and analog channels on the Antenna 1 source.
- This TV is programmed to remember the caption/text mode it was last set to, when you turn the power off.

- Press the **MENU** button and then use **D / E** button to select the **OPTION** menu.
- Press the **G** button and then use **D / E** button to select **Caption Mode**.
- Press the **G** button and then use **D / E** button to select caption: **CC1**, **CC2**, **CC3**, **CC4**, **Text1**, **Text2**, **Text3**, or **Text4**.

#### • CAPTION

The term for the words that scroll across the bottom of the TV screen; usually the audio portion of the program provided for the hearing impaired.

#### • TEXT

The term for the words that appear in a large black frame and almost cover the entire screen; usually messages provided by the broadcaster.

- Press **EXIT** button to return to TV viewing or press **MENU** button to return to the previous menu.

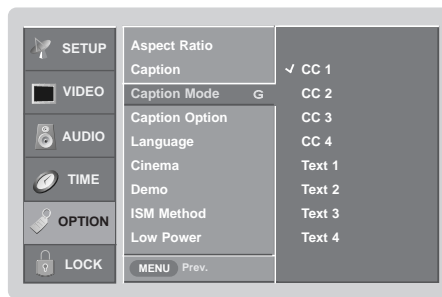

### Digital Broadcasting System Captions

- Choose the language you want the DTV/CADTV Captions to appear in.
- Languages can be chosen for digital sources only if they are included on the program.

- Press the **MENU** button and then use **D / E** button to select the **OPTION** menu.
- Press the **G** button and then use **D / E** button to select **Caption Mode**.
- Press the **G** button and then use **D / E** button to select available caption languages: **English**, **Spanish**, or **French**.
- Press **EXIT** button to return to TV viewing or press **MENU** button to return to the previous menu.

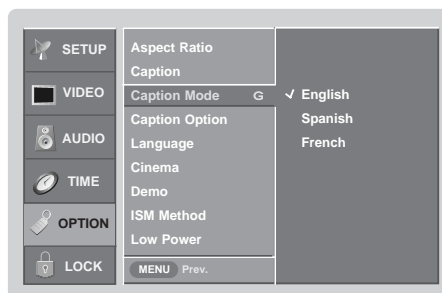

## Option Menu Features continued

### Caption Option

- Customize the DTV/CADTV captions that appear on your screen.
1. Press the **MENU** button and then use **D / E** button to select the **OPTION** menu.
  2. Press the **G** button and then use **D / E** button to select **Caption Option**.
  3. Press the **G** button and then use **F / G** button to select **Custom**.
  4. Use **D / E** button to customize the Style, Font, etc., to your preference. A preview icon is provided at the bottom of the screen, use it to see the caption language.
    - **Size:** Set the size the words will appear in.
    - **Font:** Select a typeface for the words.
    - **Text Color:** Choose a color for the text.
    - **Text Opacity:** Specify the opacity for the text color.
    - **Bg (Background) Color:** Select a background color.
    - **Bg (Background) Opacity:** Select the opacity for the background color.
    - **Edge Type:** Select an edge type.
    - **Edge Color:** Select a color for the edges.
  5. Press **EXIT** button to return to TV viewing or press **MENU** button to return to the previous menu.

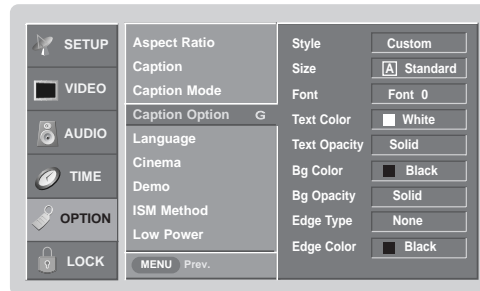

### Cinema Mode Setup

- Set up the TV for the best picture appearance for viewing movies.
1. Press the **MENU** button and then use **D / E** button to select the **OPTION** menu.
  2. Press the **G** button and then use **D / E** button to select **Cinema**.
  3. Press the **G** button and then use **D / E** button to select **On** or **Off**.
  4. Press **EXIT** button to return to TV viewing or press **MENU** button to return to the previous menu.

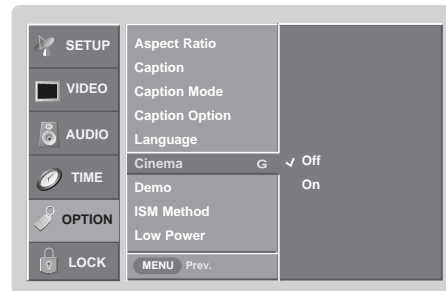

### Demo

- **EZ Demo** Use to scan the features and menu options available on your TV.
  - **XD Demo** Use to see the difference between XD Demo On and XD Demo Off.
1. Press the **MENU** button and then use **D / E** button to select the **OPTION** menu.
  2. Press the **G** button and then use **D / E** button to select **Demo**.
  3. Press the **G** button and then use **D / E** button to select **EZ Demo** or **XD Demo**.
  4. Press the **G** button to start EZ Demo or XD Demo. Press **EXIT** button to stop EZ Demo or XD Demo.

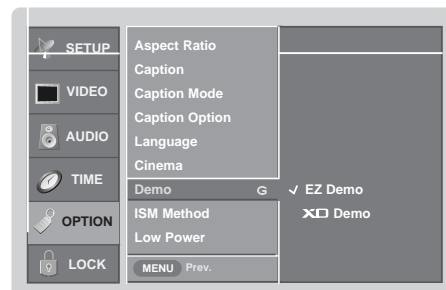

### ISM (Image Sticking Minimization) Method

- A frozen still picture from a PC/video game displayed on the screen for prolonged periods will result in an ghost image remaining; even when you change the image. Avoid allowing any fixed image to remain on the TV's screen for a long period of time.

1. Press the **MENU** button and then use **D / E** button to select the **OPTION** menu.
2. Press the **G** button and then use **D / E** button to select **ISM Method**.
3. Press the **G** button and then use **D / E** button to select either **Normal**, **Orbiter**, **Inversion**, or **White Wash**.

• **Normal**

If image sticking is never a problem, ISM is not necessary - set to Normal. When image is stopped, screen light automatically get dark to prevent ghost images, and image is appeared, screen light get bright, automatically.

• **Orbiter**

Orbiter may help prevent ghost images. However, it is best not to allow any fixed image to remain on the screen. To avoid a permanent image on the screen, the image will move once per minute: Right → Right → Downside → Downside → Left → Left → Upside → Upside.

• **Inversion**

Inversion will automatically invert the plasma display panel color every 30 minutes.

• **White Wash**

White Wash remove s permanent images from the screen. Note: An excessive permanent image may be impossible to clear entirely with White Wash. To return to normal viewing, press the any button.

4. Press **EXIT** button to return to TV viewing or press **MENU** button to return to the previous menu.

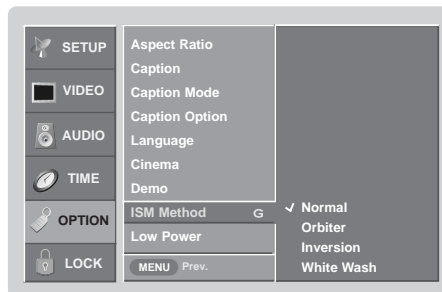

### Low Power

- Low power reduces the plasma display's power consumption.

1. Press the **MENU** button and then use **D / E** button to select the **OPTION** menu.
2. Press the **G** button and then use **D / E** button to select **Low power**.
3. Press the **G** button and then use **D / E** button to select **On** or **Off**.
  - If you select **On**, the screen darkens.
4. Press **EXIT** button to return to TV viewing or press **MENU** button to return to the previous menu.

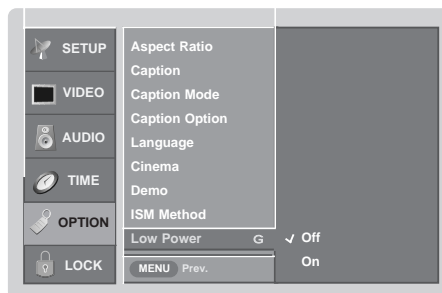

### Split Zoom (DTV 720p, or 1080i mode only)

- Enlarges the picture with correct proportions.  
 - When enlarging the picture, the image may become distorted.

1. Press the **ZOOM** button in DTV 720p, or 1080i modes.
2. Use the **D / E / F / G** buttons to select the screen split zoom section.
3. To return to normal viewing, press the **ZOOM** button again.



# Lock Menu Options

Parental Control can be used to block specific channels, ratings and other viewing sources.

The Parental Control Function (V-Chip) is used to block program viewing based on the ratings sent by the broadcasting station. The default setting is to allow all programs to be viewed. Viewing can be blocked by the type of program and by the categories chosen to be blocked. It is also possible to block all program viewing for a time period. To use this function, the following must be done :

1. Set ratings and categories to be blocked.
2. Specify a password
3. Enable the lock

## V-Chip rating and categories

Rating guidelines are provided by broadcasting stations. Most television programs and television movies can be blocked by TV Rating and/or Individual Categories. Movies that have been shown at the theaters or direct-to-video movies use the Movie Rating System (MPAA) only.

### Ratings for Movies previously shown in theaters:

#### Movie Ratings :

- Blocking Off (Permits all programs)
- G (General audience)
- PG (Parental guidance suggested)
- PG-13 (Parents strongly cautioned)
- R (Restricted)
- NC-17 (No one 17 and under admitted)
- X (Adult only)

If you set PG-13 : G and PG movies will be available , PG-13, R, NC-17 and X will be blocked.

### Ratings for Television programs including made-for-TV movies :

- TV-G (General audience)
- TV-PG (Parental guidance suggested)
- TV-14 (Parents strongly cautioned)
- TV-MA (Mature audience only)
- TV-Y (All children)
- TV-Y7 (Children 7 years older)

#### TV Rating Children:

- Age (applies to TV-Y, TV-Y7)
- Fantasy Violence (applies to TV-Y7)

#### TV Rating General:

- Age (applies to TV-G, TV-PG, TV-14, TV-MA)
- Dialogue - sexual dialogue (applies to TV-PG, TV-14)
- Language - adult language (applies to TV-PG, TV-14, TV-MA)
- Sex - sexual situations (applies to TV-PG, TV-14, TV-MA)
- Violence (applies to TV-PG, TV-14, TV-MA)

#### Aux. Block

- Video 1, 2 (On, Off)
- Component 1, 2 (On, Off)
- RGB, DVI (On, Off)

## Parental Lock Setup

- Lets you set up blocking schemes to block specific channels, ratings, and external viewing sources.
- A password is required to gain access to this menu if the Lock System is turned on

1. Press the **MENU** button and then use **D / E** button to select the **LOCK** menu. Then, press the **G** button

- If **Lock** is already set, enter the password as requested.
- The TV is set up with the initial password "7-7-7-7".

2. Use the **D / E** button to choose from the following Lock Menu options. Once the option is selected, change the settings to your preference.

- **Lock System:** Activates or disables the blocking scheme you set up previously.
- **Set Password:** Change the password by inputting a new password twice.
- **Movie Rating (MPPA):** Blocks movies according to the movie ratings limits specified, so children cannot view certain movies. You can set the ratings limit by blocking out all the movies with the ratings above a specified level. Keep in mind that the movie ratings limit only applies to movies shown on TV, not TV programs, such as soap operas.
- **TV Rating-Children:** Prevents children from watching certain children's TV programs, according to the ratings limit set. The children rating does not apply to other TV programs. Unless you block certain TV programs intended for mature audiences in the TV Rating - sub menu, your children can view those programs.
- **TV Rating-General:** Based on the ratings, blocks certain TV programs that you and your family do not want to view.
- **Aux. Block:** Enables you to select a source to block from the external source devices you have hooked up.

3. Press **EXIT** button to return to TV viewing or press **MENU** button to return to the previous menu.

### Note

- If you ever forget your password, key in '7', '7', '7', '7' on the remote control.

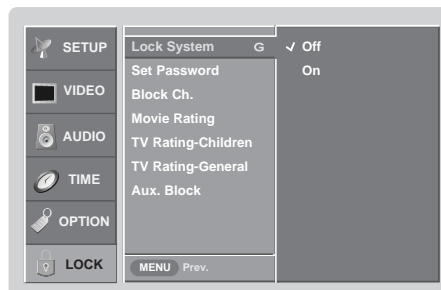



# PIP (Picture-In-Picture) / POP / Twin Picture

- PIP lets you view 2 different inputs (sources) on your TV screen at the same time. One source will be large, and the other source will show a smaller inset image.
- Twin Picture mode splits the screen into 2, allowing 2 picture sources to be shown on the TV screen at the same time. Each source is given half the screen.
- If you set the block/rating for Lock menu options in PIP/Twin Picture mode, "**Rating Blocked**" doesn't display on screen.

## Watching PIP/POP/Twin Picture

Press the PIP button to access the sub picture. Each press of PIP changes the PIP options as shown below.

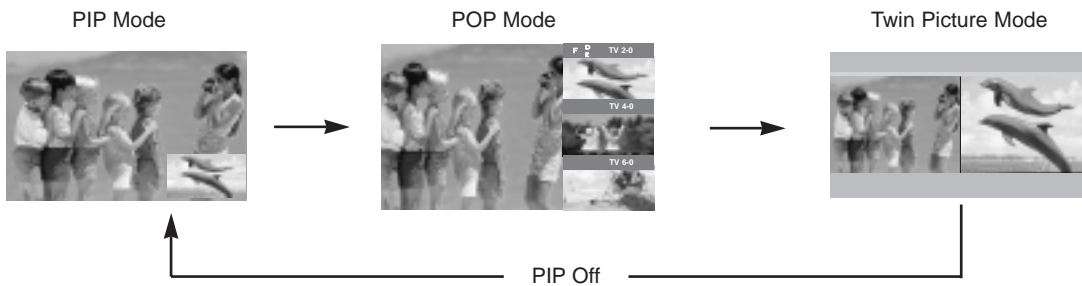

## Selecting an Input Signal Source for PIP/Twin Picture

Use the **PIP INPUT** button to select the input source for the sub picture. Each press of **PIP INPUT** button changes the PIP source. You can also select sources for the **Sub Input** in the **SETUP** menu.

Main Picture Source	Available Sub Picture Sources
DTV Signal	Analog, Video 1, and Video 2
Analog Signal	DTV, Analog, Video 1, and Video 2

## Swapping the PIP/Twin Picture

Use the **SWAP** button to switch the main and sub pictures.

- Component 1, Component 2, RGB-PC (or RGB-DTV), DVI-DTV (or DVI-PC) input sources for the main picture can't be used to swap the main and sub pictures.

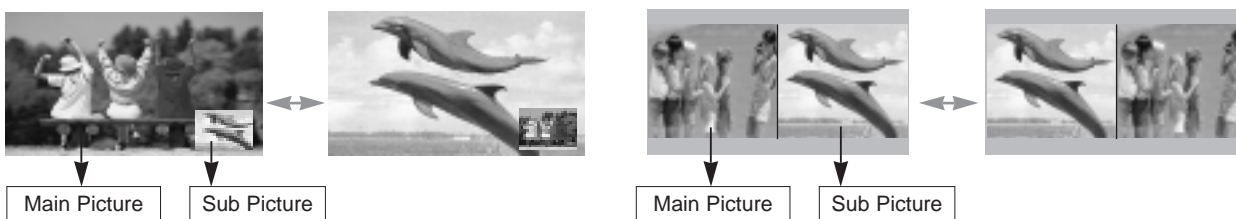

## TV Program Selection for PIP

1. Press the **PIP** button.
2. Select the Analog or DTV option on the Sub input menu or with the PIP INPUT button. Use the **PIPCH+** / **PIPCH-** button to select a channel for the sub picture.

### Moving the PIP sub picture

In PIP mode, press the **D / E / F / G** button to move the sub picture to a different location on the screen.



### Adjusting Main and Sub Picture Sizes for Twin Picture

Use the **D / E / F / G** button to change main and sub picture sizes in Twin Picture mode.

i.e)

	<p>If the maximal adjusted screen is 16:9, the large screen appears the gray part at both the up and down sides.</p>		<p>If the maximal adjusted screen is 4:3, the large screen is filled with entire screen vertically as shown.</p>
--	--	--	--

### POP (Picture-out-of-Picture: Channel Scan)

- Use POP to search the programs of all the memorized channels one-by-one on the 3 PIP screen display, (while the main picture source remains the current channel). The pictures of all the programmed channels are searched with the 3 POP screen.
- Note: Run EZ Scan channel search before using POP mode.

1. Press the **PIP** button to activate the POP mode while in PIP mode.

- **Channel selection:** Use **F** button to enlarge the selected channel being searched on the PIP screen to shift it for viewing on the Main screen.
- **PIP selection:** Use **D / E** button to select one of 3 PIP screen pictures in POP mode.
- **Input source selection for PIP:** Use PIP INPUT button or Sub Input option on the SETUP menu to select an input source for the sub picture (You can't select DTV for main and sub picture simultaneously). You can only select the Analog and DTV signal for sub input source in POP mode.



2. Press the **EXIT** button to cancel POP mode.

# External Control Device Setup

- Connect the RS-232C input jack to an external control device (such as a computer or an A/V control system) and control the Monitor's functions externally.
- Connect the serial port of the control device to the RS-232C jack on the Monitor back panel.
- RS-232C connection cables are not supplied with the Monitor.

## RS-232C Setup

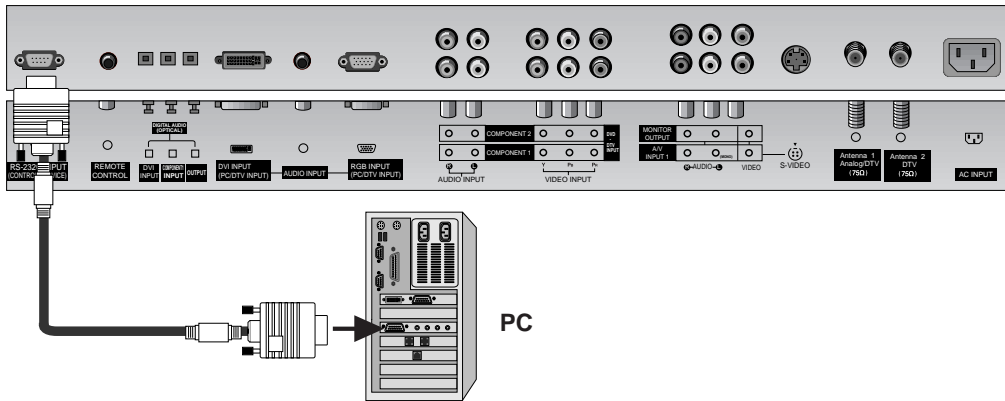

## Type of Connector; D-Sub 9-Pin Male

No.	Pin Name
1	No connection
2	RXD (Receive data)
3	TXD (Transmit data)
4	DTR (DTE side ready)
5	GND
6	DSR (DCE side ready)
7	RTS (Ready to send)
8	CTS (Clear to send)
9	No Connection

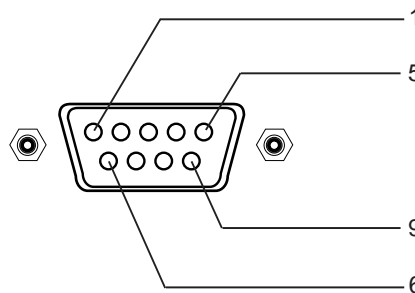

## RS-232C Configurations

### 7-Wire Configurations (Standard RS-232C cable)

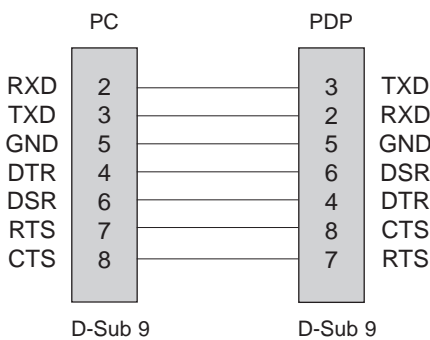

### 3-Wire Configurations (Not standard)

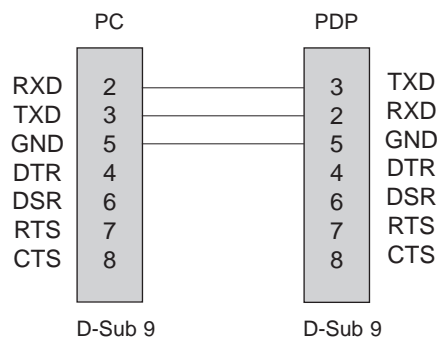

## Set ID

Use this function to specify a monitor ID number.  
Refer to 'Real Data Mapping'. See page 37.

1. Press the **MENU** button and then use **D / E** button to select the **SETUP** menu.
2. Press the **G** button and then use **D / E** button to select **SET ID**.
3. Press the **G** button and then use **D / E** button to adjust **SET ID** to choose the desired monitor ID number. The adjustment range of **SET ID** is 1 ~ 99.
4. Press **EXIT** button to return to TV viewing or press **MENU** button to return to the previous menu.

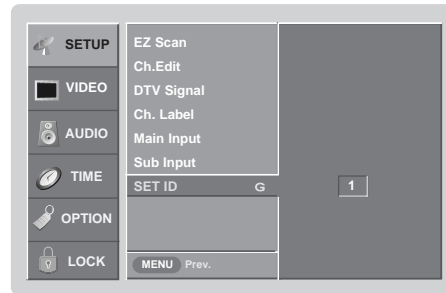

## Communication Parameters

- Baud rate : 9600 bps (UART)
- Data length : 8 bits
- Parity : None
- Stop bit : 1 bit
- Communication code : ASCII code

\* Use a crossed (reverse) cable.

## Transmission / Receiving Protocol

### Transmission

**[Command1][Command2][ ][Set ID][ ][Data][Cr]**

- \* [Command 1]: First command to control the set. (j or k)
- \* [Command 2]: Second command to control the set.
- \* [Set ID]: You can adjust the set ID to choose desired monitor ID number in Setup menu. Adjustment range is 1 ~ 99. When selecting Set ID '0', every connected the TV is controlled. Set ID is indicated as decimal (1~99) on menu and as Hexa decimal (0x0~0x63) on transmission/receiving protocol.
- \* [DATA]: To transmit command data.  
Transmit 'FF' data to read status of command.
- \* [Cr]: Carriage Return  
ASCII code '0x0D'
- \* [ ]: ASCII code 'space (0x20)'

### OK Acknowledgement

**[Command2][ ][Set ID][ ][OK][Data][x]**

- \* The Monitor transmits ACK (acknowledgement) based on this format when receiving normal data. At this time, if the data is data read mode, it indicates present status data. If the data is data write mode, it returns the data of the PC computer.

### Error Acknowledgement

**[Command2][ ][Set ID][ ][NG][Data][x]**

- \* The Monitor transmits ACK (acknowledgement) based on this format when receiving abnormal data from non-viable functions or communication errors.

- Data
- 1: Illegal Code
  - 2: Not supported function
  - 3: Wait more time

## Command Reference List

	COMMAND 1	COMMAND 2	DATA (Hexadecimal)
01. Power	k	a	0 ~ 1
02. Input Select	k	b	0 ~ 9
03. Aspect Ratio	k	c	0 ~ 15
04. Screen Mute	k	d	0 ~ 1
05. Volume Mute	k	e	0 ~ 1
06. Volume Control	k	f	0 ~ 64
07. Contrast	k	g	0 ~ 64
08. Brightness	k	h	0 ~ 64
09. Color	k	i	0 ~ 64
10. Tint	k	j	0 ~ 64
11. Sharpness	k	k	0 ~ 64
12. OSD Select	k	l	0 ~ 1
13. Key Lock Mode	k	m	0 ~ 1
14. PIP/POP/Twin Picture	k	n	0 ~ 3
15. PIP Position	k	q	0 ~ 3
16. Treble	k	r	0 ~ 64
17. Bass	k	s	0 ~ 64
18. Balance	k	t	0 ~ 64
19. Color Temperature	k	u	0 ~ 2
20. PIP Input Source	k	y	0 ~ 3
21. ISM Method	j	p	0 ~ 2
22. White Wash	j	q	0 ~ 1
23. Orbiter Time Setting	j	r	1 ~ 64
24. Orbiter Pixel Setting	j	s	0 ~ A

	COM- MAND 1	COM- MAND 2	DATA 0 (Hexadecimal)	DATA 1 (Hexadecimal)	DATA 2 (Hexadecimal)	DATA 3 (Hexadecimal)
25. Channel Tuning	m	a	01 ~ 87	01 ~ 87	00 ~ FE	00 ~ 15
26. Channel Add/Del	m	b	00 ~ 01			
27. Key	m	c				

**01. Power (Command2:a)**

G To control Power On/Off of the Monitor.

Transmission

[k][a][ ][Set ID][ ][Data][Cr]

Data 0 : Power Off                                  1 : Power On

Acknowledgement

[a][ ][Set ID][ ][OK][Data][x]

\* In a like manner, if other functions transmit 'FF' data based on this format, Acknowledgement data feedback presents status about each function.

**02. Input Select (Command2:b) (Main Picture Input)**

G To select input source for the Monitor.

Transmission

[k][b][ ][Set ID][ ][Data][Cr]

Data 0: DTV    5: Component 2  
 1: Analog    6: RGB-DTV  
 2: Video 1    7: RGB-PC  
 3: Video 2    8: DVI-DTV  
 4: Component 1                                      9: DVI-PC

Acknowledgement

[b][ ][Set ID][ ][OK][Data][x]

**03. Aspect Ratio (Command2:c) (Main picture format)**

G To adjust the screen format.

You can also adjust the screen format using the RATIO button on remote control or in the Option menu.

Transmission

[k][c][ ][Set ID][ ][Data][Cr]

Data 0: Auto (Set by program)    5: Zoom 2  
 1: Normal screen (4:3)            6: Cinema Zoom (1)  
 2: Wide screen (16:9)            :  
 3: Horizon                            :  
 4: Zoom 1                            15: Cinema Zoom (16)

Acknowledgement

[c][ ][Set ID][ ][OK][Data][x]

**04. Screen Mute (Command2:d)**

G To select screen mute on/off.

Transmission

[k][d][ ][Set ID][ ][Data][Cr]

Data 0 : Screen mute off (Picture on)  
 1 : Screen mute on (Picture off)

Acknowledgement

[d][ ][Set ID][ ][OK][Data][x]

**05. Volume Mute (Command2:e)**

G To control volume mute on/off.

You can also adjust mute using the MUTE button on remote control.

Transmission

[k][e][ ][Set ID][ ][Data][Cr]

Data 0 : Volume mute off (Volume on)  
 1 : Volume mute on (Volume off)

Acknowledgement

[e][ ][Set ID][ ][OK][Data][x]

**06. Volume Control (Command2:f)**

G To adjust volume.

You can also adjust volume with the volume buttons on remote control.

Transmission

[k][f][ ][Set ID][ ][Data][Cr]

Data Min : 0 ~ Max : 64

- Refer to 'Real data mapping' as shown below.

Acknowledgement

[f][ ][Set ID][ ][OK][Data][x]

**07. Contrast (Command2:g)**

G To adjust screen contrast.

You can also adjust contrast in the Video menu.

Transmission

[k][g][ ][Set ID][ ][Data][Cr]

Data Min : 0 ~ Max : 64

- Refer to 'Real data mapping' as shown below.

Acknowledgement

[g][ ][Set ID][ ][OK][Data][x]

**08. Brightness (Command2:h)**

G To adjust screen brightness.

You can also adjust brightness in the Video menu.

Transmission

[k][h][ ][Set ID][ ][Data][Cr]

Data Min : 0 ~ Max : 64

- Refer to 'Real data mapping' as shown below.

Acknowledgement

[h][ ][Set ID][ ][OK][Data][x]

**\* Real data mapping**

0 : Step 0  
 :  
 A : Step 10 (SET ID 10)  
 :  
 F : Step 15 (SET ID 15)  
 10 : Step 16 (SET ID 16)  
 :  
 64 : Step 100

**09. Color (Command2:i)**

G To adjust the screen color.  
You can also adjust color in the Video menu.

Transmission

[k][i][ ][Set ID][ ][Data][Cr]

Data Min : 0 ~ Max : 64

- Refer to 'Real data mapping'. See page 37.

Acknowledgement

[i][ ][Set ID][ ][OK][Data][x]

**10. Tint (Command2:j)**

G To adjust the screen tint.  
You can also adjust tint in the Video menu.

Transmission

[k][j][ ][Set ID][ ][Data][Cr]

Data Red : 0 ~ Green : 64

- Refer to 'Real data mapping'. See page 37.

Acknowledgement

[j][ ][Set ID][ ][OK][Data][x]

**11. Sharpness (Command2:k)**

G To adjust the screen sharpness.  
You can also adjust sharpness in the Video menu.

Transmission

[k][k][ ][Set ID][ ][Data][Cr]

Data Min: 0 ~ Max: 64

- Refer to 'Real data mapping'. See page 37.

Acknowledgement

[k][ ][Set ID][ ][OK][Data][x]

**12. OSD Select (Command2:l)**

G To select OSD (On Screen Display) on/off.

Transmission

[k][l][ ][Set ID][ ][Data][Cr]

Data 0: OSD off 1: OSD on

Acknowledgement

[l][ ][Set ID][ ][OK][Data][x]

**13. Remote Control Lock Mode (Command2:m)**

G To lock the remote control and the front panel controls on the set.

Transmission

[k][m][ ][Set ID][ ][Data][Cr]

Data 0: Lock off 1: Lock on

Acknowledgement

[m][ ][Set ID][ ][OK][Data][x]

**14. PIP / POP / Twin Picture (Command2:n)**

G To control the PIP (Picture-in-Picture)/POP/Twin picture.  
You can also control the PIP/POP/Twin picture using the PIP button on the remote control.

Transmission

[k][n][ ][Set ID][ ][Data][Cr]

Data 0: PIP off 2: POP  
1: PIP 3: Twin PictureAcknowledgement

[n][ ][Set ID][ ][OK][Data][x]

**15. PIP Position (Command2:q)**

G To select sub picture position for PIP.

Transmission

[k][q][ ][Set ID][ ][Data][Cr]

Data 0: Right down on screen  
1: Right up on screen  
2: Left up on screen  
3: Left down on screenAcknowledgement

[q][ ][Set ID][ ][OK][Data][x]

**16. Treble (Command2:r)**

G To adjust treble.  
You can also adjust treble in the Audio menu.

Transmission

[k][r][ ][Set ID][ ][Data][Cr]

Data Min: 0 ~ Max: 64

- Refer to 'Real data mapping'. See page 37.

Acknowledgement

[r][ ][Set ID][ ][OK][Data][x]

**17. Bass (Command2:s)**

G To adjust bass.  
You can also adjust bass in the Audio menu.

Transmission

[k][s][ ][Set ID][ ][Data][Cr]

Data Min: 0 ~ Max: 64

- Refer to 'Real data mapping'. See page 37.

Acknowledgement

[s][ ][Set ID][ ][OK][Data][x]

**18. Balance (Command2:t)**

G To adjust balance.  
You can also adjust balance in the Audio menu.

Transmission

[k][t][ ][Set ID][ ][Data][Cr]

Data Min: 0 ~ Max: 64

- Refer to 'Real data mapping'. See page 37.

Acknowledgement

[t][ ][Set ID][ ][OK][Data][x]

**19. Color Temperature (Command2:u)**

G To adjust color temperature.  
You can also adjust color temperature in the Video menu.

Transmission

[k][u][ ][Set ID][ ][Data][Cr]

Data 0: Warm 1: Medium 2: Cool

Acknowledgement

[u][ ][Set ID][ ][OK][Data][x]

**20. PIP Input Select (Command2:y)**

G To select input source for sub picture in PIP/Twin picture mode.

Transmission

[k][y][ ][Set ID][ ][Data][Cr]

Data 0: DTV  
1: Analog  
2: Video 1  
3: Video 2

Acknowledgement

[y][ ][Set ID][ ][OK][Data][x]

**21. ISM Method (Command2:p)**

G To avoid having a fixed image remain on screen.

Transmission

[j][p][ ][Set ID][ ][Data][Cr]

Data 0: Normal  
1: Orbiter  
2: Inversion

Acknowledgement

[p][ ][Set ID][ ][OK][Data][x]

**22. White Wash (Command2:q)**

G To control the white wash function on/off.  
You can also adjust white wash in Option menu.

Transmission

[j][q][ ][Set ID][ ][Data][Cr]

Data 0: White Wash off  
1: White Wash on

Acknowledgement

[q][ ][Set ID][ ][OK][Data][x]

**23. Orbiter Time Setting (Command2:r)**

G To adjust orbiter operation time term.

Transmission

[j][r][ ][Set ID][ ][Data][Cr]

Data Min: 1 ~ Max: 64

• Refer to 'Real data mapping'. See page 37.

Acknowledgement

[r][ ][Set ID][ ][OK][Data][x]

**24. Orbiter Pixel Setting (Command2:s)**

G To adjust pixel number in orbiter function.

Transmission

[j][s][ ][Set ID][ ][Data][Cr]

Data Min: 0 ~ Max: A

Acknowledgement

[s][ ][Set ID][ ][OK][Data][x]

**25. Channel Tuning (Command: m a)**

G To tune channel to following physical/major/minor number

Transmission

[m][a][ ][Set ID][ ][Data0][ ][Data1][ ][Data2][ ][Data3][Cr]

Data 0: Physical channel number (Transmit by Hexadecimal code)

\* NTSC air: 02 ~ 45  
NTSC cable: 01, 0E ~ 7D  
ATSC air: 01 ~ 45  
ATSC cable: 01 ~ 87

1: Major channel number (Transmit by Hexadecimal code)

\* NTSC air: 02 ~ 45, NTSC cable: 01 ~ 7D  
ATSC air: 01 ~ 63, ATSC cable: 01 ~ 87

2: Minor channel number (Transmit by Hexadecimal code)

\* NTSC air: 00 (must be 0), ATSC: 01 ~ FE

3: High nibble → Main picture: 0, Sub picture (PIP): 1  
Low nibble → NTSC air: 0, NTSC cable: 1, ATSC: 2,

Example) If you want PIP channel tuned to ATSC cable (standard) 30-5, the command sequence is ma 00 1e 1e 05 12.

• Refer to 'Real data mapping'. See page 37.

\* To change the channel between ATSC air and ATSC cable, change the antenna setting with EZ Scan.

Acknowledgement

[a][ ][Set ID][ ][OK][Data0][Data1][Data2][Data3][x]  
[a][ ][Set ID][ ][NG][Data0][x]

**26. Channel Add/Del (Command: m b)**

G To add and delete the channels

Transmission

[m][b][ ][Set ID][ ][Data][Cr]

Data 0: Channel Delete

1: Channel Add

Acknowledgement

[b][ ][Set ID][ ][OK][Data][x]  
[b][ ][Set ID][ ][NG][Data][x]

**27. Key (Command: m c)**

G To send IR remote key code

Transmission

[m][c][ ][Set ID][ ][Data][ ][Cr]

Data Key code: Refer to page 40.

Acknowledgement

[c][ ][Set ID][ ][OK][Data][x]

\* It's impossible to command the IR Code 0x08 and 0xC4 with RS-232C.

# IR Codes

## How to Connect

G Connect your wired remote control to the Remote Control port on the TV.

## Remote Control IR Codes

### G Output waveform

Single pulse, modulated with 37.917KHz signal at 455KHz

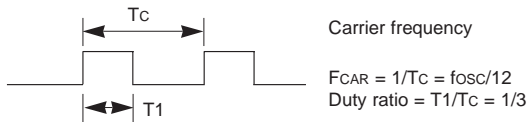

### G Configuration of frame

• 1st frame

Lead code	Low custom code							High custom code							Data code							Data code										
	C0	C1	C2	C3	C4	C5	C6	C7	C0	C1	C2	C3	C4	C5	C6	C7	D0	D1	D2	D3	D4	D5	D6	D7	D0	D1	D2	D3	D4	D5	D6	D7

• Repeat frame

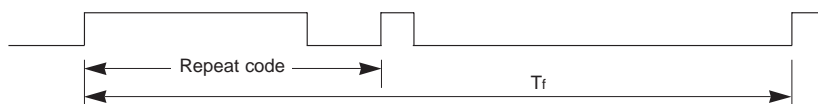

### G Lead code



### G Repeat code

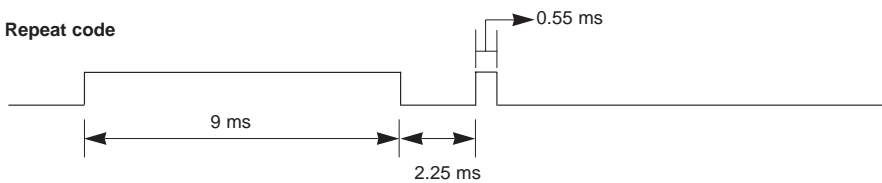

### G Bit description

• Bit "0"

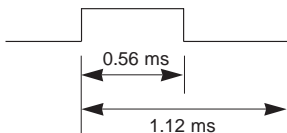

• Bit "1"

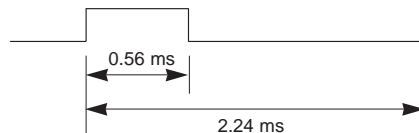

### G Frame interval : Tf

The waveform is transmitted as long as a key is depressed.

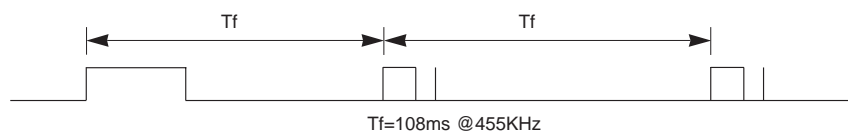



Code (Hexa)	Function	Note
0x0B	TV/VIDEO	R/C Button
	MODE	R/C Button
0x08	POWER	R/C Button (Power On/Off)
0xC4	POWER ON	Discrete IR Code (Only Power On)
0xC5	POWER OFF	Discrete IR Code (Only Power Off)
0x98	COMP/RGB/DVI	R/C Button
0x79	RATIO	R/C Button
0x0E	TIMER	R/C Button
0x10 ~ 0x19	Number Key 0~ 9	R/C Button
0x4C	- (Dash)	R/C Button
0x1A	FLASHBK	R/C Button
0x09	MUTE	R/C Button
0x02	VOL +	R/C Button
0x03	VOL -	R/C Button
0x00	CH +	R/C Button
0x01	CH -	R/C Button
0x1E	SURF	R/C Button
0xAA	INFO	R/C Button
0x39	CC	R/C Button
0x40	D	R/C Button
0x41	E	R/C Button
0x07	F	R/C Button
0x06	G	R/C Button
0x44	OK	R/C Button
0x43	MENU	R/C Button
0x52	SOUND	R/C Button
0x4D	VIDEO	R/C Button
0x5B	EXIT	R/C Button
0x60	PIP	R/C Button
0x72	PIPCH -	R/C Button
0x71	PIPCH +	R/C Button
0x61	PIP INPUT	R/C Button
0x63	SWAP	R/C Button
0x65	FREEZE	R/C Button
0x7B	ZOOM	R/C Button
0x0A	SAP	R/C Button
0xCB	ADJUST	R/C Button
0xD6	TV	Discrete IR Code (TV Input Selection)
0x5A	VIDEO 1	Discrete IR Code (Video1 Input Selection)
0xD0	VIDEO 2	Discrete IR Code (Video2 Input Selection)
0xBF	COMPONENT 1	Discrete IR Code (Component1 Input Selection)
0xD4	COMPONENT 2	Discrete IR Code (Component2 Input Selection)
0xD5	RGB-PC	Discrete IR Code (RGB-PC Input Selection)
0xD7	RGB-DTV	Discrete IR Code (RGB-DTV Input Selection)
0xC6	DVI-DTV	Discrete IR Code (DVI-DTV Input Selection)
0x76	Ratio 4:3	Discrete IR Code (Only 4:3 Mode)
0x77	Ratio 16:9	Discrete IR Code (Only 16:9 Mode)
0xAF	Ratio Zoom	Discrete IR Code (Only Zoom Mode)
0x70	MULTI PIP	Channel Search
0x96	SIGNAL	R/C Button

# Programming the Remote

G The remote control is a multi-brand or universal remote control. It can be programmed to operate most remote-controllable devices of other manufacturers.

Note that the remote control may not control all models of other brands.

## Programming a code into a remote mode

1. Test your remote control.

To find out whether your remote control can operate the component without programming, turn on the component such as a VCR and press the corresponding **MODE** button (VCR) on the remote control, while pointing at the component. Test the **POWER** and **CH +/-** buttons to see if the component responds properly. If not, the remote requires programming to operate the device.

2. Turn on the component to be programmed, then press the corresponding **MODE** button on the remote control.

3. Press the **MENU** and **MUTE** buttons simultaneously, the remote control is ready to be programmed for the code.

4. There are two ways to find the right code for the component.

A. If you press the **CH +/-** buttons repeatedly, the codes will change one at-a-time. Press the **POWER** button after each code change. If the right code is found, the device will turn off.

B. Enter a code number using the number buttons on the remote. Programming code numbers for the corresponding component can be found on the following pages. Again, if the code is correct, the device will turn off.

5. Press the **MENU** button to store the code.

6. Test the remote control functions to see if the component responds properly. If not, repeat from step 2.

# Programming Codes

## VCRs

Brand	Codes	Brand	Codes	Brand	Codes	Brand	Codes	
AIWA	034	KENWOOD	014 034 039 043	PORTLAND	108	TATUNG	039 043	
AKAI	016 043 046 124 125 146	LG (GOLDSTAR)	001 012 013 020 101 106 114 123	PULSAR	072	TEAC	034 039 043	
AMPRO	072	LLOYD	034	QUARTZ	011 014	TECHNICS	031 033 070	
ANAM	031 033 103	LXI	003 009 013 014 017 034 101 106	QUASAR	033 066 075 145	TEKNIKA	019 031 033 034 101	
AUDIO DYNAMICS	012 023 039 043	MAGIN	040	RCA	013 020 033 034 040 041 062 063 107 109 140 144 145 147	THOMAS	034	
BROKSONIC	035 037 129	MAGNAVOX	031 033 034 041 067 068	REALISTIC	003 008 010 014 031 033 034 040 053 054 101	TMK	006	
CANON	028 031 033	MARANTZ	012 031 033 067 069	RICO	058	TOSHIBA	008 013 042 047 059 082 112 131	
CAPEHART	108	MARTA	101	RUNCO	148	TOTEVISION	040 101	
CRAIG	003 040 135	MATSUI	027 030	SALORA	014	UNITECH	040	
CURTIS MATHES	031 033 041	MEI	031 033	SAMSUNG	032 040 102 104 105 107 109 112 113 115 120 122 125	VECTOR RESEARCH	012	
DAEWOO	005 007 010 064 065 108 110 111 112 116 117 119	MEMOREX	003 010 014 031 033 034 053 072 101 102 134 139	SANSUI	022 043 048 135	VICTOR	048	
DAYTRON	108	MGA	045 046 059	SANYO	003 007 010 014 102 134	VIDEO CONCEPTS	012 034 046	
DBX	012 023 039 043	MINOLTA	013 020	SCOTT	017 037 112 129 131	VIDEOSONIC	040	
DYNATECH	034 053	MITSUBISHI	013 020 045 046 049 051 059 061 151	SEARS	003 00 009 013 014 017 020 031 042 073 081 101	WARDS	003 013 017 024 031 033 034 040 053 054 131	
ELECTROHOME	059	MTC	034 040	010	SHARP	031 054 149	YAMAHA	012 034 039 043
EMERSON	006 017 025 027 029 031 034 035 036 037 046 101 129 131 138 153	MULTITECH	024 034	SHINTOM	024	ZENITH	034 048 056 058 072 080 101	
FISHER	003 008 009 010	NEC	012 023 039 043 048	SONY	003 009 031 052 056 057 058 076 077 078 149			
FUNAI	034	NORDMENDE	043	SOUNDDESIGN	034			
GE	031 033 063 072 107 109 144 147	OPTONICA	053 054	STS	013			
GO VIDEO	132 136	PANASONIC	066 070 074 083 133 140 145	SYLVANIA	031 033 034 059 067			
HARMAN KARDON	012 045	PENTAX	013 020 031 033 063		067			
HITACHI	004 018 026 034 043 063 137 150	PHILCO	031 034 067	SYMPHONIC	034			
INSTANTREPLAY	031 033	PHILIPS	031 033 034 054 067 071 101	TANDY	010 034			
JCL	031 033	PILOT	101					
JCPENNY	012 013 015 033 040 066 101	PIONEER	013 021 048					
JENSEN	043							
JVC	012 031 033 043 048 050 055 060 130 150 152							

## CATV

Brand	Codes	Brand	Codes	Brand	Codes	Brand	Codes
ABC	003 004 039 042 046 052 053	GOLDEN CHANNEL	030	PIONEER	065 085 090 034 051 052 063	SL MARX	030
AJIN	112	HAMLIN	049 050 055	076	STARCOM	002 004 008 009	
ANTRONIK	014	HITACHI	052 055	POST NEWS WEEK	016	STARGATE	008 030
ARCHER	005 007 014 024	HOSPITALITY	070 077	PRUCER	059	SYLVANIA	067
CABLE STAR	026	JERROLD	002 003 004 008 009 010 052 069 074	PTS	011 048 071 072 073 074	TADIRAN	030
CENTURION	092	LG (GOLDSTAR)	001 106 101 005	PULSAR	100	TAEKWANG	110
CENTURY	007	M-NET	037	RCA	047	TAIHAN	105
CITIZEN	007	MACOM	033	REGAL	049 050	TANDY	017
COLOUR VOICE	065 090	MAGNAVOX	010 012 064 079	REGENCY	057	TEXSCAN	029 067
COMBANO	080 081	MEMOREX	100	REMBRANT	025	TOCOM	039 040 056
COMTRONICS	019 030	MOVIE TIME	028 032	RK	091	TOSHIBA	100
DIAMOND	023	NSC	015 028 038 071 073	SAMSUNG	102 107 030 068 003 011 041 042 043 045 046	UNIKA	007 014 024
EAGLE	020 030 040	OAK	016 031 037 053	SCIENTIFIC ATLANTA	022	UNITED CABLE	004 053
EASTERN	057 062 066	PANASONIC	044 047	SHERITECH	022	UNIVERSAL	005 007 014 024 026 027 032 035
ELECTRICORD	032	PARAGON	100	SIGNAL	030	VIEWSTAR	012 015 018 086 087 088 089
GE	072	PHILIPS	006 012 013 020	SIGNATURE	052	ZENITH	100 114 060 093
GEMINI	008 022 025 054						
GI	052 074						

HDSTB

Brand	Codes	Brand	Codes	Brand	Codes	Brand	Codes
ALPHASTAR DSR	123	EUROPLUS	114	MEMOREX	057	STARCAST	041
AMPLICA	050	FUJITSU	017 021 022 027	NEXTWAVE	028 124 125	SUPER GUIDE	020 124 125
BIRDVIEW	051 126 129		133 134	NORSAT	069 070	TEECOM	023 026 075 087
BSR	053	GENERAL INSTRUMENT	003 004 016 029	PACE SKY SATELLITE	143		088 090 107 130
CAPETRONICS	053		031 059 101	PANASONIC	060 142		137
CHANNEL MASTER	013 014 015 018	HITACHI	139 140	PANSAT	121	TOSHIBA	002 127
	036 055	HOUSTON TRACKER	033 037 039 051	PERSONAL CABLE	117	UNIDEN	016 025 042 043
CHAPARRAL	008 009 012 077		057 104	PHILIPS	071		044 045 048 049
CITOH	054	HUGHES	068	PICO	105		078 079 080 086
CURTIS MATHES	050 145	HYTEK	053	PRESIDENT	019 102		101
DRAKE	005 006 007 010	JANIEL	060 147	PRIMESTAR	030 110 111	UNIDEN	135 136
	011 052 112 116	JERROLD	061	PROSAT	072	VIEWSTAR	115
	141	KATHREIN	108	RCA	066 106	WINEGARD	128 146
DX ANTENNA	024 046 056 076	LEGEND	057	REALISTIC	043 074	ZENITH	081 082 083 084
ECHOSTAR	038 040 057 058	LG	001	SAMSUNG	123		091 120
	093 094 095 096	LUTRON	132	SATELLITE SERVICE CO	028 035 047 057		
	097 098 099 100	LUXOR	062 144		085		
	122	MACOM	010 059 063 064	SCIENTIFIC ATLANTA	032 138		
ELECTRO HOME	089		065	SONY	103		

Audio

Brand	Codes	Brand	Codes	Brand	Codes	Brand	Codes
AIWA	014 028 070 096	JVC	004 013 141	PHILIPS	026 112 143 253		147 218
	125 129 139 229	KEC	185 186 187	PIONEER	039 042 043 063	TOSHIBA	137
	230	KENWOOD	038 050 067 089		065 091 093 094	THE	061
AKAI	163		170 171 197 206		115 123 127 250	VICTOR	088 131
ANAM	003 014 017 023		215 222	QUASAR	113	WARDS	089
	059 106 189 216	KOHEL	030	RCA	080	YAMAHA	054 055 066 092
	217 235 236	NAD	045 046	RCX	092		199
BURMECTER	252	LOTTE	014 016 036 098	REALISTIC	103 106		
CARVER	086		100 172 173 174	SAMSUNG	124 145 146 182		
CLARION	199		175 176 177 178		193 194 195 203		
DAEWOO	027 053 060 084		179 180 181 183		204 244 245 246		
	102 148 198 221		201 202 208 213	SANSUI	011 135 138 144		
DENON	015 075 130 143		214 219 223 232	SANYO	019 083 234		
FANTASIA	071		238 240	SCOTT	106 186		
FINEARTS	022	LXI	103	SHARP	031 032 051 052		
FISHER	089 099	MAGNAVOX	111		072 082 117 119		
LG(GOLDSTAR)	001 021 024 029	MARANTZ	002 018 020 025		156 184 199 200		
	087 107 108 110		034 041 081 090		206 209		
	190 191 192 210		097 112	SHERWOOD	005 006 158		
	211 212 239	MCINTOSH	049	SONY	044 045 109 114		
HAITAI	034 035 188 222	MCS	104		118 126 248 249		
HARMAN/KARDON	068	MEMOREX	107	TAEKWANG	012 020 073 074		
INKEL	037 058 062 069	NAD	046		076 077 105 161		
	078 079 095 121	ONKYO	013 040 041 047		162 163 164 165		
	122 149 150 151		048 056 057 132		166 167 168 169		
	152 153 154 155		133 140		205 231 233 242		
	157 158 159 160	OPTIMUS	158		254		
	189 207 222 224	PANASONIC	007 033 064 113	TEAC	010 085 106 136		
	225 226 227 243		142 220 241 251		185 187 237		
	247	PENNEY	104	TECHNICS	101 113 128 134		

DVD

Brand	Codes	Brand	Codes	Brand	Codes	Brand	Codes
APEX DIGITAL	022	MAGNAVOX	013	PHILIPS	013	SONY	007
DENON	020 014	MARANTZ	024	PIONEER	004 026	THOMPSON	005 006
GE	005 006	MITSUBISHI	002	PROCEED	021	TOSHIBA	019 008
HARMAN KARDON	027	NAD	023	PROSCAN	005 006	YAMAHA	009 018
JVC	012	ONKYO	008 017	RCA	005 006	ZENITH	010 016 025
LG	001 010 016 025	PANASONIC	003 009	SAMSUNG	011 015		

# Troubleshooting Checklist

## No picture & No sound

- Check whether the TV is turned on.
- Is the power cord inserted into wall power outlet?
- Test the wall power outlet, plug another product's power cord into the outlet where the TV's power cord was plugged in.

## Picture OK & No sound

- Press the **VOLUME** (G) button.
- Sound muted? Press **MUTE** button.

## The remote control doesn't work

- Check to see if there is any object between the TV and the remote control causing obstruction.
- Are batteries installed with correct polarity (+ to +, - to -)? (Refer to p.9)
- Correct remote operating mode set: TV, VCR etc.?
- Install new batteries. (Refer to p.9)

## Picture appears slowly after switching on

- This is normal, the image is muted during the TV startup process. Please contact your service center, if the picture has not appeared after five minutes.

## No or poor color or poor picture

- Select **Color** in the **Video** menu and press the **VOLUME** (G) button. (Refer to p.21)
- Keep a sufficient distance between the TV and the VCR.
- Activate any function to restore the brightness of the picture. (If still picture is on the screen for more than 5 minutes, the screen gets dark.)

## Horizontal/vertical bars or picture shaking

- Check for local interference such as an electrical appliance or power tool.

## No output from one of the speakers

- Adjust **Balance** in the **AUDIO** menu. (Refer to p.23)

## Unusual sound from inside the TV

- A change in ambient humidity or temperature may result in an unusual noise when the plasma display is turned on or off and does not indicate a fault with the TV.

# Maintenance

- Early malfunctions can be prevented. Careful and regular cleaning can extend the amount of time you will have your new TV. Be sure to turn the power off and unplug the power cord before you begin any cleaning.

## Cleaning the Screen

1. Here's a great way to keep the dust off your screen for a while. Wet a soft cloth in a mixture of lukewarm water and a little fabric softener or dish washing detergent. Wring the cloth until it's almost dry, and then use it to wipe the screen.
2. Make sure the excess water is off the screen, and then let it air-dry before you turn on your TV.

## Cleaning the Cabinet

To remove dirt or dust, wipe the cabinet with a soft, dry, lint-free cloth. Please be sure not to use a wet cloth.

## Extended Absence



If you expect to leave your TV dormant for a long time (such as a vacation), it's a good idea to unplug the power cord to protect against possible damage from lightning or power surges.

# Product Specifications

MODEL	DU-42PX12X/12XC	DU-50PX10/10C
Width (inches / mm)	41 / 1210	48.3 / 1400
Height (inches / mm)	27.5 / 701	30.6 / 821
Depth (inches / mm)	3.7 / 96	3.9 / 99
Weight (pounds / kg)	76.1 / 34.6	98.1 / 52.2
Power requirement	AC100-240V ~ 60Hz	
Television System	NTSC-M, ATSC	
Program Coverage	VHF 2 ~ 13, UHF 14 ~ 69, CATV 1 ~ 125, CADTV 1 ~ 135. DTV 2 ~ 69	
External Antenna Impedance	75 Ω	
Resolution	1024 x 768 (Dot)	1366 x 768 (Dot)
Color	16,770,000 (256 steps of each R, G and B)	
Operating Temperature Range	32 ~ 104°F (0 ~ 40°C)	
Operating Humidity Range	Less than 80%	
Maximum Elevation	6561 feet (2000m)	

- The specifications shown above may be changed without prior notice for quality improvement.



LG ELECTRONICS, INC.  
PLASMA TV — U.S. LIMITED WARRANTY

Your LG Plasma TV will be repaired or replaced in accordance with the terms of this warranty, at LGE's option, if it proves to be defective in material or workmanship under normal use, during the warranty period ("Warranty Period") listed below, effective from the date ("Date of Purchase") of original consumer purchase of the product. This warranty is good only to the original purchaser of the product and effective only when used in the United States, including Alaska, Hawaii, and U.S. Territories.

**WARRANTY PERIOD:**

**LABOR and PARTS: 2 YEARS** from the Date of Purchase. Your unit will be repaired or replaced with a new, substitute model or factory reconditioned unit, at LGE's option. If repaired, parts used in the repair may be new or remanufactured.

Replacement Units and Repair Parts are warranted for the remaining portion of the original unit's warranty period.

**EFFECTIVE DATE OF WARRANTY:** Your warranty period begins on the date of sale to the original consumer/end user. KEEP THE DEALER'S DATED BILL OF SALE OR PROOF OF DELIVERY as evidence of the purchase date. You will be required to submit a legible copy of your bill of sale or proof of delivery when requesting warranty service.

**HOW SERVICE IS HANDLED:**

**In-Home Service:** Please retain dealer's dated bill of sale or delivery ticket as evidence of the Date of Purchase for proof of warranty, and submit a copy of the bill of sale to the service person at the time warranty service is provided.

**Please call 1-201-816-2000 to locate your nearest LGE Authorized Service Center.**

Visit our website at:  
<http://www.lgservice.com>

**THIS WARRANTY IS IN LIEU OF ANY OTHER WARRANTY, EXPRESS OR IMPLIED, INCLUDING WITHOUT LIMITATION, ANY WARRANTY OF MERCHANTABILITY OR FITNESS FOR A PARTICULAR PURPOSE. TO THE EXTENT ANY IMPLIED WARRANTY IS REQUIRED BY LAW, IT IS LIMITED IN DURATION TO THE EXPRESS WARRANTY PERIOD ABOVE. NEITHER THE MANUFACTURER NOR ITS U.S. DISTRIBUTOR SHALL BE LIABLE FOR ANY INCIDENTAL, CONSEQUENTIAL, INDIRECT, SPECIAL, OR PUNITIVE DAMAGES OF ANY NATURE, INCLUDING WITHOUT LIMITATION, LOST PROFITS, LOST OR CORRUPTED PROGRAMMING OR DATA, OR ANY OTHER DAMAGE WHETHER BASED IN CONTRACT, TORT, OR OTHERWISE.** Some states do not allow the exclusion or limitation of incidental or consequential damages or limitations on how long an implied warranty lasts, so the above exclusion or limitation may not apply to you. This warranty gives you specific legal rights and you may also have other rights that vary from state to state.

**CONCERNING PIXEL FUNCTIONALITY:** Your Plasma TV contains about one million individual pixels. Plasma TV typically contain a small number of pixels that do not function normally. Your display has been inspected and is in compliance with manufacturer's specifications, indicating that any pixel defects do not effect the operation or use of your display.

**IMPORTANT:** Please fill out and mail in your Product Registration Card or go to [www.lgservice.com](http://www.lgservice.com) to register your product online. This information will allow us to reach you promptly should we discover a safety or reliability problem that could affect you.

**THIS LIMITED WARRANTY DOES NOT APPLY TO:**

<ul style="list-style-type: none"><li>● damage caused in shipping or transit</li><li>● service required as a result of improper installation, including incorrect or insufficient AC supply (please consult the owner's manual for power supply requirements)</li><li>● installation or repair of antenna systems, cable converters, cable company supplied equipment, or other components in a video system</li><li>● set-up or adjustment on consumer controls, or damage caused by improper adjustments</li><li>● damage caused by other system components</li><li>● any panel that has been modified or incorporated into any other product</li><li>● replacement of batteries on the remote control.</li><li>● damage (including cosmetic damage), failure, loss or personal injury due to misuse, abuse, negli-</li></ul>	<p>gence, improper maintenance or storage, or to acts of nature or other causes beyond our control. (Causes beyond our control include but are not limited to lightning strike, power surges, power outages and water damage.)</p> <ul style="list-style-type: none"><li>● image burn-in</li><li>● repair or replacement of warranted parts by other than LGE authorized service centers.</li><li>● units purchased or serviced outside of the coverage area.</li><li>● product where the original factory serial numbers have been removed, defaced or changed in any way.</li><li>● product sold and labeled as "as is, where is" or similar disclaimer.</li></ul>
---	--

The cost of repair or replacement under these excluded circumstances shall be borne by the consumer.

**CUSTOMER INTERACTIVE CENTER NUMBERS:**

To obtain customer assistance, product information or Dealer or Service locations	Call <b>1-201-816-2000</b> 24 hours a day, 365 days per year
---	---

**FOR SERVICE:**

**Before you call for warranty service, check your operating guide – you may avoid a service call.**

For warranty service information, please contact the LGE Customer Interactive Center telephone number.

When calling for service, **please have your product model number, serial number and the date of purchase or the date of original installation available.**

If a replacement unit is required, under some circumstances you may be asked to provide a reserve deposit to the LGE Service Center against a credit card number as surety for advanced shipment. Your credit card will not be charged if you return the defective unit within 10 working days.

If a replacement unit is received, please use the carton and packaging from that unit in returning the defective unit to the LG®Brand Service Center.

Parts and service in accordance with the LGE warranty are LGE's responsibility and will be provided without charge. Other service requirements will be at the owner's expense. If you have problems in obtaining satisfactory warranty service, write or call the LGE Customer Interactive Center. Service may be provided by independently owned and operated service organizations.

To assure proper credit and avoid unnecessary charges, you must obtain an LGE Return Authorization before returning any product to the LGE Service Center. Contact the Customer Interactive Center for details.

**TO CONTACT THE LGE CUSTOMER SERVICE CENTER BY MAIL:**

LGE Customer Interactive Center  
P.O. Box 240007  
201 James Record Road  
Huntsville, Alabama 35824  
<http://www.lgservice.com>

P/NO : 3828VA0479D©