

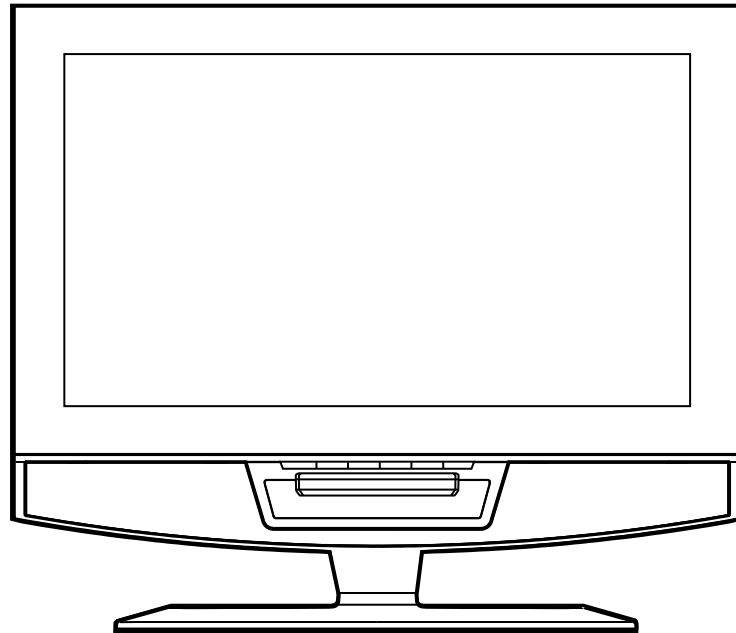

FPE3207DV

32" HD FLAT PANEL LCD TV WITH BUILT-IN DVD PLAYER



OWNER'S MANUAL



FOR ASSISTANCE CALL CUSTOMER SERVICE AT 1-800-645-4994
OR VISIT US AT WWW.AUDIOVOX.COM

128-8138

PLV31320CS10 / AUDIOVOX
I/B 811-313291W030 <English>
SIZE : 148 X 210MM
MATERIAL : 80g WOODSFREE PAPER

Printed in China
811-313291W020

SAFETY PRECAUTIONS





CAUTION
RISK OF ELECTRIC SHOCK
DO NOT OPEN



DO NOT EXPOSE THIS UNIT TO RAIN OR MOISTURE
AVIS RISQUE DE CHOC ÉLECTRIQUE — NE PAS OUVRIR

WARNING : TO REDUCE THE RISK OF ELECTRIC SHOCK, DO NOT REMOVE COVER (OR BACK). NO USER SERVICEABLE PARTS INSIDE. REFER SERVICING TO QUALIFIED SERVICE PERSONNEL.

 The lightning flash with arrowhead symbol, within an equilateral triangle, is intended to alert the user to the presence of uninsulated “dangerous voltage” within the product’s enclosure that may be of sufficient magnitude to constitute a risk of electric shock to persons.

 The exclamation point within an equilateral triangle is intended to alert the user to the presence of important operating and maintenance (servicing) instructions in the literature accompanying the appliance.



This product contains a low power laser device.

CLASS 1 LASER PRODUCT
APPAREIL À LASER DE CLASSE 1

CAUTION
INVISIBLE LASER RADIATION WHEN UNIT IS OPENED AND INTERLOCKS ARE DEFECTED.
AVOID EXPOSURE TO LASER BEAM.



The symbol for Class II (Double Insulation)

CAUTION

- DANGER OF EXPLOSION IF BATTERY IS INCORRECTLY REPLACED. REPLACE ONLY WITH THE SAME OR EQUIVALENT TYPE.
- **TO PREVENT ELECTRIC SHOCK, MATCH WIDE BLADE OF PLUG TO WIDE SLOT OF WALL OUTLET, THEN FULLY INSERT.**
- USE OF CONTROLS OR ADJUSTMENTS OR PERFORMANCE OF PROCEDURES OTHER THAN THOSE SPECIFIED MAY RESULT IN HAZARDOUS RADIATION EXPOSURE.



WARNING :

- TO PREVENT FIRE OR SHOCK HAZARD, DO NOT EXPOSE THIS UNIT TO RAIN OR MOISTURE. DO NOT PLACE OBJECTS FILLED WITH LIQUIDS ON OR NEAR THIS UNIT.
- SHOULD ANY TROUBLE OCCUR, DISCONNECT THE AC POWER CORD AND REFER SERVICING TO A QUALIFIED TECHNICIAN.

PLACEMENT INFORMATION

- Do not use this unit in places that are extremely hot, cold, dusty or humid.
- Do not restrict the airflow of this unit by placing it somewhere with poor air flow, by covering it with a cloth, by placing it on bedding or carpeting.

SAFETY INFORMATION

- When connecting or disconnecting the AC power cord, grip the plug and not the cord itself. Pulling the cord may damage it and create a hazard.
- When you are not going to use the unit for a long period of time, disconnect the AC power cord.

CONDENSATION INFORMATION

- When left in a heated room where it is warm and damp, water droplets or condensation may form inside the equipment. When there is condensation inside the unit, the unit may not function normally. Let the unit stand for 1-2 hours before turning the power on or gradually heat the room and let the unit dry before use.

RATING PLATE LOCATION

The rating plate is located on the rear of unit.

FCC STATEMENTS

NOTE: This unit has been tested and found to comply with the limits for a Class B digital device, pursuant to Part 15 of the FCC Rules. These limits are designed to provide reasonable protection against harmful interference in a residential installation. This unit generates, uses and can radiate radio frequency energy and, if not installed and used in accordance with the instructions, may cause harmful interference to radio communication. However, there is not guarantee that interference will not occur in a particular installation. If this unit does cause harmful interference to radio or television reception, which can be determined by turning the unit off and on, the user is encouraged to try to correct the interference by one or more of the following measures:

- Reorient or relocate the receiving antenna.
- Increase the separation between the unit and receiver.
- Connect the unit into a wall outlet on a circuit different from that to which the receiver is connected.
- Consult the dealer or an experienced radio/TV technician for help.



WARNING: Changes or modifications to this unit not expressly approved by party responsible for compliance could void the user authority to operate the unit.

IMPORTANT SAFETY INSTRUCTIONS

- 1) Read these instructions.
- 2) Keep these instructions.
- 3) Heed all warnings.
- 4) Follow all instructions.
- 5) Do not use this apparatus near water.
- 6) Clean only with a dry cloth.
- 7) Do not block any ventilation openings. Install in accordance with the manufacturer's instructions.
- 8) Do not install near any heat sources such as radiators, heat registers, stoves, or other apparatus (including amplifiers) that produce heat.
- 9) Do not defect the safety purpose of the polarized or grounding-type plug. A polarized plug has two blades with one wider than the other. A grounding type plug has two blades and a third grounding prong. The wide blade or the third prong is provided for your safety. If the provided plug does not fit into your wall outlet, consult an electrician for replacement of the obsolete outlet.
- 10) Protect the power cord from being walked on or pinched particularly at plugs, convenience receptacles, and the point where they exit from the apparatus.
- 11) Only use attachments / accessories specified by the manufacturer.
- 12) Use only with the cart, stand, tripod, bracket, or table specified by the manufacturer, or sold with the apparatus. When a cart is used, use caution when moving the cart / apparatus combination to avoid injury from tip-over. 
- 13) Unplug this apparatus during lightning storms or when unused for long periods of time.
- 14) Refer all servicing to qualified service personnel. Servicing is required when the apparatus has been damaged in any way, such as the power cord or plug is damaged, liquid has been spilled or objects have fallen into the apparatus, the apparatus has been exposed to rain or moisture, does not operate normally, or has been dropped.

MAINTENANCE

CLEANING THE DISC

A defective or dirty disc inserted into the unit can cause sound to drop out during playback.

Handle the disc by holding its inner and outer edges.

- Do NOT touch the surface of the unlabeled side of the disc.
- Do NOT stick paper or tape on the surface of the disc.
- Do NOT expose the disc to direct sunlight or excessive heat.
- Clean the disc before playback. Wipe the disc from the center outward with a cleaning cloth.
- NEVER use solvents such as benzene or alcohol to clean the disc.
- Do NOT use irregular shaped discs (for example : heart shaped, octagonal, etc.). They may cause malfunctions.



CLEANING THE UNIT

- Be sure to turn the unit off and disconnect the AC power cord before cleaning the unit.
- Wipe the unit with a dry soft cloth. If the surfaces are extremely dirty, wipe clean with a cloth which has been dipped in a weak soap-and-water solution and wrung out thoroughly. Then wipe it with a dry cloth.
- Never use alcohol, benzene, paint-thinner, cleaning fluid or other chemicals. Do NOT use compressed air to remove dust.

IMPORTANT NOTE

Before shipping the unit, remove the disc from the disc compartment.

CONTENTS

SAFETY PRECAUTIONS	1	PLAYING A DISC	23-24
IMPORTANT SAFETY INSTRUCTIONS	2	Playing a Disc	23
MAINTENANCE	2	Playing a Picture File Disc	23
CONTENTS	3	Pausing Playback (Still Mode)	23
DISC FORMATS	4	Stopping Playback	23
ACCESSORIES	5	Skipping to a Different Track	23
GETTING STARTED	5	Fast Forward / Fast Reverse	24
CONTROL REFERENCE GUIDE	6-9	Slow-motion Play (DVD)	24
CONNECTIONS	10-14	Audio Selection (DVD)	24
Connecting a TV Antenna / Cable / Satellite	10	Subtitle Selection (DVD)	24
Connecting an A / V Device	10	Angle Selection (DVD)	24
Connecting Devices with a Composite (Yellow RCA-Type) Video Output	11	SPECIAL FUNCTION	25
Connecting Devices with a Composite (Yellow RCA-Type) Video Input	11	Display	25
Connecting a High-Definition (HD) Source	12	Locating a Specific Title (DVD)	25
Connecting a PC	12	Locating a Specific Chapter / Track	25
Connecting HDMI	13	Locating a Specific Time (DVD)	25
Connecting an Audio Amplifier	13	REPEAT PLAYBACK	26
Connecting the AC Power Cord	14	Repeating a Chapter / Title (DVD)	26
USING HEADPHONES	14	Repeating a Single Track / an Entire Disc (CD)	26
INSTALLATION	15	Repeating a Specific Section (DVD)(CD) ...	26
Removing the Base Stand	15	DVD/CD PROGRAMMABLE PLAYBACK	27
Mounting on the Wall	15	Title / Chapter Programmed Playback (DVD)	27
UNIT OPERATION	16	Track Programmed Playback (CD)	27
SOUND SYSTEM	16	CUSTOMIZING THE FUNCTION SETTINGS	28
TV SETUP	17-22	Language Setup	28
Video Menu	17	Video Setup	28
Audio Menu	18	System Setup	28
TV Menu	19	TROUBLESHOOTING GUIDE	29
Setup Menu	20-21		
Parental Menu	21-22		

DISC FORMATS

NOTES ON COPYRIGHT

It is forbidden by law to copy, broadcast, show, broadcast on cable, play in public or rent copyrighted material without permission.

Apparatus Claims of U.S. Patent Nos. 4,907,093; 5,315,448 and 6,516,132 licensed for limited viewing uses only.

DVDs are copy protected, and any recordings made from these discs will be distorted. This product incorporates copyright protection technology that is protected by method claims of certain U.S. patents and other intellectual property rights owned by Macrovision Corporation and other rights owners. Use of this copyright protection technology must be authorized by Macrovision Corporation, and is intended for home and other limited viewing uses only, unless otherwise authorized by Macrovision Corporation. Reverse engineering or disassembly is prohibited.

The unit can play:



DVDs [8cm/
12cm disc]



Audio CDs
[8cm/12cm disc]

CD-R CD-RW
Compatible

REGION MANAGEMENT INFORMATION

Region Management Information: This unit is designed and manufactured to respond to the Region Management Information that is encoded on DVD. If the region number printed on the DVD does not correspond to the region number of this unit, this unit cannot play that disc.



The region number of this equipment is 1.

DISC FUNCTION OR OPERATION THAT IS NOT AVAILABLE

When the symbol appears on the screen, it indicates that the function or operation attempted is not available at that time. This occurs because the DVD manufacturer determines the specific functions. Certain functions may not be available on some discs. Be sure to read the documentation provided with the DVD.

ICONS USED ON DVDs

Sample Icons:

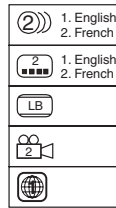

- Language selections for audio
- Language selections for subtitles
- Screen aspect ratio
- Multiple camera angles
- Region code indicator

NOTE

When playing back a CD-G (Graphics) or CD EXTRA disc, the audio portion will be played, but the graphic images will not be shown.

TITLES, CHAPTERS AND TRACKS

- DVDs are divided into "TITLES" and "CHAPTERS". If the disc has more than one movie on it, each movie would be a separate "TITLE". "CHAPTERS" are sections of titles.

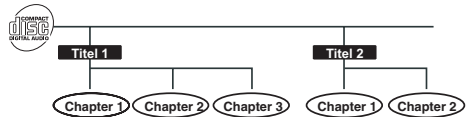

- Audio CDs are divided into "TRACKS". A "TRACK" is usually one song on an Audio CD.



NOTE

Numbers identify each title, chapter and track on a disc. Most discs have these numbers recorded on them, but some do not.

NOTES ON UNAUTHORIZED DISCS

You may not be able to playback some DVDs on this equipment if they were purchased from outside your geographic area or made for business purposes.

ACCESSORIES

Please check and identify the supplied accessories.

- Remote Control (with batteries) x 1

GETTING STARTED

USING THE REMOTE CONTROL

- Point the remote control at the remote sensor located on the unit.
- When there is a strong ambient light source, the performance of the infrared remote sensor may be degraded, causing unreliable operation.
- The recommended effective distance for remote operation is about 16 feet (5 meters).

TO INSTALL BATTERIES

1. Open the battery door.

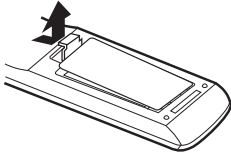

2. Insert 2 “AAA” batteries.

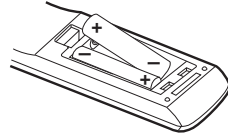

BATTERY REPLACEMENT

When the batteries become weak, the operating distance of the remote control is greatly reduced and you will need to replace the batteries.

CAUTION:

Danger of explosion if battery is incorrectly replaced.

NOTES

- If the remote control is not going to be used for a long time, remove the batteries to avoid damage caused by battery leakage corrosion.
- Do not mix old and new batteries. Do not mix ALKALINE, standard (CARBON-ZINC) or rechargeable (NICKEL-CADMIUM) batteries.
- Always remove batteries as soon as they become weak.
- Weak batteries can leak and severely damage the remote control.

 **WARNING** : Do not dispose of batteries in a fire. Batteries may explode or leak.

Many universal remote controls have a “learning” feature. We recommend you use that feature to program the remote control.

For any questions or problems related to programming a universal remote control, you must contact the customer service department of the universal remote control manufacturer for assistance, or refer to the instructions included with the universal remote control. We cannot offer assistance in programming universal remote controls.

CONTROL REFERENCE GUIDE

REMOTE CONTROL

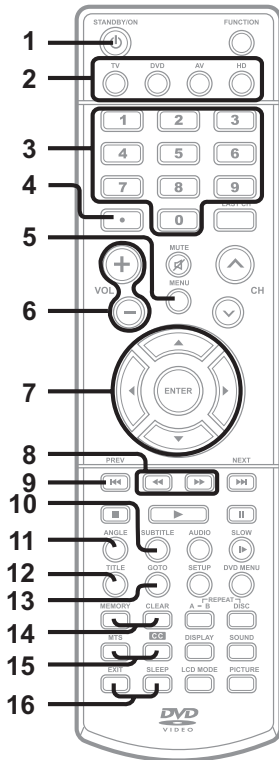

1. **⏻ STANDBY / ON button**
Press to turn ON the unit or put it in STANDBY (OFF) mode.
2. **TV button**
Press to switch to TV mode.
DVD button
Press to switch to DVD mode.
AV button
Press to switch to source connected to AV 1 / AV 2 (composite) inputs.
HD button
Press to switch to source connected to YUV in / HDMI 1 / HDMI 2 (component) inputs.
3. **Number (0 - 9) buttons**
4. **• [dot] button**
Use to enter digital sub-channels (i.e. 11.3 or 12.7)
5. **MENU button**
Press to display the on-screen TV menu.

6. **VOLUME (- / +) buttons**
Press to adjust the volume level.
7. **CURSOR (▲, ▼, ◀, ▶) buttons**
Press to highlight selections on a menu screen and adjust certain settings.
ENTER button
Press to confirm selections on a menu screen.
8. **◀◀ / ▶▶ buttons**
◀◀ : Fast reverse playback.
▶▶ : Fast forward playback.
9. **PREV ◀◀ button**
Press to select previous chapters or tracks on a disc.
10. **SUBTITLE button**
Press to select one of the subtitle languages programmed on a DVD.
11. **ANGLE button**
Press to switch the camera angle of the video presentation when scenes with multiple camera angles are recorded on a DVD.
12. **TITLE button**
Press to show title menu.
13. **GOTO button**
Press to skip directly to a specific location on a DVD/CD.
14. **MEMORY button**
Press to set predetermined playback.
CLEAR button
Press to clear input selections.
15. **MTS button**
Press to select between MONO sound, STEREO sound and Secondary Audio Program (SAP).
CC button
Press to activate the Closed Captioning feature. This function only works on programs broadcasted with captions.
16. **EXIT button**
Press to exit the TV SET UP menu and return directly to normal viewing.
SLEEP button
Press to set the SLEEP timer. The unit will remain on for the time that is set, and will automatically shut off afterwards.

CONTROL REFERENCE GUIDE

REMOTE CONTROL

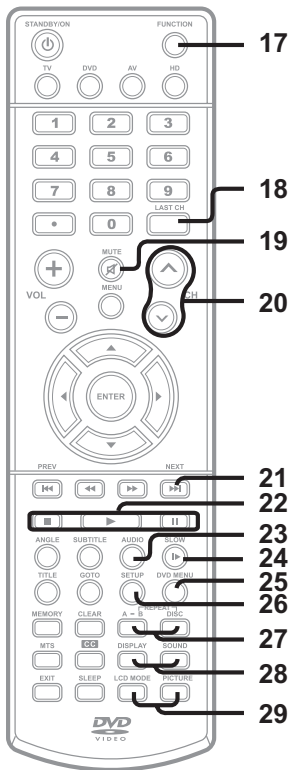

17. FUNCTION button

Press to switch between TV / AV 1 / AV 2 / YUV in / DVD / HDMI 1 / HDMI 2 / PC in.

18. LAST CH button

Press to switch repeatedly between the last two channels displayed.

19. MUTE \times button

Press to turn off the sound.

20. CH \wedge / CH \vee buttons

Press to change the TV channels.

21. NEXT \blacktriangleright button

Press to select the next title, chapter or track on a disc.

22. ■ button

Press to stop playing a disc.

Press to go to a folder list of picture file disc.

▶ PLAY button

Press to start and resume playback of a disc.

⏸ PAUSE button

Press to pause playback and single frame advance.

23. AUDIO button

Press to select audio soundtracks on a DVD or change the output mode of a CD.

24. ▶ SLOW button

Press to perform slow forward playback of a DVD.

25. DVD MENU button

Press to enter the main menu of the DVD.

26. SETUP button

Press to enter and exit the SETUP menu of the DVD.

27. A-B button

Press to perform point-to-point repeat playback on a DVD or CD.

DISC button

Press to repeat a chapter or title of a DVD. Press to repeat a single track or whole CD.

28. DISPLAY button

Press to change disc status information displayed on the screen.

SOUND button

Press to select from preset sound settings to match the type of show you are watching. (Standard / Personal / Theater / Voice / Music)

29. LCD MODE button

Press to set size of LCD display. (WIDE / 4:3 / LCD OFF)

PICTURE button

Press to select from preset screen display settings to match the type of show you are watching. (Personal / Soft / Movie / Standard / Dynamic)

CONTROL REFERENCE GUIDE

FRONT & SIDE VIEWS

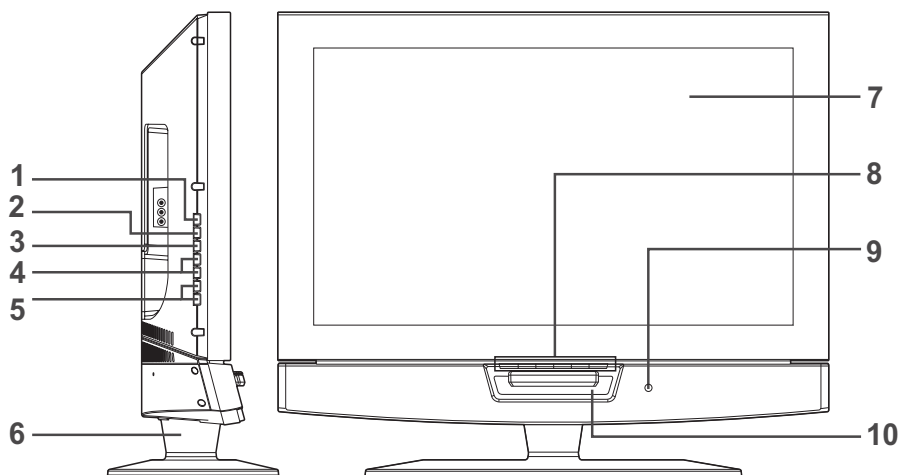

1. STD.BY / ON button

Turns the unit on and off.

2. MENU button

Enters the on-screen TV menu.

3. FUNCTION button

Selects TV / AV 1 / AV 2 / YUV in / DVD / HDMI 1 / HDMI 2 / PC in.

4. ▲ CH ▼ buttons

Confirms selections on the TV menu screen and changes the TV channels.

5. - VOL + controls

Adjusts the volume level.

6. Removable stand

7. Color LCD screen

8. ► PLAY button

Starts and resumes playback of a disc.

■ STOP button

Stops playing a disc.

|| PAUSE button

Pauses playback and single frame advance.

◀◀ PREV button

Press to go back to previous chapters / tracks.

Performs fast reverse playback.

▶▶ NEXT button

Press to advance chapters / tracks.

Press and hold to fast forward playback.

▲ button

Press to open and close the disc door.

9. Remote sensor

Receives the remote control signal.

Standby indicator

10. DVD door

CONTROL REFERENCE GUIDE

REAR VIEW

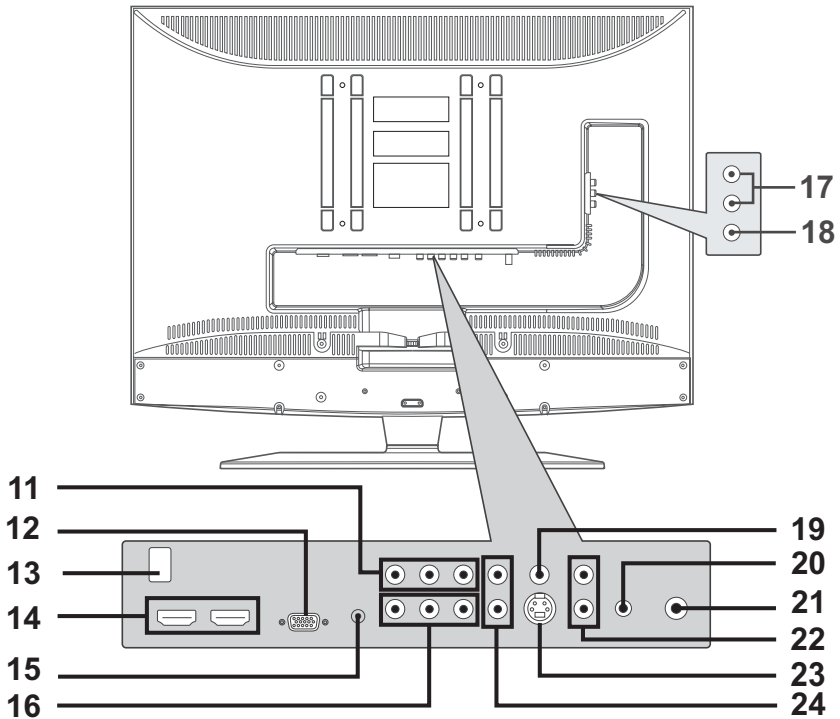

- 11. VIDEO OUT jack (AV OUT)
AUDIO OUT (Left / Right) jacks (AV OUT)
- 12. MONITOR / VGA jack (PC IN)
- 13. AC Power Cord
- 14. HDMI IN jacks (HDMI IN 1 / HDMI IN 2)
- 15. AUDIO jack (PC IN)
- 16. COMPONENT VIDEO IN (Y / PB / PR)
jacks (YUV IN)

- 17. AUDIO IN (Left/Right) jacks (AV IN 2)
- 18. VIDEO IN jack (AV IN 2)
- 19. VIDEO IN jack (AV IN 1)
- 20. PHONES jack
- 21. TV ANTENNA terminal
- 22. AUDIO IN (Left / Right) jacks (AV IN 1)
- 23. S-VIDEO jack (AV IN 1)
- 24. AUDIO IN (Left / Right) jacks (YUV IN)

CONNECTIONS

CONNECTING A TV ANTENNA / CABLE / SATELLITE

To view television channels correctly, a signal must be received from one of the following sources:

- An indoor or outdoor aerial antenna
- A cable system
- A satellite system

Connecting a Digital Antenna

The tuner in this TV receives ATSC TV signals from an antenna.

This digital TV can receive standard (SDTV) and high definition (HDTV) over the air broadcasts.

Connecting an Analog Antenna / Device

The tuner in this TV receives NTSC TV signals, analog cable signals or the RF output from a satellite receiver, VCR or cable box.

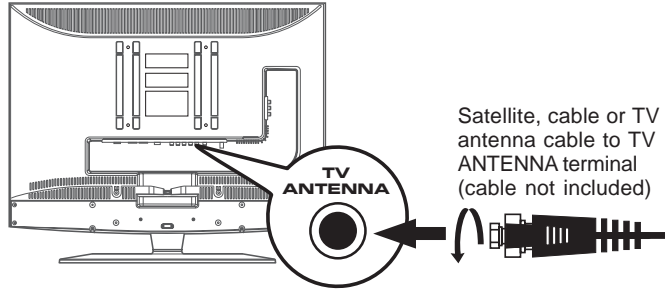

CONNECTING AN AV DEVICE

To connect to other equipment such as a VCR, camcorder, satellite system or calbe, etc.

Connecting to a VCR / Camcorder / Satellite System / Cable

Connect the AUDIO and S-VIDEO cable (not included) as shown:

Make sure you connect the cable from the other equipment (AUDIO OUT and S-VIDEO OUT) to this unit AV IN 1 (AUDIO IN and S-VIDEO IN).

NOTE

Please refer to the user manual for the other equipment for more information.

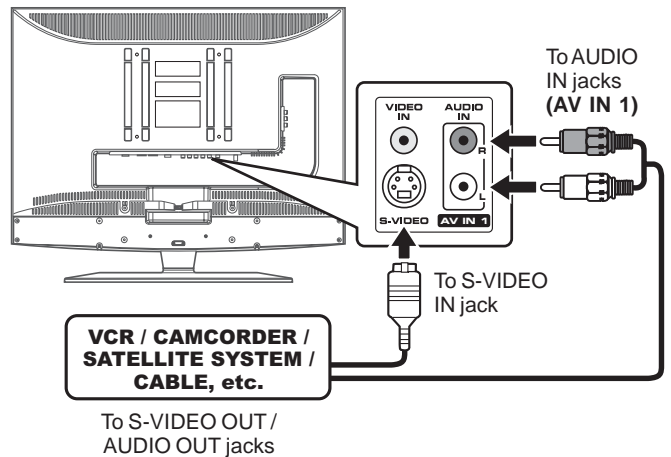

CONNECTIONS

CONNECTING DEVICES WITH A COMPOSITE (YELLOW RCA-TYPE) VIDEO OUTPUT

To connect A/V devices such as a VCR, video game system or camcorder:

Connecting to a VCR / Video Game System / Camcorder

Connect the AUDIO / VIDEO cable (not included) as shown:

Make sure you connect the cable from the other equipment (**AUDIO** and **VIDEO OUT**) to this unit **AV IN 1** (**AUDIO** and **VIDEO IN**) or **AV IN 2** (**AUDIO** and **VIDEO IN**).

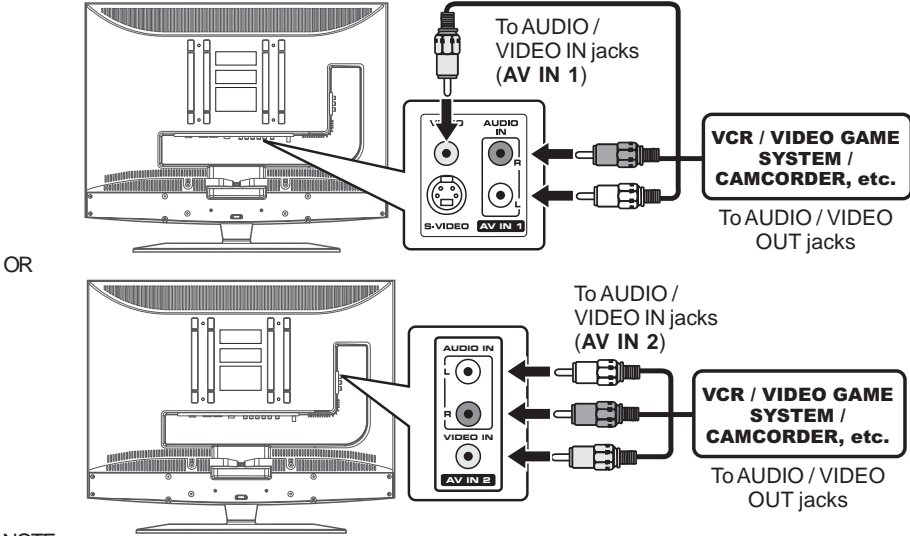

NOTE

Please refer to the user manual for the other equipment for more information.

CONNECTING DEVICES WITH A COMPOSITE (YELLOW RCA-TYPE) VIDEO INPUT

To connect A/V devices such as a VCR, PVR or camcorder:

Connecting to a VCR / PVR / Camcorder

Connect the AUDIO / VIDEO cable (not included) as shown:

Make sure you connect the cable from the other equipment (**AUDIO** and **VIDEO IN**) to this unit (**AUDIO** and **VIDEO OUT**).

NOTE

Please refer to the user manual for the other equipment for more information.

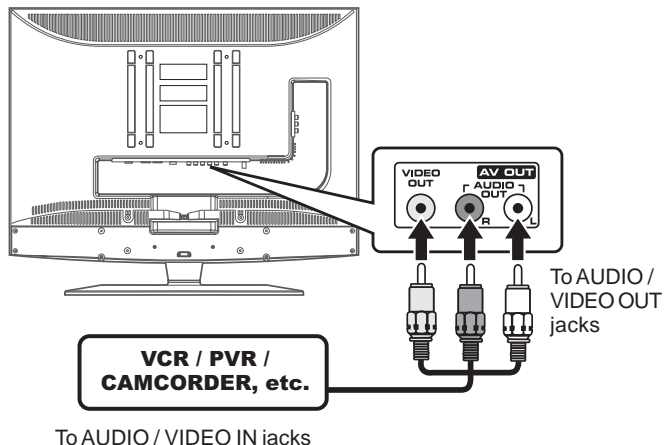

CONNECTIONS

CONNECTING A HIGH-DEFINITION (HD) SOURCE

High-Definition (HD) Devices with component video output must be connected to the YUV input. Connect the component video cable and audio cable (not included) as shown. Make sure you connect the component video cable and audio cable from the other equipment (**COMPONENT VIDEO OUT** and **AUDIO OUT**) to this unit (**COMPONENT VIDEO IN** and **AUDIO IN - YUV IN**).

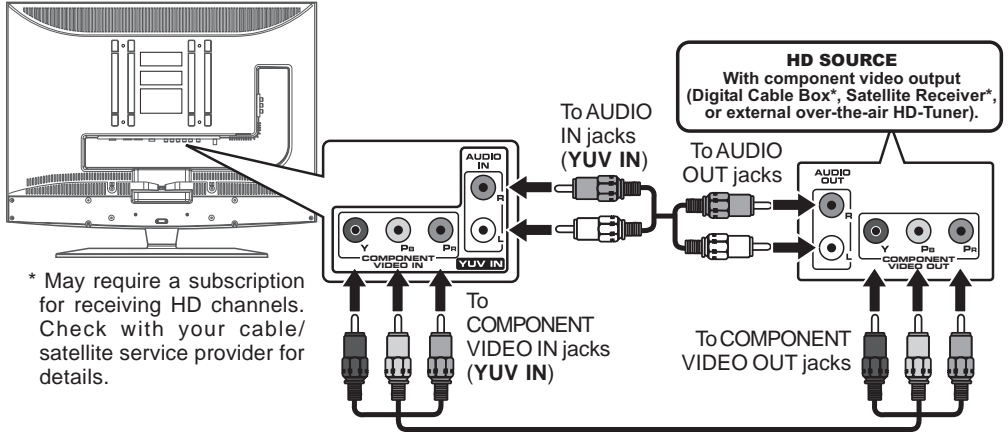

NOTE

When connecting a DVD player to the television, the picture resolution is solely dependent upon the resolution supported by the DVD player attached. DVD player resolutions vary from 480i to 1080i, and this unit can support DVD players up to a maximum resolution of 1080i.

CONNECTING A PC

Connect the 15-pin D-SUB PC/VGA connector from your computer to the 15-pin D-SUB PC/VGA input on this unit using a monitor cable and audio cable (not included) as shown.

Make sure you connect the cable from the computer (**PC Connector** and **AUDIO - PC OUT**) to this unit (**MONITOR / VGA** and **AUDIO - PC IN**).

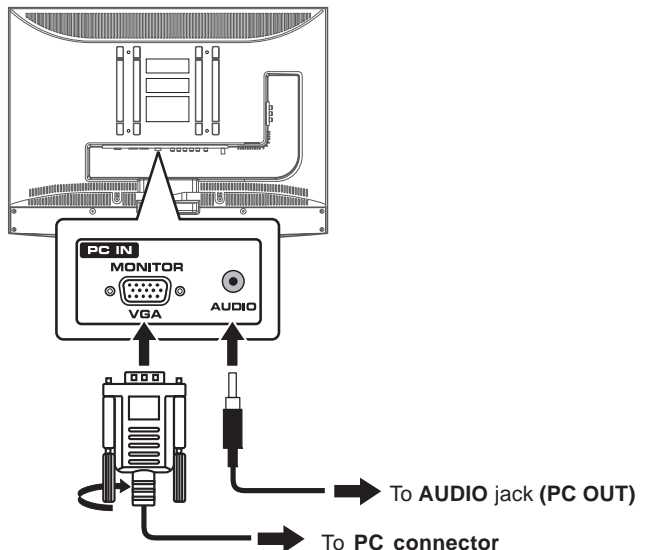

CONNECTIONS

CONNECTING HDMI

HDMI (High Definition Multimedia Interface) supports both video and audio on a single digital connection for use with DVD players, DTV, set-top boxes and other digital AV devices. HDMI was developed to provide the technologies of High Bandwidth Digital Content Protection (HDCP) as well as Digital Visual Interface (DVI) in one specification. HDCP is used to protect digital content transmitted and received by DVI-compliant or HDMI-compliant displays.

HDMI has the capability to support standard, enhanced or high-definition video plus standard to multi-channel surround-sound audio. HDMI features include uncompressed digital video, a bandwidth of up to 2.2 gigabytes per second (with HDTV signals), one connector (instead of several cables and connectors), and communication between the AV source and AV devices such as DTVs.

HDMI, the HDMI logo **HDMI** and High-Definition Multimedia Interface are trademarks or registered trademarks of HDMI licensing LLC.

Connect the HDMI cable (not included) as shown:

Make sure you connect the cable from the equipment (**HDMI OUT**) to this unit (**HDMI IN**).

Press the **HDMI** button to match the video source output quality.

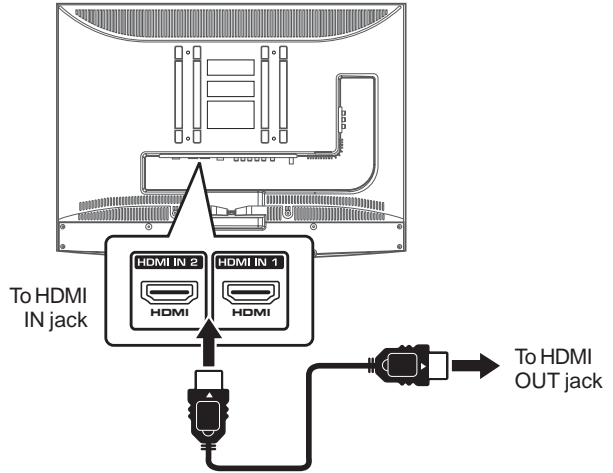

CONNECTING AN AUDIO AMPLIFIER

This connection allows you to use an audio amplifier and external speakers.

Connect the AUDIO cable (not included) as shown:

Make sure you connect the cable from the other equipment (**AUDIO IN**) to this unit (**AUDIO OUT**).

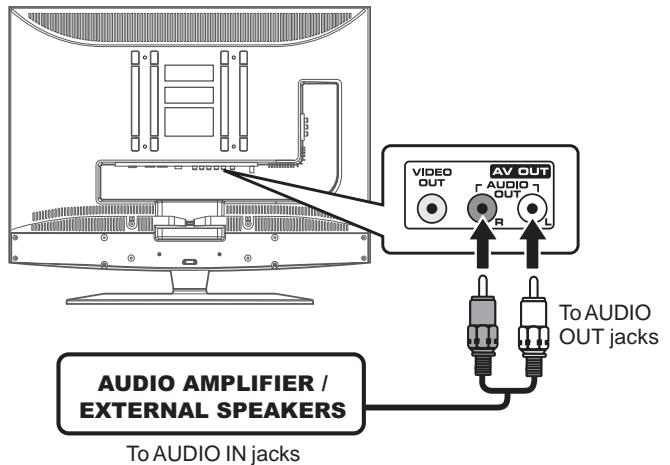

CONNECTIONS

CONNECTING THE AC POWER CORD

- Connect the AC power cord into a wall outlet.
- Press the **STANDBY / ON** button on the left side of the unit or use the remote control to turn on the unit.

NOTES

- **TO PREVENT ELECTRIC SHOCK, MATCH WIDE BLADE OF PLUG TO WIDE SLOT OF WALL OUTLET, THEN FULLY INSERT.**
- When the AC power cord is plugged in, the unit is not completely disconnected from the main power, even when the power is turned off.
- Be sure the AC power cord is disconnected and all functions are off before making connections.
- Make sure that all the components are connected correctly.
- When you are not going to use the unit for a long period of time, disconnect the AC power cord.

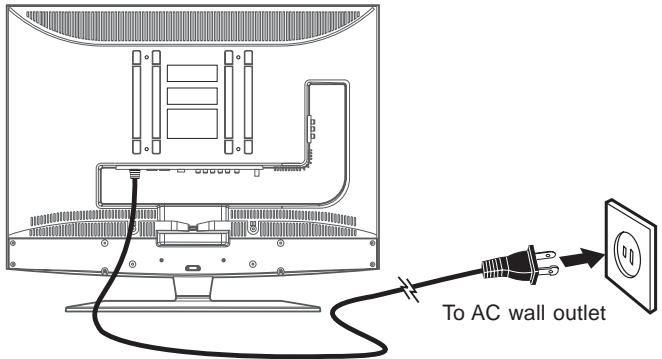

USING HEADPHONES

- Turn down the volume before connecting headphones to the unit, then adjust the volume to your desired level.
- When headphones are connected, no sound will come from the front speakers.

NOTE

Avoid listening to sound at high levels for prolonged periods of time. This may be harmful to you and may cause hearing loss.

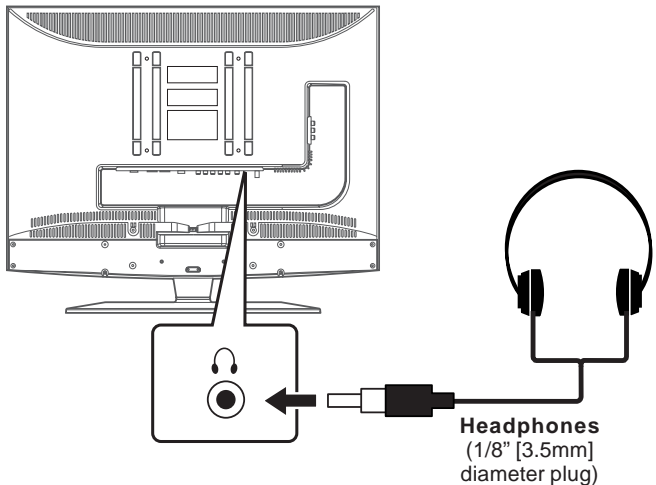

INSTALLATION

REMOVING THE BASE STAND

WARNING: The LCD display is very fragile, and must be protected at all times when removing the base stand. Be sure that no hard or sharp objects, or anything that could scratch or damage the LCD display, come in contact with it. Do NOT place pressure on the rear of the unit at anytime because the screen could crack.

1. Disconnect any cables or cords connected to the unit.
2. Lay the unit down on a flat surface, so the back side is facing up, making sure to place a soft cushioned material (such as a blanket or thick piece of foam) beneath the screen.
3. Remove the 8 screws and then remove the BASE STAND from the unit.

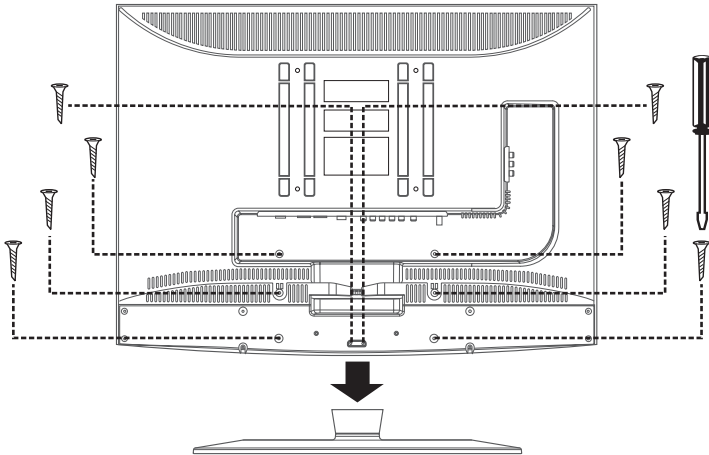

MOUNTING ON THE WALL

This unit is VESA-compliant, and is designed to be wall-mounted with a VESA-compliant 7 7/8" x 7 7/8" (200mm x 200mm) mounting kit designed for flat-panel TVs (sold separately). Mount this unit according to the directions included with the mounting kit.

NOTE

Remove the base stand before mounting the unit on the wall.

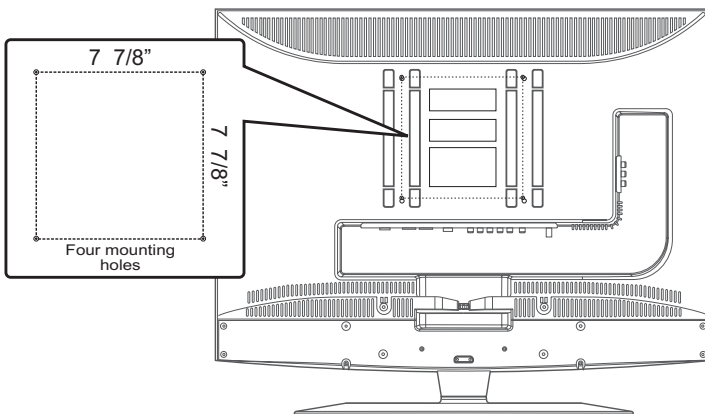

UNIT OPERATION

TURNING THE UNIT ON

When the AC power cord is connected, press the **STANDBY/ON** button to turn it on. Press the **FUNCTION** button to select desired mode (TV / AV 1 / AV 2 / YUV in / DVD / HDMI 1 / HDMI 2 / PC in). If you select DVD, the DVD logo will appear on the screen.

NOTE

When the unit is not going to be used for a long time, disconnect the AC power cord from the wall outlet.



SOUND SYSTEM

Dolby Digital (for DVD)

Dolby Digital is a sound system developed by Dolby Laboratories Inc. This unit automatically recognizes DVDs that have been recorded with Dolby Digital.

Not all Dolby Digital sources are recorded with 6 channels.

Some sources marked Dolby Digital may be recorded in Dolby Surround, a 2 channel system. Look for this logo on your unit.



Manufacturer under license from Dolby Laboratories.

"Dolby" and  the double-D symbol are trademarks of Dolby Laboratories.

TV SETUP

VIDEO MENU

1. Press the **MENU** button.
2. Press the **ENTER** or **▶** button to select **Video**.
3. Use the **▲** or **▼** button to select the options (**Picture Mode, Brightness, Contrast, Saturation, Tint, Sharpness or Color Temperature**). Adjust them using the **◀** or **▶** button (The screen will change to your desired setting); or press the **ENTER** or **▶** button to go into the detailed settings.
4. Press the **EXIT** button to return to the previous menu.
5. Repeat steps 3 and 4 to adjust other options.
6. To exit the MAIN MENU and return to the normal screen, press the **EXIT** button repeatedly.

TV MODE

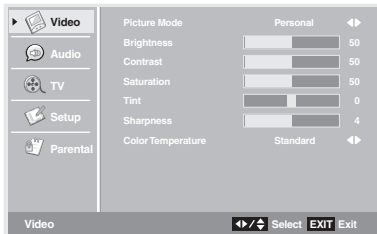

AV / YUV / DVD / HDMI MODE



PC MODE



VGA SETTINGS IN PC MODE

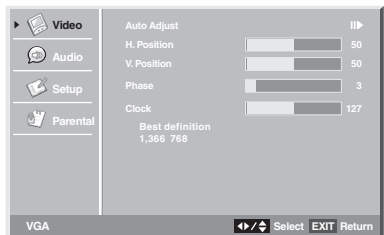

- Picture Mode** : Select from preset screen display settings to match the type of show you are watching (Personal, Soft, Movie, Standard & Dynamic). (Select Personal mode to recall your customized settings on brightness, contrast, saturation, tint, sharpness and color temperature.)
- Brightness** : Adjust the brightness of the picture. Brighten or darken the whole picture.
- Contrast** : Adjust to sharpen the picture quality. The black portions of the picture become richer in darkness and the white become brighter.
- Saturation** : Adjust the color saturation of the picture.
- Tint** : Adjust the tint of the picture. (Toward purple / Toward green)
- Sharpness** : Adjust the sharpness level to improve detail in the picture.
- Color Temperature** : Adjust the three color temperature of the picture. Choose from Standard (balanced), Warm (red white), or Cool (blue white) modes.
- H. Position** : Adjust the image by moving it left or right.
- V. Position** : Center the image by moving it up or down.
- Phase** : Adjusts the image if there is flicker of screen letters, color misalignment, or blurring.
- Clock** : Adjusts the display clock to change width of the image.

- Resolution : 1,366 x 768 max
- Refresh Frequency : 60Hz max

TV SETUP

AUDIO MENU

1. Press the **MENU** button.
2. Use the **▲** or **▼** button to select **Audio**, then press the **ENTER** or **▶** button to go into the Audio settings.
3. Use the **▲** or **▼** button to select the options (**Balance**, **Bass**, **Treble**, **Virtual Surround**, **Reverb**, **Sound mode** or **Auto Volume Control**). Adjust them using the **◀** or **▶** button (The screen will change to your desired setting); or press the **ENTER** or **▶** button to go into the detailed settings.
4. Press the **EXIT** button to return to the previous menu.
5. Repeat steps 3 and 4 to adjust other options.
6. To exit the MAIN MENU and return to the normal screen, press the **EXIT** button repeatedly.

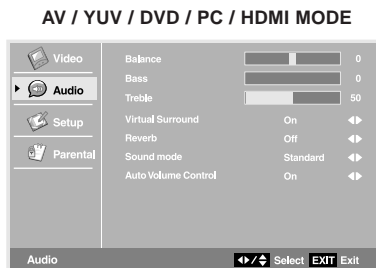
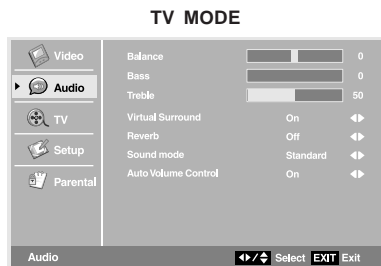

NOTE

Experiment with different sound settings until you find the settings you prefer.

- Balance** : Adjust the balance level toward the left or right speakers.
- Bass** : Adjust the bass range.
- Treble** : Adjust the treble range.
- Virtual Surround** : Switch on or off the virtual surround effect.
- Reverb** : Select from preset sound settings (Concert, Living Room, Hall, Arena, Church, Off) to match the type of show you are watching.
- Sound mode** : Select from preset sound settings (Standard, Personal, Theater, Voice & Music) to match the type of show you are watching. (Select Personal mode to recall your custom settings on bass and treble.)
- Auto Volume Control** : Automatically adjusts the sound level.

TV SETUP

TV MENU (For TV Mode Only)

1. Press the **MENU** button.
2. Use the **▲** or **▼** button to select **TV**. Press the **ENTER** or **▶** button to go into the TV settings.
3. Use the **▲** or **▼** button to select the options (**Tuner Mode**, **Auto Scan**, **Auto Scan Add CH**, **Channel Skip**, **MTS** or **Audio Language**). Adjust them using the **◀** or **▶** button (The screen will change to your desired setting); or press the **ENTER** or **▶** button to go into the detailed settings.
4. Press the **EXIT** button to return to the previous menu.
5. Repeat steps 3 and 4 to adjust other options.
6. To exit the MAIN MENU and return to the normal screen, press the **EXIT** button repeatedly.

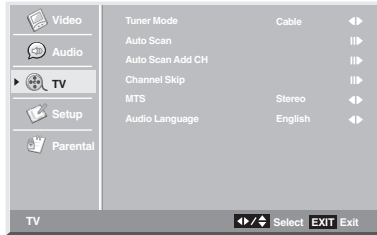

- Tuner Mode** : Antenna (over-the-air broadcasts, Ch 2-69) or Cable (cable/satellite broadcasts, CH 1-135) mode is available.
- Auto Scan** : Searches for usable stations and stores them in memory.
- Auto Scan Add CH** : Searches for more usable stations and adds them in memory. (The stations stored before are still kept.)
- Channel Skip** : Skip weak channels and the channels you do not like.
- MTS** : Select from Stereo / SAP (Secondary Audio Program) / Mono.
- Audio Language** : Select from English / Spanish / French. (Available for digital channels if multiple audio languages are broadcasted.)

NOTE

The SAP (Secondary Audio Program) feature allows a TV station to broadcast other information, which could be audio in another language.

Channel Skip Setting:

1. Use the **▲** or **▼** button to select a channel. (Press the **▶** button to select the last channel of the page, press again to go to the next page. Press the **◀** button to select the first channel of the page, press again to go to the previous page.)
2. Press the **ENTER** button to shift between skip or not skip the channel. ("✓" appears in the square means skip the selected channel. The channel will not appear when you press the **CH ^/CH v** Button.)

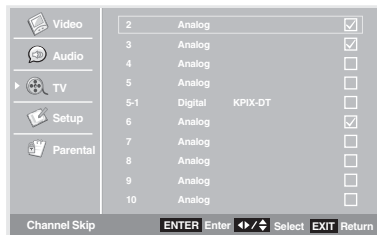

TV SETUP

SETUP MENU

1. Press the **MENU** button.
2. Use the **▲** or **▼** button to select **Setup**. Press the **ENTER** or **▶** button to go into the Setup settings.
3. Use the **▲** or **▼** button to select the options (**OSD Language**, **Time Setup**, **Caption** or **Restore setting**). Adjust them using the **◀** or **▶** button (The screen will change to your desired setting); or press the **ENTER** or **▶** button to go into the detailed settings.
4. Press the **EXIT** button to return to the previous menu.
5. Repeat steps 3 and 4 to adjust other options.
6. To exit the MAIN MENU and return to the normal screen, press the **EXIT** button repeatedly.

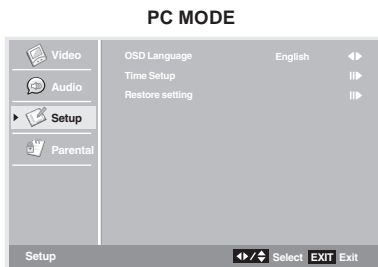
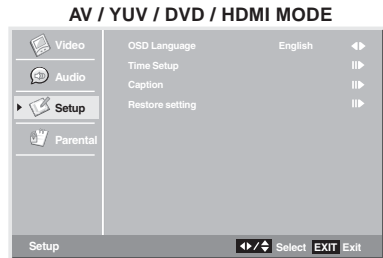
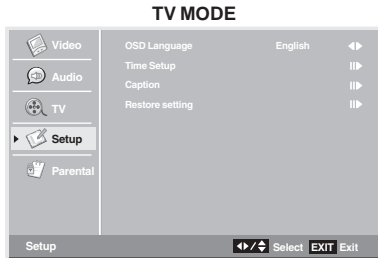

OSD Language :
Select from English / Español / Français.

Time Setup Setting

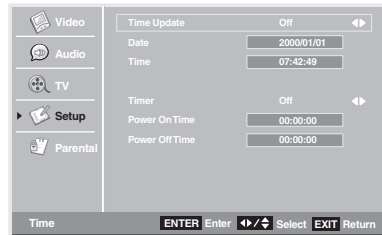
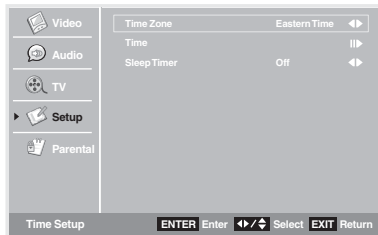

Time Zone : Select the time zone from Eastern Time / Indiana / Central Time / Mountain Time / Arizona / Pacific Time / Alaska / Hawaii.

Sleep Timer : Select the time to turn the unit to Standby mode automatically: Off -> 5 Minutes -> 10 Minutes -> 15 Minutes -> 30 Minutes -> 60 Minutes -> 90 Minutes -> 120 Minutes -> Off.

When you set the **'Time'**, the option will be shown:

Time Update : Select On/Off to activate the following manual settings; Select Auto to synchronize time with the digital TV channel signal.

Date : Press the **◀** or **▶** button to locate the position, and press the number buttons to input date.

Time : Press the **◀** or **▶** button to locate the position, and press the number buttons to input time.

Timer : Select On to activate automatically power on/off.

Power On Time : Press the **◀** or **▶** button to locate the position, and press the number buttons to input power on time.

Power Off Time : Press the **◀** or **▶** button to locate the position, and press the number buttons to input power off time.

TV SETUP

Caption Setting

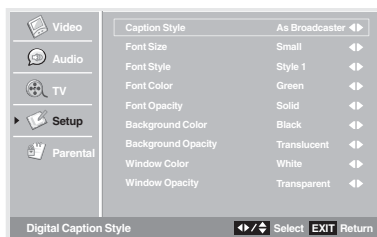
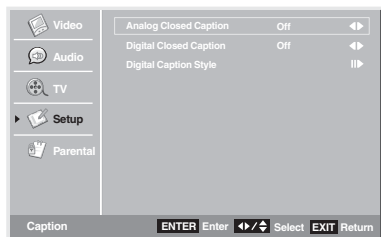

Analog Closed Caption : Select the analog closed caption or turn it off.

Digital Closed Caption : Select the digital closed caption or turn it off.

Digital Caption Style : Select as Broadcaster to use the default digital caption style of the broadcaster. Select Custom to activate the caption style items and set you preferred detailed settings.

NOTE

This function only works on ATSC programs broadcast with captions.

Restore Setting

If you reset the TV to the factory settings, all your present settings on Video & Audio will be erased and replaced by the factory's default settings. However, picture settings in PC mode and Parental settings will not be erased.

PARENTAL MENU

Password

1. Press the **MENU** button.
2. Use the **▲** or **▼** button to select **Parental**. Press the **ENTER** or **▶** button to confirm. The menu locked screen will be displayed.
3. Enter a 4-digit password. Once entered, the screen will enter the Parental menu. The preset password is 0000.

You can edit the parental control level or change the password. See **Parental Control Settings** on the next page.

TV MODE

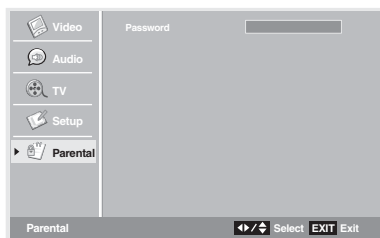

AV / YUV / DVD / PC / HDMI MODE

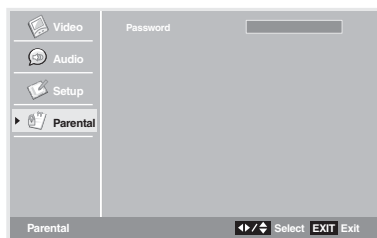

**If you forget the password,
enter " 8888 " to unlock parental control.**

TV SETUP

Parental Control Setting

1. Use the ▲ or ▼ button to select various Parental settings. Press the **ENTER** or ► button to go into the detailed settings.
2. Use the ▲, ▼, ◀ and ▶ buttons to move among the rating levels. Press the **ENTER** button to change the mode between Blocked and Allowed.
3. Press the **EXIT** button to return to the previous menu.
4. Repeat steps 1 - 3 to adjust other options.
5. To exit the MAIN MENU and return to the normal screen, press the **EXIT** button repeatedly.

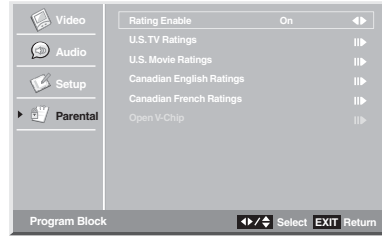
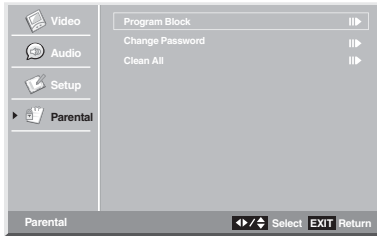



- Rating Enable** : Select On to edit the following parental items. Select Off to disable parental control.
- Open V-Chip** : Reads the ratings from ATSC TV programs if there is rating information broadcasted, and denies the channel when its rating is higher than the ratings you pre-set.

U.S. TV Ratings	<p>TV-Y : Recommended for all children.</p> <p>TV-Y7 : Recommended for all children age 7 and above.</p> <p>TV-G : General Audience.</p> <p>TV-PG : Parental Guidance Suggested.</p> <p>TV-14 : Parental Strongly Cautioned.</p> <p>TV-MA : Mature Audience Only.</p>
U.S. Movie Ratings	<p>G : GENERALAUDIENCES, Suitable for all ages.</p> <p>PG : PARENTAL GUIDANCE SUGGESTED - Some material may not be suitable for children.</p> <p>PG-13 : PARENTS STRONGLY CAUTIONED - Some material may be inappropriate for children under 13.</p> <p>R : RESTRICTED, Under 17 requires accompanying parent or adult guardian for viewing in movie theaters.</p> <p>NC-17 : No one 17 or under admitted in movie theaters,</p> <p>X : Adults Only.</p>
Canadian English Ratings	<p>C : Children.</p> <p>C8+ : Recommended for children age 8 and older.</p> <p>G : GENERALAUDIENCES, Suitable for all ages.</p> <p>PG : PARENTAL GUIDANCE SUGGESTED - Some material may not be suitable for children.</p> <p>14+ : Viewers 14 years and older.</p> <p>18+ : Adult Programming.</p>
Canadian French Ratings	<p>G : GENERALAUDIENCES, Suitable for all ages.</p> <p>8 ans+ : Not recommended for young children.</p> <p>13 ans+ : Not suitable for children under the age of 13.</p> <p>16 ans+ : Not suitable for children under the age of 16.</p> <p>18 ans+ : Adult Programming.</p>

PLAYING A DISC



This owner's manual explains the basic instructions of this unit. Some DVDs are produced with limited operation during playback. For example, many DVDs do not allow users to skip government warnings, or in some cases previews or other features. This is not a defect in the unit. Refer to the instruction notes of discs.

"" may appear on the screen during operation. A "" means that the desired operation is not permitted by the unit or disc.

PLAYING A DISC

1. Press the **STANDBY/ON** button to turn on the unit.
2. Press the **FUNCTION** button repeatedly to select DVD mode or directly press the DVD button on the remote, then press the **ENTER** button.

See CUSTOMIZING THE FUNCTION SETTINGS before proceeding to step 3.







3. Press the  button to open the disc door.
4. Hold the disc by its edges and gently push it onto the spindle with label side facing towards you until you hear a "click".
5. Press the  button to close the disc door.

After loading, for most DVDs, the unit will automatically start playing or take you to the main menu.

If the unit does not automatically start playing the DVD, press the **▶ PLAY** button.

PLAYING A PICTURE FILE DISC

This unit can play JPEG files recorded on CD-R or CD-ROM disc.

1. Press the  button to open the disc door.
2. Hold a JPEG file disc by its edge and gently push it onto the spindle with label side facing towards you until you hear a "click".
3. Press the  button to close the disc door.
4. The unit will load the disc and automatically display the contents of the disc on the screen, while also beginning to play the picture file. These files will then be played back one by one.
5. Press the  **STOP** button to go to the folder list.
6. Use the , ,  or  button to view and select desired file, then press the **ENTER** button to confirm the selected file.

NOTES

- You can press the **|| PAUSE** button to freeze the picture, and press the **▶ PLAY** button to resume slide show.
- You can press the **⏮ PREV** or **⏭ NEXT** button to change the picture. Press the **⏮ PREV** button to view the previous picture. Press the **⏭ NEXT** button to view to the next picture.
- You can press the **ANGLE** button to rotate direction of the picture by 90°.

PAUSING PLAYBACK (STILL MODE)

Press the **|| PAUSE** button. To resume normal playback, press the **▶ PLAY** button. Each time you press the **|| PAUSE** button, the picture advances one frame.

STOPPING PLAYBACK

Press the  **STOP** button at the location where you want to interrupt playback. To resume playback at the position where the disc was stopped, press the **▶ PLAY** button.

SKIPPING TO A DIFFERENT TRACK

- Press the **⏮ PREV** button to skip to the start of the current/previous track.
- Press the **⏭ NEXT** button to skip to the next track.
- For an Audio CD, use the number buttons on the remote control to go directly to the desired track number.

PLAYING A DISC

FAST FORWARD / FAST REVERSE

1. Press the **SEARCH** ◀◀ or ▶▶ **SEARCH** button when a disc is playing.
 - The disc begins a fast scan at two times normal (x2) speed.
 - Four speeds are available. Each time the **SEARCH** button is pressed, the speed of the fast scan changes.
2. Press the ▶ **PLAY** button when you have reached the desired point to resume playback at normal speed.

SLOW-MOTION PLAY (DVD)

1. Press the ▶ **SLOW** button on the remote control in play mode. Two speeds are available. Each time the ▶ **SLOW** button is pressed, the speed of slow-motion playback changes in the following sequence:
SF 1/2 ▶ → SF 1/3 ▶ → SF 1/4 ▶ → SF 1/5 ▶ → SF 1/6 ▶ → SF 1/7 ▶
2. Press the ▶ **PLAY** button to return to the normal playback speed.

AUDIO SELECTION (DVD)

On some discs, the sound is recorded in two or more formats. Follow the directions below to select the type of playback.

1. While a disc is playing, press the **AUDIO** button to show the current audio format number.
2. Press the **AUDIO** button repeatedly to select the desired audio format.

Ⓞ : 1/3ENG DDD 6CH

NOTES

- If only one audio format is recorded, the number does not change.
- About two seconds later, playback continues in the new audio format.

SUBTITLE SELECTION (DVD)

1. While a DVD is playing, press the **SUBTITLE** button to display the current language setting.
2. Press the **SUBTITLE** button repeatedly to select the desired subtitle language.

Ⓞ : 2/3 ESP

NOTES

- If only one language is recorded, the language does not change.
- About two seconds later, playback continues with the new subtitle selected.
- The number of languages recorded differs depending on the disc.
- If no button is pressed within a few seconds, playback continues without changing the current subtitle.
- This function can only be used for discs on which subtitles have been recorded in multiple languages.
- On some DVDs, subtitles are activated from the main menu of the DVD. Press the **DVD MENU** button to activate the main menu.

ANGLE SELECTION (DVD)

Some DVDs contain scenes that have been shot from a number of different angles. For these discs, the same scene can be viewed from each of these different angles.

1. While you are playing a DVD with different angles recorded, press the **ANGLE** button to view the number current angles available.
2. Press the **ANGLE** button repeatedly to change the scene to the next angle in those recorded.
 - About two seconds later, playback continues from the new angle selected.
 - If no button is pressed within 10 seconds, playback continues without changing the current angle.

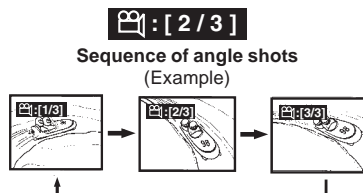

NOTES

- This function can only be used for discs on which scenes shot from multiple angles have been recorded.
- If only one angle is recorded, "📺 1/1" is displayed.

SPECIAL FUNCTION

DISPLAY

While the disc is playing, press the **DISPLAY** button repeatedly to display information on operation status.

	Title	Chapter	Elapsed time
DVD	TT 1/21	CH 6/29	⌚ 00:07:18
	Audio	Subtitle	Angle
⏮	1/3 ENG	DSD 6 CH	⏪ 2/3 ESP
⏭			⏩ OFF
	Title	Chapter	Remaining time
DVD	TT 1/21	CH 11/29	R -00:30:28
	Title	Chapter	Total time
DVD	TT 1/21	CH 11/29	T -01:00:28

LOCATING A SPECIFIC TITLE (DVD)

If a DVD contains title numbers, you can locate a specific title by directly selecting its title number.

1. In STOP mode, press the **GOTO** button.

2. Press the ◀ or ▶ button to highlight a specific field and press the corresponding number button(s) for the title you want.

DVD TT 00/21 CH 029/029 ⌚ 00:00:00

3. Press the **ENTER** button to confirm. The unit will start playback about 3 second later.

LOCATING A SPECIFIC CHAPTER / TRACK

If you know the chapter / track number you want to play, you can locate a specific chapter / track by directly selecting a chapter / track number.

1. Press the **GOTO** button to search for your desired chapter / track.

DVD TT 00/34 CH 000/029 ⌚ 00:00:00

2. Press the ◀ or ▶ button to highlight a chapter / track and press the corresponding number button(s) for the chapter / track you want.

CD TRK 00 / 12 🔊 ⏪ ⌚ 00:00:00

3. Press the **ENTER** button to confirm. The unit will start playback about 3 second later.

LOCATING A SPECIFIC TIME (DVD)

You can move to a specific location by entering its corresponding time (hours, minutes, seconds)

1. Press the **GOTO** button.

2. Press the ◀ or ▶ button to highlight a time and press the corresponding number button(s) for the setting point you want.

DVD TT 00/21 CH 029/029 ⌚ 01:00:00

3. Press the **ENTER** button to confirm. The unit will start playback about 3 second later.

NOTES

- Some discs may not respond to this process.
- This method of locating a title/chapter is available only on a DVD that contains title/chapter numbers.
- Some scenes may not be located as precisely as specified.
- This method for accessing specific locations is available only within the current title of the DVD.

REPEAT PLAYBACK

You can play a specific title or chapter repeatedly. (Title repeat, chapter repeat, A-B repeat)

Repeating a Chapter (DVD)

You can play the same chapter repeatedly.

1. While the disc is playing, press the **REPEAT DISC** button until the **REP: CHAPTER** indicator displays on the screen. The current chapter is played repeatedly.

Repeating a Title

You can play the same title repeatedly.

2. While the disc is playing, press the **REPEAT DISC** button until the **REP: TITLE** indicator displays on the screen. The current title is played repeatedly.

To Resume Normal Playback

3. While the disc is playing, press the **REPEAT DISC** button until the **REP: OFF** indicator displays on the screen.

You can play a single track or an entire disc repeatedly.

Repeating a Single Track (CD)

You can play the same track repeatedly.

1. While the disc is playing, press the **REPEAT DISC** button until the **REP: REP 1** indicator displays on the screen. The current track is played repeatedly.

Repeating an Entire Disc

2. While the disc is playing, press the **REPEAT DISC** button until the **REP: REP ALL** indicator displays on the screen. The entire disc is played repeatedly.

To Resume Normal Playback

3. Press the **REPEAT DISC** button until the **REP: OFF** indicator displays on the screen.

Repeating a Specific Section (DVD) (CD)

You can play a specific section repeatedly.

1. While the disc is playing, press the **REPEAT A-B** button at the beginning of the section (**REPEAT A-** is displayed) you want to play repeatedly.
2. Press the **REPEAT A-B** button again at the end of the section (**REPEAT A-B** is displayed) you want to play repeatedly.
3. The unit will immediately begin replaying your selection.

To Resume Normal Playback

4. While the disc is playing, press the **REPEAT A-B** button until the **A-B CANCEL** indicator displays on the screen.

NOTES

- A-B repeat can only be used within the same title. If the start and end of the section to be repeated are in different titles, A-B repeat is cancelled.
- The A-B repeat function does not operate in scenes where different camera angles are recorded.

DVD / CD PROGRAMMABLE PLAYBACK

PROGRAMMABLE MEMORY

The two types of programmed playback provided by this unit are title/chapter programmed playback and track programmed playback.

Title /Chapter Programmed Playback (DVD)

1. In STOP mode, press the **MEMORY** button.
2. Enter the title numbers in **--**. Use the **◀** or **▶** button to move the highlight to chapter and enter the chapter numbers in **--**.
3. Use the **◀**, **▶**, **▲** or **▼** button to move to other fields.
4. Repeat steps 2 to 3.
5. Press the **▶ PLAY** button to start the programmed playback.

PROG	Title		Chapter		Title		Chapter	
	T	C	T	C	T	C	T	C
1	--	--	5	--	9	--	13	--
2	--	--	6	--	10	--	14	--
3	--	--	7	--	11	--	15	--
4	--	--	8	--	12	--	16	--
			PLAY				CLEAR	

Track Programmed Playback (CD)

1. In STOP mode, press the **MEMORY** button.
2. Enter the track numbers in **----**.
3. Use the **◀**, **▶**, **▲** or **▼** button to move to other fields.
4. Repeat steps 2 to 3.
5. Press the **▶ PLAY** button to start the programmed playback.

PROG	Track						
	1	2	3	4			
1	----	5	----	9	----	13	----
2	----	6	----	10	----	14	----
3	----	7	----	11	----	15	----
4	----	8	----	12	----	16	----
			PLAY				CLEAR

CUSTOMIZING THE FUNCTION SETTINGS

LANGUAGE SETUP

1. Press the **SETUP** button in STOP mode.
2. Use the **▶** button to change the highlight cursor. Use the **▲** or **▼** button to select a language, then press the **ENTER** button. The screen will change to your selected language immediately.
3. To exit the SETUP MENU and return to the normal screen, press the **SETUP** button.

VIDEO SETUP

1. Press the **SETUP** button in STOP mode.
2. Use the **▲** button to select LANGUAGE SETUP, then press the **◀** or **▶** button repeatedly until VIDEO SETUP appears.
3. Use the **▲** or **▼** button to select the option (**BRIGHTNESS**, **CONTRAST** or **VIDEO**), then press the **▶** button. Use the **▲** or **▼** button to make adjustments, then press the **ENTER** button. The screen will change to your selected setting.
4. Repeat steps 2 and 3 above to adjust other options.
5. To exit the SETUP MENU and return to the normal screen, press the **SETUP** button.

SYSTEM SETUP

1. Press the **SETUP** button in STOP mode.
2. Use the **▲** button to select LANGUAGE SETUP, then press the **◀** or **▶** button repeatedly until SYSTEM SETUP appears.
3. Use the **▲** or **▼** button to select the option (**TV TYPE** or **DEFAULT**), then press the **▶** button. Use the **▲** or **▼** button to make adjustments, then press the **ENTER** button. The screen will change to your selected setting.
4. Repeat steps 2 and 3 above to adjust other options.
5. To exit the SETUP MENU and return to the normal screen, press the **SETUP** button.

TV Type

Pan Scan

- When wide-screen video is played, this mode clips the right and left sides of the image so that it can be viewed on a conventional screen.
- Some wide-screen DVDs that do not permit Pan Scan playback are automatically played in Letter Box mode (black bands at top and bottom of screen).

Letter Box

- When wide-screen video is played in this mode on a conventional screen, black bands appear at the top and bottom of the screen.

Wide-screen

- This is the correct mode for playing wide-screen videos on a wide-screen.

NOTES

- The displayable picture size is preset on the DVDs. Therefore the playback picture of some DVDs may not conform to the picture size you select.
- When you play DVDs recorded in the 4:3 aspect ratio, the playback picture will always appear in the 4:3 aspect ratio regardless of the TV shape setting.

Default

It takes 3-5 seconds to reset the unit to the factory default.

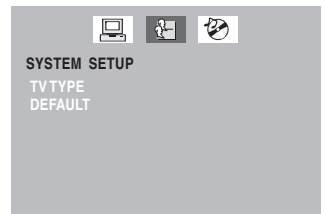
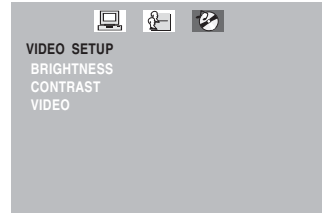
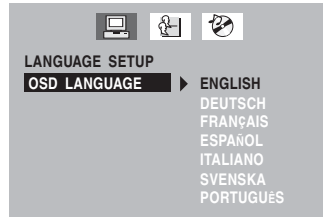

Cut off when a wide-screen video image is played.



Pan Scan



Letter Box



Wide-screen

TROUBLESHOOTING GUIDE

SYMPTOM

CAUSE (AND REMEDY)

No power.	<ul style="list-style-type: none">• Check that the AC power cord is connected.• The unit is not turned on.
The remote does not function.	<ul style="list-style-type: none">• Remove any obstacles between the remote and the unit.• Use the remote near the unit.• Point the remote at the remote sensor on the unit.• Replace the batteries in the remote with new ones.
DVD	
No sound or only a very low-level sound is heard.	<ul style="list-style-type: none">• Make sure that you select DVD mode.• The system is in pause mode. Press the ► PLAY button to return to normal PLAY mode.• Fast-forward or fast-reverse is performed. Press the ► PLAY button to return to normal play mode.• Make sure the AUDIO / VIDEO output and AV IN input connections are correct.• The DTS DVD disc cannot be decoded to have speaker output.• The unit is too hot. Shut off the unit for 30 minutes to cool it down.
No picture.	<ul style="list-style-type: none">• The region number of the disc does not match the region number of this unit. 
The picture is not clear.	<ul style="list-style-type: none">• Clean the disc.• The disc is scratched.
Severe hum or noise is heard.	<ul style="list-style-type: none">• The plugs and jacks are dirty. Wipe them with a cloth slightly moistened with alcohol.• Clean the disc.
The disc does not play.	<ul style="list-style-type: none">• There is no disc inside ("No Disc" appears on the screen).• Insert the disc correctly with the playback side facing down.• Clean the disc.• A non-valid disc has been inserted. The unit and disc region number are incompatible.• Condensation may have formed inside the unit due to a sudden change in temperature. Wait about an hour for it to clear and try again.
TV	
Bad Picture (snow, multiple images, distortion, blurry)	<ul style="list-style-type: none">• Check the location of the antenna and adjust it if necessary.• Make sure the antenna cable is firmly connected.• Make sure all input cables are firmly connected.
Black and white picture.	<ul style="list-style-type: none">• Check the VIDEO MENU within the TV SETUP MENU.• Check to make sure the program you are watching is broadcast in color and not black & white.
No picture or sound.	<ul style="list-style-type: none">• Make sure the unit is plugged in and turned on.• Make sure that TV mode is selected.• Try a new channel to check for possible station trouble.• Make sure the antenna is connected properly.• Increase the volume.• Make sure the antenna or audio video source device is working properly.• Make sure all cables are firmly connected.• Check for local interference.
Colored patches of picture.	<ul style="list-style-type: none">• Make sure there are no unshielded electrical devices nearby that are causing interference.• Turn the unit off for 30 minutes, then try it again.
No sound is output from the HDMI out	<ul style="list-style-type: none">• Check the connection between this unit and the HDMI out jack of other equipment.• See if the TV supports this 480p/576p/720p/1080i DVD system.• Check your TV system setup correctly.• Make sure your TV supports HDCP (High Bandwidth Digital Content Protection).

Unit : INCH

