

# User's Guide

## RCA SCENIUM



# Important Information

---

## WARNING

To reduce the risk of fire or electric shock, do not expose this product to rain or moisture. The apparatus shall not be exposed to dripping or splashing and no objects filled with liquids, such as vases, shall be placed on the apparatus.

## CAUTION

RISK OF ELECTRIC SHOCK  
DO NOT OPEN

Caution: To reduce the risk of electric shock, do not remove cover (or back). No user serviceable parts inside. Refer servicing to qualified service personnel.



This symbol indicates "dangerous voltage" inside the product that presents a risk of electric shock or personal injury.



This symbol indicates important instructions accompanying the product.



This symbol indicates that the lamp in the HDTV contains mercury. Disposal of these materials may be regulated due to environmental considerations. For disposal or recycling information, please contact your local authorities or the Electronic Industries Alliance: [www.eiae.org](http://www.eiae.org).

Refer to the identification/rating label located on the back panel of your product for its proper operating voltage. FCC Regulations state that unauthorized changes or modifications to this equipment may void the user's authority to operate it.

**Cable TV Installer:** This reminder is provided to call your attention to Article 820-40 of the National Electrical Code (Section 54 of the Canadian Electrical Code, Part 1) which provides guidelines for proper grounding and, in particular, specifies that the cable ground shall be connected to the grounding system of the building as close to the point of cable entry as practical.

**Important:** This television is a table model and is designed to sit on a firm, flat, surface. Don't place the TV on soft carpeting or similar surface because the ventilation slots on the bottom of the unit will be blocked resulting in reduced lifetime from overheating. To assure adequate ventilation for this product, maintain a spacing of 4 inches from the top and sides of the TV receiver and 2 inches from the rear of the TV receiver and other surfaces. If used with the optional wall mount, adequate ventilation must also be maintained to allow unrestrained exhaust and intake of room temperature air. Also, make sure the stand or base you use is of adequate size and strength to prevent the TV from being accidentally tipped over, pushed off, or pulled off. This could cause personal injury and/or damage the TV. Refer to the Important Safety Instructions packed separately.

## Product Registration

Please fill out the product registration card (packed separately) and return it immediately. For U.S. customers: Your RCA Scenium Consumer Electronics product may also be registered at [www.rcascenium.com/productregistration](http://www.rcascenium.com/productregistration). Returning the card allows us to contact you if needed.

## Product Information

Keep your sales receipt to obtain warranty parts and service and for proof of purchase. Attach it here and record the serial and model numbers in case you need them. These numbers are located on the product.

Model No. \_\_\_\_\_

Serial No. \_\_\_\_\_

Purchase Date: \_\_\_\_\_

Dealer/Address/Phone: \_\_\_\_\_

## Thank you for choosing RCA Scenium

Congratulations on purchasing this RCA Scenium High Definition Television (HDTV) featuring Digital Light Processing™ (DLP™) technology—a true viewing experience. Your purchase decision represents an investment in a new generation of technology—DLP and HDTV. Even though this is a technologically advanced HDTV, it is the most user-friendly of its kind—with comprehensive on-screen instructions that guide you through all of the TV's features.

This introduction has three parts that describe why an RCA Scenium HDTV featuring DLP technology is an excellent choice:

**Part 1: DLP—brilliance in color, design, and technology**

**Part 2: Why RCA Scenium DLP is better**

**Part 3: Other Key Features of owning an RCA Scenium HDTV**

### Part 1: DLP— brilliance, in color, design, and technology

RCA Scenium brings you brilliant pictures with Digital Light Processing (DLP) system — a brilliantly choreographed, engineering marvel that combines microscopic mirrors, light, and color to bring you the best and brightest pictures possible.

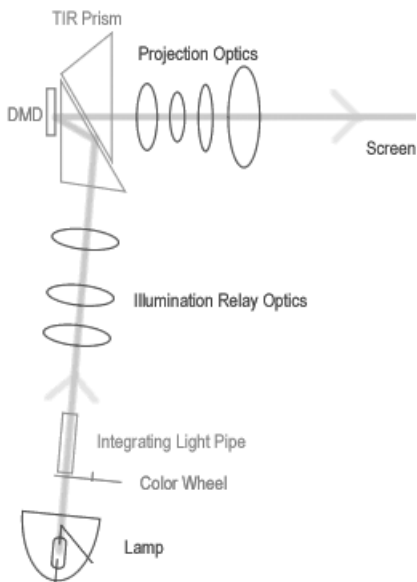

**EXAMPLE: Service Model Number sticker with lamp part number listed.**

**Model No.** \_\_\_\_\_

**Lamp Part No.** \_\_\_\_\_

**Date** \_\_\_\_\_

### How DLP Works

In general, DLP combines microscopic mirrors, a specially designed semiconductor, and a color wheel to adjust light to display the most brilliant, accurate images! Your DLP HDTV doesn't use red, green, and blue phosphors like Plasma or Cathode Ray Tubes (CRTs), which means you don't have to worry about screen burn (fixed video images burning onto the screen permanently) or convergence (realigning the CRTs). The diagram on the left illustrates the complex system.

### Thin and Light

The efficiency of DLP technology enabled our design team to create a high-performance HDTV that is about 7 inches thin and weighs approximately 125-140 pounds (depending on model).

### Lamp Replacement

DLP technology uses a special lamp. Eventually, you'll need to replace this lamp, which you can do yourself by following the replacement instructions on page 76. To order the correct lamp, you'll need to know your TV's model number, serial number, and lamp part number. The TV's model number is located under the front panel piece towards the bottom left corner. Go to page 10 for information on removing the front panel piece. The serial and lamp part numbers are listed on the Service Model Number sticker (example shown on the left). The sticker is located on the lamp handle (see page 78). For future reference, write down the information in the space provided at the left.

Digital Light Processing, DLP and DLP Cinema are trademarks of Texas Instruments. All other products and names may or may not be trademarks or registered trademarks of their respective companies.

# Introduction

---

## Part 2: Why RCA Scenium DLP is better

DLP is just part of the story. You have chosen to embark on the next generation of TV viewing— HDTV. There are many technological advancements that make HDTV better than analog TV, but there are basically three things about HDTV that bring you a superior viewing experience: (1) resolution, (2) aspect ratio, and (3) digital signal and sound.

### Resolution (it's math...that works for you)

The crisp, lifelike picture that people rave about when experiencing true HDTV is due to the resolution this technology provides. The resolution is measured by calculating the number of active lines of pixels. A pixel (which stands for picture element) is a small dot. The picture you see on your TV is composed of these dots.

A regular, analog television only has a resolution of about 200,000 pixels (480 vertical pixels x 440 horizontal pixels = 211,200 pixels). The HDTV format is capable of more than 2 million pixels (1,920 x 1,080 = 2,073,600).

More pixels equal more detail. In summary, HDTV is capable of resolution that is up to 10 times the resolution of the picture on a regular, analog TV!

Feature	Analog (NTSC)	HD Digital (ATSC)
Total Scan Lines	525	1125
Effective Scan Lines	480	1080
Aspect Ratio	4:3	16:9 (Widescreen)
Max Resolution	720 x 480	1920 x 1080
Sound	2-ch Stereo	5.1 ch Surround

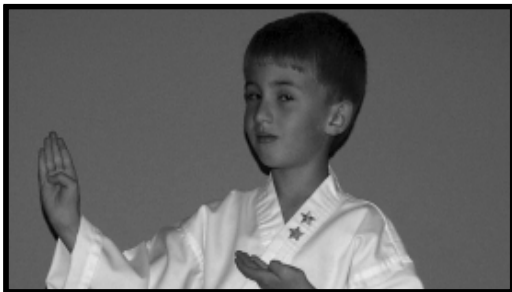

16:9 Aspect Ratio



4:3 Aspect Ratio

### Aspect Ratio

Aspect ratio is simply the width and height of the picture. Regular TVs use a 4:3 aspect ratio, which means the picture is a little wider than it is tall (a screen that is 20 inches wide is about 15 inches tall).

When the standards were being developed for television broadcasting in 1941 by the NTSC (the National Television Standards Committee), it made sense to adopt the 4:3 aspect ratio the film industry was using at that time.

As TVs dropped in price and people prospered in the 1950s, the movie industry had to find a way to get people out of their living rooms and back to the movie theatres. That's when they created the 16:9 aspect ratio (also called widescreen format). When the standards for HDTV were being developed by the ATSC (Advanced Television Standards Committee), the 16:9 aspect ratio was chosen as the format for HDTV.

This widescreen format makes sense because it's much closer to the way we see. Our field of vision is actually much wider than tall because of our peripheral vision. Not only is it closer to the way we see, but the pictures are crisper and cleaner with more detail in the close-up and panoramic views.

## Digital Signal and Sound

The analog television broadcast system that has been used in the United States for the past 50 years transmits signals as electronic waves. These waves can suffer degradation as the signal travels to your home. Additionally, the analog waves are susceptible to interference from planes passing overhead, weather, and household appliances.

Digital signals, in contrast to analog signals, can be reproduced precisely because the images are transmitted and received using the computer language of 1s and 0s. Such precision yields a signal that is capable of displaying studio-quality picture and Dolby Digital 5.1 channel sound.

## Part 3: Other Key Features of Owning an RCA Scenium HDTV

Your RCA Scenium HDTV is equipped with many features that will enhance your viewing experience. The following section highlights some of your TV's most unique features. For details about many of the TV's features, go to Chapter 3.

### Integrated HDTV Tuner with Digital Cable Ready QAM

RCA was the first to offer an integrated tuner with its HDTVs (which means there is no need for another box to receive digital programming). Now, we've gone one better—your HDTV's tuner is digital cable ready (no need for a cable box to view unscrambled digital cable programming). The CableCARD™ slot on your HDTV allows you to use a digital cable card to access digital cable. The tuner is able to decode all 35 formats of digital television broadcasts, and it can interpret unscrambled digital cable signals because it includes QAM (Quadrature Amplitude Modulation).

**Note:** A digital cable card may be necessary to view scrambled (encrypted) channels. Contact your cable provider for more information. Go to page 20 for more information.

### TruScan Digital Reality

With the *Film Mode* option turned on, the intelligent signal processing of TruScan Digital Reality recognizes incoming video signals and progressively converts them to achieve optimum digital picture performance. It also recognizes when original film sources have been modified and can automatically convert the analog frame rate back to its original format to bring out the detail—a process commonly referred to as reverse 3:2 pulldown.

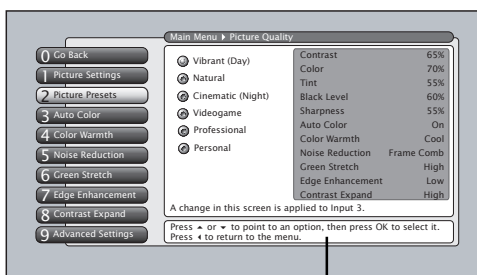

**Help text**

### User-friendly Features Help You Personalize Your TV

- You can customize your TV to fit your viewing taste and match the lighting where you watch TV by using Personal Presets and/or the automatic picture quality settings: Vibrant (Day), Natural, Cinematic (Night), Videogame, Professional. You can adjust each input jack to a different setting and the TV will automatically adjust the picture when you change inputs.
- Help Text: The elaborate, on-screen help text describes your TV's features and explains how to use them.

# Introduction

---

## FireWire® with Two-Way DTVLink®

Control your DTVLink components via your HDTV! Just link them together via the 2-way DTVLink jacks and you can network your compatible DTVLink digital components. The two-way jacks allow the audio and video signals to flow into and out from DTVLink components, such as the DVR2080 or DVR2160 (see below).

## Compatible with the Optional Audio Video Hard Disk Drive — Pause Live Digital TV and Record Digital Programs

RCA offers an Audio Video Hard Disk Drive (model DVR2080 or DVR2160) with DTVLink, available at your local RCA dealer or [www.rca.com](http://www.rca.com). The DVR2080 or DVR2160 Audio Video Hard Disk Drive (ADVHDD) component lets you pause live TV, record shows, and play them back (it records digital broadcasts only--ATSC and QAM signals).



To get the most out of your HDTV's web browser, use the supplied keyboard (model KBR755TA1) designed specifically for your TV.

## NetConnect

With an Ethernet connection and a web browser built into your TV, you can access the Internet from your TV\*. To use the web browser, you'll need a high-speed connection, such as a DSL (Digital Subscriber Line) unit or cable modem and a subscription to an ISP (Internet Service Provider). DSL, cable modem, and ISP subscription sold separately.

Additionally, your RCA Scenium HDTV enables you to access photos directly from your PC and display them on the TV! To find out more about this feature, go to [www.rca.com/Access/Scenium/311](http://www.rca.com/Access/Scenium/311).

\*The browser can't interpret all types of files, such as streaming audio and video.

## Audio System

Enjoy the great sound system in your HDTV with 60 watts total power. A 7-band on-screen graphic equalizer allows customization of the sound quality. TruSurround XT™ solves the problem of playing 5.1 multichannel content over two speakers. It delivers a compelling, virtual surround sound experience through the internal television speakers.

You can take advantage of the 6-Channel direct Audio Outputs (Matrix Surround, Subwoofer, etc.) if you have an amplifier you want to connect to your HDTV. Then choose to control the volume from the TV or the amplifier in the *Fixed/Variable Output* option in the *Audio Connections* menu. If you own an amplifier with digital audio, connect to the DIGITAL AUDIO OUTPUT instead.

## Audio/Video Output Jacks

Because the VCRs in most households are analog and can't receive or record digital TV signals, recording HDTV broadcasts wasn't possible without purchasing additional equipment. That's why RCA added AUDIO/VIDEO OUTPUT jacks to this HDTV. These jacks enable you to record both analog and digital programs. RCA understands how you watch TV and what's necessary to make the transition to HDTV seamless.

TruSurround XT, SRS and the (●) symbol are trademarks or registered trademarks of SRS Labs, Inc.

DTVLink® Certification Logo is a U.S. registered mark of CEA.

FireWire® is a trademark of Apple Computer, Inc., registered in the U.S. and other countries.

# Table of Contents

---

<b>Introduction .....</b>	<b>1</b>
<b>Chapter 1: Connections &amp; Setup</b>	
<b>Things to Consider Before You Connect .....</b>	<b>8</b>
Protect Against Power Surges .....	8
Protect Components from Overheating .....	8
Position Cables Properly to Avoid Audio Interference .....	8
Use Indirect Light .....	8
Using a Stand .....	8
Cables You May Need to Connect Components to Your TV .....	8
<b>Choose Your Connection .....</b>	<b>9</b>
<b>Removing the Front Panel Piece .....</b>	<b>10</b>
<b>Accessing the Jack Panel .....</b>	<b>10</b>
<b>Explanation of Jacks and Cables .....</b>	<b>11</b>
<b>The Front of Your TV .....</b>	<b>15</b>
Front Panel Buttons .....	15
How to Connect: TV + VCR + DVD Player .....	16
How to Connect: TV + Satellite Receiver + VCR .....	17
How to Connect: TV + DTVLink Components .....	18
How to Connect: TV + Component with DVI or HDMI .....	19
How to Connect: TV + CableCARD .....	20
Setting Up Digital Cable Television Service .....	20
Audio Connections .....	21
How to Connect: TV + Router via the HDTV's ETHERNET Jack .....	23
<b>Plug in the TV .....</b>	<b>24</b>
<b>Put Batteries in the Remote .....</b>	<b>24</b>
<b>Turn on the TV .....</b>	<b>24</b>
<b>Use the Remote Control to Complete the Assisted Setup .....</b>	<b>24</b>
<b>Complete the Assisted Setup .....</b>	<b>25</b>
Set the Menu Language .....	25
Complete Channel Search .....	25
<b>Chapter 2: Using the Remote Control</b>	
<b>The Buttons on the Remote Control .....</b>	<b>28</b>
<b>Programming the Remote to Operate Other Components .....</b>	<b>30</b>
Find Out If You Need to Program the Remote .....	30
Programming the Remote .....	30
<b>How to Use the Remote After You've Programmed It .....</b>	<b>31</b>
<b>The Learning Feature .....</b>	<b>32</b>
Adding a Learned Function .....	32
Clearing a Learned Function .....	33
Deleting ALL Learned Functions .....	33
<b>Volume Punchthrough Feature .....</b>	<b>34</b>
Deleting ALL Volume Punchthrough Commands .....	34
<b>Using the INPUT Button .....</b>	<b>35</b>
<b>Remote Code List .....</b>	<b>35</b>
<b>Chapter 3: Using the TV's Features</b>	
<b>About the Channel Banner .....</b>	<b>38</b>
<b>Digital or Analog TV Channels .....</b>	<b>39</b>
Direct Tuning to a Channel .....	39
<b>Parental Controls .....</b>	<b>40</b>
Lock/Unlock TV .....	40
Channel Lists (Video Input List, Cable Channel List, Antenna Ch. List) .....	40
<b>How V-Chip Works for the USA and Canada .....</b>	<b>41</b>
USA V-Chip TV Ratings .....	41
Canada V-Chip .....	45
<b>Auto Tuning Feature .....</b>	<b>47</b>

# Table of Contents

---

<b>PIP (Picture-in-Picture) Operation</b> .....	<b>48</b>
<b>Using the Web Browser</b> .....	<b>50</b>
Saving Your Favorite Web Address .....	50
Controlling the Web Browser .....	51
<b>DTVLink Recording</b> .....	<b>51</b>
Set up DTVLink Recording Preferences .....	52
<b>Emergency Alert System (EAS)</b> .....	<b>52</b>
<b>Chapter 4: Using the TV's Menu System</b>	
<b>Menus, On-screen Help, and Control Panels</b> .....	<b>54</b>
<b>Picture Quality Menu</b> .....	<b>56</b>
Picture Settings .....	56
Picture Presets .....	56
Auto Color .....	57
Color Warmth .....	57
Noise Reduction .....	57
Green Stretch .....	57
Edge Enhancement .....	57
Contrast Expand .....	58
Advanced Settings .....	58
<b>Audio Menu</b> .....	<b>59</b>
Equalizer Presets .....	59
Audio Processor .....	60
Sound Logic .....	60
Audio Mode .....	61
SAP (Second Audio Program) .....	61
Balance .....	61
Audio Connections .....	62
<b>Recordings Menu</b> .....	<b>63</b>
<b>Connections Menu</b> .....	<b>63</b>
Signal Strength .....	63
Channel Search .....	64
Software Upgrade .....	64
Signal Source .....	64
Video Input Setup .....	64
Auto Tuning .....	65
DTVLink Setup .....	65
Special Features .....	65
Ethernet Setup .....	66
<b>Preferences Menu</b> .....	<b>67</b>
Closed Captioning .....	67
Screen Format .....	69
Time Menu .....	69
Color Scheme .....	70
Translucency .....	70
Menu Language .....	70
Power Indicator .....	70
Lamp Power .....	70
<b>Chapter 5: Troubleshooting</b>	
<b>Troubleshooting</b> .....	<b>72</b>
<b>Lamp Replacement Instructions</b> .....	<b>76</b>
<b>HDTV Specifications</b> .....	<b>80</b>
<b>Accessory Information</b> .....	<b>82</b>
<b>Limited Warranty</b> .....	<b>84</b>
<b>Care and Cleaning</b> .....	<b>85</b>
<b>FCC Information</b> .....	<b>85</b>



# Connections & Setup

## Chapter Overview:

- Things to Consider Before You Connect
- Choose Your Connection
- Removing the Front Panel Piece
- Accessing the Jack Panel
- Explanation of Jacks and Cables
- The Front of Your TV
- How To Connect
- Plug in the TV
- Put Batteries in the Remote
- Turn on the TV
- Use the Remote Control to Complete the Assisted Setup
- Complete the Assisted Setup

SCENIUM

## Things to Consider Before You Connect

### Protect Against Power Surges

- Connect all components before you plug any of their power cords into the wall outlet or power strip. NEVER plug your TV into an outlet that is controlled by a wall switch.
- Turn off the TV and/or component(s) before you connect or disconnect any cables.
- Make sure all antennas and cables are properly grounded. Refer to the Important Safety Instructions packed with your TV.

### Protect Components from Overheating

- Don't block ventilation holes on any of the components. Arrange the components so that air can circulate freely.
- Don't stack components.
- If you place components in a stand, make sure you allow adequate ventilation.
- If you connect an audio receiver or amplifier, place it on the top shelf so the heated air from it won't flow around other components.

### Position Cables Properly to Avoid Audio Interference

- Insert each cable firmly into the designated jack.

### Use Indirect Light

Don't place the TV where sunlight or room lighting will be directed toward the screen. Use soft or indirect lighting.

### Using a Stand

If a stand, base, or cabinet is used, insure that it is of adequate size and strength to prevent the TV from being accidentally tipped over, pushed off, or pulled off. This could cause personal injury and/or damage the TV. Refer to Important Information on the inside front cover and the Important Safety Instructions packed with your TV.

## Cables You May Need to Connect Components to Your TV

The pictures below show the cables (not supplied) you may need for the connections represented in this book.

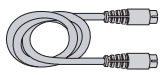

S-Video cable



CAT5 (Ethernet) Cable



Audio Cables

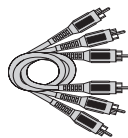

Composite Video  
Audio/ Video cable

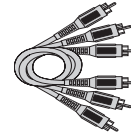

Component Video  
(Y, Pb, Pr) cable

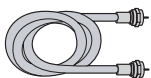

Coaxial cable

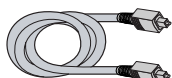

Digital Optical Cable

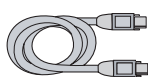

DTVLink Cable



Speaker Wire

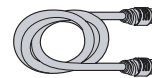







HDMI™ cable (or DVI  
cable and HDMI/DVI  
adapter)

HDMI and High-Definition Multimedia Interface are trademarks or registered trademarks of HDMI Licensing LLC.

## Choose Your Connection

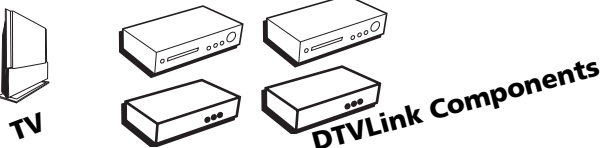
There are several ways to connect your HDTV, depending on the components you want to connect and the quality of the signal you want to achieve. Please use the following chart to determine which connection is best for you. Proceed to the appropriate page and connect your TV. For more information about the relationship between the cables, jacks, and the quality of the signal you see on your TV, go to following page.

***Note for U.S. Customers:** If you prefer, we can provide you with the name of an Authorized Service Representative who will visit your home for a fee to install your electronic entertainment system and to instruct you in its operation. For details about this service, call 1-888-206-3359. For additional assistance while using your RCA Scenium product, please visit [www.rcascenium.com/customer-support](http://www.rcascenium.com/customer-support).*

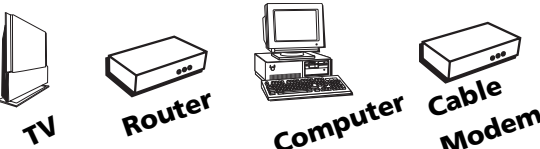
Components	Cables Needed	Connection Title	Go to...
<b>Video Connections</b>			
 <p>TV DVD VCR</p>	Coaxial Audio Component Composite	TV + VCR + DVD Player	page 16
 <p>TV Satellite Receiver VCR</p>	Coaxial Audio Composite S-Video	TV + Satellite Receiver + VCR	page 17
<b>Digital/Network Connections</b>			
 <p>TV DTVLink Components</p>	Coaxial DTVLink	TV+ DTVLink Components	page 18
 <p>TV Component with DVI or HDMI</p>	Coaxial HDMI (or DVI with HDMI/DVI adapter)	TV + Component with DVI or HDMI	page 19
 <p>TV CableCARD</p>	Coaxial	TV + CableCARD	page 20
<b>Audio Connections</b>			
 <p>TV A/V Receiver Speakers</p>	Coaxial Optical cable or Audio cables Speaker wire	TV + A/V Receiver + Speakers or TV + Receiver w/ Dolby Digital + Speakers	pages 21, 22
<b>Advanced Connections</b>			
 <p>TV Router Computer Cable Modem</p>	Coaxial CAT5 (Ethernet)	TV + Router via the HDTV's ETHERNET jack	page 23

# Connections & Setup

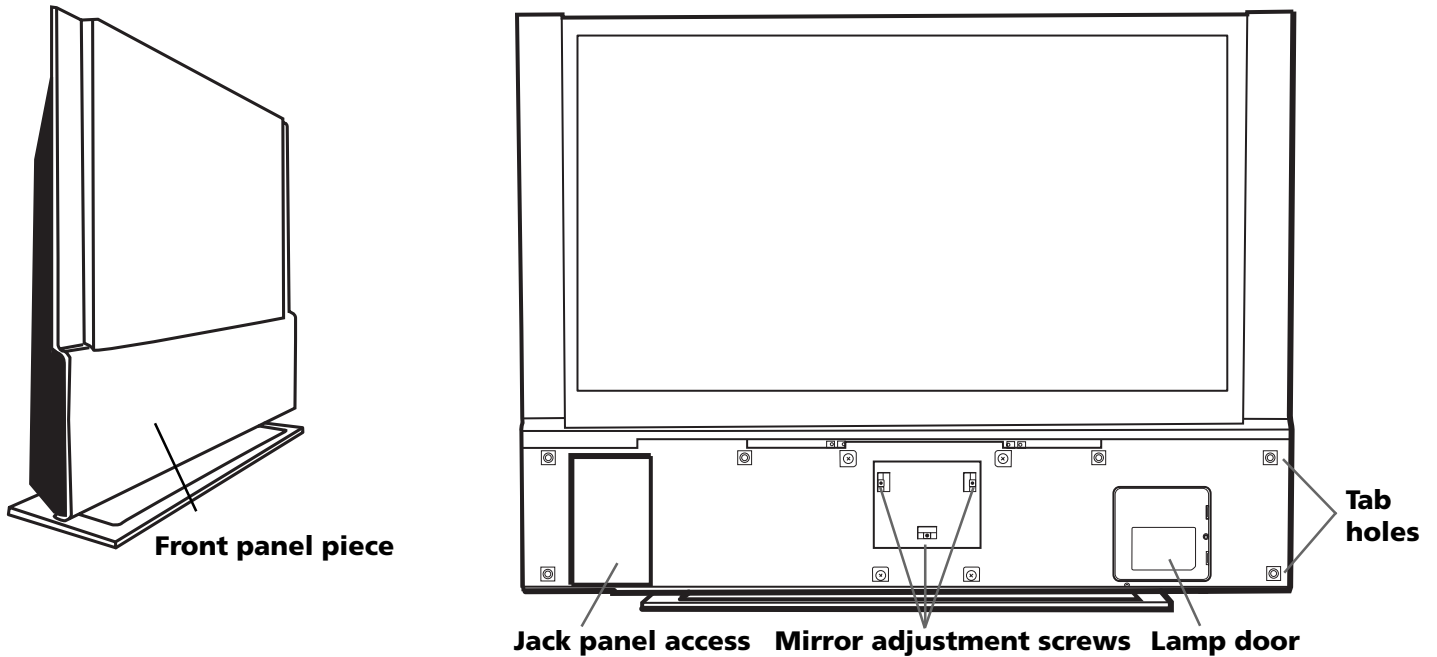

## Removing the Front Panel Piece

The front panel piece is removable to allow access to the jack panel, mirror adjustment screws, and lamp door. The mirror adjustment is discussed on page 59 and the lamp replacement is discussed on page 76. To remove the front panel piece, grasp one end of the panel and pull out until the tab pops out of the hole. Continue to slide your fingers down the panel as the tabs pop out of place, until it is unattached. Reattach the front panel piece by lining up the tabs with the holes, starting at the bottom. Then push the tabs back into place.

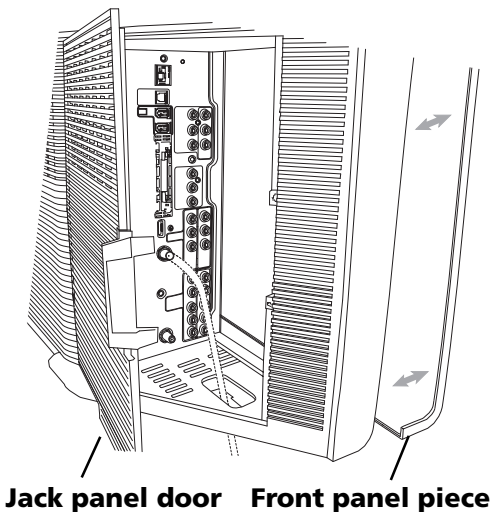

## Accessing the Jack Panel

The jack panel is located towards the back of the TV. You can access these jacks from the front by removing the front panel piece as described above, or from the back by removing the jack panel door.

Locate the jack panel door on the back of the TV on the right bottom side. To remove the door, pull the tab towards the left, and then pull the door open. Reattach the jack panel door by fitting the tabs on the left into the slots and then close the door until it snaps into place.

Connect the cables to the jacks by putting the cables through the hole, as shown to the left. Then the cables can be placed on the shelf at the back of the TV.

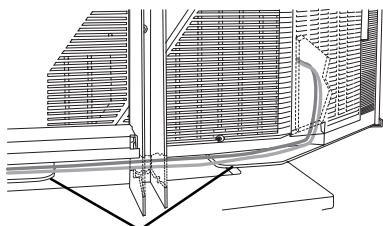

## Explanation of Jacks and Cables

The diagrams that follow illustrate jacks found towards the back of the TV. When connecting cables, be sure to connect corresponding outputs and inputs (video input into video out, right audio input into right audio out, etc.).

This section describes the jacks and cables you might use to make connections (cables may be ordered separately by calling the number on page 82). There are several ways to connect components to your TV.

Different jacks and cables provide a different level of performance. It's important to remember the different degrees of picture quality for comparison. The HDMI/DVI, DTVLink, and component jacks are considered excellent; S-Video is very good; composite jacks are good, while connecting components to the Antenna or Cable Input is fair.

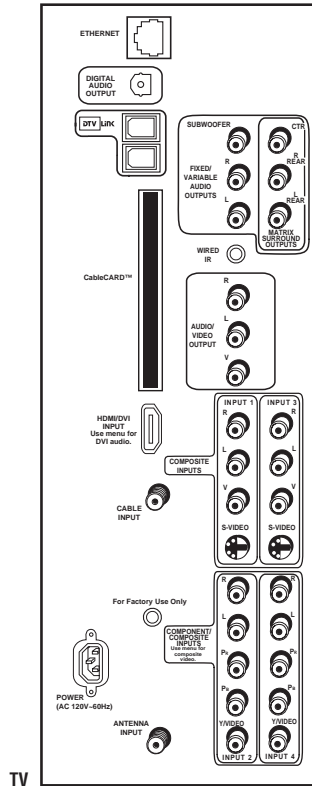

TV

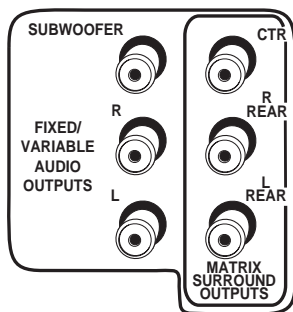

## AUDIO/VIDEO OUTPUTS

### FIXED/VARIABLE AUDIO OUTPUTS

- **CENTER** Provides center surround sound to an A/V receiver or audio amplifier.
- **R and L REAR** Provides right and left rear surround sound.

*Note:* To turn the TV's internal speakers on and off, press **MENU** on the remote control and choose **Audio**, then **Audio Connections**. Then choose **Fixed/Variable Out** from the menu and choose an option.

- **SUBWOOFER** Provides lower bass frequencies out from the TV and to a subwoofer or audio receiver with a subwoofer jack.

*Note:* Go to **Fixed/Variable Output** in the **Audio Connections** menu to set option to **Yes** if an external subwoofer is being used.

- **R and L** Provides right front and right rear mixed sound, and left front and left rear mixed sound.

# Connections & Setup

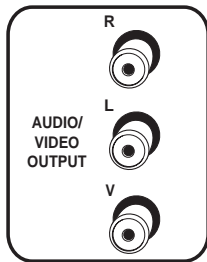

Composite Audio Cable (RCA Type)

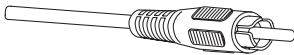

Composite Video Cable (RCA Type)

**AUDIO/VIDEO OUTPUT** Connect a VCR or DVD-recorder to record digital and analog programs from the Cable or Antenna Input (excluding copy-protected programs and component video formats) while the TV is turned on. You must leave the TV on the same channel you are recording.

- **R Audio** provides right audio connection and connector is usually red.
- **L Audio** provides left audio connection and connector is usually white.
- **V (Video)** provides composite video connection and connector is usually yellow.

*Notes: When recording from this output, remember to tune to the channel you want to record.*

*If an unusual pattern appears when you connect a VCR to these jacks, playing a tape or switching to the VCR's tuner removes the pattern.*

## AUDIO/VIDEO INPUTS

**INPUT 1 COMPOSITE INPUT** Connect an NTSC (analog) component. These jacks are used for most audio/video connections between components. The audio/video jacks are often color coded (yellow for video, red for right audio, and white for left audio).

- **R Audio** provides right audio connection and connector is usually red.
- **L Audio** provides left audio connection and connector is usually white.
- **V (Video)** provides composite video connection and connector is usually yellow.
- **S-VIDEO** lets you connect an S-Video cable for better picture quality to a component with S-Video capability, such as a VCR or DVD player. When using S-Video, make sure to connect the two audio cables as well as the S-Video connector.

The S-Video jack provides better picture quality than the composite video jacks because the color (chrominance, also called chroma) part of the signal is separated from the black and white (luminance) part of the picture.

**INPUT 3 COMPOSITE INPUT** Provides connection to a second NTSC (analog) video component such as a VCR. The jacks are the same as described above for INPUT 1.

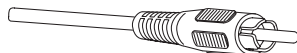
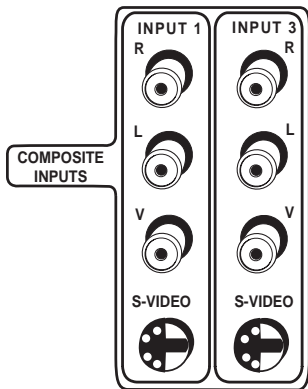

Composite Audio Cable (RCA Type)

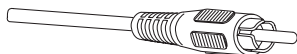

Composite Video Cable (RCA Type)

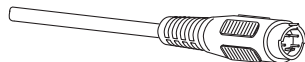

S-Video Cable

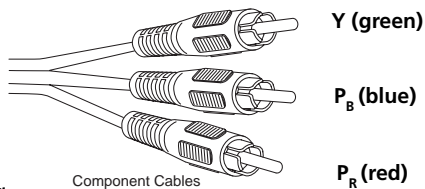
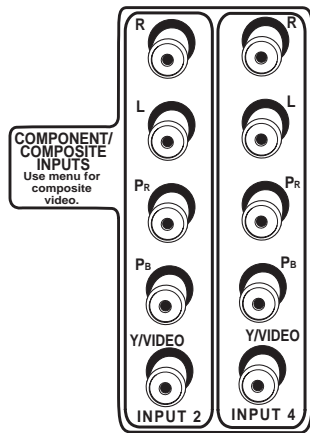

Tip

Inputs 2/4 can be used as either a component video (Y P<sub>B</sub> P<sub>R</sub>) input or a composite video (Y/Video) input. Go to the Connections menu, choose Video Input Setup and select which video input source you are using.

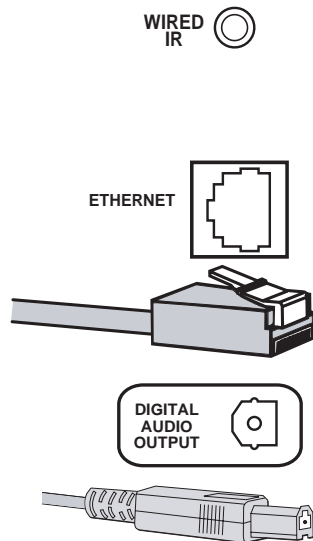

**INPUT 2 COMPONENT/COMPOSITE INPUT** Provides connection to a second NTSC (analog) video component with either composite or component outputs such as a VCR. The R and L Audio jacks are as described previously for INPUT 1.

- R Audio provides right audio connection and connector is usually red.
- L Audio provides left audio connection and connector is usually white.
- Y/Video P<sub>B</sub> P<sub>R</sub> Unlike a single video input, component (Y P<sub>B</sub> P<sub>R</sub>) video maintains the video signal as three separate parts through these three jacks. To ensure maximum picture quality, use three video-grade cables for the Y P<sub>B</sub> P<sub>R</sub> connections. Accepts 480i, 480p, 720p, and 1080i signals. If you're connecting to a component with a Video jack instead, you can still use the Y/Video jack. Go to the *Connections* menu, select *Video Input Setup* and choose *Composite video* as your source. Go to page 64 for more information.

**Notes:** Also, remember to connect the left and right audio cables because the Y, P<sub>B</sub>, P<sub>R</sub> cables carry only the picture signal, not the sound.

PIP can only be displayed from component inputs in 480i format.

**INPUT 4 COMPONENT/COMPOSITE INPUT** Provides connection to a second optional component video source, such as a DVD player or satellite receiver. The jacks are the same as described above for INPUT 2.

**WIRED IR** This jack is for connecting a wired remote control system, which is primarily for professional installers. If you're using the remote that was included with your TV, don't plug anything into this jack or the TV won't respond to the remote.

**ETHERNET** Connect a router, cable modem, or Digital Subscriber Line (DSL) modem to the TV using an Ethernet cable (CAT 5). Do not connect a telephone cable because of risk of fire or shock. A green light on the jack means that an active network has been detected. An orange light on the jack means the data is either being sent or received.

**DIGITAL AUDIO OUTPUT** Use a digital optical cable (or SPDIF cable) to connect your TV to a compatible Dolby Digital\* and/or PCM receiver and/or decoder. Dolby Digital offers theatre-quality sound (six audio channels). If you own a receiver that uses an optical cable input, you can use an optical cable to connect the TV to that receiver for the best sound quality. Go to the *Digital Audio Out* screen in the *Audio* menu to select *Auto Select* or *PCM* as the output for this jack.

**Note:** This TV's optical digital output jack fully complies with the international standard governing this type of jack (IEC958), and is designed for connection to a Dolby Digital (AC-3® or PCM) receiver or decoder. Older equipment, some of which is not fully compliant with IEC958, may not be compatible with the Dolby Digital bitstream. Such a connection using anything other than a Dolby Digital (AC-3 or PCM) receiver or decoder could create a high noise level, causing damage to headphones or speakers.

\*Manufactured under license from Dolby Laboratories. "Dolby" and the double-D symbol are trademarks of Dolby Laboratories.

# Connections & Setup

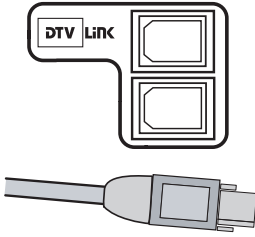

**DTVLink** DTVLink uses a connection and jack better known to some as IEEE-1394 or FireWire®. It is a compressed digital video input/output offering an IEEE 1394-type connection that meets the CEA specifications. This connection is a high-speed way of interconnecting 1394 compliant consumer electronic components. If your 1394 component has the DTVLink logo on it, it should work with this TV. Use either or both connectors to connect compatible DTVLink components but don't loop the components together. When connecting several components, use a hub or component-to-component method. Be sure to connect the fastest of the DTVLink components closer to the connection point of the TV and the slower components furthest away. Details on page 18.

**Notes:** *Audio and video information is carried on a single wire. The TV outputs audio/video through the DTVLink jack only to a component that enforces video copy protection.*

**CableCARD** Allows you to use a digital cable television card to receive digital cable services, including premium and HDTV cable channels, without the need for a set-top box. Go to page 20 for information on using the CableCARD slot.

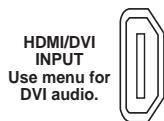
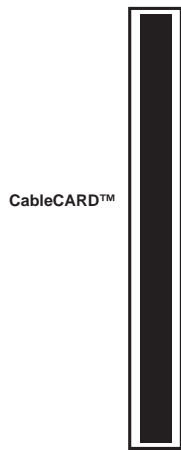

**HDMI/DVI INPUT** (High-Definition Multimedia Interface/Digital Visual Interface) Provides an uncompressed digital interface that carries both video and audio data by way of an integrated mini-plug cable. Since HDMI is based on Digital Visual Interface (DVI) the jack on the back of your TV is compatible with DVI components.

**Note:** *If you connect a component with a DVI jack to the HDMI/DVI input, you'll need an HDMI to DVI adapter. Also, connect the left and right audio cables to an input that is not in use. An example is shown on page 19. Then go to the Audio Connections menu and select DVI Audio Input to choose the input you're using to receive audio.*

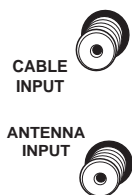

**CABLE INPUT** Used to connect a coaxial cable to receive the signal from cable or cable box.

**ANTENNA INPUT** Used to connect a coaxial cable to receive the signal from an off-air antenna.



## The Front of Your TV

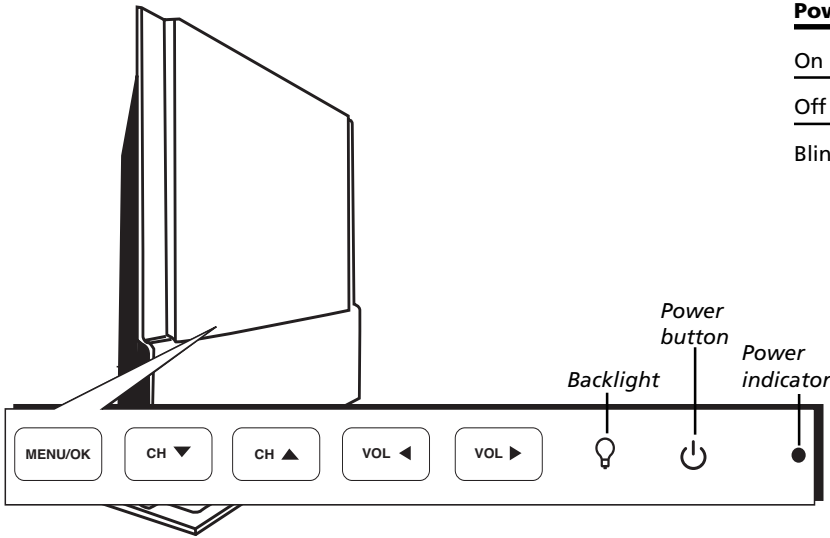

**Notes:** The front panel illustration shows a typical front panel layout. The exact look may be different from the one on the front of your TV.

If you use the Front Button Block feature, the front panel no longer provides access to the menus. The Front Button Block feature disables all front panel buttons. For more information, see Chapter 3.

### Power Indicator Light Status

On	TV is on
Off	TV is off (standby mode)
Blinks	Light blinks 5 times, pauses, and blinks again 5 times: Lamp is trying to turn on. If the TV doesn't turn on after 5 minutes and then the light blinks steadily for one minute, one of the following options is possible:  Lamp door is open. Locate the lamp door on the front of the TV under the front panel piece and close it (go to page 10 on instructions on removing the front panel piece). Turn off the TV and turn back on. The lamp should turn on.  Lamp is dead. You can replace the lamp yourself following the instructions on page 76. Go to page 82 for ordering information.  Lamp power supply within TV may need service. Go to page 84 for warranty information.

## Front Panel Buttons

If you cannot locate your remote, you can use the front panel of your TV to operate many of the TV's features.

**MENU/OK** Brings up the Main menu. When the menu system is displayed, pressing MENU/OK selects highlighted items.

**CH▼** Scans down through the channel list. In the menu system, it moves the highlight down and adjusts menu controls.

**CH▲** Scans up through the current channel list. In the menu system, it moves the highlight up and adjusts menu controls.

**VOL◀** Decreases the volume. In the menu system, it moves the highlight left to items and adjusts menu controls.

**VOL▶** Increases the volume. In the menu system, it moves the highlight right to items and adjusts menu controls.

**💡 (Backlight)** Press to activate backlighting for MENU/OK, CH, and VOL buttons. A few seconds after the last button press, the backlight turns off.

**Note:** Pressing any front panel button also activates the backlight.

**⏻ (Power button)** Turns the TV on and off. The indicator lights when TV is on. Your HDTV's lamp has a cooldown period when the TV is turned off, and a warm up period when the TV is turned on. If you try to turn the TV on during a cooldown, you will hear audio and then the picture will be displayed after a few moments. This could take up to one minute.

**● (Power indicator)** See above for different light status of the indicator. The brightness of the light can be controlled in the Preferences menu. Go to page 70 for more information.

# Connections & Setup

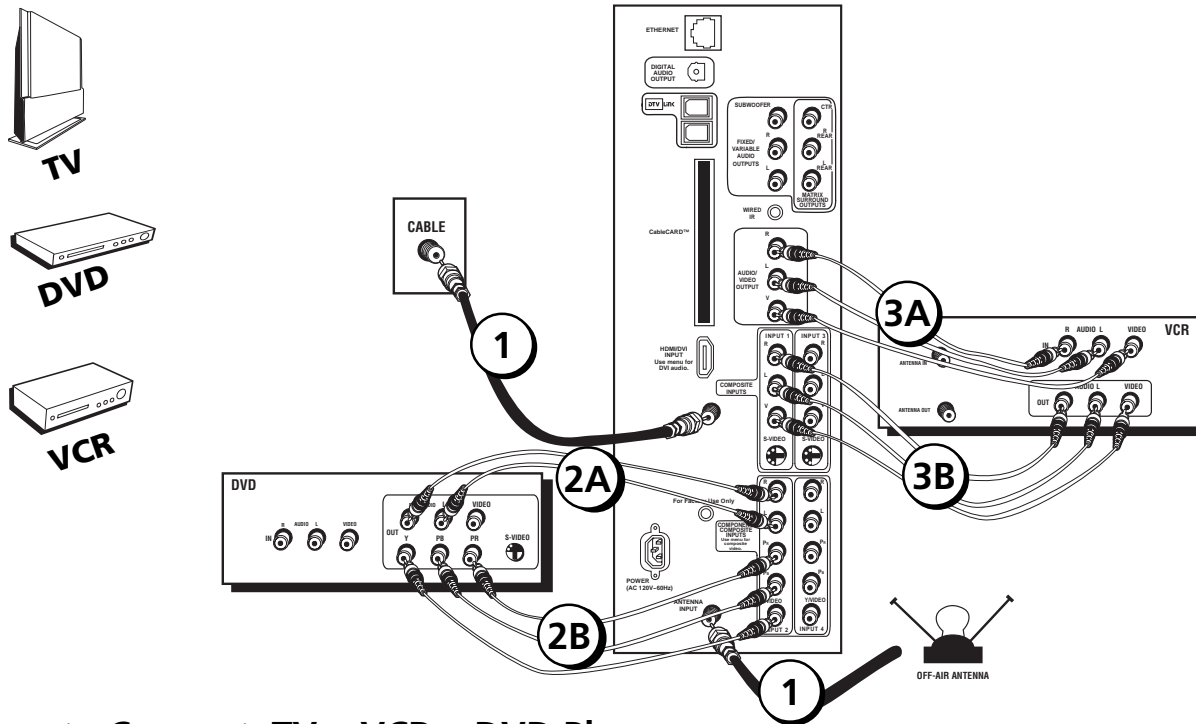

## How to Connect: TV + VCR + DVD Player

### 1. Connect your cable and/or off-air antenna.

If you have cable and an off-air antenna, connect the cable signal to CABLE INPUT. Connect the off-air antenna to ANTENNA INPUT.

### 2. Connect your DVD Player to your TV.

A. Connect the audio (white and red) cables to the INPUT 2 R and L Audio jacks on the back of the TV and to the Audio Output jacks on the DVD player.

B. Connect three video grade cables to the INPUT 2 Y/VIDEO P<sub>B</sub> P<sub>R</sub> jacks on the back of the TV and to the Y P<sub>B</sub> P<sub>R</sub> outputs on the DVD player. If your DVD player doesn't have Y P<sub>B</sub> P<sub>R</sub>, but has composite video and an S-Video output, use the INPUT 3 S-VIDEO jack instead of the V (Video) jack for better picture quality.

**Notes:** If you are using an S-Video cable or component video cables, you must also connect audio cables. The S-Video cable and component video cables only transfer video information.

If your DVD player has a component video output, we recommend you use the component video input on the TV instead of the composite video or S-Video connection.

### 3. Connect your VCR to your TV.

A. Connect the VCR's audio/video outputs to INPUT 1 (R and L-Audio, and V-Video) on the TV using composite audio/video cables.

B. Connect the VCR's audio/video inputs to AUDIO/VIDEO OUTPUT jacks on the TV. This enables recording of digital and analog programs (except copy protected or component video formats).

## Viewing the Components

1. Turn on the TV and the component(s) you want to view.
2. Press the TV button on the remote control.
3. Press the INPUT button on the remote control to scroll through the Video Input Channels.
  - View the VCR on the INPUT 1 channel.
  - View the DVD player on the INPUT 2 channel.

**Note:** You can set up the TV to automatically tune to the correct Video Input Channel. This is called Auto Tuning. (See Chapter 3 for more information.)

Go to page 24

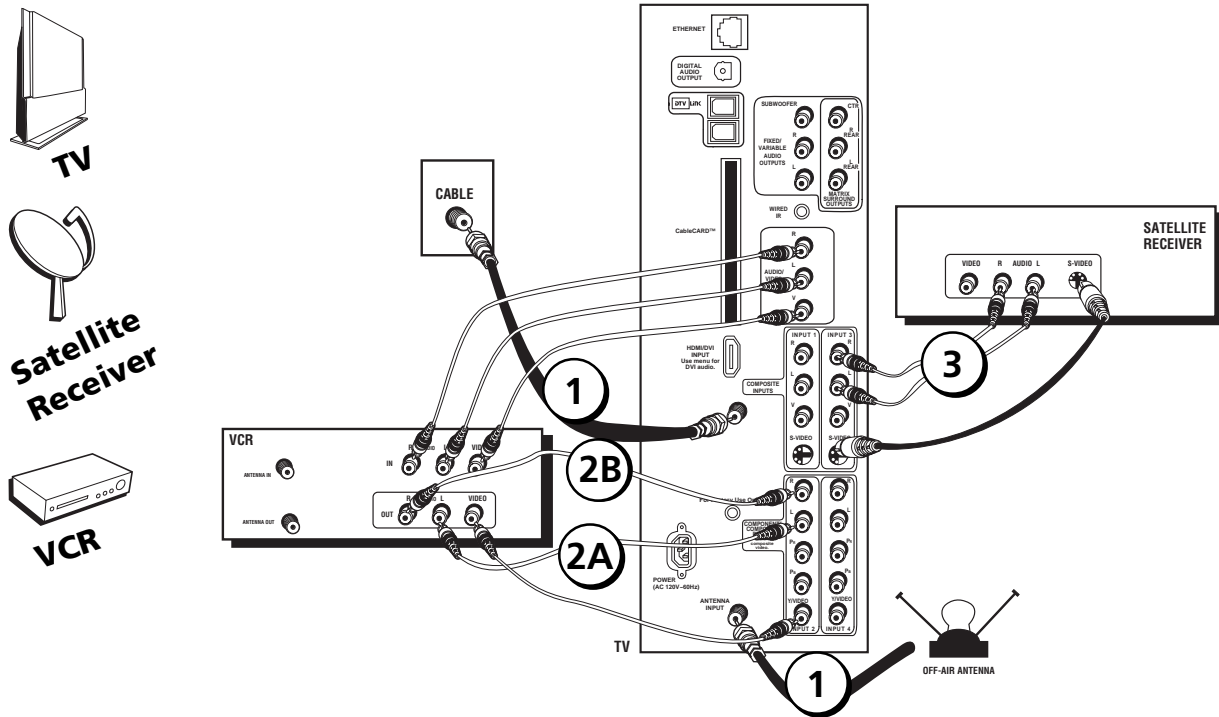

## How to Connect: TV + Satellite Receiver + VCR

### 1. Connect your cable and/or off-air antenna.

If you have cable and an off-air antenna, connect the cable signal to CABLE INPUT. Connect the off-air antenna to ANTENNA INPUT.

### 2. Connect your VCR to your TV.

A. Connect the VCR's audio/video outputs to INPUT 2 (R and L-Audio, and V-Video) on the TV using composite audio/video cables.

B. Connect the VCR's audio/video inputs to AUDIO/VIDEO OUTPUT jacks on the TV. This enables recording of digital and analog programs (except copy protected or component video formats).

### 3. Connect your Satellite Receiver to your TV.

Connect the satellite receiver's audio/video output jacks to the INPUT 3 R and L Audio and S-VIDEO jacks on the TV using audio cables and an S-Video cable. If your satellite receiver doesn't have an S-Video output, you can make the video connection by using the V (Video) jack instead. If your satellite receiver has component outputs, then use INPUT 2 or 4.

*Note: If you are using an S-Video cable or component video cables, you must also use audio cables. The S-Video cable and component video cables only transfer video information.*

## Viewing the Components

1. Turn on the TV and the component(s) you want to view.
2. Press the TV button on the remote control.
3. Press the INPUT button on the remote control to scroll through the Video Input Channels.
  - View the VCR on the INPUT 2 channel.
  - View the satellite receiver on the INPUT 3 channel.

*Note: You can set up the TV to automatically tune to the correct Video Input Channel. This is called Auto Tuning. (See Chapter 3 for more information.)*

**Go to page 24**

# Connections & Setup

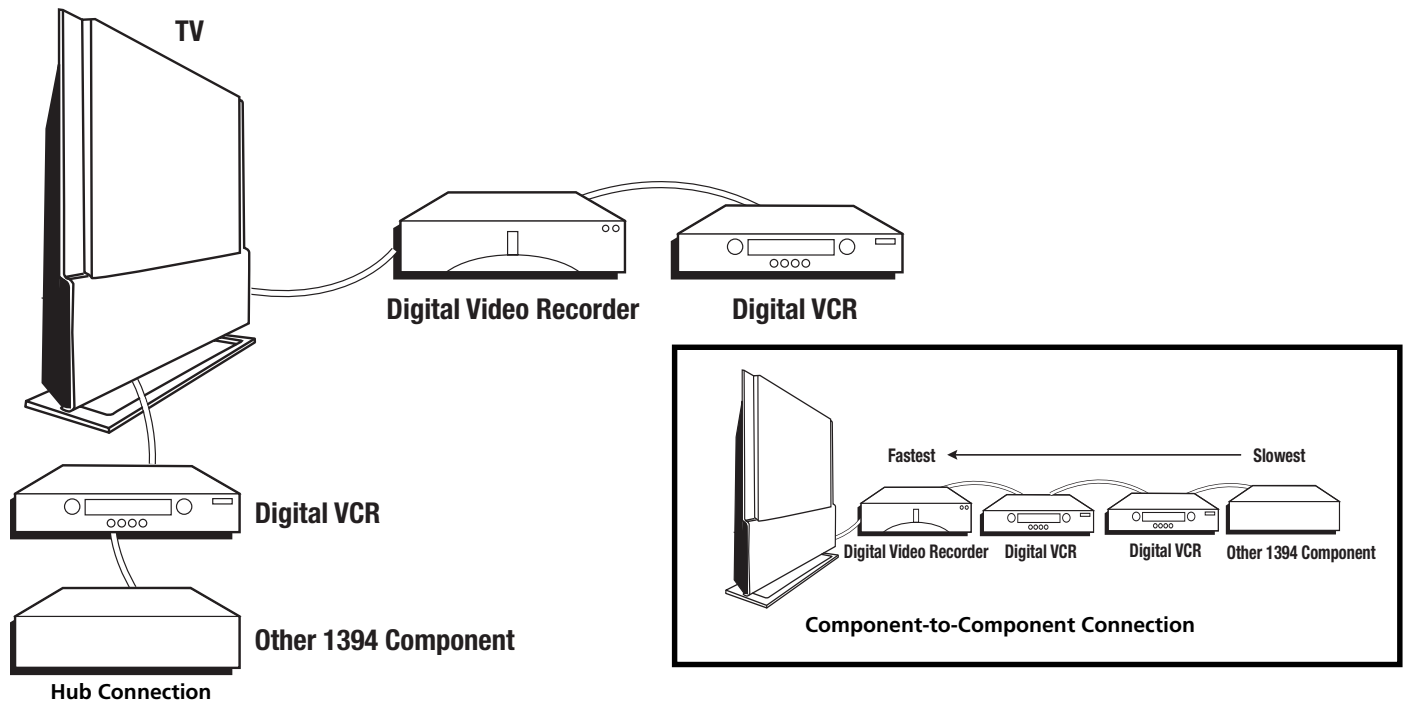

## How to Connect: TV + DTVLink Components

Two connection methods when connecting DTVLink® components are: component-to-component or hub. The component-to-component method is each component connected in a chain-like fashion, one to the other with the first component in the chain connected to the DTVLink jack on the TV. The hub method is basically the same but using both DTVLink jacks with two separate chains of components connected. Your TV is a control center for the connected compatible components, automatically recognizing each component and placing it in the Input list: press the INPUT button until you see the component name in the channel banner at the top of the screen.

**Note:** If you've tuned to a DTVLink input, you can control some basic transport functions on the component like RECORD, STOP, FAST FORWARD, REVERSE, PAUSE, and PLAY when remote is in TV mode.

Three types of 1394 connectors are available on DTVLink components; 4-pin connector (no power); 6-pin connector (with power) and 6-pin connector (without power supplied). Your DTVLink is a 6-pin connector (without power supplied). Both the 4-pin and 6-pin connectors are capable of sending digital audio and video, and digital control signals back and forth between components. If you should have some components with 4-pin connectors, 4-to-6 pin adapter cables are available from your local electronic stores.

### You should know:

- Connect your DTVLink components to either DTVLink jack.
- Only compatible DTVLink components are to be connected to the DTVLink input/output jack.
- Do not loop the DTVLink components back to the TV. That is, each component should have only one connection point to the TV, or the network might not work.
- Place the slower components at the end of the chain and the faster ones closest to the TV in the chain for faster communication speed. See component's manual for 1394 network speed.
- The TV can't decode DV format of some camcorders, but it can decode/accept MPEG2 format from some camcorders.
- Set your DTVLink component in the DTVLink Setup menu for specific recording options. Go to page 65 for more information.

**Note:** The TV sends audio/video through the DTVLink jack only to a component that enforces video copy protection.

**DTVLink® Certification Logo is a U.S. registered mark of CEA.**

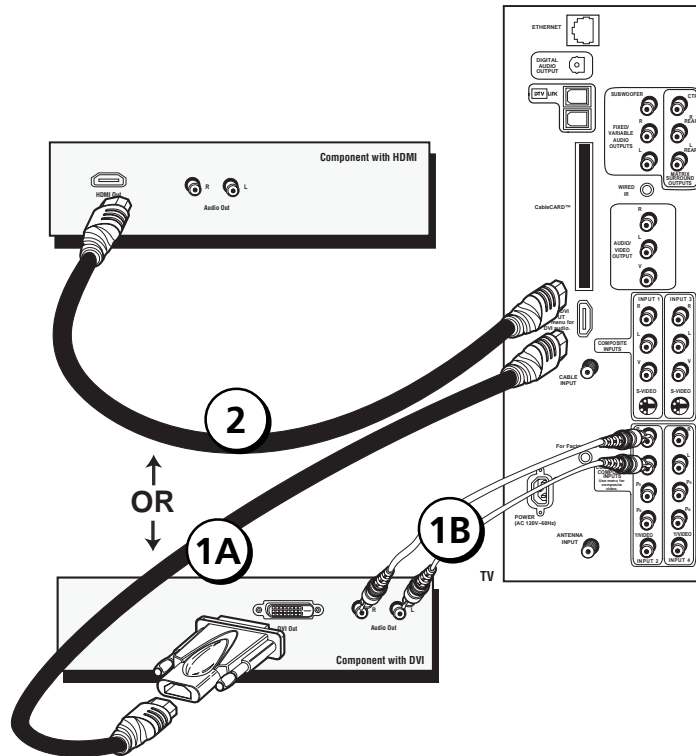

## How to Connect: TV + Component with DVI or HDMI

High-Definition Multimedia Interface (HDMI) is an uncompressed digital interface that carries both video and audio data by way of an integrated mini-plug cable. Since HDMI is based on Digital Visual Interface (DVI), the jack on the back of your TV is compatible with DVI components.

### 1. To connect your TV to a component with a DVI jack, use an HDMI cable and an HDMI/DVI adapter.

A. Connect the HDMI cable to the HDMI/DVI INPUT jack on the back of the TV. Attach the HDMI/DVI adapter to the end of the HDMI cable, then connect the adapter to the DVI Out jack on the back of the component.

B. Since you're using an HDMI/DVI adapter, you need to connect Audio left and right cables to the R and L jacks on the back of the component and to R and L Audio jacks that aren't in use on the back of the TV.

C. Go to the *DVI Audio Input* option in the *Audio Connections* menu to select which Audio Input you're using.

### 2. To connect your TV to a component with an HDMI jack, use an HDMI cable.

Connect the HDMI cable to the HDMI/DVI INPUT jack on the back of the TV and to the HDMI Out jack on the back of the component.

## Viewing the Component

1. Turn on the TV and the component you want to view.
2. Press the TV button on the remote control.
3. Repeatedly press the INPUT button on the remote control until the HDMI Video Input Channel is selected.

**Note:** You can set up the TV to automatically tune to the correct Video Input Channel. This is called *Auto Tuning*. (See Chapter 3 for more information.)

# Connections & Setup

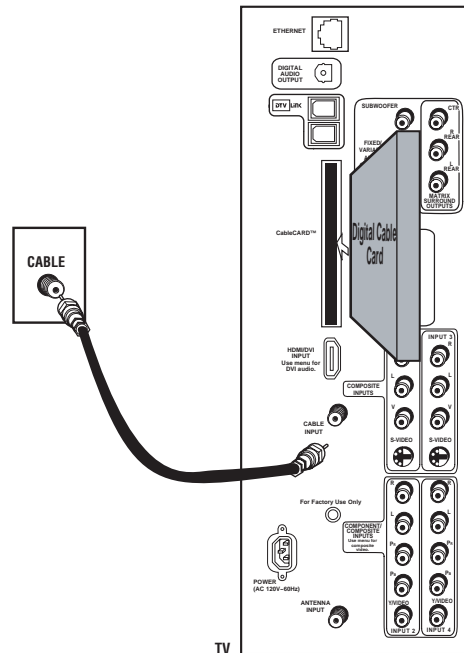

*FCC Statement: This digital television is capable of receiving analog basic, digital basic and digital premium cable television programming by direct connection to a cable system providing such programming. A security card provided by your cable operator is required to view encrypted digital programming. Certain advanced and interactive digital cable services such as video-on-demand, a cable operator's enhanced program guide and data-enhanced television services may require the use of a set-top box. For more information, call your local cable operator.*

## How to Connect: TV + CableCARD

The CableCARD slot allows you to use a digital cable television card to receive digital cable services, including premium and HDTV cable channels, without the need for a set-top box. Please contact your local cable company for availability of services and to obtain a digital cable television card.

When you receive the digital cable card, make sure you connect your coaxial cable to the CABLE INPUT jack. Then, turn on your TV. Insert the digital cable card into the slot on the back of the TV labeled CableCARD. Push firmly on the card until almost the entire card is inserted. Wait to receive information on-screen regarding your digital cable television services. See below for information on setting up digital cable television services for your TV.

### You should know:

- Once the digital cable card is authorized for a particular TV, the card can't be used with any other TV, unless it is re-authorized to it.
- You won't receive digital cable channels if you connect your cable to the ANTENNA INPUT. Make sure you connect your cable to the CABLE INPUT.
- Once inserted, it is not recommended you remove the digital cable card. In the case it needs to be removed, grasp firmly, and pull the card straight out.

## Setting Up Digital Cable Television Service

Once you have connected a digital cable card to the CableCARD slot on the back of the TV (explained above), you are ready to receive digital cable channels. Wait approximately 30 seconds for the status screen to appear. Write down the information you see and call your cable company to provide them with the information on-screen.

**Notes:** *If your information screen disappears before you have a chance to write down the information, press MENU on the remote to access the menu system. Then press 9, 9, 9, and the information screen appears. Go to page 66 for more information on the CableCARD Tools menu.*

*You can't order video-on-demand through your digital cable card. Call your local cable company to place an order.*

## Audio Connections

With the audio versatility of your HDTV, you can choose various connection options depending on the type and quality of sound that you want. From good to best sound, choose one of the options or refer to the user's manual of each component that you are connecting to get the best results.

- Use your TV's internal speakers (good sound).
- Connect audio/video receiver (speakers connected to receiver) to your TV (better sound).
- Connect audio/video receiver (speakers connected to receiver) using the digital audio output jack to your TV (best sound).

## How to Connect: TV + A/V Receiver + Speakers

1. Connect the FIXED/VARIABLE AUDIO OUTPUTS from the TV to an A/V receiver using audio cables for 6-channel matrix surround sound.
2. Be sure to go to the *Fixed/Variable Out* screen in the *Audio Connections* menu and select whether you want the FIXED/VARIABLE AUDIO OUTPUT jacks to send fixed volume audio or variable volume audio.
  - *Fixed Output* provides fixed-level audio output from the TV. This audio output is ideal for connecting to an A/V receiver that has its own volume control.
  - *Variable Output* provides variable-level audio output. Volume levels are controlled by the volume controls on the TV and TV remote control.
3. If you connect the SUBWOOFER jack, be sure to go to the *Fixed/Variable Out* screen in the *Audio Connections* menu and select *Yes* for connecting to an external subwoofer.
4. Use speaker wire to connect the Audio/Video receiver to external front and rear speakers. Refer to your audio receiver manual to complete speaker hookup to the receiver.

**OR**

## How to Connect: TV + Receiver with Dolby Digital + Speakers

If you own a receiver with Dolby Digital and/or PCM (Pulse-Code Modulation) that uses an optical cable-type input, connect an optical cable for excellent audio quality (shown on opposite page).

1. Connect one end of the optical cable to the DIGITAL AUDIO OUTPUT jack on your TV to the Digital Optical Input jack on your receiver/amplifier receiver.
  - If your receiver can decode Dolby Digital and PCM, go to *Audio* menu, select *Audio Connections*, then *Digital Audio Output*. Select *AutoSelect* (recommended) or *PCM* option.
  - If your receiver can decode only PCM, select *PCM* option.
2. Use speaker wire to connect the Audio/Video receiver to external front and rear speakers. Refer to your audio receiver manual to complete speaker hookup to the receiver.

# Connections & Setup

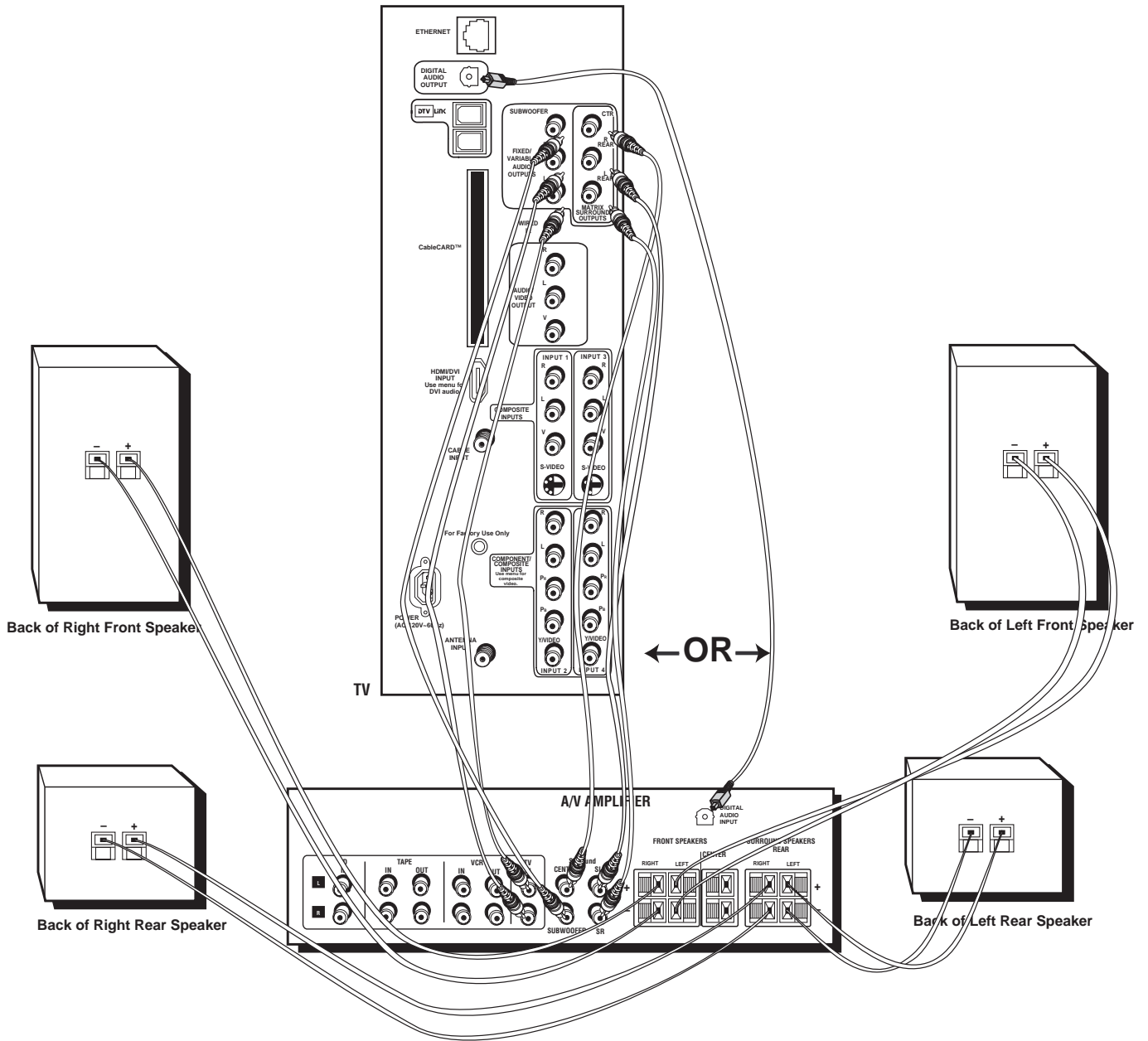



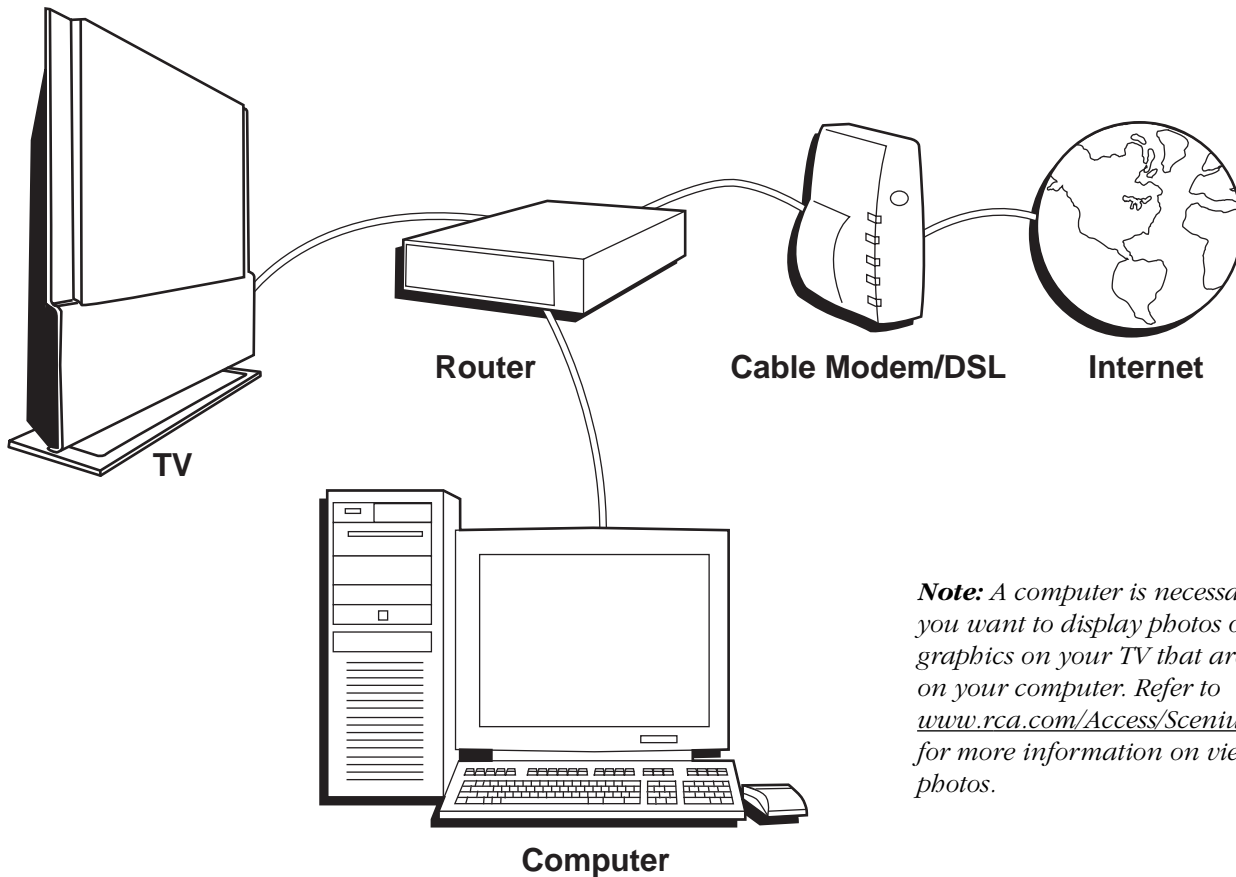

**Note:** A computer is necessary if you want to display photos or graphics on your TV that are stored on your computer. Refer to [www.rca.com/Access/Scenium/311](http://www.rca.com/Access/Scenium/311) for more information on viewing photos.

## **How to Connect: TV + Router via the HDTV's ETHERNET Jack**

The illustration above provides you with a general connection to the TV's ETHERNET jack so you can maximize your HDTV's browser to surf the Internet. You don't need to connect a computer to surf the Internet. A computer is only needed if you want to view photos or graphics on your TV that are stored on your computer (then you don't need cable modem/DSL or Internet access). An Internet Service Provider subscription is necessary to access the Internet.

### **You should know:**

- Only use the Ethernet connection if you are connecting a router to the TV's ETHERNET jack.
- It is highly recommended that the router have DHCP capability.
- The keyboard is needed to effectively surf the Internet via your HDTV's internal web browser and to enter names of websites.
- A router enables you to network several components, such as a computer, cable modem, or DSL modem. You'll need to set up each component that is connected to the router. Use the manuals that accompany your router and other Internet components for specific instructions.

To connect the router to the TV, use a CAT5 cable (not provided) to connect the ETHERNET Input Jack on the back of your HDTV to the ETHERNET Output Jack on the router.

The complexity of the setup required to make all of the components and the router work with your HDTV depends upon your Internet Service Provider (ISP). Most ISPs will automatically fill in the information needed during setup, but if you are asked for specific information while setting up the router and other components you will need to contact your ISP. Go to the *Ethernet Setup* menu on page 66 for more information on the Ethernet setup.

# Connections & Setup

## Plug in the TV

Plug the flat end of the power cable into the power jack on the side of the TV. Go to page 10 for instructions on removing the jack panel door. Then plug the other end of the power cord into an appropriate wall outlet. Be sure to insert the plug completely. Do not plug into an outlet controlled by a light switch.

**Note:** When you first plug your TV into an outlet, the Power indicator and Backlight on the front panel will light and blink for approximately 30 seconds and then go off during the initialization of the TV. The TV can only be turned on after the Power indicator goes off. This happens every time the TV is unplugged and plugged back in.

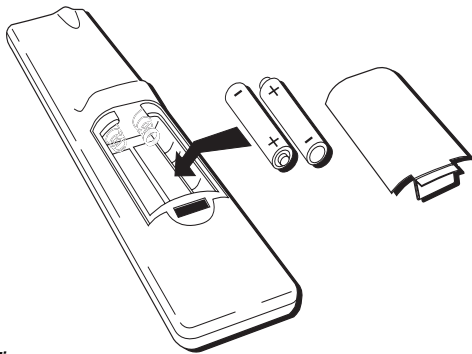

### Tip

When remote batteries are low, the component button(s) corresponding to the mode you're in flashes when you press a button. Also, a message might appear on the TV screen and disappear within a few seconds. Press CLEAR and replace the batteries to remove the message.

## Put Batteries in the Remote

- Remove the battery compartment cover from the back of the remote by pushing down on the tab and lifting cover.
- Insert 2 fresh “AA” batteries. Make sure the polarities (+ and -) are aligned correctly with the polarities inside the remote.
- Replace the cover.

## Turn on the TV

Press TV on the remote, or press the Power button on the TV's front panel.

**Note:** Pressing the TV button turns on the TV and puts the remote into TV mode. “TV mode” means that the buttons on the remote control operate the TV's functions.

## Use the Remote Control to Complete the Assisted Setup

The technical term is “Navigation” – how you move through the on-screen menus. The method is the same throughout the menu screens: highlight your choice and select it.

To highlight a menu item, put the remote into TV mode by pressing the TV button then MENU. Press the arrow buttons on the remote to highlight one of the items listed in the menu. Use the up or down arrow button to move up or down. Use the right or left arrow button to move right or left.

To select the item that you've highlighted, press OK.

**Note:** Highlighted means that the menu item stands out from other menu items on the list (appears darker, brighter, or a different color).

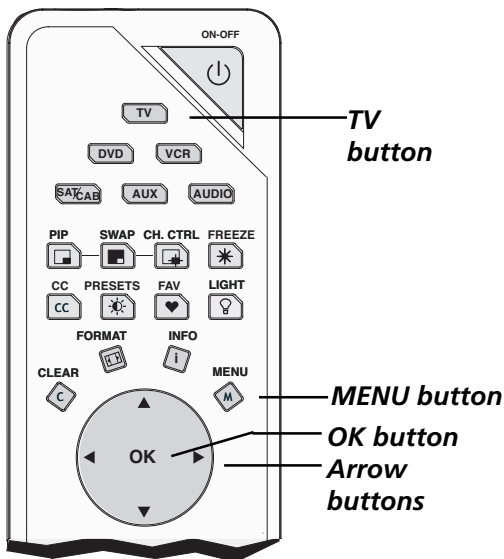

### Tip

To access the setup menus, press MENU and choose Assisted Setup.

## Complete the Assisted Setup

Your TV's menu system allows you to adjust your TV's features to be configured to work properly. On-screen information helps you choose settings to match your setup. The first time you turn on your TV, the *Assisted Setup* screens appear automatically. Select *Begin Setup* to start or select *Cancel Setup* to exit.

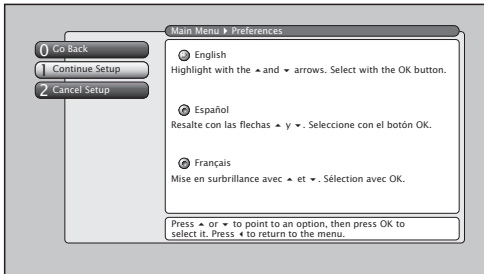

### Set the Menu Language

1. Use arrow buttons to highlight your preferred language for the menu system.
2. Press OK to select that language.
3. Press the left arrow button and the up or down arrow button, if necessary, to select *Continue Setup*, then press OK.

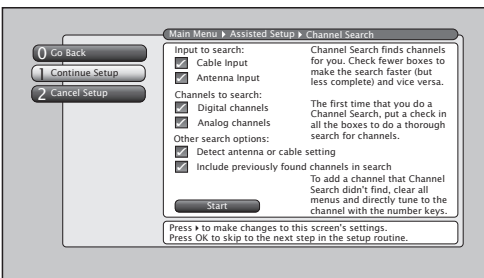

### Complete Channel Search

Even though this initial channel search can take several minutes, it is important to complete in order for your TV to display channels and programming. Make sure you have connected cable and/or off-air antenna to the corresponding inputs before you start channel search.

1. To do a complete channel search, check each box that pertains to your TV. For example, if you're only receiving cable from the CABLE INPUT, highlight *Cable Input* and press OK to place a checkmark in the box.
2. Select *Start* to begin the search.
3. When the channel search is complete, a message screen appears. Select *Continue*. Another message screen appears telling you that you've completed the Assisted Setup. Select *Continue* on the left.

**Notes:** *If you skip Channel Search now, you can access it later through the Connections menu. See Chapter 4 for more details.*

*If a cable box is connected to your TV's CABLE INPUT or a CableCARD is in use, Channel Search won't work for Cable Input.*

#### Tip

*The first Channel Search takes several minutes if the TV is searching for analog and digital channels and cable and antenna inputs are being searched. You may want to leave and come back later.*

*This page intentionally left blank*

# Using the Remote Control

## Chapter Overview:

- The Buttons on the Remote Control
- Programming the Remote to Operate Other Components
- How To Use the Remote After You've Programmed It
- The Learning Feature
- Volume Punchthrough Feature
- Using the INPUT Button
- Remote Code List

SCENIUM

# Using the Remote Control

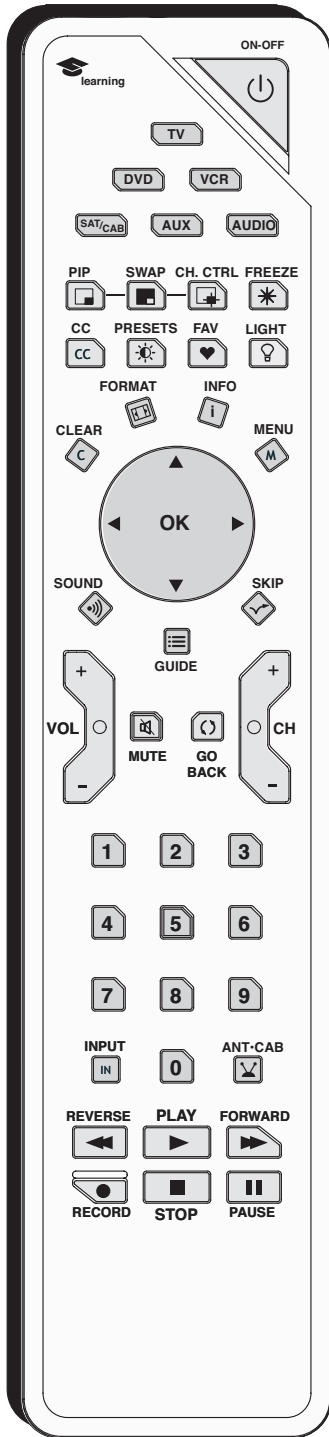

## Tips

The VCR, DVD, AUDIO and SAT/CAB buttons also turn on most RCA, GE, and Proscan products.

Some remote buttons can be used with the Web Browser and have different functions; see page 51 for details.

## The Buttons on the Remote Control

**Arrows (up, down, left, right)** Used to move through the on-screen menus. Also moves the PIP window, see page 48 for more information.

**(0-9) Number Buttons** Enter channel numbers and time settings.

**ANT•CAB** Switches between Antenna and Cable Input. In VCR mode, functions as a TV/VCR button. In SAT mode, functions as a TV/SAT button for an RCA satellite receiver. When tuned to an input, press to go back to the most recently used tuner (Antenna or Cable Input).

**AUDIO** Places the remote in audio mode to operate a component (such as a audio receiver, CD player, or amplifier receiver) that you've programmed to work with this button.

**AUX** Places the remote in auxiliary mode to operate a component (such as a cable box, satellite receiver, VCR, DVD, or audio receiver) that you've programmed to work with this button. AUX by default is set up for a second RCA VCR.

**CC (Closed Captioning)** Toggles closed captioning on and off, if available for the channel you're tuned to. When you change channels or inputs, the default for Caption Display is restored.

**CH + or CH -** Scrolls up or down through the channel or input list. Press once to change the channel up or down; press and hold to continue changing channels.

**CH CTRL (Channel control)** Toggles the channel control between the main TV picture and the PIP window. Use channel up, channel down, INPUT, component buttons, or number buttons to change channels in PIP. CH CTRL is marked by a triangle (▷) in the banner.

**CLEAR** Removes on-screen menus and displays. Cancels the commercial skip timer. Quits the browser.

**DVD** Places the remote in DVD mode. If Auto Tuning is enabled, pressing the DVD button turns on the TV and tunes to the correct Video Input Channel.

**FAV (Favorite)** Press this button and a number button (0-7) to activate a favorite webpage. See *Using the Web Browser* for more information.

**FORMAT** Toggles through the 4:3 video screen formats (Normal, Zoom, Stretch, Cinerama, and Auto Format) for some 4:3 signals—not applicable to 16:9 signals. In browser mode, toggles through three different modes: full-screen browser, video window on the left, and video window on the right.

**FREEZE** Freezes entire screen, including the main picture and PIP window, if PIP is displayed. When recording from AUDIO/VIDEO OUTPUT, freezes digital, but not analog channels. Does not affect DTVLink output.

**GO BACK** Returns you to the previous channel or previous screen in the menu system. Also, toggles between tuner and input sources.

**GUIDE** If you're controlling another component that has a guide, this accesses the on-screen guide.

# Using the Remote Control

---

## Tips

The component button corresponding to the mode you're in flashes when the remote batteries are low and you press a button on the remote. A warning banner may also appear on the screen when you press a remote button and your batteries are low.

To turn off most RCA, GE, and Proscan components that are connected to the TV, press ON•OFF twice within two seconds and hold remote steady until indicator turns off.

**INFO** Brings up the Channel Banner with channel and viewing information. Press again to remove the banner.

**INPUT** Toggles through the TV's available input sources (INPUT 1, INPUT 2, INPUT 3, INPUT 4, HDMI/DVI, DTVLink and last-active channel). To quickly access an input, press the INPUT button and the input number, for example, INPUT + 1 to access INPUT 1.

**LIGHT** Press to illuminate the remote control's buttons. To conserve battery power, the light turns off after several seconds. Backlight won't activate if batteries are low, but blinks on and off quickly.

**MENU** Makes *Main Menu* appear and disappear.

**MUTE** Reduces the TV's volume to its minimum level. Press again to restore volume. The TV's *Audio Output* menu must be set to *Variable Level, Speakers On* to control the TV's volume.

**OK** When a menu item is highlighted, press OK to select the item.

**ON•OFF** Turns the TV on or off. Your HDTV is equipped with a special lamp system. In order to preserve the life of the lamp, the TV must warm up and cool down properly when you turn the TV on and off. When you turn the TV off, the screen turns blue and fades to black. While the screen is blue, you can still turn the TV back on. If the screen is black when you try to turn it on, the TV's lamp is in its cool-down cycle. The TV's audio comes on, then the picture is displayed after a few moments.

In other modes (VCR, DVD, SAT/CAB, AUX, AUDIO), and if programmed, turns the component on and off.

**PIP** Makes the PIP window appear and disappear (See Chapter 3 for more information about using PIP.)

**PRESETS** Toggles through the Picture Presets for the input currently tuned to. The preset is only temporarily changed and goes back to the original menu setting when you change channels or inputs or turn off the TV.

**REVERSE, PLAY, FORWARD, RECORD, STOP, PAUSE** If programmed, provides transport control for some remote-controllable VCRs and CD and DVD players. In TV mode, can control a DTVLink component when tuned to the DTVLink input.

**SAT/CAB (Satellite/Cable)** Places the remote in SAT/CAB mode. If Auto Tuning is enabled, turns on the TV and tunes it to the correct Video Input Channel.

**SKIP** Press once before changing channels and the TV returns to the original channel after 30 seconds. Press repeatedly to add more time. Press CLEAR to cancel.

**SOUND** On digital channels/inputs, toggles the audio mode (if available for that channel). For analog channels, toggles SAP on or off. If you change channels/inputs, the default for Audio Mode or SAP is restored. Does not affect default menu settings for *SAP* or *Audio Mode*.

**SWAP** When using PIP, switches the main picture with the PIP window.

**TV** Places the remote in TV mode. Turns on the TV and tunes to the last-viewed TV channel or input.

**VCR** Places the remote in VCR mode. If Auto Tuning is enabled, turns on the TV and tunes to the VCR Video Input Channel.

**VOL – or VOL +** Decreases or increases the TV's volume. The TV *Audio Output* menu must be set to *Variable Level, Speakers On* to control the TV's volume.

# Using the Remote Control

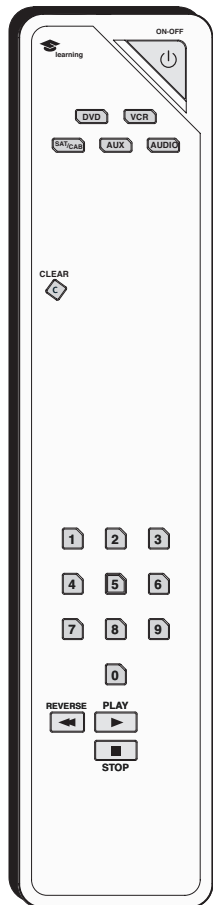

You'll use these buttons when you program the remote for other components.

**Important Note:** The remote may not be compatible with all models of all brands of components. It also may not operate all functions of your component.

## Tip

By default, the AUX button is programmed for a second RCA VCR. If auto tuning is set up, it will tune to VCR2 input channel.

## Programming the Remote to Operate Other Components

The universal remote can be programmed to operate many brands of remote-controllable VCRs, audio components, DVD players, cable boxes, satellite receivers and other components. In addition to being programmed to operate your television, it's already programmed to operate most RCA, GE, and Proscan components.

The AUX button can be programmed to operate most brands of an additional remote-controllable component: satellite receiver, cable box, DVD, VCR, and an audio component. A second and third RCA TV can be programmed to any component button, except the TV button. Go to page 66 for more information on programming the remote to another TV.

**Note:** The TV button can't be programmed on this remote to control any component; it controls only this TV.

## Find Out If You Need to Program the Remote

To determine whether the universal remote needs to be programmed to operate one of the components connected to your TV, such as a VCR, do the following:

1. Turn on the component (in this example, a VCR).
2. Point the remote at the component.
3. Press the corresponding component button (in this example, VCR).
4. Press ON•OFF to see if the VCR responds. If the VCR doesn't respond, you need to program the remote to operate it.

## Programming the Remote

There are two ways to program the remote control to operate other components: *Automatic Code Search* and *Direct Entry*.

### Using Automatic Code Search

**Note:** The AUX button can only search VCR codes, but can be used for a non-VCR device by programming it with direct entry method.

The following instructions can be used to program the remote to operate each of your components. If you want to stop the automatic code search without programming any of your components, press and hold CLEAR until the indicator on the remote turns off.

1. Turn on the component you want to operate (VCR, DVD player, etc.)
2. Press and hold the component button you want to program (VCR, DVD, etc.). While holding the component button, press and hold ON•OFF until the component button on the remote turns on, then release both buttons.
3. Point the remote at the component.



4. Press and release PLAY, then wait 5 seconds or until the component button stops flashing.

At this point the remote is searching for the correct code to program. If, after 5 seconds, the component you want to operate does not turn off, press PLAY again to tell the remote to search the next set of codes.

Continue pressing and releasing PLAY until the component turns off or you have searched through all of the codes. The component buttons flash when all codes have been searched, the component button turns off, and remote exits Automatic Code Search.

If the component you want to control *does* turn off:

1. Press and release REVERSE, then wait 2 seconds. Repeat this step until the component turns back ON.
2. To finish, press and hold STOP until the component button on the remote turns off.

## Using Direct Entry

1. Turn on the component you want to operate (VCR, DVD player, etc.)
  2. Look up the brand and code number(s) for the component on the code list in this section.
  3. Press and hold the component button you want to program on the remote.
  4. Enter the 4-digit code from the remote control code list on the following pages. If the indicator flashes, you have either entered an invalid code or the button isn't programmable.
  5. Release the component button, point remote at component, and then press ON•OFF to see if the component responds to the command. If it doesn't, try pressing the component button and then ON•OFF again.
- If you get no response, repeat these steps using the next code listed for your brand, until the component responds to the remote commands.
  - If you try all the codes for your component brand and none work, try the automatic code search method. If automatic code search doesn't find the code, the remote is not compatible with your component.

## How to Use the Remote After You've Programmed It

Because this universal remote can control several different components (TV, DVD, VCR, satellite receiver, etc.), it uses operational modes triggered by the component buttons.

1. Press the appropriate component button (DVD, TV, VCR, SAT/CAB, AUDIO, AUX) to set the remote to control the component.
2. Press ON•OFF to turn the component ON or OFF.
3. Use the remote buttons that apply to that component.

**Notes:** *The remote control may not be compatible with all brands and models of components.*

*If you keep pressing buttons and nothing happens, the remote is probably in the wrong mode. You must press the component button that matches the component you want to operate (i.e., if you want to operate the VCR, press VCR on the remote control to put the remote in VCR mode.)*

# Using the Remote Control

---

## The Learning Feature

Before using the learning feature, make sure this TV's remote control is programmed to control other components you have connected to the TV. Programming the remote control erases all learned commands for that component mode.

After you program the TV's remote control to operate the other component, the TV's remote provides most of the operations you need. However, there may be some functions on the component's original remote control that your TV's remote control doesn't have. For example, your DVD remote control might have an ANGLE button that enables you to change the angle of the picture, but your TV remote doesn't have that button. The learning feature enables you to record the functionality of a specific button from the original remote control to one of the TV's remote control buttons.

**Note:** All learned functions for a mode can be erased if you program a different component to that mode.

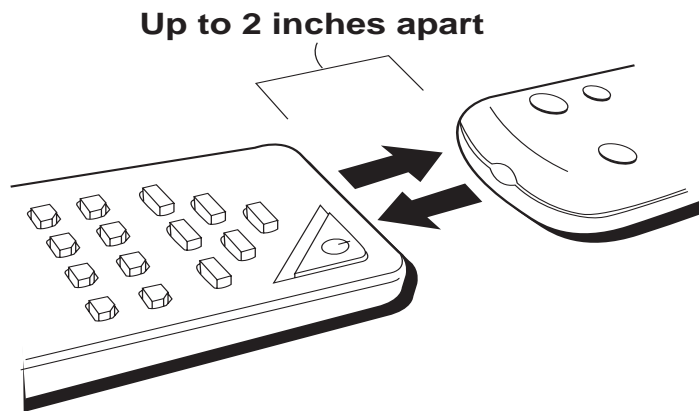

## Adding a Learned Function

There are several things to consider before you begin the learning process:

- You can't record a learned function to the following buttons on the TV's remote control: component buttons (TV, VCR, DVD, SAT/CAB, AUX, and AUDIO), the CLEAR button, and the LIGHT button.
- Before adding a Learned Function, you must program this TV's remote control to operate that component because programming the remote control erases all learned commands for that component mode.
- Do the learning process in low light areas because too much natural light or fluorescent light might cause the learning feature to fail because the remote control functions are recorded (learned) by sending infrared (IR) signals.
- The TV's remote and the original remote should be no more than 2 inches apart.
- In order to record (learn) a function from one remote to the other, you must make sure the Infrared (IR) transmitter of the original remote is facing the IR receiver on the top of the TV's remote (see illustration). To accomplish this, you may have to hold a remote in each hand instead of laying both on the table.
- The learned buttons are mode specific—if you add a button function from your DVD player's remote control, you must press the DVD button first before the learned function will work (in TV mode, the button where you've stored the learned function will continue to work as it always has).

# Using the Remote Control

---

1. Press and hold the component button on the TV's remote that applies to the function you will be adding (DVD, VCR, SAT/CAB, AUDIO, or AUX). The component button lights.
2. On the TV remote, press and hold the RECORD button.
3. Keep pressing both of the buttons (the component button and the RECORD button) until the component button light turns off, flashes, and turns off. Release both buttons.
4. On the TV's remote control, press and release the button where you want to store the new function (the component button turns off and then back on).

**Note:** *If you press an invalid button on the TV remote, the component button flashes 4 times to alert you. You'll have to repeat step 4.*

5. With the remote controls facing each other and no more than 2 inches apart, press and hold the button of the component's remote control that has the functionality you are recording to the TV's remote control. Keep pressing the button until the TV remote's component button light turns off and back on (the function has been saved to the TV remote). If all component buttons flash 4 times, the function wasn't learned. Try again starting with Step 4.
6. The TV remote control remains in "learning mode" so you can continue adding functions to different buttons by repeating steps 4 and 5. Or, press CLEAR to exit learning mode.

**Notes:** *If you want a new function on a button, you must record (learn) over it.*

*The amount of memory each learned function uses in the TV's remote control varies. If your TV remote is out of memory, the component button(s) light flashes 4 times and turn off, exiting you from the Learning mode.*

## Clearing a Learned Function

To delete a learned button function, use the procedure below.

1. Press and hold the component button (the component button lights). Then press and hold the CLEAR button for 3 seconds. Continue depressing both buttons (the component mode button flashes—turns on and off again).
2. Release the component and CLEAR buttons (the component button being programmed turns on). Remote is now in Clear learned function mode.
3. Press and release the button where learning is to be cleared. The component button blinks off then back on—the learned function was cleared successfully.
4. Repeat steps 1 through 3 until all buttons' learned functions have been cleared.

**Note:** *If an invalid button is pressed, the component mode button(s) flashes 4 times and the selected component button stays on and remote remains in Clear Learned Function mode. Repeat step 3.*

5. Press the CLEAR button and your TV remote returns to its original operation mode.

## Deleting ALL Learned Functions

This procedure erases all learned functions in every component mode of the remote.

1. Press and hold the CLEAR button (the current component button lights). Then press and hold the ON•OFF button (component button light turns off for 3 seconds, flashes, turns on and off) while continuing to hold CLEAR.
2. Release both buttons (current component button turns on).
3. Press any component button to delete all learned functions in all modes. Remote is automatically exited from this mode.

**Note:** *Pressing the CLEAR button will NOT delete all learned functions, but will exit the Delete mode.*

# Using the Remote Control

---

## Volume Punchthrough Feature

You may find this feature helpful if you've connected your components to an audio/video receiver (A/V receiver) or amplifier, but you want to use the TV's remote control to operate the volume for a component that is connected to the audio/video receiver. An example follows:

Let's say you've connected your DVD player to your audio/video receiver. You've also programmed your TV remote control to operate your DVD player. Since the DVD player gets its volume through the audio/video receiver, you would have to bounce back and forth between two remote controls: the A/V receiver's remote to adjust the volume and the TV's remote control to operate the DVD player.

The Volume Punchthrough feature eliminates the need for you to use two remote controls and saves a button press when you're using the TV remote to adjust the volume. In effect, you are telling the TV remote to retrieve and send volume commands from the a/v receiver whenever the TV remote is in DVD mode.

Therefore, after you've successfully set up the Volume Punchthrough feature, whenever the TV remote is in DVD mode (press the DVD button) and you want to adjust the volume, you only have to press the VOL + or VOL- buttons. Follow the instructions below to set up Volume Punchthrough.

1. **IMPORTANT:** First, you must program the AUDIO button on the TV's remote control to operate your audio receiver or amplifier. Go to page 30 for instructions. If you can't program this remote to operate your audio receiver, Volume Punchthrough won't work.
2. While setting up Volume Punchthrough, it's best to point the remote away from components.
3. Decide which mode the remote will be in when the volume from the audio receiver "punches through." The mode will be one of the component buttons (TV, DVD, SAT/CAB, VCR, or AUX).
4. Press and hold the VOL- button. Keep pressing VOL- while you press and release the component button you chose in step 3 (TV, DVD, SAT/CAB, or AUX).
5. Press and release the AUDIO button since the sound will be coming from the audio/video receiver. Release the VOL- button.
6. Now, test it by turning on your audio receiver or amplifier.
7. Turn on the component that is connected to the audio/video receiver or amplifier (a DVD player, for example).
8. Put the TV's remote in DVD mode by pressing the DVD button, and play a disc.
9. Press VOL+ or VOL-. The volume from the audio receiver should increase or decrease accordingly.

## Deleting ALL Volume Punchthrough Commands

To delete all programmed Volume Punchthrough settings and return the remote control back to the factory defaults, press and hold the VOL- button (the component button of the Volume Punchthrough lights). While holding the VOL- button, enter the code, **000**, using the number buttons. All component buttons turn on for 2 seconds and then turn off. The remote returns to the factory settings.

***Note:** If an invalid button is pressed, all component buttons blink 4 times and turn off. At this point, you must start over.*

# Using the Remote Control

Input source



**Note:** Watch the Channel Banner to see the input sources change each time you press the INPUT button.

## Using the INPUT Button

1. Repeatedly press the INPUT button to scroll through the available input sources until you find the input associated with the component (such as VCR or DVD player) you want to view.
2. Once you find the input source you want, stop pressing INPUT.
  - If you tune to INPUT 1 and your VCR is connected to that input, you will be able to view your VCR. To play, stop, or rewind the VCR tape using the remote that came with your TV, you must first press the VCR or AUX button (whichever one is programmed to the VCR) to put the remote control in VCR mode.

There are other ways of selecting a Video Input Channel:

- Program the component (VCR, DVD, etc.) buttons on the remote control to automatically tune to the correct Video Input Channel when pressed. For more details on Auto Tuning, see Chapter 3.
- When viewing an input, press ANT/CAB, GO BACK, or INPUT to go back to viewing channels or use the number buttons to enter the channel number.
- To quickly access an input, press the INPUT button and the input number, for example, INPUT + 1 to access INPUT 1. **Note for professional installers:** This is a discrete input code.

## Remote Code List

### Audio Codes

Programmable for the AUDIO and AUX buttons.

#### AUX/Dimensia/Lyra Wireless

RCA ..... 4004

#### Audio Cassette

GE ..... 4006

RCA ..... 4006

#### CD Players

ADC ..... 4055, 4056, 4066

Aiwa ..... 4039, 4057

Akai ..... 4058

Denon ..... 4060

Emerson ..... 4040

Fisher ..... 4041, 4063, 4064

GE ..... 4007, 4065

Hitachi ..... 4042

JVC ..... 4043

Kenwood ..... 4044, 4067, 4068

Luxman ..... 4069

Marantz ..... 4046

MCS ..... 4070

Mitsubishi ..... 4071, 4072

NEC ..... 4045

Onkyo ..... 4047

Panasonic ..... 4048

Pioneer ..... 4049

RCA ..... 4007, 4050, 4062

Sears ..... 4059

Sony ..... 4051, 4061

Technics ..... 4052

Toshiba ..... 4073

Yamaha ..... 4053, 4054

#### Phono

GE ..... 4005

RCA ..... 4005

#### Receiver/Tuner/AMP

Aiwa ..... 4008, 4009, 4010, 4011, 4012, 4021

Denon ..... 4027

GE ..... 4003

Harman Kardon ..... 4020

JBL ..... 4020

JVC ..... 4013

Kenwood ..... 4014

Onkyo ..... 4022

Optimus ..... 4028

Panasonic ..... 4023, 4024

RCA ..... 4003, 4015, 4029, 4030

Sherwood ..... 4026

Sony ..... 4016, 4017, 4025

Technics ..... 4023, 4024

Yamaha ..... 4018, 4019

Gemini ..... 5017, 5018

General Instruments ..... 5003

Hamlin ..... 5019, 5020, 5021, 5026, 5033

Hitachi ..... 5003

Jerrold ..... 5003, 5017, 5022, 5023, 5039, 5045

Magnavox ..... 5024

Memorex ..... 5026

Movie Time ..... 5025

NEC ..... 5005

NSC ..... 5025

Oak ..... 5015, 5027

Panasonic ..... 5041, 5044

Philips ..... 5011, 5012, 5013, 5014,

..... 5018, 5024, 5028, 5029, 5030

Pioneer ..... 5031, 5032

Proscan ..... 5002, 5003

RCA ..... 5007, 5040, 5042, 5044

Realistic ..... 5009

Samsung ..... 5032

Scientific Atlanta ..... 5006, 5034, 5035, 5036

Signature ..... 5003

Sprucer ..... 5044

Standard Component ..... 5037, 5038

Starcom ..... 5017, 5045

Stargate ..... 5017

Tocom ..... 5004, 5022

United Cable ..... 5045

Universal ..... 5008, 5009, 5010

View Star ..... 5015, 5024, 5025

Zenith ..... 5043

# Using the Remote Control

## HD Receiver Code

Programmable for AUX button.  
RCA ..... 7000

## TV Codes

Programmable for DVD, VCR, SAT/CAB, AUX,  
and AUDIO buttons.  
TV2 ..... 1222  
TV3 ..... 1223

## DVD codes

Programmable for DVD and AUX buttons.  
**DVD**  
Aiwa ..... 3010, 3021  
Apex ..... 3023, 3024  
Broksonic ..... 3027, 3075  
Daewoo ..... 3028  
Denon ..... 3029, 3030, 3031  
Emerson ..... 3032, 3033, 3076  
Funai ..... 3033  
GE ..... 3000, 3034, 3035  
Go Video ..... 3077  
Hitachi ..... 3009, 3067, 3068, 3069, 3070  
JVC ..... 3003, 3011, 3078  
Kenwood ..... 3071  
Konka ..... 3012, 3013  
Koss ..... 3085  
Lasonic ..... 3087  
Magnavox ..... 3004, 3036  
Memorex ..... 3037  
Mintek ..... 3038  
Mitsubishi ..... 3005  
NAD ..... 3032  
Norcent ..... 3039, 3040  
Onkyo ..... 3041  
Oritron ..... 3047  
Panasonic ..... 3014, 3042  
Philips ..... 3004, 3020  
Pioneer ..... 3006, 3043, 3044, 3045  
Proscan ..... 3000, 3046  
Qwestar ..... 3047  
RCA ..... 3000, 3002, 3048, 3079, 3086  
Samsung ..... 3072, 3073, 3074, 3080, 3081,  
Sansui ..... 3049  
Sanyo ..... 3015, 3082  
Sharp ..... 3050, 3052, 3053  
Sony ..... 3007, 3016, 3017, 3054, 3055, 3056, 3083  
Sylvania ..... 3033  
Teac ..... 3057  
Technics ..... 3058  
Toshiba ..... 3008, 3018, 3059, 3060, 3061  
Yamaha ..... 3062, 3063, 3064  
Zenith ..... 3019, 3065, 3084

## Portable DVD

Aiwa ..... 3022  
Audiovox ..... 3025, 3026  
Panasonic ..... 3030  
RCA ..... 3066  
Sharp ..... 3051

## DVD/VCR Combo Codes

DVD and AUX buttons can use DVD codes; VCR  
and AUX buttons can use VCR codes

	<b>DVD</b>	<b>VCR</b>
Broksonic	3075	2075
Emerson	3076	2076
Go Video	3077	2077
JVC	3078	2078
RCA	3079	2079
Samsung	3080, 3081	2080, 2081
Sanyo	3082	2082
Sony	3083	2083
Zenith	3084	2084

## PVR Codes

Programmable for the VCR and AUX buttons.  
**PVR**  
Replay ..... 2086  
Phillips Tivo ..... 2085

## Home Theatre in a Box (DVD Receiver) Codes

AUDIO and AUX buttons can use Audio codes;  
DVD and AUX buttons can use DVD codes

	<b>Audio</b>	<b>DVD</b>
JBL	4031	3088
JVC	4032	3089
Koss	4033	3090
Onkyo	4034	3091
Panasonic	4035	3092
Pioneer	4036	3093
RCA	4037	3094
Venturer	4038	3095

## Satellite Receiver Codes

Programmable for SAT/CAB and AUX/HD  
buttons.

Alphastar	5064
Chapparral	5046, 5047
Dishnet	5063
Drake	5048, 5049
EchoStar	5070
GE	5000, 5001, 5072
General Instruments	5050, 5051, 5052
Hitachi	5066, 5067
Hughes	5062, 5071
JVC	5065
Panasonic	5060
Philips	5068
Primostar	5061
Proscan	5000, 5001, 5072
RCA	5000, 5001, 5072
Realistic	5053
Sony	5058
STS1	5054
STS3	5055
STS4	5056
Toshiba	5057, 5059
Uniden	5069

## VCR Codes

Programmable for VCR and AUX buttons.

Admiral	2068
Aiko	2023
Aiwa	2022
Akai	2002, 2003, 2004, 2057, 2058, 2059
Audiovox	2010
Bell & Howell	2007
Broksonic	2008, 2021, 2075
Calix	2010
Canon	2017, 2018
Capehart	2016, 2056
Carver	2037
CCE	2023, 2036
Citizen	2009, 2010, 2011, 2012, 2013, 2014, 2015, 2023
Colortyme	2005
Craig	2009, 2010, 2019, 2036
Curtis-Mathes	2005, 2009, 2012,
	2014, 2017, 2018, 2020, 2060, 2072
Daewoo	2011, 2013, 2015, 2021, 2022, 2023, 2056
Daytron	2056
Dimensia	2072
Electrohome	2010, 2024
Emerson	2002, 2008, 2010, 2011, 2017, 2020,
	2021, 2022, 2024, 2025, 2026, 2027,
	2028, 2039, 2059, 2061, 2067, 2069, 2076
Fisher	2007, 2019, 2029, 2030
Fuji	2003, 2017, 2062
Funai	2022
Garrard	2022
GE	2000, 2001, 2009, 2017, 2018, 2060,
	2063, 2072

Gradiente	2022
Harman Kardon	2005
Harwood	2036
Hitachi	2033, 2034, 2035, 2053, 2057, 2063
JC Penney	2005, 2006, 2007, 2008, 2009, 2010,
	2017, 2018, 2030, 2033, 2034, 2036, 2037, 2053
Jensen	2033, 2034, 2057
JVC	2005, 2006, 2007, 2014, 2057, 2064, 2078
Kenwood	2005, 2006, 2007, 2012, 2014, 2057,
	2064
KLH	2036
Kodak	2010, 2017
LG	2010
Logik	2036
LXI	2010
Magnavox	2017, 2018, 2037, 2038, 2052, 2054,
	2065
Marantz	2005, 2006, 2007, 2012, 2014, 2017, 2037
Matsushita	2017
Memorex	2007, 2009, 2010, 2017, 2019, 2022,
	2052, 2068
MGA	2024, 2039, 2059
Minolta	2033, 2034, 2053
Mitsubishi	2024, 2033, 2034, 2039,
	2040, 2041, 2059, 2064
Montgomery Ward	2068
Motorola	2017, 2068
MTC	2009
Multitech	2009, 2012, 2022, 2031, 2036
NEC	2005, 2006, 2007, 2012, 2014, 2057, 2064
Nikko	2010
Noblex	2009
Olympus	2017
Optimus	2010, 2068
Optonica	2047
Panasonic	2017, 2018, 2055, 2066
Pentax	2012, 2033, 2034, 2053, 2063
Pentec Research	2014
Philco	2017, 2018, 2037, 2038
Philips	2017, 2037, 2047, 2065
Pioneer	2006, 2033, 2042, 2064
Portland	2012, 2013, 2015, 2056
Proscan	2000, 2001, 2072
Quasar	2017, 2018, 2066
RCA	2000, 2001, 2002, 2009, 2017,
	2033, 2034, 2043, 2044, 2045, 2053,
	2060, 2063, 2066, 2070, 2072, 2073, 2079
Radio Shack	2010, 2047, 2068
Radioshack/Realistic	2007, 2009, 2010, 2017,
	2018, 2019, 2022, 2024, 2029, 2047
Realistic	2007, 2009, 2010, 2011, 2017,
	2018, 2019, 2022, 2024, 2029, 2047, 2068
Radix	2010
Ricoh	2071
Runco	2052
Samsung	2004,
	2009, 2011, 2027, 2031, 2058,
	2080, 2081
Sansui	2006, 2046, 2057, 2064
Sanyo	2007, 2009, 2019, 2082
Scott	2008, 2011, 2021, 2026, 2028, 2039, 2061
Sears	2007, 2010, 2017, 2019,
	2029, 2030, 2033, 2034, 2053
Sharp	2013, 2024, 2047, 2048, 2068
Shintom	2003, 2034, 2036, 2049
Signature	2068
Singer	2017, 2036, 2071
Sony	2003, 2049, 2050, 2062, 2083
STS	2017, 2053
Sylvania	2017, 2018, 2022, 2037, 2038, 2039, 2065
Symphonic	2022
Tandy	2007
Tashiko	2010
Tatung	2057
TEAC	2022, 2057
Technics	2017, 2055
Teknika	2010, 2017, 2022, 2051
Toshiba	2011, 2029, 2030, 2033, 2039, 2059
Totevsion	2009, 2010
Unitech	2009
Vector Research	2005, 2006, 2011, 2012
Video Concepts	2005, 2006, 2011, 2012, 2059
Wards	2009, 2010, 2011, 2017, 2019, 2022, 2024,
	2033, 2034, 2036, 2047, 2053, 2061, 2068, 2070
XR-1000	2017, 2022, 2036
Yamaha	2005, 2006, 2007, 2014, 2057
Zenith	2003, 2049, 2052, 2062, 2071, 2084

# Using the TV's Features

## Chapter Overview:

- About the Channel Banner
- Digital or Analog TV Channels
- Parental Controls
- How V-Chip Works for the USA and Canada
- Auto Tuning Feature
- PIP (Picture-In-Picture) Operation
- Using the Web Browser
- DTVLink Recording
- Emergency Alert System (EAS)

SCENIUM



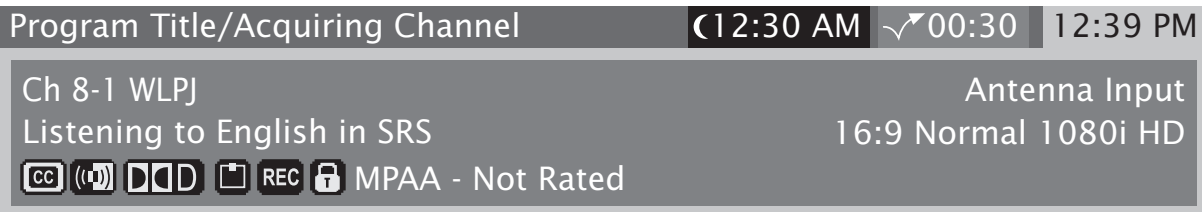





# Using the TV's Features

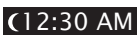

## About the Channel Banner

The Channel Banner appears when you press the INFO button on the remote. If an icon in the channel banner is grayed out (dim), the feature is not available. The following list describes the items on the Channel Banner screen (left to right and top to bottom). Other displays that are not described here are self-explanatory. When you change channels, the Channel Banner appears as a smaller version than what's shown above.

The icons change appearance to show the item's status or availability.

- Program Title/Acquiring Channel** Title of program (if available) or *Acquiring Channel* appears when tuning a channel.
-  The time when the TV shuts off if the Sleep Timer is activated in the *Time* menu.
-  Displays the time remaining before the TV tunes back to the channel where Commercial Skip was activated.
- 12:39 PM** Current time if the Time feature is set in *Time* menu.
- Ch 8-1 WLPJ** Current channel, subchannel (for digital channels) and the station call letters, if available.
- Antenna/Cable/Auto Tuning** Displays type of signal (Antenna or Cable) you're viewing or the Auto Tuning component you're viewing.
- Listening to** Displays when SAP is playing for analog channel. For a digital channel, displays the currently playing audio language. Also displays the audio processor in use. SAP or Audio Mode changes with SOUND button.
- 16:9 Normal 1080i HD** Aspect ratio (4:3 or 16:9); original resolution of the broadcast, not the resolution of the TV; HD or SD. For more information about aspect ratio and broadcast resolution, go to page 2.
-  Displays when Closed Captioning is available on the current channel and matches the format selected in the *Caption Priority* menu.
-   SAP or Audio language icon appears when the current analog channel is broadcasting SAP (Second Audio Program) information or when current digital channel is broadcasting an alternate audio mode, respectively.
-   Sound mode icons (mono, stereo, Dolby surround, four-channel surround, 4.1-channel surround, five-channel surround), etc.
-  Appears when a program can be recorded; otherwise, it is grayed out.
-  Parental Control icon is displayed red when the TV is locked, green when the TV is unlocked, and yellow when the TV is temporarily unlocked.
- MPAA - Not Rated** V-chip program rating (not the TV's rating set up in Parental Control menu).



## Digital or Analog TV Channels

A single off-air antenna can pick up both analog and digital channels. Digital channels can be made up of primary channels and subchannels.

**Note:** Subchannels (sometimes called minor channels) are channels associated with the primary channel (sometimes called the major channel). A primary channel may have just one subchannel or multiple subchannels.

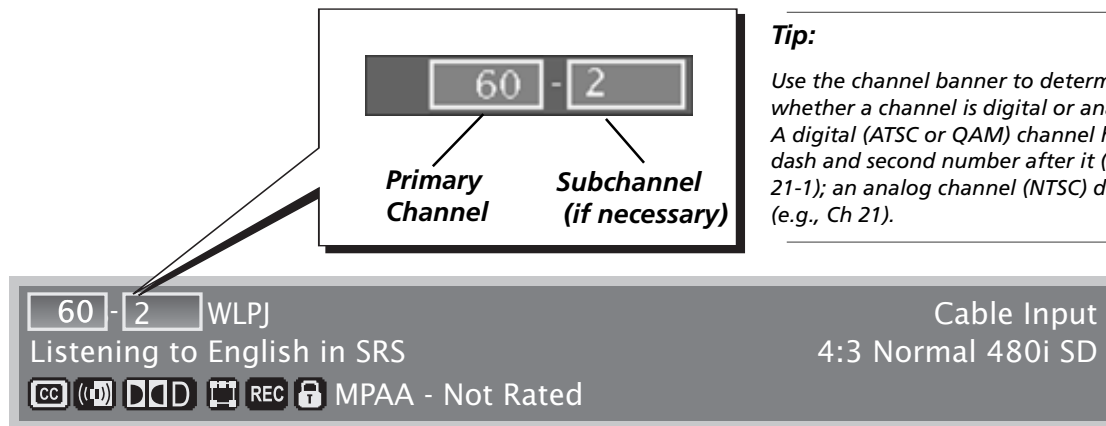

### Tip:

Use the channel banner to determine whether a channel is digital or analog. A digital (ATSC or QAM) channel has a dash and second number after it (e.g., 21-1); an analog channel (NTSC) doesn't (e.g., Ch 21).

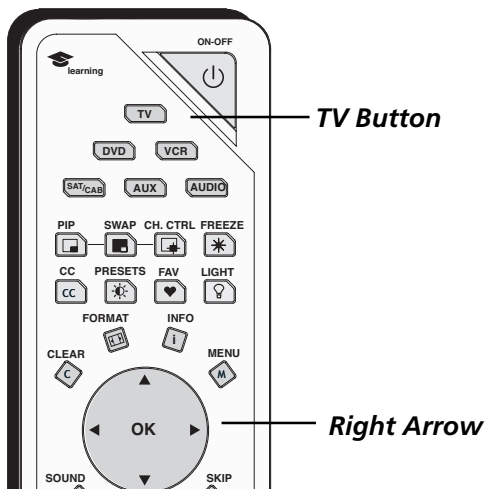

## Direct Tuning to a Channel

1. Make sure the remote is in TV mode by pressing TV on the remote control.
2. Enter the primary channel number. This number appears in the primary channel entry box. Press OK or wait a few seconds. If you don't enter a subchannel, the TV tunes to the lowest digital subchannel.
3. If the primary channel number has six or fewer digits (for cable), or two digits (for antenna) and you want to enter subchannel numbers, press the right arrow button to advance to the subchannel entry box.
4. Enter the number of the subchannel. This number appears in the subchannel entry box.
5. Press OK to tune to the channel or wait a few seconds and the TV tunes to the channel.

**Notes:** You can always use the channel up and down buttons on the remote control to change channels within the TV mode.

If you wait too long before entering the subchannel, the TV tunes to the lowest digital subchannel.

### Tip

If a digital and analog channel have the same primary channel number, tune to the analog channel by entering the analog channel number or entering the analog channel number and then a subchannel of "0."

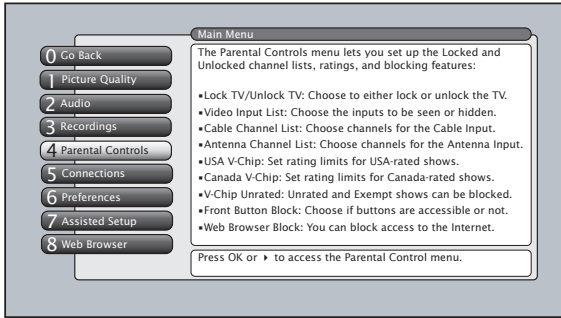

## Parental Controls

The *Parental Controls* menu allows you to program your TV so that children cannot see certain programs, channels, browser, or use the buttons on the front of the TV. The *Parental Controls* menu controls the software inside your TV (referred to as V-Chip) which lets you program your TV so it won't display certain programs and movies based on violence, sex, or other content you may believe children should not view. Once you block programs, you or other adults can unblock programs by entering a password to unlock video or enter the password to edit the features in the *Parental Controls* menu. By default, the software inside your TV is turned "off," so if you don't want to use this feature, you can just ignore it.

The options of the *Parental Controls* menu are *Lock/Unlock TV*, *Video Input List*, *Cable Channel List*, *Antenna Channel List*, *USA V-Chip*, *Canada V-Chip*, *V-Chip Unrated*, *Front Button Block*, and *Web Brouser Block*.

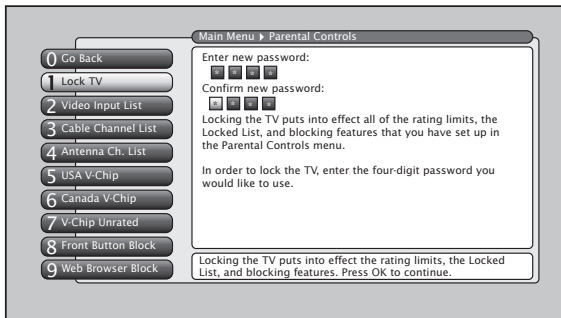

## Lock/Unlock TV

Selecting this option lets you lock and unlock the parental controls and the TV using a password. It locks or unlocks channel lists. If the TV is unlocked when watching TV, you only see the channels that have a check mark in the *Unlocked List* (see Channel Lists below). If the TV is locked when watching TV, you only see the channels that are marked as Viewable in the *Locked List*. If the TV is locked, all channels can still be accessed by using the number buttons on the remote control but may not be viewed if they are blocked (enter password to see program).

**Notes:** When locking the TV, you'll be asked to enter a password and then to re-enter the password a second time to re-confirm your password choice.

If you do not lock the TV, none of the settings for V-Chip, channel block, front panel block, and web browser block take effect.

If you forget your password, simultaneously press and hold the MENU/OK button on the front panel and VOL- button on the remote for three seconds. This resets the password only and unlocks the TV; all other settings in Parental Controls are not changed.

### Tip

You must lock the TV for the Parental Controls settings to be enforced.

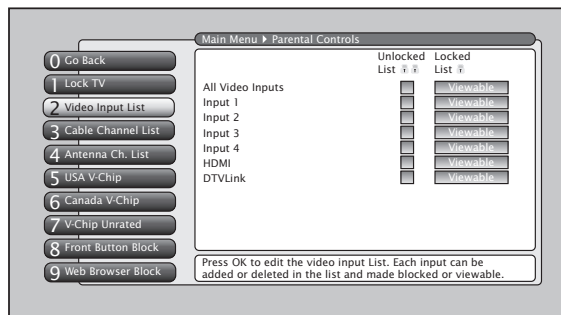
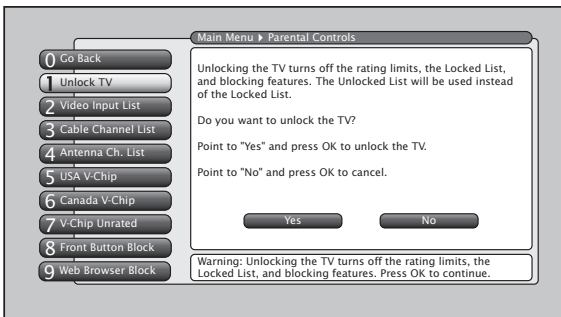

## Channel Lists (Video Input List, Cable Channel List, Antenna Ch. List)

The channel lists contain the following information: major channel number (with subchannel number only if a digital channel), channel call letters (when channel is tuned), *Locked List*, and *Unlocked List*. The major channels listed in *Cable Channel List* and *Antenna Ch. List* for off-air or cable sources are based on the channel search results. If a major channel is not found by Channel Search, then it is not listed.

## Editing Channels in the Channel Lists

The Antenna and Cable Channel lists are only editable through the *Unlocked List* and *Locked List* in the *Parental Controls* menu. You can remove or “hide” a channel from the *Unlocked List* by removing the checkmark in the checkbox. Also, you can remove or “hide” a channel from the *Locked List* by selecting *Blocked* in the *Locked List*. When you press the channel buttons, that channel will be skipped. When the TV is locked, you can still access the channel directly by using the number buttons on the remote control but may not be able to see the video until a valid password is entered.

To save time, you can also add ALL or delete ALL channels in a list by changing the checkbox or choice field in the line that says *All Video Inputs* or *All Channels* but be very careful because you could erase all of your selections.

**Note:** *If a cable box is connected to the CABLE INPUT, the channel list can be edited for Cable Channel in the Parental Controls menu. If a cable box is connected via INPUT1, the channel list cannot be edited- you can only use channel up/down or use the number buttons.*

## How V-Chip Works for the USA and Canada

The V-Chip software reads a code that most broadcasters send with programs. That code tells the TV software the program's age-based rating (TV-MA, TV-14, etc.) and content themes [(Violence (V), Adult Language (L), etc.)]. If you have blocked the rating and/or content themes that the program contains and the TV is locked and you tune to a program whose rating exceeds the rating limit you set, you will receive a message telling you that the program is not approved for viewing.

Broadcasters are not required to provide content themes, so programs received with no content themes will only be blocked if you block their age-based rating and the TV is locked. With the *V-Chip Unrated* menu, you can also block out programs that have been given a rating of “Not Rated,” or “Exempt” and programs that are considered “unrated”. The TV age-based ratings and content themes you can block are in the table on the next page.

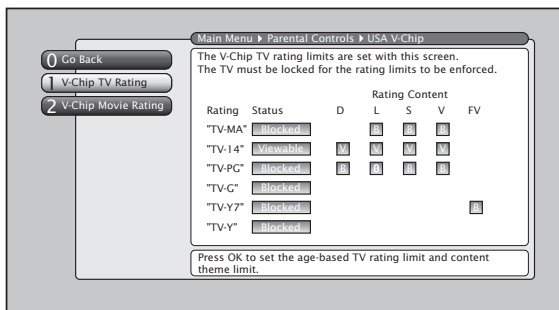

## USA V-Chip TV Ratings

The *USA V-Chip TV Rating* lets you decide which TV programs can and cannot be viewed. To set TV programming limits:

1. Choose *Parental Controls* from the Main menu. If *Parental Controls* have previously been locked, you must enter your password.
2. Highlight and select *USA V-Chip*.
3. Highlight and select *V-Chip TV Rating*.
4. Once you get to the *V-Chip TV Rating* screen, use the arrow buttons and OK on your remote to change the status of a TV program rating or content theme from *Viewable* to *Blocked*.

Proceed to the next sections for more details about how to change the status of TV program limits.

# Using the TV's Features

## USA V-Chip Rating Limit Screen

The following is an example of where items are located within the *V-Chip TV Rating* screen below the *USA V-Chip* menu.

**Rating Field**  
Lets you select from a list of age-based ratings you can block or view.

**Rating Status Field**  
Lets you select whether the status of the age-based rating limit to the left is Viewable or Blocked.

**Rating Settings Area**  
Lets you see the current block/view state of age-based ratings and associated content. The Viewable (V) settings are coded in green, and the Blocked (B) settings are coded in red.

**Content Themes**  
Lists the content themes you can block or view.

**Content Status Fields**  
Lets you select which content themes to view for the selected rating, and whether the status of the content theme is currently Viewable (V) or Blocked (B).

The screenshot shows a menu with options: 0 Go Back, 1 V-Chip TV Rating, and 2 V-Chip Movie Rating. The main screen displays a list of ratings: TV-MA (Blocked), TV-14 (Viewable), TV-PG (Blocked), TV-G (Blocked), TV-Y7 (Blocked), and TV-Y (Blocked). A 'Rating Content' section shows themes D, L, S, V, and FV with corresponding status indicators (V or B).

Age-Based Rating	USA Description and Content Themes for Age-Based Ratings
<b>TV-MA</b>	<b>Mature Audience Only.</b> Specifically designed to be viewed by adults and may be unsuitable for children under 17. It contains one or more of the following content themes: crude indecent language (L), explicit sexual activity (S), or graphic violence (V).
<b>TV-14</b>	<b>Parents Strongly Cautioned.</b> Contains some material that many parents would find unsuitable for children under 14. Parents are strongly urged to exercise greater care in monitoring this program and are cautioned against letting children under the age of 14 watch unattended. This program contains one or more of the following content themes: intensely suggestive dialogue (D), strong coarse language (L), intense sexual situations (S), or intense violence (V).
<b>TV-PG</b>	<b>Parental Guidance Suggested.</b> Contains material that parents may find unsuitable for younger children. Many parents may want to watch it with their younger children. The program contains one or more of the following content themes: some suggestive dialogue (D), infrequent coarse language (L), some sexual situations (S), or moderate violence (V).
<b>TV-G</b>	<b>General Audience.</b> Most parents would find this program suitable for all ages. It contains little or no sexual dialogue (D) or situations (S), no strong language (L), and little or no violence (V).
<b>TV-Y7</b>	<b>Directed to Children 7 years and older.</b> Designed for children ages 7 and above. It may be more appropriate for children who have acquired the developmental skills needed to distinguish between make-believe and reality. Themes and elements in this program may include mild fantasy violence (FV) or comedic violence, or may frighten children under the age of 7.
<b>TV-Y</b>	<b>All Children.</b> Themes and elements in this program are designed for a young audience, including children from ages 2-6. It is not expected to frighten younger children.

## Blocking Age-Based Ratings

You can automatically block all program ratings above a specified age-based rating level. For example, if you only want your child to watch programs that have a TV-G rating and lower (in other words, you want the child to watch TV-G, TV-Y7, and TV-Y), then you need to block out higher ratings.

To block programs with higher ratings:

1. First, determine the lowest level rating you don't want the child to watch (see chart of age-based ratings on previous page).
2. Highlight the lowest rating you do not want the child to watch. In the example discussed above, you would highlight TV-PG, since the highest rating you want the child to watch is TV-G.
3. Press the OK button to toggle between *Viewable* and *Blocked*. The status for the rating listed to the right and all higher ratings automatically change to *Blocked* (and *B*).
4. Select *Lock TV* from the *Parental Controls* menu. Enter a password and re-enter password a second time to confirm the password.

Hierarchy of Age-Based Ratings	
<b>TV-MA</b>	<b><i>Mature Audience Only</i></b>
<b>TV-14</b>	<b><i>Parents Strongly Cautioned</i></b>
<b>TV-PG</b>	<b><i>Parental Guidance Suggested</i></b>
<b>TV-G</b>	<b><i>General Audience</i></b>
<b>TV-Y7</b>	<b><i>Directed to Children 7 years and older</i></b>
<b>TV-Y</b>	<b><i>All Children</i></b>

## Viewing Age-Based Ratings

After you block age-based ratings, you have the option of changing some of the ratings back to *Viewable* (*V*).

1. Determine which blocked rating you want to view.
2. Use the up and down arrow buttons to highlight the rating with a status of *Blocked*.
3. Press the OK button to select *Viewable*.

**Notes:** *The content status fields corresponding to the unblocked rating become Viewable as well. They and the age-based rating status are the only fields that automatically change back to Viewable when you complete this process.*

*You must remember to lock the TV for rating limits to take effect.*

## Blocking Specific Content Themes

You can block programs based on their content. When you block a content theme for a particular rating, you automatically block that content theme for higher rated programs as well.

For example, if you do not want your child to watch programs that have adult language (L) rated TV-PG or higher, then you could block out all programming TV-PG and above containing adult language.

To block program content:

1. Determine the lowest level of content you don't want the child to watch.
2. Use the up and down arrow buttons on the remote to highlight the age-based ratings that correspond with the lowest content you do not want the child to watch. (In the example above, you would highlight TV-PG.)
3. Press the OK button to change content status from (*V*) *Viewable* to (*B*) *Blocked*. All higher ratings' content themes change to *Blocked*.

**Notes:** *Broadcasters are not required to provide content themes or age-based ratings.*

*You must remember to lock the TV for rating limits to take effect.*

# Using the TV's Features

## Viewing Specific Content Themes

If you block specific content themes, you have the option of going back and changing some of the content themes back to *(V) Viewable*:

Content Themes	
D	Sexually explicit dialogue
L	Adult language
S	Sexual situations
V	Violence
FV	Fantasy Violence

1. Determine the content themes you want to change to *(V) Viewable*.
2. Use the up and down arrow buttons to highlight the age-based rating whose content theme you want to change to *Viewable*.
3. Press the OK button to change its status back to *V*. Your child would then be able to watch programs with TV-14 adult language content, but not programs with TV-PG or TV-MA language content.

**Note:** Only the content theme status corresponding to TV-14 (*L*) language changes to *(V) View*. Higher rated content themes, such as that for TV-MA language, do not change.

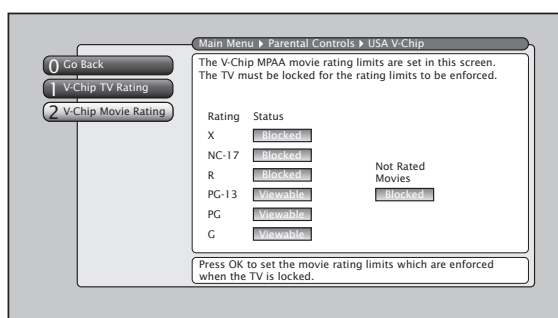

## V-Chip Movie Rating Limit

You set movie (MPAA) rating limits by blocking movies rated above a specified rating. How to block movie ratings and view movie ratings is explained in the next two sections.

To access the *V-Chip Movie Rating* menu:

1. Press MENU on the remote control (the *Main Menu* appears).
2. Select *Parental Controls*.
3. Select *USA V-Chip*.
4. Select *V-Chip Movie Rating*.

## Blocking Movie Ratings

If you only want your child to watch movies that have a PG rating and lower (in other words, movies rated PG and G), then you could automatically block out all other movies with higher ratings.

To block movies:

1. Highlight the rating that is the lowest rating you don't want the child to watch. (In the example above, you would highlight the rating status button corresponding to PG-13, since the highest rating you want the child to watch is PG.)
2. Press the OK button to change the button from *Viewable* to *Blocked*. All higher ratings automatically change to *Blocked*.
3. If the TV is not locked, you must lock it so the movie rating limits will take effect.

**Note:** Some movies may be given a *Not Rated (NR)* rating. After blocking movie ratings, you must set *NR* to *Viewable* separately to view *NR* movies.

## Viewing Movie Ratings

After you block movie ratings, you have the option of changing some of the rating status buttons back to *Viewable*:

1. Highlight the rating you want to view.
2. Press the OK button to change the button from *Blocked* to *Viewable*.

For example, if movies with a rating of PG-13 and higher are blocked, you can change the rating status corresponding with NC-17. Your child would then be able to watch all movies with a G, PG, and NC-17 Rating.

3. Exit the screen, and be sure the TV is locked.

## Canada V-Chip

Canadian TV V-Chip supports two different Canadian rating systems: English and French.

Age-Based Rating	Canada V-Chip English Rating System
<b>18+</b>	<b>Adults.</b> Programming intended for adults 18 and older. It may contain elements of violence, language, and sexual content which could make it unsuitable for viewers under 18. Violence guidelines: may contain violence integral to the development of the plot, character or theme, intended for adult audiences. Other content guidelines: may contain graphic language and explicit portrayals of nudity and/or sex.
<b>14+</b>	<b>Viewers 14 and over.</b> Programming contains themes or content which may not be suitable for viewers under the age of 14. Parents are strongly cautioned to exercise discretion in permitting viewing by pre-teens and early teens. Violence guidelines: may contain intense scenes of violence. Could deal with mature themes and societal issues in a realistic fashion. Other content guidelines: may contain scenes of nudity and/or sexual activity. There could be frequent use of profanity.
<b>PG</b>	<b>Parental Guidance.</b> Programming intended for a general audience but which may not be suitable for younger children (under the age of 8). Parents may consider some content inappropriate for unsupervised viewing by children aged 8-13. Violence guidelines: depictions of conflict and/or aggression will be limited and moderate; may include physical, fantasy, or supernatural violence. Other content guidelines: may contain infrequent mild profanity, or mildly suggestive language. Could also contain brief scenes of nudity.
<b>G</b>	<b>General Audience.</b> Programming considered acceptable for all ages groups. While not designed specifically for children, it is understood younger viewers may be part of the audience. Violence guidelines: will contain very little violence, either physical or verbal or emotional. Will be sensitive to themes which could frighten a younger child, will not depict realistic scenes of violence which minimize or gloss over the effects of violent acts. Other content guidelines: there may be some inoffensive slang, no profanity and no nudity.
<b>C8+</b>	<b>Children 8 and Older.</b> Programming generally considered acceptable for children 8 years and over to watch on their own. Violence guidelines: violence will not be portrayed as the preferred, acceptable, or only way to resolve conflict or encourage children to imitate dangerous acts which they may see on television. Any realistic depictions of violence will be infrequent, discreet, of low intensity and will show the consequences of the acts. Other content guidelines: there will be no profanity, nudity or sexual content.
<b>C</b>	<b>C (Children)</b> Programming intended for children under age 8. Violence guidelines: careful attention is paid to themes which could threaten children's sense of security and well being. There will be no realistic scenes of violence. Depictions of aggressive behavior will be infrequent and limited to portrayals that are clearly imaginary, comedic or unrealistic in nature. Other content guidelines: there will be no offensive language, nudity or sexual content.

# Using the TV's Features

Age-Based Rating	Canada V-Chip French Rating System
<b>18+</b>	<b>Adults.</b> Programming is for adults only. This program contains sustained violence or extremely violent scenes.
<b>16+</b>	<b>Viewers 16 and over.</b> Programming is not suitable for those under age 16. This program contains frequent scenes of violence or intensely violent scenes.
<b>13+</b>	<b>13+ (Viewers 13 and over)</b> Programming may not be suitable for children under the age of 13. This program either contains several violent scenes or one or more scenes that are violent enough to affect them. Viewing in the company of an adult is therefore strongly recommended for children under the age of 13.
<b>8+</b>	<b>8+ (Viewers 8 and over)</b> Not recommended for young children. This program is suitable for most audiences, but it contains mild or occasional violence that could upset young children. Viewing in the company of an adult is therefore recommended for young children (under the age of 8) who do not distinguish between reality and imagination.
<b>G</b>	<b>G (General Audience)</b> This program is suitable for audiences of all ages. It contains no violence, or any violence that it does contain is either minimal or is presented in a humorous manner, as a caricature, or in an unrealistic way.

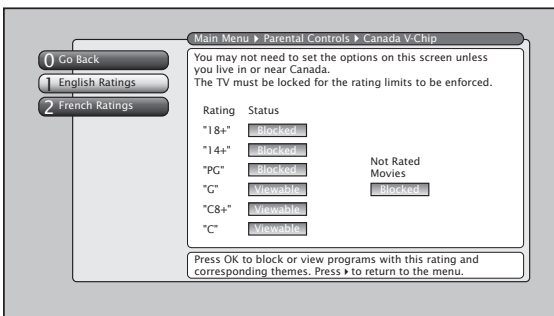

## Canada V-Chip

The *English* or *French Canada V-Chip TV Rating* lets you decide which TV programs can and cannot be viewed. To set TV programming limits:

1. Choose *Parental Controls* from the Main menu. If *Parental Controls* (TV) have previously been locked, you must enter your password.
2. Highlight *Canada V-Chip* and select either Canada's *English Ratings* or *French Ratings*.
3. Once you get to the *English* or *French Ratings* screen, use the arrow buttons and OK on your remote to change the status of a TV program rating or content theme from *Viewable* to *Blocked*.

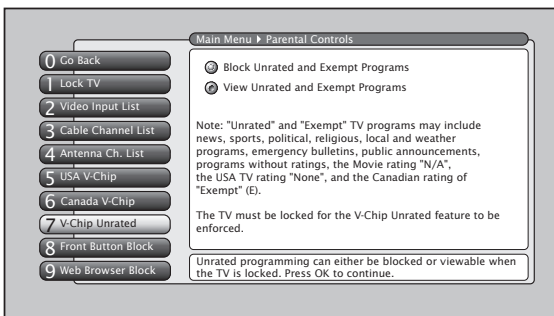

## V-Chip Unrated Program Block

Selecting this option lets you decide if programs that the V-Chip recognizes as “Unrated” (USA) and “Exempt” (Canada) can be viewed. Note that “Unrated” and “Exempt” TV programs may include news, sports, political, religious, local and weather programs, emergency bulletins, public announcements, and programs without ratings, the movie rating “N/A,” and the TV rating “None” and the Canadian rating of “Exempt.”

**Block Unrated and Exempt Programs** All unrated and exempt programs are available.

**View Unrated and Exempt Programs** All unrated and exempt programs are not available.

**Note:** You must remember to lock the TV for rating limits to take effect.



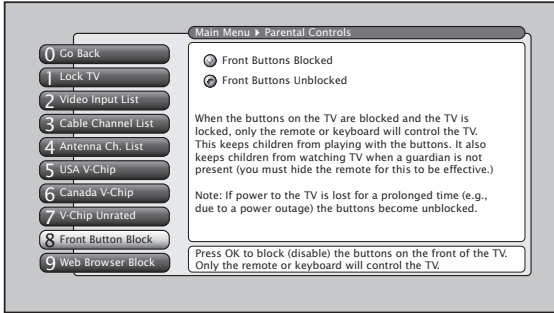

## Front Button Block

Selecting this option lets you block (disable) or unblock (enable) the TV's front buttons. The remote still tunes to any channel. *Front Panel Block* can:

- Keep children from watching TV when the parent is not present.
- Keep young children from playing with the buttons on the TV.

(When using this as a *Parental Control* method, you should remove access to any remote that is capable of operating the television.)

Don't forget to lock the TV after you select *Blocked*. If you do not, the front panel block will not take effect.

**Note:** If power to the TV is lost for an extended period, the buttons become unblocked.

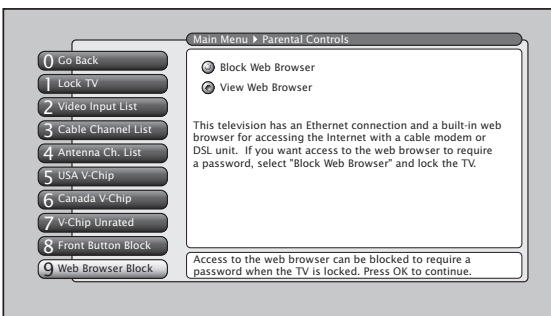

## Web Browser Block

Selecting this option lets you decide if the web browser can be accessed.

**Block Web Browser** Need a password to view web content when TV is locked.

**View Web Browser** Web browser is accessible without a password when TV is locked.

Make sure the TV is locked. If you do not, *Web Browser Block* will not block browser access even if you set *Block Web Browser*.

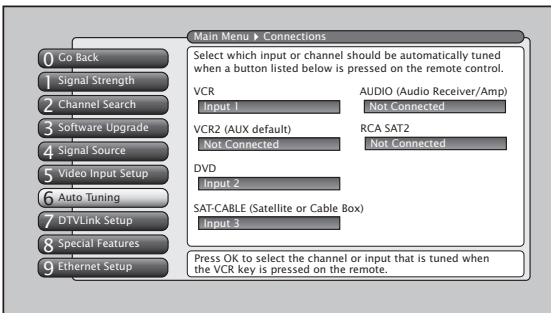

## Auto Tuning Feature

The way you set up the *Auto Tuning* feature in the TV's menu corresponds to the component buttons on the remote and the way you have each component connected to your TV. When you set auto tuning, you're telling the TV what channel or input to tune to when you press the VCR, DVD, AUDIO, or SAT/CAB button on the remote control. This is especially useful for going directly to an input like DTVLink.

**Notes:** The *AUX* button by default is set up for a second *RCA VCR*. If you need to reprogram the *AUX* button, or instead want to program the *VCR* button, use the 2001 code. Then use the *VCR2* option in the auto tuning menu to set auto tuning.

If you have two *RCA* satellite receivers, you can control each separately. Program the second receiver with the *AUX* button using the 5001 code. Then use the *RCA SAT2* option in the auto tuning menu to set auto tuning.

1. Press **MENU** (the *MAIN MENU* appears)
2. Highlight *Connections* and press **OK**.
3. Highlight *Auto Tuning* and press **OK**
4. Highlight the component button field and continually press **OK** to scroll through the selection of inputs.

The choices and a brief explanation follow:

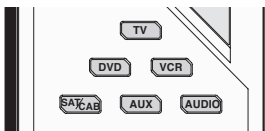

With the *Auto Tuning* feature, you can set up the TV to tune to the channel or input you want to watch by pressing that component's button. *Auto Tuning for the TV* button cannot be set.

# Using the TV's Features

**Not Connected** Choose this if you don't have this particular component connected to the TV, or if you don't want the TV to automatically tune to the correct channel when you press one of the component buttons on the remote.

**Channel 2, 3 or 4 Cable Input** Component is connected to the *CABLE INPUT* jack on the back of the TV, and you want the TV to tune to channel 2, 3, or 4 when you press the corresponding button on the remote. Reminder: make sure the component's Channel 2/3 or 3/4 switch is set to match the channel you choose in *Auto Tuning*.

**Channel 2, 3 or 4 Antenna Input** Component is connected to the *ANTENNA INPUT* jack on the back of the TV, and you want the TV to tune to channel 2, 3, or 4 when you press the corresponding button on the remote. Reminder: make sure the component's Channel 2/3 or 3/4 switch is set to match the channel you choose in *Auto Tuning*.

**Input 1, Input 3** Component is connected to the Input 1 or 3 Video (*V*) or *S-VIDEO* jack on the back of the TV and you want the TV to tune to the Video Input Channel when you press the corresponding button.

**Input 2, Input 4** Compatible video source, such as a DVD player or satellite receiver, is connected to the Input 2 or 4 *COMPONENT/COMPOSITE INPUT* jacks (Y/Video•Pb•Pr) on the back of the TV and you want the TV to tune to the composite/component video input when you press the corresponding button.

**HDMI** Component is connected to the *HDMI/DVI* jack on the back of the TV and you want the TV to tune to this input when you press the corresponding button.

**DTVLink** DTVLink components connected to the *DTVLink* jacks on the back of the TV can also be autotuned.

## PIP (Picture-in-Picture) Operation

The PIP (Picture-In-Picture) feature lets you display a second, smaller analog (NTSC format) picture on top of the main analog picture. You will only be able to use the PIP window and main picture with analog channels and inputs; PIP doesn't support digital signals. The main and PIP channels must be from different tuners or inputs; for example, main is from INPUT 1 and PIP is from ANTENNA INPUT. If you are only using tuners for PIP and main, you must have the main picture from CABLE INPUT and the PIP picture from ANTENNA INPUT, or vice-versa.

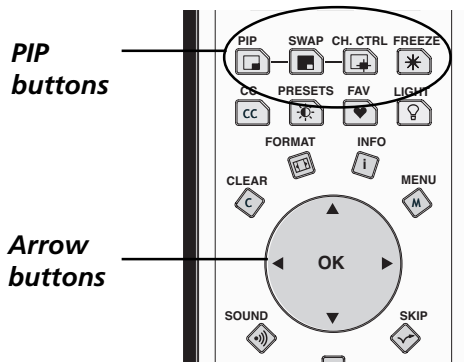

### Tip

If you want to go directly to an input or channel in PIP (or main), set up auto tuning and press the component button (VCR, DVD, etc.).

### PIP Buttons

There are certain remote buttons that control the way the PIP window works:

**PIP** Brings up the PIP window. Press PIP again to remove the window.

**Arrows** Let you move the PIP window to different areas of the screen.

**SWAP** Switches the video from the PIP window to the main picture.

**FREEZE** Freezes entire screen, including the main picture and PIP window, if PIP is displayed.

**CH CTRL** (Channel Control) Lets you switch channel control between the PIP window and the main picture. To determine whether you are controlling the PIP or the main picture, look at the channel banner as you change channels or press INFO button. The triangular indicator (▷) beside the channel number lets you know which picture you're controlling with channel up/down, number buttons, etc.

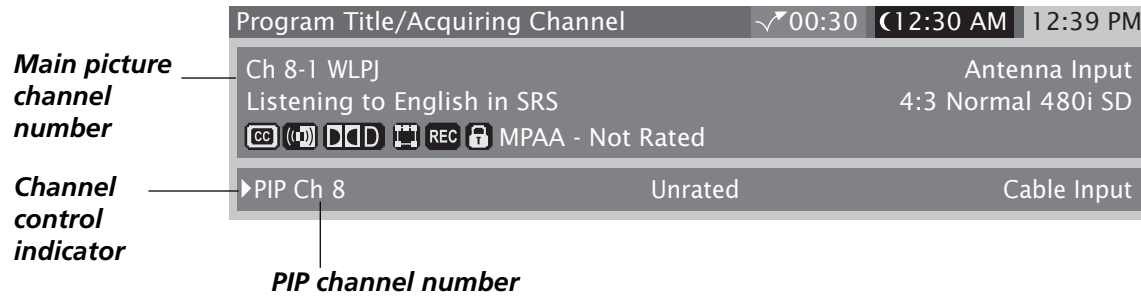

## Using the PIP Feature

The PIP feature is only available for analog (NTSC) channels; PIP won't work when tuned to a digital (ATSC) channel. Use the channel banner to determine whether a channel is digital or analog. A digital (ATSC) channel has a dash and second number after it (e.g., 21-2); an analog channel doesn't (e.g., Ch 21). While you may use PIP in different ways, this basic PIP scenario should get you started. When watching an analog channel, follow these steps.

1. Press the PIP button on the remote control. The PIP window appears on the screen and *Channel Control* is automatically set to the PIP window.
2. To change the PIP channel, use the channel up and down, INPUT, ANT/CAB, number buttons, or component buttons that have been auto tuned.
3. To change the program in the main picture window, press CH CTRL. Then use any of the above mentioned buttons. To go back and forth between controlling the PIP window and the main picture, press the CH CTRL button.

## PIP Problems?

- If you are channel surfing in the main window and PIP disappears, you may have tuned to a digital channel. To view PIP and the main picture, make sure that both the main and PIP channels are analog inputs, or signals. Continue changing the channel until you find an analog (NTSC format) channel. The PIP window will reappear.

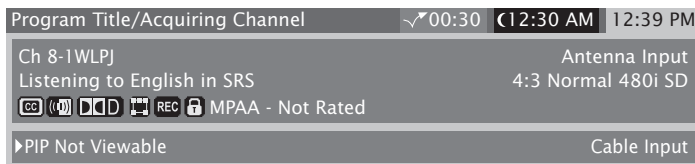

*The message "PIP Not Viewable" in the channel banner lets you know that PIP is not available on this channel and you should tune to another channel.*

- If you press PIP and the PIP window is gray, you may have activated the Parental Control feature and the program exceeds the rating limits you set. For information on removing limits, see the section "Parental Controls."
- You cannot view closed captioning in the PIP window.
- PIP channel skips all digital (ATSC) TV channels and tunes to analog channels.
- PIP can only be displayed in analog signals from CABLE, ANTENNA, composite, S-VIDEO and component (Y, Pb, Pr) inputs in 480i format.

# Using the TV's Features

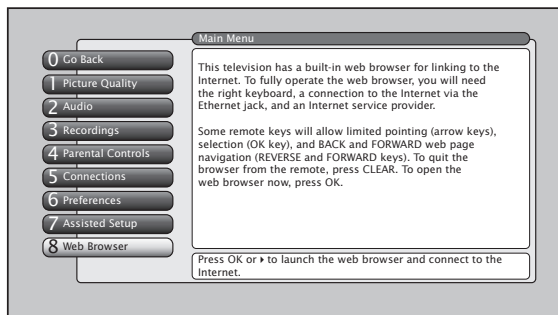

## Using the Web Browser

*Important: To use the TV's browser, you must have your TV connected to the Internet (e.g., cable modem or DSL) and subscribe to an Internet Service Provider (ISP).*

You can start the browser on your TV by selecting it from the main menu. The TV front panel and remote control provide basic navigation without a keyboard. If you launch the browser from the main menu, a message pops up to suggest that you use the keyboard with this TV to connect to the Internet. The supplied keyboard allows you to get optimum use of the web browser features.

When you start the browser for the first time, it goes to an RCA website. All FAV keyboard buttons are also initially programmed to that site. The FAV SEARCH and FAV HOME buttons on the keyboard default to a search site but you can reprogram them.

The FORMAT button on your remote (or keyboard) allows you to cycle through various combinations of a less than full screen browser and some TV video. Just press the button again to use a different format.

To close the browser entirely, press CLEAR on the remote.

You may discover that other browser windows are open. This may be the result of a pop-up window being delivered from the site you were viewing. Press "Close Window" button to close it or click the "Close Window icon" on the window.

*Note: The browser won't display streaming video or audio, and some animated graphics.*

### Tips

*If you use the video window in the browser and you press channel up/down and the video window seems to disappear, this means you've either tuned to a channel which is blocked or has a weak signal. Use the channel up/down to go to another channel.*

*Sometimes the browser locks onto an incompatible website and it won't open. Exiting the browser will not correct this condition. When the browser is restarted, the browser returns to the last-used website. To correct this condition, either press a FAV button to go to a known good website or press "Address" and type in a good website.*

*You can use channel up/down, ANTICAB, INPUT, or component buttons you've set with auto tuning to tune to a different channel in the video window. Number keys cannot be used to tune channels in the video window.*

## Saving Your Favorite Web Address

Program any favorite (FAV) key, including HOME and SEARCH, to any website address (URL). After you've browsed to a favorite web address, just press the desired key and hold it until a message appears. That site's address will be assigned to the key you pressed and saved in the TV. The next time you press the key briefly, the browser will automatically go to the site you saved. Access programmed favorite websites using your remote by pressing FAV + number button. To view FAV HOME, press FAV + 0; to view FAV SEARCH, press FAV + 7.

You can store 32 additional website addresses by using the following buttons together: SHIFT and FAV, CTRL and FAV, ALT and FAV.

If you have the optional keyboard, previously visited sites are also available as a drop-down listing from the address bar. The list can hold only a certain number of addresses, so at some point a new address will replace the oldest one.

## Controlling the Web Browser

As stated previously, the remote control and front panel buttons support only basic browser functions. However, the keyboard makes browser navigation much easier and is the only way to enter a web address. Below is a table that shows which remote buttons work what function.

Web Browser Button Interaction		
Remote:	Front Panel:	Browser Function:
MENU	MENU/OK	Closes browser and opens main menu; press OK to select weblink
CLEAR		Quits the browser
SWAP		Displays the previous browser window, if multiple windows are displayed
CH CTRL		Displays the next browser window, if multiple windows are displayed
STOP		Stops loading the current page; STOP
PLAY		Reloads the current page; REFRESH
REVERSE		Go to the previous page if one exists; BACK equivalent on optional keyboard
FORWARD		Go to the next page if one exists; FORWARD equivalent on optional keyboard
FORMAT		Toggles between Full-Size browser and browser plus video in multiple layouts
Up/Down/Left/Right Arrow		Moves the cursor in the web page

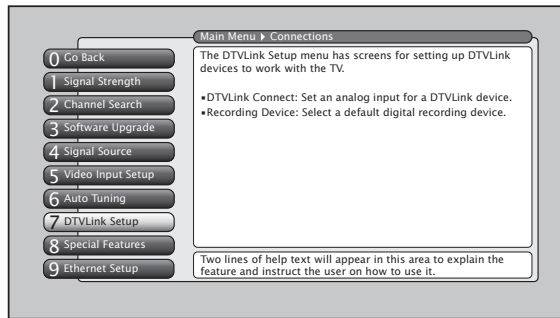

## DTVLink Recording

The 2-way DTVLink jacks enable you to connect a compatible Audio/Video Hard Disk Drive (AVHDD) and/or a Digital VCR (DVCR) so you can record and play digital content. The recommended AVHDD component is model DVR2080 or DVR2160, available at your local RCA dealer or [www.rca.com](http://www.rca.com). The DVR2080 and DVR2160 are DTVLink hard disk drives that includes time-shift features, such as recording and pausing digital TV signals.

### You should know:

- Only digital content can be recorded with the DTVLink jacks. Analog TV programs cannot be recorded through the TV's DTVLink jacks.
- You can only record content if the DTVLink component connected enforces copy protection standards (check your DVCR or AVHDD manual).
- When the TV is tuned to the DTVLink input channel and the remote is in the TV mode, you can use the remote for some basic transport controls, such as RECORD, STOP, FAST FORWARD, REVERSE, PAUSE, and PLAY. Some components support advanced functionality with CH+/-, Go BACK, and 0-9 number buttons.
- Don't change channels when you are recording because recording will stop.
- A message appears when you press the RECORD button to let you know the DTVLink component is recording the channel that you selected.
- You can record subchannels on a major channel, but only the subchannel selected is recorded.
- The program name, channel, track number, DTVLink-model name, and elapsed time for DTVLink recordings appear in the channel banner (some information is available only for AVHDD and not for DVCR). To access the channel banner, press INFO on the remote control. Press the up/down arrow buttons to scroll through the track numbers (recordings) in the channel banner.

**Note:** Use the Recordings menu in the Main menu to play and delete recordings.

# Using the TV's Features

For the different subchannels, press CH+ or CH-. In addition, pressing the left arrow button allows instant replay and pressing the right arrow button skips ahead on an AVHDD.

- To do a DTVLink timer recording, schedule it through the *Record/Wake Timer* menu (go to page 69). Once the timed recording is set up, the TV automatically makes a timed DTVLink recording if the channel is digital, no matter what signal source is selected. The recording takes place every day for the duration that is selected in the *Record/Wake* menu.

## Set up DTVLink Recording Preferences

To successfully record digital content via the DTVLink Input/Output jack, you need to set up the *Recording Device* screen.

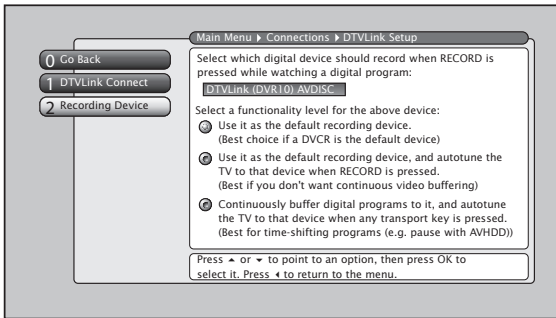

1. Go to the *DTVLink Setup* menu in the *Connections* menu.
2. Highlight *Recording Device*, and press the OK button (only DTVLink components that are capable of recording appear). If you have more than one DTVLink recording component, press OK to pick the DTVLink default recording component (i.e., the component you want to record when you press RECORD on the remote or set up a Record/Wake Timer).

**Note:** If you set the option to OFF, the component you set in the TV Guide initial setup will be the recording device when you press the RECORD button on the remote.

3. Select what you want the recording device to do when you begin recording:

Select *Use it as the default recording device* if you have a DVCR connected. Recording starts when you press the RECORD button. The TV doesn't tune to the DTVLink component's input to allow you to view the channel you're recording.

Select *Use it as the default recording device, and autotune the TV to that device when RECORD is pressed*. This goes to the DTVLink component's input and lets you view what's being recorded when you press the RECORD button.

Select *Continuously buffer digital programs to it, and autotune the TV to that device when any transport key is pressed*. This lets you view what's being recorded and you can use instant replay, pause, etc. to create time-shifting of digital programs.

## Emergency Alert System (EAS)

The EAS works only if you have a digital cable card connected to the CableCARD slot on the back of the TV. Your cable company informs you of emergency alert information related to your state or local-level emergencies, such as Flash Flood Warnings, Severe Thunderstorm Warnings, and Tornado Watches. When your TV receives a state or local-level emergency, a message is displayed that lasts approximately 2 minutes, but can be repeated if necessary. During this time, you can't clear the information being displayed. In the rare event that there is a national-level emergency, your TV would tune to a channel broadcasting the emergency information.

# Using the TV's Menu System

### Chapter Overview:

- Menus, On-Screen Help, and Control Panels
- Picture Quality Menu
- Audio Menu
- Recordings Menu
- Connections Menu
- Preferences Menu

SCENIUM

# Using the TV's Menu System

## Menus, On-screen Help, and Control Panels

This section highlights your TV's on-screen menu system. The menu system has several types of screens. An overview follows.

**Note:** The Parental Controls and Web Browser menu items are discussed in the Features chapter while Assisted Setup is discussed in the Connections and Setup Chapter.

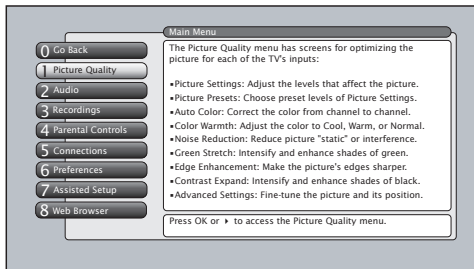

### Tips

A shortcut method to access a menu item is to press the number button on the remote that matches the number next to the on-screen menu. For example, in the Main Menu, press 2 to go straight to the Audio menu.

Feel free to explore the menu system. If you're ever unsure where you are in the menu system, look at the menu path at the top (for example, Main Menu, Picture Quality) or if you're just tired of exploring, press CLEAR to remove the menus from the screen and start over again.

## Navigating the Menu System

The first menu you see when you press the MENU button on the remote is called the *Main Menu*. To access the *Main Menu*:

1. Press the MENU button (the *Main Menu* appears).
2. Use the arrow buttons (left, right, up, down) to move through the menu and highlight different options.
3. Press the OK button to select a highlighted item.

**Note:** Press the number button on the remote that matches the number next to the on-screen menu to select the option.

To exit the *Main Menu*:

- Press CLEAR. The on-screen displays are cleared from the screen and you return to TV viewing.
- Press MENU.
- Press 0 (Go Back) or GO BACK on the remote.

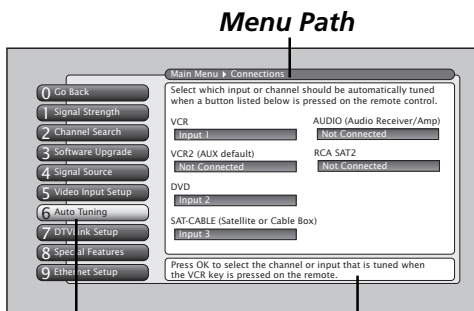

Highlighted  
Menu  
Selection

Help Text

## On-Screen Help

Information appears on most screens to assist you in understanding your menu selection. To the right of the highlighted menu item is a display area that might provide text for the item selected along with any submenu items. In addition, a menu path appears at the top of the screen to let you know where you are in the menu system. At the bottom of the screen are two lines of help text that explain the currently highlighted item.

## Controls

Controls let you adjust the default settings of your TV. You can choose a setting, enter a number, or adjust a level such as tint or brightness. There are four types of controls:

- Sliders
- Choice lists (check boxes, radio buttons)
- Alpha/numeric entries
- Menu (action, choice fields)



# Using the TV's Menu System

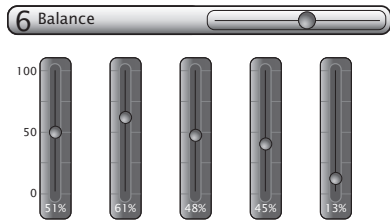

## Sliders

Sliders are used to select a specific point of a control that has continuous levels. To make adjustments:

1. Highlight the slider for the feature you want to adjust.
2. Press the up or down arrow button to adjust the indicator on a vertical slider. Press the left or right arrow to adjust the indicator on a horizontal slider.



Check Boxes



Radio Buttons

## Choice Lists

Check boxes and radio buttons are used to select options from a list. Check boxes let you select one or more options. A radio button lets you select only one option.

1. Use the arrow buttons to move left/right/up/down.
2. Press OK to select a radio button; press OK to select or de-select a check box.



## Numeric Entries

Numeric entry fields are used to enter numbers, passwords, and time values. The number buttons on the remote and the arrow, channel up/down, volume up/down, MENU and OK buttons on the front panel can be used to enter the information.

1. Use the left/right arrow button to highlight the field.
2. To enter time values, such as the Record/Wake Timer, highlight the + or - field and press OK to change the time, or simply use the number buttons. To enter passwords, you must use the number buttons.



## On-screen Menu Items

The on-screen menu items are used to access the information and/or change the settings of the specific item highlighted. Highlight the item with the up and down arrow buttons. Then press OK or right arrow button to access the item's information. To make a selection in one step, press the number button corresponding to the item.



## Action Buttons

An on-screen button that performs the action labelled on the button. Press the right arrow button to highlight and press OK to select.

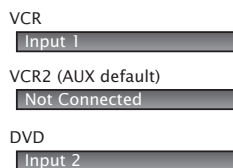

## Choice Fields

A choice field cycles through at least two or more choices. Press OK to select the next entry within the choice field. Moving the highlight to a different choice field, pressing CLEAR, or exiting the menu saves the selection previously made.

# Using the TV's Menu System

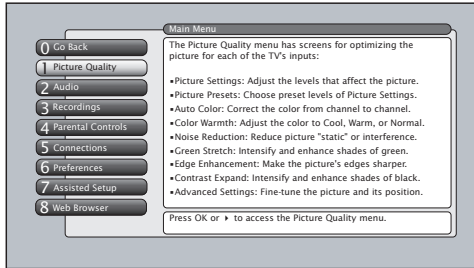

## Picture Quality Menu

The *Picture Quality* menu contains menus to configure video settings: *Picture Settings*, *Picture Presets*, *Auto Color*, *Color Warmth*, *Noise Reduction*, *Green Stretch*, *Edge Enhancement*, *Contrast Expand*, and *Advanced Settings*. Each one is described below.

**Note:** When changing an item in the *Picture Quality* menu, the graphics become transparent so you can see how your adjustments affect the picture.

To access the *Picture Quality* menu:

1. Press MENU on the remote control (the *Main Menu* appears).
2. Highlight *Picture Quality* and press OK (the *Picture Quality* options appear). Each is described below.

**Note:** When making *Picture Quality* changes, inputs are all adjusted independent of each other. Digital cable and antenna channels are adjusted independent of analog cable and antenna channels.

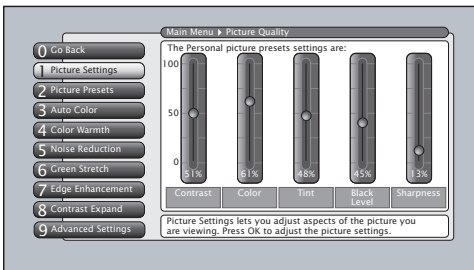

## Picture Settings

The *Picture Settings* menu displays five slider controls for adjusting the way the picture looks. Your options under the *Picture Settings* menu are:

**Contrast** Difference between the light and dark areas of the picture.

**Color** The richness of the color.

**Tint** The balance between the red and green levels.

**Black Level** The brightness of the picture.

**Sharpness** The crispness of the edges in the picture.

To create picture settings for the video inputs:

1. Press the INPUT button while in the *Picture Settings* menu until the correct Video Input Channel appears in the upper right corner.
2. Press the right and left arrow buttons on the remote control to select the slider.
3. Press the up and down arrow buttons to operate the slider.

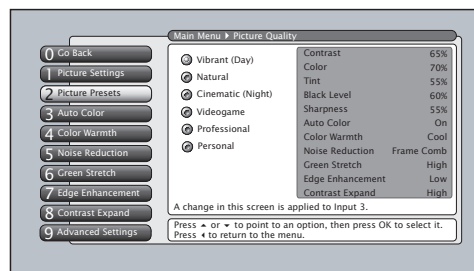

## Picture Presets

*Picture Presets* displays a choice list that lets you select one of the six preset picture settings: *Vibrant (Day)*, *Natural*, *Cinematic (Night)*, *Videogame*, *Professional*, and *Personal*.

Choose your setting based on the degree of lighting in your room. After you select a preset, the settings listed to the right are adjusted automatically.

If you choose *Personal*, you can customize each *Picture Quality* setting to your desired level, and a message appears to asking if you want to save those settings. After you've saved your personal settings, you can go back into the menu and select a different picture preset. For example, if you normally use *Personal* but want to watch a show in *Vibrant (Day)* lighting, choose *Vibrant (Day)*, watch the show, and then afterwards return to your customized settings by choosing *Personal*. The PRESETS button on the remote works with *Picture Presets*. Go to the Remote chapter for more information.

### Tip

To create a temporary personal setting, make your changes and when the message appears asking if you want to save the setting, select No. The preset is saved until you change the channel or input.

# Using the TV's Menu System

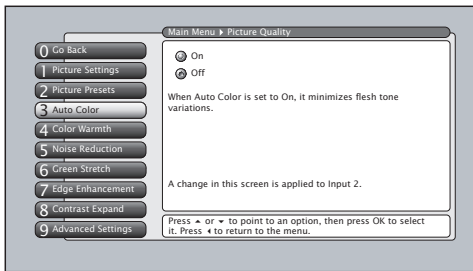

## Auto Color

*Auto Color* minimizes the flesh tone variations of the TV picture. Choose *On* or *Off*, depending on your preference.

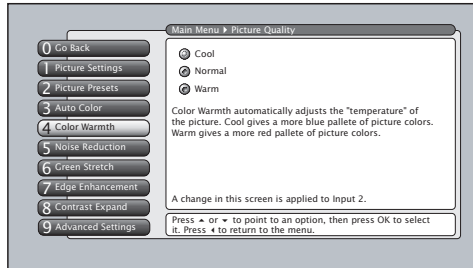

## Color Warmth

*Color Warmth* automatically adjusts the color temperature of the picture. The feature lets you set one of three automatic color adjustments:

**Cool** More blue.

**Normal** Standard picture color.

**Warm** More red.

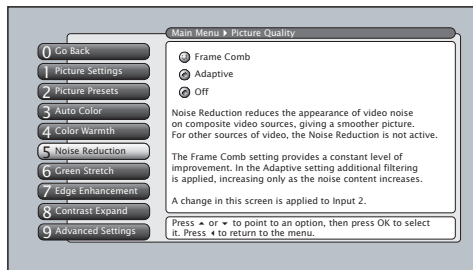

## Noise Reduction

*Noise Reduction* displays a list that lets you set one of the three settings that allows you to reduce picture “static” or any type of interference. A different *Noise Reduction* setting can be stored for each input, but only applies to components connected to composite and NTSC sources. You can set the *Noise Reduction* to *Frame Comb*, *Off* or *Adaptive*. The settings are explained in the on-screen help text.

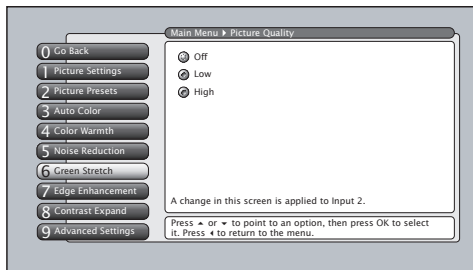

## Green Stretch

*Green Stretch* makes green “greener” and increases the saturation. For example, nature shows and sporting events are especially enhanced by this feature. The options are *Off*, *Low*, and *High*.

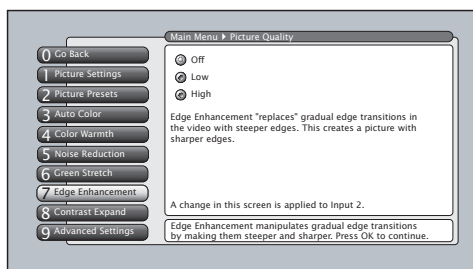

## Edge Enhancement

*Edge Enhancement* makes the edges of the video steeper, sharper, and crisper. There are three options for the edge enhancement: *Off*, *Low*, or *High*. If artifacts appear in the video, change the setting to *Low* or *Off*.

# Using the TV's Menu System

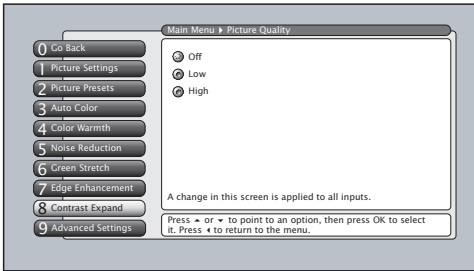

## Contrast Expand

*Contrast Expand* makes the picture appear brighter by deepening the black parts of the picture. This also helps to maintain a more consistent black level from one scene to the next. The options are *Off*, *Low*, and *High*.

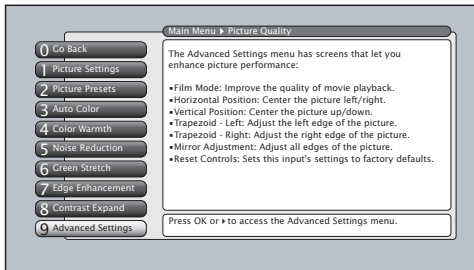

## Advanced Settings

The *Advanced Settings* option lets you enhance picture performance and adjust picture position. When you select *Advanced Settings*, a submenu appears with options:

**Film Mode** Automatically detects video sources that were originally recorded on film and converted to a different format. Film mode modifies the converted signal so it looks as close as possible to the original, a process called reverse 3:2 pulldown. Film mode is applied to all inputs. Options are:

- **Advanced** The default and recommended setting.
- **On** Used in circumstances when the TV is to be used solely with film-based sources.
- **Off** Use this setting if you think the reverse 3:2 pulldown is causing distortions in your picture.

**Horizontal Position** Allows you to adjust the picture left and right. Press the right arrow button to move the slider right and move the picture to the right. Press the left arrow button to move the slider left and move the picture to the left.

**Vertical Position** Allows you to adjust the picture up and down. Press the right arrow button to move the slider right and move the picture up. Press the left arrow button to move the slider left and move the picture down.

**Note:** Horizontal *and* Vertical Position *are applied to each input*.

**Trapezoid- Left** If the corners of the left side of the TV appear slanted, this allows you to adjust the top of the left vertical line of the test pattern. Press the left or right arrow button to align the test pattern so it is parallel with the left edge of the screen.

**Trapezoid- Right** If the corners of the right side of the TV appear slanted, this allows you to adjust the top of the right vertical line of the test pattern. Press the left or right arrow button to align the test pattern so it is parallel with the right edge of the screen.

**Note:** Trapezoid- Left *and* Right *are applied to all inputs*.

# Using the TV's Menu System

**Mirror Adjustment** Over time the small mirror inside the TV may shift slightly. You'll notice the edges of the picture aren't symmetrical or parallel, or one of the top corners is too far in or out. Try adjusting the edges by using *Trapezoid-Left* and *Right*. If this doesn't help, use the screws behind the front panel piece to adjust the corner edges while watching the test pattern on screen. Use a 4 mm. Allen wrench or Philips screwdriver to adjust the screws. Go to page 10 for information on removing the front panel piece and location of the mirror adjustment screws.

Press OK to select *Mirror Adjustment* and select *Yes* to continue. Selecting *Yes* resets *Trapezoid-Left* and *Right* adjustments you've made.

With the test pattern on screen, look at the top corners of the test pattern. Adjust the corner that is farthest in towards the center of the TV so the top horizontal line is parallel with the top edge of the TV. For example, if the left corner is farthest in towards the center, turn the left screw counterclockwise. If you feel a resistance as you turn the screw, stop turning it. Tightening the screw more could damage it (try turning the opposite screw clockwise). Now see if the left and right lines are parallel. If they aren't, use the middle screw to adjust them until they're parallel with the edges of the TV. If necessary, use the up and down arrow buttons on the remote to vertically center the test pattern. To exit the test pattern, press OK, then use the *Trapezoid-Left* and *Right* option to fine tune the picture, if necessary.

**Reset Controls** Menu button resets all Picture Quality controls to their original factory settings (except *Personal Picture Preset* and *Horizontal* and *Vertical Position*) for the currently tuned input (see on-screen text). To reset the settings, you must:

1. Tune to the input you would like to reset.
2. Press MENU to access the *Main Menu*.
3. From the *Advanced Settings* menu, select *Reset Controls*, and then select *Reset* to reset the settings for the currently tuned input.

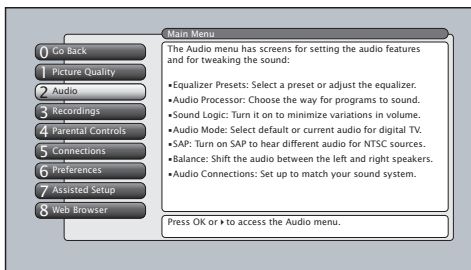

## Audio Menu

The *Audio* menu lets you adjust audio output. To access the *Audio* menu, press MENU on the remote, and then select *Audio* from the main menu. The following audio items can be adjusted: *Equalizer Presets*, *Audio Processor*, *Sound Logic*, *Audio Mode*, *SAP*, *Balance*, and *Audio Connections*.

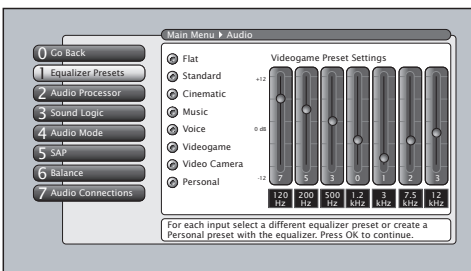

## Equalizer Presets

You can select one of the seven-band Equalizer Presets or create your own personal preset. The seven-band graphic equalizer lets you adjust the audio frequency settings. The equalizer can only be changed if the *Fixed/Variable Audio Output* is set to *Variable Output*, *Speakers On*. If the *Fixed/Variable Audio Output* is set to *Fixed Output*, you cannot make changes to the equalizer and the bands are set to 0dB. However, the graphic equalizer levels for *Variable Output*, *Speakers On* are stored in memory in case you switch from *Fixed Output* back to *Variable Output*, *Speakers On*.

**Note:** *Equalizer Presets* are stored for each input. All other audio feature settings are stored globally across all inputs and not per input.

# Using the TV's Menu System

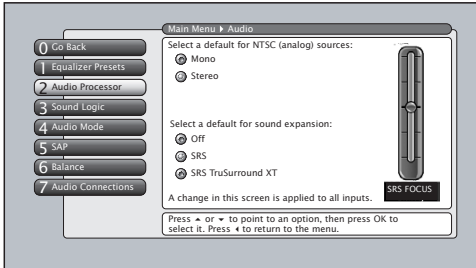

## Audio Processor

The Audio Processor displays a choice list of available audio modes, which control the way the sound comes through your speakers when TV is set to using the *Variable Output*. The selected setting affects all inputs and tuners.

To create the settings:

1. Press the MENU button to access the main menu.
2. Select *Audio*, and then *Audio Processor*. The following options appear:

**Mono** Plays the sound in monophonic audio only. This should only be used when the stereo signal is weak. The channel banner displays the word *Mono* when you have selected Mono and SRS is turned off.

**Stereo** Splits the incoming stereo audio signal into left and right front channels. Most TV programs and recorded materials have stereo audio. The channel banner displays the word *Stereo* when you have selected Stereo and SRS is turned off.

The following options are available only if the Fixed/Variable Output is set to Variable:

**Off** No SRS processing is applied to the audio.

**SRS FOCUS** Adds greater depth and stereo separation to stereo audio signals. Delivers a panoramic 3D sound stage from stereo material. Use the SRS FOCUS adjustment on the right to adjust the clarity.

**SRS TruSurround XT** Creates a virtual surround sound from multichannel source material through any two-speaker playback system. Use the SRS Dialog Clarity adjustment on the right to adjust the clarity.

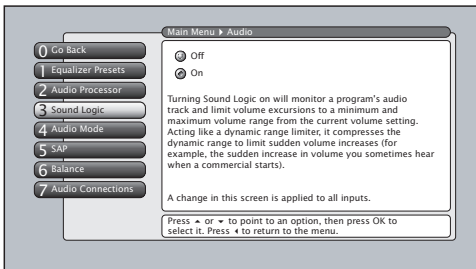

## Sound Logic

Acting like a dynamic range limiter, it compresses the dynamic range to limit suggested volume increases (for example, the sudden increase in volume you sometimes hear when a commercial starts). Choose *On* or *Off*, depending on your preference.

TruSurround XT, SRS and (SRS) symbol are trademarks of SRS Labs, Inc.  
TruSurround XT technology is incorporated under license from SRS Labs, Inc.

# Using the TV's Menu System

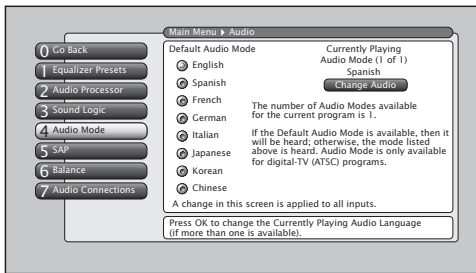

## Audio Mode

The *Audio Mode* menu lets you choose the default audio mode you want to hear for ATSC or QAM (digital TV) programs. If the Audio Mode icon (  ) in the banner lights, it means there is more than one audio mode available. The system automatically sets the audio program to the default audio mode from the menu when the channel you are viewing is a digital channel and the specified language is available for that program.

In the *Audio Mode* menu, highlight the default audio mode you want by pressing the up and down arrow buttons on your remote control. Press OK to hear that language by default whenever available on a channel.

Some programs can have audio mode available that can be heard but that cannot be set as the default. To select and hear those audio modes, navigate to the “Change Audio” action button and select OK, or use the SOUND button on remote.

**Note:** You can change the Audio Mode temporarily by pressing the SOUND button on the remote control. Changing channels reverts the Audio Mode back to the Default Audio Mode originally selected in the menu.

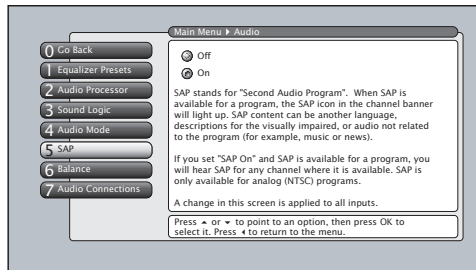

## SAP (Second Audio Program)

When turned on and available, Second Audio Program plays the analog (NTSC) program's audio in a second language. SAP is also used to broadcast a program's audio with descriptions of the video for the visually impaired. SAP might also contain audio which is totally unrelated to the video.

**Notes:** SAP is broadcast in mono and is only available for analog programs, not digital programs.

You can activate SAP (if available) temporarily with the SOUND button. Changing channels or inputs reverts SAP back to the SAP menu setting.

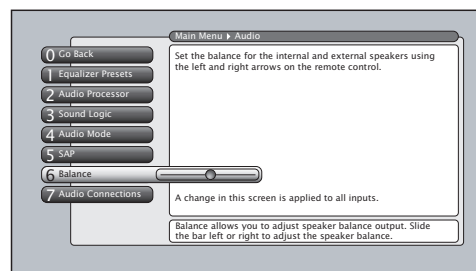

## Balance

The *Balance* setting applies to the internal speakers. Balance is how much audio (loudness) gets sent to the left and right speakers.

**Note:** Balance applies if the Fixed/Variable Audio Output is set to Variable Output, Speakers On. See the following page for more information.

# Using the TV's Menu System

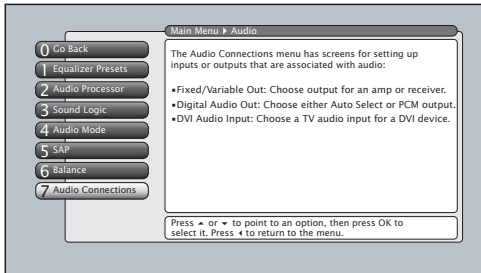

## Audio Connections

The Audio Connections menu option lets you set up input or outputs associated with audio. When you select the Audio Connections feature, a submenu appears with four options: *Fixed/Variable Out*, *Digital Audio Out*, and *DVI Audio Input*.

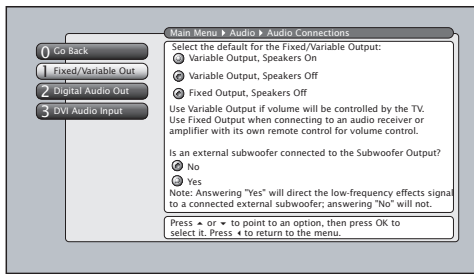

**Fixed/Variable Out** Displays a choice list that lets you turn the TV's front internal speakers on or off and set the Fixed/Variable audio output to a fixed or variable volume output level. The choices are:

- **Variable Output, Speakers On** Turns the TV's front speakers *On* and allows variable output from the TV's FIXED/VARIABLE AUDIO OUTPUT jacks. Use this setting if the TV is not connected to an audio receiver or amplifier and the volume is controlled by the TV.
- **Variable Output, Speakers Off** Turns the TV's front speakers *Off* and allows variable output from the TV's FIXED/VARIABLE AUDIO OUTPUT jacks. Use this setting if the TV is connected to an audio receiver or amplifier and the volume is controlled by the TV.
- **Fixed Output, Speakers Off** Turns the TV's front speakers *Off* and provides fixed output from the TV's FIXED/VARIABLE AUDIO OUTPUT jack to a receiver or amplifier. With the Fixed Output, the TV's volume control, graphic equalizer, balance, and mute are disabled. This output is ideal when connecting to an audio receiver or amplifier that has its own remote control for controlling the volume.
- **Is an external subwoofer connected to the Subwoofer Output?** This option only appears when *Variable Output, Speakers On* is selected. Select *Yes* if you want the low bass frequencies to be directed from the SUBWOOFER Out jack to the connected external subwoofer; select *No* if not.

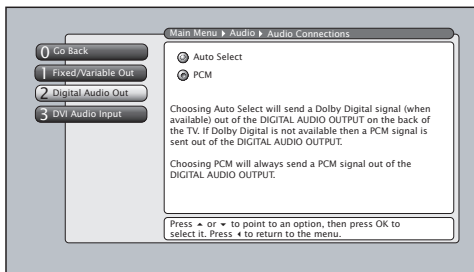

**Digital Audio Out** Allows you to receive Dolby Digital surround sound if transmitted and you've connected a six-channel receiver to the TV's DIGITAL AUDIO OUTPUT jack with a digital optical cable. Choose the correct setting in the *Digital Audio Out* menu:

- **Auto Select** Your TV automatically chooses between Dolby Digital and PCM based on the audio signal it is receiving. This is the best selection if you have a decoder with Dolby Digital and PCM that was manufactured in the last several years.
- **PCM** (Pulse Code Modulation) The TV sends all signals through the Digital Audio Output in PCM.



# Using the TV's Menu System

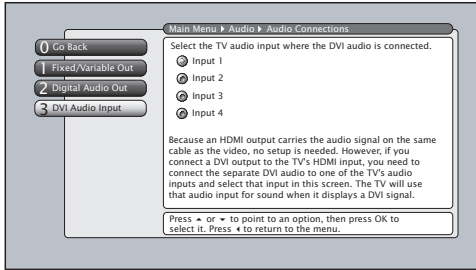

**DVI Audio Input** Allows you to select the audio input you're using if you've connected an HDMI/DVI cable adapter to the DVI input. Select from the inputs listed.

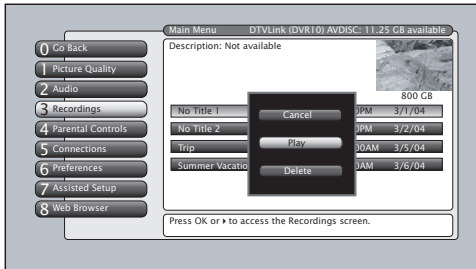

## Recordings Menu

The *Recordings* Menu allows you to view the list of programs you've recorded to the components connected to your DTVLink jacks. When you highlight and select a program, the options *Cancel*, *Play*, and *Delete* appear. To play a program listed, highlight *Play* and press OK. The program plays in the small video window. To view the program in full screen, press CLEAR or MENU. You can see other DTVLink component's recordings by pressing the INPUT button with this menu displayed.

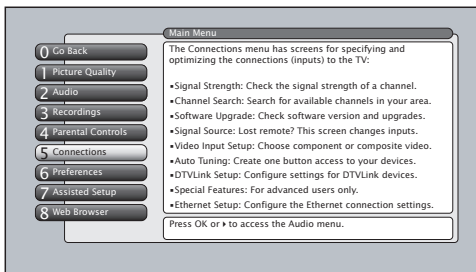

## Connections Menu

The *Connections* menu specifies various ways to adjust the inputs to your television. Items in the *Connections* menu are: *Signal Strength*, *Channel Search*, *Software Upgrade*, *Signal Source*, *Video Input Setup*, *Auto Tuning*, *DTVLink Setup*, *Special Features*, and *Ethernet Setup*.

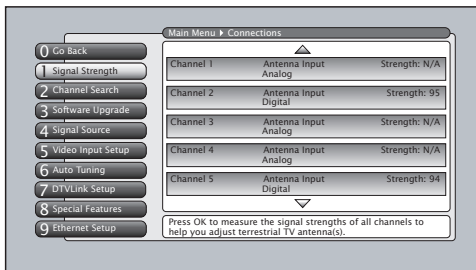

## Signal Strength

This screen lists any channel EVER added to the TV. The list shows the channel number, the station name (only when tuned, e.g. NBC), whether the channel is digital or analog, which tuner is picking up the channel, and current signal strength of digital channels.

When you move the highlight to the *Signal Strength* list, the TV attempts to tune to that channel. You can then adjust your off-air antenna for maximum signal strength (largest number) for the selected channel. The signal strength for a digital channel will be shown as “-” until the signal is strong enough for use, then numbers will appear. Analog channels will always have the display, “N/A”, since analog signal strength is not measured.

Only primary channels appear in the list. Digital subchannels, e.g. 8-1, 8-2, do not appear.

**Note:** If you have both Antenna and Cable channels, press the ANT•CAB button to view your Cable channels, or vice-versa.

# Using the TV's Menu System

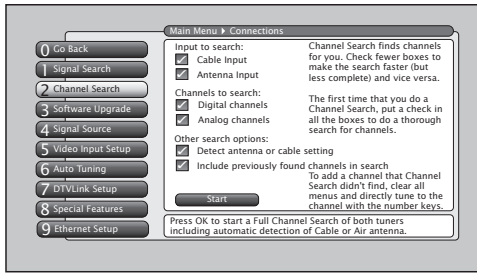

## Tip

You can still add a channel that was not found by Channel Search. Clear any on-screen menus, and tune to it by using the number buttons on the remote. If the channel can be tuned, it will be added to the channel list for that tuner.

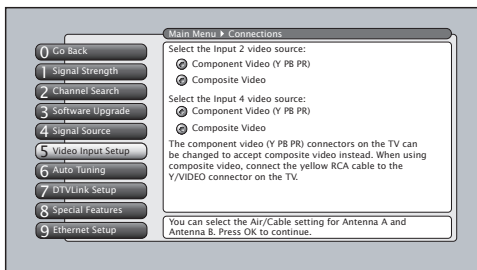
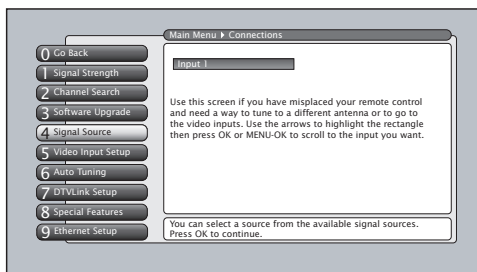
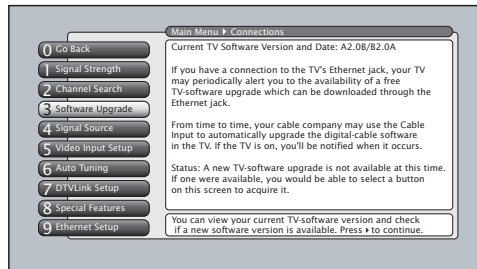

## Channel Search

Engaging in a channel search tells the TV to search for all the terrestrial TV channels available through the Antenna and Cable Inputs. When the TV finds an active channel, it places it in the channel list. Inactive channels (weak stations or channels with no signal at all) aren't placed in the channel list.

To do a complete channel search, check each box that pertains to your TV. For example, if you're only receiving cable from the CABLE INPUT, highlight *Cable Input* and press OK to place a checkmark in the box. Select *Start* to begin the search.

**Notes:** *Channel Search with all options selected takes a long time to complete because all possible analog and digital channels are being searched.*

*If a cable box is connected to your TV's CABLE INPUT or a CableCARD is in use, Channel Search won't work for Cable Input.*

## Software Upgrade

The *Software Upgrade* screen contains current software information and indicates if a new upgrade is available. The software information and upgrades can be accomplished only if you have the TV connected via the Ethernet cable to the Internet with ISP subscription. Select the *Upgrade Now* button, if available, to upgrade your software.

**Note:** *If using a dialup service via a router connected at a dialup speed of 56K, the Software Upgrade could take several hours or more. If the TV is unplugged during a Software Upgrade, it could cause the TV to not operate properly.*

## Signal Source

The *Signal Source* menu allows you to choose the source from which you would like the signal to come: Cable Input, Antenna Input, or Video Inputs. The same can be accomplished using the component buttons if you've set up Auto Tuning on the remote or by pressing the ANT•CAB or INPUT button. But, if you misplace the remote, this feature gives you another way to tune to a signal source.

## Video Input Setup

The *Video Input Setup* screen lets you choose which type of connection you're using for the Input 2 and/or Input 4 jack on the back of the TV. If you decide to change the connection, you need to go back into the *Video Input Setup* screen.

# Using the TV's Menu System

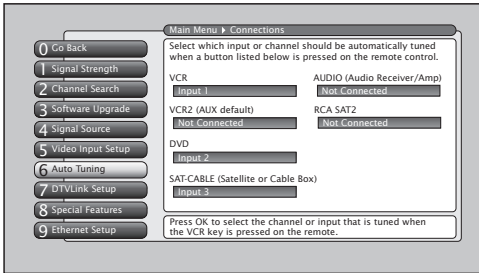

## Auto Tuning

This menu lets you specify the various components you have connected to your TV. It lets you program a component button on the remote control (VCR, AUX, DVD, SAT/CAB, or AUDIO) so that pressing the button automatically turns on the TV and turns the TV to the correct Video Input Channel (go to Chapter 3 for detailed information).

**Notes:** *The AUX button by default is set up for a second RCA VCR. If you need to reprogram the AUX button, or instead want to program the VCR button, use the 2001 code. Then use the VCR2 option in the auto tuning menu to set auto tuning.*

*If you have two RCA satellite receivers, you can control each separately. Program the second receiver with the AUX button using the 5001 code. Then use the RCA SAT2 option in the auto tuning menu to set auto tuning.*

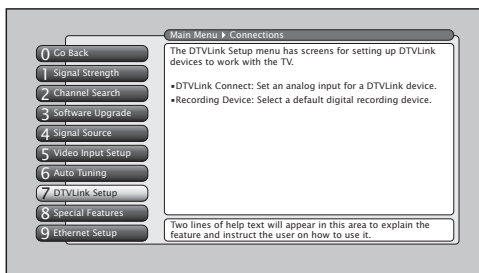

## DTVLink Setup

The DTVLink Setup option lets you set items specific to the component(s) connected to your DTVLink (1394) jack(s).

- *DTVLink Connect* applies to those DTVLink components that require a DTVLink and analog connection. Only that type of DTVLink component will appear. Highlight the choice field under your model, and press OK to choose the analog input you're using.
- If you have more than one DTVLink component connected to your TV, the *Recording Device* menu allows you to choose which component you want to use as your default to record when you press the RECORD button on your remote and component. Go to page 52 for more information on setting a DTVLink recording and for an explanation of the options in the screen.

**Notes:** *The TV only outputs video and audio to a component which enforces copy-protection measures.*

*Some components that don't support Digital Copy Protection may cause errors on the DTVLink connection if another source that supports Digital Copy Protected material is connected to the DTVLink.*

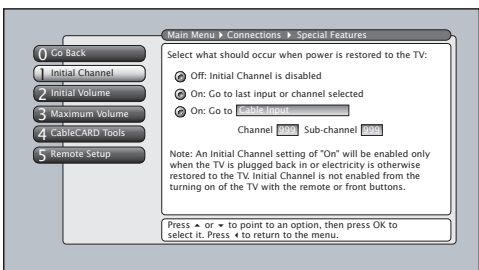

## Special Features

The special features options are mostly intended for commercial/retail use.

**Initial Channel** You can select the channel that your TV tunes to each time the TV is turned on by plugging it back in. Choose a video input or select *Antenna* or *Cable Input* and select a channel.

**Initial Volume** This feature works only if the *Initial Channel* feature is set to *On*. Select the volume level that you want when the TV is turned on.

**Maximum Volume** This feature is intended to stop the volume from being turned up too loudly. Set the volume at the loudest level you would want to hear.

# Using the TV's Menu System

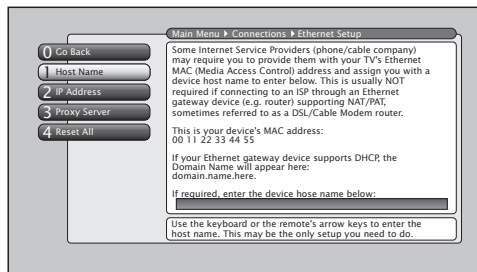
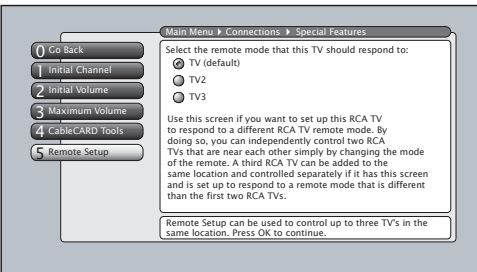
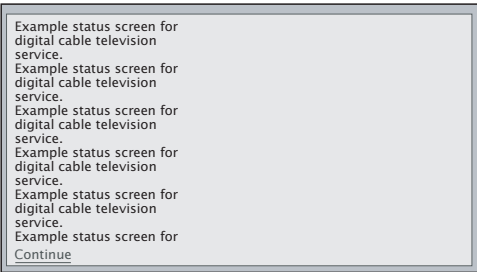
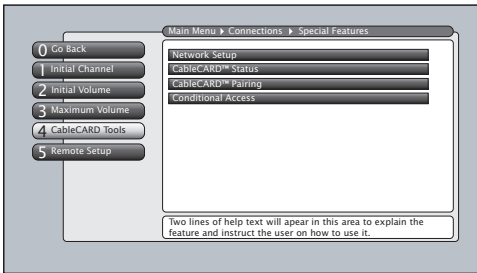

**CableCARD Tools** Displays information available for digital cable TV services when a CableCARD is inserted in the back of the TV and you have subscribed to digital cable service. Go to page 20 for more information on using your CableCARD.

The *CableCARD Tools* information might vary according to the brand of card you have inserted into your TV. The graphic to the left is an example of what you might see. Select an option to view more information.

Some *CableCARD Tools* screens might have additional information displayed on more than one page. Use the arrow buttons on the remote to highlight the blue link at the bottom of the page, for example *Continue* as the graphic to the left shows, and simply press the OK button on the remote to read more text. If more than one link appears, use the arrow buttons to highlight the one you want. To exit the screen, press CLEAR on the remote.

**Remote Setup** This feature allows you to control three different RCA TVs. This is helpful if you have two or three RCA TVs near each other, and they also have this menu option, but you want to control them independent of each other. Program a second RCA TV to the DVD, VCR, AUX, SAT/CABLE, or AUDIO component button, using the TV2 code 1222. Select the TV2 option in that TV's *Remote Setup* menu. If you have a third RCA TV, program a component button using the TV3 code 1223. Select the TV3 option in that TV's *Remote Setup* menu. Go to Chapter 2 for more information on programming your remote.

## Ethernet Setup

If you have a NAT (Network Address Translation)/PAT (Port Address Translation) component with DHCP capability (router, etc.), no setup is required. The TV automatically sets itself up for Ethernet use. If you do not have a NAT/PAT router, you may need to establish some settings in conjunction with your ISP (Internet Service Provider) before you can connect to the Internet. See Ethernet connection on page 23 for more information.

If an IP address isn't assigned for you, contact your network administrator to access the necessary information.

A *Reset All* selection is provided for your convenience if you move to another city and must enter new information, or you enter some incorrect information.

# Using the TV's Menu System

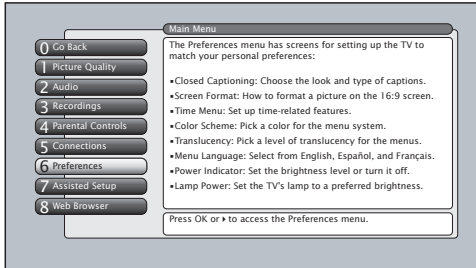

## Preferences Menu

The *Preferences* menu allows you to change some aspects of your TV to fit your personal preferences. Features in the *Preferences* menu are: *Closed Captioning*, *Screen Format*, *Time Menu*, *Color Scheme*, *Translucency*, *Menu Language*, *Power Indicator*, and *Lamp Power*.

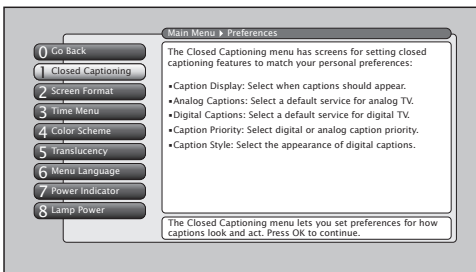

## Closed Captioning

You may set the type of captioning displayed. Captioning is not available from the PIP tuner. Choices within the *Closed Captioning* menu are: *Caption Display*, *Analog Captions*, *Digital Captions*, *Caption Priority*, and *Caption Style*.

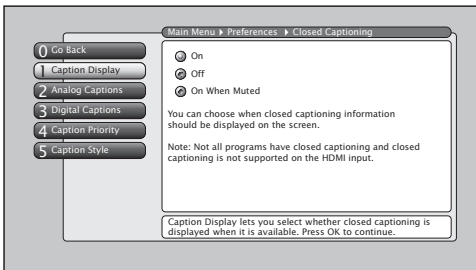

## Caption Display

The *Caption Display* menu displays a choice list that lets you choose when closed captioning information is shown on the screen. HDMI/DVI input is not supported by Closed Captioning (CC). Try the HDMI or DVI component's menu system for CC options.

**On** Captioning information is always shown, when it's available on a channel or input.

**Off** No captioning information is displayed.

**On When Muted** Captioning information is only shown when available and the TV's sound is muted. (To mute the sound, press the MUTE button on the remote control and captioning information will appear on the screen, if available.)

**Notes:** Use the CC button on the remote to toggle CC on and off. Go the remote section for more information.

If you turned off the speakers in the Audio menu (Fixed Output, Speakers Off), Closed Captioning won't appear when you press the MUTE button on the remote even when you choose On when Muted.

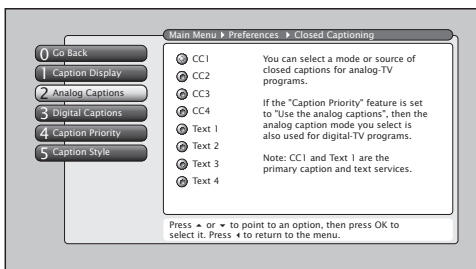

## Analog Captions

You can select a closed caption mode, which is the mode or source used for displaying captioning information for analog channels or digital channels, if available. The content of CC and Text are different; you can select which one you want to see on the screen.

**CC** Displays information at any position on the screen. It overlays the text on top of the picture as it is received.

**Text** Displays information at one particular position (such as the bottom third) of the screen. You cannot see the picture underneath the text.

You can choose between eight closed caption modes:

**(continued on next page)**

# Using the TV's Menu System

- **CC1** and **Text 1** are the primary caption and text services. The captioning or text is displayed in the same language as the program's dialog.
- **CC3** and **Text 3** serve as the preferred data channels. The captioning or text is often a secondary language translation, simplified English, or displayed at a slower rate.
- **CC2** and **CC4** and **Text 2** and **Text 4** are rarely available and broadcasters use them only in special conditions, such as when CC1 and CC3 are not available, or Text1 and Text3 are not available.

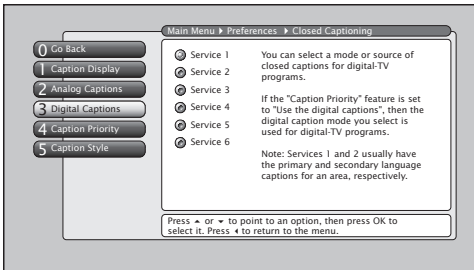

## Digital Captions

You can select a closed caption, service mode (1-6) for digital channels.

**Service 1** and **Service 2** are the primary and secondary languages, respectively.

**Service 3** and **Service 4, 5, 6** are additional caption sources that may be available. Specific label names may be displayed (e.g., Spanish) instead of a generic label (e.g., Service 1), if available.

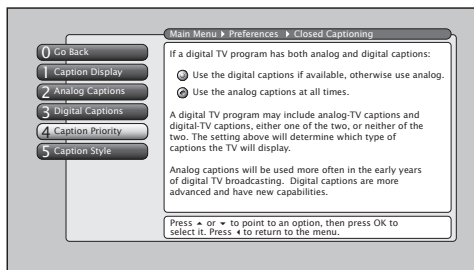

## Caption Priority

You can choose whether the TV uses digital or analog captions for digital TV programs that have both or either. The captions are displayed if turned on in *Caption Display*.

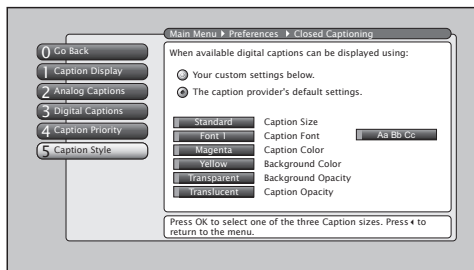

## Caption Style

Customize closed captioning for the digital captions by choosing the settings for the following options:

**Caption Size** is the font size (*Standard, Large, Small*) of the text characters.

**Caption Font** is a complete assortment of letters, numbers, punctuation marks, etc. of a given font design. You have eight fonts with varying styles of spacing from which to choose.

**Note:** A preview graphic of the caption font appears on the right of the screen.

**Caption Color** allows you to choose the font color: *White, Black, Red, Green, Blue, Yellow, Magenta, and Cyan*.

**Background Color** allows you to choose the background color: *White, Black, Red, Green, Blue, Yellow, Magenta, and Cyan*.

**Background Opacity** allows you to change the see-through background options: *Solid, Transparent, Translucent, and Flashing*.

**Caption Opacity** allows you to change the see-through caption options: *Solid, Transparent, Translucent, and Flashing*.

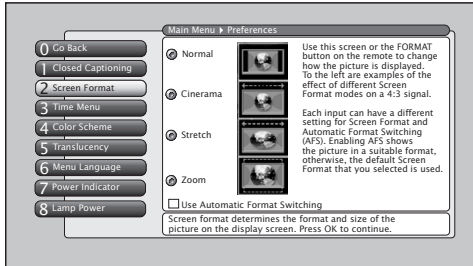

## Screen Format

The *Screen Format* feature allows you to change how the image of a 4:3 picture is displayed on your 16:9 screen. The options are *Normal*, *Cinerama*, *Zoom* or *Stretch*. If your TV receives an image with a 4:3 aspect ratio, the image can be displayed in one of four ways:

**Normal** The image of a 4:3 video signal is centered with bars on the right and left sides of the screen.

**Cinerama** The image of a 4:3 video signal is centered, expanding in the horizontal direction to fill the display with little distortion.

**Stretch** The image of a 4:3 video signal is stretched horizontally by approximately 33% while the vertical size stays the same.

**Zoom** The image of a 4:3 video signal increases by approximately 33% and the vertical size increases by approximately 33%. Edges of the image might be cropped.

**Note:** When recording from the AUDIO/VIDEO OUTPUT jacks, use *Normal* or *Stretch* to record the video closest to its original format.

Turn on *Automatic Format Switching* so that as you change channels, the TV will change formats for you.

**Notes:** There is no ability provided to change the screen format for a 16:9 video signal since it fills up the entire area of the TV's screen.

The format of some video cannot be changed even though it appears to be a 4:3 aspect-ratio picture.

The *FORMAT* button on the remote lets you change the format with a one-button press rather than navigating to the *Screen Format* menu.

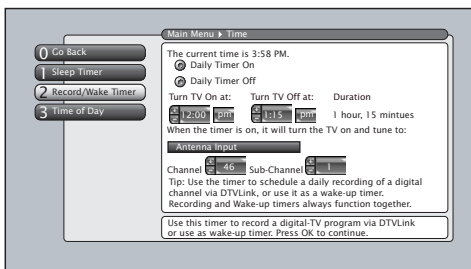

## Time Menu

The *Time* menu lets you set up time-related features and a DTVLink timed recording. *Time* menu consists of *Sleep Timer*, *Record/Wake Timer*, and *Time of Day*.

**Sleep Timer** A one-time event that is used to set the TV to turn off at a specific time.

**Record/Wake Timer** Used to turn the TV on and off at a specific time every day of the week and tune to a specific channel or video input. In addition, it sets the TV to make a DTVLink recording if a DTVLink component is connected, set up, and the channel selected is digital. See page 51 for more information on a DTVLink Recording.

**Time of Day** Enables you to enter the correct time manually. If you don't enter the time, it is acquired from the last tuned digital channel. Make sure you check that the time acquired is correct.

**Note:** If you enter the time manually, you must remember to set your TV's time when the time changes to Daylight Saving Time. Sleep Timer and Record/Wake Timer will not function as you expect if you forget to change the TV's time.

# Using the TV's Menu System

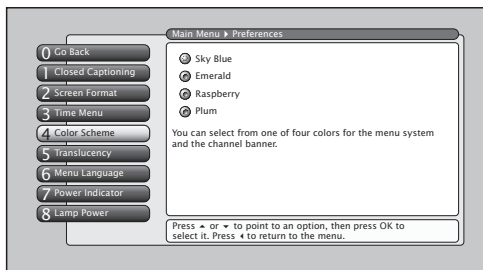

## Color Scheme

Select from among four colors (*Sky Blue, Emerald, Raspberry, and Plum*) to change the color of the menu system and banner.

**Note:** *The browser colors are unaffected.*

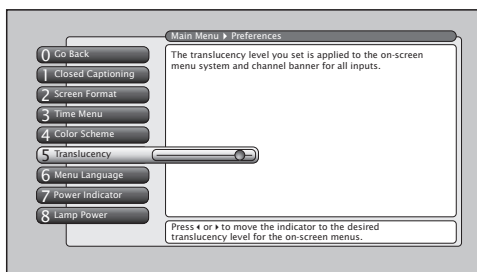

## Translucency

You can change the translucency (see-through) level of the menu screens. Adjust the slider by using the left and right arrow buttons.

**Note:** *This does not apply to the browser.*

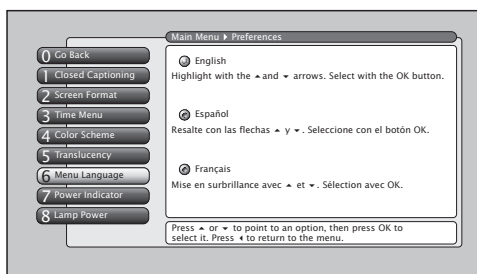

## Menu Language

The menu language can be changed to one of three languages: *English, Spanish* or *French*. The menu language can also be selected when using the *Assisted Setup* menu.

**Note:** *Spanish and French are not available in the browser.*

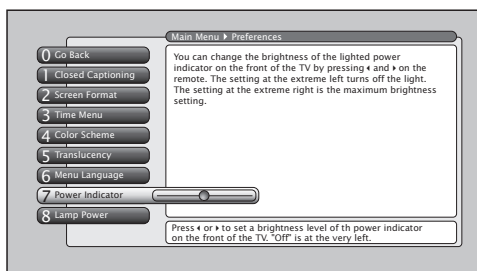

## Power Indicator

You can adjust the brightness of the power indicator that illuminates on the front of the TV when the TV is on. Press the left arrow on the remote to dim the light or turn it off completely by moving the slider all the way to the left. Press the right arrow button on the remote to brighten the light.

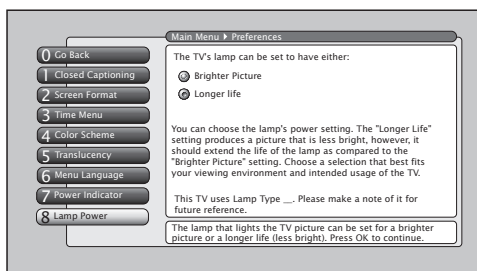

## Lamp Power

Your HDTV is equipped with a special lamp system. Eventually, the lamp (like a light bulb) will need to be replaced and you'll need to know your lamp type. Check the menu for your lamp type and write it down on page 1 for future reference (the lamp type has the same meaning as the lamp part number mentioned on page 1). The *Lamp Power* menu enables you to extend the life of the lamp (choose *Longer Life*), or provide the brightest possible picture (choose *Brighter Picture*).



# Reference

## Chapter Overview:

- Troubleshooting
- Lamp Replacement Instructions
- Specifications
- Accessory Information
- Limited Warranty
- Care and Cleaning
- FCC Information
- Index

SCENIUM

## Troubleshooting

Most problems you encounter with your TV can be corrected by consulting the following troubleshooting list.

**Note for U.S. customers:** *If you prefer, we can provide you with the name of an Authorized Service Representative who will visit your home for a fee to install your electronic entertainment system and to instruct you in its operation. For details about this service, call 1-888-206-3359. For additional assistance while using your RCA Scenium product, please visit [www.rcascenium.com/customersupport](http://www.rcascenium.com/customersupport).*

### TV Problems

---

#### TV won't turn on

- Press the TV button or ON/OFF button while remote is in TV mode and there's a source of power to the outlet or outlet strip.
- Make sure the TV is plugged in.
- Does the power light on the front of the TV turn on and you hear audio but see no picture? If so, the TV is in its cool-down cycle. Wait a few moments and the picture will appear.
- Has the power light on the front of the TV been blinking for one minute? If so, the lamp is dead. Go to page 76 for replacement instructions and page 82 for ordering information.
- When you first plug your TV into an outlet, the Power indicator and Backlight on the front panel will light and blink for approximately 30 seconds and then go off during the initialization of the TV. The TV can only be turned on after the Power indicator goes off. This happens every time power is reapplied to the TV.
- Check the wall receptacle (or extension cord) to make sure it is "live" by plugging in something else, such as a lamp.
- Something might be wrong with your remote control. Press the POWER button on the front of the TV. If the TV turns on, check the remote control solutions on page 75.
- *Remote Setup* might be set to the wrong option. Press MENU/OK on the front panel. Select *Connections*, then *Special Features*, then *Remote Setup*. Choose *TV (default)*.

#### Power indicator is blinking or flashing

If the light blinks 5 times, pauses, and blinks again 5 times, the lamp is trying to turn on. If the TV doesn't turn on after 5 minutes and then the light blinks steadily for one minute, one of the following options is possible:

- Lamp door is open. Locate the door on the side of the TV and close it. Turn off the TV and turn back on. The lamp should turn on.
- Lamp is dead. You can replace the lamp yourself following the instructions on page 76. Go to page 82 for ordering information.
- Power supply within TV may need service. Go to page 84 for warranty information.

#### Buttons don't work

- If you're using the remote control, press the TV button first to make sure the remote is in TV mode.
- The front panel controls may be locked (disabled). Use the remote control to unlock the front panel controls by selecting the *Front Button Block* in the *Parental Controls* menu and choosing *Front Buttons Unblocked*.
- Unplug the TV for five minutes and then plug it back in. Turn the TV on and try again.

#### TV turns off

- Sleep or Record/Wake Timer feature may have been activated. Go to page 69 for instructions.
- Electronic protection circuit may have been activated because of a power surge. Wait 30 seconds and then turn on again. If this happens frequently, the voltage in your house may be abnormally high or low.
- Unplug. Wait five minutes. Plug in again.

#### TV turns on unexpectedly

- Record/Wake Timer feature may have been activated. Go to page 69 for instructions.

## Video and audio are out of sync

- If you've connected a component, such as a DVD player, to your TV's Video jack, and to an audio receiver using the audio jacks, you may experience a slight delay between the audio heard and the video seen. Connect the DVD player to the TV's Audio jacks, then use the TV's FIXED/VARIABLE AUDIO OUTPUT jacks to connect to an audio receiver.

If your TV is connected to an audio/video (A/V) receiver or home theatre system via the DIGITAL AUDIO OUT jack, read the following information.

- If you've connected a component to your A/V receiver, such as a DVD player or satellite receiver, you may experience a slight delay between the audio heard and the video seen. This occurs because the digital audio is sent directly to the speakers while the video must be processed inside the TV before it is displayed.
- If the component has Component Video (Y, Pb, Pr) jacks, connect these jacks to the TV's Y, Pb, Pr jacks to minimize the discrepancy. This works best if the component supports Progressive Scan technology.
- If necessary, you can connect the component directly to the TV using L/R audio jacks and bypassing the A/V receiver or you can program an audio delay in the A/V receiver so the audio and video match up (not all audio equipment has the ability to program delays). Check the audio/video Receiver's manual.

## Blank screen

- Make sure you have connected the component to the TV correctly.
- Make sure the component connected to the TV is turned on and tuned to the corresponding Video Input Channel.
- Try another channel, or press the INPUT or ANT•CAB button.
- When you first turn off your TV, the screen fades from blue to black. Once the screen goes black, the TV's internal lamp starts its cool-down cycle. If you try to turn on the TV during the cool-down cycle, the TV turns back on and you'll hear audio, but the picture will take a few moments to be displayed.
- If you're trying to play a 1394 Recording, you may have accessed an "unrecorded" subchannel. Press the CH+ or CH- buttons to go through the subchannels before you get to the subchannel you recorded. This occurs even when you've selected to record only a specific subchannel because of how digital (ATSC) channels are broadcast and recorded by your 1394 device—the data for the subchannel is recorded, but not the content.

## Unusual sound quality

- Check the *Graphic Equalizer*, *SRS*, and *Sound Logic* settings.
- Check if SAP is turned on.
- Check that the *Audio Mode* is set to your language.

## Humming or buzzing noise

- The TV is in its lamp cool-down cycle. To prolong the life of the TV's lamp system, the TV must warm up and cool down properly. You may notice additional noise during these cycles.
- Maybe the speakers are turned off. Check the *FIXED/VARIABLE OUT* control panel in the *Audio Connections* menu.

## No picture, sound okay

- If the indicator on the front of the TV is blinking, the lamp inside of your TV may need to be changed. Go to page 76 for ordering information.
- You might have tried to turn on the TV during lamp cool-down. Wait a few moments and the picture will be displayed.

## No sound, picture okay

- Maybe the sound is muted. Try pressing the volume up button to restore sound.
- Maybe the speakers are turned off in the *Audio Connections* menu. Check the *FIXED/VARIABLE OUT* control panel in the *Audio Connections* menu.
- If using an S-Video connection, DVI, component video and composite video, remember to also connect the component's L and R AUDIO OUT jacks to the TV's L and R INPUT jacks.
- Check the *Maximum* and *Initial Volume* settings in the *Special Features* menu.

# References

---

## Channel search finds few channels

- The cable connected to the CABLE and/or ANTENNA INPUT jack might be loose.
- Your off-air antenna might be getting a weak signal. Move it higher or get a bigger antenna.
- If you have cables connected to the CABLE and ANTENNA jacks, try swapping the cables. Cable needs to be connected to the CABLE INPUT; off-air antenna needs to be connected to the ANTENNA INPUT.
- If you have a cable box, you can't connect it to the ANTENNA jack. Connect it to the CABLE INPUT or a Video Input jack.
- Select all the options in the *Channel Search* menu, and retry channel search.

## Can't select certain channel

- May be blocked or not approved in the *Parental Controls* menu.
- If using a VCR, check to make sure the TV/VCR button on the VCR is in the correct mode (press the TV/VCR or INPUT button on your VCR).
- You can't change channels when a menu is on the screen (press the CLEAR button).

## Noisy stereo reception

- May be a weak station. Use Audio menu to choose *Mono* sound.

## Picture edges aren't symmetrical or parallel

- The mirror inside the TV is not in the correct position. Use the *Mirror Adjustment* option in the *Advanced Settings* menu to adjust the picture. Go to page 59 for more information.

## No picture, no sound but TV is on

- Maybe the cable/antenna option wasn't chosen in the *Channel Search* menu. Select *Detect antenna or cable setting* in the *Channel Search* menu and run the search again.
- The channel might be blank — change channels.
- If you're watching your VCR and it's connected with coaxial cable to the CABLE/ANTENNA jack, tune the TV to channel 3 or 4 (whichever channel is selected on the 3/4 switch on the back of your VCR). Also check to make sure the TV/VCR button on the VCR is in the correct mode (press the TV/VCR button on your VCR).
- If a channel doesn't exist and you tune to scrambled QAM channel, *Unusable Signal* appears.

## Sound okay, picture poor

- Check antenna and video connections. Make sure all of the cables are firmly connected to the jacks and they're not damaged.
- Try adjusting sharpness function to improve weak signals. Go to page 56 for more instructions.
- Press the FORMAT button repeatedly to view the picture in different video formats. Analog channels may look better when you use the Normal video format (the video format appears on the right side of the channel banner).

## Black box appears on the screen

- Closed-captioning might be on. Check the *Caption Display* control panel in the *Preferences* menu. Go to page 67 for more instructions.

## ***The Remote Control Doesn't Work***

---

- Something might be between the remote and the remote sensor on the component. Make sure there is a clear path.
- Maybe the remote isn't aimed directly at the component (TV or VCR) that you're trying to operate.
- Maybe remote is not in TV Mode. Press the TV button so the remote controls the TV.
- Maybe batteries in remote are weak, dead, or installed incorrectly. If batteries are weak, you will not be able to activate backlighting on the remote; instead, backlight will blink once when activated. Put new batteries in the remote. (Note, if you remove the batteries, you may have to reprogram the remote to operate other components.)
- When using the Learning feature, do the learning process in low light areas to prevent natural light and fluorescent light interfering with the infrared signals.
- For Volume Punchthrough, remember to program the AUDIO button on the TV's remote control to operate your audio receiver or amplifier. Go to page 30 for instructions. If you can't program this remote to operate your audio receiver, Volume Punchthrough won't work.
- *Remote Setup* might be set to the wrong option. Press MENU/OK on the front panel. Select *Connections*, then *Special Features*, then *Remote Setup*. Choose *TV (default)*.

## ***Problems with V-Chip/Parental Controls***

---

### **The rating limits don't work**

- You must lock the settings. Go to the *MAIN MENU* (press MENU on your remote), select *Parental Controls*, then select *Lock TV*.

### **I don't remember my password and I want to unlock the TV**

- If you forget your password, put the remote in TV mode. Simultaneously press and hold MENU/OK on the television and VOL down on the remote for 3 seconds. Nothing appears on the screen, Parental Controls simply unlock and you can re-enter a password via *Lock TV*.

### **The V-Chip won't let me watch a program even though it's not rated as violent.**

- Maybe the movie was given an NR (Not Rated) status. After you block movie ratings, you must set *V-Chip Unrated* to View separately in order to view movies with an NR rating.

## ***Problems with DTVLink Recording/Playback***

---

- Make sure the DTVLink components are not looped. See page 18.
- If the network speed seems slow, make sure the DTVLink component that has the fastest speed is first at point of connection to TV. Check component manual's for network speed. See page 18 for more information.
- Make sure the program is digital (ATSC or QAM) or no recording will take place.
- If a program is not recorded, it could be the DTVLink component enforces copy protection standards.
- If you cannot find the program you recorded, channel through the subchannels.

## Lamp Replacement Instructions

### Replacing the Lamp Unit

Your TV's source of light comes from a lamp – similar to lamps used in film or front projectors. Although this lamp is long-lasting, it may need to be replaced eventually.

#### When to replace the lamp

You probably need a new lamp if there's no picture, but you still can hear the audio and the power light on the front of the TV does the following: blinks 5 times, pauses, blinks 5 times again. If the TV doesn't turn on after 5 minutes and then the light blinks steadily for one minute, the lamp is dead. If you have any concerns, please contact us at 1-866-723-6486 or call an authorized servicer in your area.

**Note:** *The same symptoms occur if the lamp unit isn't seated correctly, lamp access door is ajar, or lamp power supply needs service. Make sure the lamp access door is completely closed and the lamp unit is seated correctly.*

#### What to do

- If your TV is still covered by the warranty, we will refer you to a service person who will replace the lamp for you. Call 1-866-723-6486.
- If your TV's warranty has expired, call 1-800-338-0376 to order a new lamp, and you can install it yourself using the directions that follow.

The lamp has been designed to make installation as easy as possible, but if you don't follow the directions, there is a risk of burn injury or electric shock. If you don't feel comfortable replacing the lamp, call 1-866-723-6486 to have a qualified technician install the new lamp unit (a fee will apply).

**IMPORTANT PRECAUTIONS:** Before you begin, make sure you read and understand all of the instructions. If you need any clarification, call 1-866-723-6486 for help. You must follow all the instructions step by step. TTE Technology, Inc. cannot be held responsible for failure to adhere to the safety measures described herein, the safety measures on the back panel of the TV, and any other reasonable safety practices and precautions.

**Note:** *Lamp contains a small amount of mercury which can be considered hazardous if improperly handled or disposed. Take proper precautions to ensure that the lamp does not break during handling. Disposal of these materials may be regulated due to environmental considerations. For disposal or recycling information, please contact your local authorities or the Electronic Industries Alliance: [www.eiae.org](http://www.eiae.org).*

#### You Must Wait 1 Hour Before You Replace the Lamp!

The lamp unit's temperature can reach 200 degrees. Unplug the TV and allow the lamp to cool thoroughly (for at least 1 hour) before you remove the burnt-out lamp.

- Don't remove the lamp access door or remove the inoperative lamp unit until you have a replacement lamp (this will reduce the risk that children or pets will come into contact with the hot lamp, and will keep foreign objects and dust out of the lamp unit.)
- Never allow children or pets to play with the lamp access door at any time.
- Use only a genuine RCA lamp replacement unit.
- There are no user serviceable parts within the lamp unit itself. Don't attempt to repair the lamp unit – attempting to do so may cause injury, and will void your warranty.

#### What you'll need to get started:

\_\_\_ A flashlight

\_\_\_ A flat-head screwdriver

\_\_\_ The correct lamp replacement unit. To order the correct lamp, you'll need to know your TV's model number, serial number, and lamp type. The TV's model number is located under the front panel piece towards the bottom left corner. Go to page 10 for information on removing the front panel piece. The serial and lamp part numbers are listed on the Service Model Number sticker (example shown on the right). The sticker is located on the lamp handle (see the following page for sticker location).



**EXAMPLE: Service Model Number sticker with lamp part number listed.**

\_\_\_ The box that the lamp replacement unit came in.

1. Read the precautions listed above.
2. Make sure your hands are dry and clean before you begin replacing the lamp.
3. Unplug the TV's power cord from the wall outlet (or power strip). Unplug the power cord from the back of the TV.
4. Put the power cord far away from the TV. Taking this precaution will ensure that no one plugs in the TV if you walk away from it, or when you're waiting for the lamp unit to cool, or when you're installing the new lamp.
5. Wait 1 hour so the lamp can thoroughly cool. If you don't wait at least 1 hour, you risk getting injured!

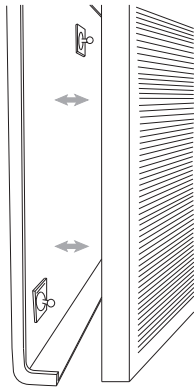

6. After 1 hour, go to the front of the TV set and remove the front panel piece. Go to page 10 for instructions. Find the lamp-unit access door (located in the lower right side of the TV). Read the precautions on the door (you may need a flashlight).

**Note:** Do not attempt to repair the lamp. Do not open the lamp assembly unit — leave the lamp in its casing.

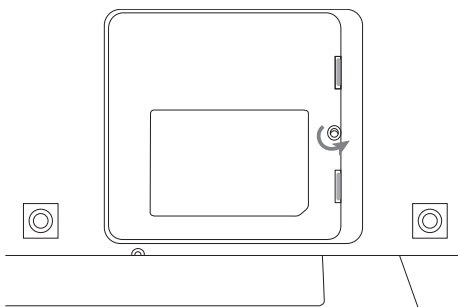

7. Loosen the screw on the door (don't remove the screw, just loosen it).

**Note:** Don't use a coin to loosen the screw because the coin could fall into the TV.

# References

---

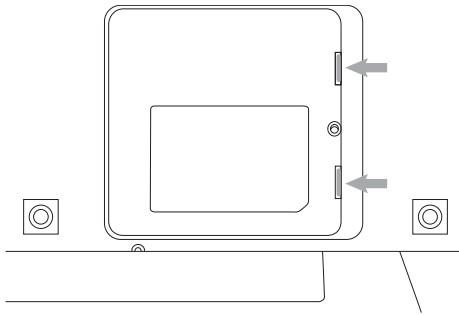

8. Press the catch tabs near the screw you just loosened (one tab is above the screw and one is below), and remove the entire lamp access door. Place the door to the side (don't put it on the floor or anywhere someone might step on it or accidentally break the tabs).

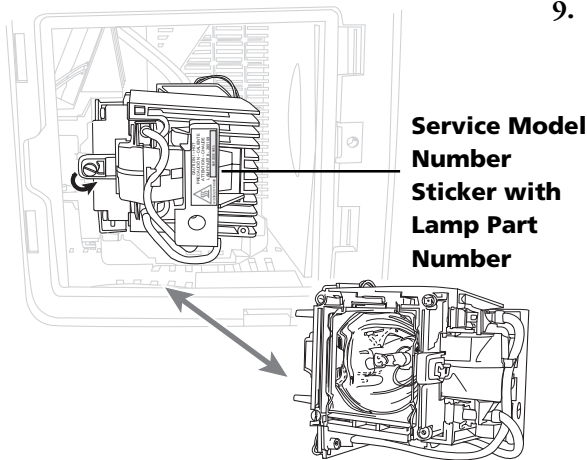

9. Loosen the screw on the lamp unit inside the TV (the screw stays with the unit so just loosen it, don't remove it).

10. As you remove the lamp, pay attention to how the lamp fits so that you can use the proper orientation when you're installing the new lamp. To remove the lamp unit:
  - grasp the handle and pull straight back to remove the entire lamp assembly unit from the TV.
  - place the old unit out of the way where it won't get broken or dropped.
11. Remove the new lamp assembly unit from its packaging. Make sure you do not touch the glass surface of the lamp.
12. Make sure the lamp unit is oriented in the correct position, and gently slide it into the lamp access opening as far as it can go (it fits snugly).
13. Tighten the screw on the new lamp unit.
14. Put the old lamp unit into the box in which the new lamp unit was packaged.



- 15.** Replace the lamp access door (the TV won't turn on unless this door is in place and properly attached).
  - a. Insert the catch tabs (also called latches) into the slots on the left side of the lamp access compartment first. Then put the rest of the door in place by pivoting the door until it is fully closed and the latches are engaged.
  - b. Tighten the screw.
- 16.** Plug the power cord into the back of the TV first and then back into the wall outlet strip.
- 17.** Turn on the TV.
- 18.** After the TV warms up (up to 60 seconds), you should see a picture. If you don't see a picture, check the following:
  - Make sure TV is plugged in.
  - Make sure you've tuned the TV to a valid channel.
  - Try turning on the TV both ways: with the remote control, and then with the power button on the front of the TV.
  - Make sure the lamp unit access door is properly and completely closed.
  - Make sure the screws are completely tightened.
  - Unplug the power cord from the TV and from the power outlet. Return to step 7 and make sure the lamp unit is fully seated in the housing.
  - If the TV still doesn't come on, you need to have the unit professionally serviced. See your warranty.

# References

---

## HDTV Specifications\*\*

<b>Tuning Capability</b>	Channel Tuning .....	NTSC/ATSC/64 QAM - 256 QAM
	Digital Cable Compatibility .....	1394 (DTVLink), 64 QAM - 256 ..... QAM, HDMI/DVI, Component, ..... CableCARD slot
<b>Video</b>	3:2 Pull Down (Film Mode) .....	Reverse Diagonal
	4:3 Format Control (Screen) .....	Normal, Cinerama, Zoom, Stretch, ..... Auto Format Switch
	Adaptive Video Noise Reduction .....	Yes
	Adjustable Color Warmth .....	Yes
	Adjustable Picture Control .....	Yes
	Auto Color Control .....	Yes
	Auto Flesh .....	Yes
	Comb Filter .....	Digital Frame Comb (3D Y/C)
	Contrast Expand .....	Off, Low, High
	Optimum Contrast, High-Resolution Screen .....	Yes
	Edge Enhancement .....	Off, Low, High
	Green Stretch .....	Off, Low, High
	Horizontal Resolution (Picture Width) .....	1280
	Horizontal Viewing Angle (Alpha H) .....	80°
	Hybrid Lens System .....	Yes
	Picture Presets .....	Vibrant (Day), Natural, ..... Cinematic (Night), Videogame, ..... Professional, Personal
	Light Engine Type .....	DLP Light Engine
	Picture Screen Pitch .....	Screen .155mm
	Scan Rate Converter .....	Yes
	Vertical Viewing Angle (Alpha V) .....	20°
Wide Band Video Amplifier .....	Yes	
<b>Sound</b>	Audio Power (Watts) Front Speakers .....	20 Watts/Channel
	Balance Control .....	Yes
	Broadcast Stereo w/dbx† Noise Reduction .....	Yes
	Sound Presets .....	7 plus Personal
	Front Speakers .....	2/Tweeter/Dual-Mid-range ..... channels
	Fully Enclosed Speaker System .....	Yes
	Graphic Equalizer .....	7 band

† dbx is a registered trademark of Carillon Electronics Corporation.

\*\*Specifications are subject to change.

Matrix Surround Sound .....	Yes
Second Audio Program (SAP) .....	Yes
Sound Logic Audio Leveler .....	Yes
SRS Labs TruSurround XT .....	Yes

## Convenience

Web Browser .....	Yes
Auto Channel Search .....	Yes
Multilingual On-screen Display .....	English, French, Spanish
Auto Tuning .....	Yes
Closed Captioning .....	Analog & Digital
Front Button Block .....	Yes
Commercial Skip.....	Yes
Parental Control with USA & Canada V-Chip .....	Yes
Picture Reset .....	Yes, in Menu
Picture-in-Picture (PIP).....	Analog on Analog
Picture Memory Presets for Video Inputs .....	Yes
(Individual Memory)	
Clock (Time), Sleep and Record Wake-up Timers .....	Yes

## Front Panel

Backlit Touch Sensor Front Panel Buttons.....	Yes
---	-----

## Back Panel Inputs/Outputs

Composite A/V Inputs with Autodetect S-Videos .....	2 sets
Component with composite audio/video inputs .....	2 - Y,Pr,Pb (RCA Jacks)
.....	SYNCROSCAN
Antenna/Cable Inputs .....	2 - RF
HDMI/DVI Input (with Audio Input menu selection).....	1
Broadband Connection (Ethernet RJ45) .....	1
DTVLink (IEEE 1394) .....	2
Audio/Video (Record) Output .....	1
Digital Audio Output .....	1
Fixed or Variable Audio Outputs .....	1 set, menu switchable
CableCARD slot .....	1
Matrix Surround Outputs .....	Left and Right Rear, and
.....	Center

# References

---

## Accessory Information

Below are accessories available to compliment your product. Prices are subject to change without notice. All accessories are subject to availability.

A shipping and handling fee will be charged upon ordering, and we are required by law to collect the appropriate sales tax for each individual state, county and locality to which the merchandise is being sent.

### How to Order

To place your order by phone, have your Visa, MasterCard or Discover Card ready and call the toll-free number listed below. Use this number only to place an order for accessory items listed on these pages.

**1-800-338-0376**

### Custom DLP HDTV Accessories



To purchase an additional or replacement keyboard, call 1-800-798-5875 or order on-line at [www.rca.com/keyboard](http://www.rca.com/keyboard).

**KBR755TA1**

### Wall Mount

You can hang your DLP by using a compatible wall mount accessory. Call the toll-free number listed above for more details on purchasing a wall mount and have your TV's model number ready.

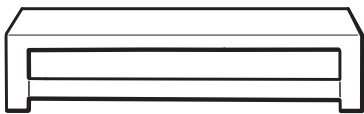

**Base Stand**

### Stand

Your DLP can be placed on a compatible stand for additional storage of components connected to your TV. There are two stand options: a base stand that the TV is placed on, or a stand with hanging bracket which the TV's base comes off and then attaches to the stand's bracket. Call the toll-free number listed above for more details on purchasing a stand and have your TV's model number ready.

**Make sure you read cautions about the stand on page 8.**

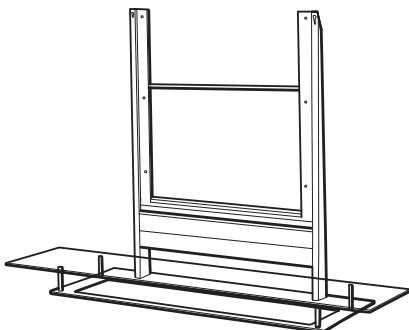

**Stand with hanging bracket**

### DVR2080 or DVR2160

#### (AVHDD) Audio Visual Hard

**Disk Drive** Connect to your TV's DTVLink jack to record and store digital (ATSC and QAM) programs.

### Replacement Lamp

Your DLP is equipped with a special lamp unit. If you have sound, no picture, and the light on the front of the TV blinks, you may need to change the lamp. Locate the sticker on the lamp handle (see page 78) or go to the *Lamp Power* menu for the lamp type. To order, call

**1-800-338-0376.**



**Remote Control** This is the remote control that came packed with your TV. Replacements or spares can be ordered as needed.

264855 \$51.60

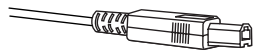

**Optical/SPDIF cables** help you connect to a component with an Optical Audio In jack, such as a Dolby Digital decoder or receiver.

DV3 (3-ft) \$15.95

DV6 (6-ft) \$19.95



**Network Category 6 cables** help you connect to a component with an ethernet jack. High performance 500MHz Bandwidth, 5x bandwidth of standard Category 5 cable

TP603N (3-ft) \$14.95

TP607N (7-ft) \$19.95

TP625N (25-ft) \$29.95



**Amplified VHF/UHF/FM Antenna** allows you to easily switch from the antenna signal to cable or satellite easily without disconnecting antenna.

ANT200 \$49.95

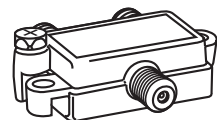

**Signal Splitter** helps you connect to other components.

2-way VH47 \$3.95

4-way\* VH49 \$6.95

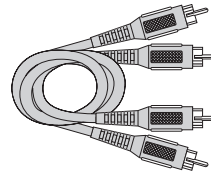

**Monaural VCR Dubbing Audio/Video Cable** is a double cable that lets you connect the video and audio jacks of two VHS VCRs to duplicate tapes. It can also be used to connect a VCR to your TV. The cable is color-coded and shielded. It has RCA-type phono plugs on each end.

Gold-Tipped cable, VH83 (6-ft) \$5.95

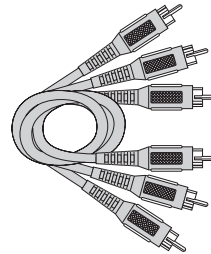

**Stereo VCR Dubbing Audio/Video Cable** is a triple cable that lets you connect the VIDEO and AUDIO jacks of stereo components.

Gold-Tipped cable, VH84 (6-ft) \$9.95

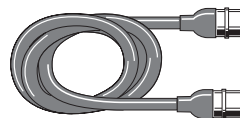

**Push-on Cable\*** attaches to the round antenna connectors (called 75-ohm F-type) on the back of your VCR or TV. The ends push on for a quick connection.

VH89 (6-ft) \$5.95

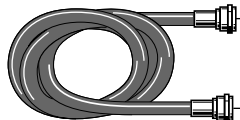

**Screw-on Cable\*** attaches to the round antenna connectors (called 75-ohm F-type) on the back of your VCR or TV. The ends screw onto the connectors for a secure connection.

VH82 (6-ft) \$4.95

VH81 (3-ft) \$3.95

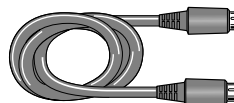

**S-Video Cable** has multi-pin connectors on each end for connecting S-Video components to your TV.

VH976 (6-ft) \$7.95

VH913 (12-ft) \$14.95

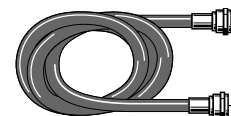

**RG-6 Coaxial Burial Cable** with weatherproof "F" connectors.

VHD905 \$5.95

\* This accessory is intended for use with an off-air or cable TV signal distribution and is not suitable for distribution of the satellite signal originating from your satellite dish antenna.

# References

---

## Limited Warranty

### What your warranty covers:

- Defects in materials or workmanship.

### For how long after your purchase:

- One year from date of purchase for labor.
- One year from date of purchase for parts.
- One year from date of purchase for light engine and lamp assembly.

The warranty period for rental units begins with the first rental or 45 days from date of shipment to the rental firm, whichever comes first.

### What we will do:

Pay an Authorized Service Center the labor charges to repair your unit.

Pay an Authorized Service Center for the new, or at our option, refurbished replacement parts, light engine, and lamp assembly required to repair your unit.

### How you get service:

- Call 1-866-SCENIUM and have your unit's date of purchase and model/serial number ready.
- A representative will troubleshoot your problem over the phone.
- If the representative determines that you should receive service, they will provide you with the name(s) of the Authorized Service Center in your area.
- Contact the Service Center and arrange for home or pick up, repair, and return service, provided that your unit is located within the geographic territory covered by an Authorized Service Center. If not, you must take your unit to the Service Center location at your own expense, or pay for the cost the Service Center may charge to transport your unit to and from your home.
- Proof of purchase in the form of a bill of sale or receipted invoice which is evidence that the product is within the warranty period must be presented to obtain warranty service. For rental firms, proof of first rental is also required.

### What your warranty does not cover:

- Customer instruction. (Your Owner's Manual describes how to install, adjust, and operate your unit. Any additional information should be obtained from your dealer.)
- Installation and related adjustments.
- Damage resulting from non-approved installation methods.
- Signal reception problems not caused by your unit.
- Damage from misuse or neglect.
- Batteries.
- Labor to replace the light engine and lamp assembly after one year from the date of purchase.
- A television that has been modified or incorporated into other products or is used for institutional or other commercial purposes.
- A unit purchased or serviced outside the U.S.A.
- Acts of nature, such as but not limited to lightning damage.

### Product Registration:

- Please complete and mail the Product Registration Card packed with your unit. It will make it easier to contact you should it ever be necessary. The return of the card is not required for warranty coverage.

### Limitation of Warranty:

- **THE WARRANTY STATED ABOVE IS THE ONLY WARRANTY APPLICABLE TO THIS PRODUCT. ALL OTHER WARRANTIES, EXPRESS OR IMPLIED (INCLUDING ALL IMPLIED WARRANTIES OF MERCHANTABILITY OR FITNESS FOR A PARTICULAR PURPOSE) ARE HEREBY DISCLAIMED. NO VERBAL OR WRITTEN INFORMATION GIVEN BY TTE TECHNOLOGY, INC., ITS AGENTS OR EMPLOYEES SHALL CREATE A WARRANTY OR IN ANY WAY INCREASE THE SCOPE OF THIS WARRANTY.**

- **REPAIR OR REPLACEMENT AS PROVIDED UNDER THIS WARRANTY IS THE EXCLUSIVE REMEDY OF THE CONSUMER. TTE TECHNOLOGY, INC. SHALL NOT BE LIABLE FOR INCIDENTAL OR CONSEQUENTIAL DAMAGES RESULTING FROM THE USE OF THIS PRODUCT OR ARISING OUT OF ANY BREACH OF ANY EXPRESS OR IMPLIED WARRANTY ON THIS PRODUCT. THIS DISCLAIMER OF WARRANTIES AND LIMITED WARRANTY ARE GOVERNED BY THE LAWS OF THE STATE OF INDIANA. EXCEPT TO THE EXTENT PROHIBITED BY APPLICABLE LAW, ANY IMPLIED WARRANTY OF MERCHANTABILITY OR FITNESS FOR A PARTICULAR PURPOSE ON THIS PRODUCT IS LIMITED TO THE APPLICABLE WARRANTY PERIOD SET FORTH ABOVE.**

#### **How State Law relates to warranty:**

- Some states do not allow the exclusion nor limitation of incidental or consequential damages, or limitations on how long an implied warranty lasts, so the above limitations or exclusions may not apply to you.
- This warranty gives you specific legal rights, and you also may have other rights that vary from state to state.

#### **If you purchased your unit outside the United States:**

- This warranty does not apply. Contact your dealer for warranty information.

**Service calls which do not involve defective materials or workmanship are not covered by this warranty. Costs of such service calls are the sole responsibility of the purchaser.**

## Care and Cleaning

CAUTION: Turn OFF your TV before cleaning.

You can clean the TV as required, using a soft lint-free cloth. Be sure to occasionally dust the ventilation slots in the cabinet to help assure adequate ventilation.

The TV's screen may be cleaned with a soft, lint-free cloth as well. Take care not to scratch or mar the screen. If necessary, you may use a cloth dampened with warm water.

Never use strong cleaning agents, such as ammonia-based cleaners, or abrasive powder. These types of cleaners will damage the TV.

While cleaning do not spray liquid directly on the screen, or allow liquid to run down the screen and inside the TV. Also, avoid placing drinks or vases with water on top of the TV. This could increase the risk of fire or shock hazard or damage to the TV.

## FCC Information

This equipment has been tested and found to comply with the limits for a Class B digital device, pursuant to Part 15 of the FCC Rules. These limits are designed to provide reasonable protection against harmful interference in a residential installation. This equipment generates, uses, and can radiate radio frequency energy and, if not installed and used in accordance with the instructions, may cause harmful interference to radio communications. However, there is no guarantee that interference will not occur in a particular installation. If this equipment does cause harmful interference to radio or television reception, which can be determined by turning the equipment off and on, the user is encouraged to try to correct the interference by one or more of the following measures:

- Reorient or relocate the receiving antenna.
- Increase the separation between the equipment and receiver.
- Connect the equipment into an outlet on a circuit different from that to which the receiver is connected.
- Consult the dealer or an experienced radio/TV technician for help.

This Class B digital apparatus complies with Canadian ICES-003

## Symbols

3:2 pulldown 58

## A

Accessories 82  
Action buttons 55  
Adding a learned function 32  
Advanced Settings 58  
Age-based rating  
  Blocking 43  
  Viewing 43  
Age-Based Ratings 42, 45, 47  
Analog captions 67  
Analog TV channel 39  
ANT•CAB button 28  
ANTENNA INPUT 14  
Antenna type 38  
Arrow buttons 28  
Aspect ratio 38  
Assisted setup 24  
AUDIO button 28  
Audio Connections 62  
Audio menu 59  
  Audio Connections 62  
  Audio Mode 61  
  Audio Processor 60  
  Balance 61  
  Equalizer Presets 59  
  SAP 61  
  Sound Logic 60  
Audio Mode 61  
AUDIO OUTPUT  
  Digital 13  
Audio Processor 60  
Audio remote codes 35  
Audio System 4  
AUDIO/VIDEO OUTPUT jacks 12  
Authorized service 9, 72  
Auto color 57  
Auto Tuning 65  
Auto tuning 47  
Automatic code search 30  
AUX button 28

## B

Backlight 15  
Balance 61  
Batteries, installing 24  
Block  
  Age-Based Ratings 43  
  Front Panel 47  
  Movie ratings 44  
  Specific Content Themes 43  
  V-Chip Unrated Program 46  
  Web browser 47  
Browser  
  Web 50

## Buttons

ANT•CAB 28  
Arrows 28  
AUDIO 28  
AUX 28  
CC 28  
CH +/- 28  
CH CTRL 28  
Channel down 15  
Channel up 15  
CLEAR 28  
Don't work 72  
DVD 28  
FAV 28  
FORMAT 28  
FORWARD 29  
FREEZE 28  
Front panel 15  
GO BACK 28  
GUIDE 28  
INFO 29  
INPUT 29  
LIGHT 29  
MENU 29  
MENU/OK 15  
MUTE 29  
Number 28  
OK 29  
ON•OFF 29  
PAUSE 29  
PIP 29, 48  
PLAY 29  
Power 15  
PRESETS 29  
RECORD 29  
Remote control 28  
REVERSE 29, 30  
SAT/CAB 29  
SKIP 29  
SOUND 29  
STOP 29  
SWAP 29  
TV 29  
VCR 29  
VOL +/- 29  
Volume down 15  
Volume up 15

## C

Cable box remote codes 35  
CABLE INPUT 14  
CableCARD 3  
  connection 20  
  slot 14  
  Tools menu 66  
Cables  
  to connect 8

## Canada

  English ratings 46  
  French ratings 46  
  V-Chip unrated program 46  
Canada V-Chip 45  
Caption display 67  
Caption priority 68  
Caption style 68  
Captions  
  Analog 67  
  Background color 68  
  Background Opacity 68  
  Color 68  
  Digital 68  
  Font 68  
  Opacity 68  
  Size 68  
Care and Cleaning 85  
CC  
  display 38  
CH CTRL button 28  
Channel  
  down button 15  
  Initial 65  
  search 25  
  up button 15  
Channel banner 38  
Channel information 38  
Channel lists 40  
Channel search 64  
Channels  
  Digital or Analog 39  
Chart, of connections 9  
Choice fields 55  
Choice lists 55  
Choose Your Connection 9  
Cleaning and care 85  
CLEAR button 28  
Clearing a learned function 33  
Clock display 38  
Closed captioning 67, 68  
Color 56  
  Warmth 57  
Color scheme 70  
Commercial skip 38  
COMPONENT/COMPOSITE INPUT jacks  
  13  
Components, connecting 9  
COMPOSITE INPUT jacks 12  
Connections  
  A/V receiver 21  
  Internet 23  
  TV + Receiver w/ Dolby Digital, speakers  
  21  
  TV, CableCARD 20  
  TV, DTVLink Components 18  
  TV, HDMI or DVI component 19  
  TV, Router 23



- TV, Satellite Receiver, VCR 17
- TV, VCR, DVD player 16
- Connections menu 63
  - Audio Tuning 65
  - Channel Search 64
  - DTVLink Setup 65
  - Ethernet Setup 66
  - Signal Source 64
  - Signal Strength 63
  - Software Upgrade 64
  - Special Features 65
  - Video Input Setup 64
- Content Themes 42
  - Blocking 43
  - Viewing 44
- Contrast 56
- Contrast Expand 58
- Control panels 54
- Controls
  - Menus 54
  - Parental 40
  - Reset 59

## D

- Deleting ALL learned functions 33
- Digital
  - Cable Ready 3
  - CableCARD 3
  - Sound 3
- Digital Audio Out 62
- DIGITAL AUDIO OUTPUT jack 13
- Digital captions 68
- Digital TV channel 39
- Direct entry programming 31
- DSL modem 23
- DTVLink
  - Auto tuning 48
  - jack 14
  - Problems 75
  - recording 51
  - Recording preferences 52
- DTVLink Setup 65
- DVD button 28
- DVD remote codes 36
- DVD/VCR remote codes 36
- DVI Audio Input 63

## E

- EAS 52
- Edge Enhancement 57
- Emergency Alert System 52
- Equalizer Presets 59
- ETHERNET Jack 13
- Ethernet setup 66

## F

- FAV button 28
- FCC Information 85
- Film Mode 3, 58
- Fixed/Variable Out 62
- Format
  - Screen 69
- FORMAT button 28
- FORWARD button 29
- FREEZE button 28
- Front panel
  - Buttons 15
  - removing piece 10
- Front panel block 47

## G

- GO BACK button 28
- Green Stretch 57
- GUIDE button 28

## H

- HDMI
  - autotuning 48
- HDMI/DVI Input 14
- HDTV specifications 80
- Help text 54
- Home Theatre box remote codes 36
- Horizontal Position 58

## I

- Icons
  - Channel banner 38
- Indicator 15
- Indirect light 8
- INFO button 29
- Initial
  - channel 65
  - volume 65
- INPUT autotuning 48
- INPUT button 29
- Internet connection 23
- Internet service provider 23

## J

- Jack panel
  - access 10
  - door 10
- Jacks
  - ANTENNA INPUT 14
  - AUDIO/VIDEO OUTPUT 12
  - CABLE INPUT 14
  - CableCARD 14
  - CENTER 11
  - COMPONENT/COMPOSITE INPUT 13

- COMPOSITE INPUT 12
- DIGITAL AUDIO OUTPUT 13
- DTVLink 14
- ETHERNET 13
- FIXED/VARIABLE OUTPUTS 11
- HDMI/DVI 14
- S-VIDEO 12
- SUBWOOFER 11
- WIRED IR 13

## L

- Lamp Power 70
- Lamp replacement 76
- Language
  - Menu 25, 70
- Language display 38
- Learning feature 32
  - Adding a function 32
  - Clearing a function 33
  - Deleting ALL functions 33
- Light blinking 24
- LIGHT button 29

## M

- Main Menu 54
- Maximum volume 65
- MENU button 29
- Menu controls 54
  - Action buttons 55
  - Choice fields 55
  - Choice lists 55
  - Numeric entries 55
  - Sliders 55
- Menu language 25, 70
- MENU/OK Button 15
- Menus 54
  - Audio 59
  - Connections 63
  - Moving through 54
  - Picture Quality 56
  - Preferences 67
  - Recordings 63
- Mercury 76
- Mirror Adjustment 59
  - screws 10
- MUTE button 29

## N

- Noise reduction 57
- Number buttons 28
- Numeric entries 55

## O

- OK button 29
- ON•OFF button 29
- On-screen help 54
- On-screen help text 54
- OUTPUTS
  - AUDIO/VIDEO 12
  - FIXED/VARIABLE AUDIO 11
- Overheating 8

## P

- Parental controls 40
  - Channel lists 40
  - Editing channels 41
  - Lock/unlock 40
- Password, V-Chip 75
- PAUSE button 29
- PCM 62
- PCM receiver 21
- Picture Presets 56
- Picture Quality menu 56
  - Advanced Settings 58
  - Auto color 57
  - Color warmth 57
  - Contrast Expand 58
  - Edge Enhancement 57
  - Green Stretch 57
  - Noise Reduction 57
  - Picture presets 56
  - Picture settings 56
- Picture settings 56
- Picture-in-Picture 48
- PIP
  - button 29, 48
  - operation 48
- PIP (Picture in Picture)
  - Buttons 48
  - Problems 49
- PIP, using 49
- PLAY button 29
- Power
  - button 15
  - Indicator 70
  - indicator 15
  - Lamp 70
- Power light flashing 72
- Power surges 8
- Preferences menu 67
  - Analog captions 67
  - Caption Display 67
  - Caption Style 68
  - Captions Priority 68
  - Closed captioning 67
  - Color Scheme 70
  - Digital captions 68
  - Lamp Power 70
  - Menu Language 70

- Power Indicator 70
- Screen Format 69
- Time 69
- Translucency 70
- PRESETS button 29
- Problems
  - DTVLink Recording 75
  - Parental controls 75
  - Remote control 75
  - TV 72
  - V-Chip 75
- Program title 38
- Programming the remote
  - Automatic code search 30
  - Direct entry 31
- PVR remote codes 36

## Q

- QAM 3

## R

- Rating Limits
  - movies 44
- Ratings
  - Blocking movie 44
  - Viewing movie 44
- RECORD button 29
- Record/Wake Timer 69
- Recording
  - DTVLink 51
- Recordings menu 63
- Remote
  - Setup 66
- Remote Control
  - Buttons 28
  - Code list 35
  - Installing the Batteries 24
  - Programming 30
- Remote control
  - Learning feature 32
- Reset controls 59
- REVERSE button 29

## S

- S-Video jack 12
- SAP 61
- SAP display 38
- SAT/CAB
  - Button 29
- Satellite Receiver remote codes 36
- Saving Web address 50
- Screen Format 69
- Search
  - Automatic code 30
  - Channels 64
- Second audio program 61
- Service, authorized 9

## Setup

- Ethernet 66
- Remote 66
- Setup, assisted 24
- Signal source 64
- SKIP button 29
- Sleep timer 69
- Sliders 55
- Software Upgrade 64
- SOUND button 29
- Sound Logic 60
- Special features 65
- Specifications 80
- SRS 60
- Stand 8
- Stands 82
- STOP button 29
- SUBWOOFER jack 11
- SWAP button 29

## T

- Things to Consider Before You Connect 8
- Time display 38
- Time of Day 69
- Timer
  - Record/Wake 69
  - Sleep 69
- Tint 56
- Translucency 70
- Trapezoid
  - Left 58
  - Right 58
- Troubleshooting 72
- TruScan 3
- Turn on TV 24
- TV button 29
- TV, CableCARD connection 20
- TV, HDMI or DVI component connection 19
- TV problems 72
- TV, Router connection 23
- TV, Satellite Receiver, VCR connection 17
- TV, VCR, DVD Player connection 16
- TV, DTVLink Components connection 18

## U

- USA
  - V-Chip TV ratings 41

## V

- V-Chip 40
  - Age-Based Ratings 41
  - Blocking age-based 43
  - Blocking Movies 44
  - Canada 41, 45

- Content Themes 41
  - display 38
  - USA 41
  - USA TV ratings 41
  - Viewing age-based rating 43
- V-Chip rating screen 42
- V-Chip unrated program 46
- VCR button 29
- VCR remote codes 36
- Vertical Position 58
- VIDEO 12
- Video Input Setup 64
- Viewing
  - Movie ratings 44
  - Specific content themes 44
- VOL +/- buttons 29
- Volume
  - Initial 65
  - Maximum 65
- Volume down button 15
- Volume Punchthrough 34
  - Deleting commands 34
- Volume up button 15

## **W**

- Wall Mount 82
- Warranty 84
- Web browser 50
  - block 47
  - controlling 51
  - saving 50
  - use 50
- WIRED IR jack 13

*This page intentionally left blank*

*This page intentionally left blank*

*This page intentionally left blank*

*This page intentionally left blank*

*This page intentionally left blank*



*This page intentionally left blank*

*This page intentionally left blank*

*This page intentionally left blank*

**Visit the RCA Scenium website at [www.rcascenium.com](http://www.rcascenium.com)**

---

Please do not send any products to the Indianapolis address listed in this manual or on the carton. This will only add delays in service for your product.

**TTE Technology, Inc.**  
**10330 North Meridian Street**  
**Indianapolis, IN 46290**

©2004 TTE Technology, Inc.  
Trademark(s)® Registered  
Marca(s) Registrada(s)  
Printed in USA  
**TOCOM 16336520**