

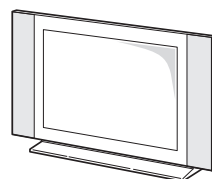

# THOMSON



---

**Manuel d'utilisation**

Bedienungsanleitung

**Manuale di utilizzazione**

User manual

**Manual de utilización**

Manual de utilização

**Gebruiksaanwijzing**

Bruksanvisning

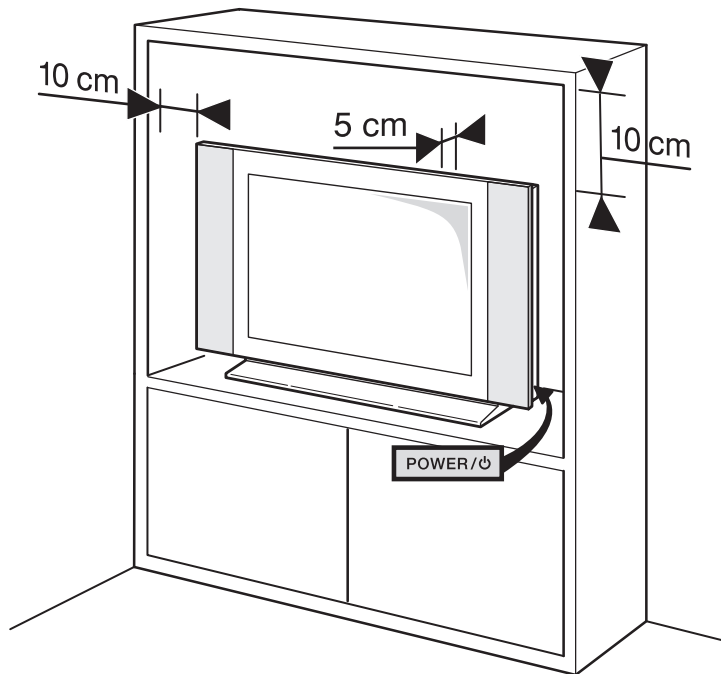
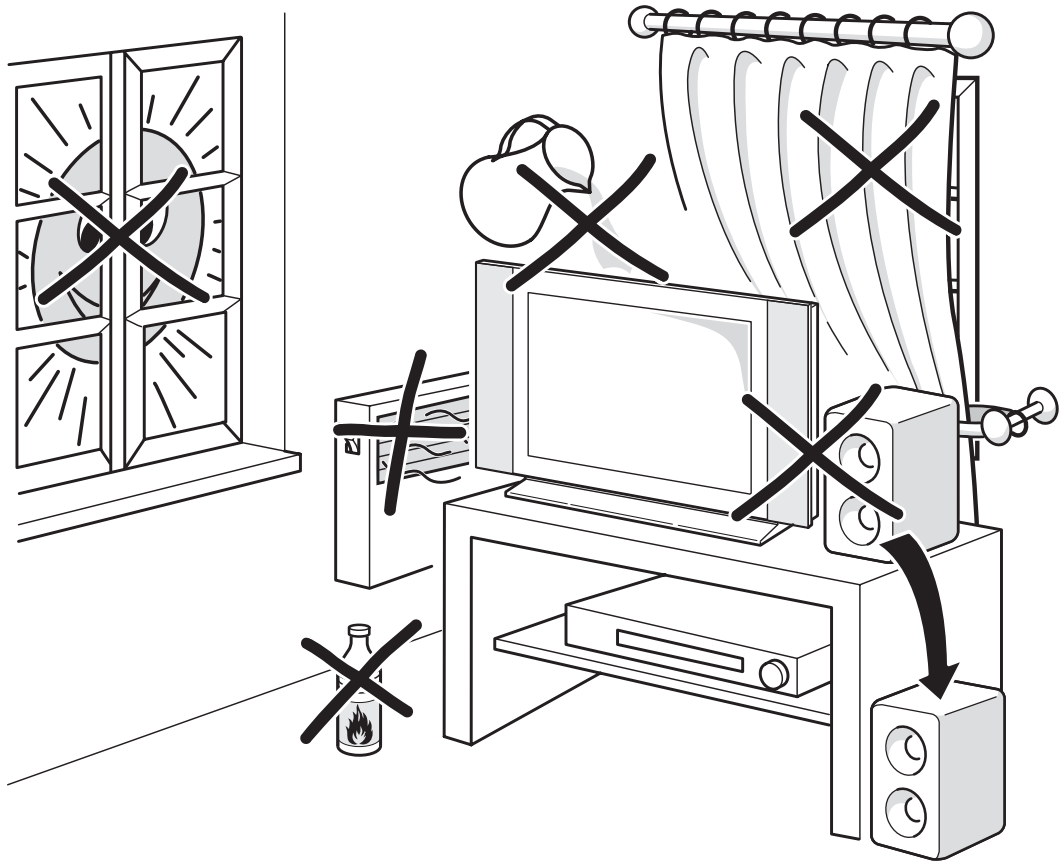

## Getting started

<b>Important information</b> .....	2
Safety .....	2
Care .....	2
LCD TV .....	2
Plasma TV .....	2
Hanging the TV set on the wall .....	2
<b>Switching on</b> .....	3
<b>Remote control TV functions</b> .....	4
<b>Playing files from memory cards</b> .....	4
<b>Using the remote control for other equipment</b> .....	4
Programming the remote control .....	4
Programming the volume control function .....	5

## Channel set-up

<b>Initial set-up</b> .....	6
<b>Manual channel set-up</b> .....	7

## General operation

<b>Switching the TV set on and off</b> .....	8
<b>Accessing channels</b> .....	8
<b>Accessing your favourite channels</b> .....	8
<b>Accessing AV programmes</b> .....	8
<b>Volume</b> .....	8
<b>Displaying status information</b> .....	8
<b>Zoom</b> .....	9
<b>List of channels</b> .....	9
<b>Freezing a picture</b> .....	9
<b>Flat batteries</b> .....	9
<b>Product information</b> .....	9

## Advanced functions

<b>Adjusting the sound</b> .....	10
Tone control .....	10
Headphone settings .....	11
<b>Adjusting the picture</b> .....	11
Other settings .....	12
<b>PIP - PAP</b> .....	13
Operation .....	13
<b>Setting the time</b> .....	14
Setting the time and date .....	14
Using the calendar .....	14
Programming the sleep timer.....	14
Programming the wake-up timer .....	15
<b>Parental control</b> .....	15
Defining a PIN code.....	15
Locking a channel or AV programme .....	16
Locking the buttons on the TV set .....	16
Locking the Time menu.....	16
Locking the Installation menu .....	16
Operation (TV mode) .....	16
<b>Customising your television</b> .....	17
Preferences.....	17
Configuring AV sockets .....	17
<b>Playing files from memory cards</b> .....	18
Other functions.....	19
<b>Teletext</b> .....	20
Accessing Teletext.....	20
Navigator .....	20
Other Teletext functions .....	20
<b>Program Info (programme guide)</b> .....	21
Accessing the programme guide .....	21
Storing programmes.....	21
Checking your selections on the Events screen .....	22
Operation (TV mode) .....	22

## Other information

<b>Sockets</b> .....	23
<b>Connecting active speakers or an amplifier</b> .....	24
<b>Connecting headphones</b> .....	24
<b>Connecting a video recorder</b> .....	24

This manual applies to several TV set models. Some features may not be available on the model you purchased. Refer to the feature table provided with this manual to find out the main features of the relevant model.

Optional functions are indicated by the following symbol: 

The model number of your TV set is on a label at the back of the set and on the cover of this manual.

In the interest of improving the quality of our products, we reserve the right to modify their features. The information in this manual is, therefore, subject to change and does not represent any kind of contract.



This symbol means that your inoperative electronic appliance must be collected separately and not mixed with the household waste. The European Union has implemented a specific collection and recycling system for which producers are responsible.

This appliance has been designed and manufactured with high quality materials and components that can be recycled and reused. Electrical and electronic appliances are liable to contain parts that are necessary in order for the system to work properly but which can become a health and environmental hazard if they are not handled or disposed of in the proper way. Consequently, please do not throw out your inoperative appliance with the household waste.

If you are the owner of the appliance, you must deposit it at the appropriate local collection point or leave it with the vendor when buying a new appliance.

- If you are a professional user, please follow your supplier's instructions.
- If the appliance is rented to you or left in your care, please contact your service provider.

Help us protect the environment in which we live!



This publication is printed on recycled paper.

## Important information

### Safety

- Ensure that your domestic mains supply voltage matches the voltage indicated on the identification sticker located at the back of your set. This TV set is a class I appliance. It **must** be connected to an electrical wall socket with an **earth**.
- The TV set's components are sensitive to heat. The **maximum ambient temperature** should not exceed **35° Celsius**. Do not cover the vents at the back or sides of the TV set. Leave sufficient space around it to allow adequate ventilation. Install the appliance away from any source of heat (fireplace, ...) or appliances creating strong magnetic or electric fields.
- **Moisture** in rooms where the set is installed should not exceed **85% humidity**. If you have to use the TV set outdoors, **do not expose it to rain or splashing water. Do not place any object containing a liquid** (vase, glass, bottle, etc.) on or near the set. Moving the set from a cold place to a warm one can cause condensation on the screen (and on some components inside the TV set). Let the condensation evaporate before switching the TV set on again.
- The **POWER/⏻** button at the side of the TV set can be used to switch it on and put it into standby mode. If you are **not going to be watching the TV for a lengthy period of time**, switch it off completely by removing the plug from the mains power socket.
- During **thunderstorms**, we recommend that you disconnect the TV set from the mains and aerial so that it is not affected by electrical or electromagnetic surges that could damage it. For this reason, keep the **mains and aerial sockets** accessible so they can be **disconnected**, if necessary.
- **Unplug** the TV set immediately if you notice it giving off a **smell of burning or smoke**. You must never, under any circumstances, open the TV set yourself, as you run the risk of an **electric shock** in doing so.
- Before setting up your television set, make sure that the surface you want to put the set on can support its weight (see the list of specifications provided with the booklet). Don't place the set on an unstable surface (e.g. moving shelf, very edge of a unit) and make sure that the front of the television set does not overhang the surface it is sitting on.

### Care

- Use a glass-cleaning product to clean the screen and a soft cloth and mild detergent to clean the rest of the set. **Important:** Using strong detergents, alcohol-based and abrasive products may damage the screen.
- Dust the vents at the back and sides regularly. Using solvents, abrasive or alcohol-based products could damage the TV set.
- If an object or liquid enters inside the appliance, unplug it immediately and have it checked by an authorised engineer.
- Never open the appliance yourself since this may put you at risk or damage the appliance.

### LCD TV

- The LCD panel used in this product is made of glass. Therefore, it can break when the product is dropped or impacted upon by other objects.
- The LCD panel is a very high technology product, giving you finely detailed pictures. Occasionally, a few non-active pixels may appear on the screen as a fixed point of blue, green or red. This does not affect the performance of your product.

### Plasma TV

- In order to ensure long performance of your set and reduce the risk of screen burning, please observe the following precautions.
  - Do not display for lengthy periods of time still images (still computer and video game images, logos, pictures, text) or images in formats which do not fill the entire screen;
  - Use a screen saver when using a computer;
  - When displaying tables, graphics, etc.:
    - decrease the contrast and brightness of the picture as much as possible,
    - display pictures with many colours and grading of colours (photographs),
    - adjust contrast to obtain the least noticeable transition between dark and light areas (white characters on a black background).

### Screen burns are not covered by the warranty.

- The plasma panel is a very high technology product, giving you finely detailed pictures. Occasionally, a few non-active pixels may appear on the screen as a fixed point of blue, green or red. This does not affect the performance of your product.

### Hanging the TV set on the wall

**Warning: This operation requires two people. THOMSON disclaims any liability for damages caused by the TV set being installed inappropriately.**

Please observe the following safety instructions to make sure that the TV set is hung on the wall safely.

- Check that the wall can support the weight of the TV set and wall mount.
- Follow the fitting instructions supplied with the wall mount.
- Hang the TV set on a vertical wall.
- Use screws that are suitable for the material the wall is made of.
- Arrange the TV set's connection cables so that they don't pose a risk of anyone falling over them.

In addition, all the other safety instructions concerning the use of our TV sets remain completely valid

**THOMSON disclaims any liability if the TV set is not used in accordance with this manual.**

## Switching on

Follow the instructions on this page on how to switch on your TV set and the remote control before going on to following pages describing how to use the remote control and the channel set-up procedure.

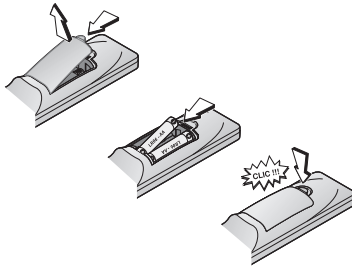

### 1. Insert two LR06 or AA batteries in the remote control.

Precautions on using batteries:

- Only use the battery types specified.
- Make sure you use the correct polarity.
- Do not mix new and used batteries.
- Do not use rechargeable batteries.
- Do not expose batteries to excessive heat, throw them in a fire, recharge them or try to open them, as this could cause them to leak or explode.
- Remove the batteries from the remote control if you are not using it for a long period of time (several weeks).

220 - 240 V ~ 50/60 Hz

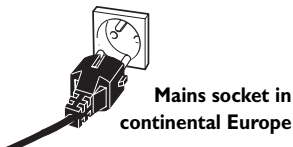

### 2. Connect the power cable **FIRST** to the television, **THEN** to a mains socket.

Your TV set should only be connected to a 220 - 240 V ~ 50/60 Hz AC supply. It must not be connected to a DC supply. If the plug is detached from the cable, do not, under any circumstances, connect it to a mains socket, as there is a risk of electric shock.

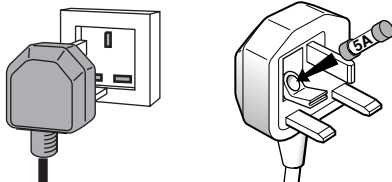

Equipment for the UK and Ireland is supplied with a mains cable fitted with a moulded plug.

This plug contains safety components and must not be replaced by one sold by general retailers. It is fitted with a fuse that protects your television. If your set has stopped working, the fuse may have blown. If it has, replace it with an identical ASTA or BSI certified (BSI 362) 5-amp fuse.

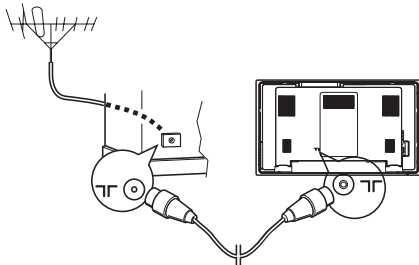

### 3. Connect the outside aerial or cable network to the **TV Antenna** socket at the back of the TV set.

The aerial socket (75 Ohms - VHF / UHF / cable) can be used for connecting an external aerial or other equipment fitted with a modulator (video recorder, satellite receiver, etc.).

We recommend that you do not connect other equipment (video recorder, satellite receiver, etc.) to your TV set to begin with, so as not to complicate the set-up procedure with the additional steps involved. Connect them when you have finished setting up the channels by referring to page 23 of this manual.

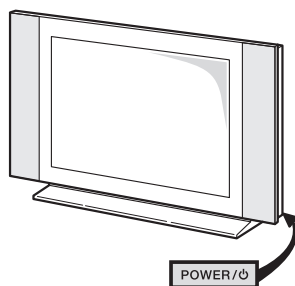

### 4. Switch the TV on by pressing the **POWER/⏻** button located on the side.

Note: The first time you switch on the television, the language selection menu appears.

You will find a description of how to use the remote control on page 4. Then go to page 6 for information on the initial set-up, or to page 7 for information on manual set-up (if the channels have already been set up on your TV).

Note: Before connecting other devices to the AV sockets, carry out the initial channel set-up (described on page 6) in order to avoid any problems with equipment selection.







Please respect the environment and the relevant regulations. Before you dispose of batteries (or accumulators), ask your dealer whether they require special recycling and if he is able to take them back.

# Getting started



## Remote control TV functions

Most of your television's functions are available via the menus that appear on the screen. The remote control supplied with your set can be used to navigate through the menus and to configure all the general settings.

-  Standby / quit standby.
  - TV** To access TV mode. Press this button to control the television.
  - VCR** To access VCR mode.
  - DVD** To access DVD mode.
  - SAT** To access SAT mode.
  - AUX** To access AUX mode.
  - AMP** To access AMP mode.
  - PIP** To enable the PIP function (see page 13).
  - SWAP** To swap the main picture with the PIP picture (see page 13).
  - PIP+/PIP-** To change programmes within the PIP function (see page 13).
  - ZOOM** To change the size of the PIP picture (see page 13).
  - FREEZE** To freeze the main picture (see pages 9 and 13).
  - SLEEP** To access directly the **Sleep timer** option in the **Time** menu (see page 14).
  - LIGHT** Remote control light.
  - PRESETS** (red button) preset settings menu.
  - LIST** (green button) list of channels (see page 9).
  - INFO** (yellow button) status information (see page 8).
  - GUIDE** (blue button) programme guide (see page 21).
  - TEXT** (purple button) Teletext (see page 20).
- The coloured buttons can also be used for operating Teletext.
-  To select menu options.
  -  To set functions, change values, enable and disable functions (checkbox) in menus.  
To select the picture format or zoom.
  - OK** To confirm a selection, enable and disable functions (checkbox) in menus.  
To freeze the picture (see page 9).
  - MENU** To access the **OVERVIEW** menu.
  - EXIT** To exit the menu structure.
  -  To control the volume.
  -  **MUTE** To switch the sound off and back on again.
  - RETURN** To return to the previous channel/AV programme.
  - PR+/PR-** To change channels.
  - 0-9** To select a channel by its number. In the case of channel numbers with two digits:
    - press the tens digit for a few seconds to display it on the screen, then press the units digit or
    - press **0/--** to display "--", then enter the channel number.To enter numeric values in menus.  
In PC mode, the buttons **1-9** can be used to return to TV mode and change channels.
  - AV** To select an appliance connected to an AV socket.
  - DEMO** (Disabled).

## Playing files from memory cards

When playing mp3, WMA, JPEG, MPEG and DivX files, you can use some of the buttons on the remote control to perform certain functions, which vary according to the type of file.

- INFO** To display the Info menu.
- REVERSE** mp3 and WMA: to return to the previous file.  
JPEG: to reduce the projection speed.
- PLAY** To play.
- FORWARD** mp3 and WMA: to go on to the next file.  
JPEG: to increase the projection speed.
- STOP** To stop playing.
- PAUSE** To pause, stop at a particular picture.
-   MPEG and DivX: to change files.
- 0-9** MPEG and DivX: to select a file by its number.

## Using the remote control for other equipment

This remote control can be used to control other appliances using the programmable buttons **VCR**, **DVD**, **SAT**, **AMP** and **AUX**. For each button you can control the following appliances:

**VCR**: video recorder

**DVD**: DVD player

**SAT**: satellite receiver, cable network

**AMP**: hi-fi system, Home Cinema amplifier

**AUX**: decoder for terrestrial digital TV set and any other appliance. For instance, if you have two video recorders, you can program the **VCR** button to control one video recorder, and program the **AUX** button to control the other one.

*Note: The **TV** button is not programmable.*

## Programming the remote control

### Automatic code search

This method can be used to automatically find the most appropriate code for your appliance.

1. Switch on the appliance you wish to use the remote control with.
2. Press the relevant button for this appliance on the remote control, and while holding this button down, press the  standby button until the appliance buttons of the remote control come on. Release both buttons.
3. Point the remote control at the appliance and press **PLAY**. If the appliance has not gone into standby mode, press the **PLAY** button again to continue the search for the next set of codes. Repeat this operation until the appliance goes into standby mode. There are around 20 sets of codes.
4. When the appliance goes into standby mode, switch it on again without using the remote control. Press the **REV** button as many times as is required to return the appliance to standby mode.
5. Press the **STOP** button and hold it down until the appliance buttons of the remote control go off.

*Note: You can cancel the programming operation at any time by pressing the **EXIT** button.*

## Manual programming

This method involves carrying out a manual search for the codes to be used for controlling your other appliances.

1. Switch on the appliance you wish to use the remote control with.
2. Press the relevant button for this appliance on the remote control, and while holding this button down, enter one of the codes relevant to your make of appliance (there is a list of codes at the end of this manual). If the appliance buttons of the remote control flash you have entered the wrong code or it is not possible to program the remote control.
3. Point the remote control at the appliance and press the relevant button (**VCR**, **DVD**, etc.). Press the  standby button. If the appliance does not go into standby mode, try another code.



Depending on the year of manufacture and the type of appliance, some functions may not be available. Certain codes may cover more functions than others. Test the functions you can control and, if appropriate, try other codes. Note here the code(s) which work best.

VCR					AUX				
DVD					AMP				
SAT									

When you **change the remote control's batteries**, remember to **reprogram** it.







## Programming the volume control function

If you have programmed the TV remote control to use with other appliances and these are connected to an amplifier you can also programme the remote control to adjust the volume when you are using one of these appliances. The example below describes the procedure for programming a DVD player.









1. Programme the **AMP** button on the remote control to use with the amplifier (refer to page 4).
2. Move the remote control away from the appliances. Press the - button and while holding it down, press the relevant mode button (**DVD**, in this example), then the **AMP** button. Release the - button.
3. Switch on the amplifier, then the DVD player.
4. Set the remote control to **DVD**, play a disc and adjust the volume using the  +/- buttons.

Repeat this operation for the other appliances.

To cancel the programmed function for any of the appliances, press the - button, while holding it down and enter the code 000 using the numeric buttons.

	Video recorder	DVD player	Satellite receiver	Hi-fi system
	Press the <b>VCR</b> button. On/Standby	Press the <b>DVD</b> button. On/Standby	Press the <b>SAT</b> button. On/Standby	Press the <b>AMP</b> button. On/Standby
<b>MENU</b>	To display the main menu	To display the main menu	To display the main menu	
 	Vertical scrolling in menus	Vertical scrolling in menus	Vertical scrolling in menus	
 	Horizontal scrolling in menus	Horizontal scrolling in menus	Horizontal scrolling in menus	
<b>OK</b>	To confirm an action	To confirm an action	To confirm an action	
<b>EXIT</b>	To close a menu	To close a menu	To close a menu	
<b>0-9</b>	To directly access channels or enter numeric values	To enter numeric values or select options in menus	To directly access channels or enter numeric values	To select a station using its number
<b>PR+ / PR-</b>	To change channels	To change chapters	To change channels	To change stations
<b>AV</b>	To select AV input	To select AV input		
<b>REV</b>	Rewind	Rewind		
<b>PLAY</b>	Play	Play		
<b>FWD</b>	Fast forward	Fast forward		
<b>STOP</b>	Stop	Stop		
<b>PAUSE</b>	Pause picture	Pause picture		
<b>REC</b>	Record			
 <b>MUTE</b>				To switch the sound off and back on again
 +/-				To set the volume level

**Important:**  
If the batteries in your remote control are run down you can use the buttons on the front of your TV set. In TV mode, they have the same functions as the corresponding buttons on the remote control. In the menus they have the following functions:

- PR**  
- PR**  
- VOL**   or **OK**
- VOL**   or **OK**
-  **MENU** To confirm a selection

## Initial set-up

Initial set-up involves selecting all the settings required to be able to search for and store all the channels you can receive. Make sure that the television is switched on and follow all the steps in turn specified hereafter.

The first time you switch the television on, the language selection menu appears.



2

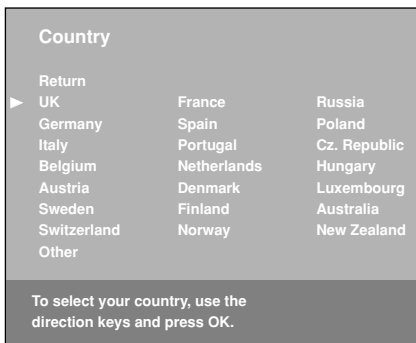

3

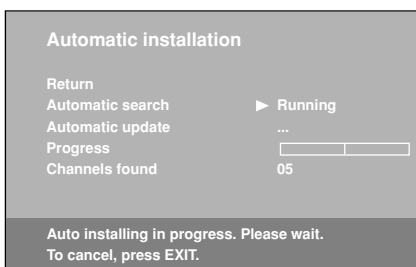

5

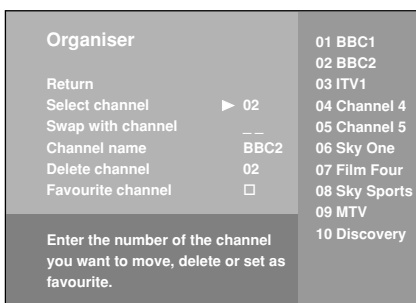

1. Select your language using the **▲ ▼ ◀ ▶** buttons and confirm by pressing **OK**. When you select a language, it is applied to the menus immediately.

2. A list of countries appears. Select the relevant country using the **▲ ▼ ◀ ▶** buttons. Press **OK** to confirm.

*Note: This is the country you are in, or the country whose channels you want to receive if you live near its borders.*

3. The **Automatic installation** menu appears. The **Automatic search** option is selected. Start the automatic set-up by pressing **OK**. The message **Running** appears next to the **Automatic search** option and the **Progress** and **Channels found** options appear, informing you of the installation procedure's progress.

*Notes:*

- The automatic set-up process can take up to 10 minutes. To prevent the channel set-up process from being interrupted, wait for the message indicating that the set-up is complete before closing the menu.

- The automatic set-up process deletes all the channels previously stored.

4. Channels are arranged in a pre-set order.

- To modify this order, name and rename channels or delete channels stored twice, press **OK** and go to step 5.

- If you do not want to reorganise the channels, press **EXIT** to close the menu.

5. The **Organiser** menu allows you to change the order of the channels as arranged during the automatic set-up process, to name or rename channels, as well as delete channels stored twice or with poor reception quality. You can also define certain channels as your favourite channels so that you can access them more quickly by pressing the **PR+/PR-** buttons. Simply follow the instructions at the bottom of the screen. Use a TV programme magazine to identify the channels.

- Organising channels: Select the **Select channel** option. Using the **PR+/PR-**, **◀ ▶** or numeric buttons, display the number of the channel to be moved. Select the **Swap with channel** option. Using the **◀ ▶** or numeric buttons, enter the number you want to assign this channel to. Press **OK**.

- Changing a channel name: Select the **Select channel** option. Using the **PR+/PR-**, **◀ ▶** or numeric buttons, display the number of the channel whose name you want to change. Select the **Channel name** option and choose a name from the list using the **◀ ▶** buttons. If none of the names available is suitable select -----. The cursor appears at the first dash. Use the **▲ ▼** buttons to select a character from the list made up of the letters in the standard alphabet, the numbers 0 to 9 and certain punctuation symbols. Use the **◀ ▶** buttons to go to another character. A name can only have a maximum of six characters. Press **OK** to confirm.

- Deleting a channel: Select the **Select channel** option. Using the **PR+/PR-**, **◀ ▶** or numeric buttons, display the number of the channel to be deleted. Select the **Delete channel** option and press **OK**.

- Defining a favourite channel: Select the **Select channel** option. Using the **PR+/PR-** or numeric buttons, display the number of the channel you want to define as a favourite. Select the **Favourite channel** option and check the box by pressing **OK**. You can define up to six favourite channels.

When you have finished press **EXIT** to close the menu.

To access the **Organiser** menu another time, press the **MENU** button to display the **OVERVIEW** menu, select **Installation** and press **OK**. Then select **Organiser** from the **Installation** menu.



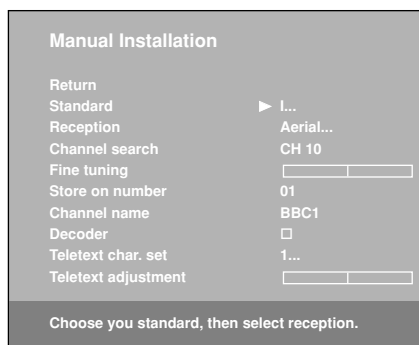

## Manual channel set-up

Follow the procedure given on this page if you find that some channels have not been stored during the initial set-up. This can happen if you are setting up cable network channels. Setting up channels manually requires every setting for a particular channel to be entered, one at a time.

Display the **OVERVIEW** menu by pressing the **MENU** button. Select the **Installation** option and press **OK** to confirm. Select the **Manual installation** option from the **Installation** menu and press **OK** to confirm.

1. Select the **Standard** option. Use the **<>** buttons to select the standard for your country.  
*Note: The following standards are available to choose from: **I** for the UK and Ireland, **France** for France and Luxembourg, **DKK'** for Eastern Europe, the Middle East and Asia, **EURO** **BG** for Western Europe, **Australia** for Australia, and **New Zealand** for New Zealand.*
2. Select the **Reception** option. Select the reception method for the channels (aerial or cable network) using the **<>** buttons.
3. Select the **Channel search** option. Enter the number of the reception channel or use the **<>** buttons to find the channels. When a channel has been found the picture is displayed.
4. If the picture is not clear you can adjust the setting. You do this by selecting the **Fine tuning** option and adjusting it with the **<>** buttons.
5. Select the **Channel name** option and choose a name from the list using the **<>** buttons. If none of the names available is suitable select **CH \_ \_ \_ \_**. Use the **▲ ▼** buttons to select a character from the list made up of the letters in the standard alphabet, the numbers 0 to 9 and certain punctuation symbols. Use the **<>** buttons to go to another character. Press **OK** to confirm.
6. If the channel is encoded and you want to connect a decoder to the AVI socket, select the **Decoder** option and check the box by pressing **OK**.
7. Then select the **Teletext char. set** option and choose the character set that will be used for Teletext on this channel using the **<>** buttons. The following character sets are available:
 

1: Western Europe, Greek	4: Arabic
2: Eastern Europe	5: Ukrainian
3: Russian, Belarussian	
8. To improve Teletext reception, select the Teletext adjustment option and adjust using the **<>** buttons.
9. Then select the **Store on number** option and enter the number to be assigned to this channel using the numeric buttons (for instance, for BBC1 type 01). Press **OK**.  
*Important: Whenever you change a value in the **Manual Installation** menu, the **Store on number** option starts flashing. To confirm your change you need to select the **Store on number** option and press **OK**. If you do not confirm the change it will be cancelled when you change channels or put the TV set in standby.*

Repeat this procedure to find other channels.

Notes:

- For cable networks, to search for missing channels, select **Other** instead of a country, then select **Automatic update** in the **Automatic installation** menu.
- If you wish to go through the whole initial set-up process, put the TV in standby mode, then hold down the **VOL ◀** button on the television and the **MENU** button on the remote control until the menu displays. Proceed as for the initial set-up.
- Subsequent set-ups:
  - The **Automatic update** function allows you to set up channels just launched or any channels that are missing or wrongly set up.
  - The **Automatic search** function is used for setting up channels after the initial set-up (e.g. after moving house). This process deletes all channels previously stored.

## Switching the TV set on and off

- To switch the TV set on:
  - press the **POWER/⏻** button on the side of the TV set, the **⏻** or **OK** on the remote control to switch the television on at the last channel or AV programme you were watching,
  - press the **TV** or **PR+/PR-** buttons to switch the television on at the last channel you were watching,
  - press any numeric button to switch the television on at the corresponding channel,
  - press the **AV** button to switch the television on at the last AV programme you were watching.
- To put the TV set into standby mode, press the **POWER/⏻** button on the side of the TV set or the **⏻** button on the remote control. The TV set remains powered up, but with low energy consumption.
- To switch off the TV set, unplug the mains socket from the mains outlet.

## Accessing channels

- Using the numeric buttons:
  - ◆ for channels 1 to 9, press the corresponding numeric button;
  - ◆ for channels 10 to 99,
    - press the tens digit for a few seconds to display it on the screen, then press the units digit. For instance, for programme 24, press and hold **2** to display **2-**, then press **4**; or
    - press the **0/--** button to display "--", then enter the two digits.
- Using the **PR+/PR-** buttons: scroll through the channels. AV programmes are not included in the cycle unless you use the buttons on the side of the TV set.
- Using the list of programmes: refer to page 9.

To access the channel or AV programme previously being watched, press the **RETURN** button.

## Accessing your favourite channels

You can define the channels you watch most often as your favourite channels. This will allow you to create your own list of channels which you can access more quickly using the **PR+/PR-** buttons on the remote control.

1. Follow the procedure described in point 5 on page 6 for defining a channel as your favourite channel.
2. Press the **PRESETS** (red) button on the remote control.
3. Select the **PR+/PR- keys** option. Use the **◀▶** buttons to select **Favourites**.

When you change channels using the **PR+/PR-** buttons on the remote control only your favourite channels will be available.

To cancel this option, select **All channels** under the **PR+/PR- keys** option.

*Note: The **PR▲▼** buttons on the TV set allow you to access all the channels set up, even if the **Favourites** option is selected*

## Accessing AV programmes

Press the **AV** button to display the last selected audio-visual programme and scan through the other audio-visual programmes. AV selection loop: AV1, AV2, AV3, CMP (= component, YPrPb or YCrCb), VGA, HDMI.

## Volume

- Volume control: use the **◀VOL▶** buttons on the side of the TV set or press the **◀+/-** buttons on the remote control to increase or decrease the volume.
- Sound mute: press the **🔇** button to temporarily mute the sound. Press this button again or the **◀+** button to restore it.
- Headphone volume control: press the **◀+/-** buttons on the remote control to display the volume control bar. Then use the **◀▶** buttons to switch to the headphone volume control bar. Use the **◀+/-** buttons to adjust the volume.

## Displaying status information

- In TV mode you can press the **INFO** (yellow) button on the remote control to display the number and name of the relevant channel, the time and date, the type of sound and format or zoom. If the sleep or turn-off timer is set the time remaining until the TV set is switched into stand by is displayed.
- In PC mode you can press the **INFO** (yellow) button on the remote control to display the time and date, the type of format, as well as the source of the signal being received and the resolution. If the sleep or turn-off timer is set the time remaining until the TV set is switched into stand by is displayed.

When you switch the TV set on, change channels or exit Teletext, the channel's number and name are displayed.

*Note: If you activate the **Channel number** function in the **Preferences** menu, the channel number will be displayed permanently (see page 17).*

## Zoom

In TV mode, you have the option of changing the display format and using the zoom function via the ◀ ▶ buttons. The available formats and zoom functions are:

**4/3 format** - picture in centred 4:3 format

**14/9 zoom** - picture in centred letterbox 14:9 format

**16/9 zoom** - picture in centred letterbox 16:9 format

**16/9 zoom up** - picture in 16:9 format with subtitles.

**Cinerama** - picture in widescreen 4:3 format

**16/9 format** - picture in widescreen 16:9 format

In **14/9 zoom**, **16/9 zoom**, and **16/9 zoom up** modes, you can temporarily shift the picture up and down using the ▲ ▼ buttons.

In PC mode, only **4/3 format** and **16/9 format** are available.

*Plasma TV sets: Do not use for lengthy periods of time formats which do not fill the entire screen in order to avoid screen burnout.*

## List of channels

Press the **LIST** (green) button on the remote control to display the list of channels. It contains a maximum of 11 pages and shows the name and number of every channel. The last page lists units connected to the AV sockets.

The list appears on the page featuring the channel or AV programme which you are currently watching. The channel or AV programme you are watching is indicated by a symbol. Any channels and AV programmes which are locked are indicated by a closed padlock and those temporarily unlocked are indicated by an open padlock. Favourite channels are indicated by the letters **FAV** next to them.

*Note: For more information on locking channels, refer to the Parental control section.*

To watch one of the channels on the displayed page, select it using the ▲ ▼ buttons and press **OK**, or use the **PR+/PR-** buttons. You can also enter the last digit of the channel number (for example, 5 for 25). The selected channel is shown.

You can scroll through the pages using the ◀ ▶ buttons.

Press **EXIT** to close the menu.

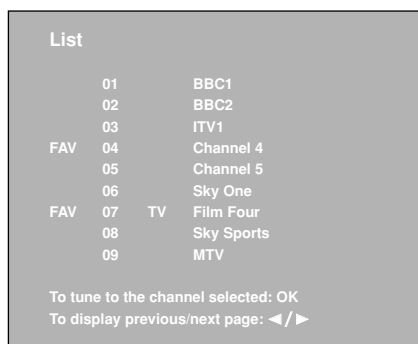

## Freezing a picture

Press the **OK** or **FREEZE** button to freeze the picture. Press any button on the remote control or TV set to cancel this function. In PIP mode, press the **FREEZE** button to freeze the picture of the main programme.

*Plasma TV sets: Do not leave the frozen picture on screen for a lengthy period of time in order to avoid screen burnout.*

## Flat batteries

When the batteries are flat a message appears on the screen when you press a button on the remote control.

You should change the batteries and reprogram the remote control (see page 4).

## Product information

Press the **MENU** button to open the **OVERVIEW** menu. Select the **Contact us!** option and press **OK** to confirm. The relevant screen appears. This will give you the Thomson Europe website address and the telephone number for the Helpline, if there is one (see page 2), as well as your TV set's serial number.

Press **EXIT** to close the menu.

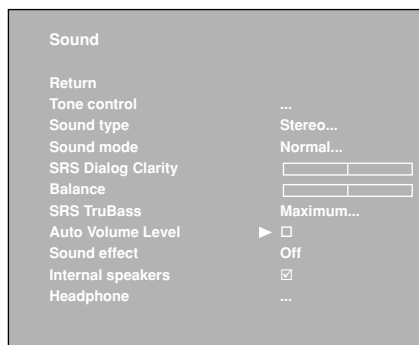

## Adjusting the sound

Display the **OVERVIEW** menu by pressing the **MENU** button. Select the **Sound** option and press **OK** to confirm. The **Sound** menu appears with the following options:

**Tone control:** this option gives you access to the **Tone control** menu (more details below).

**Sound type:** select a sound type from the list using the **<>** buttons.

The default sound type is **Automatic** for mono sources, **Stereo** for stereo sources and **Stereo** for AV sources.

*Note: The options offered depend on the programme you're watching. Refer to the table 1 opposite.*

**Sound mode:** use the **<>** buttons to choose a mode from the list. **SRS TruSurroundXT** is the default mode.

*Notes:*

- The options available depend on the sound type selected. Refer to the table 2 opposite.

- **SRS TruSurroundXT** mode reproduces virtually on two channels only the sound from a multi-channel source and enhances the rendition of dialogue and bass.

- **SRS TruSurround** mode reproduces virtually on two channels only the sound from a multi-channel source.

- **SRS WOW** mode can be used to obtain optimum bass reproduction

**SRS Dialog Clarity:** this function boosts the central channel to make dialogue easier to understand. You can use the **<>** buttons to adjust it.

*Note: This option only appears if you have selected **SRS TruSurroundXT** under the **Sound mode** option.*

**Balance:** use the **<>** buttons to balance the sound between the left and right speakers.

**SRS TruBass:** this function is used to strengthen the bass. Select an option from the list using the **<>** buttons.

**Auto Volume Level:** check the box by pressing the **OK** button, if you want to keep the same sound level for all channels.

**Sound effect:** this function allows you to create sound effects. Select an option from the list using the **<>** buttons.

**Internal speakers:** uncheck this box by pressing **OK** if you want to stop the sound coming from the internal speakers and connect external speakers to the TV set.

If you unplug these external speakers, remember to check the box to reactivate the TV set's internal speakers (otherwise you will not get any sound).

**Headphone:** this option allows access to the headphone setting menu (see further below).

Press **EXIT** to close the menu. Select **Return** and press **OK** to return to the **OVERVIEW** menu.

## Tone control

Select the **Tone control** option from the **Sound** menu and press **OK** to display the menu. The content of this menu depends on the options you have selected under **Sound mode** and **Sound effect** in the **Sound** menu.

● If you have not selected any effect under **Sound effect**, the menu which is displayed allows you to select a predefined setting and choose your own settings using the graphic equaliser. It offers the following options:

**Sound preset:** use the **<>** buttons to select the appropriate setting for the programme you are watching.

The **Personal** setting stores your graphic equaliser settings.

*Note: The **Sound preset** option is not available if you have selected a sound effect under the **Sound effect** option.*

You can access the list of preset sound settings directly by pressing the **PRESETS** button (red) on the remote control, selecting the **Sound preset** option and choosing one of the preset settings from the list. Your selection is applied to all channels and AV programmes. Press **EXIT** or **PRESETS** to close the menu.

**1**

Broadcast	Sound types
Mono	Automatic - Mono
Stereo	Mono - Stereo
Dual	Sound 1 - Sound 2
NICAM - 3	Sound 1 - Sound 2 - Sound 3
Analog AV	Stereo - Sound 1 - Sound 2

**2**

Sound type	Sound modes
Automatic	Normal - Wide - SRS
Mono - Sound 1	TruSurroundXT
Sound 2 - Sound 3	SRS TruSurround - SRS WOW
Stereo	Normal - Stereo wide
	TruSurroundXT
	SRS TruSurround - SRS WOW

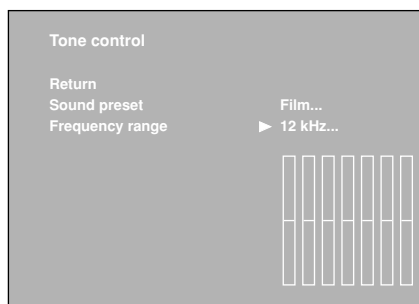

**Frequency range:** the graphic equaliser has seven frequency bands. Select each band in turn using the ◀ ▶ buttons and make the necessary adjustments using the ▲ ▼ buttons. Press **OK** to confirm.

*Note: When you are setting the graphical equaliser, **Personal** appears under the **Sound preset** option and your settings are stored as your new personal settings.*

● In every other instance, the menu displayed offers the following options:

**Bass, Treble:** you can adjust these settings to the level you want using the ◀ ▶ buttons.

Press **EXIT** to close the menu. To return to the **Sound** menu, select **Return** and press **OK** to confirm.

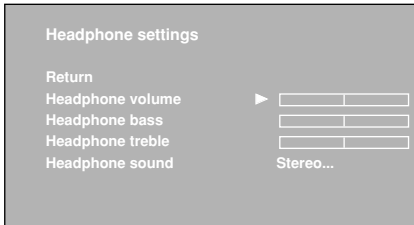

## Headphone settings

Select the **Headphone** option from the **Sound** menu and press **OK** to display the menu. The following options are available:

**Headphone volume, Headphone bass, and Headphone treble:** you can adjust these settings to the level you want using the ◀ ▶ buttons.

**Headphone sound:** select a sound type from the list using the ◀ ▶ buttons.

The default sound type is **Automatic** for mono sources, **Stereo** for stereo sources and **Stereo** for AV sources.

Press **EXIT** to close the menu. To return to the **Sound** menu, select **Return** and press **OK** to confirm.

TruSurroundXT, SRS and  symbol are trademarks of SRS Labs, Inc. TruSurroundXT technology is incorporated under license from SRS Labs, Inc.

## Adjusting the picture

The menus for adjusting the picture are used to obtain the best picture setting according to your preference, the type of programme you are watching and the ambient lighting. When you make an adjustment only the selected option remains displayed, allowing you to see the changes taking place on screen. The entire menu is displayed again when you select another option or the time for making an adjustment has elapsed.

Display the **OVERVIEW** menu using the **MENU** button. Select the **Picture** option and press **OK** to confirm. The **Picture** menu appears with the following options:

**Picture preset:** use the ◀ ▶ buttons to select the appropriate setting for the programme you are watching.

**Personal** contains the values you have defined for the settings **Brightness, Colour, Contrast, Black expand, Tone, Sharpness** and **Noise reduction**.

You can access the list of preset picture settings directly by pressing the **PRESETS** button (red) on the remote control, selecting the **Picture preset** option and choosing one of the preset settings from the list. Your selection is applied to all channels. You must, however, select a preset setting for each AV programme. Press **EXIT** or **PRESETS** to close the menu.

*Note: This function is only available in TV mode.*

**Brightness, Colour, Contrast, Tone, Sharpness:** adjust these settings as required using the ◀ ▶ buttons.

**Black expand:** can be used to adjust the picture according to the ambient brightness. Select an option from the list using the ◀ ▶ buttons.

**Noise reduction:** improves the quality of the picture in the case of poor reception. Select an option from the list using the ◀ ▶ buttons.

**Other settings:** this option provides access to the **Other settings** menu (see further below).

Press **EXIT** to close the menu. To return to the **OVERVIEW** menu, select **Return** and press **OK** to confirm.

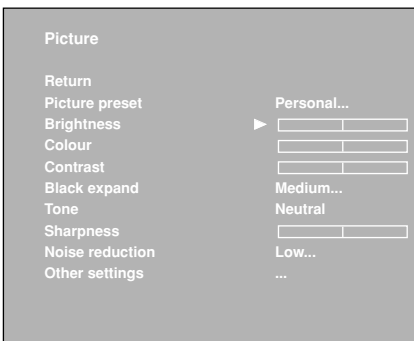

TV mode

# Advanced functions

EN

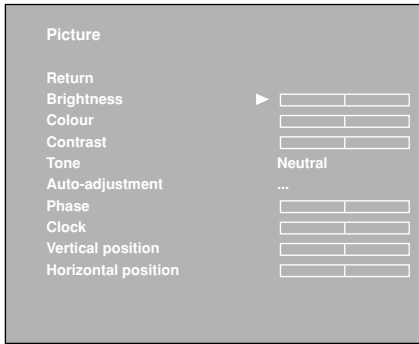

PC mode

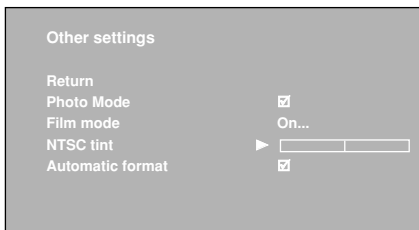

In PC mode you can access a number of specific functions:

**Auto-adjustment:** this option allows you to automatically adjust the following functions: **Phase, Clock, Vertical position** and **Horizontal position**. Press **OK** until the message **Running** appears. Once the setting is implemented the message **Done** appears.

**Phase, Clock:** adjust these settings as required using the **<>** buttons in order to enhance picture quality.

**Vertical position:** use the **<>** buttons to move the picture vertically on the screen.

**Horizontal position:** use the **<>** buttons to move the picture horizontally on the screen.

## Other settings

*Note: This menu is only available for TV channels and AV programmes.*

Select the **Other settings** option from the **Picture** menu and press **OK**. The **Other settings** menu appears with the following options:

**Photo Mode:** improves quality and stability of still pictures. When this function is enabled still pictures are detected automatically and their resolution enhanced. Check the box by pressing **OK** to enable this function.

*Note: This function is only available for certain audio-visual sources.*

**Film mode:** detects that the programme being broadcast is a film and enhances picture quality. Select an option from the list using the **<>** buttons.

*Notes:*

- The **Advanced** option is selected by default.

- This function is only available for certain audio-visual sources.

**NTSC tint:** is used to adjust the picture's tint. Adjust these settings as required using the **<>** buttons.

*Note: This function is only available for NTSC audio-visual sources.*

**Automatic format:** automatically applies the appropriate format to the picture. Check the box by pressing **OK** to enable this function.

*Note: This function is only available for certain audio-visual sources.*

Press **EXIT** to close the menu. To return to the **Picture** menu, select **Return** and press **OK** to confirm.

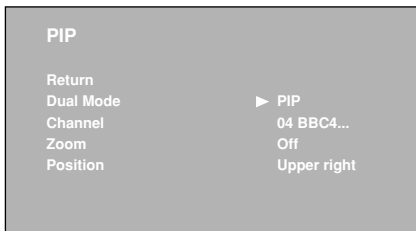

## PIP - PAP

This function can be used to display a second source (TV,AV, etc.) in a corner of the screen or on the right side of the screen. It is available in both TV and PC mode.

*Note: If this function is not available for the source displayed on the screen a message will inform you of this.*

Press the **MENU** button to display the **OVERVIEW** menu. In PC mode, select **PIP** and press **OK**. The **PIP** menu offers the following options:

**Dual mode:** use the **<>** buttons to select an option from the list:

- **Off:** function is disabled, full screen in TV or PC mode.
- **PIP:** a channel or AV programme is displayed in a frame in a corner of the screen.
- **PAP:** the screen is divided vertically in two and the PIP is displayed on the right side.

The other menu options may or may not still be accessible, depending on the option you have selected:

- In **PIP** mode, you can select the programme, the zoom and the position of the frame on the screen. Select an option from the list each time using the **<>** buttons.
- In **PAP** mode, you can select the programme to be displayed in the frame. Select an option from the list each time using the **<>** buttons.

Press **EXIT** to close the menu. Select the option **Return** and press **OK** to return to the **OVERVIEW** menu.

## Operation

Use the **PIP** button on the remote control to enable the different display modes in turn. In TV mode, the sound always comes from the main programme. In PC mode, the sound always comes from the VGA or HDMI AV source.

In both display modes:

- Press the **FREEZE** button to freeze the picture of the main programme.
- To apply the PIP function to an AV programme in RGB, you need to select **RGB** as the relevant AV source in the **AV Settings** menu (see page 17).
- If the channel or AV programme that you want to apply the PIP function to is locked the pictures will not be displayed. Change channel or press **OK**. Then follow the instructions on the screen.

In **PIP** mode:

- Use the **SWAP** button to swap the channels around.
- Use the **PIP ZOOM** button to change the size of the PIP picture.
- Use the **▲ ▼** buttons to change the position of the PIP frame on the screen.
- Use the **PIP+/PIP-** buttons to change channels on the right side of the screen.
- In TV mode, press **OK** to display the PIP picture on the full screen.

In **PAP** mode:

- Use the **SWAP** button or **<>** buttons to swap screens.
- Use the **PIP+/PIP-** buttons to change channels on the right side of the screen.
- Use the **TEXT** button (purple) to display on the right side of the screen Teletext on the channel displayed on the left. Press **EXIT** to disable this function.

Press **EXIT** to quit PIP mode and return to full screen in TV or PC mode.

## Time

Return	
Sleep timer	▶ Off
Time reference	04 BBC4
Time	12:34
Date	01/06/05
Calendar	...
Wake up timer	Once
Wake up time	07:00
Wake up channel	10 CNN
Turn off timer	Once
Turn off time	12:00

## Setting the time

The **Time** menu allows you to set the time and date on your TV set, to programme an automatic turn-off or wake-up timer and to view the calendar.

Display the **OVERVIEW** menu by pressing the **MENU** button. Select the **Time** option and press **OK** to confirm.

## Setting the time and date

1. Select the **Time reference** option.
2. Select a channel which displays Teletext so that the time and date from this can be used as a reference, by using the ◀▶ buttons or entering a channel number using the numeric buttons on the remote control. The time and date appear in a couple of seconds if they are available on the channel that has been selected.
3. If the time and date are not supplied by Teletext they will not appear under the **Time** and **Date** options. You will then have to enter them manually. Select the **Time** option and enter the time using the numeric buttons or the ◀▶ buttons. The setting -- appears under the **Time reference** option. Select the **Date** option and enter the date using the numeric buttons in the format: DD/MM/YY.

Notes:

- In the event of the power supply being cut off (the TV set is unplugged or there is an electrical fault), the time and date will be lost, if they have been entered manually. You need to enter them again. In this instance, we advise you to consult a channel which has this information and to check that it is correct.
- If the time has not been set, when you select the **Time** option from the **OVERVIEW**, a message appears prompting you to set the time.

## Calendar

Return	
Month	▶ September
Year	2005
Today	...

Mon	Tue	Wed	Thu	Fri	Sat	Sun
			1	2	3	4
5	6	7	8	9	10	11
12	13	14	15	16	17	18
19	20	21	22	23	24	25
26	27	28	29	30		

## Using the calendar

This menu allows you to look for a particular date.

1. Select the **Calendar** option and press **OK** to confirm. The **Calendar** screen appears.
2. Under **Month** select the month you want from the list using the ◀▶ buttons.
3. Under **Year** select the year you want from the list using the ◀▶ buttons.

The calendar displays the selected month.

To display the calendar for the current month, select the **Today** option and press **OK** to confirm. The current day is automatically selected if the date is available.

## Programming a turn-off timer

You can programme the TV set's turn-off timer by setting a period of time after which or a specific time when the TV set goes into standby mode.

To set a period of time after which the TV set goes into standby mode:

1. Select the **Sleep timer** option.
2. Using the ◀▶ buttons, set the period after which the TV set automatically goes into standby mode (4 hours maximum, at 5-minute intervals). To disable this function, select **Off**.

Note: You can access this function directly by pressing the **SLEEP** button on your remote control.

To select a time for the TV set to go into standby:

1. Select the **Turn off timer** option.
2. Using the ◀▶ buttons, choose **Once** or **Daily** from the list. Select **Off** to disable this function.
3. Select the **Turn off time** option. Using the numeric buttons or ◀▶ buttons, enter the time at which you want the TV set to go into standby mode.

When one of these functions (Sleep timer or Turn off timer) is on, a message appears one minute before the television set goes into standby mode. Press any button on the remote control to cancel standby mode.

Press **EXIT** to close the menu. To return to the previous menu, select **Return** and press **OK** to confirm.



## Programming the wake-up timer

This function can be used to set the time for the set to come on, for instance, for the television to wake you up.

1. Select the **Wake-up timer** option. Using the numeric buttons or **<>** buttons, choose **Once** or **Daily** from the list to activate this function and access the relevant options. Select **Off** to disable this function.
2. Under the **Wake-up time** option enter the wake-up time using the numeric or **<>** buttons.
3. Under the **Wake-up channel** option enter the number of the channel you want to wake you using the **<>** or numeric buttons. You can also select an AV programme using the **AV** button. In this case, make sure you programme the equipment connected to the AV socket to come on as well.
4. Press **EXIT** to close the menu. A message appears to say that the wake-up timer has been programmed. Press any button on the remote control to make the message disappear.
5. To enable the function, press the **⏻** button on the remote control to put the TV set into standby mode.

The TV set will automatically come on at the programmed time if you do not interrupt it by using the remote control. Once the TV set is on:

- you can use all its functions as normal;
- you can put the TV into standby mode. In this case, the **Wake-up timer** function is disabled for the relevant day;
- if the channel or AV programme selected from the menu is locked you need to enter your code to access it.

## Parental control

The parental control functions allow you to restrict your children's access to the television. This means that you can lock the set's buttons and prevent access to certain channels and/or AV programmes. You can also lock the **Time** menu to prevent any of the automatic turn-off and wake-up timers you have programmed for your set from being modified. You can also prevent access to the **Installation** menu to prevent any channels from being set up without your consent. All these functions are protected by a PIN code.

Display the **OVERVIEW** menu by pressing the **MENU** button. Select the **Parental control** option and press **OK** to confirm. Follow the instructions on screen for displaying the menu.

## Defining a PIN code

To be able to use the functions in the **Parental control** menu, you need to first of all define a 4-digit PIN code as follows:

1. Select the **PIN code** option from the **Parental control** menu. Enter your code using the numeric buttons. The numbers are replaced by asterisks on screen.
2. Type your code in again to confirm it.

*Note: Choose a code that you can easily remember.*

You can now use the various parental control functions.

*Note: Once a parental control function is enabled, you need to enter your PIN code to access the **Parental control** menu.*

To amend your PIN code, select the **PIN code** option. Enter your new code using the numeric buttons. Type your code in again to confirm it.

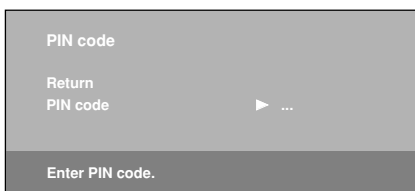

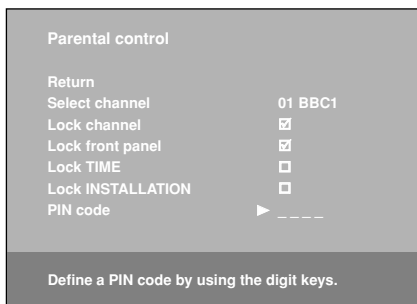

## Locking a channel or AV programme

1. Select the **Select channel** option from the **Parental control** menu. Use the **<>** or numeric buttons to select the channel to be locked. Use the **<>** buttons or press the **AV** button to access the AV programmes.

2. Check the box under the **Lock channel** option by pressing **OK**.

*Note: This function is only available if a code has been defined.*

To unlock the channel or AV programme, go to the **Parental control** menu by entering your code, select the **Lock channel** option and uncheck the box by pressing **OK**. Press **EXIT** to close the menu.

## Locking the buttons on the TV set

Select the **Lock front panel** option from the **Parental control** menu and check the box by pressing **OK**.

Notes:

- This function is only available if a code has been defined.

- The remote control is needed to be able to use the television.

To cancel the lock, go to the **Parental control** menu by entering your code, select the **Lock front panel** option and uncheck the box by pressing **OK**. Press **EXIT** to close the menu.

## Locking the Time menu

Select the **Lock TIME** option from the **Parental control** menu and check the box by pressing **OK**.

Notes:

- This function is only available if a code has been defined.

- When this function is active you need to enter your PIN code to be able to access the **Time** menu.

To cancel the lock function, enter your PIN code to access the **Parental control** menu, select the **Lock TIME** option and uncheck the box by pressing **OK**. Press **EXIT** to close the menu.

## Locking the Installation menu

Select the **Lock INSTALLATION** option from the **Parental control** menu and check the box by pressing **OK**.

Notes:

- This function is only available if a code has been defined.

- When this function is active you need to enter your PIN code to be able to access the **Installation** menu.

To cancel the lock function, enter your PIN code to access the **Parental control** menu, select the **Lock INSTALLATION** option and uncheck the box by pressing **OK**. Press **EXIT** to close the menu.

## Operation (TV mode)

- To watch a channel or AV programme which is locked, try accessing it and follow the procedure on the screen. The lock will be applied again when you put the television in standby.

In the list of programmes, channels and/or AV programmes which are temporarily unlocked are indicated by an open padlock.

- If you have forgotten your PIN code you can cancel it:

Put your TV set into standby mode, then press the **VOL** **<** button on the TV set and the **EXIT** button on the remote control simultaneously for five seconds. This procedure is possible, even if you have locked the buttons on the TV set.

## Customising your television

### Preferences

You can set preferences for some features. These preferences remain in force as long as you do not change them.

Display the **OVERVIEW** menu by pressing the **MENU** button. Select the **Installation** option and confirm by pressing **OK**. Select the **Preferences** option from the **Installation** menu and press **OK** to confirm. The **Preferences** menu offers the following options:

**Channel number:** check this box using the **OK** button to permanently display the number of the channel being watched.

**Important:** on plasma TV sets, due to the risk of screen burnout, we recommend that you disable this function.

**Language:** select from the list the language the menus will be displayed in using the **<>** buttons.

*Note: When you select a language, it is applied to the menus immediately.*

**Maximum TV volume:** set the maximum volume level using the **<>** buttons. To hear the level that you have just set, press the **OK** button and hold it for a few seconds.

**Programme info pages:** if you have changed the reference page for the TV programmes in Teletext you can restore the factory-set reference pages. Press **OK** until the message **Running** appears. Once the setting is implemented the message **Done** appears.

**Power Savings Mode:** when this function is active the TV set automatically goes into standby mode after five minutes if it does not receive any signal on the selected channel or AV programme. To enable this function, check the box by pressing **OK**.

**Burn in protection (plasma TV sets only):** when this function is on, it moves the picture on screen without the user noticing it in order to prevent screen burnout.

*Note: This function is enabled by default.*

Press **EXIT** to close the menu. Select the option **Return** and press **OK** to return to the **Installation** menu.

### Configuring AV sockets

You can configure your TV set according to the equipment you connect to it.

Display the **OVERVIEW** menu by pressing the **MENU** button. Select the **Installation** option and press **OK** to confirm. The **Installation** menu appears. Select the **AV settings** option and press **OK** to confirm. Follow the messages on screen and the instructions below explaining how to configure the AV sockets.

**AV1 name:** use the **<>** buttons to select from the list the name of the equipment connected to this socket. If the factory preset names do not suit you, select **AV1\_ \_ \_** and enter another one, following the screen messages.

**AV1 video input:** use the **<>** buttons to select from the list the type of video signal transmitted by the equipment connected to the AV1 socket.

*Note: Select **RGB** if no picture is displayed when you connect a games console.*

Repeat the same procedure to configure the AV2 socket.

**AV3 name:** use the **<>** buttons to select from the list the name of the device connected to the AV3 sockets. If none of the devices in the list is appropriate, select **AV3\_ \_ \_** and enter the name of the device following the instructions on the screen.

**AV3 video input:** use the **<>** buttons to select from the list the type of video signal transmitted by the equipment connected to the AV3 sockets. If the equipment is connected to the AV3 scart socket, select **Video** or **S-Video**. If it is connected to the AV3 cinch sockets, select **Video (cinch)** or **S-Video (cinch)**.

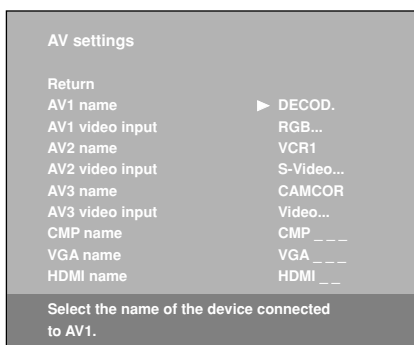
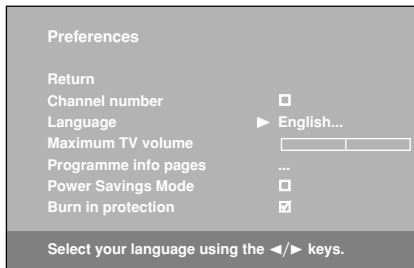

**CMP name:** use the ◀ ▶ buttons to select from the list the name of the device connected to this socket. If none of the devices in the list is appropriate, select **CMP \_ \_ \_** and enter another one, following the instructions on the screen.

**VGA name:** use the ◀ ▶ buttons to select from the list the name of the device connected to this socket. If none of the devices in the list is appropriate, select **VGA \_ \_ \_** and enter the name of the device following the instructions on the screen.

**HDMI name:** use the ◀ ▶ buttons to select from the list the name of the device connected to this socket. If none of the devices in the list is appropriate, select **HDMI \_ \_ \_** and enter the name of the device following the instructions on the screen.

Press **EXIT** to close the menu. Select the option **Return** and press **OK** to return to the **Installation** menu.

## Playing files from memory cards

Insert a card in the relevant connector or plug the USB card reader into the relevant socket on the side of the TV set.

**Important:** Make sure and insert the card in the connector facing the right way.

If the reader does not read the card, display the **OVERVIEW** menu by pressing the **MENU** button. Select the **Memory card** option and press **OK** to confirm. Select the **Memory Card** option from the main menu and press **OK** to confirm.

1. Select from the list the option relevant for the file format that you want to play using the ▲ ▼ buttons: **Music** (mp3, WMA), **Pictures** (JPEG), or **Video Clips** (MPEG, DivX). Press **OK** to confirm. The relevant screen is displayed. The list of folders/files appears on the left of the screen.
2. Use the ▲ ▼ buttons to select a folder/file and press **OK** to confirm. Then press the ▶ button to access the play modes on the right of the screen.
3. Use the ▲ ▼ buttons to select the relevant play mode and press **OK** to confirm. The following play modes are available:

### Standard Play

- Folder: the device plays all the subfolders and files in this folder in the order they were recorded on the card;
- File: the device starts playing from this file.

### Play All

The device plays all the files in all the folders in the order they were recorded on the card.

### Random All

The device plays all the files in all the folders randomly.

### Random Folder

- Folder: the device plays the files in the selected folder randomly.

- File: the device plays this file, then the other files in the selected folder randomly.

### Repeat Folder/File

The device plays the selected folder or file again.

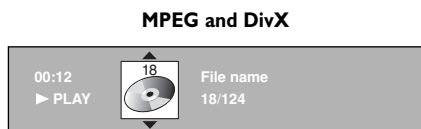
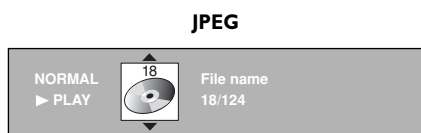
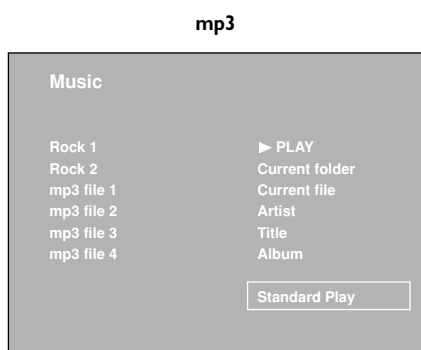

While playing, the screen displays information which varies according to the type of file (see opposite).

While playing, you can still access the sound and picture setting functions. Press the **PRESETS** button (red) on the remote control. In the menu that is displayed:

- Select the **Sound preset** or **Picture preset** option and choose one of the preset settings from the list using the ◀ ▶ buttons.
- Select the **Sound** or **Picture** option. The relevant menu appears.
- Select the **Zoom** option, then select a picture format from the list using the ◀ ▶ buttons.

## Other functions

The main menu offers other functions, which are described below. Select an option and press **OK**.

### Lock

This function can be used to control access to files that can be read by this reader. Press **OK** to display the relevant menu.

**Lock Player.** This is used to lock the reader.

Select **Lock Player** from the **Lock** menu using the **▲ ▼** buttons and press **OK** to confirm. Enter a 4-digit code in the screen that appears using the numeric buttons on the remote control, then press **OK** to confirm. Enter your code again to confirm it, then press **OK**.

*Note: Choose a code that is easy for you to remember or make a note of it.*

When the reader is locked, you need to enter the code to access the options in the **Lock** menu.

**Unlock Player.** This is used to unlock the reader.

Select **Lock** from the main menu using the **▲ ▼** buttons and press **OK** to confirm. Enter your code in the screen that appears using the numeric buttons, then press **OK** to confirm. The **Lock** menu appears. Select **Unlock Player** and press **OK** to confirm. The reader is unlocked.

**Change Password.** This is used to change your password.

Select **Change Password** from the **Lock** menu using the **▲ ▼** buttons and press **OK** to confirm. Enter a new 4-digit code and press **OK** to confirm. Enter your new code again to confirm it, then press **OK**.

**Ratings Limits.** Select **Ratings Limits** from the **Lock** menu using the **▲ ▼** buttons and press **OK** to confirm. You can then define the conditions for accessing unrated titles (which don't contain any parental control information).

Press **OK**. Select **Free Access** if you don't want to set any limits, or **Password Required** if you want to allow the files to be read only after a password has been entered.

These limits are only enabled if you have locked the reader.

**System Test.** If requested by your reseller, you can select the **System Test** option to access certain information.

### Display

This can be used to enable the **On-Screen Displays** function. Press **OK**. The **On-Screen Displays** option appears. Press **OK**. Enable or disable the function by pressing **OK**.

### Sound

This can be used to enable the **Sound Logic** function. You can use this function to control the different sound levels via dynamic compression. It improves the quality of the sound track at a low volume and quietens the loudest sounds. Press **OK**. The **Sound Logic** option appears. Enable or disable the function by pressing **OK**.

### Languages

This can be used to select the language which the menus for the memory card reader are displayed in. Press **OK**. The **Player Menus** option appears. Press **OK**. Select a language from the list using the **▲ ▼** buttons and press **OK** to confirm.

# Advanced functions

## Teletext

The Teletext service is available in many countries under a variety of names (TOP Text, Fastext, FLOF text, Videotext). It is provided as a free service by television broadcasters. This service provides a real wealth of information, available at any time, on weather, sports results, news, games, etc. The information is presented in pages or organised in topics specified in colour on the screen and you can access this information by simply pressing the buttons of the relevant colour on the remote control.

### Accessing Teletext

Press the **TEXT** button (purple) on the remote control. Teletext will display the last page selected, or if you have changed channel, the index page (usually 100). If the particular programme does not provide a Teletext service, a message will appear to this effect.

To display a page, enter its 3-digit number or use the **PR+/PR-** buttons. The page appears after a few moments. The entered number appears:

- red if the page does not exist,
- white if the page has been found,
- green when a sub-page has also been found for this page,
- yellow when the page exists but has not been found yet.

If the current page includes subpages, the page number is displayed in green. In this mode, pressing the **< >** buttons will allow you to step through all the available subpages.

You can select a specific subpage number by pressing **0** to enter subpage direct access mode. The display will look like this: 120 ----. You can then enter the four digits of the sub-page number using the numeric buttons (e.g. 0003).

## Navigator

In the navigator use the **▲ ▼** buttons to select one of the following functions:

### Stop

Some information is spread over several subpages which will be displayed one after the other. To stop subpage scrolling, select **STOP** and press **OK**. Press **OK** to allow the information to move again.

If you select **STOP** and the symbol changes colour, this means that there are no subpages.

### Hidden answers

To reveal a hidden answer (for example, in games), select **?** and press **OK**. Press **OK** once more to hide the answer again.

### Zoom

Select **⌕** and press **OK**: once to zoom in on the top part of the screen, twice to zoom in on the bottom part of the screen and three times to return to normal display.

### Mixed display

Select **☒** and press the **OK** button to display Teletext in the right half of the screen. Use the **TEXT** button to toggle between full screen and mixed display modes.

## Other Teletext functions

### Newsflash

When a newsflash is detected, the **☒** icon is replaced with a **N** in the navigator. Select it and press **OK** to display the newsflash. In the case of an update, the Teletext function is enabled and displays the new information.

### Subtitles

Some channels provide subtitles for some of their programmes. The number of the relevant pages is specified on the Teletext index page.

To display subtitles, enable the Teletext function, find the number of the page displaying the subtitles and enter it. Once the relevant page is found, the subtitles appear in the TV picture. The navigator disappears after a couple of seconds. To display it again, press the **TEXT** button (purple).

### Alarm page

In some countries (Spain, Benelux, etc.), you can set a time to display certain Teletext pages (alarm pages).

To do this, display the relevant alarm page and enter subpage mode. Enter the time instead of the subpage number (e.g. 1705 for 17:05) and press **EXIT**. The page will disappear and will appear again at the set time, as long as you do not change channels or switch off the TV beforehand.

### Direct access

The yellow and blue buttons on the remote control allow you to access directly those pages whose numbers are displayed in yellow and blue at the bottom of the screen.

### Fastext (FLOF)

There is a band displayed at the bottom of the screen in Fastext teletext, which is divided into coloured sections, which represent links to the topics which you can access by pressing the button of the relevant colour. Other topics accessible in the same way can also be displayed.

### TOPtext

TOPtext displays a bar at the bottom of the page divided into two coloured sections (yellow and blue). The blue section displays a topic you can access directly by pressing the blue button. The next topic will then appear in the blue section. The yellow section displays an article you can access directly by pressing the yellow button. The next article will then appear in the yellow section.

### ☒ Storing the programme page

If the broadcasting company amends the pages of its Teletext you need to save the new programme page to be able to access the programme guide (see page 21).

To do this, go to the programme page for the current day and select the **?** function in the navigator. Press the **OK** button until the message "**Store for programme info: OK. Reset: 0**" appears at the bottom of the screen. Press **OK**. Press **EXIT** to quit Teletext, and access the programme guide again.

Press the **EXIT** button to quit Teletext.

Program Info		Thu 13/10/05
01 BBC1		06:00
⊙	06:00 Breakfast	
	09:15 Mirror, Signal, Manoeuvre	
Ⓜ	10:00 City Hospital	
	11:00 Homes Under the Hammer	
Ⓜ	11:30 Bargain Hunt	
	01:00 BBC News	
	01:28 BBC London News	
	01:40 Neighbours	
Ⓜ	02:15 Doctors	
	02:35 Diagnosis Murder	
	Events	...
To set a memo/wake up timer (Ⓜ/⊙): OK.		
To display previous/next page: ◀/▶.		

## 📅 Program Info (programme guide)

The programme guide is only available for channels which have been stored. The information it contains has been compiled by your television based on Teletext information transmitted by the various channels, according to the services they offer. It can be used to find out what programmes are on and to store those which you want to be reminded of when they are about to start.

### Accessing the programme guide

- press the **GUIDE** (blue) button on the remote control, or
- display the **OVERVIEW** menu using the **MENU** button, then select **Program Info** and press **OK** to confirm

EN

**Important:** The guide's availability and context depend entirely on the Teletext transmitted by each broadcaster.

- If the guide is not available on the channel you are watching, a message will inform you of this.
- If the date is not set correctly on the television you are prompted to select a reference channel. Select a channel offering Teletext using the ◀ ▶ buttons or enter the number of the channel using the numeric buttons (see the "Setting the time and date" section on page 14). Then press **OK**.

The **Program Info** screen appears with a list of ten programmes. The first one is the programme currently being shown. If you select the **Events** option the **Events** screen appears, providing a summary of the programmes selected for the TV to come on automatically or for sending a reminder when the programme is starting. Use the ◀ ▶ buttons to go to the previous or following page of programmes.

### Storing programmes

1. Select from the list the programme you want to store, using the ▲ ▼ buttons.
2. Press **OK** twice if you want to be reminded when the programme is starting while you are watching another programme, or three times if you want to programme the TV set to come on automatically when this programme starts.

The programmes in the list which have a reminder set for them are indicated by the symbol 📅. Those stored for the TV set to come on automatically when they start are indicated by the symbol ⌚.

Notes:

- You can select up to four programmes.
- If four programmes have already been selected the ! sign appears in front of the programme option you want to store. You then need to delete a programme to be able to store or record another one. Refer to the section "Checking your selections on the Events screen".

## Events

Return		
⊙	06:00 - 09:15	Breakfast 01BBC1
Ri	10:00 - 11:00	City Hospital 01BBC1
Ri	11:30 - 12:15	Bargain Hunt 01BBC1
Ri	02:05 - 02:35	Doctors 01BBC1

To delete an event, press OK.

## Checking your selections on the Events screen

This screen displays the list of programmes stored. To display it, select the **Events** option from the **Program Info** menu and press **OK** to confirm. The four programmes that are stored are indicated by the same symbols as feature in the **Program Info** screen.

- If you want to delete a programme, select it from the list using the **▲ ▼** buttons, then press **OK**.

- As soon as a programme has been broadcast, it is automatically removed from this list.

Select **Return** to return to the **Program Info** screen and press **OK** to confirm. Press **EXIT** to quit the **Program Info** screen.

## Operation (TV mode)

- Programme stored for a reminder to be sent:  
If you are watching another channel a message appears to tell you that the programme you stored is starting. It appears in a frame in the top right of the screen. Press any button on your remote control to make the message disappear. If you want to watch the stored programme, press **OK**. Press **EXIT** if you want to make the message disappear without switching to the channel showing the stored programme.

*Note: This function can only be enabled if the TV is on.*

- Programme stored for the TV to come on automatically:  
The TV comes on automatically at the time the programme starts and on the channel that is showing it. A message appears stating the name of the programme, the time it starts and the channel it is being shown on.

*Note: This function can only be enabled if the TV is in standby.*



## Sockets

### AV1 and AV2 SCART sockets (input-output) at the back

These sockets can be used to connect a range of equipment, including video recorders, camcorders (VHS, S-VHS, 8 mm or Hi 8 format), decoders, satellite receivers, DVD players, games consoles or devices producing an RGB signal.

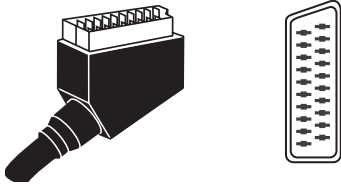

### AV3 SCART socket (input) at the back

This socket can be used to connect equipment, such as video recorders or camcorders (VHS, S-VHS, 8 mm or Hi 8 format).

EN

### AV3 cinch audio + video sockets (input) on the side

These can be mainly used to connect camcorders (VHS or 8 mm format).

### AV3 cinch audio + S sockets (input) on the side

These can be mainly used to connect camcorders (S-VHS or Hi 8 format).

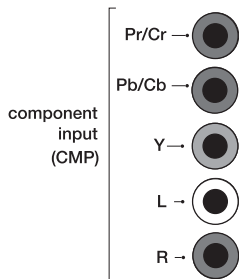

### CMP component sockets (Y Pb/Cb Pr/Cr) + cinch audio sockets (input) at the back

These can be used to connect a DVD player. The component sockets automatically detect the type of component signal received: interlaced component (YPrPb) or progressive component (YCrCb).

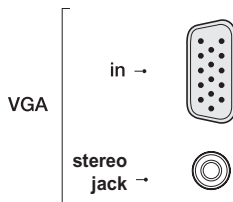

### VGA socket (15 pin) + audio socket (input) at the back

These can be used to connect a computer.

### HDMI socket (or DVI socket + cinch audio sockets) (input) at the back

This can be used to connect a PC with a compatible video card installed, certain DVD players or a high-definition compatible digital satellite decoder. This socket allows a very high transmission quality for the video and audio signals. To connect a device with a DVI socket, you can use the HDMI socket and the cinch audio sockets. In this instance, the HDMI socket is used for receiving the video signal and the cinch sockets for receiving the audio signal. An HDMI-DVI cable is required.

Notes:

- Do not connect a device supplying analogue RGB signals to this socket.
- The HDMI socket is compatible with HDCP format.

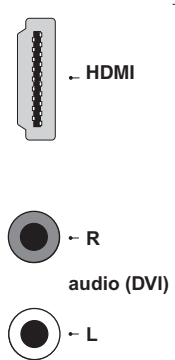

HDMI, the HDMI logo and High-Definition Multimedia Interface are trademarks or registered trademarks of HDMI Licensing LLC.

To display images using the equipment connected, press the **AV** button on the remote control: once to select AV1, twice to select AV2, etc. For some equipment (connected to the SCART sockets), this selection is done automatically.

### Cinch audio sockets (output) at the back

These can be used to connect a stereo amplifier, a hi-fi system or amplified speakers (see further below).

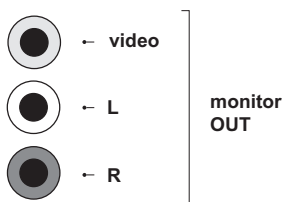

### Cinch audio + video sockets (output) at the back

These can be used to connect a Home Cinema amplifier.

### USB socket (input) at the side

This can be used to connect a memory card reader for cards containing mp3, WMA, JPEG, MPEG, and/or DivX files. The following USB 1.1 and USB 2.0 Mass Storage Class devices are recognised as compatible:

- flash memory card readers
- USB flash memory sticks
- mp3 players with flash memory
- mp3 players with hard disc, with their own power supply
- most digital cameras
- some mobile telephones
- hard disc drives with their own power supply, supporting FAT12 and FAT16 file systems.

The FAT8, FAT12 and FAT16 file systems are supported. NTFS systems are not supported.

### Memory card sockets (input) on the side

These can be used to connect memory cards.

The following formats are supported: SM, SD, MMC, MS, MS Pro, XD, CF and MD.

### Connecting active speakers or an amplifier

The audio cinch sockets on the side of the set can be used to connect active speakers (with a built-in amplifier) or an amplifier.

Connect the left speaker to the cinch L socket and the right speaker to the cinch R socket.

To connect an amplifier, you should connect the cinch left L and right R sockets to the amplifier's L and R inputs.



### Connecting headphones

Use the relevant socket on the side of the TV set to connect headphones or stereo earphones. Refer to page 11 on how to adjust the headphone volume.

### Connecting a video recorder

You are recommended to connect a video recorder via the SCART socket to obtain optimum picture and sound quality. However, you can also connect a video recorder to the TV set only using the aerial socket.

If you select the latter option, switch the video recorder on and play a tape. Then use the **Automatic update** option from the **Automatic installation** menu to search for the appropriate channel for the video recorder (refer to the relevant section). You should assign channel 99 to it to ensure enhanced picture quality when tapes are being played and in pause mode.

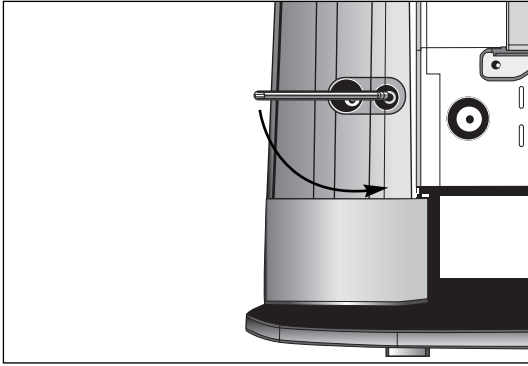
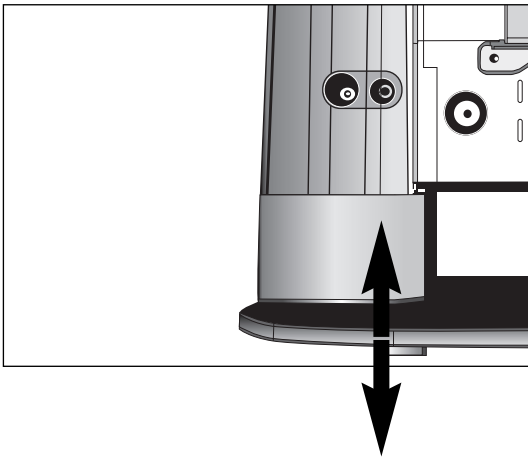
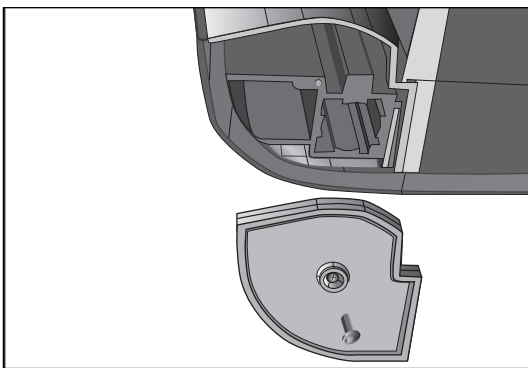
**I****2****3****FR**

Démontage du support de table en vue de la fixation d'un support mural (disponible en option).

Retournez le téléviseur (écran vers le sol) et posez-le sur une surface plane et protégée.

1. Dévissez les deux vis pointeau sur 2 à 3 tours maximum, à l'aide de la clé fournie.
2. Dégagez le support de table du téléviseur en effectuant les mouvements illustrés.
3. Mettez en place et vissez les deux enjoliveurs qui se trouvent dans le sachet de documentation à l'aide des vis également fournies.

Vous pouvez maintenant installer le support mural, en vous reportant aux instructions qui l'accompagnent. Le tableau en bas de page indique pour chaque taille d'appareil le type de support mural VESA à commander.

**DE**

Abbau des Tischfußes für die Montage einer Wandhalterung (als Option erhältlich).

Drehen Sie das Fernsehgerät mit dem Bildschirm nach unten und legen Sie es auf eine völlig flache und sichere Grundlage.

1. Lösen Sie die beiden Stellschrauben mit 2 bis maximal 3 Umdrehungen mithilfe des mitgelieferten Schlüssels.
2. Entfernen Sie den Tischfuß des Fernsehers, indem Sie die zwei dargestellten Bewegungen ausführen.
3. Montieren und verschrauben Sie die beiden Zierblenden, die Sie in der Plastikhülle zusammen mit den mitgelieferten Schrauben finden

Sie können nun die Wandhalterung anbringen. Befolgen Sie dabei bitte die mitgelieferte Anleitung. In der untenstehenden Tabelle finden Sie für jede Gerätgröße den zu bestellenden VESA-Wandhalterungstyp.

**IT**

Smontaggio del supporto da tavolo per il fissaggio di un supporto a muro (disponibile su richiesta).

Girate il televisore (con lo schermo rivolto a terra) e posatelo su una superficie piana e protetta.

1. Con la chiave in dotazione, svitate le due spine filettate di 2 - 3 giri al massimo.
2. Staccate il supporto da tavolo dal televisore effettuando i movimenti mostrati nella fotografia.
3. Posizionate e avvitate i due coperchietti che si trovano nella busta della documentazione con le apposite viti in dotazione.

Adesso è possibile installare il supporto a muro, facendo riferimento alle relative istruzioni. La tabella in fondo alla pagina indica, per ogni dimensione di apparecchio, il tipo di supporto a muro VESA da ordinare.

**EN**

Detaching the table stand to attach the TV set to a wall mount (available separately).

Turn the TV set over (with the screen facing the floor) and place it on a flat, protected surface.

1. Remove the two screws (2-3 turns maximum) using the key supplied.
2. Detach the table stand from the TV set using the movements shown.
3. Fit under the appliance the two covers supplied in the documentation bag using the screws supplied.

You can now attach the wall mount, referring to the instructions supplied with it. The table at the bottom of the page contains the type of VESA wall mount to be ordered for each size of TV set.

LCD 32"	LCD 37" + 42"	LCD 46" Plasma 50"
600x400	600x200	800x400

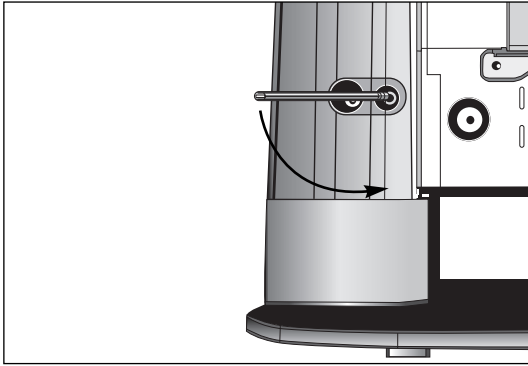
**I****ES**

Desmontaje del soporte de mesa para la fijación de un soporte mural (disponible opcionalmente).

Gire el televisor (pantalla hacia el suelo) y colóquelo sobre una superficie lisa y protegida.

1. Desatornille los dos tornillos de punta de 2 ó 3 vueltas como máximo, con ayuda de la llave proporcionada.
2. Despeje el soporte de mesa del televisor efectuando los movimientos indicados en las ilustraciones.
3. Colóquelo y atornille los dos embellecedores que se encuentran en la bolsa de la documentación con la ayuda de los tornillos que también se proporcionan.

Ahora puede instalar el soporte mural, siguiendo las instrucciones que acompañan al mismo. La tabla de la parte inferior de la página indica el tipo de soporte mural VESA que debe solicitar con relación a los diferentes tamaños de aparato.

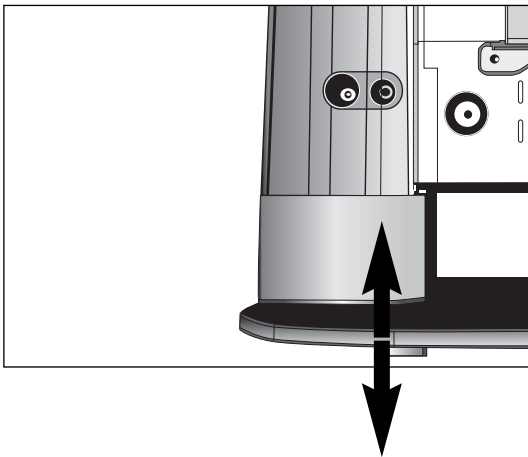
**2****PT**

Desmontagem do suporte de mesa para a fixação de um suporte de parede (disponível em opção).

Vire o televisor (ecrã voltado para o chão) e coloque-o sobre uma superfície plana e protegida.

1. Desenrosque, 2 a 3 voltas no máximo, os dois parafusos de imobilização, com a ajuda da chave fornecida.
2. Separe o suporte de mesa do televisor, efectuando os movimentos ilustrados.
3. Posicione e aparafuse as duas tampas que se encontram no saco com a documentação, com a ajuda dos parafusos também fornecidos.

Pode agora instalar o suporte de parede, de acordo com as instruções que o acompanham. O quadro no final da página indica, para cada tamanho de aparelho, o tipo de suporte de parede VESA a encomendar.

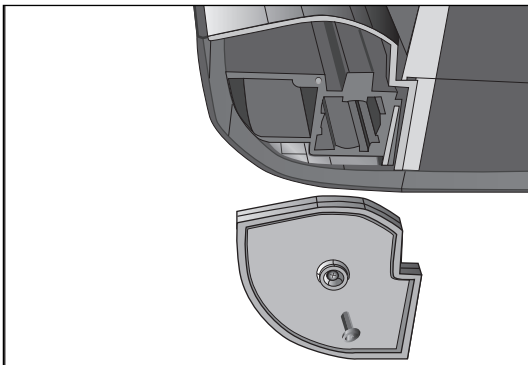
**3****NL**

Demontage van het tafelstatief voordat u de een muurbevestiging plaatst (apart verkrijgbaar).

Draai het televisietoestel om (scherm naar beneden) en plaats deze op een vlakke en beschermde ondergrond.

1. Schroef de beide ventielschroeven maximaal 2 tot 3 draaien los met de meegeleverde sleutel.
2. Verwijder het tafelstatief van het televisietoestel door middel van de in de afbeelding aangegeven bewegingen.
3. Breng op zijn plaats en schroef de beide sierdoppen uit het documentatiezakje vast met de eveneens meegeleverde schroeven.

U kunt nu de muurbevestiging monteren waarbij u de bijgevoegde aanwijzingen volgt. De tabel onder aan de pagina geeft voor elk toestelformaat het type VESA-muurstatief aan dat u moet bestellen.

**SV**

Nedmontering av bordsstativet inför montering av väggstativ (finns som tillbehör).

Lägg ner TV:n (med skärmen mot marken) på ett plant och skyddat underlag.

1. Lossa de två spetsiga skruvarna med max 2-3 varv med den medföljande nyckeln.
2. Lossa bordsstativet genom att föra TV:n i den riktning som visas på bilderna.
3. Sätt TV:n på plats och fixera de två skyddshattarna som levererades med dokumentationen med hjälp av de medföljande skruvarna.

Du kan du montera väggstativet genom att följa de anvisningar som levererades med det. Tabellen längst ner på sidan visar för varje storlek på apparat vilket VESA-stöd som ska beställas.

LCD 32"	LCD 37" + 42"	LCD 46" Plasma 50"
600x400	600x200	800x400



## VCR

AIWA	2053, 2061, 2062, 2065, 2072, 2074, 2089, 2094, 2095
AKAI	2021, 2022, 2033, 2034, 2049, 2050, 2054, 2068, 2074, 2090, 2095
AKURA	2074, 2081
ALBA	2009, 2026, 2042, 2048, 2051, 2054, 2059, 2060, 2062 2065, 2068, 2081, 2087, 2090, 2092, 2093, 2094, 2095
AMBASSADOR	2009, 2068
AMSTRAD	2048, 2057, 2058, 2065, 2081, 2087
ANITECH	2026, 2081
ANSONIC	2066
ASA	2012, 2028, 2072
AUDIOSONIC	2087
AUDIOTON	2068
BAIRD	2031, 2065, 2074, 2082, 2087
BLAUPUNKT	2002, 2004, 2008, 2035, 2039, 2044 2045, 2067, 2071, 2083, 2085
BRANDT	2037, 2055, 2074, 2091, 2098
BUSH	2026, 2042, 2048, 2051, 2059, 2060, 2062, 2065 2081, 2087, 2088, 2090, 2092, 2093, 2094, 2095
CARREFOUR	2077
CASIO	2065
CATHAY	2087
CGE	2065, 2074
CIMLINE	2026, 2081
CLATRONIC	2009, 2068, 2081
CONDOR	2009, 2068, 2087
CROWN	2009, 2026, 2048, 2068, 2081, 2087
CYRUS	2028
DAEWOO	2009, 2048, 2068, 2077, 2087, 2095
DANSAI	2026, 2081, 2087
DAYTRON	2087
DECCA	2028, 2065, 2074, 2080
DENON	2015
DUAL	2065, 2074, 2087
DUMONT	2028, 2031, 2032, 2065, 2082
ELBE	2013, 2073, 2087
ELCATECH	2026, 2081
ELIN	2086
ELTA	2081, 2087
EMERSON	2077, 2081
ESC	2047, 2048, 2068, 2086, 2087
EUROPHON	2068
FERGUSON	2029, 2055, 2065, 2074, 2091, 2098
FIDELITY	2065, 2081
FINLANDIA	2028, 2031, 2065, 2075, 2079, 2082
FINLUX	2015, 2028, 2031, 2032, 2065, 2075, 2082
FIRSTLINE	2012, 2016, 2017, 2026, 2042, 2072 2075, 2076, 2077, 2081, 2088, 2094
FISHER	2018, 2019, 2023, 2031, 2068, 2073, 2078, 2082
FRONTECH	2009, 2068
FUJITSU	2065
FUNAI	2065
GBC	2068
GEC	2028
GENEXXA	2082
GOLDHAND	2026, 2081
GOLDSTAR	2012, 2043, 2065, 2072
GOODMANS	2009, 2012, 2024, 2026, 2048, 2065, 2068 2072, 2081, 2086, 2087, 2088, 2094
GRAETZ	2031, 2047, 2074, 2082, 2086
GRANADA	2018, 2028, 2031, 2065, 2067, 2072, 2075, 2079, 2082, 2086
GRANDIN	2012, 2026, 2065, 2068, 2072, 2081, 2087
GRUNDIG	2002, 2004, 2005, 2008, 2026, 2028, 2039 2041, 2044, 2051, 2067, 2085, 2091
HANSEATIC	2012, 2072, 2087
HARWOOD	2081
HCM	2026, 2051, 2081
HINARI	2003, 2026, 2047, 2051, 2062, 2066, 2074, 2081, 2087, 2088, 2095

HISAWA	2095
HITACHI	2003, 2015, 2032, 2036, 2046, 2047 2065, 2066, 2074, 2075, 2082, 2086
IMPERIAL	2065, 2086
INGERSOL	2003, 2066, 2086
INNO HIT	2068, 2081, 2086, 2087
INTERBUY	2072, 2081
INTERFUNK	2028, 2082
INTERVISION	2065, 2072, 2087, 2094
IRRADIO	2072, 2081
ITT	2009, 2012, 2018, 2031, 2033, 2047, 2048, 2063, 2074, 2082, 2086
ITV	2068, 2072, 2087
JVC	2006, 2025, 2029, 2040, 2041, 2063, 2074, 2080
KAISUI	2026, 2081
KENDO	2033, 2042, 2061, 2072, 2081, 2090, 2094
KENWOOD	2074
KNEISSEL	2094, 2095
KUBA	2078
LENCO	2048
LG	2065, 2072
LOEWE	2003, 2004, 2012, 2028, 2035
LOEWE OPTA	2066, 2067, 2072, 2083, 2097
LOGIK	2003, 2047, 2066, 2081, 2086
LUMATRON	2087
LUXOR	2016, 2018, 2020, 2024, 2031, 2033 2076, 2078, 2079, 2081, 2082
M ELECTRONIC	2013, 2065, 2072
MARANTZ	2002, 2004, 2024, 2028, 2067, 2073
MATSUI	2003, 2011, 2030, 2038, 2042, 2061, 2062 2065, 2066, 2072, 2086, 2094, 2095
MEDION	2094
M-ELECTRONIC	2065, 2072, 2073
MEMOREX	2012, 2018, 2031, 2065, 2072, 2078, 2079, 2082
METZ	2002, 2004, 2012, 2035, 2039, 2045, 2067, 2083, 2085, 2097
MIGROS	2065
MINERVA	2004, 2008, 2039, 2085
MITSUBISHI	2016, 2025, 2027, 2028, 2076, 2080
MULTITECH	2026, 2065, 2068, 2081, 2082
MURPHY	2065
NATIONAL	2083
NEC	2013, 2014, 2025, 2073, 2074, 2080
NECKERMANN	2028, 2067, 2074
NESCO	2026, 2065, 2081, 2095
NIKKAI	2068, 2081, 2087
NOKIA	2018, 2031, 2033, 2047, 2074, 2075, 2079, 2082, 2086, 2087, 2090
NORDMENDE	2052, 2055, 2063, 2074, 2084, 2091, 2099
OCEANIC	2065, 2074, 2079, 2082
OKANO	2054, 2061, 2081, 2087, 2090, 2094
ORION	2003, 2011, 2030, 2042, 2059, 2060, 2061 2062, 2066, 2092, 2093, 2094, 2095
ORSON	2065
OSAKI	2012, 2026, 2065, 2072, 2081
OSUME	2088
OTAKE	2092, 2093
OTTO VERSAND	2028
PALLADIUM	2004, 2012, 2026, 2066, 2067, 2072, 2074, 2081, 2086, 2090
PANASONIC	2035, 2044, 2045, 2083, 2097
PATHE CINEMA	2011, 2066, 2076
PATHE MARCONI	2074
PENTAX	2015, 2032
PERDIO	2065
PHILCO	2013, 2073, 2081
PHILIPS	2028, 2063, 2067
PHONOLA	2028
PIONEER	2025, 2028, 2046, 2075, 2080
PORTLAND	2009, 2068, 2087
PRINZ	2065



## DVD

PROFEX	2056
PROFI-TRONIC	2086
PROLINE	2051, 2065, 2088
PYE	2028
QUELLE	2028, 2067
RADIOLA	2028
REX	2063, 2074
RFT	2068, 2081
ROADSTAR	2012, 2026, 2047, 2048, 2072, 2081, 2086, 2087
SABA	2040, 2041, 2052, 2055, 2063, 2074, 2091
SAISHO	2003, 2011, 2030, 2038, 2042, 2066, 2094
SALORA	2016, 2018, 2033, 2076, 2082
SAMSUNG	2047, 2064, 2086, 2096
SANSUI	2025
SANWA	2066
SANYO	2018, 2031, 2078, 2079, 2082
SBR	2028
SCHAUB LORENZ	2031, 2065, 2074, 2082
SCHNEIDER	2026, 2028, 2065, 2072, 2081, 2086, 2087
SEG	2047, 2056, 2081, 2086, 2087
SEI	2003, 2028
SEI-SINUDYNE	2066
SELECO	2068, 2072, 2074
SENTRA	2009, 2068, 2081, 2088
SHARP	2020, 2024, 2079
SHINTOM	2026, 2031, 2081, 2082
SHIVAKI	2072
SHORAI	2003, 2066
SIEMENS	2002, 2004, 2008, 2012, 2023, 2028 2031, 2039, 2067, 2072, 2082, 2085
SINGER	2017
SINUDYNE	2003, 2028, 2066
SOLAVOX	2009
SONITRON	2078
SONOKO	2087
SONOLOR	2018, 2024, 2079
SONTEC	2012, 2072
SONY	2007, 2010, 2069, 2070, 2071
STARLITE	2072, 2082
STERN	2087
SUNKAI	2061, 2094
SUNSTAR	2065
SUNTRONIC	2065
SUPRA	2072, 2086
SYMPHONIC	2065, 2081
TANDBERG	2087
TASHIKO	2065, 2072, 2079, 2086
TATUNG	2028, 2065, 2074, 2076, 2079
TEAC	2065, 2074, 2087
TEC	2009, 2068, 2081, 2087
TECHNICS	2035, 2044
TELEAVIA	2074
TELEFUNKEN	2037, 2055, 2063, 2074, 2091, 2098, 2100
TELETECH	2081, 2087
TENSAI	2056, 2065, 2066, 2072, 2081
THOMSON	2000, 2001, 2063, 2074, 2091, 2098, 2099
THORN	2011, 2029, 2031, 2072, 2074, 2082
TOSHIBA	2016, 2017, 2028, 2063, 2074, 2076, 2077
TOWADA	2056, 2081
UHER	2047, 2072, 2086
ULTRAVOX	2021, 2087
UNITECH	2086
UNIVERSUM	2004, 2008, 2012, 2021, 2028, 2033, 2039, 2047 2057, 2065, 2067, 2072, 2085, 2086, 2094
YOKO	2009, 2047, 2068, 2072, 2081, 2086

AKAI	3006
DENON	3002, 3009
JVC	3016
KENWOOD	3002, 3005, 3014
MAGNAVOX	3010
MICROMEGA	3021
mitsubishi	3011
ONKYO	3010
OPTIMUS	3020
PANASONIC	3002, 3009
PHILIPS	3010, 3018, 3021
PIONEER	3020, 3022
SAMSUNG	3017
SONY	3004, 3013
TECHNICS	3009
THOMSON	3000, 3012, 3015, 3019
TOSHIBA	3003, 3010
XBOX	3012
YAMAHA	3009
ZENITH	3010

## Réseau câblé, Kabelnetz, rete via cavo, cable network, red por cable

ALCATEL	5025, 5026
BT CABLE	5004
CABLETIME	5007, 5010, 5014, 5019, 5021, 5023
FILMNET CABLECRYPT	5022
FRANCE TELECOM	5024, 5027, 5029
GENERAL INSTRUMENT	5020
GRUNDIG	5013
JERROLD	5002, 5008, 5017, 5020
MACAB	5024
M-NET	5022
NOKIA	5015
PHILIPS	5024, 5028, 5029
PIONEER	5005
SAGEM	5016, 5024
SALORA	5011
SCIENTIFIC ATLANTA	5003, 5009
TELE+I	5012, 5022
TELEPIU	5022
UNITED CABLE	5002, 5017
VIDEOWAY	5006, 5018
VISIOPASS	5024, 5029
WESTMINISTER CABLE	5004

**Récepteur satellite, Satellitenempfänger,  
ricevitore satellite, satellite receiver,  
receptor satélite**

AB SAT	5079
AKAI	5091
ALBA	5032, 5063, 5093
ALLSAT	5037, 5043, 5091
ALLTECH	5066
ALPHA	5091
ALTAI	5052
AMPERE	5052
AMSTRAD	5035, 5046, 5052, 5067, 5069, 5073, 5080, 5092
ANKARO	5044, 5047, 5094
ANTTRON	5032, 5043, 5063
APOLLO	5032
ARCON	5071
ARMSTRONG	5091
ASA	5053
ASAT	5091
AST	5048
ASTRA	5033, 5050, 5057
ASTRO	5041, 5063, 5094, 5095
AUDIOTON	5063
BEST	5094
BLAUPUNKT	5041
BRAIN WAVE	5049, 5071
BSKYB	5080
BT SATELLITE	5072
BUSH	5037, 5043, 5093
CAMBRIDGE	5031, 5068
CANAL SATELLITE	5088, 5096
CHANNEL MASTER	5093
CITYCOM	5077
CLATRONIC	5049
COMTEC	5047, 5051
CONDOR	5033, 5094
CONRAD	5033, 5060, 5061, 5094
CONTEC	5051, 5061
DAEWOO	5032
DANSAT	5037, 5043
D-BOX	5083
DNR	5071
DNT	5052, 5091
ECHOSTAR	5052, 5082, 5088, 5096
EINHELL	5032, 5046, 5047
ELSAT	5069
ELTA	5032, 5091, 5094
EMME ESSE	5082, 5094
EUROPA	5044, 5061, 5091
EUROSKY	5030, 5033, 5094
EUROSTAR	5033, 5084
FERGUSON	5037, 5043, 5064
FIDELITY	5046, 5067
FINLUX	5031, 5055, 5060
FRACARRO	5032, 5082
FREESAT	5066
FTE	5061, 5068, 5094
FUBA	5032, 5052, 5094
GALAXIS	5047, 5051, 5057, 5081, 5094
GRANDIN	5038
GRUNDIG	5035, 5040, 5041, 5074, 5076, 5080, 5092
G-SAT	5043
HANSEATIC	5062
HINARI	5032, 5043, 5093
HIRSCHMANN	5030, 5041, 5052, 5053, 5054, 5056, 5060
HISAWA	5049
HUTH	5033, 5044, 5047, 5049, 5050, 5051, 5061
INTERVISION	5033, 5065
ITT/NOKIA	5053, 5060, 5083
JOHANSSON	5049

KATHREIN	5041, 5056, 5063, 5077, 5086, 5091, 5095
KOLON	5032
KOSMOS	5056
KR	5063, 5066
KREISELMEYER	5041
KYOSTAR	5032, 5063
LASAT	5033, 5051, 5068, 5094
LEMON	5071
LENCO	5032, 5044, 5057, 5071, 5094
LEXUS	5091
LORENZEN	5033, 5044, 5071, 5073
LUXOR	5060, 5083, 5092
MANATA	5072
MANHATTAN	5072
MASCOM	5056
MASPRO	5039, 5041, 5066, 5071, 5074
MATSUI	5031, 5041, 5072, 5093
MEDIABOX	5096
MEDIASAT	5057, 5088, 5096
MEDION	5094
METRONIC	5032, 5038, 5047, 5063, 5077
METZ	5041
MICRO TECHNOLOGY	5057
MORGAN'S	5061, 5068, 5091
NEC	5042
NETWORK	5043
NEUHAUS	5033, 5044, 5057, 5061, 5071
NEUSAT	5071
NOKIA	5053, 5060, 5083
NORDMENDE	5032, 5049, 5064, 5093
NOVIS	5049
OCTAGON	5032, 5044, 5051, 5063
ONDIGITAL	5045, 5089, 5090
ORBITECH	5032, 5058, 5059, 5061
PACE	5035, 5037, 5043, 5045, 5075, 5080
PALCOM	5093
PALLADIUM	5032
PANASONIC	5035, 5080
PANDA	5033, 5037
PHILIPS	5041, 5043, 5044, 5061, 5063, 5072, 5074, 5076 5077, 5086, 5088, 5089, 5090, 5091, 5096
PHOENIX	5043, 5051
PHONOTREND	5047, 5081
PIONEER	5087, 5088, 5096
PREDKI	5032, 5049
PREMIERE	5096
PROSAT	5047, 5065, 5093
QUADRAL	5047, 5061, 5065, 5072, 5093, 5094
QUELLE	5033, 5046
RADIOLA	5091
RADIX	5052, 5066, 5085
REDPOINT	5057
RFT	5044, 5047, 5058, 5091
ROVER	5065
SABA	5033, 5043, 5064, 5070, 5071, 5072
SAGEM	5034, 5078
SAKURA	5051
SAMSUNG	5030, 5032
SATCOM	5033, 5050, 5062
SATELCO	5094
SATFORD	5050
SATLINE	5065
SATPARTNER	5032, 5049
SCHNEIDER	5076
SEDEA ELECTRONIQUE	5032
SEEMANN	5057, 5094
SEG	5032, 5049, 5062, 5073, 5094

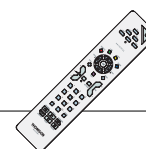

SELECO	5082
SIEMENS	5041, 5068
SKARDIN	5057
SKYMASTER	5047, 5062, 5065, 5084
SL	5071
SONY	5031, 5035
STRONG	5032, 5094
SUNNY SOUND	5094
SUNSTAR	5094
TECHNILAND	5050
TECHNISAT	5036, 5058, 5059, 5091
TELASAT	5062
TELECIEL	5063
TELEFUNKEN	5032, 5072
TELEKA	5052, 5056, 5063, 5071, 5074
TELESAT	5062
TELETECH	5084
THOMSON	5000, 5033, 5064, 5088
TONNA	5050
TRIAD	5048
TRIASAT	5055
TRIAX	5055
UNIDEN	5067
UNISAT	5051, 5091
UNIVERSUM	5033, 5041, 5053, 5067, 5073
VARIOSAT	5041
VESTEL	5073
VISIOSAT	5070
VIVA	5044
VORTEC	5030, 5032, 5045
WELA	5061
WINERSAT	5049
WISI	5041, 5048, 5052, 5061, 5070
WORLD	5049
ZAUNKONIG	5071
ZEHNDER	5048, 5073, 5077, 5094

GOODMANS	4046, 4050, 4051, 4069, 4095, 4097
GRUNDIG	4031, 4033, 4035, 4036, 4068
HARMAN KARDON	4024, 4031
HARWOOD	4051
HCM	4097
HITACHI	4080
INTERSOUND	4051
JVC	4022, 4047
KENWOOD	4019, 4030, 4034, 4039, 4040, 4056, 4071, 4093, 4098
KODAK	4078
LG	4035
LINN	4068
M ELECTRONIC	4094
MARANTZ	4031, 4033, 4061, 4065, 4068
MATSUI	4051, 4068, 4079, 4082, 4095
MEMOREX	4018
MERIDIAN	4068
MICROMEGA	4031, 4068
MITSUBISHI	4046, 4062, 4067
NAD	4041, 4054
NAIM	4068
NIKKO	4069
OKANO	4046
ONKYO	4027
PANASONIC	4012, 4020, 4038, 4049, 4052, 4081, 4085
PHILIPS	4031, 4068, 4077, 4078
PIONEER	4008, 4018, 4023, 4030, 4037, 4057, 4088
QUAD	4068
QUASAR	4020
RADIOTONE	4096, 4097
REVOX	4030, 4031, 4068
ROADSTAR	4087, 4094
ROADSTER	4016
ROTEL	4068
SAISHO	4042
SAMSUNG	4036
SANSUI	4031, 4042, 4050, 4074, 4091, 4097
SANYO	4021, 4033, 4043, 4070, 4084
SCHNEIDER	4066, 4096
SHARP	4030, 4060, 4076
SHERWOOD	4048, 4063, 4072
SIEMENS	4050, 4092
SONY	4028, 4045, 4054, 4090
SUPERTECH	4097
TEAC	4024, 4050, 4069
TECHNICS	4012, 4020, 4032, 4038, 4049, 4052, 4075, 4081
TELEFUNKEN	4053
THOMSON	4003, 4007
THORENS	4031, 4068
THORN	4051
TOSHIBA	4089, 4098
UHER	4042
UNIVERSUM	4035, 4036, 4046, 4050, 4051, 4068
WATSON	4096
YAMAHA	4009, 4013, 4029, 4030, 4059

**Sistèmes audio, Audiosysteme,  
sistemi audio, audio systems,  
sistemas audio**

AIWA	4014, 4026, 4028, 4044, 4062, 4064, 4067, 4073, 4086
AKAI	4025, 4046, 4050
ALBA	4069, 4079, 4083, 4096
ARCAM	4068
AUDIO RESEARCH	4068
AUDIOTON	4068
BRANDT	4053
BUSH	4015, 4096
CARVER	4021, 4043
CLATRONIC	4051
CONDOR	4066
CYRUS	4068
DENON	4010, 4011, 4017, 4055, 4058
DUAL	4072
ECLIPSE	4097
ELTA	4051
FISHER	4021, 4043, 4070, 4084
GENEXXA	4030
GOLDSTAR	4035, 4094, 4095





IFC230  
TV LCD - PLASMA

**Modèle et numéro de série**  
Modell und Seriennummer  
**Modello e numero di serie**  
Model and serial number  
**Modelo y número de serie**  
Modelo e número de série  
**Model en serienummer**  
Modell och serienummer

**THOMSON Sales Europe**  
46, quai A. Le Gallo  
92648 Boulogne Cedex  
FRANCE  
322 019 464 RCS NANTERRE  
<http://www.thomson-europe.com>

---

CE  25830600 © Copyright TTE Europe SAS 2006

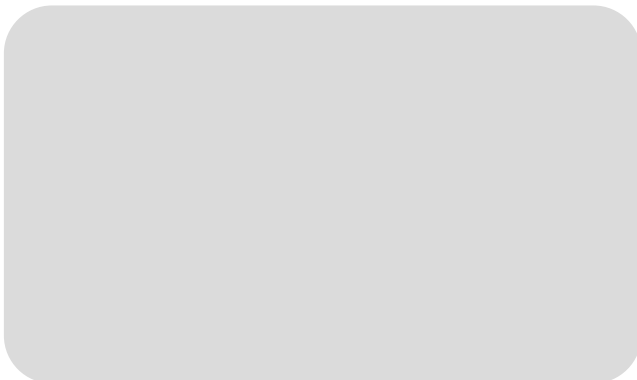
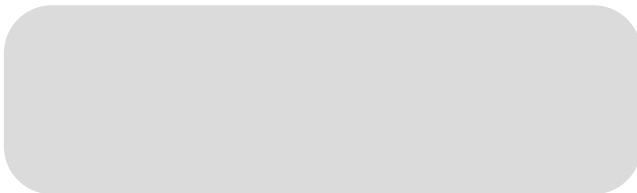

**Adresse du détaillant**  
Adresse des Fachhändlers  
**Indirizzo del rivenditore**  
Dealer's address  
**Dirección del distribuidor**  
Morada do negociante  
**Adres van de verkoper**  
Återförsäljarens adress