

Foreword

- Caution 3
- Important Safety Information 5

Overviewing the Monitor

- Viewing the Control Panel 9
- Viewing the Connecting Panel 10
- Viewing the Remote Control
 - Button Description 12
 - PIP (Picture in Picture) Buttons 13
 - Loading the Batteries..... 15

Installation

- Table Stand Installation 16
- Speaker Installation 17

Connecting the Cable/Devices

- Connecting the TV Cable 18
- Connecting the VCR 19
- Connecting the DVD 20
- Connecting the Set Top Box 21
- Connecting the PC [D-Sub & DVI] 22
 - Displayable Monitor Specification..... 23

Setting the Channel

- Basic Operation..... 24
- OSD Menu Structure 25
- Choosing the Channel Type..... 26
- Storing the Channel Automatically 26
- Fine Tuning the Channel Reception 27
- Setting the Favorite Channel 28

Setting the Picture

- Changing the Picture Mode 29
 - Adjust User Mode 30
- Changing the Color Temperature 32
- Video NR (Noise Reduction) 32
- Selecting the Film Mode..... 33
- Changing the Screen Form 33

- Setting the Black Enhancer 34
- Adjusting the PC Screen (Geometry) 35
 - Native Mode 36

Setting the Sound

- Adjusting the Sound Balance 37
- Changing the Sound Mode 37
- Adjusting the User Sound Mode 38
- Spatial Effect 38
- AVC (Auto Volume Control) 38
- MTS (Multichannel Television Sound) 39

Setting the Others

- Adjusting the Transparency of the OSD Window 40
- PIP (Picture in Picture) 40
 - Changing the Size in PIP 40
 - Choosing the Source in PIP 41
 - Picture Swap in PIP 41
 - Changing the Position in PIP 42
- Other Advanced Function 42
 - Set ID 43
 - Setting the Blue Screen Mode 43
 - Changing the OSD Language 43
 - Front Key Lock in Advance 43
- V-chip (TV Parental Guidelines) 44
 - TV Blocking in V-Chip 43
 - Movie Blocking in V-Chip 43
 - Change Password in V-Chip 43
 - V-Chip Blocking in V-Chip 43

Setting the Time

- Setting the Current Time 47
- Setting the On Time 47
- Setting the On Channel 48
- Setting the On Volume 48
- Setting the Off Time 49
- Setting the Sleep Timer 49

- Troubleshooting** 50

- Warranty Card** 51



CAUTION

RISK OF ELECTRIC SHOCK
DO NOT OPEN



CAUTION : TO REDUCE THE RISK OF ELECTRIC SHOCK, DO NOT REMOVE COVER (OR BACK), NO USER-SERVICEABLE PARTS INSIDE. REFER SERVICING TO QUALIFIED SERVICE PERSONNEL.

CAUTION

- TO PREVENT DAMAGE WHICH MAY RESULT IN FIRE OR SHOCK HAZARD.
- DO NOT EXPOSE THIS APPLIANCE TO RAIN OR MOISTURE.
- SHOCK HAZARD DO NOT OPEN.

CAUTION

These servicing instructions are for use by qualified service personnel only. To reduce the risk of electric shock, do not perform any servicing other than that contained in the operating instructions unless you are qualified to do so.

CAUTION

The stand is intended for use with this monitor only. Use with other products may result in injury.

- 

This symbol is intended to alert the user to the presence of uninsulated "dangerous voltage" within the product's enclosure that may be of sufficient magnitude to constitute a risk of electric shock to persons.
- 

This symbol is intended to alert the user to the presence of important operating and maintenance(servicing) instructions in the literature accompanying the appliance.

WARNING

- Apparatus shall not be exposed to dripping or splashing and no objects filled with liquids, such as vases, shall be placed on the apparatus.
- This is Class B product. In a domestic environment this product may cause radio interference in which case the user may be required to take adequate measures.
- To reduce the risk of fire and electric shock, do not expose this product to rain or moisture.

FCC NOTICE

This device has been tested and found to comply with the limits for a Class B device, pursuant to Part 15 of the FCC Rules. These limits are designed to provide reasonable protection against harmful interference in home environment as well as in a commercial, industrial or business environment. This equipment can generate, use and radiate radio frequency energy and, if not installed and used in accordance with the instruction, may cause harmful interference to radio communications. However, there is no guarantee that interference will not occur in a particular installation. If this equipment does cause harmful interference to radio or television reception, which can be determined by turning the equipment off and on, the user is encouraged to try to correct the interference by one or more of the following measures :

- Reorient or relocate the receiving antenna.
- Increase the separation between the equipment and receiver.
- Connect the equipment into an outlet on a circuit different from that to which the receiver is connected.
- Consult the dealer or an experienced radio/TV technician for help.

Changes or modification not expressly approved by the party responsible for compliance could void the user's authority to operate the equipment.
Connecting of peripherals requires the use of grounded shielded signal cables.

➤ **Always be careful when using your the monitor. To reduce the risk of fire, electrical shock, and other injuries, keep these safety precautions in mind when installing, using, and maintaining your machine.**



Read all safety and operating instructions before operating your the monitor.

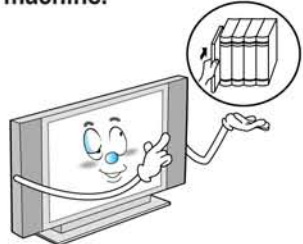

Keep the safety and operating instructions for future reference.



Heed all warnings on the monitor and in the operating instructions.

Caution

Always be careful when using your the monitor. To reduce the risk of fire, electrical shock, and other injuries, keep these safety precautions in mind when installing, using, and maintaining your machine.

1. Read these instructions.
2. Keep these instructions.
3. Heed all warnings.
4. Follow all instructions.
5. Do not use this apparatus near water.
6. Clean only with a damp cloth.
7. Do not block any of the ventilation openings. Install in accordance with the manufacturer's instructions.
8. Do not install near any heat sources such as radiators, heat registers, stoves, or other apparatus (including amplifiers) that produce heat.
9. Do not defeat the safety purpose of the polarized or grounding type plug. A polarized plug has two blades with one wider than the other. A grounding type plug has two blades and a third grounding prong. The wide blade or the third prong is provided for your safety. When the provided plug does not fit into your outlet, consult an electrician for replacement of the obsolete outlet.
10. Protect the power cord from being walked on or pinched particularly at plugs, convenience receptacles, and the point where they exit from the apparatus.
11. Only use the attachments/accessories specified by the manufacturer.
12. Use only with a cart, stand, tripod, bracket, or table specified by the manufacturer, or sold with the apparatus. When a cart is used, use caution when moving the cart/apparatus combination to avoid injury from tip-over.



13. Unplug this apparatus during lightning storms or when unused for long periods of time.
14. Refer all servicing to qualified service personnel. Servicing is required when the apparatus has been damaged in any way, such as power supply cord or plug is damaged, liquid has been spilled or objects have fallen into the apparatus, the apparatus has been exposed to rain or moisture, does not operate normally, or has been dropped.



Follow all operating and use instructions.

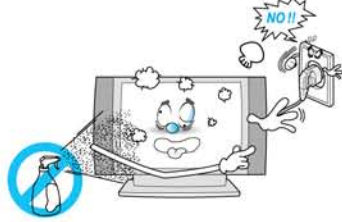

Unplug the monitor from the wall outlet before cleaning. Use a damp cloth; do not use liquid or aerosol cleaners.



Never add any attachments and/or equipment without approval of the manufacturer. Such additions can increase the risk of fire, electric shock, or other personal injury.



Do not use the monitor where contact with or immersion in water is a possibility, such as near bath tubs, sinks, washing machines, swimming pools, etc.

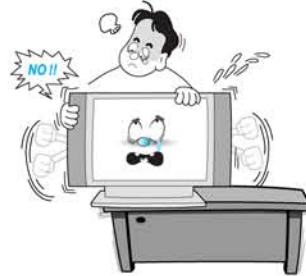

When installing the monitor on a table, be careful not to place it too close to the edge of the table.
- This may cause the monitor to fall, causing serious injury to a child or adult, and serious damage to the monitor.

Important Safety Information

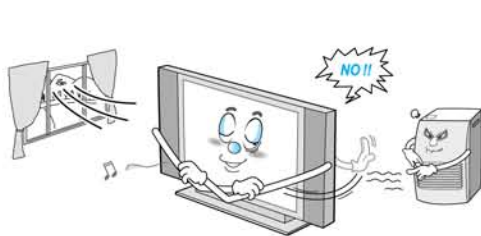

Provide ventilation for the monitor. The unit is designed with slots in the cabinet for ventilation to protect it from overheating. Do not block these openings with any object, and do not place the monitor on a bed, sofa, rug or other similar surface. Do not place it near a radiator or heat register. If you place the monitor on a rack or bookcase, ensure that there is adequate ventilation and that you've followed the manufacturer's instructions for mounting.



Use only the accessory cord designed for this product to prevent shock. The power supply voltage rating of this product is AC100-240V, the power cord attached conforms to the following power supply voltage. Use only the power cord designated by our dealer to ensure Safety and EMC. When it is used by other power supply voltage, power cable must be changed. Consult your product dealer.

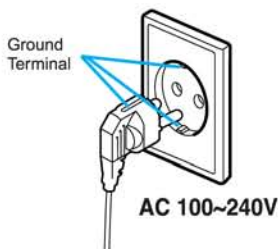

Use only a grounded or polarized outlet. For your safety, this Monitor is equipped with a polarized alternating current line plug having one blade wider than the other. This plug will fit into the power outlet only one way. If you are unable to insert the plug fully into the outlet, try reversing the plug. If the plug still does not fit, contact your electrician to replace your outlet.



Avoid overhead power lines. An outside antenna system should not be placed in the vicinity of overhead power lines or other electric light or power circuits or where it can fall into such power lines or circuits. When installing an outside antenna system, be extremely careful to keep from touching the power lines or circuits. Contact with such lines can be fatal.

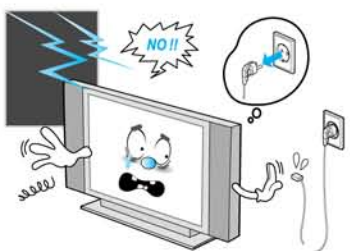

Unplug the monitor from the wall outlet and disconnect the antenna or cable system during a lightning storm or when left unattended and unused for long periods of time. This will prevent damage to the unit due to lightning and power-line surges.

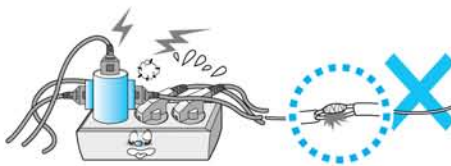

Protect the power cord. Power supply cords should be routed so that they won't be walked on or pinched by objects placed on or against them. Pay particular attention to cords at plugs, convenience receptacles, and the point where they exit from the unit.



Do not overload the wall outlet or extension cords. Overloading can result in fire or electric shock.



Do not insert anything through the openings in the unit, where they can touch dangerous voltage points or damage parts. Never spill liquid of any kind on the monitor.



Bend antenna cable between inside and outside building to prevent rain from flowing in.

- This may cause water damaged inside the monitor and could give an electric shock.

Ground outdoor antennas. If an outside antenna or cable system is connected to the monitor, be sure the antenna or cable system is grounded so as to provide some protection against voltage surges and built-up static charges. Section 810 of the National Electrical Code, ANSI/NFPA No.70-1984, provides information about proper grounding of the mast and supporting structure, grounding of the lead-in wire to an antenna discharge unit, size of grounding conductors, location of antenna discharge unit, connection to grounding electrodes, and requirements for the grounding electrode.

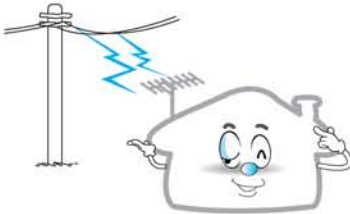

Do not place an outside antenna in the vicinity of overhead power lines or other electric light or power circuits.

- This may cause an electric shock.

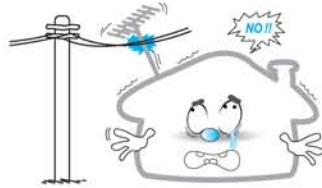

There should be enough distance between an outside antenna and power lines to keep the former from touching the latter even when the antenna falls.

- This may cause an electric shock.

Do not attempt to service the monitor yourself. Refer all servicing to qualified service personnel. Unplug the unit from the wall outlet and refer servicing to qualified service personnel under the following conditions:

- when the power-supply cord or plug is damaged
- if liquid has been spilled on the unit or if objects have fallen into the unit
- if the monitor has been exposed to rain or water
- if the monitor does not operate normally by following the operating instructions
- if the monitor has been dropped or the cabinet has been damaged
- when the monitor exhibits a distinct change in performance

Important Safety Information



When replacement parts are required, be sure the service technician uses replacement parts specified by the manufacturer or those that have the same characteristics as the original part. Unauthorized substitutions may result in additional damage to the unit.



Upon completion of any service or repairs to this the monitor, ask the service technician to perform safety checks to determine that the monitor is in a safe operating condition.



If you make adjustments yourself, adjust only those controls that are covered by the operating instructions. Adjusting other controls may result in damage and will often require extensive work by a qualified technician to restore the monitor to normal.

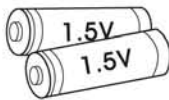

Only use the specified batteries.

- This may cause damage to the monitor or could give an electric shock.



Do not place anything containing liquid on top of the monitor.

- This may cause a fire or could give an electric shock.

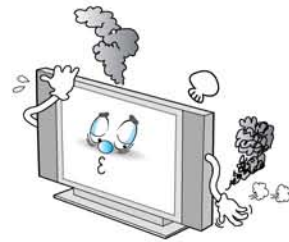

In case of smoke or strange smell from the monitor, switch it off, unplug it from the wall outlet and contact your dealer or service center.

- This may cause a fire or could give an electric shock.



The viewing distance should be about 5~7 times as long as diagonal length of the screen.

- If not, eyes will strain.



When moving the monitor assembled with speakers do not carry holding the speakers.

- This may cause the monitor to fall, causing serious injury to a child or adult, and serious damage to the monitor.

OSD Button Position

Front Panel

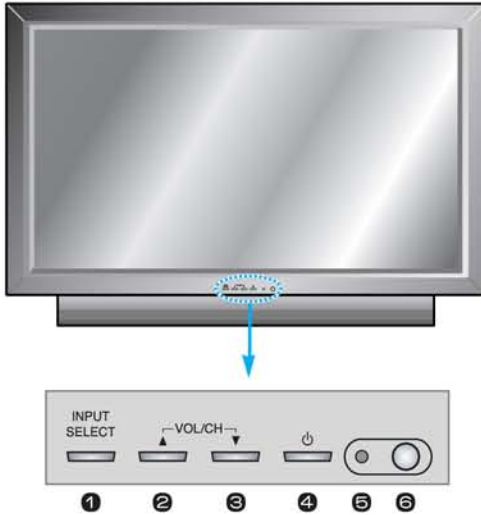

OSD Button & Function

- ➊ Input Source Select
- ➋ Up (See the box below)
- ➌ Down (See the box below)
- ➍ Power (Standby)
- ➎ Remote Sensor
- ➏ Status/Power Indicator LED

OSD Button Function

➊ INPUT SELECT

Select the signal source from multiple input sources such as TV, AV 1, AV 2, S-Video/AV 3, Component 1, Component 2, PC and DVI.

➋ VOL/CH▲/▼

To change the CHANNEL, press ▲ button first and change the channel with ▲, ▼ buttons.

To change the VOLUME, press ▼ button first and change the volume with ▲, ▼ buttons.

➍ Power On/Off

Turn the monitor on and off.

Accessories



Remote Control Handset



Power Cord



RF Cable

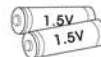

Alkaline Batteries



Owner's Manual

Viewing the Connecting Panel

Back Panel and Jacks

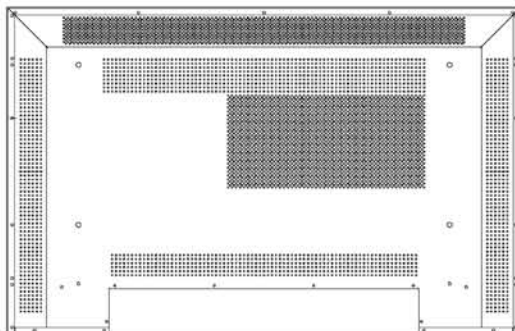

< Back panel of the monitor >

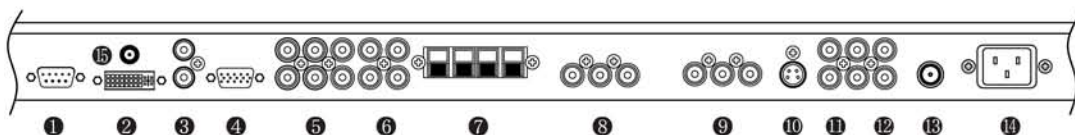
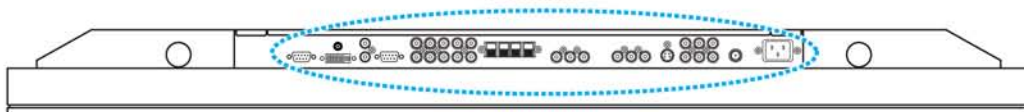

1	RS-232C	To Control from PC
2	DVI	For PC, Set Top Box
3	D-Sub(PC), DVI Sound	PC/DVI Audio Input
4	D-Sub (PC)	For PC, Set Top Box
5	Component 1, 2	For DVD, Set Top Box
6	Component Sound	For Component Audio Input
7	Speakers	To Connect Speakers (2CH, Stereo)
8	AV 1	For VCR, DVD, Set Top Box
9	AV 2	For VCR, DVD, Set Top Box
10	S-Video	For DVD, Set Top Box, S-VHS
11	AV Output	To Connect other TV or Monitor
12	AV 3	For VCR, DVD, Set Top Box
13	TV Antenna	For TV Antenna Cable (Air)
14	AC Power	
15	DC 5V Output	

• Refer to the next page for port descriptions.

- ❶ **RS-232C Jack**
Connects a control signal from a PC.
- ❷ **DVI Input Jack**
Connects a digital video signal from a DVI output jack of PC or set top box.
- ❸ **D-Sub(PC), DVI Sound**
Connects a sound signal from PC or DVI.
- ❹ **RGB PC Input Jack (D-Sub)**
Connects a video signal from a video output jack of PC.
Cables connecting the PC vary according to the type of machine, so contact your product dealer.
- ❺ **Component Input Jack 1, 2**
Connects a three separate component video signal from a component output jack of a DVD player or set top box.
Supports 480i/p(60Hz), 576i/p(50Hz), 720p(50/60Hz), 1080i(50/60Hz) signals. (i: interlace, p: progressive)
- ❻ **Component Sound**
Connects a sound signal from component.
- ❼ **Speaker Jack**
Connects external speakers by wires. Match red/red and black/black of speaker/TV.
- ❽ ❸ **Composite (RCA) Input Jack 1, 2**
Connects an AV composite video signal from a composite output terminal of a VCR or DVD player.
- ❿ **S-Video Input Jack**
Connects a S-Video video signals from a S-Video output jack of a S-VHS, VCR or DVD player.
- ⓫ **(Upper). Composite (RCA) Output Jack**
Output the signal of the current screen of the monitor. Connects to other TV or monitor.
- ⓬ **(Lower). Composite (RCA) Input Jack 3**
Connects an AV composite video signal from a composite output terminal of a VCR or DVD player.
Unavailable when a S-Video cable is put into the S-Video input jack.
- ⓭ **ANT. IN (TV Antenna Jack)**
Connects to an TV antenna cable.
- ⓮ **AC(Power) Input Terminal**
Firmly insert the accessory power cord as far as it will go into the power input terminal.
Firmly push the power cord plug as far as it will go into the power socket.

Connectors	
Audio Input	RCA Pin Jack
Composite Video Input	RCA Pin Jack
Composite Video Output	RCA Pin Jack
S-Video Input	Mini Din 4 Pin
Component Video Input	RCA Pin Jack
Analog RGB Input	Mini D-Sub 15 Pin
Digital Video Input	DVI-D 24 Pin

- Cables connecting the PC vary according to the type of machine, so consult your product dealer.

RS-232C Configurations

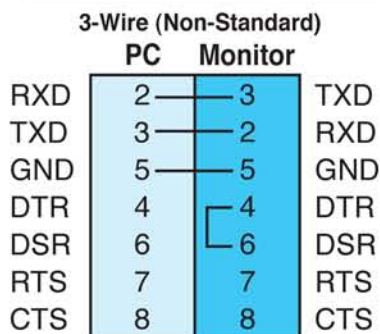

Viewing the Remote Control

▶ Button Description

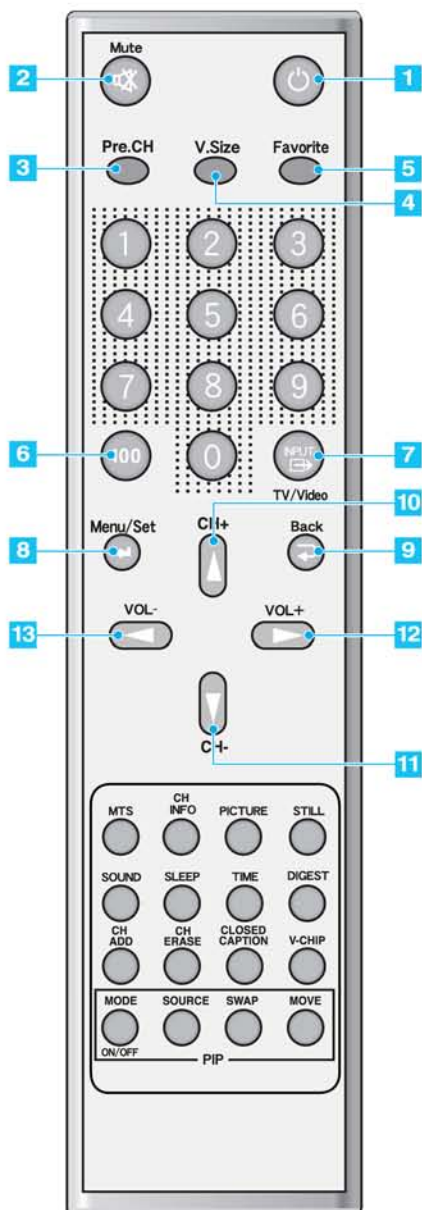

- 1 Power**
Turn the monitor on and off.
- 2 Mute**
Temporarily cut the sound and restore it.
- 3 Pre.CH**
Turn to the previous channel or exit OSD.
- 4 V.Size**
Choose the screen form.
16:9 → Panorama → Zoom1 → Zoom2 → 4:3
- 5 Favorite**
Tune to your next favorite channel.
- 6 100**
Press to tune the channels over 100.
- 7 INPUT**
Display the input source list.
- 8 Menu/Set**
Display the main OSD menu.
Activate your choice in the OSD menu.
- 9 Back**
Return to the previous OSD menu.
- 10 CH+**
Move to the upper channel.
- 11 CH-**
Move to the lower channel.
- 12 VOL+**
Increase the volume level.
- 13 VOL-**
Decrease the volume level.

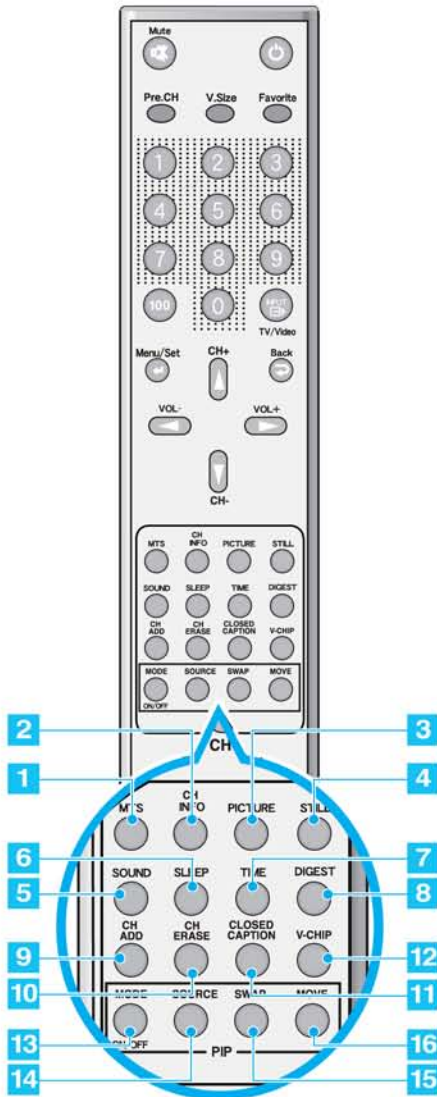

▶ **PIP (Picture in Picture) Buttons**

- 13 MODE (ON/OFF)**
Activate PIP function and change the PIP window size and PIP mode.
Small → Large → Twin (Half) → OFF
- 14 SOURCE**
Change the PIP window source.
- 15 SWAP**
Swap the main screen and the PIP window.
- 16 MOVE**
Move the position of the PIP window.

- 1 MTS**
Choose the MTS (Stereo) mode. Each time it is pressed, different mode is selected.
Mono → Stereo → SAP
• You can select only available modes depending on the source.
- 2 CH INFO**
Display the current information about time, screen form, source and MTS mode.
- 3 PICTURE**
There are 4 picture modes.
Standard → Vivid → Mild → User
- 4 STILL**
Temporarily freeze the screen and restore it.
- 5 SOUND**
Choose the sound equalizer settings.
Standard → Movie → Music → News → User
- 6 SLEEP**
Set the preset time interval for automatic turn-off.
OFF → 10 → 20 → 30 → 60 → 90 → 120 → 150 → 180
- 7 TIME**
Display the current time on the screen.
- 8 DIGEST**
Display 15 TV programs at the same time.
- 9 CH ADD**
Add the current channel to memory.
- 10 CH ERASE**
Erase the current channel from memory.
- 11 CLOSED CAPTION**
Set the close caption.
OFF → Closed Caption1 → Closed Caption2 → Text1 → Text2
- 12 V-CHIP**
Get into V-Chip menu.

Viewing the Remote Control

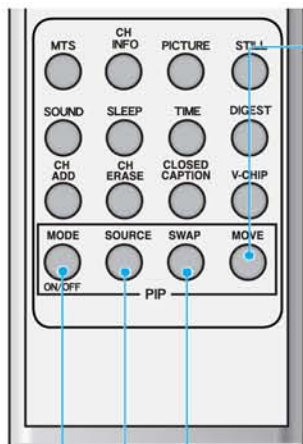

MOVE button : Move the position of PIP window.



SWAP button : Swap the sources of the main screen and PIP window.



MODE button : Change the PIP window mode.
OFF → Small → Large → Twin



SOURCE button : Change the source of the PIP window. The available sources are shown as below.

PIP \ Main	TV	AV 1	AV 2	S-Video/AV 3	Component 1	Component 2	PC	DVI
TV	✓	✓	✓	✓	✓	✓	✓	✓
AV 1	✓	-	✓	✓	✓	✓	✓	✓
AV 2	✓	✓	-	✓	✓	✓	✓	✓
S-Video/AV 3	✓	✓	✓	-	✓	✓	✓	✓
Component 1	✓	✓	✓	✓	-	-	-	-
Component 2	✓	✓	✓	✓	-	-	-	-
PC	✓	✓	✓	✓	-	-	-	-
DVI	✓	✓	✓	✓	-	-	-	-

Loading the Batteries

- 1 Press on the cover and slide in the direction of the arrow.
- 2 Load two AAA batteries, taking care that the + and - ends face the correct direction.
- 3 Close the cover until it clicks.

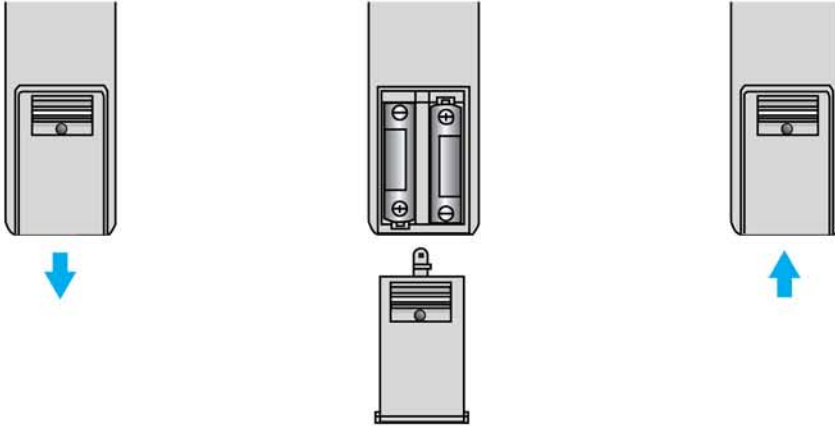

Reception Range of Remote Control

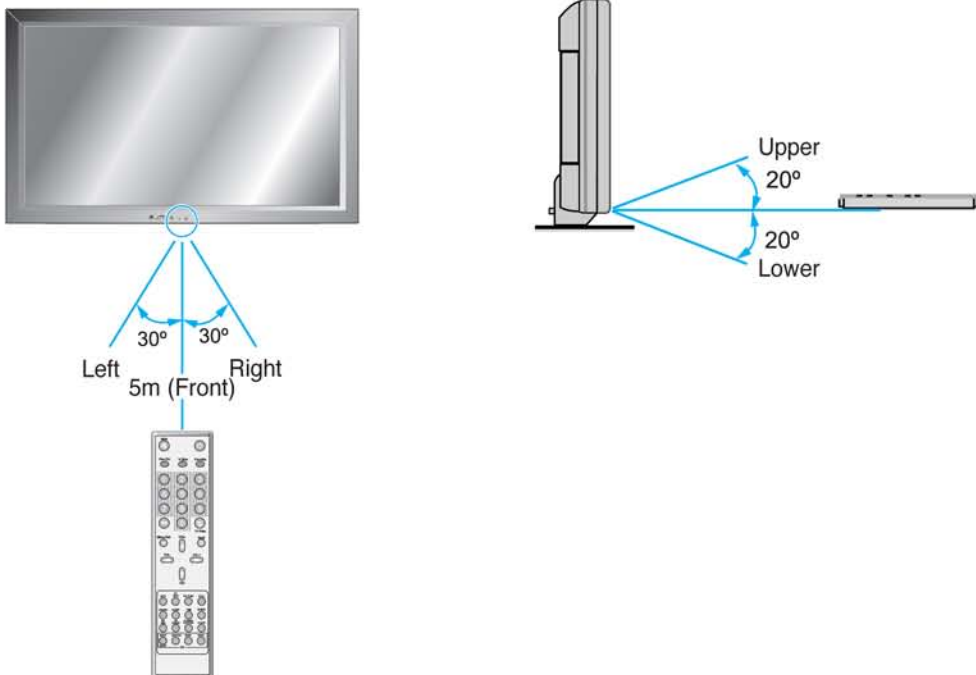
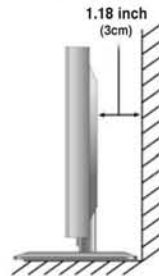
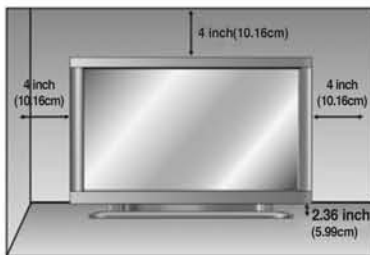

Table Stand Installation (Optional)



< The monitor can be installed on the desk as shown above. >

- Table stand mount minimum allowable clearances for adequate ventilation.



Installation

Table-Stand User's Guide

- 1 Insert Stand Bars into the Stand Base as shown below
- 2 a - Secure with Screw A (8 x 18)

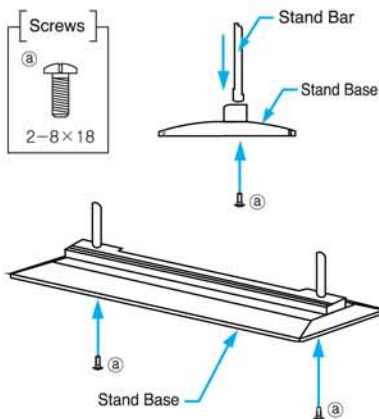

- 3 Insert a Stand-Table as below
- 4 b - Secure with Screw B (4 x 30)

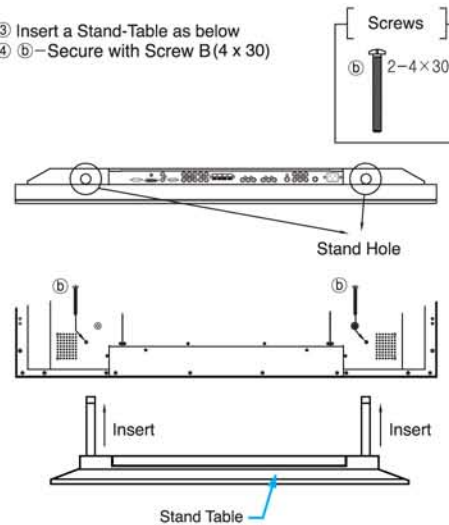

Speaker Installation (Optional)

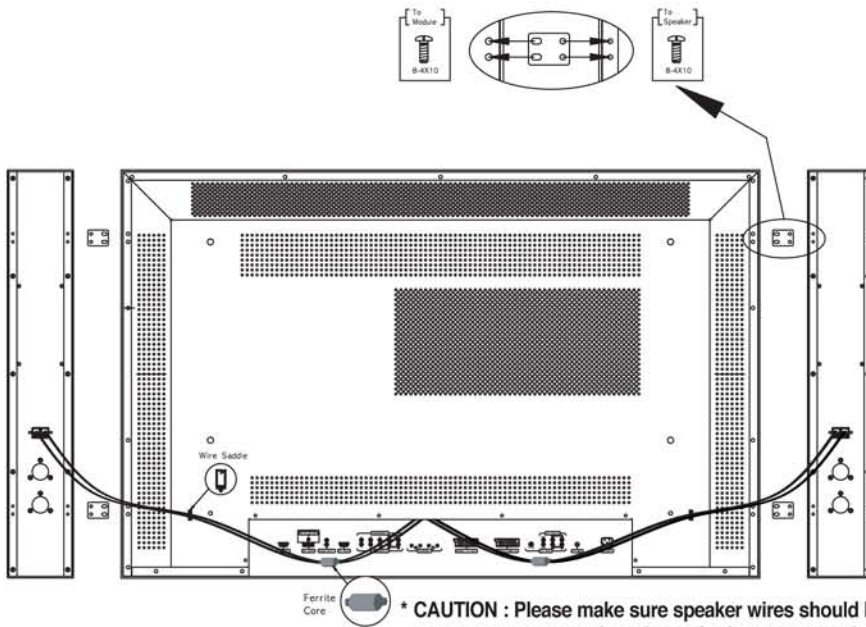

* CAUTION : Please make sure speaker wires should be connected as above, ferrite core are to be nearer to the main unit not to speakers to avoid possible electromagnetic-interference.



Caution

- Be sure monitor power is turned off before making any connections. Place the speakers in the position you want. Install the speaker wires on the monitor and speaker. Be sure to connect the positive "+" wire to the "+" input and the negative "-" wire to the "-" input. Connect left monitor input to left speaker and right monitor input to right speaker. Any extra speaker wire length remaining can be bunched into the wire holders provided. (Caution: Once installed, the speaker wire holders lock into position and can't be removed.)
- Always lift the monitor itself (not the speakers) when handling or moving the monitor after speakers have been installed.

Speaker Accessories



4 - Iron Plates
(Mount speakers to monitor)



16 - 4 x 10 Long Bolts
(Attach iron plates to speakers)



2 - Speaker Wire Holders
(For arranging the speaker wires)



2 - Speaker Wires

Connecting the TV Cable

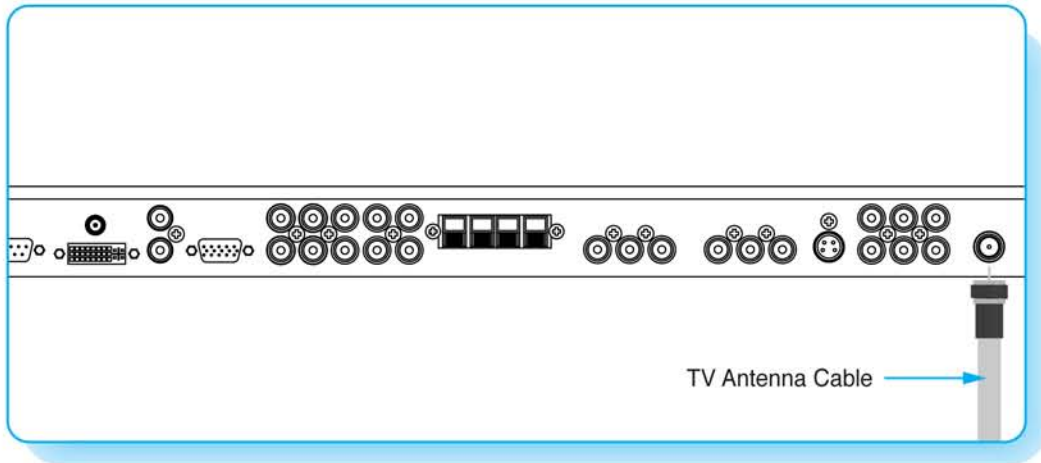

Connecting the TV Cable

- 1 Connect the TV antenna cable to the TV input jack. Press INPUT button on the remote control and select TV on OSD.
- 2 Use CH+/CH- button or numeric button to change TV channel for your channel selection.
- 3 Press Pre.CH button on the remote control to tune the previous channel.
- 4 Also, you can tune to cable service provided channels using the cable box. For further information regarding cable TV service, contact cable TV service provider(s).

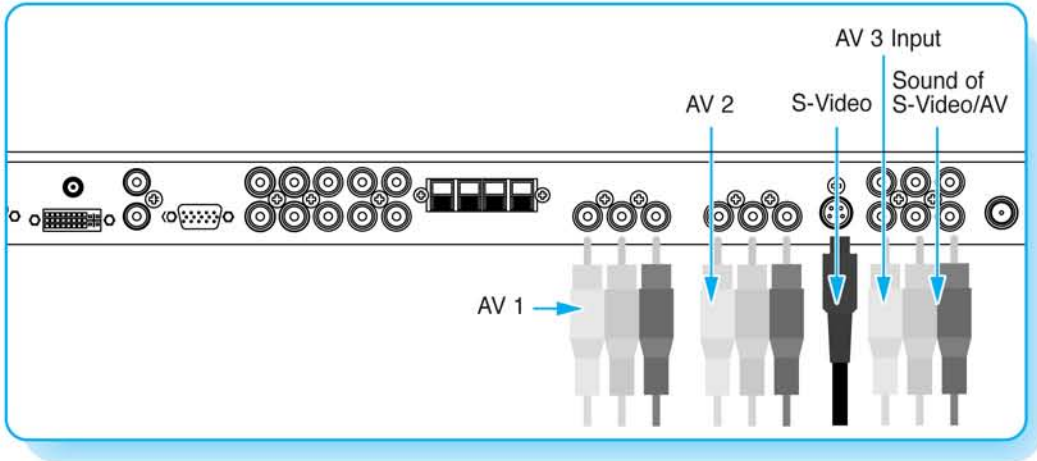

Connecting the VCR

With S-Video

Connect a S-Video cable to the S-Video jacks of the VCR and the monitor.

Connect L (White), R (Red) sound cable (Composite) to the sound jacks of the VCR and the monitor.

With AV Input

Connect a composite cable to the AV video jacks of the VCR and the monitor.

Connect L (White), R (Red) sound cable (Composite) to the sound jacks of the VCR and the monitor.

Watching VCR

- 1 Press INPUT button on the remote control and select video sources.
- 2 Insert a video tape into the VCR and press the PLAY button on the VCR.



Notes

- **To avoid picture noise** (interference), leave an adequate distance (over 3m) between the VCR and monitor.
- When connecting the monitor with external equipment, match the color of connecting ports (e.g. Video - Yellow, Audio(L) - White, Audio(R) - Red).
- If you have a mono VCR, connect the audio cable from the VCR to the Audio(L/Mono) input of the monitor.
- If you connect an S-VHS VCR to the S-Video input socket, you can get a better picture quality than normal video input (AV).

Connecting the DVD

- Connect the three separate component video cables to the DVD player's Y, Pb and Pr jacks and to the Component jacks on the monitor.
- Connect the audio cable to the DVD player's audio L (White) and R (Red) jacks and to the L and R audio jacks beside the Component jacks on the monitor.

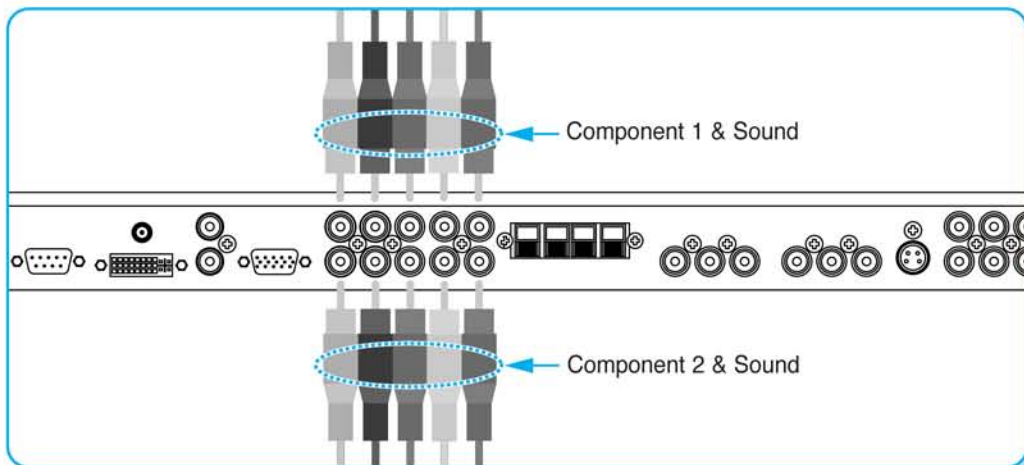

How to Use

- 1 Turn on the DVD player.
- 2 Press INPUT button on the remote control of the monitor and select Component 1 or Component 2.

Component Input Ports

You can get better picture quality if you connect DVD player with component input sockets as below.



Notice

- Normal DVD source is based on 480i, which should be through normal YPbPr of component signal.
- Component, PC, DVI ports can be displayed only 1 signal among them. If one of them is being displayed, other ports are unavailable.

Supported Signals for Component Ports

	Component 1	Component 2
480i/60Hz	✓	✓
480p/60Hz	✓	✓
576i/50Hz	✓	✓
576p/50Hz	✓	✓
720p/50Hz	✓	✓
720p/60Hz	✓	✓
1080i/50Hz	✓	✓
1080i/60Hz	✓	✓

Component ports of the monitor	Y	Pb	Pr
Video output ports of DVD player	Y	Pb	Pr
	Y	B-Y	R-Y
	Y	Cb	Cr
	Y	Pb	Pr

How to Connect

Connect Set Top Box (STB) video inputs to AV, Component, PC or DVI jacks on the monitor.
Audio inputs to audio sockets beside the L (White) and R (Red) audio jacks which you connect video inputs.

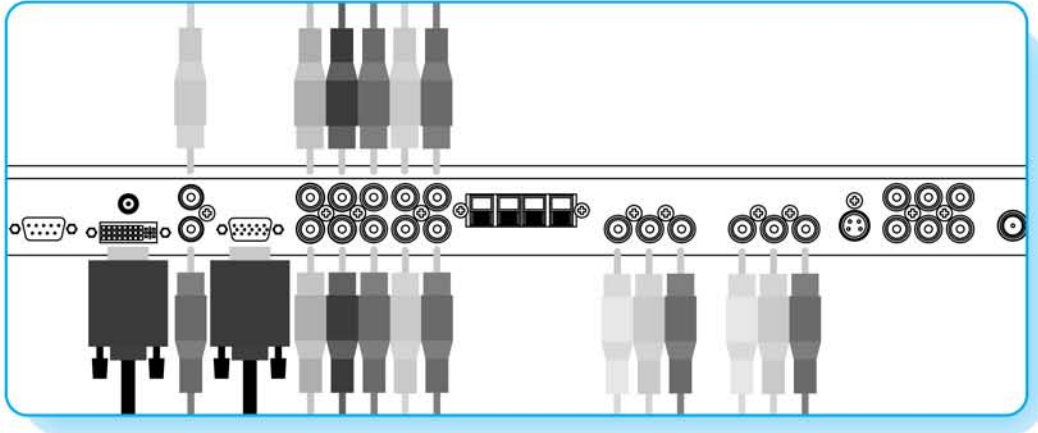

How to Use

- 1 Turn on the set top box.
- 2 Press INPUT button on the remote control of the monitor and select Component 1, Component 2, PC or DVI.

Supported Signals

	Component 1	Component 2	PC	DVI
480i/60Hz	✓	✓	–	–
480p/60Hz	✓	✓	✓	✓
576i/50Hz	✓	✓	–	–
576p/50Hz	✓	✓	✓	✓
720p/50Hz	✓	✓	✓	✓
720p/60Hz	✓	✓	✓	✓
1080i/50Hz	✓	✓	✓	✓
1080i/60Hz	✓	✓	✓	✓

How to Connect

With Component

Connect a three separate component cables to the component jacks of the STB and the monitor.
Connect L (White) and R (Red) sound cables (Composite) to the sound jacks of the STB and the monitor.

With RGB(D-Sub) or DVI

Connect a D-Sub or DVI cable to the AV video jacks of the STB and the monitor.
Connect L (White) and R (Red) sound cables (Composite) to the sound jacks of the STB and the monitor.



Notice

- Component, PC and DVI ports can be displayed only 1 signal among them. If one of them is being displayed, other sockets are unavailable.

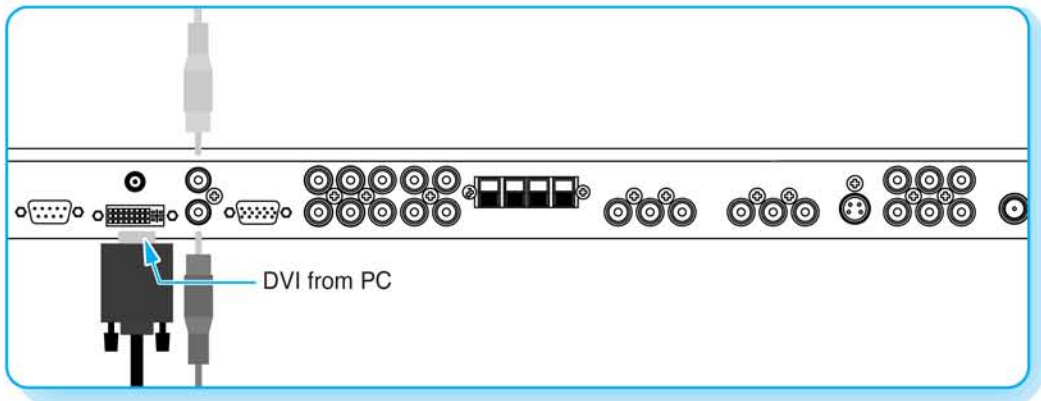
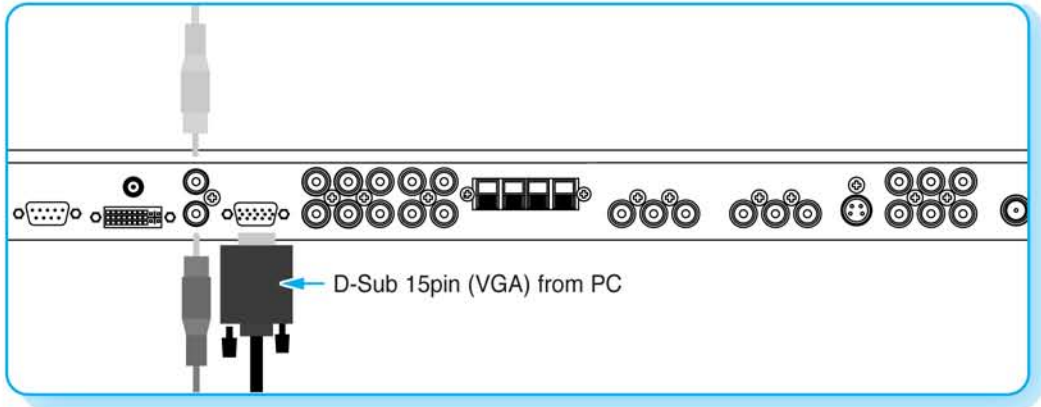

▶ Connecting a PC to the monitor

- There are two connectors to connect the monitor and PC: D-Sub and DVI.
- D-Sub
Connect a PC (15pin) video cable between the video output port on the PC and the PC port on the monitor.
- DVI
Connect a DVI-D cable between the DVI output port on the PC and the DVI port on the monitor.

▶ Pin Configuration

15pin signal cable (based on protruded pin)

▶ To watch the PC screen

- 1 Turn on the monitor and press INPUT button to select the PC mode.
- 2 Turn on the PC and check for the PC requirements.
- 3 Adjust the PC screen in Geometry menu.
(See 35 page.)



Pin No.	Description
1	Red (R)
2	Green (G)
3	Blue (B)
4	Grounding
5	Grounding (DDC)
6	Red (R) Grounding
7	Green (G) Grounding
8	Blue (B) Grounding
9	Reserved
10	Sync Grounding
11	Grounding
12	Data (DDC)
13	Horizontal sync.
14	Vertical sync.
15	Clock (DDC)

Resolution	Horizontal Frequency (KHz)	Vertical Frequency (Hz)
640 x 350	31.468	70.09
	37.861	85.08
640 x 400	31.469	70.08
	37.927	85.03
640 x 480	31.469	59.94
	35.000	66.66
	37.861	72.80
	37.500	75.00
	43.269	85.00
	45.913	90.03
	53.011	100.04
800 x 600	64.062	120.000
	35.156	56.25
	37.879	60.31
	48.077	72.18
	46.875	75.00
	53.674	85.06
	56.000	90.00
832 x 624	64.016	100.00
	49.725	74.55
852 x 480	31.468	60.05
1024 x 768	48.363	60.00
	56.476	70.06
	60.023	75.02
1280 x 768	47.700	60.00
1280 x 1024	64.000	60.00
1366 x 768	48.387	60.00

• The PC signal is supported by DVI also.



Notes

- **Synchronization input form : separate**
- The monitor recognizes 640 x 480 @60Hz signal as 480p DTV signal. So the signal is expanded, please try other signals like 640 x 480 @75Hz.
- The monitor operates abnormally if a non-standard video format is selected.
- 1280 X 768 : 40"(15:9) native resolution horizontal polarity is positive(+) vertical polarity is negative(-).
- 1366 X 768 : 32/40"(16:9) native resolution horizontal polarity is positive(+) vertical polarity is negative(-).
- Depending on the manufacturer, your PC screen might appear differently (and depending on your particular version of windows). Check your PC instruction book for information about connecting your PC to a the monitor.
- The monitor may operate abnormally if a non-standard video signal.
- "Out of range" message box will appear when an over-spec video signal is input. Change the video settings of PC when the message is displayed.

Turning the Monitor ON/OFF

Press the Power button on the remote control. The monitor will turn on and you will be ready to use its features. You can also use the Power button on the front panel.

Select Source

Press INPUT button on the remote control. Then you can see the source list menu shown as below.



Source list menu

Select the source to watch with CH+/CH- button on the remote control and press the Menu/Set button.

TV Channel Selection

- 1 Connect the signal source (TV antenna) to TV input. Press INPUT button on the remote control and select TV on the source list.
- 2 Use CH+/CH- button or numeric button to change TV channel you want.
- 3 Press Pre.CH button on the remote control to watch the previous channel.
- 4 Also, you can tune the cable service, provided channels while using the cable box. For further information regarding cable TV service, contact your TV service provider(s).

Volume Control

Use VOL+/VOL- button on the remote control to adjust the volume level.
Press Mute button on the remote control when you need to cut the sound temporarily.

- OSD (On Screen Display) allows users to control or adjust various features and settings in accordance with his/her preferences.
- Press the Menu/Set button on the remote control to see the main OSD menu.

Example of OSD Menu

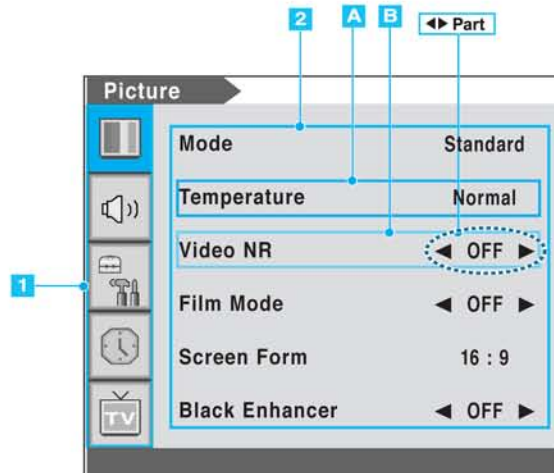

1 Main Menu

Press Menu/Set button on the remote control to enter the main OSD menu. First, select main menu item you need with CH+/CH- button. To select a main menu items, just press VOL+ or Menu/Set button on the remote control.

2 Sub Menu

Each menu item has its own sub menu items to set.

3 Sub Menu Items

- A : If there is no ◀▶ part, the item has an sub menu.
 You can enter the sub menu and adjust an item you need.
 Select sub menu item with CH+/CH- button on the remote control and press VOL+ or Menu/Set button to enter the sub menu.
- B : If there is a ◀▶ part, you can set the item by selecting ◀▶. Ex) ◀ ON ▶ or ◀ OFF ▶
 Press VOL+ or Menu/Set button to set a ◀▶ part, and adjust it with CH+/CH- button.

Choosing the Channel Type

Before your television can begin memorizing the available channels, you must specify the type of signal source that is connected to the TV (i.e., an antenna, a standard cable system, an HRC, or an IRC).

- 1 Press Menu/Set button to display the main OSD menu.
- 2 Select the TV main menu item.
- 3 Press Menu/Set button to enter the sub menu.
- 4 Select **Channel Type** and press VOL+ button to enter the ◀▶ parts. Then the cursor moves into the ◀▶ parts.
- 5 Select the channel type with CH+/CH- button and press Back button. You can select **NTSC(AIR,CATV,IRC,HRC)** or **PAL(AIR,CATV)**.

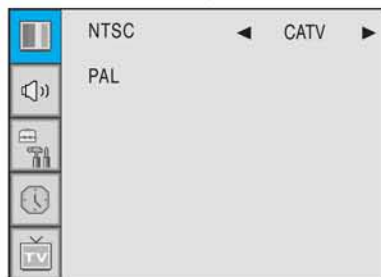

Notes

- You can enter the TV menu in TV mode only. (When you watch a TV channel.)
- PAL means PAL-M in channel type.
- PAM-M(AIR, CATV) is used in Brazil.

Storing the Channel Automatically

- 1 Press Menu/Set button to display the main OSD menu.
- 2 Select the TV main menu.
- 3 Press Menu/Set button to enter the sub menu.
- 4 Select **Auto Scan** with CH+/CH- button and press Menu/Set button on the remote control. Then the tuning bar will appear and scanning will start.



Fine Tuning the Channel Reception

The fine tuning function lets you manually adjust the monitor's tuner if you have difficulty tuning analog channels.

- 1 Press Menu/Set button to display the main OSD menu.
- 2 Select the TV main menu item.
- 3 Press Menu/Set button to enter the fine tune sub menu.
- 4 Select **Fine Tune** with CH+/CH- button and press Menu/Set button. Then you can see the adjust bar.
- 5 Adjust the Fine Tune with VOL+/VOL- button.

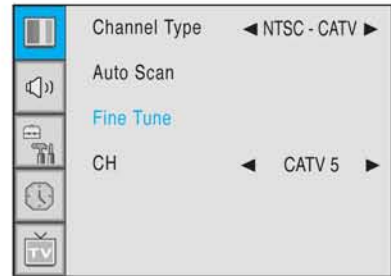

Digest

In the Digest function, you can watch 15 programs at the same time. (This function works only in TV mode)

- 1 Press the DIGEST button on the remote control.
- 2 By pressing the channel number, the selected channel becomes main window.
- 3 You can make off the digest function by pressing DIGEST button again.

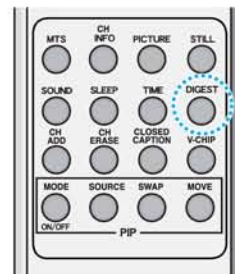

Setting the Favorite Channel

You can store of your favorite channels for each available input source (such as TV or CATV). Then, when you press the Favorite button on the remote control, the monitor display only the favorite channels you previously stored, allowing you to quickly and easily find frequently wanted channels.

- 1 Press Menu/Set button to display the main OSD menu.
- 2 Select the TV main menu.
- 3 Press Menu/Set button to enter the TV sub menu.
- 4 Select **CH** and press the Menu/Set button. Then the cursor moves into the ◀▶ parts and the **Skip** and **FAV** menu appear.
- 5 In the ◀▶ parts, select the channel to Skip or set as the Favorite channels.
- 6 Then press CH- button on the remote control to enter the sub menu.
- 7 In sub menu, move with CH+/CH- button and set the values with VOL+/VOL- button.

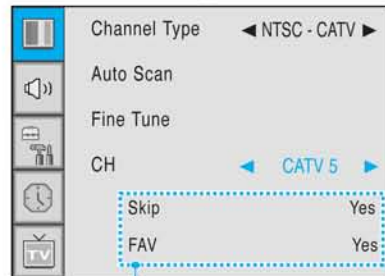
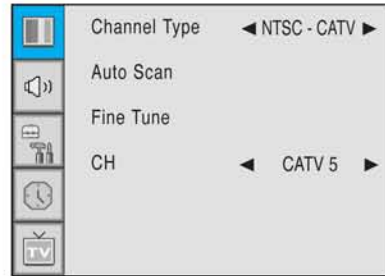

Sub menu appears

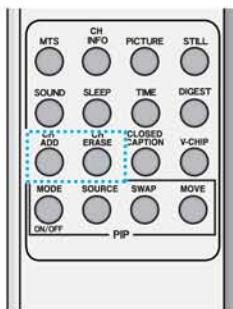

You can add or erase the current channel by the remote control.

- 1 **CH ADD**
Add the current channel into the scanned channel list.
- 2 **CH ERASE**
Remove the current channel from the scanned channel list.



Notes

- Only scanned channels can be set as favorite channels.

Changing the Picture Mode

Your the monitor has 3 automatic factory preset picture settings (**Standard**, **Vivid** and **Mild**). You can choose Standard, Vivid or Mild by pressing PICTURE button on the remote control (or by making a selection from the menu). Or you can select User which automatically recalls your personalized picture setting.

- 1 Press Menu/Set button to display the main OSD menu.
- 2 Select the Picture main menu.
- 3 Press Menu/Set button to enter the sub menu.
- 4 Select **Mode** and press Menu/Set button to enter the sub menu. Then the picture sub mode appear.
- 5 Select the picture mode and press Menu/Set button.
- 6 You will see the picture setting bars. Just press Back button on the remote control. You can adjust each values of the picture setting, but the changed values are stored as in **User** mode.

**User mode has additional settings in a sub menu:
See next page.**

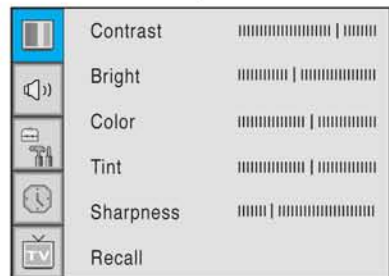
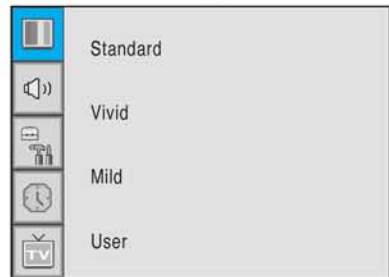

Notes

- **Alternative method** : Just press the PICTURE button on the remote control. Each time it is pressed, different mode is selected.

Setting the Picture

Adjust User Mode

You can change the Contrast, Brightness, Color, and Sharpness according to personal preference in user mode.

- 1 Select the item to adjust with CH+/CH- button.
- 2 Press Menu/Set button.
- 3 Adjust the item with VOL+/VOL- button.
- 4 To cancel all adjust, select **Recall** and press Menu/Set button.

For a more detailed description of these settings, see the next page.

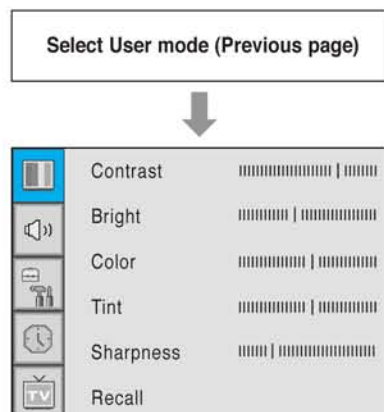

▶ Contrast

Adjust brightness difference between bright part of the screen and dark part.



Distinct ◀

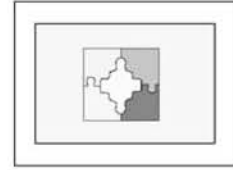

▶ Vague

▶ Brightness

Adjust brightness of the screen.

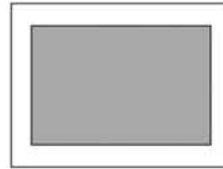

Dark ◀



▶ Bright

▶ Color

Adjust deep and light color of the screen.



Decrease ◀



▶ Increase

▶ Tint

Adjusts the balance between green and yellow.



Green color is deeper ◀



▶ Red color is deeper

▶ Sharpness

Adjust vividness of the screen.



Less sharp ◀



▶ Sharp

Changing the Color Temperature

Your the monitor has 5 screen temperatures (color settings):

- 1 Press Menu/Set button to display the main OSD menu.
 - 2 Select the Picture main menu.
 - 3 Press Menu/Set button to enter the picture menu.
 - 4 Select **Temperature** and press Menu/Set button to enter the sub menu. Then the picture-temperature sub menu appear.
 - 5 Select the Temperature mode with CH+/CH- button and press Menu/Set button.
 - 6 Press Back button to return.
- ▶ **Cool 1, 2**
Screen seems cool: Strong Blue.
 - ▶ **Normal**
Normal: Factory default.
 - ▶ **Warm 1, 2**
Screen seems warm: Strong Red.

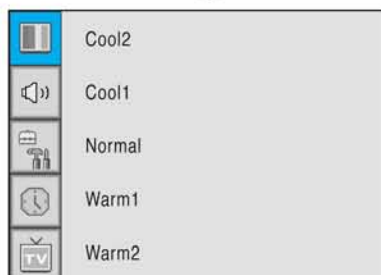

Video NR (Noise Reduction)

This function automatically filters out and reduces the image noise and improves picture quality when receiving weak signals.

- 1 Press Menu/Set button to display the main OSD menu.
- 2 Select the Picture main menu item.
- 3 Press Menu/Set button to enter the sub menu.
- 4 Select **Video NR** and press VOL+ button to enter the ◀▶ parts. Then the cursor moves into the ◀▶ parts.
- 5 Turn on or off Video NR function with CH+/CH- button and press Back button.

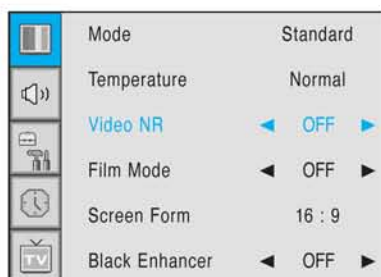

Selecting the Film Mode

This mode is in order to watch a movie composed of 24frames smoothly when the movie is converted to 30frames on TV.

- 1 Press Menu/Set button to display the main OSD menu. Select the picture main menu item.
- 2 Press Menu/Set button to enter the sub menu.
- 3 Select **Film Mode** and press VOL+ button to enter the ◀▶ parts. Then the cursor moves into the ◀▶ parts.
- 4 Turn on or off Film Mode function with CH+/CH- button and press Back button.

	Mode	Standard
	Temperature	Normal
	Video NR	◀ OFF ▶
	Film Mode	◀ OFF ▶
	Screen Form	16 : 9
	Black Enhancer	◀ OFF ▶

Changing the Screen Form

Your the monitor has four screen forms: **16:9, Panorama, Zoom1, Zoom2, 4:3.**
(For more detail description for these modes, refer to the next page.)

- 1 Press Menu/Set button to display the main OSD menu.
- 2 Select the Picture main menu.
- 3 Press Menu/Set button to enter the picture menu.
- 4 Select **Screen Form** and press Menu/Set button to enter the sub menu. Then the screen form sub menu appear.
- 5 Select the Screen Form you want and press Menu/Set button.

	Mode	Standard
	Temperature	Normal
	Video NR	◀ OFF ▶
	Film Mode	◀ OFF ▶
	Screen Form	16 : 9
	Black Enhancer	◀ OFF ▶



	16 : 9
	Panorama
	Zoom1
	Zoom2
	4 : 3

Setting the Picture

Screen Form Description

16:9

16:9 video : No change.

4:3 video : Expands 4:3 video signal horizontally to fit the 16:9 screen.

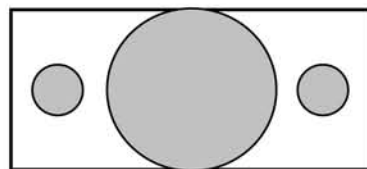

Panorama

16:9 video : No change.

4:3 video : Expands 4:3 video horizontally to fit the 16:9 screen and to minimize distortion, sides are expanded more than center.

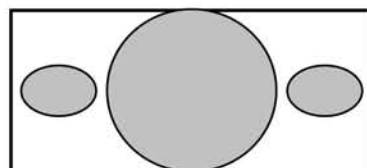

Zoom 1

Expands 16:9 mode screen vertically.

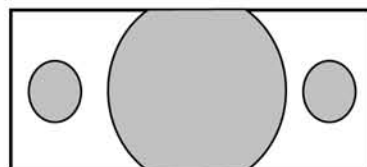

Zoom 2

Expands zoom 1 mode screen vertically.

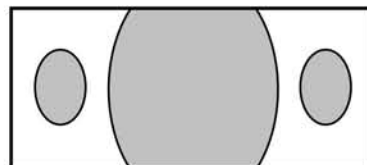

4 : 3

16:9 video : The image is suppressed.

4:3 video : No expansion.

There are gray areas besides the image.

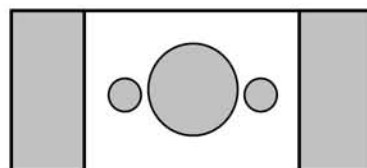

Setting the Black Enhancer

This will enhance the black level / the contrast of the picture. The dark regions of the picture are made darker, while bright areas remain unchanged.

The advantage of this black-level expansion is that the black expansion is performed only if it is noticeable to the viewer.

	Mode	Standard
	Temperature	Normal
	Video NR	◀ OFF ▶
	Film Mode	◀ OFF ▶
	Screen Form	16 : 9
	Black Enhancer	◀ OFF ▶

In PC mode, you can adjust the H, V-Position, Native Mode, and Phase. Also you can adjust them automatically.

Adjusting te PC Screen (Geometry)

You can change H, V-Position, Native Mode, and Phase in PC mode like usual PC monitors. You can also adjust them automatically. (Auto adjust function.)

- 1 Press Menu/Set button to display the main OSD menu.
- 2 Select the Picture main menu with CH+/CH- button.
- 3 Press Menu/Set button to enter the sub menu.
- 4 Select **Geometry** and press Menu/Set button to enter the sub menu. Then the picture-geometry sub menu will appear.

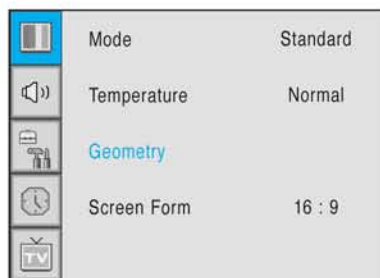

- 1 Select the item to adjust with CH+/CH- button.
- 2 Press Menu/Set button.
- 3 Then the cursor moves on the bar and you can adjust the value with VOL+/VOL- button.
- 4 To adjust these items, automatically, select **Auto Adjust** and press Menu/Set button.

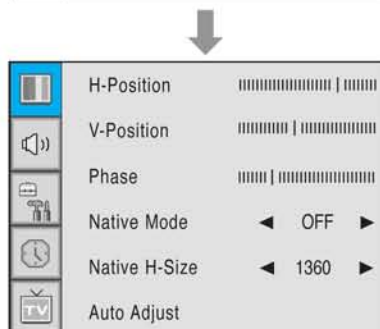

For more detail description refer to the next page.

You can select the H-Size of Native Mode depending on the Input timing (1360/1366 selection)

Setting the Picture [PC]

▶ H-Position

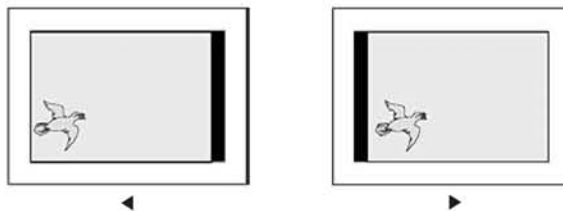

▶ V-Position

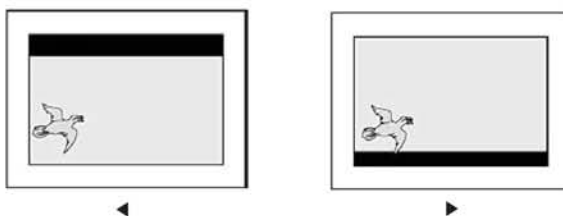

▶ Phase

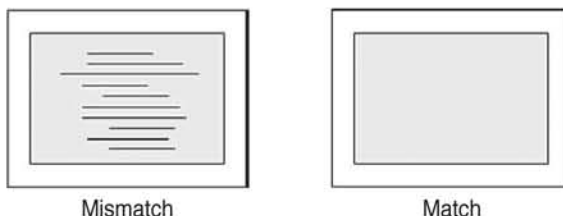

▶ Native Mode

When you use monitor, native mode display all timing to 1366 x 768 mode.

When you off native mode, monitor display 1366 x 768 mode expect 1360 x 768.

- 1 Select Native Mode menu and press VOL+ button to enter the ◀▶ parts. Then the cursor moves into the ▶◀ parts.
- 2 Turn the function on or off with CH+/CH- button and press Back button.

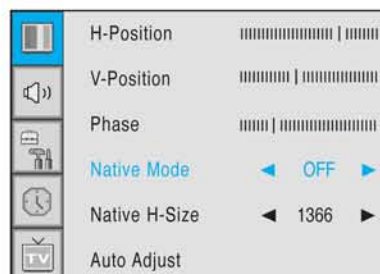

In Sound menu, you can adjust balance, MTS (Multi-Track Sound), AVC (Auto Volume Control) and select the equalizer settings.

Adjusting the Sound Balance

This control allows you to adjust the balance of the left and right speaker output.

- 1 Press Menu/Set button to display the main OSD menu.
- 2 Select the Sound main menu.
- 3 Press Menu/Set button to enter the sub menu.
- 4 Select **Balance** and press Menu/Set button.
- 5 Adjust the Balance with VOL+/VOL- button and press Menu/Set button.

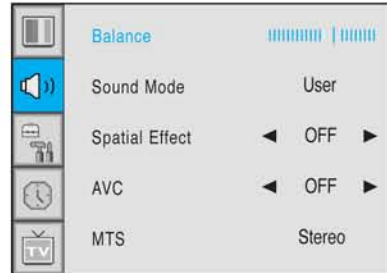

Changing the Sound Mode

Your the monitor has four automatic sound settings (**Standard, Movie, Music** and **News**) that are preset at the factory. You can activate either Standard, Movie, Music, or News by pressing SOUND on the remote control (or by making a selection from the menu) or you can select **Custom** which automatically recalls your personalized sound settings.

- 1 Press Menu/Set button to display the main OSD menu.
- 2 Select the Sound main menu.
- 3 Press Menu/Set button to enter the sub menu.
- 4 Select **Sound Mode** and press Menu/Set button to enter the sub menu. Then the mode sub menu appear.
- 5 Select the **User** setting and press Menu/Set button.
- 6 You will see the equalizer bars. Just press Back button on the remote control. You can adjust each values of equalizer, but the changed values are stored as in **User** mode.

User mode require more settings.
It has sub menu: See next page.

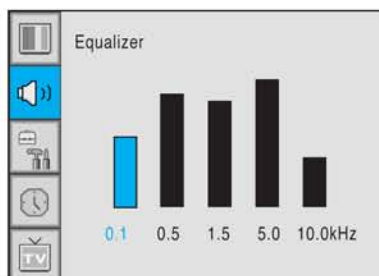

Adjusting the User Sound Mode

You can use the OSD menu to change the treble, Bass, Balance, and DRC according to your preference.

- 1 Equalizer menu appear when you select User mode.
- 2 Select a gain bar with VOL+/VOL- button on the remote control and adjust it with CH+/CH- button.
- 3 Press Back button on the remote control to exit equalizer. The result will be saved automatically.

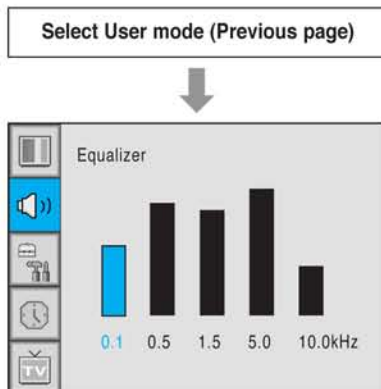

Spatial Effect

This function can create surround effect such as the sound seems to come from all directions.

- 1 Press Menu/Set button to display the main OSD menu.
- 2 Select the Sound main menu item with CH+/CH- button.
- 3 Press Menu/Set button to enter the sub menu.
- 4 Select **Spatial Effect** and press VOL+ button.
- 5 Turn on or off Spatial Effect function with CH+/CH- button and press Menu/Set button.

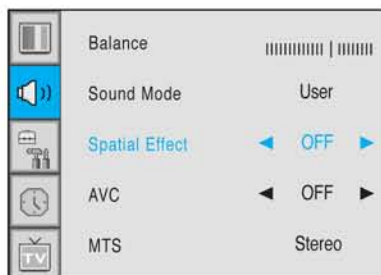

AVC (Auto Volume Control)

This function adjust sound volume level automatically depending on the source.

- 1 Press Menu/Set button to display the main OSD menu.
- 2 Select the Sound main menu.
- 3 Press Menu/Set button to enter the sub menu.
- 4 Select **AVC** and press VOL+ button to enter the ◀▶ parts. Then the cursor moves into the ◀▶ parts.
- 5 Turn on or off AVC function with CH+/CH- button and press Back button.

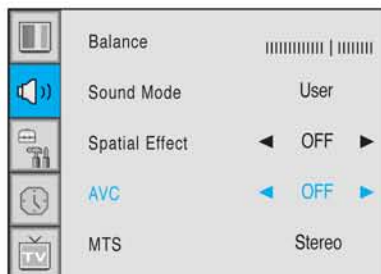

MTS (Multichannel Television Sound)

Select sound signal format from the input source. There are **Mono**, **Stereo**, **SAP** sound formats.

- 1 Press Menu/Set button to display the main OSD menu.
- 2 Select the Sound main menu with CH+/CH- button on the remote control.
- 3 Press Menu/Set button to enter the sub menu.
- 4 Select **MTS** and press Menu/Set button to enter the sub menu. Then the MTS sub menu appear.
- 5 Select the MTS format with CH+/CH- and press Menu/Set button.

The available sound forms are displayed.
Usually, you can see Mono and Stereo.

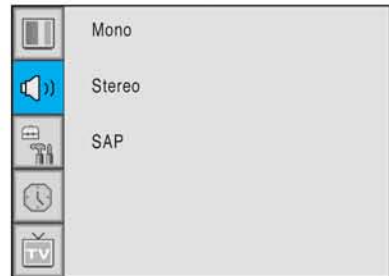

In Setup menu, you can adjust the transparency of the OSD menu and set PIP and others.

Adjusting the Transparency of the OSD Window

Adjust the transparency of the OSD menu. There are 8 step from OFF to 7.

- 1 Press Menu/Set button to display the main OSD menu.
- 2 Select the Setup main menu with CH+/CH- button on the remote control.
- 3 Press Menu/Set button to enter the sub menu.
- 4 Select **Translucent** and press VOL+ button to enter the ◀▶ parts. Then the cursor moves into the ◀▶ parts.
- 5 Adjust with CH+/CH- button and press Back button.

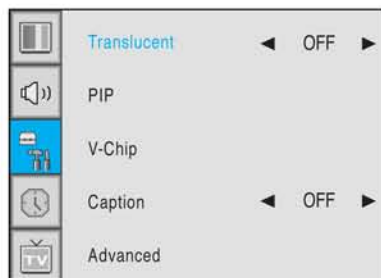

PIP (Picture in Picture)

You can watch two channels or sources at the same time. And Setup PIP size and position.

- 1 Press Menu/Set button to display the main OSD menu.
- 2 Select the Setup main menu with CH+/CH- button on the remote control.
- 3 Press Menu/Set button to enter the sub menu.
- 4 Select **PIP** and press Menu/Set button to enter the sub menu. Then the PIP sub menu appear.

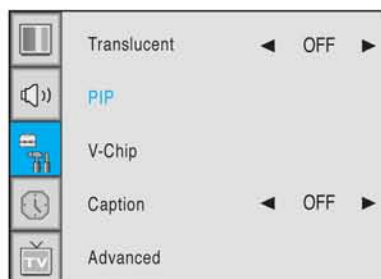

PIP Window

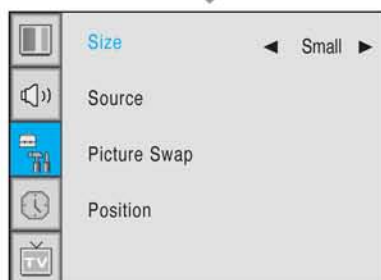

Changing the Size in PIP

Change the size of the PIP window. There are 3 sizes: Small, Large, Twin.

- 1 Select **Size** and press VOL+ button to enter the ◀▶ parts. Then the cursor moves into the ◀▶ parts.
- 2 Adjust Size function with CH+/CH- button and press Menu/Set button.



Small



Large



Twin

Choosing the Source in PIP

Change the source of the PIP window.

- 1 Select **Source** and press Menu/Set button to enter the sub menu. Then the PIP sub menu appear.
- 2 The available sources will be displayed. Select the source and press Menu/Set button.

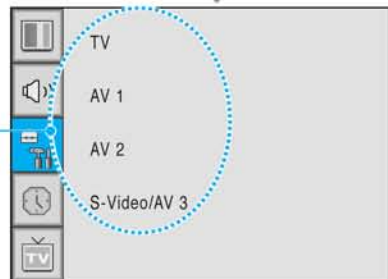

This picture is an example. The displayed sources may be different depending on the main input source.

PIP \ Main	TV	AV 1	AV 2	S-Video/AV 3	Component 1	Component 2	PC	DVI
TV	✓	✓	✓	✓	✓	✓	✓	✓
AV 1	✓	-	✓	✓	✓	✓	✓	✓
AV 2	✓	✓	-	✓	✓	✓	✓	✓
S-Video/AV 3	✓	✓	✓	-	✓	✓	✓	✓
Component 1	✓	✓	✓	✓	-	-	-	-
Component 2	✓	✓	✓	✓	-	-	-	-
PC	✓	✓	✓	✓	-	-	-	-
DVI	✓	✓	✓	✓	-	-	-	-

Picture Swap in PIP

Swap the sources of the main screen and the PIP window.

Select picture swap and press Menu/Set button.

Changing the Position in PIP

Change the position of the PIP window.

- 1 Select **Position** with CH+/CH- button on the remote control and press Menu/Set button to enter the sub menu. Then the PIP sub menu appear.
- 2 In sub menu, there are four positions. Select the Position with CH+/CH- button on the remote control and press Back button.

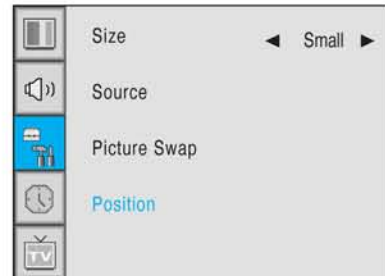

Other Advanced Function

You can Setup ID, Blue Back, Language, and Front Key Lock in Advanced menu.

- 1 Press Menu/Set button to display the main OSD menu.
- 2 Select the Setup main menu with CH+/CH- button on the remote control.
- 3 Press Menu/Set button to enter the sub menu.
- 4 Select **Advanced** and press Menu/Set button to enter the Advanced menu. Then the advanced sub menu appear.

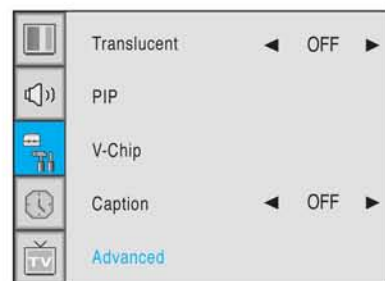

▶ Set ID

Set the ID of the monitor for mass-controlling through the serial port.

- 1 Select **Set ID** and press VOL+ button to enter the ◀▶ part. Then the cursor moves into the ◀▶ part.
- 2 Adjust with CH+/CH- button and press Back button.



▶ Setting the Blue Screen Mode

You can set to display blue-color screen instead of noise screen.

- 1 Select **Blue Back** and press VOL+ button to enter the ◀▶ parts. Then the cursor moves into the ◀▶ parts.
- 2 Turn the function on or off with CH+/CH- button and press Back button.



▶ Changing the OSD Language

Set the language to use in OSD.

Supported languages are English, French, German, Spanish, and Italian.

- 1 Select **Language** and press VOL+ button to enter the ◀▶ parts. Then the cursor moves into the ◀▶ parts.
- 2 Choose the Language with CH+/CH- button and press Back button.



▶ Front Key Lock in Advance

Lock the OSD panel of the monitor.

It can protect the monitor from children's power On/Off or other operation by miss.

- 1 Select **Front Key Lock** and press VOL+ button to enter the ◀▶ parts. Then the cursor moves into the ◀▶ parts.
- 2 Turn the function on or off with CH+/CH- button and press Back button.



V-Chip (TV Parental Guidelines)

Parental restrictions can be Setup using either of two methods: The TV guidelines or the MPA rating.

- 1 Press Menu/Set button to display the main OSD menu.
- 2 Select the Setup main menu with CH+/CH- button on the remote control.
- 3 Press Menu/Set button to enter the sub menu.
- 4 After enter the password, the V-Chip sub menu appear.

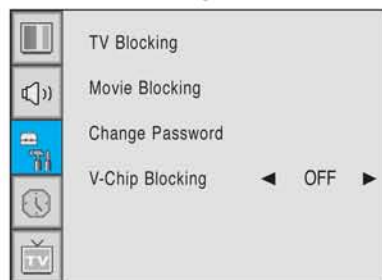
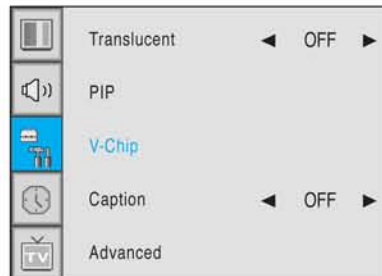

Caution

- The factory default number is 0000 and the master button number is 9673.

TV Blocking in V-Chip

You can Setup restrictions using the "TV Parental Guidelines" of FCC.

- 1 Select **TV Blocking** with CH+/CH- button on the remote control and press Menu/Set button to enter the sub menu. Then the TV Blocking sub menu appear.
- 2 You can independently lock the TV ratings. The locked TV (FCC) ratings are indicated by the symbol .
- 3 Press CH+/CH-/VOL+/VOL- buttons and the Menu/Set button to activate the appropriate restrictions for TV (FCC) rating system.

Note: These categories consist of two separate groups: TV-Y and TV-Y7 (young children through age 7), and TV-G through TV-MA (everybody else).

The restrictions for these two groups work independently: If a household includes very young children as well as young adults, the TV guidelines must be Setup separately for each age group.

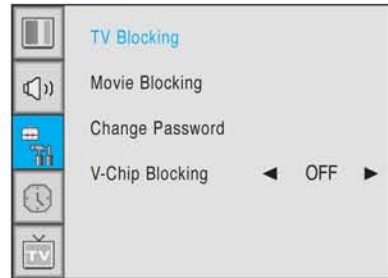

	Block	FV	D	L	S
TV-Y					
TV-Y7					
TV-G					
TV-PG					
TV-14					
TV-MA					

Movie Blocking in V-Chip

The Movie Blocking uses the motion picture association of america (MPAA) system, and its main application is for movies. When the rating controls is on, the TV will automatically block any programs that are coded with objectionable ratings (either MPAA or TV-Ratings).

- 1 Select **Movie Blocking** with CH+/CH- button on the remote control and press Menu/Set button to enter the sub menu. Then the Movie Blocking sub menu appear.
- 2 You can independently lock the TV ratings. The locked movie (FCC) ratings are indicated by the symbol .
- 3 Press CH+/CH- buttons and the Menu/Set button to activate the appropriate restrictions for MPAA rating system.

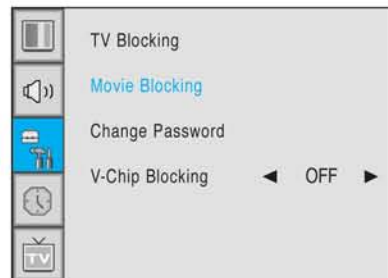

	Block
MPAA-G	
MPAA-PG	
MPAA-PG-B	
MPAA-R	
MPAA-R	
MPAA-NC	
MPAA-X	
MOZZ-NR	

Change Password in V-Chip

- 1 Select **Change Password** with CH+/CH- button on the remote control and press Menu/Set button to enter the sub menu. Then the password change sub menu appear.
- 2 Enter the new password with numeric buttons on the remote control.

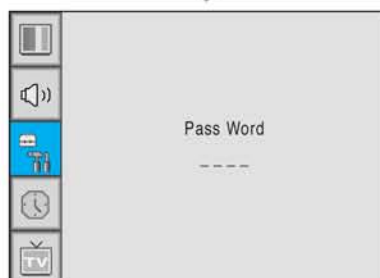
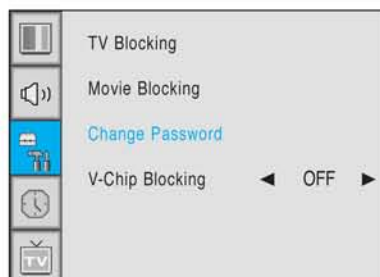

V-Chip Blocking in V-Chip

- 1 Select **V-Chip Blocking** with CH+/CH- buttons on the remote control.
- 2 Enter to the ◀▶ part by pressing VOL+ button. Then the cursor moves into the ◀▶ parts.
- 3 On or off the V-Chip Blocking with CH+/CH- buttons.
- 4 Exit with Back button on the remote control.

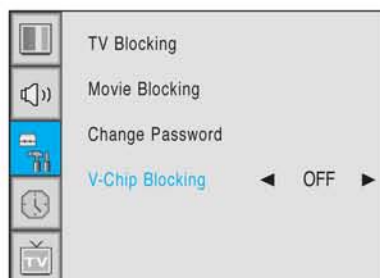

In the Time menu, you can set the current time and auto power On/Off.

Setting the Current Time

Set the current time.

- 1 Press Menu/Set button to display the main OSD menu.
- 2 Select the Time main menu.
- 3 Press Menu/Set button to enter the sub menu.
- 4 Select **Time Set** by pressing VOL+ button.
- 5 Move the cursor by pressing VOL+/VOL- button and adjust time by CH+/CH- button.

	Time Set	AM 03:29
	On Time	AM 05:11 ON
	On Channel	◀ 99 ▶
	On Volume	◀ 100 ▶
	Off Time	AM 05:11 OFF
	Sleep	◀ OFF ▶

Setting the On Time

This the monitor can be set to turn on automatically at specific time that you choose. Before using the timer, you must set the monitor's time as described previously.

- 1 Press Menu/Set button to display the main OSD menu.
- 2 Select the Time main menu with CH+/CH- button on the remote control.
- 3 Press Menu/Set button to enter the sub menu.
- 4 Select **On Time** with CH+/CH- button and press VOL+ button.
- 5 Move the cursor by VOL+/VOL- button and adjust time by CH+/CH- button.

	Time Set	AM 03:29
	On Time	AM 05:11 ON
	On Channel	◀ 99 ▶
	On Volume	◀ 100 ▶
	Off Time	AM 05:11 OFF
	Sleep	◀ OFF ▶



Setting the On Channel

Set the channel when the monitor power turn on automatically.

Available only when the time is set and on time is on.

- 1 Press Menu/Set button to display the main OSD menu.
- 2 Select the Time main menu with CH+/CH- button on the remote control.
- 3 Press Menu/Set button to enter the sub menu.
- 4 Select **On Channel**.
- 5 Enter to the ◀▶ part with VOL+ button. Then the cursor moves into the ◀▶ parts.
- 6 Adjust the channel with CH+/CH- button. Press Back button to return.



Setting the On Volume

Available only when the time is set and on time is on.

- 1 Press Menu/Set button to display the main OSD menu.
- 2 Select the Time main menu with CH+/CH- button on the remote control.
- 3 Press Menu/Set button to enter the sub menu.
- 4 Select **On Volume**.
- 5 Enter to the ◀▶ part by pressing VOL+ button. Then the cursor moves into the ◀▶ parts.
- 6 Adjust the sound volume level with CH+/CH- button.



Setting the Off Time

This the monitor can be set to turn off automatically at specific times that you choose. Before using the timer, you must set the monitor's clock as described previously.

- 1 Press Menu/Set button to display the main OSD menu.
- 2 Select the Time main menu with CH+/CH- button on the remote control.
- 3 Press Menu/Set button to enter the sub menu.
- 4 Select **Off Time** with CH+/CH- button on the remote control and press VOL+ button.
- 5 Move the cursor with VOL+/VOL- button and adjust time with CH+/CH- button.

	Time Set	AM 03:29
	On Time	AM 05:11 ON
	On Channel	◀ 99 ▶
	On Volume	◀ 100 ▶
	Off Time	AM 05:11 OFF
	Sleep	◀ OFF ▶

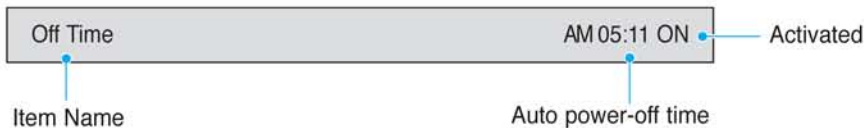

Setting the Sleep Timer

You can set your the monitor to automatically turn off after a preset interval.

If you turn off the monitor in the state of setting up sleep time and turn on again, sleep time erased therefore Setup again. The time period runs from OFF(0min) to 180min. (OFF, 10min, 20, 30, 60, 90, 120, 150, 180)

- 1 Press Menu/Set button to display the main OSD menu.
- 2 Select the Time main menu. With CH+/CH- button on the remote control.
- 3 Press Menu/Set button to enter the sub menu.
- 4 Select **Sleep** with CH+/CH- button on the remote control and press VOL+ button.
- 5 Enter to the ◀▶ part with VOL+ button. Then the cursor moves into the ◀▶ parts.
- 6 Set the time period with CH+/CH- button.
- 7 Press Back button to return.

	Time Set	AM 03:29
	On Time	AM 05:11 ON
	On Channel	◀ 99 ▶
	On Volume	◀ 100 ▶
	Off Time	AM 05:11 OFF
	Sleep	◀ OFF ▶

If your monitor is not working properly, please scan this list of problems and possible solutions. It may save you time and money.

Problem	Quick Action for Possible Solution
No picture & no sound	<ul style="list-style-type: none">• Check whether the monitor is turned on.• Power cord inserted into wall outlet?• Plug another product's power cord into the wall outlet where the monitor's power cord was plugged in.
Picture ok & no sound	<ul style="list-style-type: none">• Press the VOLUME(▶) button.• Check the audio input signal.
The remote control doesn't work	<ul style="list-style-type: none">• Check to see if there is any object between the monitor and the remote control causing obstruction.• Check to see if the batteries are installed with the correct polarities.
Digital broadcasting screen problem	<ul style="list-style-type: none">• Check the digital signal strength and input antenna.
No or poor color or poor picture	<ul style="list-style-type: none">• Select color in the picture and press VOLUME (▶) button.• Keep a certain distance between the monitor and the input source.• Activate any function to restore the brightness of the picture.• Check to see that both the monitor and the source are plugged in and turned on.
The image is too light or too dark	<ul style="list-style-type: none">• Adjust the brightness or contrast settings.
The image is too large or too small	<ul style="list-style-type: none">• Adjust the size settings.
No output from one of the speakers	<ul style="list-style-type: none">• Adjust Balance in the sound menu.