

**HITACHI**  
Inspire the Next

# 32 LCD HDTV

Owner's Guide  
Model L32C205  
32" Class (31.51" Diagonal)



## Owner's Guide

Thank you for purchasing this Hitachi product. Please read these instructions carefully.  
For additional assistance please call 1-888-333-1899(U.S.A. or Puerto Rico), or 01-800-700-4321(Mexico)  
or visit our website at [www.hitachi.us/tv](http://www.hitachi.us/tv).  
Keep this owner's guide for future reference.

Record the model number and serial number of your LCD Television for future reference.  
This information is located on the back of the television.

MODEL NUMBER \_\_\_\_\_ SERIAL NUMBER \_\_\_\_\_

### TABLE OF CONTENTS

IMPORTANT SAFETY INSTRUCTIONS.....	2-6
HOW TO ATTACH / REMOVE THE STAND.....	7
FIRST TIME USE .....	10-13
TV OPERATION .....	14-18
CONNECTIONS TO OTHER EQUIPMENT .....	19-21
TROUBLESHOOTING .....	22
SPECIFICATIONS.....	23
LIMITED WARRANTY.....	24-25
END USER LICENCE AGREEMENT FOR HITACHI DTV SOFTWARE .....	26-27
APPENDIXES.....	28



# ENGLISH

	<b>CAUTION</b> RISK OF ELECTRIC SHOCK DO NOT OPEN	
<b>CAUTION:</b> TO REDUCE THE RISK OF ELECTRIC SHOCK, DO NOT REMOVE COVER (OR BACK). NO USER-SERVICEABLE PARTS INSIDE. REFER SERVICING TO QUALIFIED SERVICE PERSONNEL.		



The lightning flash with arrowhead symbol, within an equilateral triangle is intended to alert the user to the presence of uninsulated dangerous voltage within the product's enclosure that may be of sufficient magnitude to constitute a risk of electric shock.



The exclamation point within an equilateral triangle is intended to alert the user to the presence of important operating and maintenance (servicing) instructions in the literature accompanying the appliance.

<b>WARNING:</b>	TO PREVENT FIRE OR SHOCK HAZARD, DO NOT EXPOSE THIS APPLIANCE TO RAIN OR MOISTURE. TO PREVENT THE SPREAD OF FIRE, KEEP CANDLES OR OPEN FLAMES AWAY FROM THIS PRODUCT AT ALL TIMES.
<b>CAUTION:</b>	TO PREVENT ELECTRIC SHOCK, DO NOT USE THIS POLARIZED PLUG WITH AN EXTENSION CORD, RECEPTACLE OR OTHER OUTLET UNLESS THE BLADES CAN BE FULLY INSERTED TO PREVENT BLADE EXPOSURE.

**WARNING:** This equipment has been tested and found to comply with the limits for a Class B digital device, pursuant to Part 15 of the FCC Rules. These limits are designed to provide reasonable protection against harmful interference in a residential installation. This equipment generates, uses and can radiate radio frequency energy and, if not installed and used in accordance with the instructions, may cause harmful interference to radio communications. However, there is no guarantee that interference will not occur in a particular installation. If this equipment does cause harmful interference to radio or television reception, which can be determined by turning the equipment off and on, the user is encouraged to try to correct the interference by one or more of the following measures:

- Reorient or relocate the receiving antenna.
- Increase the separation between the equipment and receiver.
- Connect the equipment into an outlet on a circuit different from that to which the receiver is connected.
- Consult the dealer or an experienced radio/TV technician for help.

**CAUTION:** Changes or modifications not expressly approved by the party responsible for compliance with the FCC Rules could void the user's authority to operate this equipment.

### Location of the required Marking

The rating sheet and the safety caution are on the rear of the unit.

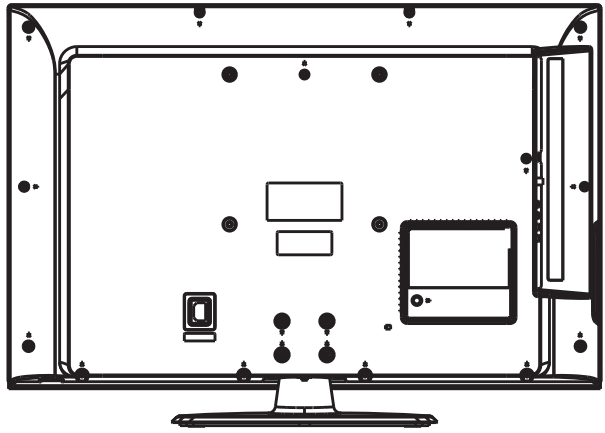

# IMPORTANT SAFETY INSTRUCTIONS

- 1) Read these instructions.
- 2) Keep these instructions.
- 3) Heed all warnings.
- 4) Follow all instructions.
- 5) Do not use this apparatus near water.
- 6) Clean only with dry cloth.
- 7) Do not block any ventilation openings. Install in accordance with the manufacturer's instructions.
- 8) Do not install near any heat sources such as radiators, heat registers, stoves, or other apparatus (including amplifiers) that produce heat.
- 9) Do not defeat the safety purpose of the polarized or grounding-type plug. A polarized plug has two blades with one wider than the other. A grounding type plug has two blades and a third grounding prong. The wide blade or the third prong are provided for your safety. If the provided plug does not fit into your outlet, consult an electrician for replacement of the obsolete outlet.
- 10) Protect the power cord from being walked on or pinched particularly at plugs, convenience receptacles, and the point where they exit from the apparatus.
- 11) Only use attachments/accessories specified by the manufacturer.
- 12) Use only with cart, stand, tripod, bracket, or table specified by the manufacturer, or sold with the apparatus. When a cart is used, use caution when moving the cart/apparatus combination to avoid injury from tip-over.
- 13) Unplug this apparatus during lightning storms or when unused for long periods of time.
- 14) Refer all servicing to qualified service personnel. Servicing is required when the apparatus has been damaged in any way, such as power-supply cord or plug is damaged, liquid has been spilled or objects have fallen into the apparatus, the apparatus has been exposed to rain or moisture, does not operate normally, or has been dropped.
- 15) Apparatus should not be exposed to dripping or splashing, and objects filled with liquids, such as vases, should not be placed on the apparatus.
- 16) An outside antenna system should not be located in the vicinity of overhead power lines or other electric light or power circuits, or where it can fall into such power lines or circuits. When installing an outside antenna system, extreme care should be taken to keep from touching such power lines or circuits, as contact with them might be fatal.
- 17) Do not overload wall outlets and extension cords, as this can result in a risk of fire or electric shock.
- 18) Do not push objects through any openings in this unit, as they may touch dangerous voltage points or short out parts that could result in fire or electric shock. Never spill or spray any type of liquid into the unit.
- 19) If an outside antenna or cable system is connected to the unit, be sure the antenna or cable system is grounded to provide some protection against voltage surges and built-up static charges, Section 810 of the National Electrical Code, ANSI/NFPA 70, provides information with respect to proper grounding of the mast and supporting structure, grounding of the lead-in wire to an antenna discharge unit, size of grounding conductors, location of antenna discharge unit, connection to grounding electrodes, and requirements for the grounding electrode.
- 20) When replacement parts are required, be sure the service technician uses replacement parts specified by the manufacturer or those that have the same characteristics as the original part.

Unauthorized substitutions may result in fire, electric shock or other hazards.
- 21) Upon completion of any service or repairs to this unit, ask the service technician to perform safety checks to determine that the unit is in proper operating condition.
- 22) When you connect the product to other equipment, turn off the power and unplug all of the equipment from the wall outlet. Failure to do so may cause an electric shock and serious personal injury. Read the owner's manual of the other equipment carefully and follow the instructions when making any connections.
- 23) Sudden high volume sound may cause hearing or speaker damage. When you use headphones, (if the unit is equipped with a headphone jack) keep the volume at a moderate level. If you use headphones continuously with high volume sound, it may cause hearing damage.

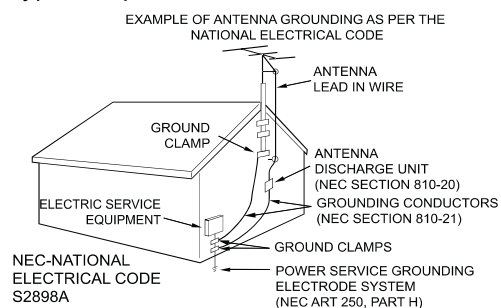

# IMPORTANT SAFETY INSTRUCTIONS (continued)

- 24) Do not allow the product to output distorted sound for an extended period of time. It may cause speaker overheating and fire.
- 25) This reminder is provided to call the cable TV system installer's attention to Article 820-40 of the NEC that provides guidelines for proper grounding and, in particular, specifies that the cable ground shall be connected to the grounding system of the building, as close to the point of cable entry as practical.
- 26) The socket-outlet must be installed near the unit and easily accessible.
- 27) The mains plug is used as the disconnect and shall remain readily operable.

## CONDENSATION

Moisture will form in the operating section of the unit if the unit is brought from cool surroundings into a warm room or if the temperature of the room rises suddenly. When this happens, unit's performance will be impaired. To prevent this, let the unit stand in its new surroundings for about an hour before switching it on, or make sure that the room temperature rises gradually. Condensation may also form during the summer if the unit is exposed to the breeze from an air conditioner. In such cases, change the location of the unit.

## HOW TO HANDLE THE LCD PANEL

- Do not press hard or jolt the LCD panel. It may cause the LCD panel glass to break and injury may occur.
- If the LCD panel is broken, make absolutely sure that you do not touch the liquid in the panel. This may cause skin inflammation. If the liquid gets in your mouth, immediately gargle and consult with your doctor. Also, if the liquid gets in your eyes or touches your skin, consult with your doctor after rinsing for at least 15 minutes or longer in clean water.

**Possible Adverse Effects on LCD Panel:** If a fixed (non-moving) pattern remains on the LCD Panel for long periods of time, the image can become permanently engrained in the LCD Panel and cause subtle but permanent ghost images. This type of damage is NOT COVERED BY YOUR WARRANTY. Never leave your LCD Panel on for long periods of time while it is displaying the following formats or images:

- Fixed Images, such as stock tickers, video game patterns, TV station logos, and websites.
- Special Formats that do not use the entire screen. For example, viewing letterbox style (16:9) media on a normal (4:3) display (black bars at top and bottom of screen); or viewing normal style (4:3) media on a widescreen (16:9) display (black bars on left and right sides of screen).

**The following symptoms are not signs of malfunction but technical limitation. Therefore we disclaim any responsibility for these symptoms.**

- LCD Panels are manufactured using an extremely high level of precision technology, however sometimes parts of the screen may be missing picture elements or have luminous spots. This is not a sign of a malfunction.
- Do not install the LCD Panel near electronic equipment that produces electromagnetic waves. Some equipment placed too near this unit may cause interference.
- Effect on infrared devices – There may be interference while using infrared devices such as infrared cordless headphones.

## Power source

This LCD television is designed to operate on 120 volts 60 Hz, AC current. Insert the power cord into a 120 volts 60 Hz outlet. To prevent electric shock, do not use the LCD television's plug with an extension cord, receptacle, or other outlet unless the blades and ground terminal can be fully inserted to prevent blade exposure. Never connect the LCD television to 50 Hz, direct current, or anything other than the specified voltage.

## Warning

To reduce the risk of fire or electric shock, do not expose this apparatus to rain or moisture.

## Caution

Never remove the back cover of the LCD television as this can expose you to very high voltages and other hazards. If the television does not operate properly, unplug the LCD television and call your authorized dealer or service center. Adjust only those controls that are covered in the instructions, as improper changes or modifications not expressly approved by Hitachi could void the user's warranty.



This product contains lead and one or more non-replaceable mercury backlights. Do not put in trash. Dispose of this product in accordance with applicable environmental laws. For product recycling and disposal information, contact your local government agency or [www.eRecycle.org](http://www.eRecycle.org) <<http://www.eRecycle.org>> (in California), the Electronic Industries Alliance at [www.eiae.org](http://www.eiae.org) <<http://www.eiae.org>> (in the US) or the Electronic Product Stewardship Canada at [www.epsc.ca](http://www.epsc.ca) <<http://www.epsc.ca>> (in Canada). For more information, call 1-888-333-1899.

This Class B digital apparatus complies with Canadian ICES-003 as a Standard Television Receiving Apparatus, Canada BETS-7/NTMR7.

## Declaration of Conformity

This device complies with part 15 of the FCC Rules. Operation is subject to the following two conditions:

(1) This device may not cause harmful interference and (2) This device must accept any interference received, including interference that may cause undesired operation.

For questions regarding this declaration, contact:

Hitachi America, Ltd.  
900 Hitachi Way  
Chula Vista, CA 91914-3556  
ATTN: Customer Relations

## CHILD SAFETY:

It Makes A Difference How and Where  
You Use Your Flat Panel Display

ENGLISH

Congratulations on your purchase!

As you enjoy your new product, please keep these safety tips on mind:



### HITACHI CARES!

- The consumer electronics industry is committed to making home entertainment enjoyable and safe.
- Please note the American Academy of Pediatrics discourages television viewing for children younger than two years of age.
- The home theater entertainment experience is a growing trend and larger flat displays are popular purchases. However, flat panel displays are not always supported on the proper stands or installed according to the manufacturer's recommendations.
- Flat Panel displays that are inappropriately situated on dresser, bookcases, shelves, desks, speakers, chest or carts may fall over and cause injury.

### TUNE INTO SAFETY

- One size does NOT fit all. Follow the manufacturer's recommendations for the safe installation and use of your flat panel display.
- Carefully read and understand all enclosed instructions for proper use of this product.
- Don't allow children to climb on or play with furniture and television sets.
- Don't place flat panel displays on furniture that can easily be used as steps, such as a chest of drawers.
- Remember that children can become excited while watching a program, especially on a "larger than life" flat panel display. Care should be taken to place or install the display where it cannot be pushed, pulled over, or knocked down.
- Care should be taken to route all cords and cables connected to the flat panel display so that they cannot be pulled or grabbed by curious children.

### WALL MOUNTING: IF YOU DECIDE TO WALL MOUNT YOUR FLAT PANEL DISPLAY, ALWAYS:

- Use a mount that has been recommended by the display manufacturer and/or listed by an independent laboratory (such as UL, CSA, ETL).
- Follow all instructions supplied by the display and wall mount manufacturers.
- If you have any doubts about your ability to safely install your flat panel display, contact your retailer about professional installation.
- Make sure that the wall where you are mounting the display is appropriate. Some wall mounts are not designed to be mounted to walls with steel studs or old cinder block construction. If you are unsure, contact a professional installer.
- A minimum of two people are required for installation. Flat panel displays can be heavy.



# SAFETY PRECAUTIONS

The unit emits heat when in operation. Do not place any covers or blankets on the unit, this may cause overheating. Do not block ventilation holes, or set up near radiators. Do not place in direct sunlight. When placing on a shelf leave 4 inches (10 cm) free space around the entire unit.

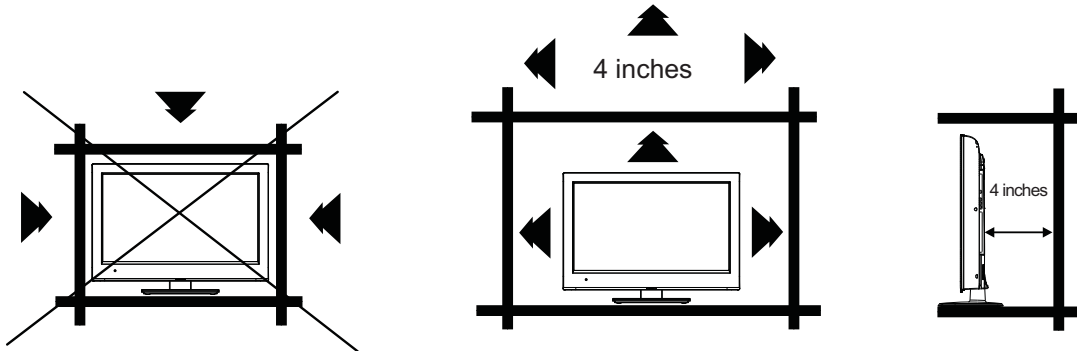

## Notes when mounting the LCD TV on a wall

If the unit is to be mounted on the wall, contact the retailer where you purchased the LCD TV for advice, and have the equipment professionally installed. Incomplete or improper installation may cause injury to you, and/or damage to the LCD TV.

The screws ISO M6 thread type should be used. The insertion length must be within 12 - 16mm.

If the insertion length is less than 12mm, the weight can not be maintained.

If the insertion length is more than 16mm, a space is created between the Wall Mount Bracket and the Television.

(Insertion Length) = (Screw Length) - (Washers Thickness) - (Mounting Bracket Thickness)

## Securing to a Wall

1. Use metallic wire, clamp and screw (not provided) on the rear of the LCD TV as shown below.
2. Use proper hardware (drywall anchor, masonry screw, etc) to secure other end of wire to wall.

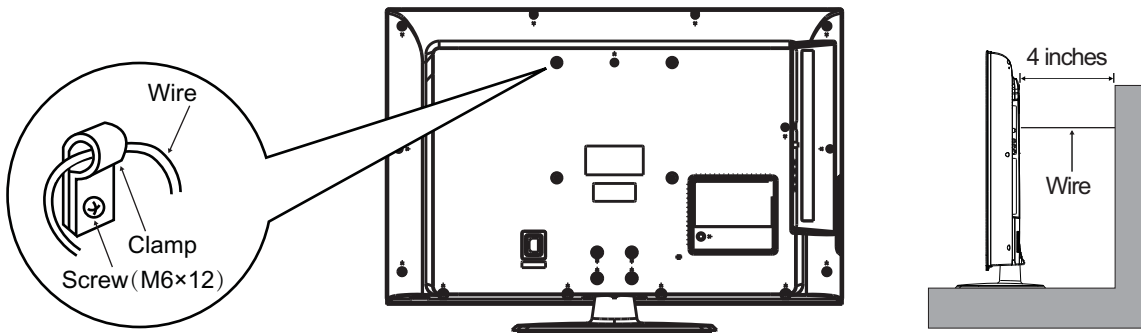

## NOTICE FOR TV CABINET

If the unit is to be mounted on a cabinet smaller than the length of the unit, it could result in an unstable location and the unit may tumble over, making a risk of personal, possibly fatal injury. Also, this would damage the product seriously. Accordingly, Hitachi accepts no responsibility or liability for any injuries or property damage resulting from the improper installation.

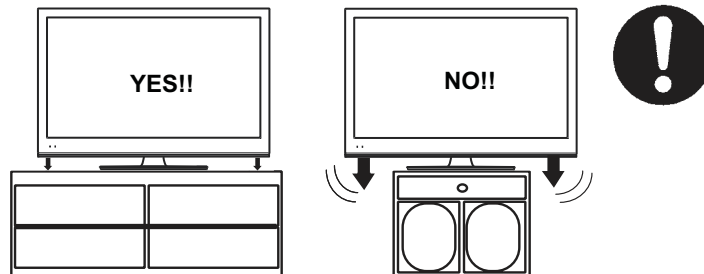

# How to attach the stand

## NOTES

- The below figures are for reference only, please refer to the actual units to determine the appearances.  
Every hole of the pedestal must be fastened with screws!

1. Lay the soft cloth on a table which can hold the weight of the whole TV.
2. Put the TV on the cloth with its back upwards and the LCD downwards.
3. Take out the pedestal, and insert the pedestal into the TV then put the pedestal to relevant position of the TV set, until all the holes match each other completely.
4. Fasten the pedestal and the TV set together with screws.
5. Erect the TV set, and put it on the proper position for watching.

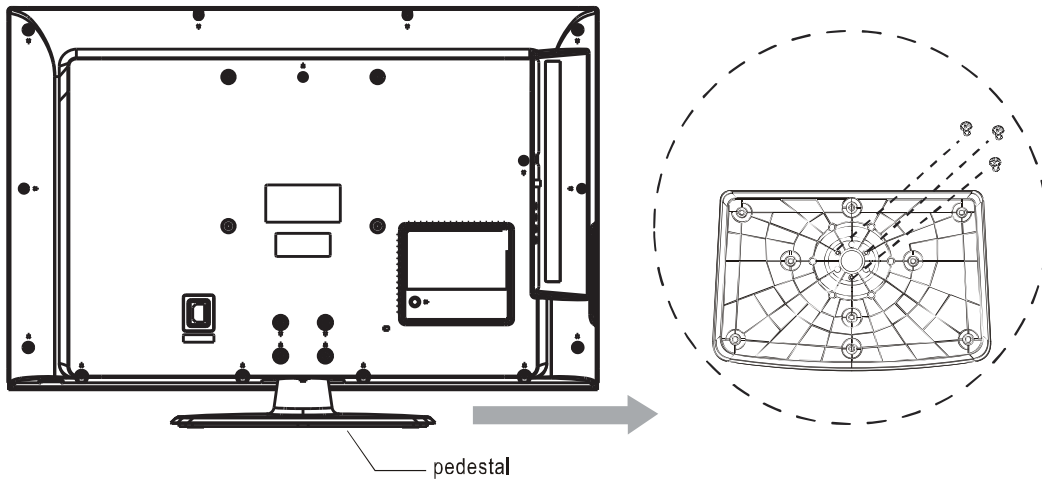

# How to remove the stand

When you transport this product, remove the stand and pack flat against the back of the unit in the carton. To remove the stand, perform above steps in reverse order.

# Features

## LCD color TV

Unique space saving design combines a 32" class LCD color TV.

- **Integrated Digital Tuner** - You can view digital broadcasts without using a Digital TV Set-Top Box.
- **Closed Caption Decoder With Full Text Mode** - Displays text captions or full screen text on the screen for hearing impaired viewers.
- **Picture Adjustments Using The Remote Control** - The On-Screen display allows precise remote control adjustment of BRIGHTNESS, CONTRAST, COLOR, TINT and SHARPNESS.
- **Programmable TV Sleep Timer** - Operable from the remote control, the TV can be programmed for up to 120 minutes to turn off automatically.
- **On-Screen 3 Language Display** - You can select one of 3 languages, English, Spanish or French for on-screen programming
- **Parental Control** - The Parental Control function can read the rating of a TV program or movie content if the program is encoded with this information. Parental Control will allow you to set a restriction level.

This LCD Television receiver will display television closed captioning, ( **CC** or **□** ), in accordance with paragraph 15.119 and 15.122 of the FCC rules.

- \* HDMI, the HDMI Logo, and High-Definition Multimedia Interface are trademarks or registered trademarks of HDMI Licensing LLC in the United States and other countries.
- \* Manufactured under license from Dolby Laboratories. Dolby and the double-D symbol are trademarks of Dolby Laboratories.
- \* VGA and XGA are trademarks of International Business Machines Corporation.
- \* VESA is a registered trademark of the Video Electronics Standard Association.

## Power source

### TO USE AC POWER

Connect the AC cord into an AC outlet.

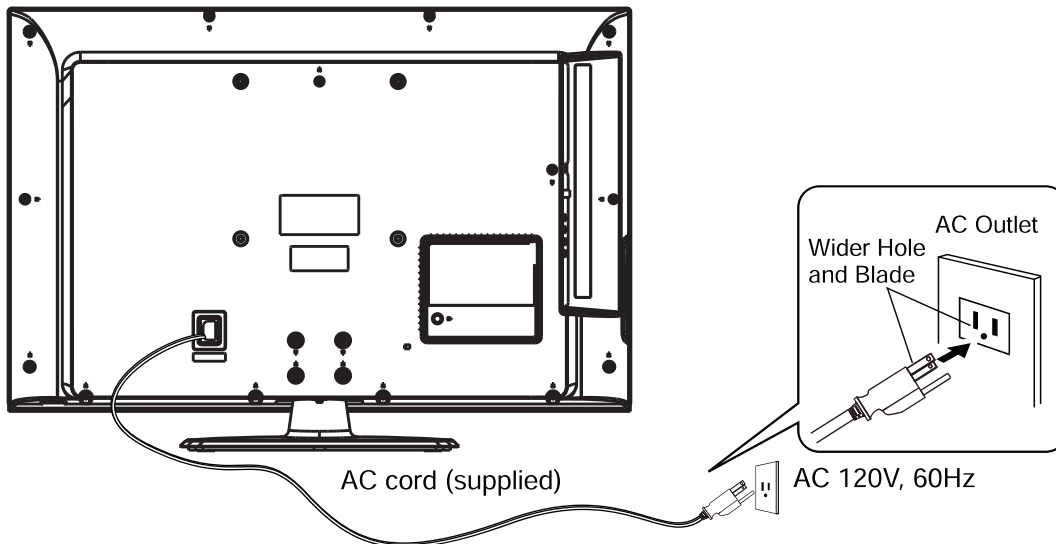

### NOTES

- Please make sure to insert the cord securely at both the LCD TV and to the wall outlet.
- The AC Cord has a grounding type AC line plug. If the supplied AC cord does not match your AC outlet, contact a qualified electrician.

### WARNING:

- Do not connect this unit to the power using any device other than the supplied AC cord. This could cause fire, electrical shock, or damage.
- Do not use with a voltage other than the power voltage specified. This could cause fire, electrical shock, or damage.

### CAUTION:

- When this unit is not used for a long time, (e.g., away on a trip) in the interest of safety, be sure to unplug it from the AC outlet.
- Do not plug/unplug the AC cord when your hands are wet. This may cause electrical shock.



## Before using your unit

IMPORTANT SAFETY INSTRUCTIONS .....	2
CHILD SAFETY NOTICE .....	5
SAFETY PRECAUTIONS .....	6
How to attach the stand .....	7
How to remove the stand .....	7
Features .....	8
Power source .....	8
Contents .....	9
Location of controls .....	10
Remote control .....	11
Antenna connections .....	12
Cable TV connections .....	12

## TV operation

Starting setup .....	13
Using the Channels Menu .....	14
Using the Video Menu .....	14
Using the Audio Menu .....	15
Using the Setup Menu .....	15
Using the Parental Controls Menu .....	17

## Additional information

Connections to other equipment .....	19
Troubleshooting .....	22
Specifications .....	23
LIMITED WARRANTY .....	24
End User License Agreement .....	26
Appendixes .....	28

# Location of controls

## Front

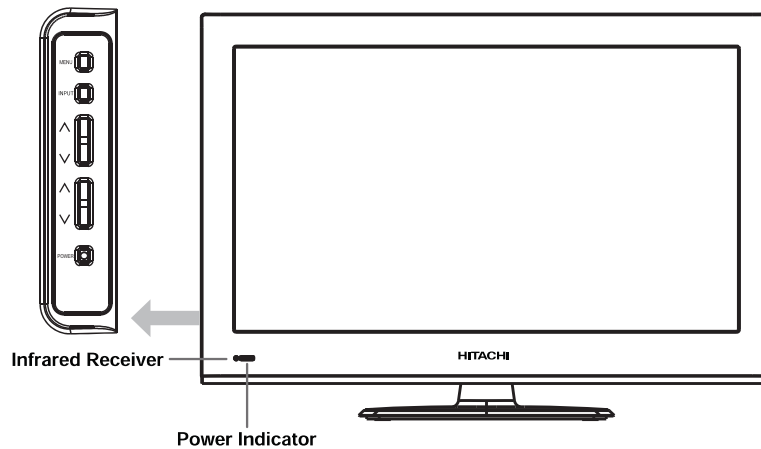

Item	Description
IR (Infrared Receiver)	Receives IR signals from the remote control. Do not put anything near the sensor, as its function may be affected.
POWER LED	Illuminates red when the TV is in standby mode and flashes for a few seconds when you turn on the TV, then illuminate blue.
MENU	Displays the OSD (on screen display) menu.
INPUT	Select among the different input signal sources.
VOL $\wedge$ $\vee$	Adjust the volume. Select sub-menu and adjust setting in OSD menus.
CH $\wedge$ $\vee$	Select a channel. Select items of OSD menu.
POWER	Switch the TV on from standby. Switch the TV back to standby.

## Rear

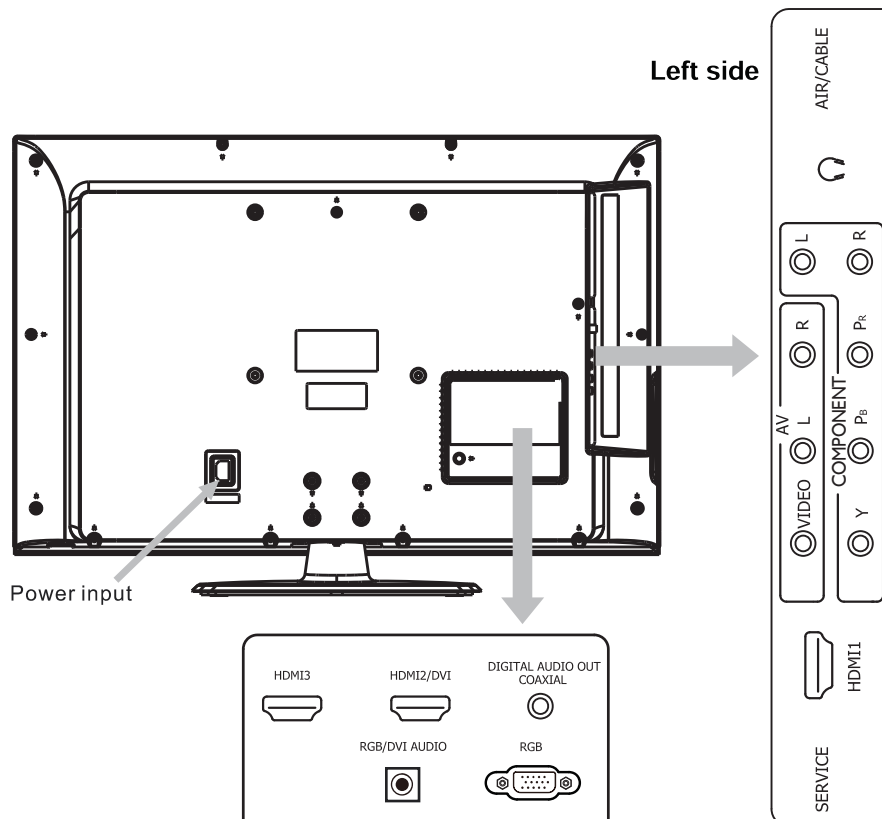

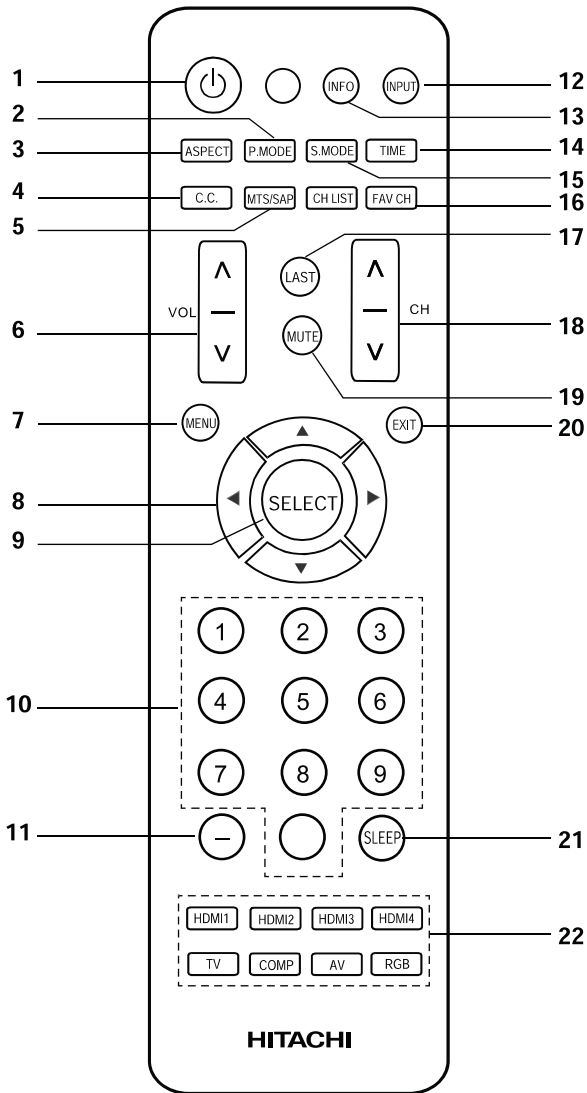

1. **POWER Button** - Press to turn the LCD TV's power on/off.
2. **P.MODE**-Picture mode selecting button.
3. **ASPECT Button** - Press to change the picture size.
4. **C.C. Button** - Used to turn on/off the Closed Captions.
5. **MTS/SAP Button** - Press to change the audio language.
6. **VOL (VOLUME) ^ / v Buttons** - Press the ^ button to increase, or the v button to decrease the sound level.
7. **MENU Button** - Press to display the On-Screen menu.
8. **CURSOR ▲/▼/◀/▶ Buttons** - Use to navigate and select menu functions of the LCD TV.
9. **SELECT Button** - Press to enter or select functions for the On-Screen menu.
10. **Direct Channel Selection Buttons (0-9)** - Allows direct access to any channel of the LCD TV.
11. **- Button** - This button is the "-" button used when selecting digital channels.
12. **INPUT Button** - Press to change the TV's input.
13. **INFO Button** - When you press this button, the current information will be displayed on the screen.
14. **TIME Button** - Press to display the time.
15. **S.MODE**-Sound mode selecting button.

16. **FAV CH** - Press to display favorite channels.
17. **LAST Button** - Pressing this button allow you to go back to the previous channel selected. Press this button again to return to the channel you were watching.
18. **CH (CHANNEL) ^ / v Buttons** - Press to change the channels of the TV.
19. **MUTE Button** - To turn off the sound, press this button once. The LCD TV will be silenced and the mute icon will appear on the screen. The muting feature can be released by pressing the **MUTE** button again or by pressing either of the **VOL (VOLUME) ^** or **v** buttons.
20. **EXIT Button** - Press to exit the On-Screen menu.
21. **SLEEP Button** - To set the LCD TV to turn off after a preset amount of time, use the **SLEEP** button on the remote control.
22. **Direct Input Key Buttons** - Press to go to the HDMI / TV / COMP /AV / RGB.(There is no function for the HDMI4 key on this model.)

Before using the remote control, batteries must first be installed.

## HOW TO INSTALL BATTERIES

1. Open the battery compartment cover.



2. Install two "AAA" batteries (supplied).

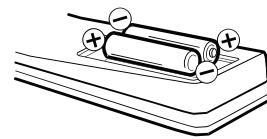

3. Replace the battery compartment cover.

Use two "AAA" size batteries. The batteries may last approximately one year depending on how much the remote control is used. For best performance, it is recommended that batteries should be replaced on a yearly basis, or when the remote operation becomes erratic. Do not mix old and new batteries or different types.

## BATTERY PRECAUTIONS

These precautions should be followed when using batteries in this device:

- Use only the size and type of batteries specified.
- Be sure to follow the correct polarity when installing the batteries as indicated in the battery compartment. Reversed batteries may cause damage to the device.
- Do not mix different types of batteries together (e.g. Alkaline and Carbon-zinc) or old batteries with fresh ones.
- If the device is not to be used for a long period of time, remove the batteries to prevent damage or injury from possible battery leakage.
- Do not try to recharge batteries not intended to be recharged; they can overheat and rupture. (Follow battery manufacturer's directions.)
- Please use caution when inserting batteries to avoid battery damage. If the spring terminal in the remote control remains in contact with a side of a damaged battery it can cause a short circuit. Never use damaged batteries as they can become very hot and are dangerous.

# Antenna connections

If you are using an indoor or outdoor antenna, follow the instructions below that correspond to your antenna system. If you are using a Cable TV service, see Cable TV connections.

## Combination VHF/UHF Antenna (Single 75 ohm cable)

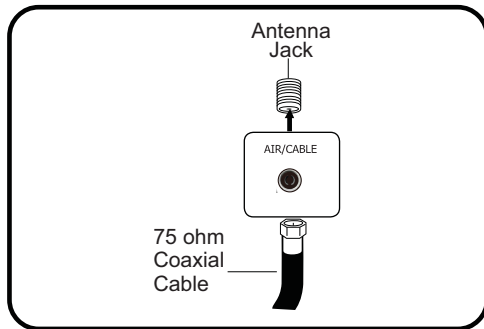

## Cable TV connections

This TV has an extended tuning range and can tune most cable channels without using a Cable TV Converter box. Some cable companies offer "premium pay channels" where the signal is scrambled. Descrambling these signals for normal viewing requires the use of a descrambler device which is generally provided by the Cable TV company.

### For subscribers to basic Cable TV service

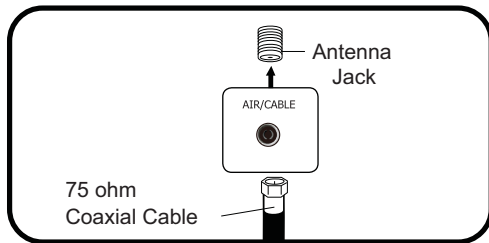

For basic Cable TV service not requiring a Converter/Descrambler box, connect the 75 ohm Coaxial Cable directly to the Antenna Jack on the back of the TV.

### For subscribers to scrambled Cable TV service

If you subscribe to a Cable TV service which requires the use of a Converter/Descrambler box, connect the incoming 75 ohm Coaxial Cable to the Converter/Descrambler box. Using another 75 ohm Coaxial Cable, connect the output jack of the Converter/Descrambler box to the Antenna Jack on the TV. Follow the connections shown below. Set the TV to the output channel of the Converter/Descrambler box (usually channel 3 or 4) and use the Converter/Descrambler box to select channels.

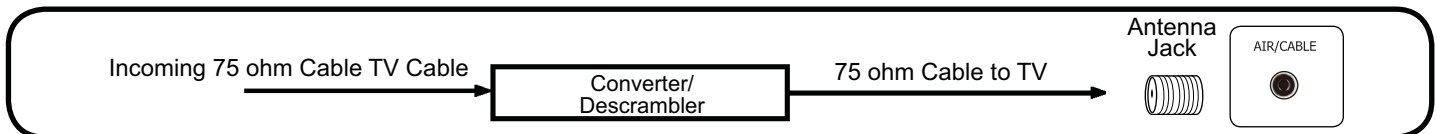

### For subscribers to unscrambled Cable TV service with scrambled premium channels

If you subscribe to a Cable TV service in which basic channels are unscrambled and premium channels require the use of a Converter/Descrambler box, you may wish to use a signal Splitter and an A/B Switch box (available from the Cable TV company or an electronics supply store). Follow the connections shown below. With the switch in the "B" position, you can directly tune any unscrambled channels on your TV. With the switch in the "A" position, tune your TV to the output of the Converter/Descrambler box (usually channel 3 or 4) and use the Converter/Descrambler box to tune scrambled channels.

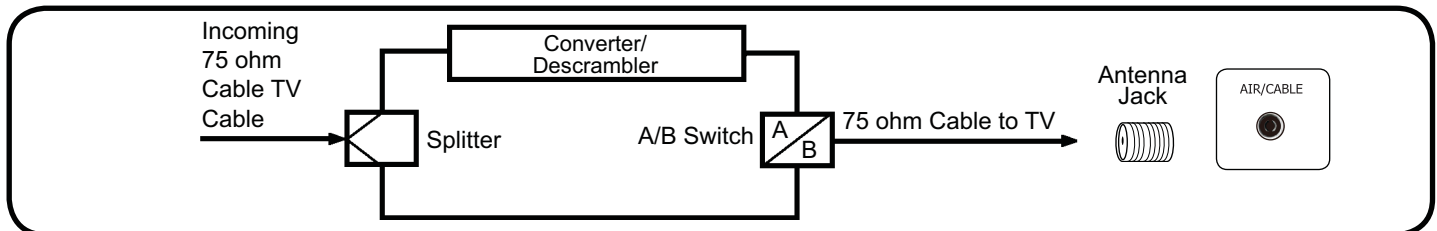

# Starting setup

The Setup Wizard appears the first time you turn on the TV. It will assist you to specify the Air/Cable setting and program your channels automatically.

**IMPORTANT:** Make sure that the antenna or cable TV system connection is made.

- 1 To turn on the TV, touch **POWER** (POWER indicator on the front of the unit changes blue. It may take approx. 10 seconds for a picture to appear on screen.). The Setup Wizard function begins.

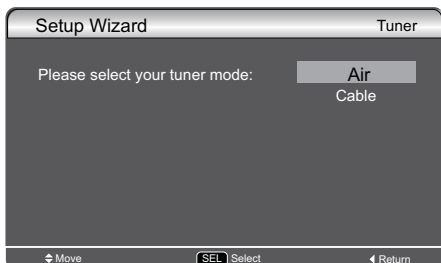

- 2 Press **▲** or **▼** to select "Source", then press **◀** or **▶** to select "Cable" or "Air".
- 3 Press **▲** or **▼** to select "Scan", then press **▶** or **SELECT**.
- 4 "Setup Wizard" will begin. After the Setup Wizard is completed, the TV channel appears on the screen.
  - Depending on the reception condition, it may take up to 25 minutes or more to complete memorizing digital cable channels. Please allow the process to complete without interruption.

## NOTE

- If you press **EXIT** in the process of "Setup Wizard", the Setup Wizard stops and changes to the normal screen. When you make a menu selection, your changes occur immediately. You do not have to press **EXIT** to see your changes.

# TV operation

- 1 To turn on the TV, press **POWER**. (POWER indicator on the front of the unit changes blue. It may take approx. 10 seconds for a picture to appear on screen.)
- 2 Adjust the volume level by pressing **VOL ▲** or **▼**. The volume level will be indicated on the screen by volume bars. As the volume level increases, so do the number of bars. If the volume decreases, the number of volume bars also decreases.
- 3 Set the Source option to the appropriate position.
- 4 Press the **Direct Channel Selection (0-9, -)** buttons to select the channel. (If you press only the channel number, channel selection will be delayed for a few seconds.)

## TO SELECT ANALOG CHANNELS

- 1-9: Press 1-9 as needed. Example, to select channel 2, press **2**, then press **SELECT**.
- 10-99: Press the 2 digits in order. Example, to select channel 12, press **1, 2**, then press **SELECT**.
- 100-135: Press the 3 digits in order. Example, to select channel 120, press **1, 2, 0**, then press **SELECT**.

## TO SELECT DIGITAL CHANNELS

Press the first 1-3 digits, then press the **-** button followed by the remaining number.

Example, to select channel 15-1, press **1, 5, -, 1**, then press **SELECT**.

- If a channel is selected with only audio content, "Audio only" will be displayed on the screen.
- If a channel is selected with a weak digital signal, "Weak Signal or Channel not available." will be displayed on the screen.
- The same program may be available on either an analog channel or a digital channel. You may choose to watch either format.
- If a channel is selected to which you have not subscribed, "Scrambled" will be displayed on the screen.

## VHF/UHF/CABLE CHANNELS

Air	Cable
VHF 2-13	VHF 2-13
UHF 14-69	CATV 1-125 Digital Terrestrial Broadcast(8VSB):2-69 Digital cable(64/256 QAM):1-135

## NOTES

- If a channel with no broadcast is selected, the sound will automatically be muted.
- It may take a few seconds for a digital channel picture to appear on screen after being selected.

## To select the video input source

To view a signal from another device connected to your LCD TV, such as a VCR player, press **INPUT**, then press **▲** or **▼**, then press **SELECT**. You can select TV, Video, Component, HDMI or RGB depending on which input jacks you used to connect your devices.

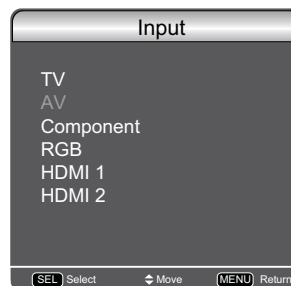

## CH ▲/▼

Press and release **CH ▲/▼**. The channel automatically stops at the next channel set into memory.

For proper operation, before selecting channels, they should be set into the memory. Refer to the Channels Menu on page 14.

# Using the Channels Menu



- 1 Press Menu button to display the main menu.
- 2 Press ▲ or ▼ button to select Channels.
- 3 Press ► or **SELECT** button to enter Channels menu.
- 4 Press ▲ or ▼ button to select the option, press ► or **SELECT** button to enter or press **EXIT** button to exit.
- 5 When you are finished, press the **EXIT** button to close the menu.

### You can adjust:

- Source - Select the TV signal source. You can select Air or Cable.
- Channel Scan - Scans for channels that have signals and stores the channels information in memory.

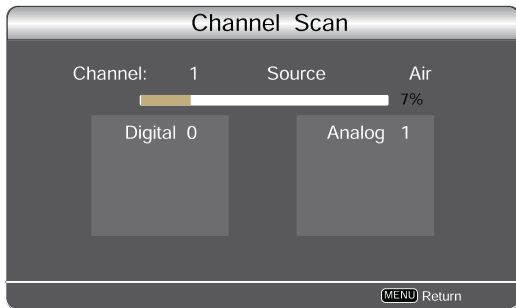

DTV: The scanned TV programs in digital signals.

TV: The scanned programs in analog signals.

- Channel Skip - Deletes a channel stored in memory. When you press CH▲ or CH▼, your TV skips the channel you deleted. You can still tune to the channel using the number buttons on the remote control.

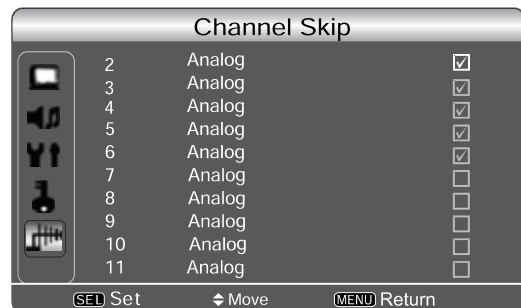

- Favorite CH List - Selects or cancel the favorite programs.
- MTS - Selects the sound mode. You can select Mono, Stereo, or SAP(Second Audio Program).
- Preferred Language - Selects your preferred language as the audio default language. This setting is only for digital channels.

# Using the Video Menu

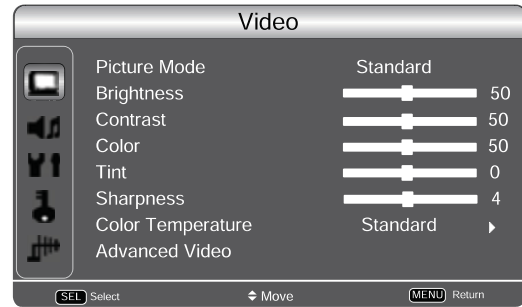

- 1 Press Menu button to display the main menu.
- 2 Press ▲ or ▼ button to select Video.
- 3 Press ► or **SELECT** button to enter Video menu.
- 4 Press ▲ or ▼ button to select the option, press ► or **SELECT** button to enter or press **EXIT** button to exit.
- 5 When you are finished, press the **EXIT** button to close the menu.

### You can adjust:

- Picture Mode - Adjusts the Picture Mode. You can select Dynamic, Standard, Movie, or Custom.
- Brightness - Use this function to change the overall brightness of the dark areas of this picture.
- Contrast - Use this function to change the contrast between black and white level in the picture.
- Color - Use this function to adjust the level of color in the picture.
- Tint - Use this function to adjust flesh tones so they appear natural.
- Sharpness - Use this function to adjust the amount of fine detail in the picture.
- Color Temperature - Set this to High for cooler color with more blue, set to Warm for a more natural color or set to Standard for accurate color.
- Advanced Video - Accesses advanced video settings such as Noise Reduction.

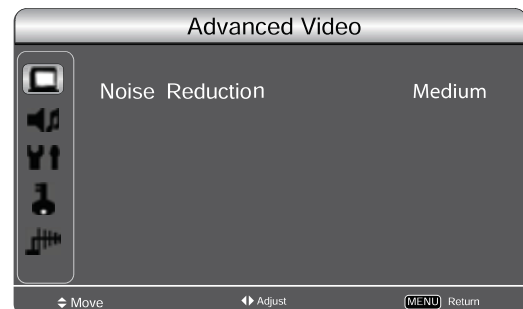

- Noise Reduction: It can optimize the picture signal from time and space; reduce the outside noise interference and return the pure initial signal. It has four ratings: Low, Medium, High and Off.

# Using the Audio Menu

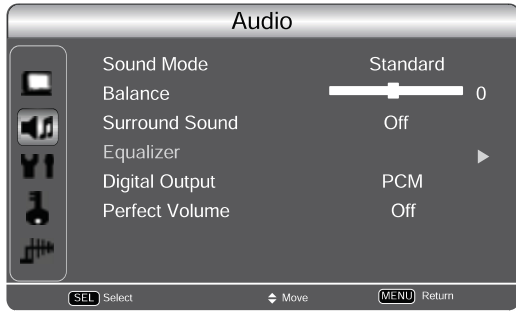

- 1 Press Menu button to display the main menu.
- 2 Press ▲ or ▼ button to select Audio.
- 3 Press ► or **SELECT** button to enter Audio menu.
- 4 Press ▲ or ▼ button to select the option, press ► or **SELECT** button to enter or press **EXIT** button to exit.
- 5 When you are finished, press the **EXIT** button to close the menu.

**You can adjust:**

- Sound mode - Select the sound mode. It can be Standard, Speech, Custom, Music.
- Balance - Adjusts the volume of the left and right speakers.
- Surround Sound - Turns the surround sound effect on or off.

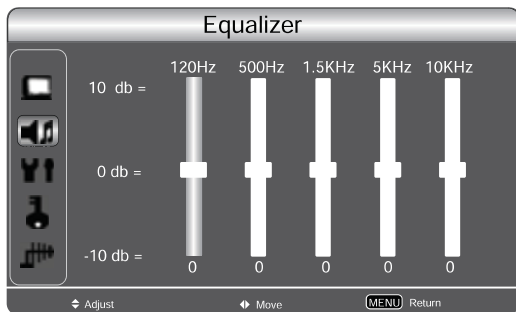

- Equalizer - Weaken or enlarge the sound of the main frequency points.
- Digital Output - Selects the item, you can select PCM, RAW or Off.  
 PCM - PCM is an encoding, mainly used for analog signal, Dolby mainly used for digital signal.  
 RAW - When the data stream carries Dolby signal, digital audio outputs Dolby data stream. When the data stream carries no Dolby signal, it transports PCM data stream.  
 Off - Select to turn off Digital Audio Output
- Perfect Volume - This function will automatically adjust volume so each channel and input has the same average volume level.

# Using the Setup Menu

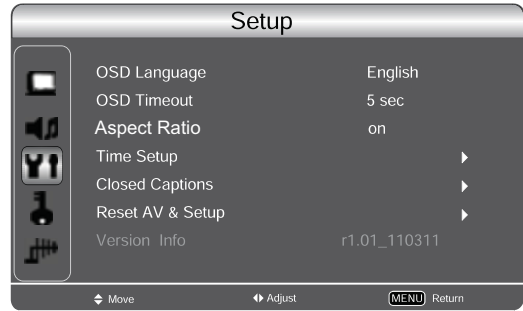

- 1 Press Menu button to display the main menu.
- 2 Press ▲ or ▼ button to select Setup .
- 3 Press ► or **SELECT** button to enter Setup menu.
- 4 Press ▲ or ▼ button to select the option, press ► or **SELECT** button to enter or press **EXIT** button to exit.
- 5 When you are finished, press the **EXIT** button to close the menu.

**You can adjust:**

- OSD Language - Use the right or left arrow button to choose the OSD Language among English, Spanish and French.
- OSD Timeout - Selects the lasting time of OSD. You can choose the time from 5 sec to 60 sec.
- Aspect Ratio - Use the arrow button to choose the screen aspect ration from 16:9, 4:3, Zoom, Cinema, Dot-to-Dot.

- 1 4:3  
 The original 4:3 aspect ratio is preserved, so black bars are added to the left and right of the image.  
 Standard TV broadcasts are displayed with a 4:3 aspect ratio.

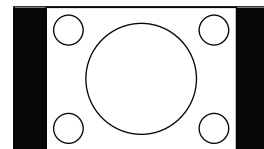

- 2 16:9  
 When watching a standard broadcast or full-frame movie in this mode, the display image is stretched proportionately to fill the TV screen.  
 When watching a widescreen program or movie, the display image fills the TV screen.

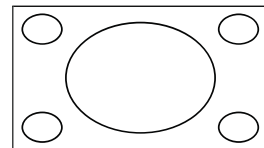

- 3 Zoom  
 Stretches the 4:3 aspect ratio image vertically and horizontally to fill the screen.

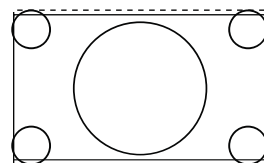

# Using the Setup Menu

## 4 Cinema

Stretches the 4:3 aspect ratio image vertically and horizontally to fill the screen.

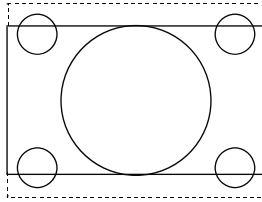

## 5 Dot to dot

Use the function to see the full image without any cutoff, when TV in RGB source.

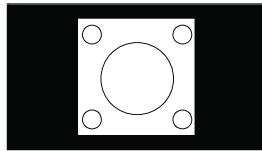

- PC Standby - This is a good function for a computer monitor. When PC Standby is on, the computer will control the screen on or off. For example, if the computer is in sleep mode, the screen will be switched off. If the computer is activated, the screen also is activated. ("PC Standby" being only available in RGB input.)
- Time Setup - You can set up the exact time by yourself. You can also set up Sleep Timer, Auto Synchronization, and Timer.

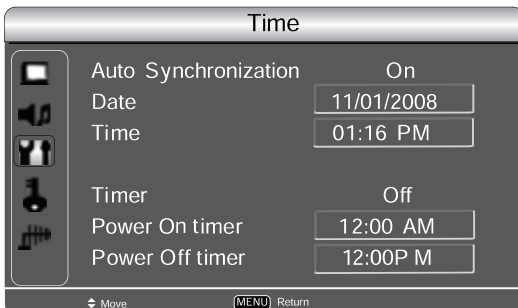
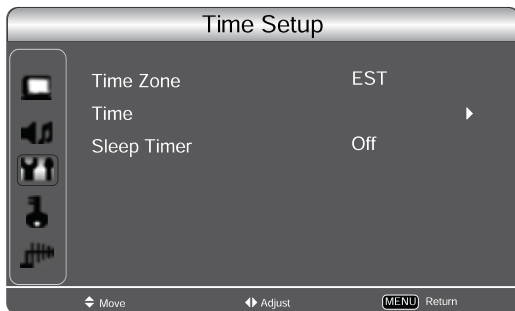

- Closed Captions - Analog Closed Caption, Digital Closed Caption and Digital Caption Style. Display available analog and digital closed captions or modify the appearance of digital closed captions.

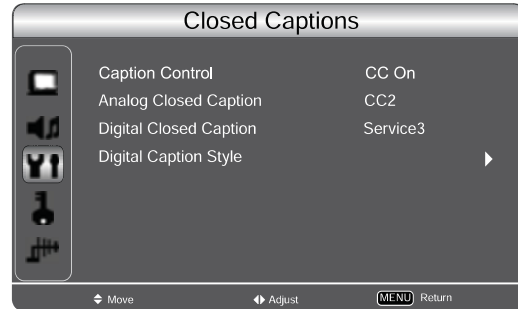

Caption Control: CC On , CC Off, CC On When Mute.

Analog Closed Caption: CC1,CC2,CC3,CC4, TEXT1,TEXT2,TEXT3,TEXT4.

Digital Closed Caption: Service1, Service2, Service3, Service4, Service5, Service6.



- Digital Caption Style - There are two Caption Styles. One is the automatic function set as the broadcaster, while the other is the custom style where you can adjust the font size, color, opacity, background color etc., accordingly.
- Reset AV & Setup - Every TV has its original setting before leaving the factory. So this function helps you restore these settings.



# Using the Parental Controls Menu

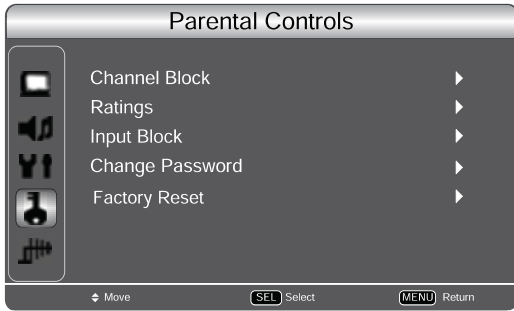

- 1 Press Menu button to display the main menu.
- 2 Press ▲ or ▼ button to select Parental Controls.
- 3 Press ► or **SELECT** button to enter Parental Controls menu.
- 4 Press ▲ or ▼ button to select the option, press ► or **SELECT** button to enter or press **EXIT** button to exit.
- 5 When you are finished, press the **EXIT** button to close the menu.

When you first use this function, the default password is [0000]. Once you input this password, you can: Press ▲ or ▼ to highlight an option, then press ◀ or ▶ to adjust the option.

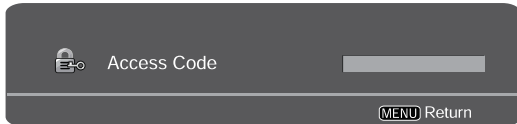

## You can adjust:

- Channel Block - This function will let you block any channel you want.

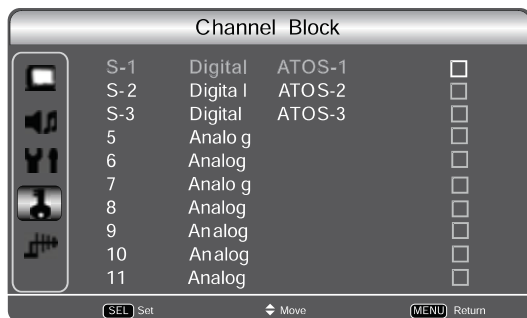

- Factory Reset - This function will reset your TV to the factory settings.

## NOTE

If you choose this function, all the programs you preset will be lost, and you will have to complete the "Setup Wizard" again. Refer to Starting Setup on page 13.

- Input Block - You can block the input source with this function. For example, if you want to block AV input, just highlight **AV** and press **SELECT**. The AV input will not be seen in the screen.

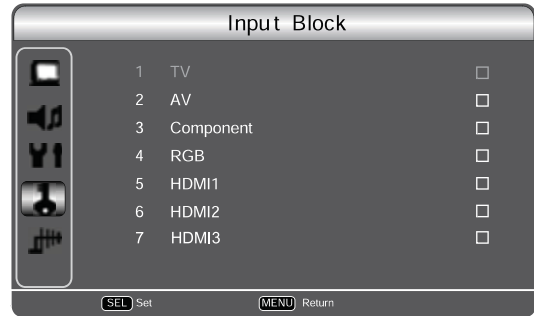

- Ratings-
  - A. Rating Enable is on.
  - B. U.S. TV Ratings: You can choose TV ratings according to the illustration on the screen.
  - C. The settings for U.S. Movie Ratings, Canada (English) Ratings and Canada (French) Ratings follow Step B. If you want to block the unrated program, please turn on this function.
  - D. In order to set Region 5 Ratings the ATSC digital channel received must include region.
  - E. If you want to block the unrated program, please turn on this function.



- Change Password - The first time you use this function, use the default password. If you want to change it, first enter the new password then enter the same password again.
- If you forget your password, use the factory password 7777, you can then gain access to change your password if necessary.

# Using the Parental Menu

The following are descriptions of the ratings.

## TV Parental Guide Ratings

Age	Defined as
TV-Y	All children
TV-Y7	Directed to older children
TV-G	General audience
TV-PG	Parental Guidance suggested
TV-14	Parents Strongly cautioned
TV-MA	Mature Audience only

Contents	Defined as
FV	Fantasy Violence
D	Suggestive dialogue
L	Strong language
S	Sexual situations
V	Violence

## Motion Picture Ratings

Rating	Defined as
G	General audience
PG	Parental Guidance suggested
PG-13	Parents strongly cautioned
R	Restricted
NC-17	No one 17 and under admitted
X	Adult audience only

## Canadian Rating (ENG)

Rating	Description
C	Children
C8+	Children eight years and older
G	General Programming, suitable for all audiences
PG	Parents Guidance
14+	Viewers 14 years and older
18+	Adult programming

## Canadian Rating (FRN)

Rating	Description
G	General
8 ans+	8+General; Not recommended for young children
13 ans+	Programming may not be suitable for children under the age of 13
16 ans+	Programming is not be suitable for children under the age of 16
18 ans+	Programming restricted to adults

**NOTE:** As you block ratings, all ratings higher than the ones you select are blocked as well. For example, if you choose to block the MPAA rating R, the higher ratings, NC-17 and X, are automatically blocked too.

# Connections to other equipment

The exact arrangement you use to interconnect various video and audio components to this unit is dependent on the model and features of each component. Check the Owner's Manual provided with each component for the location of video and audio inputs and outputs.

## To connect the LCD TV to a VCR

### Back of the unit

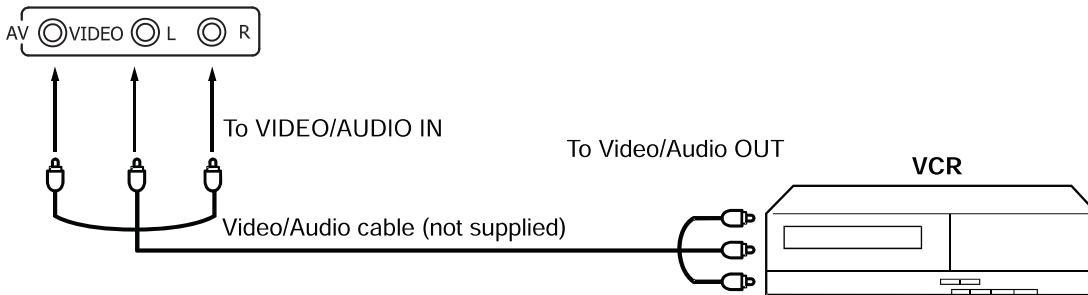

## To connect to a DVD player with Component Video Input

You can enjoy a high quality picture by connecting the unit's COMPONENT VIDEO OUT jacks of your DVD player with the COMPONENT video cables (not supplied).

### Back of the unit

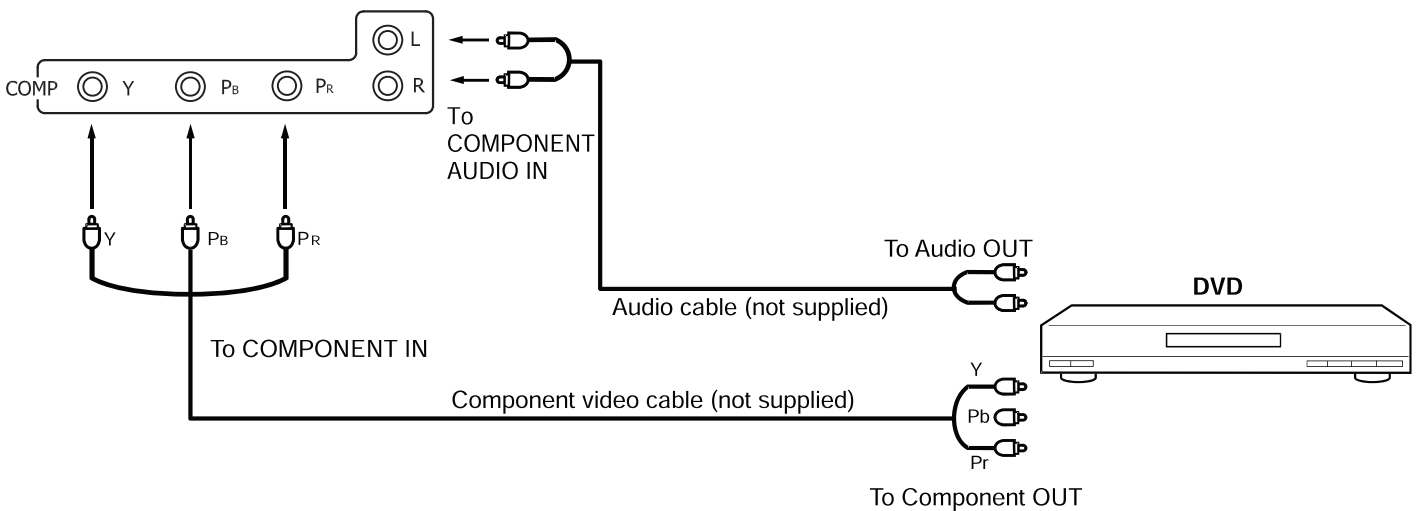

### NOTE

- Component Video input of the unit are for use with a device which output 480i/1080i interlaced signals and 480p/720p progressive signals.

## To connect a HDMI or a DVI device to the unit

The HDMI/DVI input receives digital audio and uncompressed video from a HDMI device or uncompressed digital video from a DVI device.

When you connect to a DVI device with a HDMI-to-DVI adapter cable, it transfers only video signal. Separate analog audio cables are required.

### Back of the unit

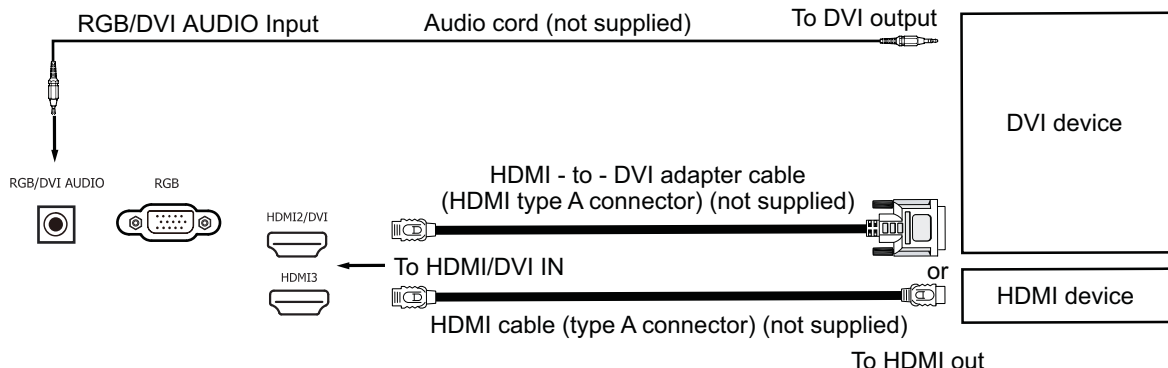

When using a HDMI input from a Set-Top-Box, it is recommended to use a 1080p, 1080i or 720p input signal. When the HDMI input is a 1080p signal, it is recommended that the length of the cable should be less than 5 meters.

## Using an AV Amplifier with built-in digital surround

If you are using an Amplifier with built-in digital surround sound, you can enjoy various audio systems including Dolby Digital Surround audio that sounds just like the movie.

Connect an AV amplifier with built-in Dolby Digital decoder, DTS decoder, or MPEG decoder etc. as shown below.

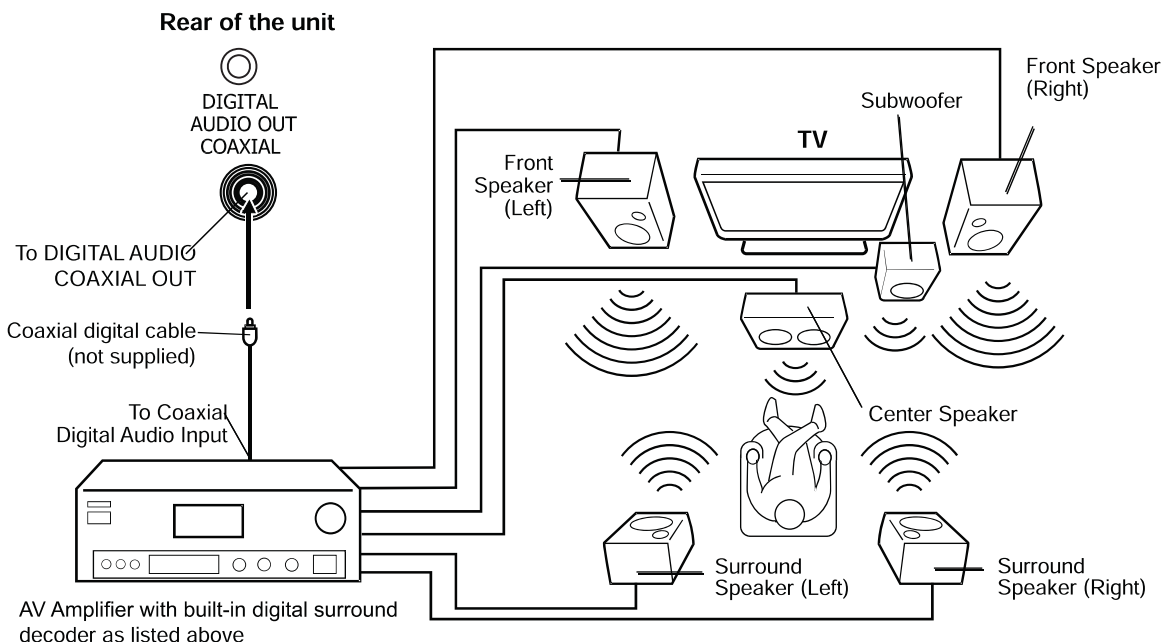

### NOTE

- When you are viewing digital broadcast, this unit will not work in conjunction with DTS audio or MPEG audio. There will be no sound output if connected to an AV amplifier with a built-in DTS decoder or MPEG decoder.

### To connect the TV to a camcorder or a game console

To play back from a camcorder, connect to the unit as shown.

This unit can also be used as a display device for many video games. However, due to the wide variety of signals generated by these devices and subsequent hook-up variations required, they have not all been included in the suggested connection diagrams. You'll need to consult each component's Owner's Manual for additional information.

#### Back of the unit

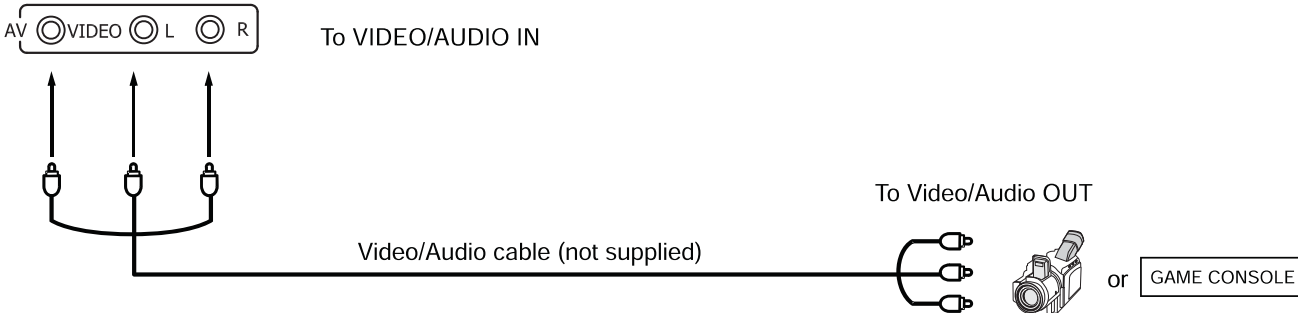

### To connect the TV to a PC (Personal Computer)

Connect one end of a (male to male) VGA cable to the video card of the computer and the other end to the VGA connector RGB Input on the rear of the TV. Attach the connectors firmly with the screws on the plug. In case of a Multimedia computer, connect the audio cable to the audio output of your Multimedia computer and to the AUDIO connector of the RGB/DVI AUDIO Input jack of the TV. You can also connect the PC with HDMI cable. If you use a HDMI cable, you don't have to connect the audio cable. If you use a DVI-to-HDMI cable, please connect the audio cable in the same way as the RGB cable. Press **INPUT** on the remote control to select RGB mode. Switch on the computer. The TV can operate as the computer monitor.

#### Left and Rear of the unit

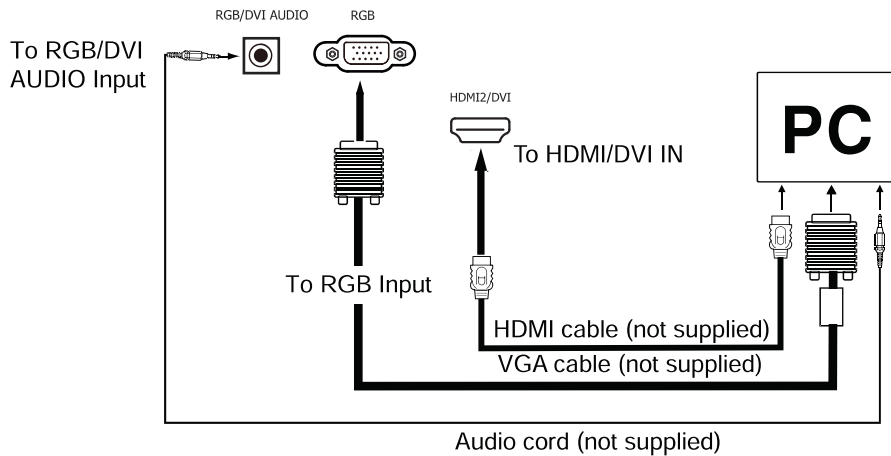

#### Monitor Display modes

MODE	Resolution	Refresh rate
VGA	640x480	60 Hz
SVGA	800x600	60 Hz
XGA	1024x768	60 Hz
WXGA	1280x768	60 Hz
WXGA	1280x720	60 Hz
WXGA	1360x768	60 Hz

**To return to normal mode**  
Press **INPUT** again.

### NOTES

- The on-screen displays will have a different appearance in RGB mode than in TV mode.
- If there is no video signal from the PC when the unit is in RGB mode, "No Signal" will appear on the TV screen.

# Troubleshooting

Use the following checklist for troubleshooting if you have problems with your LCD TV. Consult your local dealer or service outlet if problems persist. Be sure all connections are properly made when using with other units.

SYMPTOMS	POSSIBLE SOLUTIONS
TV does not operate.	<ul style="list-style-type: none"> <li>• Make sure the power cord is plugged in.</li> <li>• Try another AC outlet.</li> <li>• Power is off, check fuse or circuit breaker.</li> <li>• Unplug unit for an hour, then plug it back in.</li> </ul>
Poor sound or no sound.	<ul style="list-style-type: none"> <li>• Station or Cable TV experiencing problems, tune to another station.</li> <li>• Check sound adjustments (Volume or Mute).</li> <li>• Check for sources of possible interference.</li> </ul>
Poor picture or no picture.	<ul style="list-style-type: none"> <li>• Station or Cable TV experiencing problems, tune to another station.</li> <li>• Make sure channels are set into memory.</li> <li>• Check antenna or Cable TV connections, adjust antenna.</li> <li>• Check for sources of possible interference.</li> <li>• Check picture control adjustments.</li> </ul>
Poor reception on some channels.	<ul style="list-style-type: none"> <li>• Station or Cable TV experiencing problems, tune to another station.</li> <li>• Make sure channels are set into memory.</li> <li>• Station is weak, adjust antenna to receive desired station.</li> <li>• Check for sources of possible interference.</li> </ul>
Poor color or no color.	<ul style="list-style-type: none"> <li>• Station or Cable TV experiencing problems, tune to another station.</li> <li>• Make sure channels are set into memory.</li> <li>• Check picture control adjustments.</li> <li>• Check antenna or Cable TV connections, adjust antenna.</li> <li>• Check for sources of possible interference.</li> </ul>
Picture wobbles or drifts.	<ul style="list-style-type: none"> <li>• Station or Cable TV experiencing problems, tune to another station.</li> <li>• Make sure channels are set into memory.</li> <li>• Cable TV company is scrambling signal.</li> <li>• Adjust antenna.</li> </ul>

SYMPTOMS	POSSIBLE SOLUTIONS
Digital broadcasting screen problem.	<ul style="list-style-type: none"> <li>• Check digital signal strength.</li> </ul>
No CATV reception.	<ul style="list-style-type: none"> <li>• Check all Cable TV connections.</li> <li>• Set Air/Cable menu option to the Cable mode.</li> <li>• Station or Cable TV system problems, try another station.</li> </ul>
Horizontal or diagonal bars on screen.	<ul style="list-style-type: none"> <li>• Check antenna connections, adjust or re-direct antenna.</li> <li>• Check for sources of possible interference.</li> </ul>
No reception above channel 13.	<ul style="list-style-type: none"> <li>• Make sure Source option is in the appropriate mode.</li> <li>• If using antenna, check UHF antenna connections.</li> </ul>
No Remote operation.	<ul style="list-style-type: none"> <li>• Batteries are weak, dead or inserted incorrectly.</li> <li>• Remote is out of range, move closer to TV (within 15 feet).</li> <li>• Make sure Remote is aimed at sensor.</li> <li>• Confirm there are no obstructions between the Remote and the TV.</li> <li>• Make sure the power cord is plugged in.</li> </ul>
TV shuts off.	<ul style="list-style-type: none"> <li>• Sleep Timer is set.</li> <li>• Power interrupted.</li> </ul>
Closed Caption is not activated.	<ul style="list-style-type: none"> <li>• TV station experiencing problems or program tuned is not closed captioned. Try another channel.</li> <li>• Check Cable TV connection or VHF/UHF antenna, reposition or rotate antenna.</li> <li>• Set closed caption decoder in the menu.</li> </ul>
TV is not shown in your language.	<ul style="list-style-type: none"> <li>• Select proper language in the menu options.</li> </ul>

If the problem cannot be solved with the suggested procedures, contact 1-888-333-1899(U.S.A. or Puerto Rico), or 01-800-700-4321(Mexico). For your safety, never try to repair the product yourself.

# Specifications

ENGLISH

<b>GENERAL</b>	
Power supply	AC 120V 60Hz
Power consumption	Operation: 88W Standby: 0.7W
Weight	9.5kg (20.9lbs)
Dimensions(with stand)	Width: 792 mm (31.2 inches) Height: 561 mm (22.1 inches) Depth: 230 mm ( 9.1 inches)
Operating temperature	5°C - 40°C
Operating humidity	Less than 80% RH
<b>TELEVISION</b>	
Type	80 cm (32" class/ 31.51" diagonal)
Display method	Transmission TFT color LCD panel
Number of Pixels	1366 (H) x 768 (V)
Broadcasting system	US system M ATSC standard (8VSB), QAM
Receiving channels	VHF 2-13 UHF 14-69 CATV 1-125 Digital Terrestrial Broadcast(8VSB):2-69 Digital cable(64/256 QAM):1-135
Tuner type	Frequency synthesized
Inputs	Video: 1.0 V (p-p), 75 ohms Audio: 2V RMS max, 50k ohms terminated Component video: (Y) 1.0 V (p-p), 75 ohms (Pb)/(Pr) 0.7 V (p-p), 75 ohms HDMI: HDMI compliant (type A connector) HDCP compliant E-EDID compliant Suggested scan rates: 1080p, 1080i, 720p, 480p, 480i HDMI Audio: 2-channel PCM 32/44, 1/48 kHz sampling frequency 16/20/24 bits per sample PC Monitor: Mini-Dsub 15pin x 1 Antenna: VHF/UHF In 75 ohms coaxial
Output	Digital audio: 0.7 V (p-p), 75 ohms terminated
Speaker	184mm×48.6mm×21.5mm(7.2 inch x 1.9 inches x 0.8 inches), 8 ohms x 2
Audio output power	6.0W + 6.0W
<b>ACCESSORIES</b>	
	Remote control/Batteries (AAA) x 2/Stand/Stand Screw x 3 /Owner's Guide/Easy Graphic Guide/AC Cord

- Designs and specifications are subject to change without notice.
- For information on our other products, please visit our website at [www.hitachi.us/tv](http://www.hitachi.us/tv)

# Limited Warranty

---



## LIMITED WARRANTY TO ORIGINAL CONSUMER LCD TV

**Up to 32”:** Carry-in or ship-in service only  
**Above 32”:** In-home service

Subject to the terms and conditions of this Limited Warranty (this “Warranty”), this Hitachi Television Product, including any accessories included in the packaging) (this “Product”), is warranted by **Hitachi America, Ltd.** (“Hitachi”) to the original consumer purchaser against defects in materials and workmanship as follows:

1. **LABOR:** For a period of one year from date of original consumer purchase, if this Product or any functional part is determined by Hitachi, or any authorized servicer specified by Hitachi (“Authorized Servicer”), to be defective, Hitachi will repair the Product or, at Hitachi’s option, replace the Product with a Hitachi refurbished television product of similar or better quality, at no charge to the original consumer. After the expiration of the one year Warranty period, consumer is responsible for all repairs and repair-related labor charges.
2. **PARTS:** For a period of one year from the date of original consumer purchase, Hitachi will supply, at no charge to the original consumer new, rebuilt, or refurbished functional replacement parts in exchange for defective parts. After the expiration of the one year Warranty period, consumer is responsible for the costs of all parts.
3. **TRANSPORTATION:** Except to the extent the Product qualifies for in-home service, customer assumes responsibility for all applicable transportation or shipping charges related to delivering Product to an Authorized Servicer during the aforementioned warranty period; *provided that*, if Product is shipped to an Authorized Servicer by customer, Hitachi will pay the cost of shipping the Product back to the consumer. Product 32” or below is not eligible for in-home service.
4. **IN-HOME SERVICE:** In-home service requires clear, complete and easy access to the Product by the Authorized Servicer and does not include removal or re-installation of an installed Product. It is possible that certain in-home repairs will not be completed on-site, but will require that the Product or parts of the Product, at the Authorized Servicer’s discretion be removed for shop diagnosis and/or repair. The Product or parts will then be returned to the consumer.

**To obtain Warranty Service and Troubleshooting information:**

**Call our Electronics Consumer Care Center at 1-888-333-1899(U.S.A. or Puerto Rico), or 01-800-700-4321(Mexico).  
Hours: 9am to 6 pm EST Monday - Friday (excluding holidays)**

To receive Warranty service, the original consumer purchaser must contact Hitachi at the above telephone number for problem determination and service procedures. Proof of purchase in the form of an original bill of sale or receipted invoice, evidencing that the Product is within the applicable Warranty period(s), **MUST** be presented to Hitachi, or an Authorized Servicer, in order to obtain the requested service.

**Exclusions and Limitations:** This Warranty covers manufacturing defects in materials and workmanship encountered in the normal, noncommercial use of the Product, and does not cover consumer instruction, delivery, installation, set-up, adjustments, signal reception problems (including antenna), cosmetic damage or damage due to acts of nature, accident, misuse, abuse, negligence, commercial use or modification of, or to any part of the Product. In addition, this Warranty does not cover “ghosting” or image retention the Product’s screen caused by extended and/or repeated display of fixed on-screen content. This Warranty applies to the original consumer only and does not cover Products sold to consumers in used, “AS IS” or “WITH ALL FAULTS” condition, or consumables (e.g., fuses, batteries, bulbs etc.), and the Warranty is invalid if the factory-applied serial number has been altered or removed from the Product. Damage occurring to any Product returned for service that is caused by improper or unsecure packaging or shipping by the original consumer purchaser is excluded from coverage under this Warranty. This Warranty is valid only in the United States and Puerto Rico, and only applies to Products purchased and serviced in the United



# Limited Warranty

States and Puerto Rico. Warranty will be voided if attempts of repair are performed by the consumer or any servicers that are NOT authorized by Hitachi.

**THERE ARE NO EXPRESS WARRANTIES OTHER THAN THOSE EXPRESSLY DESCRIBED ABOVE, AND NO WARRANTIES WHETHER EXPRESS OR IMPLIED, INCLUDING, BUT NOT LIMITED TO, ANY IMPLIED WARRANTIES OF MERCHANTABILITY OR FITNESS FOR A PARTICULAR PURPOSE, SHALL APPLY AFTER THE EXPRESS WARRANTY PERIOD STATED ABOVE, AND NO OTHER EXPRESS WARRANTY OR GUARANTY GIVEN BY ANY PERSON, FIRM OR ENTITY WITH RESPECT TO THE PRODUCT SHALL BE BINDING ON HITACHI. THIS WARRANTY IS THE EXCLUSIVE WARRANTY WITH RESPECT TO THE PRODUCT AND HITACHI IS THE EXCLUSIVE WARRANTY PROVIDER FOR THE PRODUCT. REPAIR OR REPLACEMENT IS THE EXCLUSIVE REMEDY OF THE CONSUMER. HITACHI SHALL NOT BE LIABLE FOR ANY INCIDENTAL OR CONSEQUENTIAL DAMAGES CAUSED BY THE USE, MISUSE OR INABILITY TO USE THE PRODUCT. NOTWITHSTANDING THE FOREGOING, CONSUMER'S RECOVERY AGAINST HITACHI SHALL NOT EXCEED THE PURCHASE PRICE OF THE PRODUCT SOLD BY HITACHI. THIS WARRANTY SHALL NOT EXTEND TO ANYONE OTHER THAN THE ORIGINAL CONSUMER WHO PURCHASED THE PRODUCT AND IS NOT TRANSFERABLE.**

ENGLISH

Some states do not allow the exclusion or limitation of incidental or consequential damages, or allow limitations on warranties, so the above limitations or exclusions may not apply to you. This Warranty gives you specific rights, and you may have other rights, which vary from state to state.

### CUSTOMER RECORD

(Please Retain for your records)

Date of Purchase: \_\_\_\_\_ Store/Dealer: \_\_\_\_\_  
Model No.: \_\_\_\_\_ Serial No.: \_\_\_\_\_

**Important:** Keep all original Product packaging materials and *the original receipt* in the event Product needs service.

# End User License Agreement for HITACHI DTV Software

## END USER LICENSE AGREEMENT FOR HITACHI DTV SOFTWARE

**IMPORTANT – READ CAREFULLY:** This End User License Agreement for **HITACHI** DTV Software (this “Agreement”) is a legal agreement between you (“you” or “your”), in your capacity as the owner of a **HITACHI** brand digital television (the “DTV”), and **HITACHI** America, Ltd., Home Electronics Division (“**HITACHI**”). By using the DTV or the digital television software installed on the DTV (the “DTV Software”) or any Upgrade (as defined below, and together with the DTV Software, the “Software”), you agree to be bound by the terms and conditions of this Agreement. **IF YOU DO NOT AGREE TO BE BOUND BY THIS LICENSE AGREEMENT, DO NOT USE THE DTV OR THE SOFTWARE.**

1. **LICENSE GRANT.** **HITACHI** grants to you, for the life of the DTV, a non-exclusive, non-transferable, revocable license to install and use one copy of the Software on the DTV, subject to the following limitations and restrictions:
  - a. You may not share, duplicate, republish or redistribute the Software;
  - b. You may not resell, rent, lease, sublicense, gift, loan, as sign or otherwise transfer the Software or any of your rights under this Agreement;
  - c. You may not modify, adapt, translate, reverse engineer, decompile, disassemble or make derivative works from the Software or use the Software in combination with any non-Hitachi software; and
  - d. You may not use the Software for any commercial purpose.
2. **VIOLATIONS; INDEMNITY.** You understand and agree that your use of the Software in any manner except as permitted under this Agreement could constitute a serious crime and could subject you to damages and an award to **HITACHI** of attorneys’ fees in connection with your violation of this Agreement. You further understand that you may be held legally responsible for any copyright infringement or other violation of intellectual property rights caused or facilitated by your failure to abide by the terms of this Agreement. You agree to defend, indemnify and hold **HITACHI** and its parent and affiliate companies harmless from and against any and all liability resulting from any breach by you of this Agreement.
3. **INTELLECTUAL PROPERTY.** The Software is protected by federal copyright laws, international copyright treaties and other intellectual property laws and treaties. The Software is licensed, not sold, to you. All right, title and interest in and to the Software and any intellectual property associated therewith, including any accompanying printed materials, shall belong to **HITACHI** and its licensors and suppliers. Except as expressly provided herein, neither **HITACHI** nor any of its licensors or suppliers grants to you under this Agreement any express or implied right in or to any patents, copyrights, trademarks, trade secrets or other intellectual property. All right, title and interest in and to the intellectual property rights associated with any content that is accessible through use of the Software shall belong to the applicable content owners and may be protected by copyright or other intellectual property laws and treaties. This Agreement grants you no rights to use such content. Any rights of **HITACHI** not expressly granted to you hereunder are reserved expressly by Hitachi.
4. **SOFTWARE UPGRADES.** In the future, **HITACHI** may release or make available one or more upgrades to the DTV Software (each, an “Upgrade”). You understand and agree that if you decide to install or use any Upgrade, your installation and use of such Upgrade and/or any other software or intellectual property **HITACHI** may provide in connection therewith shall be governed by the terms and conditions of this Agreement, except to the extent that **HITACHI** provides different or supplementary license terms or conditions that accompany such Upgrade or other software or intellectual property. In the event **HITACHI** provides you with a “flash card” or other media to effect or facilitate an Upgrade, you understand and acknowledge that your failure to return such flash card or other media to **HITACHI** as **HITACHI** may require could result in **HITACHI** placing your name and your DTV’s serial number on a “No Further Upgrades” list, which will prohibit you from receiving any subsequent Upgrades **HITACHI** may later release or make available. **IF YOU DO NOT AGREE WITH ALL THE TERMS AND CONDITIONS OF THIS AGREEMENT OR ALL THE TERMS AND CONDITIONS OF ANY DIFFERENT OR SUPPLEMENTARY LICENSE THAT MAY ACCOMPANY SUCH UPGRADE, (A) DO NOT USE ANY HITACHI-PROVIDED FLASH CARD OR OTHER MEDIA, (B) DO NOT PERFORM INSTALL ANY HITACHI-PROVIDED UPGRADE SOFTWARE ON YOUR DTV, AND (C) PROMPTLY RETURN SUCH FLASH CARD OR OTHER MEDIA TO HITACHI.**
5. **EXPORT RESTRICTIONS.** **HITACHI** is licensing the Software for use within North America only. You agree that you will not export or re-export the Software. You specifically agree not to export or reexport the Software: (i) to any country to which the U.S. has embargoed or restricted the export of goods or services, which currently include, but are not necessarily limited to Cuba, Iran, Libya, North Korea, Sudan and Syria, or to any national of any such country, wherever located, who intends to transmit or transport the Software back to such country; (ii) to any person or entity who you know or have reason to know will utilize the Software in the design, development, or production of nuclear, chemical, or biological weapons; or (iii) to any person or entity

who has been prohibited from participating in U.S. export transactions by any federal agency of the U.S. government. You warrant and represent that neither the U.S. Bureau of Industry and Security nor any other U.S federal Agency has suspended, revoked, or denied your export privileges.

6. **NO WARRANTIES.** The software is provided to you in “as is” condition and **HITACHI** makes no warranties of any kind whatsoever regarding the software and, to the maximum extent permitted by law, hereby expressly disclaims all warranties of any kind whatsoever, express or implied, with respect to the software. All implied warranties, including without limitation, the implied warranties of non-infringement, merchantability and fitness for a particular purpose are hereby expressly disclaimed by **HITACHI** to the maximum extent permitted by law.
7. **LIMITATION OF LIABILITY.** To the maximum extent permitted by applicable law, **HITACHI**, its licensors, suppliers, parent companies, affiliates, subsidiaries, employees and agents shall not under any circumstances be liable to you or any third parties for any damages of any nature arising in any way from this agreement, your use of the software or otherwise, whether indirect, special, incidental, consequential or otherwise, including, without limitation, any claims for lost profits, lost good will, lost data, business interruption, procurement of substitute goods or services, or expenditures made or committed for in reliance on the continuation of this agreement, even if advised in advance of the possibility of such damages.
8. **NO FAILURE OF ESSENTIAL PURPOSE.** You agree that neither **HITACHI'S** breach of this agreement nor its failure to repair a defect, error or bug in the software shall constitute a failure of the essential purpose of this agreement.
9. **CRYPTOGRAPHIC SOFTWARE.** The software contains software developed by the OpenSSL Project, including cryptographic software written by eric young (the “cryptographic software”). The cryptographic software is provided by the OpenSSL Project in “as is” condition and any express or implied warranties, including but not limited to, the implied warranties of merchantability and fitness for a particular purpose are hereby expressly disclaimed to the maximum extent permitted by law. In no event shall the OpenSSL Project, its contributors, **HITACHI** or any of its parent or affiliate companies be liable for any direct, indirect, incidental, special, exemplary, or consequential damages (including, but not limited to, procurement of substitute goods or services; loss of use, data, or profits; or business interruption) however caused and on any theory of liability, whether in contract, strict liability, or tort (including negligence or otherwise) arising in any way out of the use of the software or the cryptographic software, even if advised in advance of the possibility of such damages.
10. **TERMINATION.** **HITACHI** may terminate this Agreement immediately at any time by providing notice to you.
11. **GOVERNING LAW; SEVERABILITY.** This Agreement will be governed by the laws of the State of New York, and you consent to the exclusive jurisdiction and venue in the federal courts sitting in the Southern District of New York, unless no federal subject matter jurisdiction exists, in which case you consent to the exclusive jurisdiction and venue in the Borough of Manhattan, New York, USA.

# End User License Agreement for Open Source Software

## OPEN SOURCE SOFTWARE LICENSE INFORMATION

This Hitachi TV incorporates open source software modules distributed under certain licenses, including the GNU General Public License Version 3 (as defined by the Free Software Foundation, Inc.).

The open source software modules incorporated in this Hitachi TV are shown in the table below.

Software Module	Library Name	Link	Applicable License
AC3 decoder	liba52.c	<a href="http://www.liba52.sourceforge.net">www.liba52.sourceforge.net</a>	GNU General Public License Version 3

ENGLISH

THESE SOFTWARE MODULES AND THE SOURCE CODE MODIFICATIONS THERETO ARE PROVIDED "AS IS" AND BOTH THE LICENSORS AND HITACHI DISCLAIM ANY AND ALL WARRANTIES OF ANY KIND, INCLUDING THE IMPLIED WARRANTY OF MERCHANTABILITY AND OF FITNESS FOR A PARTICULAR PURPOSE.

If you would like to learn more about the Free Software Foundation, Inc. or the GNU software project, please visit <http://www.fsf.org>. If you would like to request a copy of the Source Code Modifications, please send an email to the following address: [tvsoftwaresupport@hal.hitachi.com](mailto:tvsoftwaresupport@hal.hitachi.com)

# Appendixes

## Appendix A: Picture Format for Each Input Source

### Aspect Specifications

Aspect		4:3	16:9	Dot toDot	Zoom	Cinema
Zoom Ratio	SD:OverScan(5%) HD:OverScan (3%)	YES	YES	No	YES	YES
Air / Cable	NTSC, 480i,480p	YES	YES	--	YES	YES
	720p, 1080i	--	YES	--	--	--
Composite/S-video		YES	YES	--	YES	YES
Component	480i, 480p	YES	YES	--	YES	YES
	720p, 1080i,1080P	--	YES	--	--	--
HDMI (DVI)	VGA, SVGA,	YES	YES	--	YES	YES
	XGA, WXGA			--		
	480i, 480p	YES	YES	--	YES	YES
	720p, 1080i, 1080p	--	YES	--	--	--
RGB		YES	YES	YES	--	--

## Appendix B: RGB Format

Resolution	Frequency(Hz)
640x480	60
800x600	60
1024x768	60
1280x720	60
1280x768	60
1360x768	60

### NOTE

The type of video board or connecting cable may not allow for correct displays adjustment of H-Position, V-Position, Clock and Phase.

