

# user's guide





**RCA** | LCD FLAT PANEL HDTV

For use with models: L42FHD37/L46FHD37/L46FHD35/  
L42FHD38/L46FHD38/L52FHD38/L40FHD380

## contents

connections	6
remote	21
features	30
menus	36
FAQs	42
warranty	48

# Important Information

	<b>CAUTION</b> RISK OF ELECTRIC SHOCK DO NOT OPEN			This symbol indicates that this product incorporates double insulation between hazardous mains voltage and user accessible parts. When servicing use only identical replacement parts.
<p>Caution: To reduce the risk of electric shock, do not remove cover (or back). No user serviceable parts inside. Refer servicing to qualified service personnel.</p>				
	This symbol indicates "dangerous voltage" inside the product that presents a risk of electric shock or personal injury.		This symbol indicates important instructions accompanying the product.	

**WARNING**  
To reduce the risk of fire or electric shock, do not expose this product to rain or moisture. The apparatus shall not be exposed to dripping or splashing. No objects filled with liquids, such as vases, shall be placed on the apparatus.

**WARNING**  
The TV is unstable if it is not properly attached to the base or mounted to the wall. Please follow the base or wall mounting instructions provided in the User's Guide to ensure your safety.

 This symbol indicates that this product contains mercury. Special disposal of this product for environmental reasons may be required under the laws applicable to your jurisdiction. For disposal or recycling information, please contact your local authorities or the Electronic Industries Alliance: [www.eiae.org](http://www.eiae.org).

Refer to the identification/rating label located on the back panel of your product for its proper operating voltage. FCC regulations state that changes or modifications to this unit not expressly approved by the party responsible for compliance could void the user's authority to operate the equipment.

Cable TV Installer: This reminder is provided to call your attention to Article 820-40 of the National Electrical Code (Section 54 of the Canadian Electrical Code, Part 1) which provides guidelines for proper grounding and, in particular, specifies that the cable ground shall be connected to the grounding system of the building as close to the point of cable entry as practical.

Important: This television is a table model and is designed to sit on a firm, flat, surface. Don't place the TV on soft carpeting or similar surface because the ventilation slots on the bottom of the unit will be blocked resulting in reduced lifetime from overheating. To assure adequate ventilation for this product, maintain a spacing of 4 inches from the top and sides of the TV receiver and 2 inches from the rear of the TV receiver and other surfaces.

Also, make sure the stand or base you use is of adequate size and strength to prevent the TV from being accidentally tipped over, pushed off, or pulled off. This could cause personal injury and/or damage the TV. Refer to the Important Safety Instructions on the next page.

The power button (followed by the power symbol) on this TV and your remote control puts the TV into a very low-power standby mode but will not completely shut the power off. In order to shut the power off, you will need to disconnect the power cord from your outlet. Therefore, you should make sure the TV is installed in a way that allows you to disconnect the power cord when desired.

## Product Registration

Please fill out the product registration card (packed separately) and return it immediately. For US customers: Your RCA Consumer Electronics product may also be registered at [www.rca.com/television](http://www.rca.com/television). Registering this product allows us to contact you if needed.

## Product Information

Keep your sales receipt to obtain warranty parts and service and for proof of purchase. Attach it here and record the serial and model numbers in case you need them. These numbers are located on the product.

**Model No.** \_\_\_\_\_ **Serial No.** \_\_\_\_\_ **Purchase Date** \_\_\_\_\_  
**Dealer/Address/Phone** \_\_\_\_\_

# Important Safety Instructions

## Important Safety Instructions

1. Read these instructions.
2. Keep these instructions.
3. Heed all warnings.
4. Follow all instructions.
5. Do not use this apparatus near water.
6. Clean only with dry cloth.
7. Do not block any ventilation openings. Install in accordance with the manufacturer's instructions.
8. Do not install near any heat sources such as radiators, heat registers, stoves, or other apparatus (including amplifiers) that produce heat.
9. Do not defeat the safety purpose of the polarized or grounding-type plug. A polarized plug has two blades with one wider than the other. A grounding type plug has two blades and a third grounding prong. The wide blade or the third prong is provided for your safety. If the provided plug does not fit your outlet, consult an electrician for replacement of the obsolete outlet.
10. Protect the power cord from being walked on or pinched particularly at plugs, convenience receptacles, and the point where it exits from the apparatus.
11. Only use attachments/accessories specified by the manufacturer.
12. Use only with the cart, stand, tripod, bracket, or table specified by the manufacturer, or sold with the apparatus. When a cart is used, use caution when moving the cart/apparatus combination to avoid injury from tip-over.
13. Unplug this apparatus during lightning storms or when unused for long periods of time.
14. Refer all servicing to qualified service personnel. Service is required when the apparatus is damaged in any way, such as power-supply cord or plug damage, liquid spilled on or objects falling onto apparatus, rain or moisture exposure, abnormal operation, or if the apparatus has been dropped.
15. If an outside antenna or cable system is connected to the product, be sure the antenna or cable system is grounded so as to provide some protection against voltage surges and built-up static charges. Section 810 of the National Electrical Code, ANSI/NFPA No. 70-1984 (Section 54 of Canadian Electrical Code, Part 1) provides information with respect to proper grounding of the mast and supporting structure, grounding of the lead-in wire to an antenna-discharge unit, size of grounding conductors, location of antenna-discharge unit, connection to grounding electrodes, and requirements for the grounding electrode. See following example:

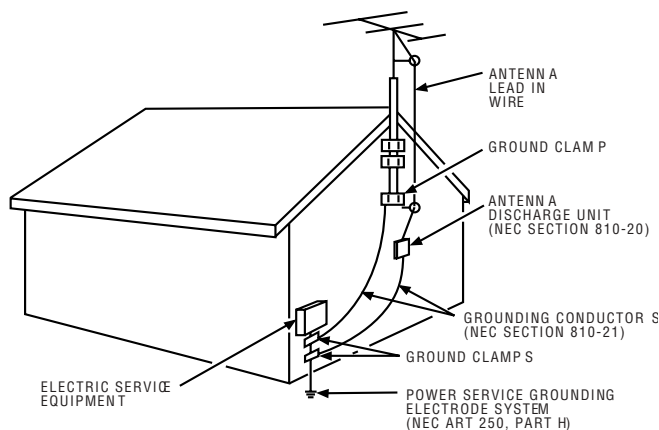

# Table of Contents

---

Important Safety Instructions ..... i

## Chapter 1 | Connections & Setup

<b>Things to Consider Before You Connect</b> .....	<b>6</b>
Protect Against Power Surges .....	6
Instructions at the Beginning of the User's Guide .....	6
Position Cables Properly to Avoid Audio Interference .....	6
Use Indirect Light .....	6
Check Supplied Parts .....	6
<b>Attaching Your TV to the Table Stand</b> .....	<b>7</b>
<b>Mounting Your TV to the Wall</b> .....	<b>9</b>
<b>Get the Picture</b> .....	<b>10</b>
Getting Channels .....	10
<b>Choose Your Connections</b> .....	<b>11</b>
Composite Video Connection .....	12
Component Video Connection .....	12
HDMI/DVI Connection .....	13
PC Connection .....	14
Viewing the Picture From the Connected Device .....	15
Viewing the PC .....	15
<b>Plug in the TV</b> .....	<b>16</b>
<b>Put Batteries in the Remote</b> .....	<b>16</b>
<b>Turn on the TV</b> .....	<b>16</b>
<b>How to Use the Remote Control to Complete the Initial Setup</b> .....	<b>16</b>
<b>Complete the Initial Setup</b> .....	<b>17</b>
Set the Menu Language .....	17
Set the TV Location Mode .....	17
Complete Channel Setup .....	17
<b>What To Expect</b> .....	<b>18</b>
Watching TV .....	18
Changing Channels .....	18
<b>Explanation of Jacks (in alphabetical order)</b> .....	<b>19</b>
<b>Buttons and Other Jacks on Your TV</b> .....	<b>20</b>
Side Input Jacks .....	20
Side Panel Buttons .....	20

## Chapter 2 | Using the Remote Control

<b>Remote Control Buttons</b> .....	<b>21</b>
Using the INPUT Button .....	22
<b>Programming the Remote to Operate Other Devices</b> .....	<b>22</b>
Find Out If You Need to Program the Remote .....	22
Programming the Remote .....	23

How to Use the Remote After You've Programmed It .....	<b>24</b>
Modes of Operation .....	24
Manual Reset of the Remote Control .....	<b>25</b>
Remote Code List .....	<b>26</b>

## Chapter 3 | Using the TV's Features

Channel Banner .....	<b>30</b>
Autotuning .....	<b>30</b>
Parental Controls and V-Chip .....	<b>31</b>
How V-Chip Works for USA and Canada .....	31
Lock/Unlock Parental Controls .....	32
US V-Chip Menu .....	32
US V-Chip TV Ratings .....	32
US V-Chip Movie Rating Limit .....	33
Blocking Canada V-Chip Ratings .....	34
Block Channel .....	34
Block Buttons .....	34
Blocking Unrated/Exempt Programs .....	34
Future Rating Region .....	34
Additional Features .....	<b>35</b>
Fetch Feature .....	35
Screen Formats .....	35

## Chapter 4 | Using the TV's Menu

Using the Menu System .....	<b>36</b>
Sound Menu .....	<b>36</b>
Picture Menu .....	<b>38</b>
Channel List Menu .....	<b>38</b>
Setup Menu .....	<b>38</b>
Parental Control Menu .....	<b>40</b>
Time Menu .....	<b>40</b>
USB Menu .....	<b>41</b>
USB Connection .....	<b>41</b>

## Chapter 5 | Other Information

Frequently Asked Questions (FAQs) .....	<b>42</b>
Troubleshooting .....	<b>43</b>
V-Chip Rating Explanations .....	<b>46</b>
US V-Chip Rating System .....	46
Canadian English V-Chip Rating System .....	46
Canadian French V-Chip Rating System .....	47
Limited Warranty .....	<b>48</b>
Care and Cleaning .....	<b>51</b>

# 1 Connections and Setup

## Things to Consider Before You Connect

### Protect Against Power Surges

- Connect all devices before you plug any power cords into the wall outlet or power strip. NEVER plug your TV into an outlet that is controlled by a wall switch.
- Turn off the TV and/or device(s) before you connect or disconnect any cables.
- Make sure all antennas and cables are properly grounded. Refer to the Important Safety Instructions.

### Instructions at the beginning of the User's Guide

- Protect devices from overheating.
- Don't block ventilation holes on any of the devices. Arrange the devices so that air can circulate freely.
- Don't stack devices.
- If you place devices in a stand, make sure you allow adequate ventilation.
- If you connect an audio receiver or amplifier, place it on the top shelf so the heated air from it won't flow around other devices.

### Position Cables Properly to Avoid Audio Interference

- Insert each cable firmly into the designated jack.
- If you place devices above the TV, route all cables down one side of the back of the TV instead of straight down the middle.
- If your antenna uses 300-ohm twin lead cables, do not coil the cables. Also, keep the twin lead cables away from audio/video cables.

### Use Indirect Light

Don't place the TV where sunlight or room lighting will be directed toward the screen. Use soft or indirect lighting.

### Check Supplied Parts

Check that the following parts were packed with your product.

**Note:** If you need to replace your remote, call 1-800-338-0376. A shipping and handling fee, and the appropriate sales tax, will be charged upon ordering. Have your Visa, MasterCard, or Discover Card ready.

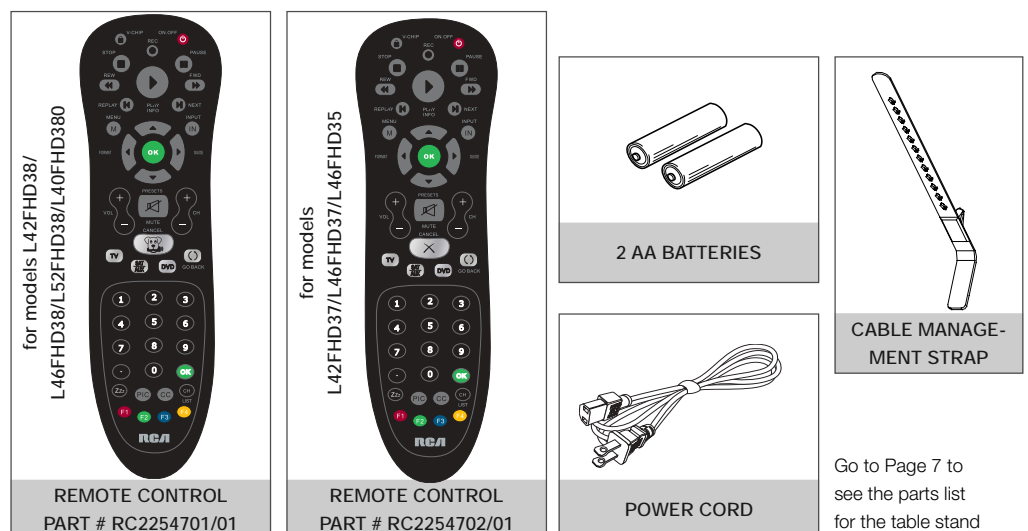

Graphics contained within this publication are presentation only.

# Attaching Your TV to the Table Stand

**Note:** For model L52FHD38, the Table Stand is preassembled, please go to the next section.

Your TV comes without the table stand attached so that you can choose to mount your TV either to its table stand or to a wall (wall mount sold separately). If you want to mount your TV to the wall, don't attach the table stand, and instead,

Parts List for models L42FHD37/L46FHD37/L46FHD35/L42FHD38/L46FHD38/L40FHD380

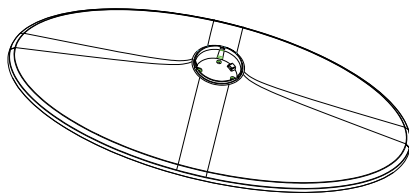

1 Table Stand Base

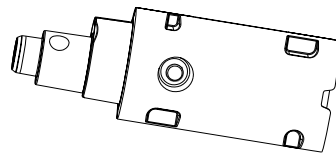

1 Hinge

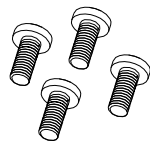

4 Size M5 Screws

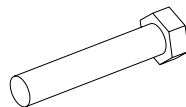

1 Size M8 Screw

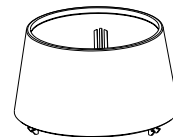

1 Hinge Cover

## Step 1

There are two options for the stand assembly:

Option 1: Your TV has been packed upside down in the carton (see Figure 1) to facilitate the attachment of the TV Table Stand assembly. You just need to remove the bag covering the TV, assemble the Table Stand as noted on page 8 and then attach the Table Stand to the TV before removing the TV from the carton.

Option 2: Remove the TV bag and place it on a large, flat surface such as a table or countertop. Remove the TV from the carton and place it face down on the TV bag (see Figure 2). Be sure that the TV is face down to avoid scratching the screen.

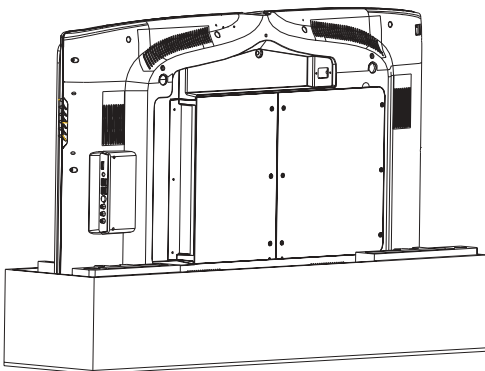

Figure 1

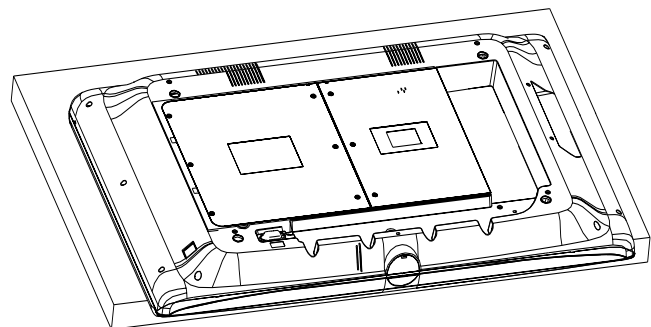
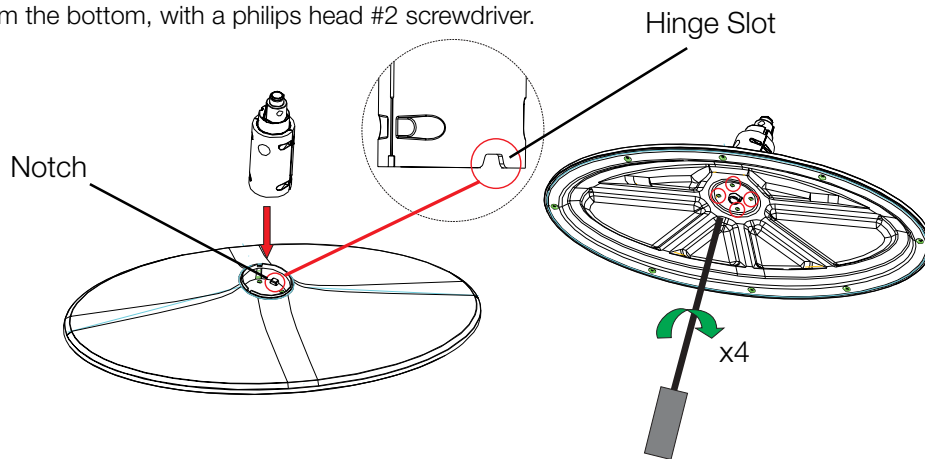

Figure 2

### Step 2

1. Take the stand base and the hinge.
2. Position the hinge by aligning the slot on the hinge and the notch on the stand base.
3. Attach the hinge to the stand base with four M5 screws, from the bottom, with a philips head #2 screwdriver.



### Step 3

1. Take the stand base assembly and the hinge cover.
2. Locate the hinge cover by aligning the biggest tab fastener to the biggest slot on the stand base.
3. Push and fasten the hinge cover to the stand base. Be sure all 3 tab fasteners snap firmly in place.

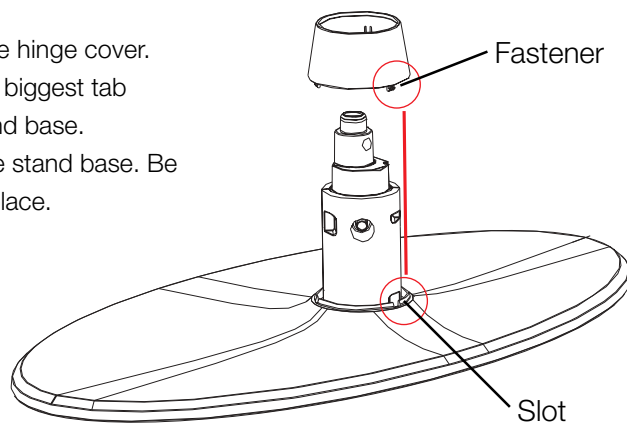

### Step 4

Remove the stand cap from the TV cabinet by pushing on the small tab and pulling out the cap.

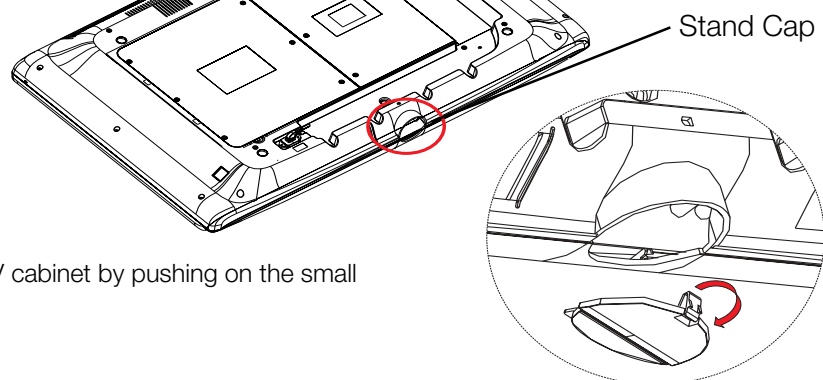



### Step 5

Attach the fully assembled table stand to the TV cabinet by inserting the hinge into the cabinet and aligning the hinge guide to the slot opening.

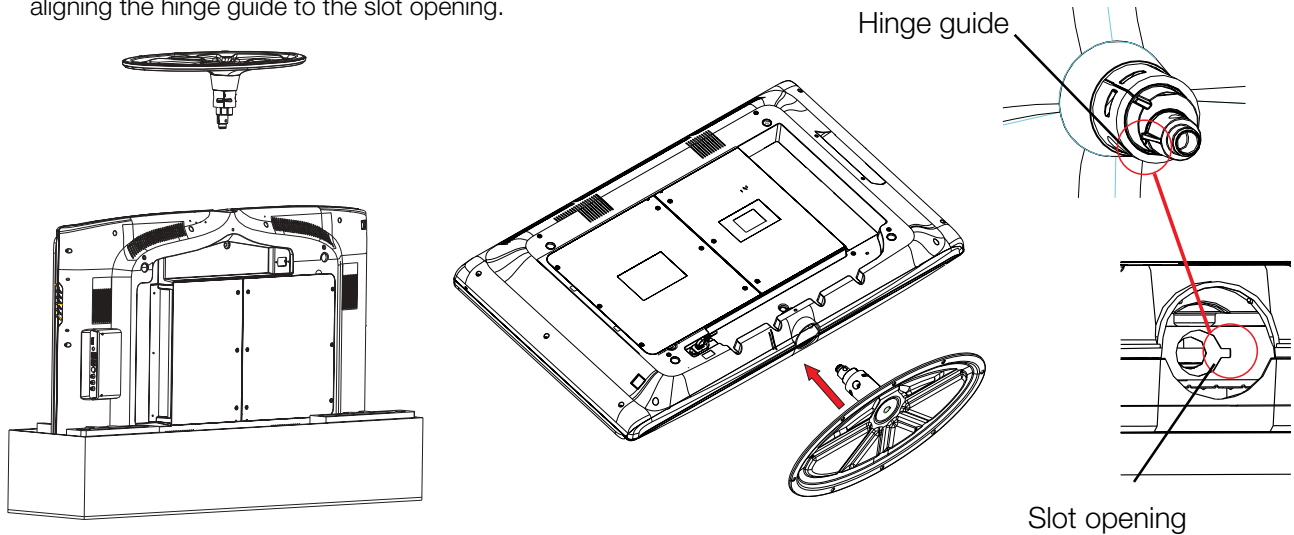

### Step 6

Secure the table stand to the TV cabinet by tightening the M8 screw with a philips head #3 screwdriver.

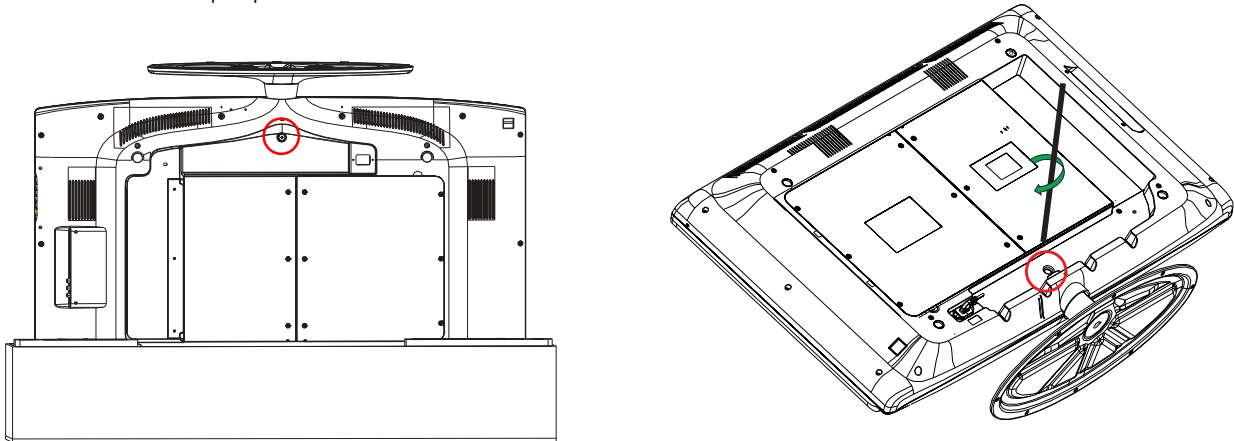

## Mounting Your TV to the Wall

*To mount your TV to the wall you need to purchase a VESA wall mount*

Model L42FHD37/L40FHD380/L42FHD38

Purchase a VESA 600 x400, M6 screw

Model L46FHD37/L46FHD35/L46FHD38/  
L52FHD38

Purchase a VESA 600 x400, M6 screw

**Caution:** Your wall mount must bear a minimum of five times the tv's net weight without causing damage.

The VESA number is the horizontal and vertical measurement of the mounting holes. For example, 600x400 means the mounting measurements are 600mm horizontally and 400mm vertically. Follow the directions included with the wall mount to mount the TV to the wall.

# Get the Picture

The first part of connecting your TV is to get the picture, also known as the signal. The back panel of your TV allows you to receive analog and/or digital channels by using the ANTENNA/CABLE INPUT.

## Getting Channels

### What You Need

Antenna ("rabbit ears") or outdoor antenna with coaxial cable

OR

Coaxial cable with cable service

- A. Do you have an indoor or outdoor antenna? If not, go to step B. If so, plug the antenna or coaxial cable from the wall outlet into the ANTENNA/CABLE INPUT to receive free off-air local digital and analog channels.
- B. Do you have cable? If so, plug the coaxial cable from the wall outlet into the ANTENNA/CABLE INPUT to receive your cable channels.
- C. Do you have a set-top box? If so, you may need to call your cable company or satellite service provider. They may recommend special cables to allow you to view digital channels.

### What You Need To Know

- Visit [www.antennaweb.org](http://www.antennaweb.org) for help deciding what type of antenna to use to receive the local digital channels available to you. By entering where you live, this mapping program tells you what local analog and digital stations are available using a certain antenna.
- When you are ready to watch channels, the channel banner displays the type of channel you're viewing. Look for a *D* at the bottom of the screen for digital channels; look for an *A* for analog channels. Go to page 30 for more information.

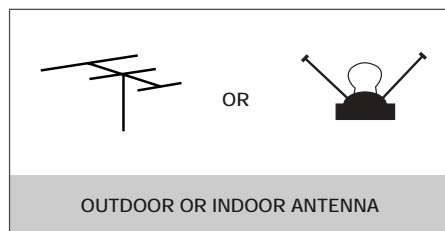
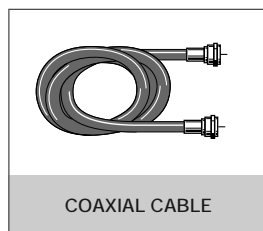

# Choose Your Connections

There are several ways to connect devices such as DVD players and set-up boxes to your TV. Please use the following chart to determine which connection is best for you. Proceed to the appropriate page to connect your TV.

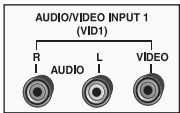
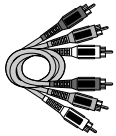
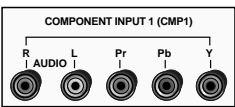
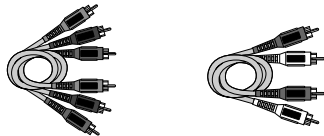
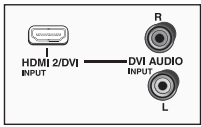
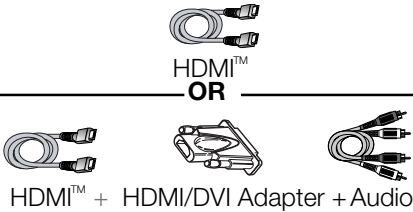
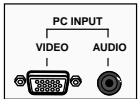
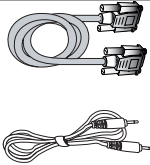
Jacks Used	Cable Needed	Go to...
 <p>Audio R and L    Video</p>	 <p>Audio/Video</p>	page 12
 <p>Audio R and L    Y Pr Pb</p>	 <p>Component Video    Audio</p>	pages 12-13
 <p>HDMI/DVI    Audio R and L</p>	<p>HDMI™ OR</p>  <p>HDMI™ + HDMI/DVI Adapter + Audio</p>	pages 13-14
 <p>VGA    Audio</p>	 <p>VGA  Audio</p>	pages 14-15

HDMI, the HDMI logo, and High-Definition Multimedia Interface are trademarks or registered trademarks of HDMI Licensing LLC.

Input	Signal Compatibility
Ant/Cable	480i, 480p, 720p, 1080i (NTSC, ATSC, and QAM formats)
Composite Video	480i
S-Video	480i
Component Video	480i, 480p, 720p/60Hz, 1080i/60Hz
PC	VGA, SVGA, XGA
HDMI	480i, 480p, 720p/60Hz, 1080i/60Hz, 1080p

## Note for US

**customers:** If you prefer, we can provide you with the name of an Authorized Service Representative who will visit your home for a fee to install your electronic entertainment system and instruct you in its operation. For details about this service, call **1-888-206-3359**. For additional assistance while using your RCA product, please visit [www.rca.com/customersupport](http://www.rca.com/customersupport).

## Connecting a Device with Composite Video (Good)

This connection allows you to connect a device that has a Video Out jack, for example, a DVD player.

Using the example of a DVD player:

1. If necessary, connect your cable and/or off-air antenna as described on page 10.
2. Connect your yellow video cable. Connect a video cable to the (VID1) VIDEO jack on the back of the TV and to the VIDEO OUTPUT jack on the DVD player.
3. Connect your red and white AUDIO cables. Connect the AUDIO (red and white) cables to the (VID1) right and left AUDIO jacks on the back of the TV and to the AUDIO OUTPUT jacks on the DVD player.

## Composite Video Connection

This is an example of a connection using the composite video jack.

**Don't forget:**  
If necessary, connect antenna or cable to get a picture. Go to page 10 for instructions.

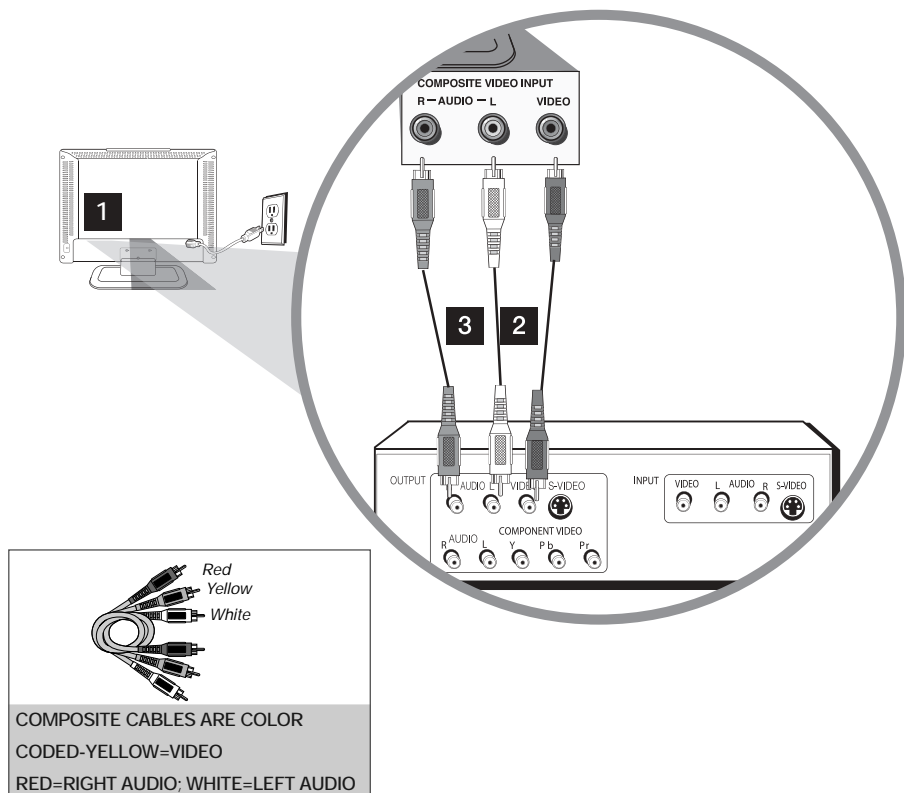

## Connecting a Device with Component Video (Better)

This connection allows you to connect a device that has Y Pb Pr jacks, for example, a DVD player.

Using the example of a DVD player:

1. If necessary, connect your cable and/or off-air antenna as described on page 10.
2. Connect your Y Pb Pr component VIDEO cables. Connect three VIDEO cables or special Y Pb Pr cables to the COMPONENT INPUT 1 (CMP1) Y Pb Pr jacks on the back of the TV and to the Y Pb Pr outputs on the DVD player.
3. Connect your red and white AUDIO cables. Connect the AUDIO (red and white) cables to the Component Input 1 (CMP1) right and left AUDIO jacks on the back of the TV and to the AUDIO OUTPUT jacks on the DVD player.

## Component Video Connection

This is an example of a connection using the component video jacks. Go to page 12 for specific instructions.

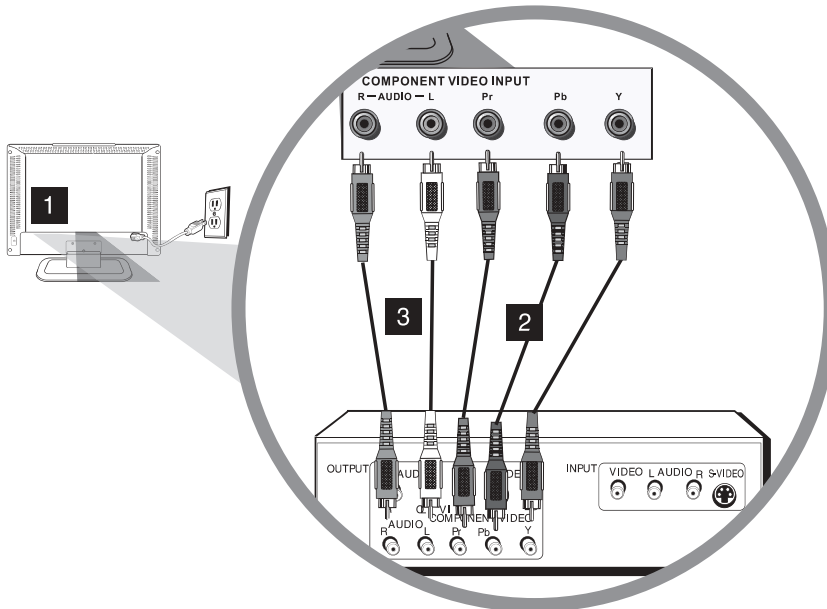

### **Don't forget:**

If necessary, connect antenna or cable to get a picture. Go to page 10 for instructions.

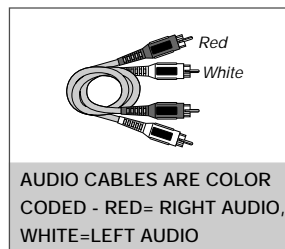
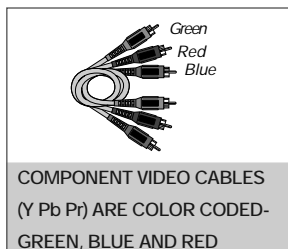

## Connecting a Device with HDMI (Best)

High-Definition Multimedia Interface (HDMI) technology is an uncompressed digital connection that carries both video and audio data by way of an integrated mini-plug cable. Since HDMI technology is based on Digital Visual Interface (DVI), the jack on the back of your TV is also compatible with devices that have a DVI output jack.

Using the example of a set-top box:

If your set-top box has an HDMI jack, connect an HDMI cable. Connect an HDMI cable to the HDMI2/DVI INPUT jack on the back of the TV (or the HDMI1 jack on the back or HDMI3 on the side of the TV if it is more convenient) and to the HDMI Out jack on the back of the device.

-OR-

If your set-top box has a DVI jack, connect an HDMI cable and an HDMI/DVI adapter.

1. Connect an HDMI cable to the HDMI2/DVI INPUT jack on the back of the TV.
2. Attach an HDMI/DVI adapter to the end of the HDMI cable, then connect the adapter to the DVI Out jack on the set-top box.
3. Since you're using an HDMI/DVI adapter, you need to connect separate AUDIO cables to the DVI AUDIO right and left jacks on the back of the TV and to the R and L AUDIO jacks on the back of the device.

## HDMI/DVI Connection (Best)

This is an example of a connection using the HDMI2/DVI jack. Go to page 13 for specific instructions.

**Don't forget:**  
If necessary, connect antenna or cable to get a picture. Go to page 10 for instructions.

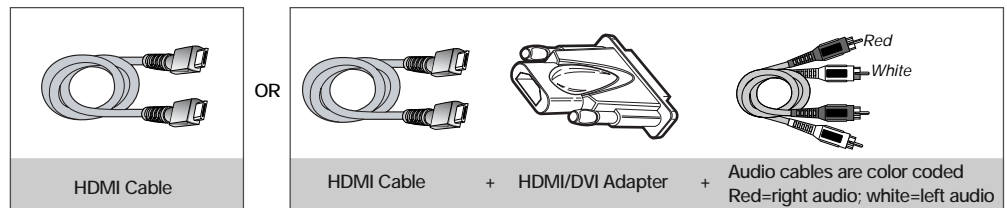
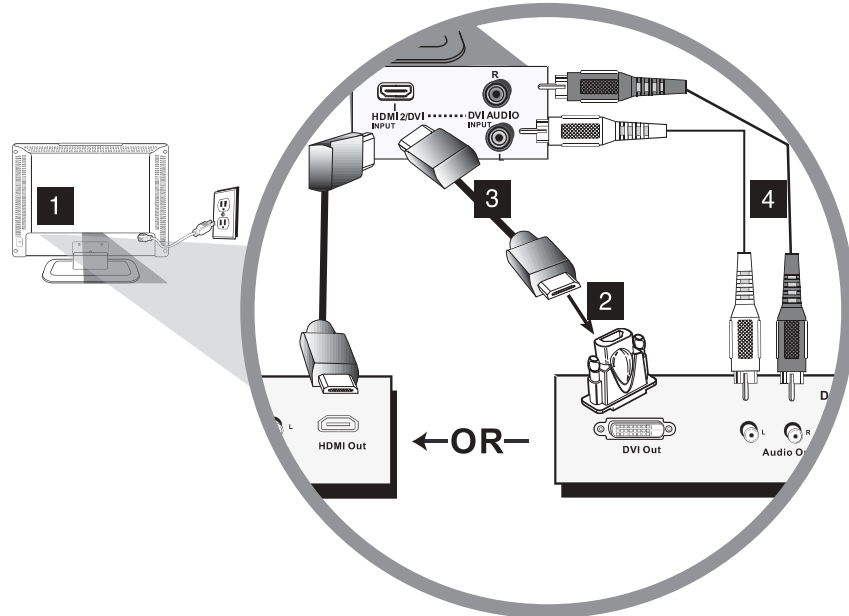

## Connecting a PC Device

**Note:** The maximum resolution is 1024 x 768. Be sure to set your PC to the correct monitor output setting.

This connection allows you to connect to a personal computer and use your TV as a monitor.

1. If necessary, connect your cable and/or off-air antenna as described on page 10.
2. Connect your monitor cable. Connect one end of a 15-pin monitor cable to the PC VIDEO jack on the TV and the other end to the PC's VIDEO OUTPUT jack. Note, if your PC's VIDEO OUTPUT isn't 15-pin, you'll need an adapter that can connect to a 15-pin monitor cable.
3. Connect your AUDIO cable. Connect a 3.5mm stereo mini pin cable (sometimes referred to as 1/8" stereo mini pin) to the PC AUDIO jack on the back of the TV and the other end to the AUDIO OUTPUT jack on the PC.

## PC Connection

This is an example of a connection using the PC VIDEO jack. Go page 14 for specific instructions.

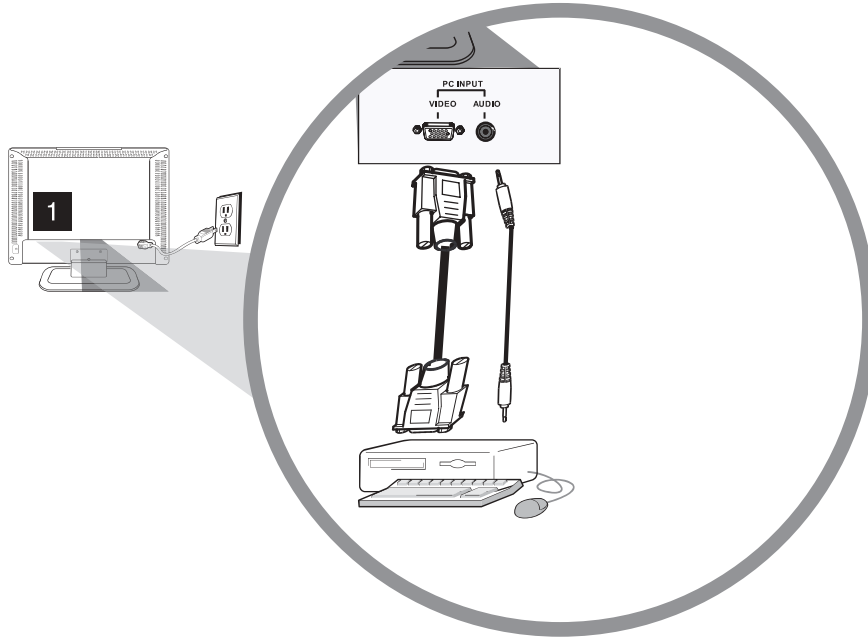

### **Don't forget:**

*If necessary, connect antenna or cable to get a picture. Go to page 10 for instructions.*

## Viewing the Picture from the Connected Device

1. Plug in the TV (see page 16 for details) and the device, if they aren't already plugged in.
2. Turn on the TV and the device you want to view, for example a DVD player.
3. Repeatedly press the INPUT button on the remote control until you see VID1 (if connected to the VIDEO INPUT 1 jacks), CMP1 (if connected to the CMP1 jacks) or HDMI1 (if connected to the HDMI1 jack) displayed at the bottom of the TV's screen. To go back to viewing TV channels, use the number buttons to enter the channel you want to view.

**Note:** *If the picture from the DVD player appears black and white and your device is connected to the VIDEO INPUT, you might be tuned to the wrong input. Make sure you press INPUT until you see VID1, CMP1 or HDMI1 displayed at the bottom of the TV's screen.*

### **Note:**

- *If you're done connecting devices to your TV, go to page 17 to complete the Initial Setup.*
- *To continue connecting devices, go to the next page.*

## Viewing the PC

1. Plug in the TV and the PC, if they aren't already plugged in.
2. Turn on the TV and the PC.
3. Repeatedly press the INPUT button on the remote control until you see PC displayed at the bottom of the TV's screen. To go back to viewing TV channels, use the number buttons to enter the channel or press CH+ or CH- buttons.

**Note:** *If you're done connecting devices to your TV, go to page 17 to complete the Initial Setup.*

## Plug in the TV

Plug the end of the power cord into the back of the TV. Plug the other end into an outlet. Insert the plug completely into the outlet. Do not plug into an outlet controlled by a light switch.

## Put Batteries in the Remote

- Remove the battery compartment cover from the back of the remote by pushing the tab and lifting off the cover.
- Insert two fresh batteries. Make sure the polarities (+ and -) are aligned correctly.
- Replace the cover.

## Turn on the TV

Turn on your TV by pressing the Power button(  ) on the side of the TV or ON•OFF on the remote control.

## How to Use the Remote Control to Complete the Initial Setup

The technical term is “Navigation” - how you move through the on-screen menus. The theory is the same throughout the menu screens: highlight your choice and select it.

To highlight a menu item, press the arrow buttons on the remote to highlight one of the items listed on the screen. Use the up or down arrow button to move up or down. Use the right or left arrow button to view other selections for a menu choice or to display a sub-menu.

***Note:** Highlighted means that the menu item stands out from other menu items on the list (appears darker, brighter, or a different color).*



# Complete the Initial Setup

The menu system in your TV allows the TV's features to work properly. The first time you turn on your TV, the language screen appears.

## Set the Menu Language

The first part of the setup allows you to select your preferred language for the menu system. If *English* is your preferred language, press OK and go to set the TV Location Mode. To choose another language, press the down arrow button until that language is highlighted, and press the OK button.

## Set the TV Location Mode

After choosing the Language, a menu screen will ask you to set the TV Location. Choosing "Home" for the TV Location assigns the optimal picture settings for most home environments. This is also the most energy efficient setting. Press OK, the picture mode will automatically be set to "Natural" and the Channel Setup menu will display.

If choosing "Retail", which is not Energy Star compliant, press OK to display "Proceed" and "Go Back". Choosing "Go Back", press OK to return to the previous menu which allows the selection of retail and home modes. If choosing "Proceed", press OK, the picture mode will automatically be set to "Vibrant" and the Channel Setup menu will display.

## Complete Channel Setup

Make sure you've connected the TV to cable or an off-air signal before you start the next part of the setup.

### Set the Signal Type

From the Channel Setup menu, press the up or down arrow button to highlight *Signal Type*, if you connect the Cable to your ANTENNA/CABLE INPUT jack, the option is chosen for you and you can press the down arrow button to continue. To choose *Antenna*, press the right arrow button and then press the down arrow button to continue.

### Complete the Channel Search

With *Channel Search* highlighted, press OK to begin the channel search. There are several things to be aware of when the TV searches for channels. If you chose *Cable* as your signal type, the search takes a while because it's looking for analog and digital channels, and then it's removing scrambled channels found. Here is what happens during the search:

1. The search first looks for analog channels and places the number of channels found next to *Analog Channels Found*.
2. The search then looks for digital channels and places the number of channels found next to *Digital Channels Found*. This number may seem high. This is because the number includes both scrambled (for example, Pay Per View) and non-scrambled channels. These channels are dependent upon what your cable company is sending.
3. The search might appear as if it is complete, but as long as the search says *Running*, it is still in progress. What's happening now is the TV is removing scrambled channels from the channel list. When Channel Search is in progress, you can press the CANCEL button to cancel the search. Any channels already found will be stored.
4. When the search is complete, the Channel Setup menu will display the following help text: "*Channel Search complete. Press OK to review channels, Press CANCEL to exit, MENU for Setup menu*". If it's the TV's first installation, the help text will display like this "*Channel Search complete. Press OK to review channels. Press CANCEL to exit.*"

You might find there are still some channels in your list that are unavailable to view. To get rid of these channels, press MENU and choose *Setup*. Highlight and select *List and Labels*.

Note that removing channels from your channel list may be time consuming, so you might want to do it later. Go to page 38 for details on editing your channel list.

**Note:** If you are using a satellite or cable set-top box, you do not need to complete Channel Search.

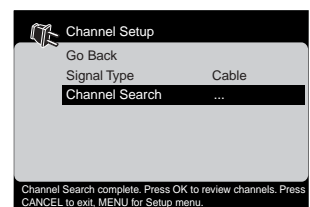
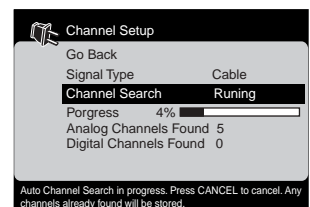
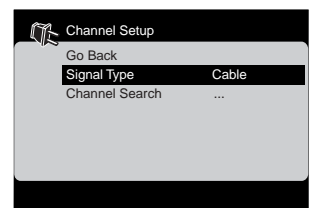
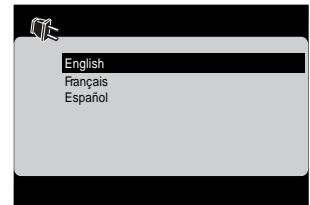

# What To Expect

## Watching TV

- **Remember:** Look for an *A* at the bottom of the screen to see if you're watching an analog channel.  
Analog video is sent in a 4/3 format, or your TV can display these channels in a 16/9 format by pressing the **FORMAT** button to view the different formats available. Go to page 35 for more explanation of screen formats.
- **Remember:** Look for a *D* at the bottom of the screen to see if you're watching a digital channel.  
Most digital video is sent in a 16/9 format which does fill your screen, but it is sometimes sent in 4/3 which does not fill your screen. It depends on how the station or source device is formatting the video. **If there are bars on-screen, press the FORMAT button to try a different format. This may eliminate the bars.** Some bars can't be removed because of the way the format is sent by the broadcaster. Go to page 35 for more explanation of screen formats.

## Changing Channels

- Digital channels can have both primary channels (like the analog channel number) and sub-channels. To tune to a digital channel with a sub-channel, such as 10.1, enter the primary channel number (10), then press the right arrow button. Enter the sub-channel number (1) and press OK.
- Depending upon the type of signals you have connected to your HDTV, you might notice that the channels change slower than you're used to. This is perfectly normal. Digital cable channels sometimes take longer to tune.

# Explanation of Jacks (in alphabetical order)

This section describes the jacks on the back panel of your TV. There are several ways to connect devices.

**ANTENNA/CABLE INPUT** Lets you connect a coaxial cable to receive the signal from your antenna, cable, or cable box.

**AUDIO/VIDEO INPUT 1 (VID1)** Lets you connect a device that has composite video jacks, such as a VCR or DVD player.

- **L AUDIO** Provides left audio connection when using the VIDEO INPUT 1 jack. The left audio connectors are usually white. For mono audio sources be sure to use the Left AUDIO INPUT.
- **R AUDIO** Provides right audio connection when using the VIDEO INPUT 1 jack. The right audio connector is usually red.

**COMPONENT INPUTS** Lets you connect a device that has component VIDEO jacks, such as a DVD player.

- **CMP1 Y Pb Pr (Component Video)** Provides optimum picture quality because the video is separated into three signals. Use three video-grade or component VIDEO cables for the connection. When using CMP1 Y Pb Pr, make sure you connect left and right AUDIO cables to the CMP1 L and R AUDIO jacks.
- **CMP1 L AUDIO** Provides left audio connection when using the CMP1 VIDEO inputs. The left audio connector is usually white. For mono audio sources be sure to use the Left AUDIO INPUT.
- **CMP1 R AUDIO** Provides right AUDIO connection when using the CMP1 VIDEO INPUTS. The right audio connector is usually red.
- **CMP2 Y Pb Pr (Component Video)** Same as described for CMP1 Y Pb Pr and CMP1 AUDIO above. Make sure you connect the left and right AUDIO cables to the CMP2 L and R AUDIO jacks.

**DIGITAL AUDIO OUTPUT (optical)** Use a digital optical cable to connect your TV to a compatible audio receiver.

**FIXED AUDIO OUTPUT** Use left and right AUDIO cables to connect your TV to a compatible audio receiver.

**HDMI1 INPUT** Lets you connect a device, such as a digital cable box, with an HDMI output.

**HDMI2/DVI INPUT** Lets you connect a device, such as a digital cable box, with an HDMI or a DVI output.

- **HDMI2/DVI INPUT** (High-Definition Multimedia Interface/Digital Visual Interface) Provides an uncompressed digital connection that carries both video and audio data by way of an integrated mini-plug cable. Since HDMI technology is based on Digital Visual Interface (DVI), the jack on the back of your TV is also compatible with DVI devices.
- **DVI AUDIO L (used for DVI only)** Provides left audio connection when using the HDMI2 jack for DVI. The left audio connector is usually white. For mono audio sources be sure to use the Left AUDIO INPUT.
- **DVI AUDIO R (used for DVI only)** Provides right audio connection when using the HDMI2 jack for DVI. The right audio connector is usually red.

**PC VIDEO INPUT** Connect your computer, or other device with a VGA OUTPUT, to this jack using a 15 pin D-sub cable.

**PC AUDIO (Stereo mini jack)** Use to obtain sound when a PC is connected to the PC INPUT. Use a 3.5mm stereo mini pin cable (sometimes referred to as 1/8" stereo mini pin) to connect a PC to your TV.

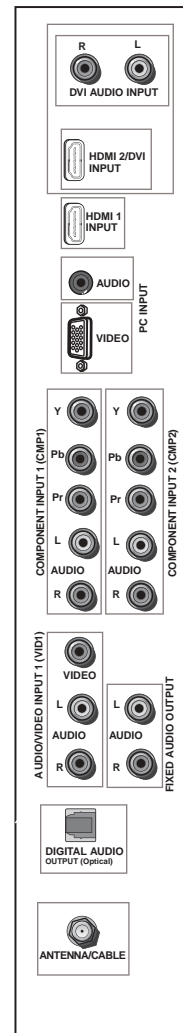

**Note:** Remember to connect the left and right AUDIO cables because the DVI cable carries only the picture signal, not the sound.

# Buttons and Other Jacks On Your TV

## Side Input Jacks

**Headphones** Allows you to connect headphones to listen to the sound coming from the TV.

**VIDEO INPUT 2** Receives video from another device such as a camcorder, video game console, VCR, or DVD player. To access a device connected to the VIDEO jack, press the INPUT button on your remote until VID2 appears at the bottom of the screen.

**AUDIO L and R** Receives audio from another device such as a camcorder, video game console, VCR, or DVD player. Use when connecting to the VIDEO or S-VIDEO INPUT. For mono audio sources be sure to use the Left AUDIO INPUT.

**S-VIDEO INPUT** Allows you to connect an S-Video cable from another device. Make sure you also connect audio cables from the device to the TV. To access a device connected to the S-VIDEO jack, press the INPUT button on your remote until VID2 appears at the bottom of the screen.

**HDMI 3 INPUT** Lets you connect a device with an HDMI OUTPUT.

**USB** This connection allows you to plug in a USB flash drive or connect to a compatible mass storage device with USB.

*Note: Do not connect an S-Video and a regular video cable to the side jacks at the same time.*

## Side Panel Buttons

If you cannot locate your remote, you can use the side panel buttons of your TV to operate many of the TV's features.

**⏻ POWER** Turns the TV on and off.

**MENU/(OK)** Brings up the TV Main menu. When in the menu system, it displays sub-menus and selects highlighted items.

**VOL ▶** Increases the volume. In the TV menu system, it acts like the right arrow button on the remote control and adjusts menu controls.

**VOL ◀** Decreases the volume. In the TV menu system, it acts like the left arrow button on the remote control and adjusts menu controls.

**CH▲** Scans up through the channel list. In the TV menu system, it acts like the up arrow button on the remote control and adjusts menu controls.

**CH▼** Scans down through the channel list. In the TV menu system, it acts like the down arrow button on the remote control and adjusts menu controls.

** (FETCH=MENU + VOL ▶)** Press the MENU and VOL ▶ at the same time and the remote control will bark to be located. (This Fetch function is only available for models L42FHD38, L46FHD38, L52FHD38 and L40FHD380.)

## 2 Using the Remote Control

### Remote Control Buttons

**Alphanumeric Buttons** Enter channel numbers, time settings, and options with letters, using these buttons.

To enter a channel, press the number buttons and press OK (or just let the entry timeout).

To enter a digital channel with a sub-channel, enter the main channel, then press the right arrow button to enter the sub-channel and press OK.

**Arrows (◀/▶/▲/▼)** Used to highlight different items in the TV menu and to adjust the menu controls. When viewing a channel, arrow functions are as follows:

- **Left arrow/FORMAT** Press to change the screen format: *Normal, Zoom, Cinerama, Stretch*. Go to page 35 for more information on screen formats.
- **Right arrow/GUIDE** Press this button first to display the electronic program guide-EPG (when available), press again to view the program in the schedule.
- **UP arrow/INFO** Press this button once to display the channel banner, press again to remove the menu.
- **Down arrow/PRESETS** Press this button to enter the PRESET menu. Display *Picture and Sound preset; CC Setting; Current Audio Track*.

**CC** Takes user directly into the Closed Caption submenu.

**CH + or CH -** Scans up or down through the current channel list. Press once to change the channel up or down; press and hold to continue changing channels.

**CH List** When you tune to a particular channel, press button to enter the List and Labels menu directly to add/ remove the channel from channel list.

 **(FETCH)/CANCEL** Cancels the barking when Fetch has been activated. (This Fetch function is only available for models L42FHD38, L46FHD38, L52FHD38 and L40FHD380.) Go to page 20 or 35 for more details. Cancel function: Removes any menu or display from the screen and returns you to normal viewing.

**DVD** Places the remote in DVD mode. If Autotuning is enabled, turns on the TV and tunes it to the DVD Channel. This button lights when you press a valid button in DVD mode (see Modes of Operation on page 24 for more details).

**F1-F4** Favorite channel buttons. You can set one of the favorite channel buttons (F1/F2/F3/F4) to the current channel by holding the button for a couple of seconds. Each button can be set to a favorite channel at one time, but you can change the setting many times.

**GO BACK** Returns you to the previous channel.

**INPUT** Accesses the available video input channels (*VID1, VID2, CMP1, CMP2, PC, HDMI1, HDMI2 and HDMI3*). To resume TV viewing, press the number buttons to enter the channel or press CH+ or CH- buttons.

**MENU** Brings up the Main Menu.



**Remote control part number RC2254701/01**

This is a multi-device remote control and many of the buttons have multiple functions.

**Note:** If you need to replace your remote, call 1-800-338-0376. A shipping and handling fee, and the appropriate sales tax, will be charged upon ordering. Have your Visa, MasterCard, or Discover Card ready.

**MUTE** Reduces the TV's volume to its minimum level. Press again to restore the volume.

**OK** When in the menu system, selects highlighted items.

**PIC** Press to display the *Picture* submenus.

**ON•OFF** When in TV mode, turns the TV on or off. If in another mode (SAT/AUX or DVD) and programmed, will turn the device on or off.

**REW, REPLAY, PLAY, NEXT, FWD, REC, STOP, PAUSE (buttons at TOP of the remote)**  
If programmed, provides transport control for some remote-controllable devices, for example, VCRs or DVD players.

**ZZZ (SLEEP)** Press to display the *Time* menu and set *Sleep Timer*.

**SAT/AUX** Places the remote in SAT/AUX mode. If Autotuning is enabled, turns on the TV and tunes it to the satellite or cable box Video Input Channel. This button lights when you press a valid button in SAT/AUX mode (see Modes of Operation on page 24 for more details).

**TV** Turns on the TV and puts the remote in TV mode. Also displays current status.

**V-CHIP** Press to display the Parental Control submenu directly.

**VOL - or VOL +** Decreases or increases the TV's volume.

### **Using the INPUT Button**

Use the INPUT button to scroll through the available video input channels and view devices you have connected to the TV.

1. Make sure the device you want to view is turned ON.
2. Press INPUT to tune to an available video input source and view the device.
3. To return to the previous channel, press INPUT until you return to the channel.

## Programming the Remote to Operate Other Devices

The universal remote can be programmed to operate many brands of remote-controllable VCRs, audio devices, DVD players, cable boxes, satellite receivers and other devices. In addition to being programmed to operate your television, it's already programmed to operate some RCA devices.

### **Notes:**

- *The TV button can't be programmed on this remote to control any device; it controls only this TV.*
- *The remote may not be compatible with all models of all brands of devices. It also may not operate all functions of your device.*

### **Find Out If You Need to Program the Remote**

To determine whether the universal remote needs to be programmed to operate one of the devices connected to your TV, such as a DVD player, do the following:

1. Turn on the device (in this example, a DVD player).
2. Point the remote at the device.
3. Press the corresponding device button (in this example, DVD player).
4. Press ON•OFF to see if the DVD responds. If the DVD doesn't respond, you need to program the remote to operate it.

## Programming the Remote

The CANCEL button is used as visual feedback during the programming operation. During programming, the CANCEL button will light up when buttons are pressed and turn off when buttons are released. When programming is finished, the CANCEL button will long blink to indicate success and short blink to indicate fail.

**Note:** All device buttons are off during programming mode.

There are 3 ways to program the remote control to operate other devices: Direct Entry, Manual Code Search, and Automatic Code Search. If you have recently purchased the device you want to control or if the device has many codes, you might want to try the manual code search first.

### Using Direct Entry

1. Turn on the device you want to control.
2. On your remote control, simultaneously press and hold the ON•OFF and MUTE buttons (approximately 3 seconds) until the CANCEL button lights up. Then release the buttons.
3. Press and release the device button (SAT/AUX or DVD) you want to program.
4. Enter a 4-digit code from the code list. The first digit indicates the database device type (0 for DVD, 1 for Satellite TV, 2 for Cable, 3 for DVR, 4 for VCR, 5 for Audio, 6 for CD), the other 3 digits indicate the brand. Look up the brand and code number(s) for the device in the code list at the end of this section.
5. The CANCEL button will long blink to indicate success. Repeat these steps until you've tested all codes for your device's brand or try to run a manual code search.

### Using a Manual Code Search

**Note:** Before using manual code search, you must use Direct Entry first. This lets the remote know which type of device to begin searching codes. Then proceed with the following steps.

1. Turn on the device you want to control.
2. On your remote control, simultaneously press and hold the ON•OFF and MUTE buttons (approximately 3 seconds) until the CANCEL button lights up. Then release the buttons.
3. Press and release the device button (SAT/AUX or DVD) you want to program.
4. Repeatedly press and release the left arrow or right arrow button, watching for the device to respond. If it does turn off, press and release the OK button to save the code. The CANCEL button will long blink to indicate success.
5. When all codes have been searched, the CANCEL button will short blink to indicate fail, then the remote returns to normal operation.

**Note:** Use right arrow to search ahead, use left arrow to search back. Or you can press the ON/OFF button to switch to Auto Code Search mode.

### Using Automatic Code Search

1. Turn on the device you want to control.
2. On your remote control, simultaneously press and hold the ON•OFF and MUTE (approximately 3 seconds) buttons until the CANCEL button lights up. Then release the buttons.
3. Press and release the device button you want to program.
4. Press and release the ON•OFF button once. The remote starts the code search.
5. Once the device turns off, quickly press the OK button to save the code. The CANCEL button will long blink to indicate success.
6. When all codes have been searched, the CANCEL button will short blink to indicate fail, then the remote returns to normal operation.

**Note:** If you accidentally passed the code before saving it, press the left arrow button to backtrack through the codes; then use the right arrow button to go forward through the codes again. Once the left arrow or right arrow button has been pressed, the search mode changes to Manual Code Search.

# How to Use the Remote After You've Programmed It

**Note:** *The remote control may not be compatible with all brands and models of devices.*

Once the remote has been programmed successfully, you are ready to use it to operate your devices.

To operate the device:

1. Press the appropriate device button (SAT/AUX or DVD) to set the remote to control the device, for example, press DVD to control your DVD player.
2. Press ON•OFF to turn the device ON or OFF.
3. Use the remote buttons that apply to that device.

## **Modes of Operation**

The button corresponding to the mode the remote is in lights up when you press any button that works in that mode. For example, if you're in TV mode and you press the VOL+ button, the TV button lights up. This tells you that the command to increase the volume is being sent to the TV (and not the satellite receiver, for example).



## Manual Reset of the Remote Control

The Manual Reset is used to reset the remote settings to default.

**Note:** *The reset can also be done by replacing the batteries, but replacing the batteries does not always cause a reset, so you can perform a manual reset if the remote doesn't reset after battery replacement.*

1. On your remote control, simultaneously press the V-Chip, ON•OFF and MUTE buttons.
2. The CANCEL button will long blink to indicate success, and the remote control returns to normal operation.

# Remote Code List

**Note:** The codes are programmable to any of the device buttons (SAT /AUX or DVD) on the remote. The remote code is a 4-digit code. The first digit indicates the database device type (0 for DVD, 1 for Satellite TV, 2 for Cable, 3 for DVR, 4 for VCR, 5 for Audio and 6 for CD), the following 3 digits indicate the brands as follows:

## Audio Codes

Accuphase	032
Accurus	033
ADC	074
Adcom	056
Admiral	150
ADS	151
Aiwa 014 072 073 109 214 225 279 287 335 369	
Akai	142
Alco	093
Alpine	152
Altec Lansing	140
Amphion Media Works	104 107
Amplifier Technologies	118
AMW	104 107
Anam	080 148
Angstrom	034
Apex	403 407 095
Aragon	033
Arcam	131
Atlantic technology	120
Audio Research	154
Audio Source	035
AudioPhase	388
Audiotronic	061
Audiovox	093 399 417
B & K	155
Bang & Olufsen	353
Bel Canto Design	036
Biamp	037
BOSE	010 075 082 117 371 384
Boston Acoustics	121
Brix	146
California Audio Lab	028
CambridgeSoundWorks	418
Cpetronic	074
Carver	061 073
Cary Audio Design	031
Casio	125
CCE	177
Chase Technologies	029
Cinema Sound	038
Clarinet	125
Clarion	156
Classe	039
Classic	411
Coby	018
Counterpoint	157
Creative	129
Criterion	136
Curtis	409
Cary Audio Design	031
Curtis	409
Curtis Mathes	022
Daewoo	132
Dell	134
Delphi	158
Denon	009 058 090 205 220 226
227 242 259 263 267 282 286 304 305 309 310	
311 312 315 341 344 345 368 413	
Digital Audio Control	030
Durabrand	040 434
EAD	159
Eclipse	209
Elan	041
ESA	160
Fisher	114
Fosgate	042
Garrard	128
Gateway	145
GE	020
Glory Horse	133
Go Video	144
GPX	404 421
Gradiente	389
Halfer	161
Harman/Kardon	013 026
073 078 088 264 319 397	
Hitachi	114
Honyas	162
iLive	429
Initial	137
Inkel	122

Insighia	337 338 416
Integra	055
Jamo	275
JBL	051 088 397
Jensen	163
Jerrold	391
JVC	004 023 092 097 201231 249 261 272
273 300 303 307 318 355 359 360 366 373 376	
377 408	
Kenwood	005 089 105 106 185 186 188
189 198 200 219 223 232 237 240 251 255 296	
308 320 331 370 380	
KLH	093 094
Knoll System	043
Koss	091 394
Krell	326
Lasonic	149
Left Coast	026
Lenox	138
Lexion	130
LG	406 432
Linn	073
Liquid Video	141
Lloyds	125
Logitech	044
Luxman	045
LXI	124
Magnadyne	164
Magnavox	016 061 073 074 100 401
Marantz	026 061 073 329 340
Mark Levinson	046
McIntosh	047
MCS	126
Memorex	165
Midland	048
Mitsubishi	290 313
Modulaire	125
Motorola	139
NAD	066
Nakamichi	065 067 070
NEC	027
Neo	158
Nexxtech	119
Niro	166
Norcent	135
Nova	167
Omnifi	147
Onkyo	006 055 057 069 077 101 190 194 203
210 213 233 252 260 265 266 269 270 271 274	
278 291 292 306 323 324 348 350 398	
Optimus	022 074 076 079 080
Oritron	091
Panasonic	002 087 102 108 112 113 153
229 289 301 316 354 357 364 375 385 386 390	
395 396 422 423 424 425 426 427 433	
Parasound	062
Penny	125
Philco	168
Philips	012 026 061 073
085 349 362 379 412	
philips Magnavox	435
Pioneer	003 022 052 071 074 079 183
184 192 193 195 212 221 222 224 238 239 241	
353 314 330 336 342 343 346 352 383	
Polaroid	436
Polk Audio	026 073 328
Proscan	083
Pyle	169
Radio Shack	133 434
RCA	007 022 074 079 080
083 093 099 363 367 372 380 393 434	
RCA & Dimensia	437
Realistic	125
Regent	138
Rio	116
Rotel	334
Saba	143
Samsung	011 068 098 332 428 431
Sansui	073
Sanyo	096 114 414
Schneider	170
Scientific Atlanta	127
Scott	123
Sharp	015 361 378 419
Sharp Image	133

Sherwood	297 339 420
Shinsonic	171
shure	027
Skyfi	158
Sonic Blue	116
Sony	000 025 050 084 103 110 111
115 178 179 180 181 182 187 197 207 215 216	
217 218 230 235 276 277 293 294 295 325 356	
358 365 374 382 387 392 400 430	
Soundesign	020 076
Soundmatters	063
SoundStream	049
Starcom	391
Stereophonics	079
STS	172
Sunfire	089
Sylvania	327
Symphonic	150
TAG McLaren	173
Tao	158
Teac	080 093
Technics	008 204 208 211 228
280 281 283 299	
Techwood	174
Thomson	175
Thorens	061
Toshiba	410
Vector Research	176
Venturer	093 415
Victor	023
Wards	020 071 073 346
XM Radio	158
Yamaha	001 021 024 053 054 055
059 060 064 081 086 191 196 199 206 234 236	
243 244 245 246 247 262 268 284 285 288 302	
317 321 347 351 402 405	
Yorx	125
Zenith	019 333 406

## Cable Codes

ABC	008 009 022 026 032 034
040 041 042 081 085	
Adelphia	005 025
Americast	092
Antronix	045 046
Archer	046 047
AT & T	002
Bell South	092
Cable Vision	004 102
Cabletenna	045
Cableview	044
Citizen	051
Clearmaster	091
ClearMax	091
Colour Voice	049 050
Comcast	000 001 039
Comtronics	035 051
Contec	026 031 053
Coolmax	091
COX	001
Director	001 089
Eastern	054
Everquest	035 086
Focus	088
GC Electronics	046 051
GE	040 041
Gemini	055 056 086
General Instrument	000 001 041 083 089 101
Goldstar	035 036
Hamilin	057 058 059 065 071 074 082 095 096
Hitachi	041
illico	102
Jasco	086
Jerrold	001 041 055 060 061 075 081 083
086 087 089 101	
Magnavox	062
Memorex	063 085
Monarch	051
Motorola	001 002 018 039 087 089 094 101 103
Movie Time	051 064
Multi Canal	051
Multitech	091
NEC	043

NET Brazil	006
Novavision	027
NSC	064
Oak	053 066
Pace	007 008 009 010 011 012 013 014 015 016 017 022 024 025
Panasonic	077 080 085
Paragon	085
Philips	048 049 050 052 056 062 067 068 069 098 099
Philips Magnavox	056 098
Pioneer	007 019 024 025 036 037 070 084 090 102
Popular Mechanics	088
Proscan	040 041
Pulsa	051 085
Quasar	085
Radio Shack	086 091
RCA	044 076 078 080 083
Realistic	046
Recoton	088
Regal	059 071 082 096 097
Regency	054
Rembrandt	041
Rogers	102
Runco	085
Samsung	035 036 037 038 051
Scientific Atlanta	002 005 007 008 009 019 020 022 023 024 025 026 027 028 029 030 031 032 033 034 102
Signal	035 051 055 086
Signature	041
SL Marx	035
Sony	004 093
Sprucer	080
Standard Component	072 073
Starcom	055 081 086
Stargate	035 051 055 086
Starquest	055 086
Supercable	087 104
Supermax	091
TeleView	035 051
TIME WARNER	003 102
Timeless	035
Tocom	042 060
Toshiba	085
Tristar	091
Tusa	055 086
TV86	064
U.S.Electronics	026
Unika	045 046
United Cable	081
Universal	045 046 047
V2	091
Verizon	105
Videotron	102
View Star	053 062 064
Vision	091
Vortex View	091
Zenith	079 085 092 100
Zentek	088

## CD Codes

Aiwa	009
BOSE	011
Denon	007 019
Harman/Kardon	004
JVC	001 013 025 026
Kenwood	010 014
Marantz	015
Onkyo	006 016
Panasonic	000 017 023 029
Philips	003 032
Pioneer	005
RCA	028
Sanyo	022
Sharp	002
Sherwood	020
Sony	012 024 027 030 031
Teac	021
Technics	008
Yamaha	018

## DVD

Accele Vision	177
Accurian	353
Advent	029

Aiwa	017 232
Akai	022 236
Alco	027
Allegro	059
Alpine	220
Amphion MediaWorks	014 033
AMW	014 033
Anaba	067
Anam	068
Apex	005 045 046 126 136 164 166 176 188 242 243 244 324 390 457 461
Apple	426
Argo	050
Aspire	032
Astar	351
Audiologic	069
Audiovox	004 011 027 224 454 471 475
Axion	070
B & K	071
Bang & Olufsen	048
Bel Canto Design	072
Blaupunkt	046 153
Blue Parade	043
BOSE	245 430 441
Boss Audio System	073 444
Broksonic	022 233 372 406
California Audio Labs	024
CambridgeSoundWorks	474
CAVS	074
CineVision	049 113 414
Clarion	246
Classic	216 247 463
Coby	012 030 031 157 192 206 451
Criterion	075
Curtis	451
Curtis Mathes	060
CyberHome	006 050
Cytron	491
Daewoo	141 234 271 419
Denon	004 024 116 165 175 195 296 467
Diamond/Vison	289
Disney	010 140
Dual	076
Duarabrand	027 051 054 113 259
DVD2000	040
Eclipse	301
Elta	084
Eltax	064
Emerson	010 023 052 248 391 395 465
Enterprise	056
ESA	052 235
Fahrenheit	077
Fisher	249 280
Flex Vision	078
Fun TV	079
Funai	010 052 340 379 391
Gateway	323
GE	041 046 125 167 205 250
Go Video	003 187 226 227 323 402 404 413 418 420 421
Goldstar	425
GPX	251 278 451 458
Gradiente	024 274
Greenhill	046
Grundig	042
Harman/Kardon	199 210
Hitachi	003 144 200 217 299 376 417
Hitek	045
Honda	080
Honyas	081
iLive	484
iLo	053
Ingelen	105
Initial	046
Insignia	013 052 113 375 470
Integra	025 043 057 062
Irradio	346
Jamo	082
Jaton	083
JBL	452
Jenken	106
Jensen	031
JMB	107
JVC	007 044 142 143 207 212 219 269 281 317 318 319 321 364 365 366 367 397 398399 400 403 409
Jwin	084
Karcher	108
Kawasaki	027

Kendo	109
Kenwood	004 024 116 198 204 214 230 231 252
KLH	027 046 147
Konka	018 019
Koss	015 026 035 448
Lasonic	253
Landel	222
Lenox	034 051 054
Lexia	110
Lexicon	085
LG	013 284 331 333 352 369 370 373 460 486 488
Lifetec	111
Limit	110
Liquid Video	035
Liteon	323 332 348 353
Loewe	086
Logiclub	104
Logix	112
Luxman	113
Luxor	109
Magnavox	010 023 039 042 052 150 156 185 326 356 380 388 437 456
Malata	087
Marantz	042 156 275
Memorex	010 022 140 254
Microsoft	041
Mintek	046 255
Mitsubishi	016 038 040 161 194
Momitsu	088
Mustek	458
NAD	248 256
Nakamichi	257
Nesa	046
Next Base	058
Nexxtech	055 276
Niro	089
Nissoho Iwai	079
Norcent	030 222 237 258 279
Onkyo	025 039 159 190 225 453
Opko	047
Optiview	067
Oritron	026 035 260
Orion	022
Panasonic	004 024 039 116 117 127 149 152 172 173 178 208 265 266 267 290 291 292 299 300 312 336 341 371 383 385 386 387 407 431 432 434 436 438 443 449 450 476 477 478 479 480 489 490
Philco	065
Philips	002 010 039 042 150 156 162 196 209 294 305 334 337 342 391 437 448
philips Magnavox	162 209 337
Pioneer	009 036 043 134 146 160 170 181 193 201 203 238 282 295 313 314 315 339 377 429
Polaroid	014 390 423
Polk Audio	042
Portland	090
Presidian	010 391
Prima	091
Princeton	092
Proceed	045
Proscan	041 125 184
Provision	093
Pye	356
Qwestar	026 239 260
RCA	000 008 027 041 043 046 125 130 179 184 191 197 228 288 338 389 401 411 422 447
regent	034
Rio	066
Rotel	044
Rowa	028
Saba	094
Sampo	261
Samsung	003 024 120 124 139 145 148 183 189 285 293 322 325 330 336 355 357 368 384 396 405 412 415 439 445 472 481 485 487
Sansui	022 233 378
Sanyo	022 280 347 424 468
Sensory Science	323
SEG	014
Sharp	010 128 137 320 343 344 374 379 410 473
Sharper Image	095
Sherwood	262 474
Shinco	166 240
Shinsonic	037
Sigma Designs	092

Sonic Blue	.....059 061 063 066
Sony	.....001 020 037 115 118 121 122 123
131 133 135 154 155 158 163 168 223 229 268	
283 306 307 308 335 354 358 360 362 381 392	
394 427 428 433 435 440 442 446 455 464 466	
482 483	
Sungale	.....270
Superscan	.....023
SVA	.....096
Sylvania	.....010 023 052 340 391 395 416
Symphonic	.....010 391
Teac	.....027 224
Technics	.....004 024
Technosonic	.....097
Techwood	.....241 263
Terapin	.....098
Theta Digital	.....043
Tivo	.....099
Toshiba	.....002 021 022 039 119 129 132
138 171 180 182 286 297 302 303 304 309 310	
311 316 327 328 329 359 363 382 393 408 462	
Tredex	.....100
Trutech	.....273
TView	.....067
Urban Concepts	.....039
US Logic	.....224
Venturer	.....027 469
Vizio	.....101
Vocopro	.....102
Westinghouse	.....492
Xbox	.....041
Xwave	.....103
Yamaha	.....024 042 116 150 169 174
196 202 211 215 218 277 345 459	
Zenith	.....013 039 113 151 186 213 227 264
298 349 350 369 425 460	
WHITE WESTINGHOUSE	.....492

### DVD/VCR Combo Codes

Where the code is listed as [### #] the first is for the DVD and the second is for the VCR. Otherwise just the one code operates both the DVD and the VCR. Remember to add the code for the database device type 0 for DVD, 4 for VCR, [0### 4###].

Broksonic	.....[372 062] [022 072] [406 088]
Hitachi	.....[376 013] [417 103]
Insignia	.....[375 016] [013 047] [113 117]
JVC	.....[364 052] [365 053] [366 054]
[367 055] [317 056] [318 058] [319 059] [403 094]	
[397 079] [398 080] [399 081] [400 082] [403 085]	
[409 095] [317 056] [318 058] [319 059]	
LG	.....[369 016] [373 060] [013 047]
[331 060] [370 060]	
Pioneer	.....[377 064]
Sansui	.....[378 065] [022 072]
Sharp	.....[374 124] [379 125] [410 111]
Toshiba	.....[363 051] [382 067] [119 091]
[119 096] [393 076] [408 092] [393 115]	
Zenith	.....[369 016] [151 116] [227 099]
Apex	.....[390 074]
CineVision	.....[113 101] [414 117]
Daewoo	.....[419 107]
Durabrand	.....[113 117]
Emerson	.....[395 010] [395 103]
Funai	.....[379 125]
Go Video	.....[227 100] [402 084] [404 086]
[413 087] [418 106] [420 108] [421 109]	
Goldstar	.....[425 114]
Magnavox	.....[156 009] [380 126] [156 104]
[388 071]	
Memorex	.....[022 072]
Panasonic	.....[383 061] [385 068] [386 069]
[407 089] [407 105] [371 061]	
Philips	.....[156 009] [391 075]
Polaroid	.....[390 074] [423 112]
Presidian	.....[391 075]
RCA	.....[389 073] [401 083] [411 097] [422 110]
Samsung	.....[368 005] [384 070] [396 078]
[405 087] [412 098] [415 087]	
Sanyo	.....[424 113]
Sony	.....[360 048] [361 049] [362 050]
[381 066] [392 093] [394 093] [394 077] [392 090]	
Sylvania	.....[391 075] [395 102] [416 103]
Symphonic	.....[391 075]
Diamond Vision	.....[289 126]
AKAI	.....[236 127]
Superscan	.....[023 128]

### DVR Codes

ABS	.....020
Alienware	.....020
AT&T	.....030
Bang & Olufsen	.....023
Cyberpower	.....020
Dell	.....020
DIRECTV	.....002 007 008 010 011 012 015
019 021 024 026 027	
Dish Network	.....017 018
Dishpro	.....017
Echostar	.....017 018
Expressvu	.....017
Gateway	.....020
GO!	.....017
Hewlett Packard	.....020
HNS	.....009
Highr Computers	.....020
HP	.....020
HTS	.....017
Hughes	.....001 010 011 012 015
Hughes Network System	.....001 010011
012 015 024 026 027	
Humax	.....015
Hush	.....020
iBUYPOWER	.....020
JVC	.....001 017 018
Linksys	.....020
Media Center PC	.....020
Microsoft	.....020
Mind	.....020
Niveus Media	.....020
Northgate	.....020
Panasonic	.....005 022 030
Philips	.....001 009 012 015 024 025
Pioneer	.....031
Proscan	.....019
RCA	.....001 002 009 016 019 021
ReplayTV	.....004 022 030
Samsung	.....009 024
Sonic Blue	.....004 022 030
Sony	.....000 013 014 020
Stack 9	.....020
Systemax	.....020
Tagar Systems	.....020
Tivo	.....000 001 002 003 010 013
014 015 025 026 027 028	
Toshiba	.....006 020
Touch	.....020
UltimateTV	.....021
Viewsonic	.....020
Voodoo	.....020
ZT Group	.....020

### Home Theatre in a Box

Where the code is listed as [### #] the first is for the DVD and the second is for the AUDIO. Otherwise just the one code operates both the DVD and the AUDIO. Remember to add the code for the database device Type, 0 for DVD, 5 for Audio [0### 5###].

Apex	.....[457 403] [461 407]
Audiovox	.....[471 417] [475 399] [454 399]
BOSE	.....[430 384] [441 010]
CambridgeSoundWorks	.....[474 418]
Classic	.....[463 411]
Coby	.....[451 018]
Curtis	.....[451 409]
Denon	.....[467 413]
Emerson	.....[465 017]
GPX	.....[451 421] [458 404]
iLive	.....[484 429]
Insignia	.....[470 416]
Jamo	.....[082 275]
JBL	.....[452 397]
Koss	.....[448 394]
LG	.....[284 432] [460 406] [486 406]
[488 406]	
Magnavox	.....[437 016] [456 401]
Onkyo	.....[453 398]
Panasonic	.....[431 385] [432 390] [434 386]
[436 385] [438 385] [449 395] [450 396] [476 422]	
[477 423] [478 425] [479 426] [480 427] [489 433]	
[490 434] [438 424]	
Philips	.....[437 016] [448 412]
Pioneer	.....[429 383]
RCA	.....[447 393]
Samsung	.....[439 011] [445 011] [481 332]
[485 431] [487 431] [481 428]	

Sanyo	.....[468 414]
Sharp	.....[473 419]
Sherwood	.....[474 420]
Sony	.....[427 382] [433 430] [435 387]
[440 430] [442 387] [446 430] [455 400] [464 387]	
[466 430] [482 430] [483 430] [433 392]	
Toshiba	.....[462 410]
Venturer	.....[469 415]
Yamaha	.....[459 405]
Zenith	.....[460 406] [425 019] [425 333]
Durabrand	.....[259 434]
JVC	.....[143 408]

### Satellite TV Codes

Alphastar	.....051
Amstrad	.....100
Chaparral	.....045
DIRECTV	.....001 006 007 008 009 010
013 014 015 031 032 034 036 039 043 044 054	
055 057 058 059 062 063 064 066 067 068 069	
074 078 079 080 081 084 086 087	
Dish Network	.....002 004 017 018 019 020
021 022 023 024 025 026 027 028 029 030 033	
035 037 041 061 083	
Dishpro	.....035 037 061
Drake	.....046
Echostar	.....002 004 033 035 037 061 071 083
Expressvu	.....037 061 07
BELL EXPRESSVU	.....071
FORTEC STAR	.....101
GE	.....063 087
General Instrument	.....047 048 056
GO!	.....061
Grundig	.....100
Hisense	.....060
Hitachi	.....009
HTS	.....061
Hughes Network Systems	.....003 006
008 015 031 043 057 064 073	
Humax	.....090
iLo	.....060
Jerrold	.....056
JVC	.....002 004 033 052 061 083
LG	.....011 059
Magnavox	.....014
Memorex	.....014
Mitsubishi	.....006 008 064 093
Motorola	.....038 056 065
Next Level	.....056
Pace	.....100
Panasonic	.....010 062 086 092 096 100
Pansat	.....088
Paysat	.....014
Philips	.....001 003 009 014 015 031
054 055 057 064 081	
Philips Magnavox	.....009 054 055
Pioneer	.....015
Primestar	.....050
Proscan	.....013 036 063 095
Proton	.....060
Radio Shack	.....056
RCA	.....000 003 013 034 040 044
058 063 075 076 077 078 080 082 091 094 095	
097	
Realistic	.....049
Samsung	.....003 007 015 057 070 085 098
Sharp	.....016
SKY NETWORK	.....100
Sony	.....005 032 042 066 074 079 084
Star Choice	.....038 056 072
STS	.....053
Sylvania	.....099
Tivo	.....003 015 057
Toshiba	.....006 008 009 064
UltimateTV	.....058
Uniden	.....014
US Digital	.....060
USDTV	.....060
Viewsat	.....089
Voom	.....056
Zenith	.....012 067

### VCR Codes

ABS	.....038
Adventura	.....010 028 125
ADMIRAL	.....097
Aiwa	.....010 028 035 125
Aiko	.....107

Akai .....	.017 018 033 127	MGN Technology .....	.021	Videasonic .....	.021
Alienware.....	.038	MGA .....	.008	Viewsonic .....	.038
American High .....	.025	Microsoft .....	.038	Villain .....	.010 125
Apex .....	.074	Midland .....	.029	Voodoo .....	.038
Asha .....	.021	Mind .....	.038	Wards .....	.010 021 022 023 025
Audio Dynamics .....	.019	Minolta .....	.030	026 028 030 125	
Audiovox .....	.022 035 121	Mitsubishi .....	.008 030	White Westinghouse .....	.036
Bang & Olufsen .....	.037	Motorola .....	.025	Westinghouse .....	.046
Beaumarck .....	.021	MONTGOMERY WARD .....	.097	XR-100 .....	.010 025 028 125
Bell & Howell .....	.020	MTC .....	.010 021 125	Yamaha .....	.019 020 024 033
Broksonic.....	.027 062 072 088	Multitech .....	.010 021 028 029 125	Zenith .....	.007 010 016 018 032 034 099 116
Calix .....	.022 035	NEC .....	.019 020 024 033	117 120 122 125	
Candle .....	.021 022 023 024	Nikko .....	.022 035	ZT Group .....	.038
Canon .....	.015 025	Niveus Media .....	.038		
CARVER.....	.104	Noblex .....	.021		
CCE .....	.107	Northgate .....	.038		
CineVision .....	.101 117	Olympus .....	.025		
Citizen .....	.021 022 023 024 035	Orion .....	.014		
Colortyme .....	.019	Panasonic .....	.000 015 025 039 061 068 069		
COLT .....	.046	089 105 118 119			
Craig .....	.021 022 026 035	Penney .....	.035		
Curtis Mathes .....	.012 015 019 021	Pentax .....	.030		
024 025		Pentax Research .....	.024		
Cybernex .....	.021	Philco .....	.015 025		
CyberPower.....	.038	Philips .....	.009 025 075 104		
Cyperpower.....	.038	Philips Magnavox .....	.104		
Daewoo .....	.011 023 027 028 107	Pilot .....	.022 035		
Davidson.....	.010 125	Pioneer .....	.030 064		
DBX .....	.019	Polaroid .....	.074 112		
Dell.....	.038	Polk Audio .....	.104		
Denon .....	.030	Presidian .....	.075		
DiamondVision .....	.126	Proscan .....	.012 043 044		
Dimensia .....	.012	PROTEC .....	.046		
Durabrand .....	.017 117	PROFITRONIC .....	.021		
Dynatech .....	.010 028 125	Pulsar .....	.007 032		
Electrohome .....	.022 035	Quarter .....	.020		
Electrohome .....	.022 035	Quartz .....	.020		
Emerson .....	.010 017 022 023	Quasar .....	.015 025		
025 027 028 035 075 103 125		Radio Shack .....	.010 022 125		
Emerex .....	.001	Radio Shack/Realistic .....	.015 020 021 022		
ESA .....	.047	025 026 028			
Fisher .....	.020 026 045	Radix .....	.022 035		
Fuji .....	.018 025	Randex .....	.022 035		
Funai .....	.010 028 036 075 125	RCA .....	.003 012 017 021 025 030 042		
Garrard .....	.010 028 125	073 083 097 110			
Gateway .....	.038	Realistic .....	.010 015 020 021 022 023 025		
GE .....	.012 015 021 025	026 028 035 125			
Go Video .....	.084 086 087 100 106 108 109	Ricavision .....	.038		
Goldstar .....	.019 022 024 035 114	Ricoh .....	.034		
Gradiente .....	.010 028 125	Runco .....	.007 032		
Harley Davidson .....	.028	Samsung .....	.005 021 023 029 070 078 087 098		
Harman/Kardon .....	.019	Sanky .....	.007 032		
HARWOOD .....	.046	Sunsui .....	.010 014 033 065 072 125		
Headquater .....	.020	Sanyo .....	.020 021 026 045 113		
Hewlett Packard .....	.038	Scott.....	.023 027		
Hi-Q .....	.026	Sears .....	.010 020 022 025 026 030 035 125		
Hitachi .....	.010 013 030 033 103 125	Sharp .....	.010 063 111 124 125		
Howard Computers .....	.038	Shintom .....	.018		
HP .....	.038	Shogun .....	.021		
Hush .....	.038	Singer .....	.025 034		
Hughes Network Systems .....	.030	SIGNATURE .....	.110		
iBUYPOWER .....	.038	Sony .....	.001 010 018 031 038 040 048 049		
Insignia .....	.016 047 117	050 066 077 090 093 123 125			
Instant Replay .....	.025	Stack .....	.038		
JC Penney .....	.015 019 020 021 022 025 0230	Stack 9 .....	.038		
JCL .....	.025	STS .....	.025		
Jesen .....	.030 033	Superscan .....	.128		
JVC .....	.004 019 020 024 033 041	Sylvania .....	.010 015 025 028 075 102 103 125		
052 053 054 055 056 057 058 059 079 080 081		Symphonic .....	.010 028 036 075 125		
082 085 094 095		Systemax .....	.038		
KEC .....	.035	Tagar Systems .....	.038		
Kenwood .....	.019 020 024 033	Tandy .....	.020		
Kodak .....	.022 025 035	Tashiko .....	.022		
KLH .....	.046	Tatung .....	.033		
LG .....	.016 022 047 060	Teac .....	.010 028 033 125		
Linksys .....	.038	Technics .....	.025		
Lloyd's .....	.010 028 125	Teknika .....	.010 022 025 028 035 125		
LOGIK .....	.046	Thomas .....	.010 125		
LXI .....	.022 035	TMK .....	.021		
magnavox 006 007 010 015 025 032 071 104 125		Toshiba .....	.002 023 030 038 051 067 076 091		
Magnin .....	.022	092 096 115			
magnasonic .....	.010	Totevision .....	.021 022 035		
Marantz .....	.019 020 024 025	Touch .....	.038		
Marta .....	.022 035	Unitech .....	.021		
Matsushita .....	.025	Vector Research .....	.019 023		
Media Center PC .....	.038	Vector .....	.002		
MEI .....	.025	Video Concepts .....	.019 023		
Memorex .....	.007 010 014 020 021 022	Videomagic .....	.035		
025 026 028 032 035 046 072 125					

## 3 Using the TV's Features

### Channel Banner

There are several indicators that might appear when you press the INFO button on the remote. This display is called the Channel Banner. The following list describes the items on the Channel Banner screen (left to right and top to bottom).

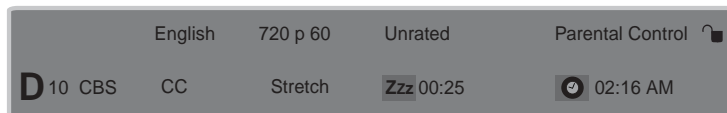

- Stereo** If the current channel is analog, Stereo appears when broadcasting in stereo and Mono appears when the current channel is broadcasting in mono. If the current channel is digital, this space will be blank.
- SAP** If the current channel is analog, this will show it's broadcasting SAP (Second Audio Program) information. If the current channel is digital, this will show language.
- 720 p 60** Broadcast signal resolution
- Unrated** Ratings information
- Parent Control** The Parent control state of the current program
- D 10 CBS** The *D* means it's a digital channel. If it's an analog channel, *A* is displayed. The channel, sub-channel (if available for digital channels) and program (only for digital channels) you're currently viewing are displayed.
- CC** Closed Captioning is available on the current channel.
- Stretch** Current screen format. If there are bars on the screen, you might be able to get rid of them by pressing the **FORMAT** button on the remote. Go to page 35 for more information on screen formats.
- ZZZ 00:25** Current time left on sleep timer, if the sleep timer is set.
- 🕒 02:16 AM** Current time

### Autotuning

*Note* : This feature only works with other RCA devices.

The Autotuning feature automatically tunes the TV to the correct video input channel for different devices you have connected to your TV. When you set up Autotuning in the menu system you don't have to remember to change your TV to the VID1 input, for example, when you want to watch a tape on the VCR. To set up the Autotuning feature:

1. Press **MENU** (the *Main Menu* appears).
2. Highlight *Setup* and press **OK** on your remote control.
3. Highlight *Autotuning* and press **OK**.
4. Choose which device button you would like to set:

- Set DVD Channel** Lets you set up the channel the TV tunes to when you press the DVD button.
- Set SAT-AUX Channel** Lets you set up the channel the TV tunes to when you press the SAT/AUX button.

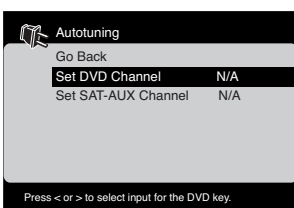

5. Press the left/right arrow button to select the choice that matches the way you have the device connected to this TV.

You can select from the following inputs or channels:

**N/A** Choose this if you don't have a device connected to the TV, or if you don't want the TV to automatically tune to the correct channel/input when you're using this device.

**Channel 3 or 4** Device is connected to the ANTENNA/CABLE jack on the back of the TV, and you want the TV to tune to channel 3 when you press the corresponding button on the remote. Reminder: make sure the device's Channel 3/4 switch is set to channel 3.

**VID1 or VID2 (Video Input)** Device is connected to the VIDEO INPUT 1 jack on the back of the TV or the VIDEO INPUT 2 jack on the side of the TV and you want the TV to tune to the VIDEO INPUT channel when you press the corresponding device button.

**CMP1 or CMP2 (Component Video Input)** Compatible component VIDEO source, such as an HDTV tuner, satellite receiver, or DVD player, is connected to the three Component VIDEO INPUT jacks (Y Pb Pr) on the back of the TV and you want the TV to tune to the component VIDEO INPUT channel (CMP1 or CMP2) when you press the corresponding device button.

**PC** Device is connected to the PC INPUT jack on the back of the TV and you want the TV to tune to the PC input when you press the corresponding device button

**HDMI1, HDMI2 or HDMI3** Device is connected to the HDMI1 or HDMI2/DVI INPUT on the back of the TV or HDMI 3 on the side of the TV, and you want the TV to tune to the HDMI INPUT channel when you press the corresponding device button.

## Parental Controls and V-Chip

The choices in the *US V-Chip* and *Canada V-Chip* menus involve software inside your TV referred to as V-Chip which allows you to block TV programs and movies. TV programs can be blocked by age-based ratings, such as *TV-MA*, which is explained on page 32. If available, TV programs can also be blocked by content, such as adult language (*L*). This is explained on page 33. Movies can only be blocked by age-based ratings. This is explained on page 33. Once you block programs, you can unblock programs by entering a password. By default, the software inside your TV is turned off or unlocked. For instructions to lock V-Chip, see page 32.

### How V-Chip Works for USA and Canada

V-Chip reads the program's age-based rating (*TV-MA*, *TV-14*, etc.) and content themes [(Violence (*V*), Adult Language (*L*), etc.)]. If you have blocked the rating and/or content themes that the program contains, you will receive the message This channel is blocked. Change channel or press OK to enter your password and temporarily deactivate the parental controls.

Broadcasters are not required to provide content themes, so programs received with no content themes will only be blocked if you block their age-based rating. You can also block out programs that have been given an Exempt rating, and programs that are considered unrated. Go to page 46 for the US and Canada ratings explanations.

*Note: Parental control settings are not available for HDMI1, HDMI2, HDMI3, CMP1, CMP2, or PC INPUTS. These settings must be set in the connected device's parental controls.*

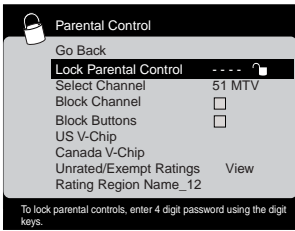

**Note:** If you do not lock parental controls, none of the settings for V-Chip, Block Channel, or Block Buttons will take effect.

## Lock Parental Controls

- When the Parental Control menu is accessed from the Main menu and the parental controls are permanently unlocked, the following message is displayed: *“Parental controls are UNLOCKED. Rating limits and Channel block will NOT require a password to view the picture. Use “Lock Parental Control” to lock. Press any key to continue.”*
- Pressing any key displays the Parental Control menu and highlights *Lock Parental Control*.
- To lock parental controls, enter a 4 digit password using the digit keys, after password is entered and parental controls are still unlocked, you must repeat entering the password. Once password is confirmed, the message is displayed: *“Parental Controls are LOCKED. Blocked programs will require a password to view the picture.”*

## Unlock Parental Controls

If parental controls are locked or temporarily unlocked, then the Password menu will appear when the user tries to enter the Parental Control menu. After correct password is entered, the parental controls are now unlocked.

## The V-Chip Rating Screen

The following is an example of where items are located within the TV Ratings option with the US V-Chip menu.

**Note:** If you forget your password, turn off the TV. Simultaneously press and hold VOL DOWN on the side panel and CANCEL on the remote for 10 seconds. Next time you enter the Parental Control menu, enter a new password.

### Rating Status Field

Lets you select whether the status of the age-based rating to the left limit is view or block.

### Rating Field

Lets you select from a list of age-based ratings you can block or view.

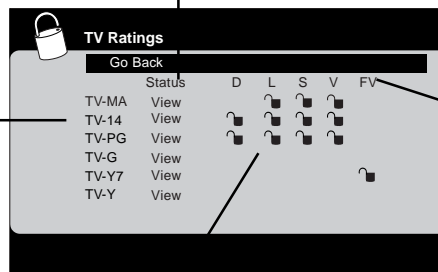

**Content Themes**  
Lists the content themes you can block or view.

### Content Status Fields

Lets you select which content themes to view for the selected rating, and whether the status of the content theme is currently unlocked (☞) or locked (🔒).

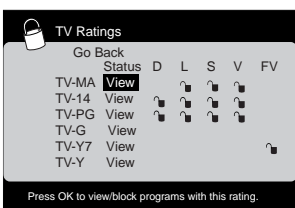

## US V-Chip TV Ratings

### Blocking Age-Based Ratings

You can automatically block all program ratings above a specified age-based rating level.

- Choose *Parental Control* from the Main menu. If parental controls have previously been locked, you must enter your password.
- Highlight and select *US V-Chip*. Then select *TV Ratings*.
- Press the up or down arrow button to scroll to the rating corresponding with the lowest rating you do not want the child to watch.
- Press the OK button to toggle between *View* and *Block*. The status for the rating and all higher ratings automatically changes to *Block*.



5. Use the MENU button repeatedly to get back to the Parental Control menu.
6. Select Lock Parental Control from the Parental Control menu for rating limits to take effect, you must enter the correct password twice. To view age-based ratings after you've locked them, follow the same steps as above to unlock.

### Blocking Specific Content Themes

You can block programs based on their content. (Content is represented by the *D, L, S, V* and *FV* on your screen.) When you block a content theme for a particular rating, you automatically block that content theme for higher rated programs as well. To block program content:

1. Determine the content themes you want to block.
2. Press the down arrow button to scroll to the rating whose content theme you want to change.
3. Press the right arrow button to move the highlight to a particular content theme.
4. Press the OK button to change its status to block. (For example, you block the language (L) corresponding with *TV-14*. The language for *TV-MA* is blocked as well.)

To view content theme after you've locked them, follow the same steps as above to unlock.

**Note:** If you unlock the language corresponding with *TV-14*, the language for *TV-MA* doesn't unlock. You have to unlock the content theme status for each rating separately.

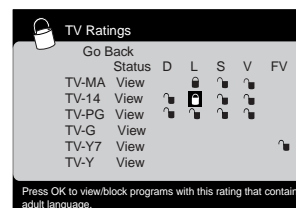

**Note:** Broadcasters are not required to provide content themes or age-based ratings. You must remember to lock Parental Controls for rating limits to take effect.

**Note:** If you forget your password, turn off the TV. Simultaneously press and hold VOL DOWN on the side panel and CANCEL on the remote for 10 seconds. Next time you enter the Parental Control menu, enter a new password.

Hierarchy of Age-Based Ratings	
TV-MA	Mature Audience Only
TV-14	Parents Strongly Cautioned
TV-PG	Parents Guidance Suggested
TV-G	General Audience
TV-Y7	Directed to Children 7 Years and Older
TV-Y	All Children

D	Sexually Explicit Dialogue
L	Adult Language
S	Sexual Situations
V	Violence
FV	Fantasy Violence

### US V-Chip Movie Rating Limit

Set movie rating limits by blocking movies rated above a specified level.

To access the Movie Rating Limit menu:

1. Press MENU on the remote control (the TV's Main Menu appears).
2. Select *Parental Control*.
3. Select *US V-Chip*.
4. Select *Movie Ratings*.
5. Press the down arrow button to scroll to the rating you want to change.
6. Press OK to change its status to block (all ratings above the one you selected change to block).

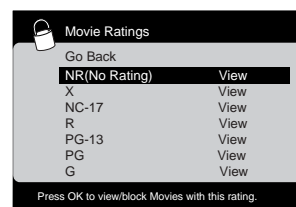

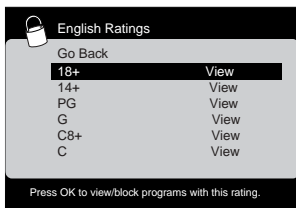

## Blocking Canada V-Chip Ratings

If you receive Canadian programs you can block Canadian English and French V-Chip by ratings only. When you block a particular rating, you automatically block the higher rated programs as well. To block Canadian English and French program ratings:

1. Select Canada V-Chip from the Parental Control menu.
2. Highlight *English Ratings* or *French Ratings* and press OK.
3. Determine the rating you want to block.
4. Press the down arrow button to scroll to the rating you want to change.
5. Press OK to change its status to block (all ratings above the one you selected change to block).

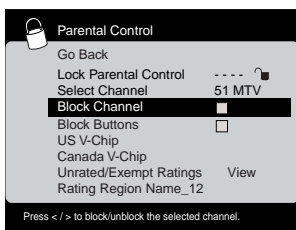

## Block Channel

Turn this option on to block the channel you choose in the *Select Channel* option. Use the number buttons to enter the channel you want to block, then press the down arrow button. Press OK to place a check mark in the *Block Channel* box to block the channel. When you tune to that channel you'll need to enter a password to view the channel if parental control is locked.

## Block Buttons

Select this option to block (disable) or unblock (enable) the TV's side panel buttons so that they can't be used by someone, like a young child. The remote still tunes to any channel. If you're using this to keep children from changing channels, remove access to any remote that is capable of operating the television while you have the side panel blocked. Don't forget to lock parental controls after you change the status. If you don't, the *Block Buttons* action will not take effect.

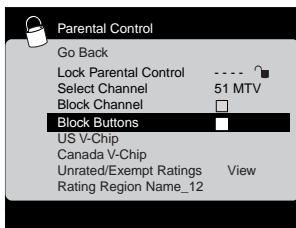

**Note:** You must remember to lock parental controls for rating limits to take effect.

## Blocking Unrated/Exempt Programs

The *Unrated/Exempt Ratings* option lets you decide if programs that the V-Chip recognizes as unrated or exempt can be viewed. Unrated TV programs may include news, sports, political, religious, local and weather programs, emergency bulletins, public announcements, and programs without ratings. The Exempt option applies to both USA and Canadian unrated programs and Canadian programs rated E.

Press the down arrow button to highlight *Unrated/Exempt Ratings*. Then press the OK or right arrow button to toggle between *View* and *Block*.

**View** All unrated programs are available

**Block** All unrated programs are not available.

**Note:** These ratings are available only if the broadcaster is sending them.

## Future Rating Region

You might notice an option in your Parental Control menu that wasn't there before. This is because broadcasters have the capability to add a new rating system for TV programs. These ratings let you define additional parameters for parental controls. This option and its name are dependent on the content acquired from the broadcaster.

# Additional Features

There are additional features available unrelated to parental controls. These features can be found in other menus.

## Fetch Feature

This is a unique “Fetch” remote control finder function on the HDTV. Pressing the MENU and VOLUME UP button on the side panel of the TV set at the same time will cause the remote control to bark from its current location. (only available for models L42FHD38, L46FHD38, L52FHD38, and L40FHD380)

## Screen Formats

Screen format is the way the picture is displayed on your TV. Press the FORMAT button on your remote to see if a different format is available for the video you are viewing. The format changes as you press the FORMAT button and the format type is displayed at the bottom of the screen.

Analog video is sent in a 4/3 format, which your TV displays in a 16/9 format. Most digital video is sent in a 16/9 format which does fill your screen, but it sometimes is sent in 4/3 which does not fill your screen. It depends on how the station or device connected to your TV is formatting the video. If there are bars on the screen, press the FORMAT button to try a different format that may eliminate the bars. Some bars can't be removed because of the way the format is sent by the broadcaster.

The different formats available and what they look like follow. Each format is available for analog video, but it might not be available for digital video.



Normal



Zoom



Stretch



Cinerama

# 4 Using the TV's Menu

## Using the Menu System

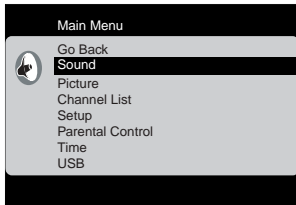

This section explores the menus of your TV. Each menu is outlined and detailed to help you get the most from your TV. The Parental Control menu is discussed in Chapter 3. To access the menu system:

1. Press the MENU button.
2. Use the up and down arrow buttons to highlight an option and press OK to display it. The name of the menu is displayed at the top of the menu screen.
3. Press the up and down arrow buttons to move to a different option within the menu. If necessary, press the OK button to display the choices of the option you've highlighted. If available, use the text at the bottom of each screen for help.
4. To return to the Main Menu, press the MENU button until it's displayed.

Descriptions of each menu are discussed in the order they appear.

There are two ways to exit a menu:

- Press the CANCEL button. The menus are cleared from the screen and you return to TV viewing.
- Press the MENU button repeatedly until the menu disappears.

## Sound Menu

The Sound menu lets you adjust audio output. To access the Sound menu, press MENU on the remote, and then select *Sound* from the Main Menu. The following audio items can be adjusted:

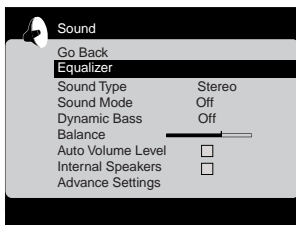

**Equalizer** The five-band graphic equalizer lets you adjust the audio frequency settings. You can select one of the five-band Equalizer Presets or create your own personal preset.

**Sound Preset** Allows you to choose a specific Sound Preset. Press the right arrow to cycle through the options: *Standard*, *Movie*, *Voice*, *Music* and *Personal*.

**Frequency Range** Displays the different graphic equalizer bands set for each Sound Preset option. Choose a band and make adjustments. When you make adjustments, the Sound Preset option automatically changes to *Personal*. Press the left or right arrow button to select the frequency (100Hz, 300Hz, 1KHz, 3KHz, 10KHz) you want to adjust. Then use the up or down arrow button to adjust the level. When you're done adjusting the levels, press the MENU button to exit.

To view the frequency range of another Sound Preset option, press the right or left arrow until no band is selected and *Frequency Range* is highlighted. Then press the up arrow to highlight *Sound Preset*.

**Sound Type** Controls the way the sound comes through your speakers. The options available vary according to the input selected.

**Mono** (available for regular TV viewing only) Plays the sound in mono only. Use this setting when receiving broadcasts with weak stereo signals.

**Stereo** Splits the incoming stereo audio signal into left and right channels. Most TV programs and recorded materials have stereo audio. The word Stereo appears in the channel banner when you tune to a program that is broadcast in stereo.

**Sound Mode** Provides special processing through your speakers (depending on the setting you chose as your Sound Type). The available sound modes are:

**Off** Does not give any special sound processing.

**SRS WOW** Gives a surround effect with more bass. (available for models L42FHD37, L46FHD37, and L46FHD35)

**SRS TurSurround XT** (available for models L42FHD38, L46FHD38, L52FHD38, and L40FHD380)

**Dynamic Bass** Improves bass output. Displays a choice list of available settings you can adjust: *Off* and *On*.

**Balance** Press the right or left arrow buttons to adjust how much audio is sent to the left and right speakers.

**Auto Volume Level** Reduces the annoying blasts in volume during commercial breaks, and also amplifies softer sounds in program material. Eliminates the need to constantly adjust the volume.

**Internal Speakers** Turn on or off the internal speakers. If you have a device connected to the AUDIO OUTPUT jacks on the back of the TV and you want to control the sound by the device instead, uncheck the box.

### Advanced Settings

**Second Audio Program (SAP)** Plays the program's audio in a second language, if one is available. The letters SAP appear in the channel banner when you tune to a program that is broadcast with SAP information. SAP audio is broadcast in mono. SAP is also used to broadcast a program's audio with descriptions of the video for the visually impaired.

**Default Audio Language** Choose the language you prefer for dialog on digital channels. If your preferred language is being broadcast with a program, then the TV plays it. If not, then the TV plays the default audio for the program (usually English in the U.S.). The default digital channel audio language options are *English*, *Spanish*, *French*, *German*, and *Italian*.

**Current Audio Track (not available for analog channels)** Press the right arrow to choose from the audio languages available for the program you're watching. The language you choose becomes your preferred audio language for all digital channels until you turn the TV off. If the language you choose here is not being broadcast with a program, then the TV plays the default audio for the program (usually English in the U.S.).

**Note:** *This menu will gray-out when current channel selected is analog.*

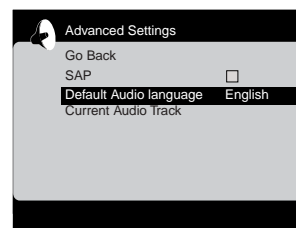

## Picture Menu

The Picture menu contains menus and controls to configure how the picture looks. The Picture menu options apply to the video for the main TV and VIDEO INPUT selections. All picture options can be applied to each input - *VID1*, *VID2*, *CMP1* or *CMP2*, *HDMI1*, *HDMI2* or *HDMI3*, and *PC*.

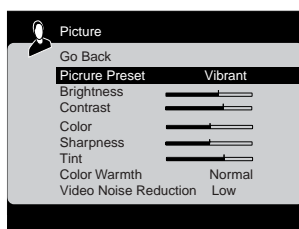

**Picture Preset (not available on PC)** Displays a choice list that lets you select one of the preset picture settings: *Vibrant*, *Sports*, *Personal*, *Natural*, or *Cinematic*. Choose the setting that is best for your viewing environment.

**Brightness** Use the left or right arrow buttons to adjust the brightness of the picture.

**Contrast** Use the left or right arrow buttons to adjust the difference between the light and dark areas of the picture.

**Color** Use the right or left arrow buttons to adjust the richness of the color.

**Sharpness (not available on PC)** Use the right or left arrow buttons to adjust the crispness of the edges in the picture.

**Tint (not available on PC)** Adjusts the balance between the red and green levels.

**Color Warmth** Displays a choice list that lets you set one of three automatic color adjustments: Cool for a more blue palette of picture colors; Normal; or Warm for a more red palette of picture colors. The warm setting corresponds to the NTSC standard of 6500 K. When you change any of these picture settings, the Picture Preset changes to *Personal*. Use the left or right arrow button to make adjustments.

**Video Noise Reduction (not available on PC)** Reduces picture “static” or any type of interference. This feature is especially useful for providing a clearer picture in weak analog signal conditions. Press the right arrow to choose between: *Off* for no noise reduction; *Low* for a softer, smoother picture that retains picture sharpness and detail; *Medium* for a slightly softer picture than the *Low* setting; *High* for an even softer, smoother picture than the other settings (the picture detail is somewhat decreased).

*Note: Video noise reduction is available for the CMP1 and CMP2 inputs only if the signal is 480i.*

## Channel List Menu

The Channel List menu allows you to view all the channels available in your channel list. Press the up or down arrow button to highlight a channel then press OK to tune to the channel.

## Setup Menu

The Setup menu lets you configure the TV to fit its surroundings and your preferences. To access the Setup menu, press MENU on the remote, and then select *Setup* from the Main Menu.

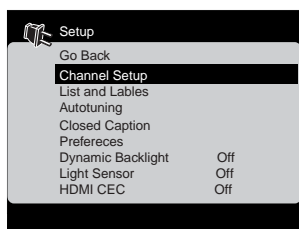

### Channel Setup

**Signal Type** Choose the type of signal you have connected to the ANTENNA/CABLE INPUT.

**Channel Search** Searches for channels the signal is receiving. Go to page 17 for more information.

### List and Labels

Edit the channels in the list or choose labels for each video input channel.

**Channel Number** Use the number buttons on your remote to enter the channel number, or press left and right arrow buttons to select the VIDEO INPUT channel among *VID1*, *VID2*, *CMP1*, *CMP2*, *PC*, *HDMI1*, *HDMI2* and *HDMI3*.

**In Channel List (only available for TV channels)** If you've entered a channel you want to add to the channel list, highlight *In Channel List* and press the right arrow to place a check in the check box. If you've entered a channel you want to delete from the channel list, press the right arrow button to uncheck the box. When an AV INPUT is displayed in the Channel number field, the line "In channel list" is grayed-out.



**Channel Label (not available for TV channels)** Allows you to select a label for the video input channel selected in *Channel Number*. The label is displayed on the screen when you tune to this input channel. When a channel number is displayed in the *Channel Number* field, this is grayed-out.

**Autotuning** Go to Chapter 3 for details about the Autotuning feature.

### Closed Caption

Many programs are encoded with closed-captioning information, which lets you display the audio portion of a program as text on the TV screen.

**Note:** *Closed caption settings are not available for HDMI1, HDMI2, HDMI3, CMP1, or CMP2 INPUTS. These settings must be set in the connected device's menu. Closed captioning is not available on all channels at all times. Only specific programs are encoded with closed-captioning information. When a program is closed captioned, CC is displayed in the channel banner. See Chapter 3 for more information about the channel banner. The closed caption options are:*

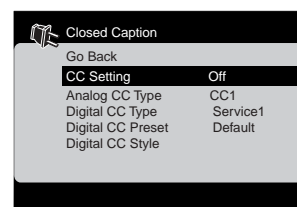

**CC Setting** Lets you choose the way closed captioning information appears on the screen.

- Off** No captioning information displayed.
- On always** Captioning information shown always, when available.
- On when muted** Displays captioning information, when available, whenever the TV's sound is muted by pressing the MUTE button. The captioning information is not displayed when the sound is not muted.

**Analog CC Type** If available, lets you select the captioning mode used for displaying captioning information. If you are unsure of the differences among the modes, you may prefer to leave the closed captioned mode set to CC1, which displays complete text of the program in the primary language in your area.

**Digital CC Type** If available, lets you select a closed caption service mode (1.6) for digital channels.

**Digital CC Preset** If available, lets you select between Default and Custom options. Custom changes according to what you set for the options below.

**Digital CC Style** If available, lets you customize the following display options:

- Digital CC Size** Lets you set the size of the digital closed-caption text. You can choose *Standard, Large, or Small*.
- Digital CC Font** Lets you select a character design for the digital closed-caption text. A font is a complete assortment of letters, numbers, punctuation marks, etc. in a given design. You can choose from a variety of fonts (*Semi Serif, Screen Serif, etc.*).
- Digital CC Opacity** Lets you set the appearance of the digital closed-caption text: *Solid, Transparent, Translucent, or Flashing*.
- Digital CC Color** Lets you choose the color of the digital closed-caption text: *White, Red, Green, Blue, Yellow, Magenta, Cyan or Black*.
- Digital CC Back. Opacity** Lets you set the appearance of the space behind the digital closed-caption text: *Solid, Transparent, Translucent, or Flashing*.
- Digital CC Back. Color** Lets you choose the color of the area of the screen behind the digital closed-caption text: *White, Red, Green, Blue, Yellow, Magenta, Cyan or Black*.

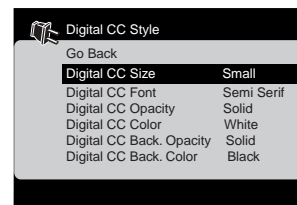



**Note:** These captioning style options only have an effect on true digital closed captions. Not all captioning on digital channels is digital captioning--it depends on what the broadcaster is sending. If the closed captioning for a program is not digital, the Digital CC style settings will not have an effect.

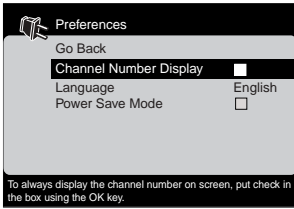

TV mode	Backlight Power Level	LED Color
Standby	Off	Off
On	Full Power Level	Blue
On	Mid Power Level	Cyan
On	Low Power Level	Green

**Note:** The connected HDMI device must be HDMI CEC compliant in order for this feature to work. However, some HDMI devices may utilize specific protocols that are not fully CEC compliant and may prevent the feature from working properly.

## Preferences

- Channel Number Display** Turn this feature on if you want the channel number always visible.
- Language** Lets you select your preferred language for the menus: *English, Espanol* or *Francais*.
- Power Save Mode** If no signal is detected from the Input/RF INPUT for 5min, the TV set goes to standby mode.

**Dynamic Backlight** Option: On/Off. If you choose On, the TV will continually monitor the video content being displayed and will adjust the backlight to achieve optimum contrast levels.

**Light Sensor** If you choose On, this feature is activated.

- When activated, this feature monitors the ambient light conditions in the room and adjusts the TV's backlight for optimum viewing. It also serves as an energy saving feature by lowering the backlight power level when appropriate (typically in darker room conditions).
- The TV has a multi-colored LED that adjusts based on the backlight power level with "green" representing the highest level of energy savings. Please refer to the table at the left for the various conditions of the backlight power level and LED colors when the light sensor is active.

**Note:** When TV is On and the light sensor is Off, the LED color will be blue.

## HDMI CEC (Consumer Electronics Control)

If choose On, the HDMI CEC function is enabled. This feature provides expanded capabilities when your TV is connected to an HDMI CEC compliant device using a certified HDMI 1.3 cable. Here is an example using an HDMI CEC compliant DVD player connected to the TV.

- Upon activating the feature, the TV searches for HDMI CEC compliant devices that are connected. In this example, a connected DVD player is found.
- When both the TV and DVD player are On and you insert a disc into the DVD player, the TV will automatically switch to the associated input and initiate play.
- When the TV is on and the DVD player is turned on with the disc already loaded, the TV will automatically switch to the associated input and initiate play.
- If you connect another HDMI CEC device and /or change the HDMI input used for an existing HDMI CEC device, you should turn the HDMI CEC function Off and then turn it back On again in order for the TV to complete a new search for the connected devices.

# Parental Control Menu

The Parental Control menu is explained in Chapter 3. Go to page 31 for more information.

# Time Menu

**Sleep Timer** Use the left and right arrow keys to set the TV to turn off after a given amount of time.

**Auto Time Channel** Choose a station to have the TV set the time for you. Wait about one minute for the time to be set.

**Time Zone** Select the current local time among *Atlantic, Newfoundland, Central, Mountain, Pacific, Alaska, Hawaii* and *Eastern*.

**Daylight Saving (DST)** Choose between *Off* and *Automatic* modes.

**Enter Time** If you didn't set the time reference channel, enter the current time manually. If it is 8:00, for example, you must first enter the number zero, then number eight. Use the OK button to choose between AM and PM.

**Wake up Timer** Use the left and right arrow keys to choose between *Off, Once* or *Daily* to set the TV to turn itself on just one time or at the same time each day.

**Note:** The Wake up Timer is available only when the time has been set.

**Wake up Time** Set the time you want the TV to turn itself on. To enter 8:00, for example, you must first enter the number zero, then number eight. Use the OK button to choose between AM and PM.

**Turn off Timer** Use the left and right arrow keys to choose between *Off, Once, or Daily* to set the TV to turn itself off just one time or at the same time daily.

**Turn off Time** Set the time you want the TV to turn itself off. To enter 8:00, for example, you must first enter the number zero, then number eight. Use the OK button to choose between AM and PM.

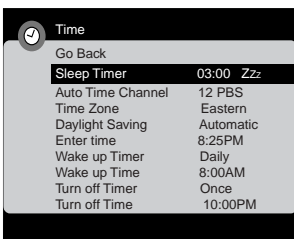



# USB Menu

The USB feature allows to play audio files (format supported: MP3) or display pictures (format supported: JPEG)

Select *USB* in the Main Menu, then select *USB Device*.

## USB Device

**Picture** If you have pictures on your USB device connected to your TV, this menu allows you to view the pictures individually by pressing the up/down arrow buttons to highlight the picture (the picture is displayed on the right).

**Note:** To play a slideshow of all the pictures available on your device, highlight a folder and press *PLAY*.

**Music** If you have mp3 audio files on your USB device connected to your TV, this menu allows you to play files individually by pressing the up/down arrow buttons to highlight the song.

**Note:** To play a slideshow of all the music files available on your device, highlight a folder and press *PLAY*.

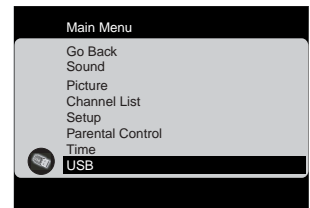

## USB Connection

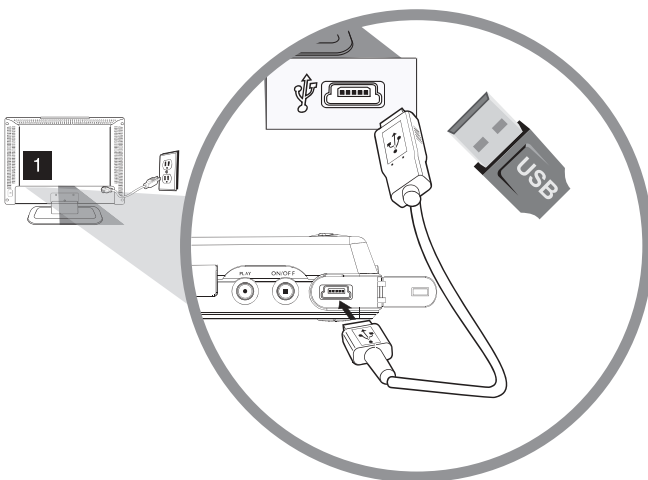

### Connecting a device with USB or a USB flash drive

This connection allows you to insert a USB flash drive directly or connect to a compatible mass storage device with USB, such as a digital camera, multi-format card reader, or mp3 player.

If you have a USB flash drive, plug in the drive directly.

If you have a device with USB:

- Connect one end of the USB cable to the USB device and the other end to the USB jack on the side of TV.
- To access and adjust the options of the USB device, press MENU then choose USB from the Main Menu.

**Note:** When using a USB connection, a picture slideshow can be set for a folder not per picture

## 5 Other Information

---

### Frequently Asked Questions (FAQs)

#### **What's the quickest way to view High Definition (HD) video?**

Connect an off-air antenna to the ANTENNA/CABLE Input to view free local digital channels. You might need to purchase an antenna. Go to page 10 for more information.

Visit [www.antennaweb.org](http://www.antennaweb.org) for help deciding what type of antenna to use to receive the local digital channels available to you. By entering where you live, this mapping program tells you which local analog and digital stations are available using a certain antenna.

#### **Are there other ways to view High Definition (HD) video?**

Besides using an off-air antenna as mentioned above, you can also use a set-top box to receive digital video. Contact your cable company or satellite provider to purchase digital programming and have them connect the box for you to ensure you're viewing channels the best way.

#### **How do I tell an analog channel from a digital channel?**

Press the INFO button to display the channel banner. Look at the bottom left corner of the screen. An *A* is displayed for an analog channel. A *D* is displayed for a digital channel.

#### **Why are there bars on my screen and can I get rid of them?**

Most digital video is sent in a 16/9 format which does fill your screen, but is sometimes sent in 4/3 which does not fill your screen. It depends on how the station or device connected to your TV is formatting the video. If there are bars on the screen, press the FORMAT button to try a different format that may eliminate the bars. Some bars can't be removed because of the way the format is sent by the broadcaster. The format changes as you press the FORMAT button and the format type is displayed at the bottom of the screen. For more information on screen formats, go to page 35.

#### **Why does channel search find a lot of channels, but when I try to tune to them there's nothing there?**

Some channels enabled by the cable company don't carry programming, such as video on-demand. When channels are unavailable, your TV's screen is blank or appears like snow. You probably want to remove these channels from your channel list. Remove these in the Channel List menu. Go to page 38 for more information.

#### **Why does the first channel search take a long time?**

If you have both analog and digital channels, the TV is looking for all available channels in the channel list. If you do have digital channels, the TV is also searching for scrambled channels, non-scrambled channels, and each sub-channel of that digital channel.

# Troubleshooting

Most problems you encounter with your TV can be corrected by consulting the following troubleshooting list.

## TV Problems

### TV won't turn on

- Make sure the TV is plugged in.
- Check the wall receptacle (or extension cord) to make sure it is "live" by plugging in something else.
- The side panel controls may be locked (disabled). Use the remote control to unlock the side panel controls by selecting the *Block Buttons* feature on the Parental Control menu and press OK to uncheck the box.

### No picture and no sound but TV is on

- You might be tuned to an input with no device connected to it to view. If you're trying to view a connected device, press INPUT until the picture from that device appears.
- The *Signal Type* option may be set incorrectly. Go to page 17 for detailed instructions.
- The channel might be blank--change channels.
- If you're watching your VCR and it's connected with coaxial cable to the ANTENNA/CABLE jack, tune the TV to channel 3 or 4 (whichever channel is selected on the 3/4 switch on the back of your VCR). Also make sure the TV/VCR button on the VCR is in the correct mode (press the TV/VCR button on your VCR).

### Sound okay, picture poor

- If you're getting a black and white picture from a device you've connected to your TV, you might have your video cables connected to the wrong jacks. A yellow Video cable connects to the yellow VIDEO INPUT jack on the side or back of your TV; three video cables or bundled component video cables (red, blue, and green) connect to the corresponding COMPONENT INPUT jacks on the back of your TV.
- If you're getting no picture from a device you've connected to your TV, you might have your video cable connected to the VIDEO OUTPUT jack on the back of your TV. These jacks are used to connect recording devices. A yellow Video cable connects to the yellow VIDEO INPUT jack on the side or back of your TV.
- Check antenna connections. Make sure all of the cables are firmly connected to the jacks.
- Try adjusting the sharpness function to improve weak signals. Go to page 38 for more instructions.

### No sound, picture okay

- The sound might be muted. Try pressing the volume up button to restore sound.
- If using DVI, S-Video, or Y, PB, PR, remember to also connect the device's left and right AUDIO OUTPUT jacks to the TV's L and R AUDIO INPUT jacks.
- The sound settings may not be set correctly. Go to page 36 for more information.
- The internal speakers might be turned off. Go to page 37 for more information.
- If your audio source has only one jack or is a (mono) audio source, make sure you have plugged the connection into the Left AUDIO INPUT jack on the TV.

### Blank screen

- Check your connections. If you used yellow, red, and white cables to connect, make sure they're connected to the yellow, red, and white VIDEO INPUT jacks on the side or back of the TV, not to the VIDEO OUTPUT jacks on the back of the TV.
- If you're trying to watch something that's playing on a device connected to the TV (like a DVD), press INPUT until you get to the correct video input channel.
- Make sure the device connected to the TV is turned on.
- Try another channel.

### Buttons don't work

- The side panel controls may be locked (disabled). Use the remote control to unlock the side panel controls by selecting the *Block Buttons* feature in the Parental Control menu and press OK to uncheck the box.
- Unplug the TV for ten minutes and then plug it back in. Turn the TV on and try again.

### TV turns off unexpectedly

- Sleep timer may have been activated. Go to page 40 for instructions.
- Electronic protection circuit may have been activated because of a power surge. Wait 30 seconds and then turn on again. If this happens frequently, the voltage in your house may be abnormally high or low.
- Unplug. Wait ten minutes. Plug in again.

### TV turns on unexpectedly

Wake up timer might have been activated. Go to page 40 for instructions.

### Can't select certain channel

- Channel may be blocked or not approved in the Parental Control menu.
- If using a VCR, check to make sure the TV/VCR button on the VCR is in the correct mode (press the TV/VCR button on your VCR).
- Press the TV button and then try to change channels.

### Noisy stereo reception

May be a weak station. Use the Sound menu and Sound Type to choose *mono*.

### Black box appears on the screen

Closed-captioning might be on. Check *Closed Caption* in the Setup menu. Go to page 39 for more instructions.

## Problems with HDMI Connection

- Make sure the HDMI or DVI device is turned on and the cables are firmly connected. If problems still occur, turn off your device. Re-connect your device. Reset the power by unplugging the power cord and plugging it back in.
- If you are tuned to the HDMI 1, HDMI 2 or HDMI 3 INPUT and you're receiving *Unusable Signal* message onscreen, press the INFO button on the remote. If *Acquiring Channel* appears in the channel banner, the HDMI or DVI device isn't responding. Contact the manufacturer of the HDMI or DVI device for further assistance.
- If you tune to the HDMI 1, HDMI 2 or HDMI 3 INPUT and you see snow, the video goes in and out, or the video takes a long time to appear, your HDMI or DVI device is having trouble sending video information to the TV. Re-connect your device. Reset the power by unplugging the power cord and plugging it back in. If problems persist, try connecting the Y Pb Pr jacks if they are available or contact the manufacturer of the HDMI or DVI device for further assistance.
- If you have black bars on each side of your picture, the device you connected might have a switch or a menu option allowing you to change the picture quality output that will fix this. Choose either *720p* or *1080i*.
- 480i signals aren't supported by the HDMI2/DVI, HDMI1 or HDMI3 INPUT.

## The Remote Control Doesn't Work

- Something might be between the remote and the remote light sensor on the front of the TV. Make sure there is a clear path.
- The remote may not be aimed directly at the TV.
- The batteries in the remote may be weak, dead, or installed incorrectly. Put new batteries in the remote. (Note, if you remove the batteries, you may have to reprogram the remote to operate other devices.)

## **Problems with V-Chip/Parental Controls**

The rating limits don't work

You must lock the settings. Go to the Main Menu (press MENU on your remote), select *Parental Control*, select *Lock Parental Control*.

I don't remember my password and I want to unlock the TV

If you forget your password, turn the TV off. Simultaneously press and hold VOL DOWN on the side panel and CANCEL on the remote for 10 seconds. Next time you enter the Parental Control menu, enter a new password.

The V-Chip won't let me watch a program even though it's not rated as violent.

Maybe the movie was given an NR (Not Rated) status. After you block movie ratings, you must set NR to *View Separately* in order to view movies with an NR rating.

## **What Else Can I Do?**

If you've been through the Troubleshooting section and nothing has fixed your problem, try rebooting your TV. Note that after a reboot you may need to run your TV through the setup process again. To do a reboot, unplug the power cord from the wall outlet, power strip, etc. Keep your TV unplugged for about 5 minutes. Then plug in the TV, turn on the TV, and see if the problem is fixed. If the problem remains, then please click on the Customer Support Menu at [www.rca.com/television](http://www.rca.com/television) for updated FAQs or contact RCA Customer Support at the support number provided in your Warranty under *How To Get Service*.

# V-Chip Rating Explanations

## US V-Chip Rating System

**TV-MA (Mature Audience Only)** Specifically designed to be viewed by adults and may be unsuitable for children under 17. It contains one or more of the following content themes: crude indecent language (L), explicit sexual activity (S), or graphic violence (V).

**TV-14 (Parents Strongly Cautioned)** Contains some material that many parents would find unsuitable for children under 14. Parents are strongly urged to exercise greater care in monitoring this program and are cautioned against letting children under the age of 14 watch unattended. This program contains one or more of the following content themes: intensely suggestive dialogue (D), strong coarse language (L), intense sexual situations (S), or intense violence (V).

**TV-PG (Parental Guidance Suggested)** Contains material that parents may find unsuitable for younger children. Many parents may want to watch it with their younger children. The program contains one or more of the following content themes: some suggestive dialogue (D), infrequent coarse language (L), some sexual situations (S), or moderate violence (V).

**TV-G (Parental Audience)** Most parents would find this program suitable for all ages. It contains little or no sexual dialogue (D) or situations (S), no strong language (L), and little or no violence (V).

**TV-Y7 (Directed to Children 7 years and older)** Designed for children ages 7 and above. It may be more appropriate for children who have acquired the developmental skills needed to distinguish between make believe and reality. Themes and elements in this program may include mild fantasy violence (FV) or comedic violence, or may frighten children under the age of 7.

**TV-Y (All Children)** Themes and elements in this program are designed for a young audience, including children ages 2-6. It is not expected to frighten younger children.

## Canadian English V-Chip Rating System

**18+ (Adult)** Programming intended for adults 18 and older. It may contain elements of violence, language, and sexual content which could make it unsuitable for viewers under 18. Violence Guidelines: May contain violence integral to the development of the plot, character or theme, intended for adult audiences. Other Content Guidelines: May contain graphic language and explicit portrayals of nudity and/or sex.

**14+ (Viewer 14 and over)** Programming contains themes or content which may not be suitable for viewers under the age of 14. Parents are strongly cautioned to exercise discretion in permitting viewing by pre-teens and early teens. Violence Guidelines: May contain intense scenes of violence. Could deal with mature themes and societal issues in a realistic fashion. Other Content Guidelines: May contain scenes of nudity and/or sexual activity. There could be frequent use of profanity.

**PG (Parental Guidance)** Programming intended for a general audience but which may not be suitable for younger children (under the age of 8). Parents may consider some content inappropriate for unsupervised viewing by children aged 8-13. Violence Guidelines: Depictions of conflict and/or aggression will be limited and moderate; may include physical, fantasy, or supernatural violence. Other Content Guidelines: May contain infrequent mild profanity, or mildly suggestive language. Could also contain brief scenes of nudity.

**G (General Audience)** Programming considered acceptable for all ages groups. While not designed specifically for children, it is understood younger viewers may be part of the audience. Violence Guidelines: Will contain very little violence, either physical or verbal or emotional. Will be sensitive to themes which could frighten a younger child, will not depict realistic scenes of violence which minimize or gloss over the effects of violent acts. Other Content Guidelines: There may be some inoffensive slang, no profanity and no nudity.

**C8+ (Children 8 and older)** Programming generally considered acceptable for children 8 years and over to watch on their own. Violence Guidelines: Violence will not be portrayed as the preferred, acceptable, or only way to resolve conflict or encourage children to imitate dangerous acts which they may see on television. Any realistic depictions of violence will be infrequent, discreet, of low intensity and will show the consequences of the acts. Other Content Guidelines: There will be no profanity, nudity or sexual content.

**C (Children)** Programming intended for children under age 8. Violence Guidelines: Careful attention is paid to themes which could threaten children's sense of security and well being. There will be no realistic scenes of violence. Depictions of aggressive behavior will be infrequent and limited to portrayals that are clearly imaginary, comedic or unrealistic in nature. Other Content Guidelines: There will be no offensive language, nudity or sexual content.

### **Canadian French V-Chip Rating System**

**18+ (Adult)** Programming is for adults only. This program contains sustained violence or extremely violent scenes.

**16+ (Viewer 16 and over)** Programming is not suitable for those under age 16. This program contains frequent scenes of violence or intensely violent scenes.

**13+ (Viewer 13 and over)** Programming may not be suitable for children under the age of 13. This program either contains several violent scenes or one or more scenes that are violent enough to affect them. Viewing in the company of an adult is therefore strongly recommended for children under the age of 13.

**8+ (Viewer 8 and over)** Not recommended for young children. This program is suitable for most audiences, but it contains mild or occasional violence that could upset young children. Viewing in the company of an adult is therefore recommended for young children (under the age of 8) who do not distinguish between reality and imagination.

**G (General Audience)** This program is suitable for audiences of all ages. It contains no violence, or any violence that it does contain is either minimal or is presented in a humorous manner, as a caricature, or in an unrealistic way.

# TTE Technology, Inc. (“TTE”) Limited Warranty

## All LCD Models

**EXCEPT TO THE EXTENT PROHIBITED BY APPLICABLE LAW, THIS WARRANTY DOES NOT COVER, AND AS DESCRIBED BELOW TTE EXPRESSLY DISCLAIMS, ALL ACTUAL AND IMPLIED WARRANTIES WITH RESPECT TO ANY PRODUCT USED FOR INSTITUTIONAL OR OTHER COMMERCIAL PURPOSES (INCLUDING BUT NOT LIMITED TO RENTAL PURPOSES).**

**What your warranty covers:** Defects in materials or workmanship to the original owner

### **New LCD Televisions - screen sizes 32” and smaller:**

- **For how long after your purchase:**
  - Ninety (90) days from date of purchase for labor charges. After ninety (90) days, labor charges will be at owner expense.
  - One (1) year from date of purchase for parts.
- **What we will do:**
  - At TTE’s discretion, pay an Authorized RCA Service Center for both labor charges and parts to repair your television, or replace your television with a new or refurbished/remanufactured unit. **See “How to get service”**

### **New LCD Televisions - screen sizes 33” and larger:**

- **For how long after your purchase:**
  - One (1) year from the date of purchase for labor charges.
  - One (1) year from the date of purchase for parts.
- **What we will do:**
  - At TTE’s discretion, pay an Authorized RCA Service Center for labor charges and parts to repair your television, or replace your television with a new or refurbished/remanufactured unit. **See “How to get service”**

### **All Remanufactured/Refurbished LCD Televisions:**

- **For how long after your purchase:**
  - Ninety (90) days from date of purchase for labor charges.
  - Ninety (90) days from date of purchase for parts.
- **What we will do:**
  - At TTE’s discretion, pay an Authorized RCA Service Center for both labor charges and parts to repair your television, or replace your television with a refurbished/remanufactured unit. **See “How to get service”**

### **How to get service:**

- Call 1-800-951-9582. Please have your unit’s date of purchase and model/serial number ready. The model/serial number information can be found on the back of your unit.
- A representative will troubleshoot your problem over the phone.
- If it is determined that your unit requires service, the service location will be at the sole discretion of TTE based upon the TTE Limited Warranty statement.
  - At the sole discretion of TTE, television screen sizes 32” and smaller is either consumer carry-in to an Authorized RCA Service Center or directly exchanged for a new or refurbished/remanufactured unit.
  - At the sole discretion of TTE, television screen sizes 33” and larger is either consumer carry-in to an Authorized RCA Service Center or directly exchanged for a new or refurbished/remanufacture unit.
- Proof of purchase in the form of a bill of sale or receipted invoice from an Authorized Dealer which is evidence that the product is within the warranty period must be presented to obtain warranty service.

### **What your warranty does not cover:**

- Customer instruction. (Your Owner’s Manual describes how to install, adjust, and operate your unit. Any additional information should be obtained from your dealer.)
- Installation and related adjustments.



- Damage resulting from non-approved installation methods.
- Signal reception problems not caused by your unit.
- Damage from misuse or neglect.
- Batteries.
- A television that has been modified or incorporated into other products or is used for institutional or other commercial purposes (including but not limited to rental purposes).
- A unit purchased or serviced outside the U.S.A.
- Acts of nature, such as but not limited to lightning damage.
- Special, incidental or consequential damages.

**Product Registration:**

Please complete and mail the Product Registration Card packed with your unit or register on-line at [www.rca.com/television](http://www.rca.com/television). It will make it easier to contact you should it ever be necessary. The return of the card is not required for warranty coverage.

**Limitation of Warranty:**

- **THE WARRANTY STATED ABOVE IS THE ONLY WARRANTY APPLICABLE TO THIS PRODUCT. NO VERBAL OR WRITTEN INFORMATION GIVEN BY TTE TECHNOLOGY, INC., ITS AGENTS OR EMPLOYEES SHALL CREATE A GUARANTY OR IN ANY WAY INCREASE OR MODIFY THE SCOPE OF THIS WARRANTY.**
- **REPAIR OR REPLACEMENT AS PROVIDED UNDER THIS WARRANTY IS THE EXCLUSIVE REMEDY OF THE CONSUMER. TTE TECHNOLOGY, INC. SHALL NOT BE LIABLE FOR SPECIAL, INCIDENTAL OR CONSEQUENTIAL DAMAGES RESULTING FROM THE USE OF THIS PRODUCT OR ARISING OUT OF ANY BREACH OF ANY EXPRESS OR IMPLIED WARRANTY ON THIS PRODUCT. THIS DISCLAIMER OF WARRANTIES AND LIMITED WARRANTY ARE GOVERNED BY THE LAWS OF THE STATE OF INDIANA. EXCEPT TO THE EXTENT PROHIBITED BY APPLICABLE LAW, ANY IMPLIED WARRANTY OF MERCHANTABILITY OR FITNESS FOR A PARTICULAR PURPOSE ON THIS PRODUCT IS LIMITED TO THE APPLICABLE WARRANTY AND WARRANTY PERIOD SET FORTH ABOVE.**

**How State Law relates to this warranty:**

- Some states do not allow the exclusion nor limitation of incidental or consequential damages, or limitations on how long an implied warranty lasts, so the above limitations or exclusions may not apply to you.
- This warranty gives you specific legal rights, and you also may have other rights that vary from state to state.

**If you purchased your unit outside the United States or seek warranty coverage outside the United States:**

This warranty does not apply. Contact your dealer for warranty information.

**Service calls which do not involve defective materials or workmanship are not covered by this warranty. Costs of such service calls are the sole responsibility of the purchaser.**

# TTE Technology Canada Ltd. (“TTE”) Limited Warranty

**EXCEPT TO THE EXTENT PROHIBITED BY APPLICABLE LAW, THIS WARRANTY DOES NOT COVER, AND AS DESCRIBED BELOW TTE EXPRESSLY DISCLAIMS, ALL ACTUAL AND IMPLIED WARRANTIES AND CONDITIONS WITH RESPECT TO ANY PRODUCT USED FOR INSTITUTIONAL OR OTHER COMMERCIAL PURPOSES (INCLUDING BUT NOT LIMITED TO RENTAL PURPOSES).**

**What your warranty covers:** Defects in materials or workmanship to the original purchaser.

**For how long after purchase:**

- All RCA televisions: One year parts and labor.
- All RCA Scenium televisions: Two years parts and labor.

**What TTE Technology Canada Ltd. will do:**

- At TTE’s discretion, pay an Authorized RCA Service Centre for both labor charges and parts to repair your television, or replace your television with a new or refurbished/remanufactured unit. **See “How to get service”**

**How to get service:**

- Call **1-866-465-7157** (French: **1-800-522-0445**). Please have your unit’s date of purchase and model/serial number ready. The model/serial number information can be found on the back of your unit.
- A representative will troubleshoot your problem over the phone.
- If it is determined that your unit requires service, the service location will be at the sole discretion of TTE based upon the TTE Limited Warranty statement.
- At the sole discretion of TTE, RCA CRT DV televisions are either consumer carry-in to an Authorized RCA Service Centre or directly exchanged for a new or refurbished/remanufactured unit.
- At the sole discretion of TTE, RCA LCD televisions are either consumer carry-in to an Authorized RCA Service Centre, directly exchanged for a new or refurbished/remanufacture unit or provided in-home service.
- At the sole discretion of TTE, RCA Scenium LCD televisions are either consumer carry-in to an Authorized RCA Service Centre, directly exchanged for a new or refurbished/remanufacture unit or provided in-home service.
- Proof of purchase in the form of an original bill of sale or receipted invoice from an Authorized Dealer which is evidence that the product is within the warranty period must be presented to obtain warranty service.

**Your warranty does not cover damages which are caused by:**

- Fire, accident, lightning, flood and/or other acts of God;
- Faulty installation, set-up adjustments, improper antenna, inadequate signal reception, adjustment of consumer controls and/or improper maintenance; and/or
- Failure which results from misuse, abuse, neglect, mishandling, misapplication, and/or alteration.

### **What your warranty does not cover:**

- Customer instruction (Your Owner's Manual describes how to install, adjust, and operate your unit. Any additional information should be obtained from your dealer);
- Transportation cost to and from the Service Centre (Unless you have made other arrangements with your dealer at the time of purchase whereby he undertakes this responsibility);
- Installation and set-up service adjustments;
- Products connected otherwise than as outlined in the Owner's Manual;
- Products on which the serial number has been altered or removed;
- External antenna or cable systems;
- Remote control batteries;
- A television that has been modified or incorporated into other products or is used for institutional or other commercial purposes (including but not limited to rental purposes);
- A unit purchased or serviced outside Canada;
- Special, incidental or consequential damages; and/or
- Normal wear or cosmetic damage.

### **How Provincial law relates to this warranty:**

- This warranty gives you specific legal rights, which are in addition to statutory warranties, which may vary from Province to Province and which take precedence over the terms of this warranty.

### **If you purchased your unit outside of Canada:**

- This warranty does not apply. Contact your dealer for warranty information.

**©2009 TTE Technology Canada Ltd.**

**6605 Hurontario Street, Mississauga, Ontario L5T 0A3**

## Care and Cleaning

**Caution:** Turn OFF your TV before cleaning.

You can clean the TV as required, using a soft lint-free cloth. Be sure to occasionally dust the ventilation slots in the cabinet to help assure adequate ventilation.

**IMPORTANT: Never use strong cleaning agents, such as ammonia-based cleaners, or abrasive powder. These types of cleaners will damage the TV. The TV's screen may be cleaned with a soft, lint-free cloth as well. Take care not to scratch or mar the screen. If necessary, you may use a cloth dampened with warm water. While cleaning do not spray liquid directly on the screen, or allow liquid to run down the screen and inside the TV. Also, never place drinks or vases with water on top of the TV. This could increase the risk of fire, shock hazard or damage to the TV.**



**ENERGY STAR is a set of power-saving guidelines issued by the U.S. Environmental Protection Agency (EPA).  
Manufactured under license from Dolby Laboratories.**

**“Dolby” and the double-D symbol are registered trademarks of Dolby Laboratories.**

**WOW, SRS and (●) symbol are trademarks of SRS Labs, Inc. WOW technology is incorporated under license from SRS Labs, Inc.**

**TruSurround XT, SRS and (●) symbol are trademarks of SRS Labs, Inc. TruSurround XT technology is incorporated under license from SRS Labs, Inc.**

### **FCC Information**

This equipment has been tested and found to comply with the limits for a Class B digital device, pursuant to Part 15 of the FCC Rules. These limits are designed to provide reasonable protection against harmful interference in a residential installation. This equipment generates, uses, and can radiate radio frequency energy and, if not installed and used in accordance with the instructions, may cause harmful interference to radio communications. However, there is no guarantee that interference will not occur in a particular installation. If this equipment does cause harmful interference to radio or television reception, which can be determined by turning the equipment off and on, the user is encouraged to try to correct the interference by one or more of the following measures:

- Reorient or relocate the receiving antenna.
- Increase the separation between the equipment and receiver.
- Connect the equipment into an outlet on a circuit different from that to which the receiver is connected.
- Consult the dealer or an experienced radio/TV technician for help.

This Class B digital apparatus complies with Canadian ICES-003.

### **Visit the RCA website at [www.rca.com/television](http://www.rca.com/television)**

Please do not send any products to the Indianapolis address listed in this manual or on the carton. This will only add delays in service for your product.

# **TTE**

**TTE Technology, Inc.  
101 West 103rd Street  
Indianapolis, IN 46290**

**@2009 TTE Technology Inc.**

**RCA and associated marks are trademarks of THOMSON S.A.  
used under license to TTE Corporation.**

**Printed in USA**

**Part No.: 72-TV5221-E001D**