

ÖLEVIA

By **SYNTAX**

User's Manual

LCD Multi-Media Display
LT32HV / LT37HV Series

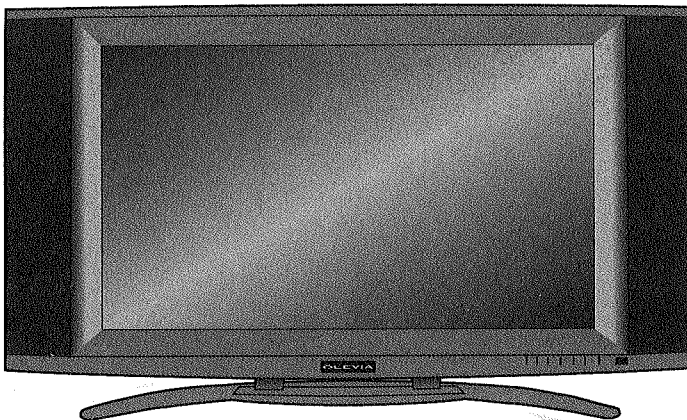
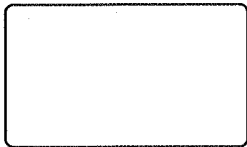



Table of Contents

Important Information	1
Important Safety Precautions	2
FCC Statement	5
Accessories	6
Installation And Connection Guide	
Identifying Front Controls and Rear Inputs	8
-Descriptions of Input Types	10
-Connecting the TV's Power	11
Installation	12
-Connecting to an Antenna or Video Equipment with Antenna outlet	13
-Connecting to a VCR	14
-Connecting to an Audio Receiver/Home Theater System	15
-Connecting to a DVD Player with A/V or S Video Cables	16
-Connecting to a DVD Player with Component Cables	17
-Connecting to a Satellite Receiver or Cable Box with A/V Cables	18
-Connecting to a Satellite Receiver or Cable Box With Component Connectors	19
-Connecting to a PC with VGA, and a DVD Player with DVI/HDCP Cables	20
-Other Connections	21
Remote Control Guide	
-Functions and Descriptions	22
-Hotkeys Tutorial	23
Adjusting the On Screen Display (OSD)	
Introduction	25
Adjusting Picture Quality	26
-Input Source	27
-Auto Adjustment	28
-Reset Factory Settings	28
Adjusting Sound Quality	29
-Selecting Stereo or Bilingual Programs	30
Adjusting Personal TV Settings	
-Description of Settings	31
-Auto Scan	32
-Favorite Channels	32
-Editing Channels	33
-TV Clock	34
-TV Alarm	34
-Sleep Timer	34
-Closed Caption	35
-Parental Control	36
-OSD Background Settings	39
Adjusting Screen Modes	40
-Changing Screen Mode	40
-Changing View Modes (PIP, Split Screen, POP3, POP12)	41
Troubleshooting	47
Specifications	48
Timing Mode for VGA and DVI	50
Glossary	52

Important information



Caution

Risk of electronic shock
Do not open



To reduce the risk of electronic shock, do not remove cover (or back).
No user-serviceable parts inside.
Refer service to qualified Repair Technician or Repair Center.



Read the following context indicated by the following symbol to the left. It indicates important literature in operating the product.



Read the following context indicated by the following symbol to the left. It indicates a potential high voltage hazard that may compromise your safety.



Caution

Take caution when moving the product on a cart.
Quick stops, excessive force, and uneven surfaces may cause the display unit and cart combination to overturn.

Caution

To prevent electric shock, match wide blade of plug to wide slot, fully insert.

Caution

This product satisfies FCC regulations when shielded cables and connectors are used to connect the unit to other equipment. Prevent electromagnetic interference from electrical appliances such as radios and televisions. Please use shielded cables and connectors for connections.

Warning

FCC Regulations state that any unauthorized changes or modifications to this equipment not expressly approved by the manufacturer could void the user's authority to operate this equipment.

Important safety precautions

Cleaning

Remember to unplug the AC cord from the AC outlet before cleaning the display unit. And do not use liquid cleaners or aerosol cleaners to clean the display.

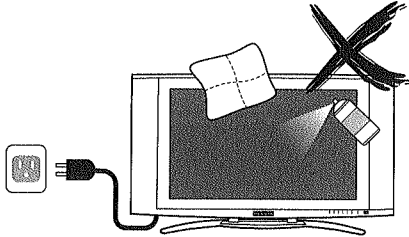

Stand

Do not place the display unit on an unstable place. The TV may fall resulting in serious personal injuries to nearby people as well as damage to the display unit.

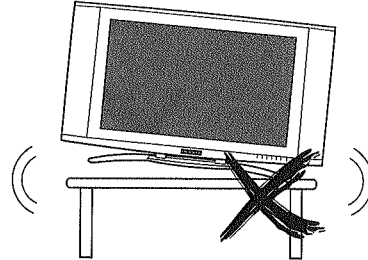

Ventilation

Do not cover or block these vents and openings located on the top and back of the display. Inadequate ventilation may cause overheating and shorten the lifespan of the display. Do not place in an enclosed area such as a built-in shelf, unless proper ventilation is provided or the manufacturer's instructions are followed. Keep the distance of 10cm minimum between the display unit and wall. Never install the display unit as indicated in the picture below.

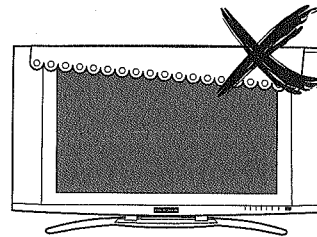

Air circulation is blocked

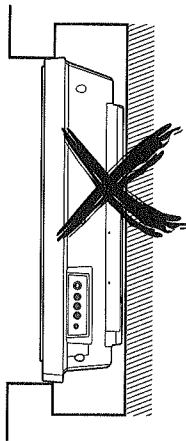

Air circulation is not blocked

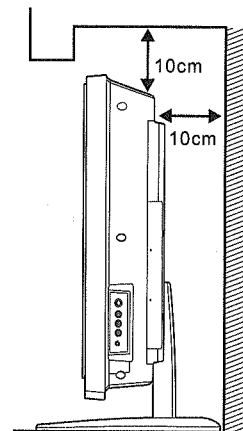

Never insert objects or spill liquid into the display unit

Never insert any object into the display unit through openings or spill liquid on the display unit. High voltage flows in the display unit, and inserting an object can cause electric shock and/or short internal parts.

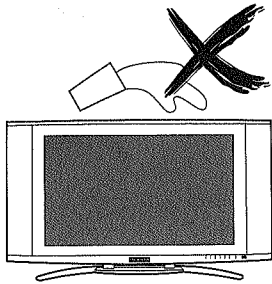

Keep away from water and moisture

Do not place the display in areas where moisture is present or where the unit may get wet such as bathrooms, kitchen, pool area or in a wet basement.

Keep away from heat sources

Keep the display unit away from heat sources such as radiators, heaters, stoves and other heat-generating products.

The liquid crystal panel used in this product is made of glass

Do not hit the panel. Be careful to prevent from getting hurt by broken glass pieces in case the panel breaks.

Follow operating instructions

All operating instructions must be followed.

Servicing

Do not attempt to service the display unit yourself. Removing covers expose you to high voltage and other dangerous conditions. Request a qualified service technician to perform the service.

Precautions when transporting the display

Carrying the display requires two or more people.

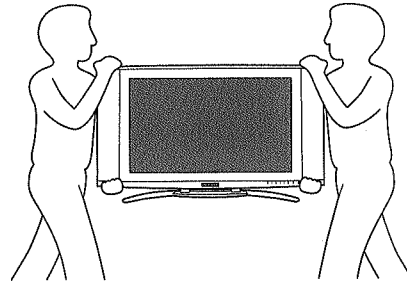

Attachments

Do not use attachments not recommended by the manufacturer. Use of inadequate attachments may result in accidents to nearby people or to the unit.

Power source

This product must operate on a power source specified on the specification label. If you are not sure of the type of power supply used in your home, consult your dealer or local power company. For units designed to operate on batteries or another power source, refer to the operating instructions.

AC cord protection

The AC cords must be routed properly to prevent people from stepping on them or objects from resting on them. Check the cords at the plugs and product.

Wall mounting

Be sure to install the display unit according to the method recommended by the manufacturer. Use only the mounting hardware recommended by the manufacturer.

Overloading

Do not overload AC outlets or extension cords. It may result in electric shock or start a fire.

Replacement parts

In case the display unit needs replacement parts, make sure that the service technician uses replacement parts specified by the manufacturer, or those with the same characteristics and performance as the original parts. Use of unauthorized parts can result in fire, electric shock and/or other danger.

Safety checks

Upon completion of service or maintenance, request the service technician to perform safety checks to ensure that the display unit is in proper operating condition.

Repair

When the display unit displays an abnormal condition, any noticeable abnormality in the display unit indicates that the display unit needs servicing. If any of the following conditions occurs, unplug the AC cord from the AC outlet, and request a qualified service person to perform repairs.

1. A liquid was spilled on the display unit or objects have fallen into the display unit.
2. The display unit has been exposed to rain or water.
3. The display unit has been dropped or damaged.

Environment

The display unit only operates within the temperature 0°C to 40°C. Operation outside of the recommended may cause damage to your product.

FCC Statement

FCC notice

This equipment has been tested and found to comply with the limits for a Class B digital device, pursuant to part 15 of the FCC Rules. These limits are designed to provide reasonable protection against harmful interference in a residential installation. This equipment generates, uses and can radiate radio frequency energy and, if not installed and used in accordance with the instructions, may cause harmful interference to radio communications. However, there is no guarantee that interference will not occur in a particular installation. If this equipment does cause harmful interference to radio or television reception, which can be determined by turning the equipment off and on, the user is encouraged to try to correct the interference by one or more of the following measures:

- 1.Reorient or relocate the receiving antenna.
- 2.Increase the separation between the equipment and receiver.
- 3.Connect the equipment into an outlet on a circuit different from that to which the receiver is connected.
- 4.Consult the dealer or an experienced radio/TV technician for help.

Modifications not expressly approved by the manufacturer could void the user's authority to operated the equipment under FCC rules. This device complies with part 15 of the FCC Rules. Operation is subject to the following two conditions:

- 1.This device may not cause harmful interference.
- 2.This device must accept any interference received, including interference that may cause undesired operation.

For Canadian model

This Class B digital apparatus complies with Canadian ICES-003.

Approval



Accessories

Supplied accessories

Remote control & batteries (AAA x 2)

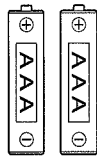
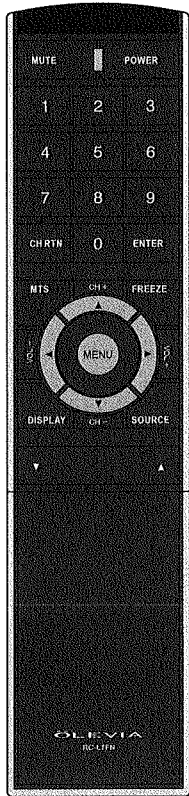

VGA cable (D-Sub 15 male) x 1



Component cable with RCA connector



User manual booklet x 1

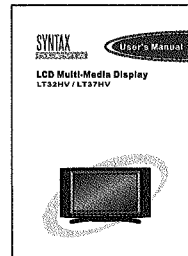

Power cord x 1



Optional accessories

AV cable with RCA connector



S-video cable



DVI cable

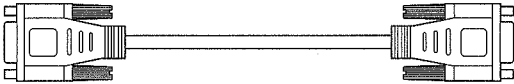

Audio cable with RCA connector



Wall mount set

Model# WM-20D

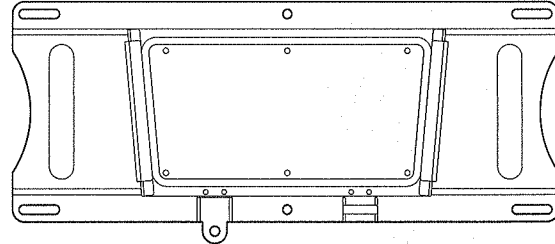

Audio cable with stereo mini jack

Use the proper cable for the device.



(Stereo mini jack cable)



(Stereo mini jack to RCA cable)

TV Installation and Connection Guide

Identifying Front and Rear Panels

Front Panel

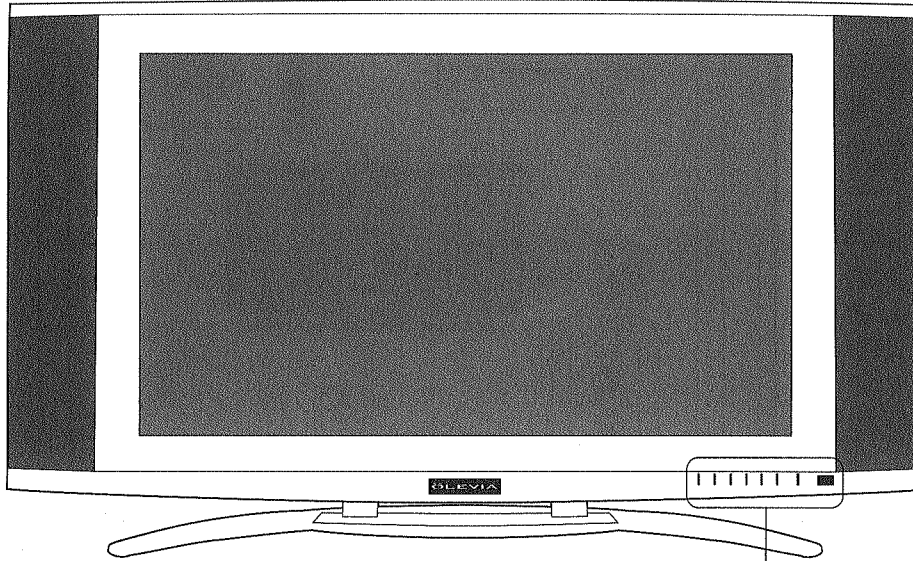

POWER Turns display on/off

MENU Displays the On Screen Display(OSD) menu. In OSD menu, press it to return to pre-phase

CH+ / CH- Adjusts Channel. In the OSD menu, both keys are used to navigate within menu.

VOL+/VOL- Adjusts volume. In OSD menu, both key are used to navigate within menu. Vol+ is used to select the highlighted option.

SOURCE Press to switch the input sources

IR SENSOR Contains Infra-red light for digital data transmission by the remote control. Please point remote control at IR Sensor for function.

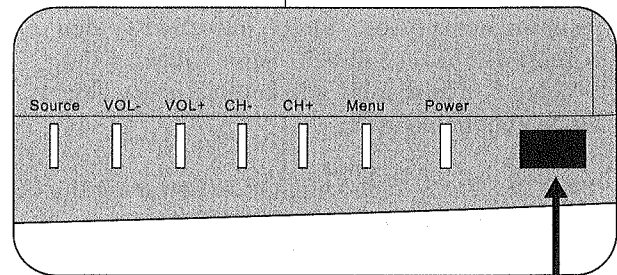

IR Pad

Identifying Front and Rear Connectors

Rear Panel

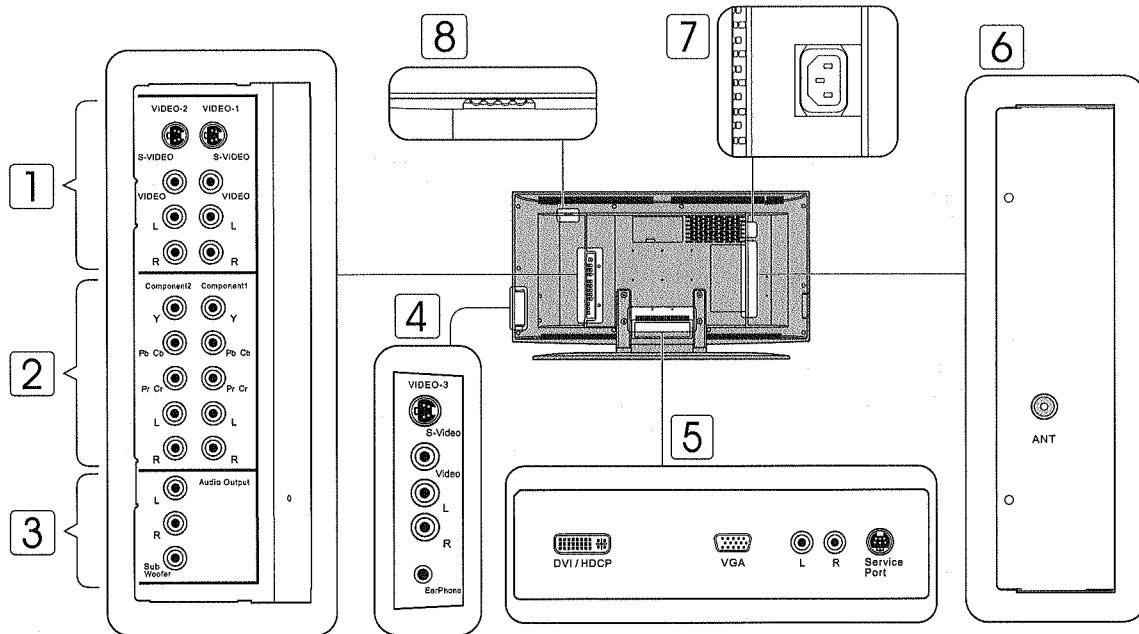

1 Video 1,2 These inputs can be used for the connection of a VCR, Super VHS (S-VHS) VCR, DVD player, or other video devices to the TV. There is a Video and an S-Video input for Video 1 and video 2. When both inputs are used simultaneously on Video 1, only the S-Video input will be recognized. Same behavior for Video 2. The display will automatically detect the input being used.

NOTE: The S-Video input has a better quality of picture than a composite Video signal.

2 Component 1, 2 These inputs can be used for the connection of A/V equipment with component video outputs, such as a DVD player, Digital Satellite Receiver, or compatible Video Game System.

3 Audio Out The Audio Output sends the TV's connected audio signals to an A/V receiver or other equipment. Display features a R/L stereo and subwoofer output.

4 Video 3 An additional input for other A/V devices such as VCR, Super VHS (S-VHS) VCR, DVD player or other video devices to the TV. The headphone jack is also located here for audio output.

5 DVI/HDCP and VGA Port : This display includes a DVI input that receives analog or digital video signals through the interface for the display of high quality digital video signals. The DVI port is HDCP (High Bandwidth Digital Content Protection) compliant and is fully compatible with video equipment that features the HDCP function. The VGA input can be used for analog RGB signals from a HD Receiver or personal computer. Resolutions supported are VGA, SVGA, XGA and WXGA. DVI and VGA share Audio L/R inputs.

Service Port is reserved for manufacturer use. Incorrect use may damage the Display.

6 Antenna (ANT) Antenna receives signals from VHF/ UHF antennas or a cable system.

7 AC IN power cord connects here.

8 AV-light lights up during connection process for user viewing assistance.

To Activate: Press "Source" & "Vol+" simultaneously to turn AV-light on. It will automatically turn off after 60 seconds.

Descriptions of Connector Types

You may find it necessary to use some of the following connector types during setup.

75-ohm coaxial cable Used for TV cable connection .



S-Video Cable High quality video cable for enhanced picture quality.



Audio/Video Cable

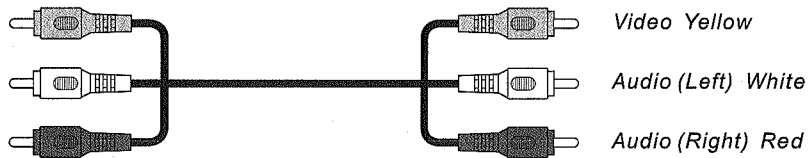

Some DVD players are equipped with the following three video connectors:

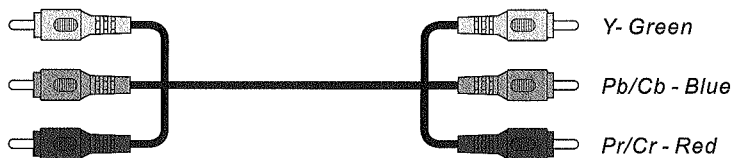

Connecting the Power Cord

Complete other connections prior to connecting the power cord:

1. Connect the power cord to the AC IN connector of the TV

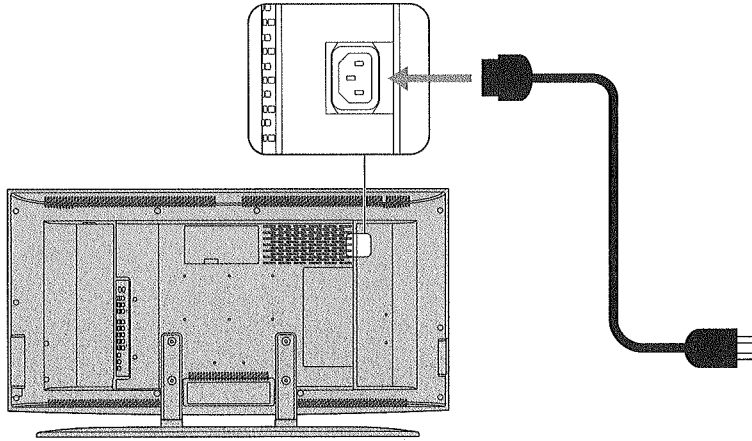

2. Connect the other end of the power cord to the wall outlet.

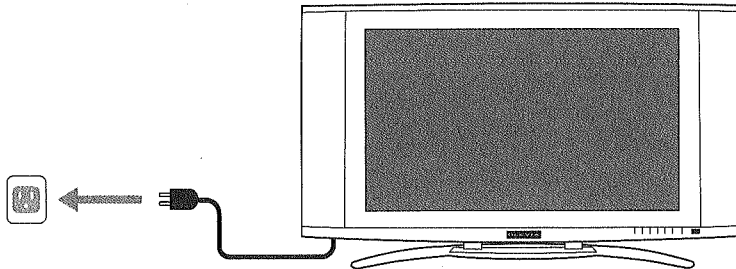

For your Convenience

An AV-Light is located in the rear panel above Video1 and Video2. To activate press Source & Vol+ simultaneously to turn AV-light on. The AV-Light will remain on for 1 minute. See page 9 for description.

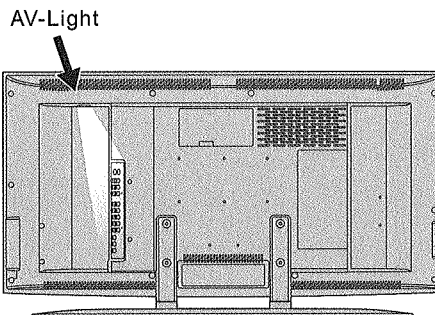

Installation

In the following pages, you will find directions on how to install your tv and choice of video equipment.

- **Connecting to an Antenna or Video Equipment with Antenna outlet**
- **Connecting to a VCR**
- **Connecting to an Audio Receiver/Home Theater System**
- **Connecting to a DVD Player with A/V or S Video Cables**
- **Connecting to a DVD Player with Component Cables**
- **Connecting to a Satellite Receiver or Cable Box with A/V Cables**
- **Connecting to a Satellite Receiver or Cable Box With Component Connectors**
- **Connecting to a PC with VGA, and a DVD Player with DVI/HDCP Cables**
- **Other Connections**

Connecting to an Antenna or Video Equipment with Antenna outlet

⚠ Disconnect all power sources before making any connection.

1. Connect a 75ohm coaxial cable onto the ANT input on the back of the TV's right side panel.

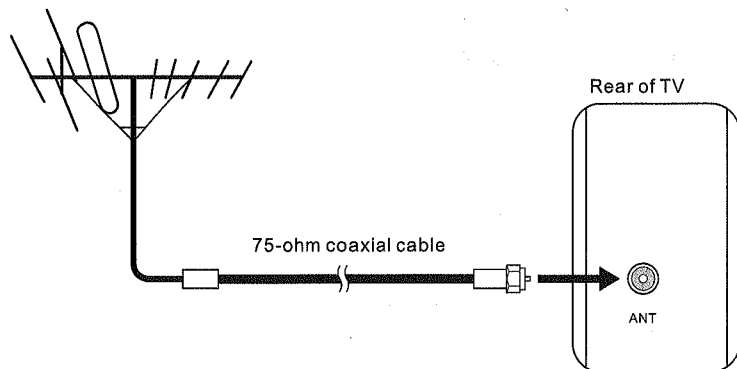

If connecting to Video Equipment with Antenna outlet

1. Using a 75-ohm coaxial cable (or choice of Antenna Cable), connect the cable box's OUT jack to the TV's ANT jack (RF Terminal).

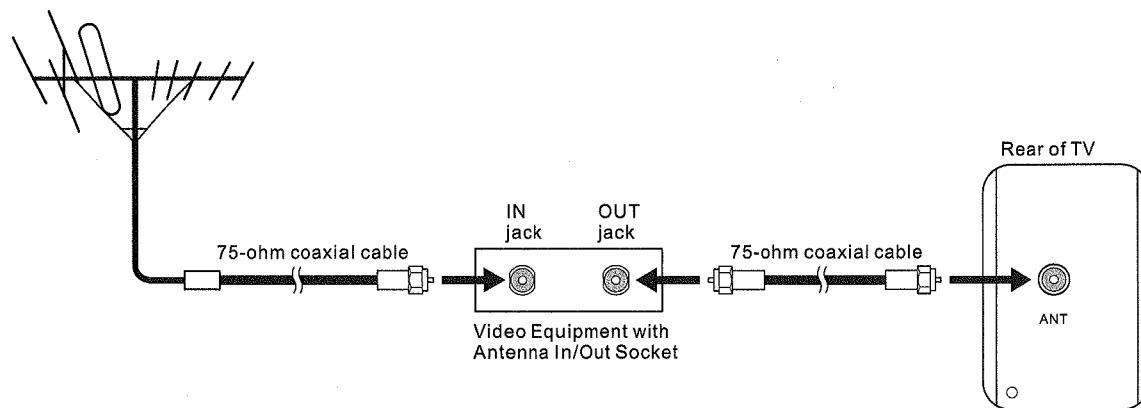

Connecting to a VCR

⚠ Disconnect all power sources before making any connections.

Use this hookup if you subscribe to a cable TV system that does not require a cable box.

1. Using A/V cable and S-Video cables, connect the VCR's Audio and S Video OUT jacks to the TV's Audio and S-Video In jacks.

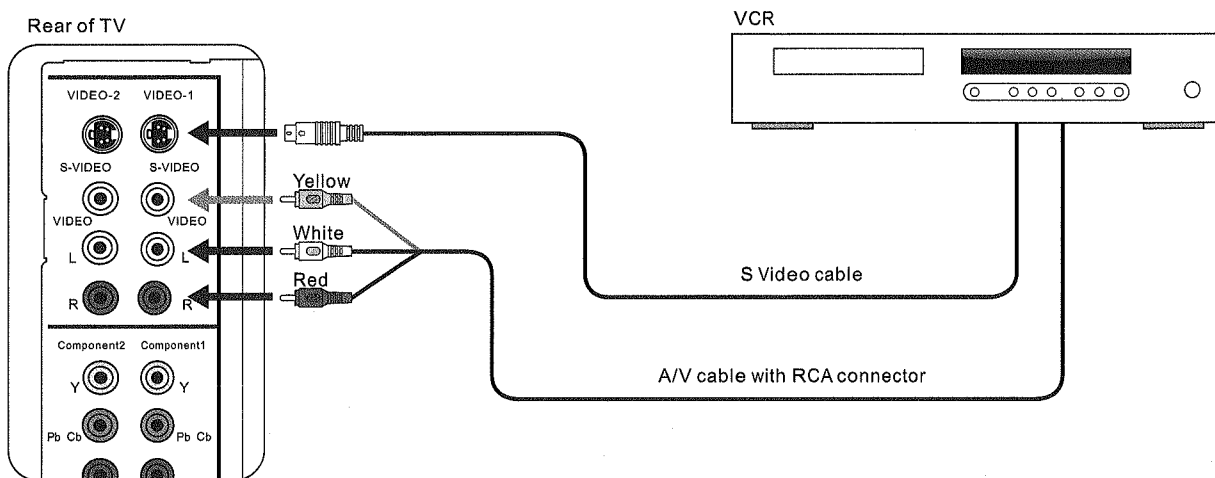

When Connecting both Video IN and S-Video IN

Note: When you connect video equipment to both the same Video and S-Video input jacks, display will automatically select S-Video first. To view Video signal, please disconnect the S-Video jack or turn off the S-Video signal on the video equipment.

S-Video is strongly recommended for use if your VCR or video equipment has it. S-Video input has a better quality of picture than a composite Video signal.

Note: You can also use the Video 2 jacks located on the TV rear, or Video 3 located on the right side of the display to connect additional video equipment.

Connecting to an Audio Receiver / Home Theater System

⚠ Disconnect all power sources before making any connections.

1. Using an audio cable, connect the TV's audio OUT jack to the audio receiver's audio IN or AUX IN jacks.
2. Using an audio cable, connect the TV's audio Out jack to the subwoofer Audio In or AUX IN jacks.

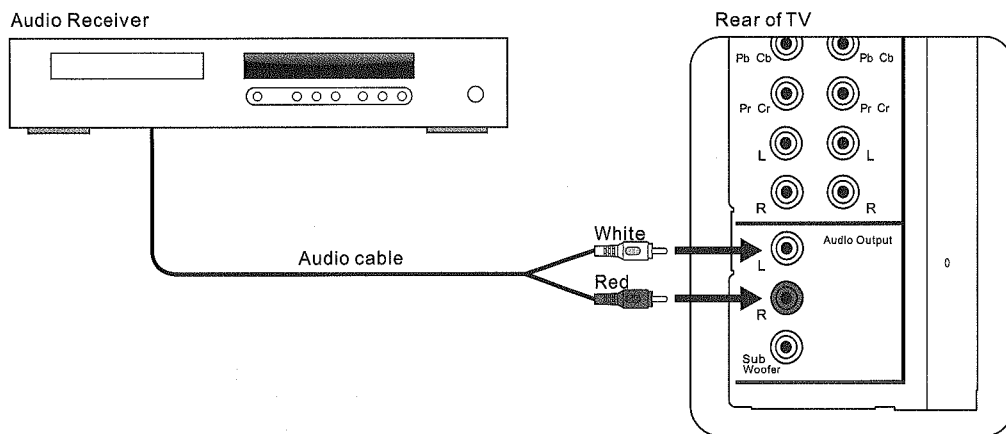

Note: When connecting an Audio output signal, an external Audio amplifier is necessary to amplify the signal for external speakers.

Note: If the audio out is hooked up to a home theatre sound system, please disable the audio in the OSD by selecting off in audio section . Volume adjustment must be made on the home theatre receiver. By not disabling the TV's speaker it could damage the speakers or TV itself.

Connecting to a DVD Player with A/V or S Video Cables

⚠ Disconnect all power sources before making any connections.

Use this hookup if your DVD player does not have component (Y, Pb, Pr) jacks.

Note: If your DVD player has component video output connectors, for best picture quality, use the connection described for *Connecting to a DVD Player With Component Connectors.* (See page.17)

1. Using an A/V cable, connect the DVD player's Audio OUT jacks to the TV's Audio IN jacks.
2. Using an S Video Cable, connect the DVD player's S Video OUT jack to the TV's S Video IN jack.

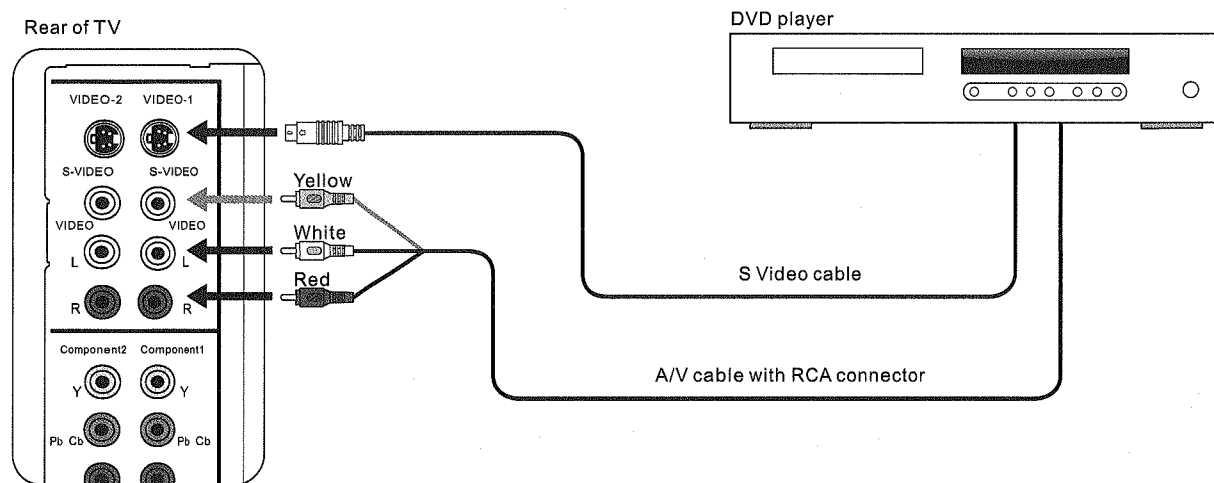

Note: When you connect video equipment to both the same Video and S-Video input jacks, the display will automatically select S-Video first. To view Video signal, please disconnect the S-Video jack or turn off the Video signal on the video equipment.

S-Video is strongly recommended for use if your VCR or video equipment has it S-Video input has better quality of picture than a composite Video signal.

Note: You can also use the Video 2 jacks located on the TV rear, or Video 3 located on the right side of the display to connect additional video equipment.

Connecting to a DVD Player With Component Cables

⚠ Disconnect all power sources before making any connections.

Use this hookup if your DVD Player has component (Y, Pb, Pr) jacks.

1. Using a component video cable, connect the DVD Player's Y, Pb and Pr jacks to the Y, Pb and Pr jacks on the TV.

Colors on Component Video connectors:

Y: Green

Pb (also identified as Cb, CB or B-Y): Blue

Pr (also identified as Cr, CR or R-Y): Red

Note: The Y, Pb and Pr jacks on your DVD player are sometimes labeled as Y, Cb and Cr, or B-Y and R-Y. If so, connect the cables to the matching colors.

2. Using an Audio cable, connect the DVD player's Audio OUT jacks to the TV's Audio in jacks.

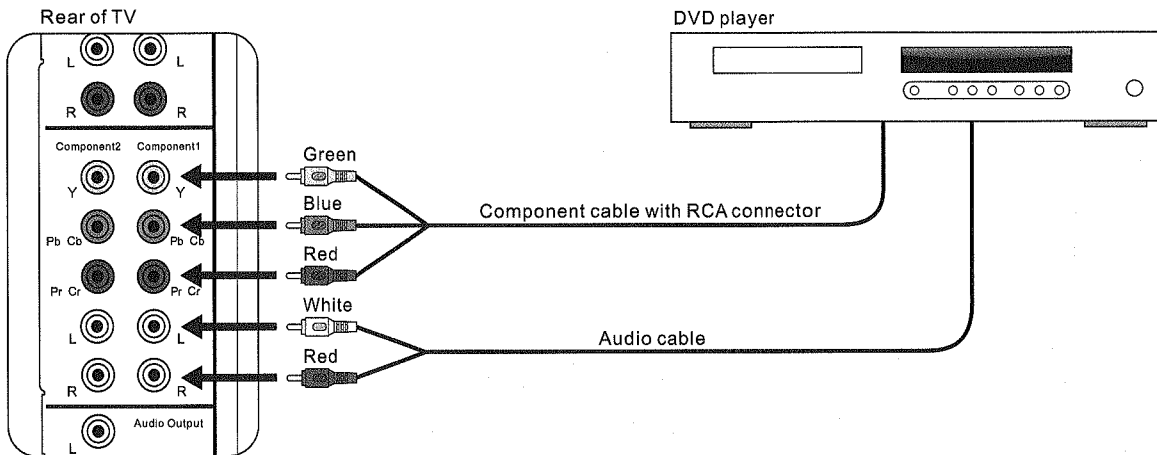

Note: The Y, Pb and Pr jacks do not provide audio, so audio cables must be connected to provide sound.

Note: The YPbPr connection provides the best quality of video signal compared to AV (Composite) and S-Video connection.

Connecting to a Satellite Receiver or Cable Box with A/V Connectors

⚠ Disconnect all power sources before making any connections.

1. Using Audio and S Video cables, connect the satellite receiver's Audio and S Video OUT jacks to the TV Audio and S Video IN jacks.
2. Connect a 75-ohm coaxial cable from your cable or antenna to the TV Ant (Antenna) jack.

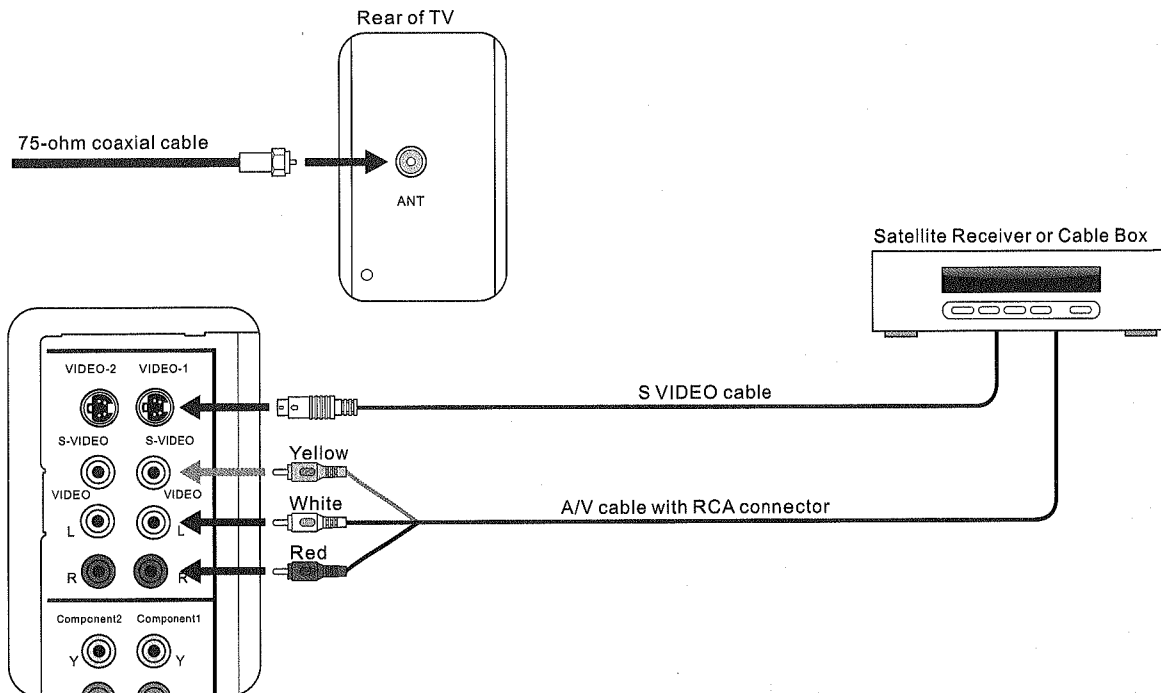

Note: When you connect video equipment to both the same Video and S Video input jacks, display will automatically select S Video first. To view S Video signal, please disconnect Video jack or turn off the Video signal on the video equipment.

S-Video is strongly recommended for use if your VCR or video equipment has it because S-Video input has better quality of picture than a composite Video signal.

Note: You can also use the Video 2 jacks located on the TV rear, or Video 3 located on the right side of the display to connect additional video equipment.

Connecting to a Satellite Receiver or Cable Box With Component Connectors

⚠ Disconnect all power sources before making any connections.

Use this hookup if your Satellite Receiver or Cable Box has component (Y, Pb, Pr) jacks.

1. Using a component video cable, connect the Satellite Receiver or Cable Boxes' Y, Pb and Pr jacks to the Y, Pb and Pr jacks on the TV.

Colors on Component Video connectors:

Y: Green

Pb (also identified as Cb, CB or B-Y): Blue

Pr (also identified as Cr, CR or R-Y): Red

Note: The Y, Pb and Pr jacks on your Satellite Receiver or Cable Box are sometimes labelled as Y, Cb and Cr, or B-Y and R-Y. If so, connect the cables to the matching colors.

2. Using an Audio cable, connect the Satellite Receiver or Cable Boxes' Audio OUT jacks to the TV's Audio in jacks.

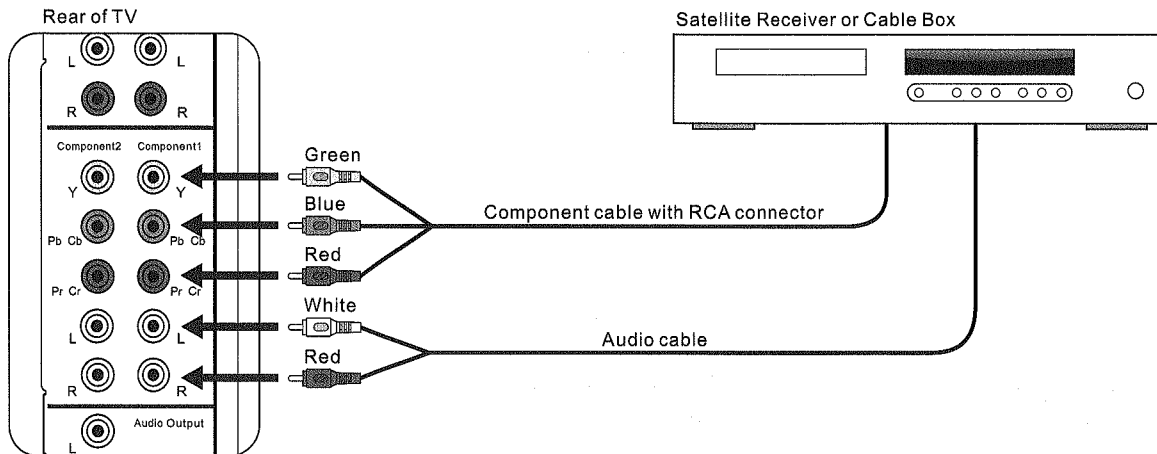

Note: The Y, Pb and Pr jacks do not provide audio, so audio cables must be connected to provide sound.

Note: The YPbPr connection provides the best quality of video signal compared to AV (composite) and S-Video connection.

Connecting to a PC with VGA Connector

⚠ Disconnect all power sources before making any connections.

1. Using a D-Sub 15 pin cable, connect the VGA output terminal of the PC to the TV's VGA signal input terminal.
2. You may need to use a Stereo mini jack to RCA L/R connectors to receive audio.

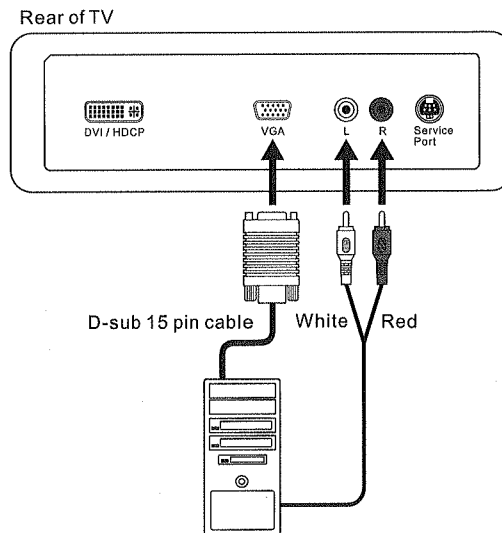

Connecting to a DVD Player or HD-Receiver with a DVI/HDCP Cable

⚠ Disconnect all power sources before making any connections.

1. Using a DVI cable, connect the DVD's DVI output terminal to the TV's DVI-HDCP input terminal.
2. Using an Audio cable, connect the DVD's Audio OUT jacks to the TV's Audio IN jacks.

Note: VGA and DVI/HDCP Connectors share the same audio input.

Note: HDCP is a copy protected digital connection that receives analog or digital video signals from equipment with DVI output that features the HDCP function. DVI allows the transfer of digital uncompressed data to the TV.

DVI technology is better than Component, S Video or AV (composite) connections.

Note: DVI signal is purely digital and provides a crystal clear technology better than component, S-Video or Video connections. It is strongly recommended to use this connection if you have this function on your equipment.

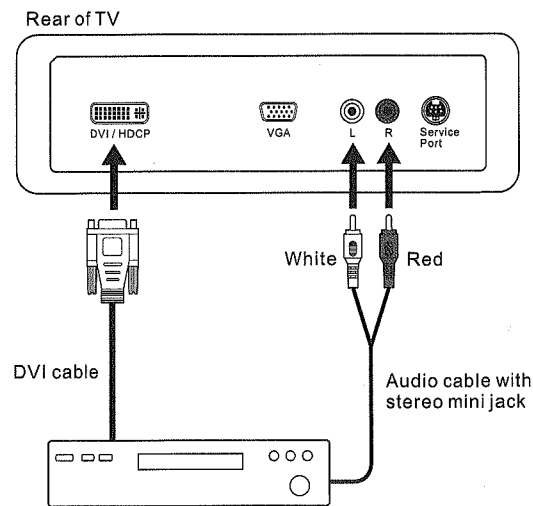

Other Connections

⚠ Disconnect all power sources before making any connections.

See setup instructions for: Connecting to an Audio Receiver on page 15.

Subwoofer and other Speakers

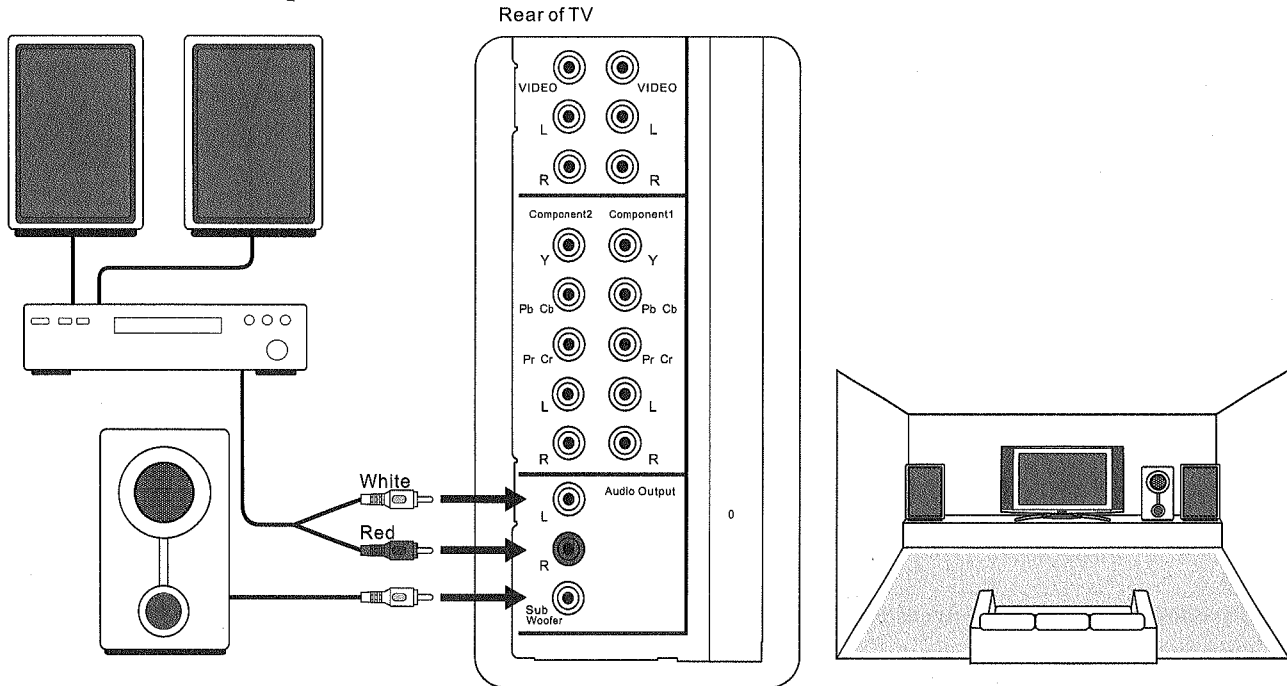

Note: Subwoofer speakers must contain an amplifier in order to amplify the signal from the TV.

Headphone Set

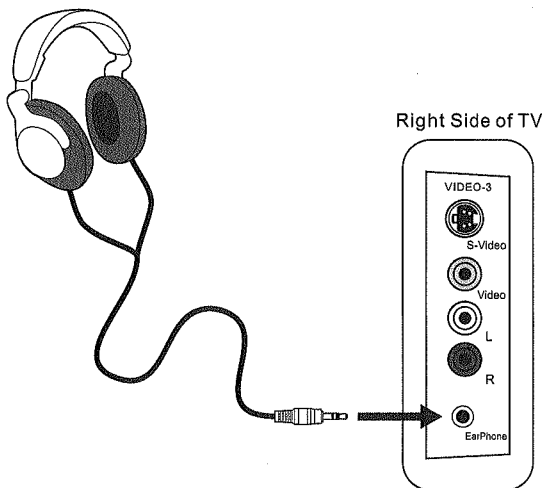

Note: When headphone is plugged in the speaker will turn into mute mode.

Remote Control Guide

Remote Function Keys & Description

Regular Buttons

- 1 MUTE** Press to mute the sound.
- 2 NUMBER BUTTONS** Press the number buttons to select channels on the display.
- 3 CH RTN (Channel Return)** Press to return the to previous-channel.
- 4 MTS** Press to select from SAP, Mono or Stereo mode
- 5 VOL+ / VOL-** Press to adjust the volume.
- 6 DISPLAY** Press to display the information of current channel number and time.
- 7 ▼ / ▲ buttons (Direction Buttons)** Press to move highlighted selection through menus or submenus or adjust Channel +/- under TV input.
- 8 POWER** Press to turn display on/off.
- 9 ENTER** Press to enter the channel number, highlighted menu or submenu item.
- 10 FREEZE** Press to freeze the picture. Press again to unfreeze the picture.
- 11 CH + / CH-** Press to adjust channel up and channel down.
- 12 MENU** Press to activate or close the On Screen Display menu. In OSD Menu, acts as a cancel button while navigating through the OSD.
- 13 SOURCE** Press to show the source input from TV, Video 1, Video 2 or Video 3, Component 1, Component 2, VGA, DVI, and Cardreader (optional).
- 14 Hotkeys** Press to directly access certain Shortcut TV functions..

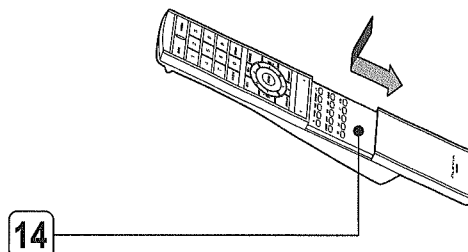
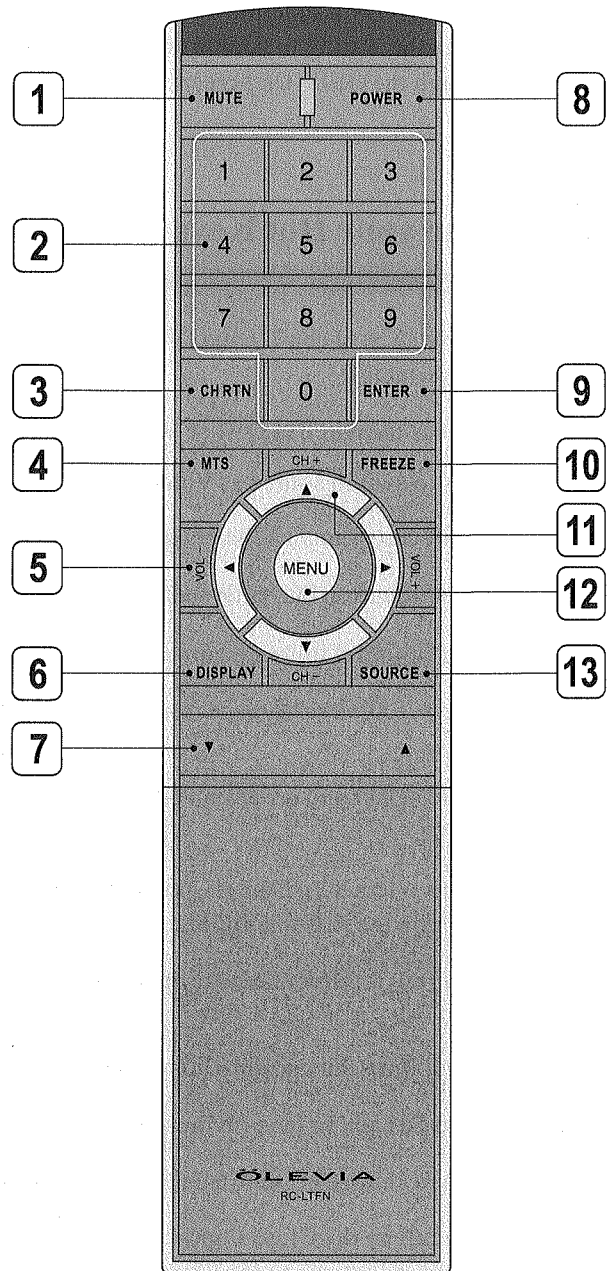

Hot Keys Tutorial

The remote control contains 15 additional "Hotkeys" that represent direct access to a certain function on your TV. Hotkeys enable you to directly change the setting to your preference without having to navigate through the OSD (On Screen Display) Menu.

How to use your Hot Keys

HOT KEY FUNCTION

TV Press to switch between TV and DTV Mode (optional function currently unavailable)

DVI/VGA Press to switch to DVI or VGA Mode.

VIDEO Press to switch source as Video 1, Video 2 and Video 3.

COMPONENT Press to switch between Component 1 and Component 2

C.R. (Optional function currently unavailable)

V.FORMAT (Optional function currently unavailable)

ASPECT Press to change the aspect ratio (4:3, 16:9, Zoom) and letterbox modes.

VIEW Press to select and program PIP, POP3, Split Screen or POP12 viewing options.

SWAP Press to select TV channels between main and sub screen. (This function is only in the PIP and Split Screen modes.)

FAVORITE Press to select favorite channels. Can be preset in OSD Menu.

EPG (Optional function currently unavailable)

EXIT Press to go back to the previous menu.

SLEEP Press to choose preset time interval for automatic shutoff.

C.C. Press to call up the Close Caption (CC) and Caption Service (CS) list. You can pre-select one to see Closed Caption.

P.CTRL Press to access Parental Control password and/ or program parental locks.

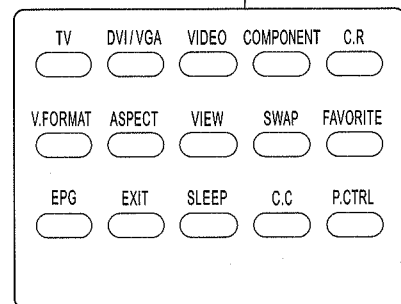
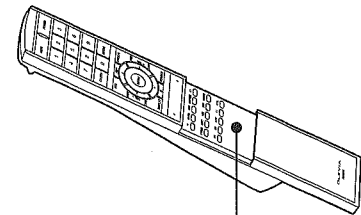

Battery Installation

1. Push the tab and pull it out as illustrated below.
2. Insert two size AAA batteries (supplied) by matching the (+) and (-) on the batteries to the diagram inside the remote control's battery department.
3. Replace the cover back and make sure the cover "snaps" into the remote control.

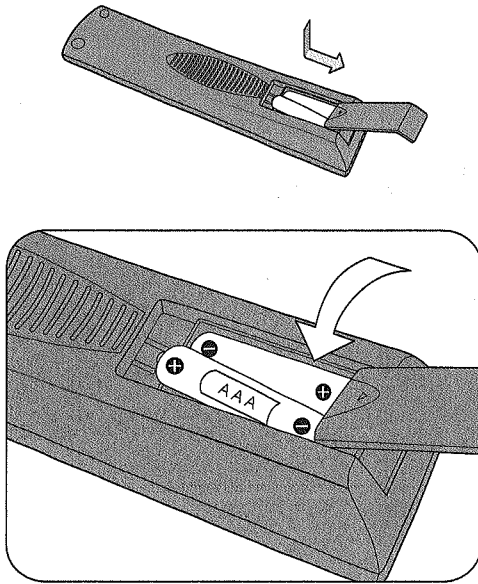

Note:

1. The display unit comes with two new AAA batteries as accessories. However, due to uncontrollable causes, the electricity of the accessorized batteries may be partially or completely drained. We do not warrant the quality of the batteries in any case since many factors are considered. If replacement is needed, please purchase two AAA batteries.
2. Handle remote with care. Avoid dropping it, placing in direct sunlight, near a heater, high areas of humidity or getting it wet. If the remote gets wet, please wipe it dry immediately. In the event of the remote not working properly or is inoperational, a replacement of remote control may be required.
3. If you do not use the remote control for a long period of time, please remove the batteries and store in a cool place to preserve battery life.
4. Do not mix new and used or with different types of batteries for operation.

Adjusting On Screen Displays (OSD)



Introduction

After you have finished connecting your TV, you are now ready to choose and personalize your TV settings in the OSD (On Screen Display) menu.

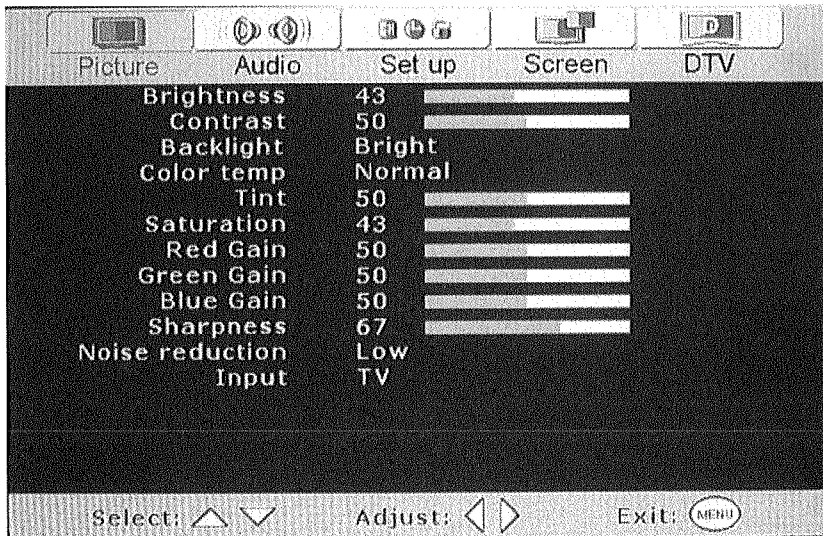
There are five main sections in the OSD (Picture, Audio, Setup, Screen and DTV).

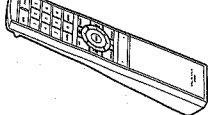
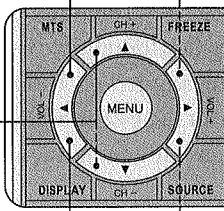
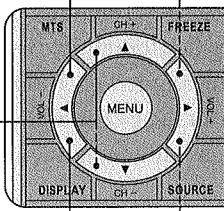

To Operate in the OSD

1. Press "Menu" button to enter OSD menu mode. 
2. To select between main functions, use the keys "VOL -" and "VOL+" 
3. To select the function, press the keys "CH+" and "CH-" 
4. To adjust the value bar, use the keys "VOL -" and "VOL+" 
5. After choosing your setting, press "Menu" to exit and go back to the last picture. 
6. To exit the OSD menu, press "Menu" until you exit the OSD menu, or without action for 12 seconds of inactivity. This is also adjustable in the OSD. 

Adjusting Picture Quality

In this Setup Index, you can adjust picture settings to suit your personal preferences.

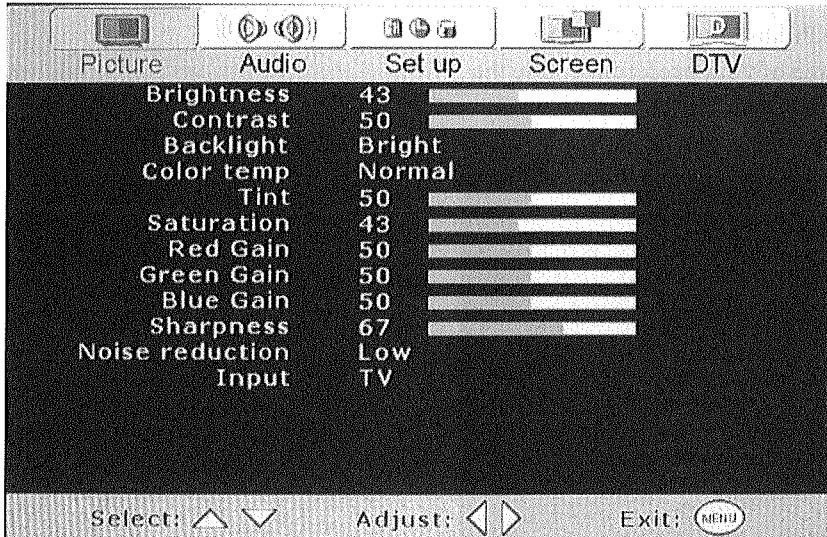

Picture Settings

Item	Adjustment	Function
Brightness	0~100	Adjusts picture brightness contrast
Contrast	0~100	Adjusts picture color contrast
Backlight	Soft / Normal / Bright	Adjusts darkness or lightness of the screen
Color temp	Cool / Normal / Warm	Adjusts image color intensity. Warm: More red-tinted colors Normal: Standard color temperature Cool: More blue-tinted colors
Tint	0~100	Adjusts skin color to a natural tone.
Saturation	0~100	Adjusts the color intensity
Red gain	0~100	Adjusts the color control with red tones
Green gain	0~100	Adjusts the color control with green tones
Blue gain	0~100	Adjusts the color control with blue tones
Sharpness	0~100	Adjusts the picture sharpness or softness
Noise reduction	OFF / Low / High	Adjusts the different level of noise reduction
Source	DVI, VGA, TV, DTV (not currently available) Video 1, Video 2, Video 3, Component 1, Component 2	Selects the input source.
Auto adjustment (Only display under VGA mode)		Corrects the image position according to an input source automatically.

Choosing the Input Source

There are two ways to choose the Input Source.

1. You can choose the input source in the Picture Index on the OSD Menu.

Scroll down to highlight the input source of your preference. Use the Ch. +/- to highlight the option and press either "Enter" button or "Vol+" to select it.

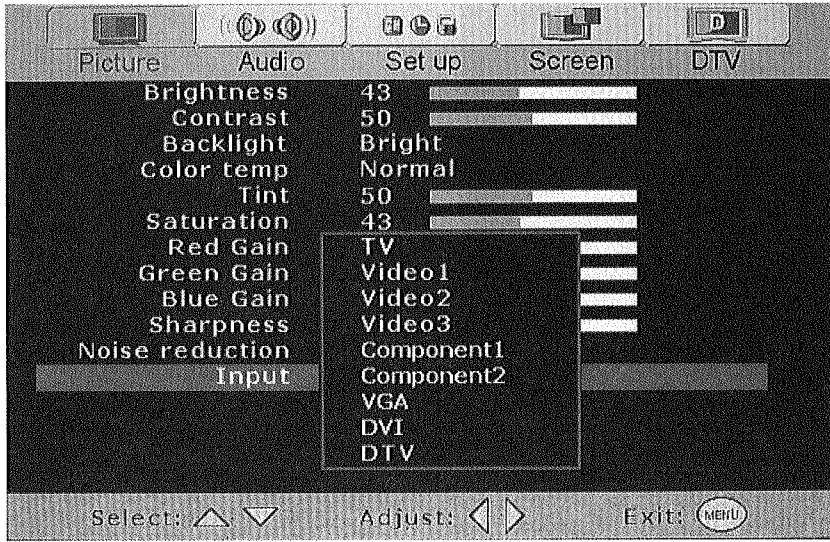

DTV not currently available

2. You can also choose the input source through the Hotkey shortcut function. Simply press "Source" to choose from the menu on the upper left hand screen. Use the Ch. +/- to highlight the option and press either "ENTER" button or "Vol+" to select it.



Auto Adjustment

In VGA mode, the picture could be slanted and smaller than a full screen. Select the item "Auto adjustment" to correct the picture. You may also press , the "Auto" hotkey on the remote control.

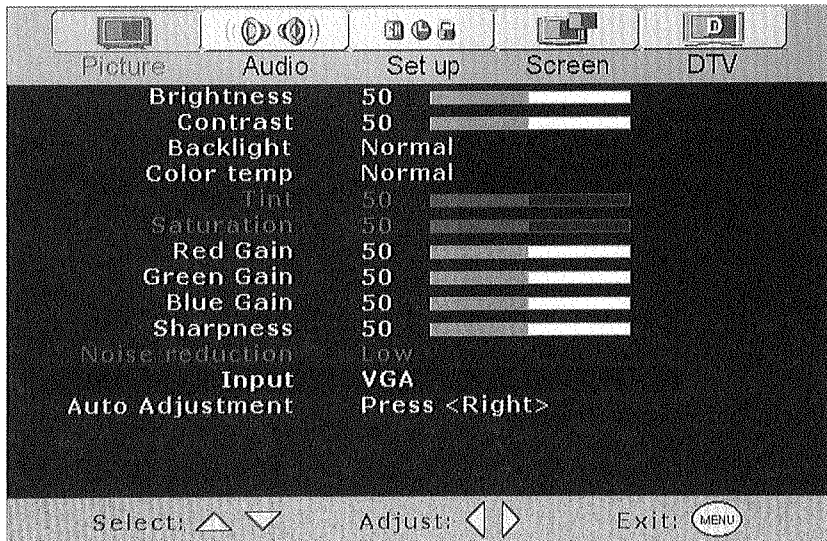

To Reset Factory Settings

If, at any time, you wish to go back to original factory setting, you may do so in the Set Up Index of the OSD Menu.

Selecting "Factory Default," will reset all OSD settings to the original manufacture settings. The only items which will remain unaffected, are:

- Clock
- Auto Scan Channels
- Edited Channels
- Parental Control Password

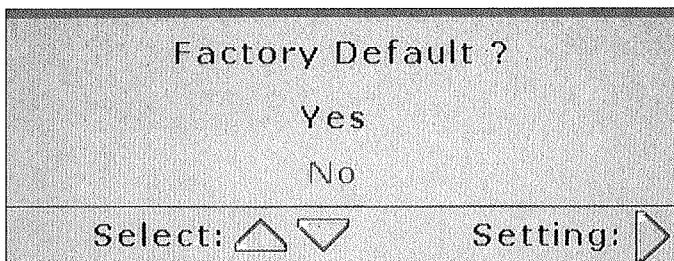

Adjusting Sound Quality

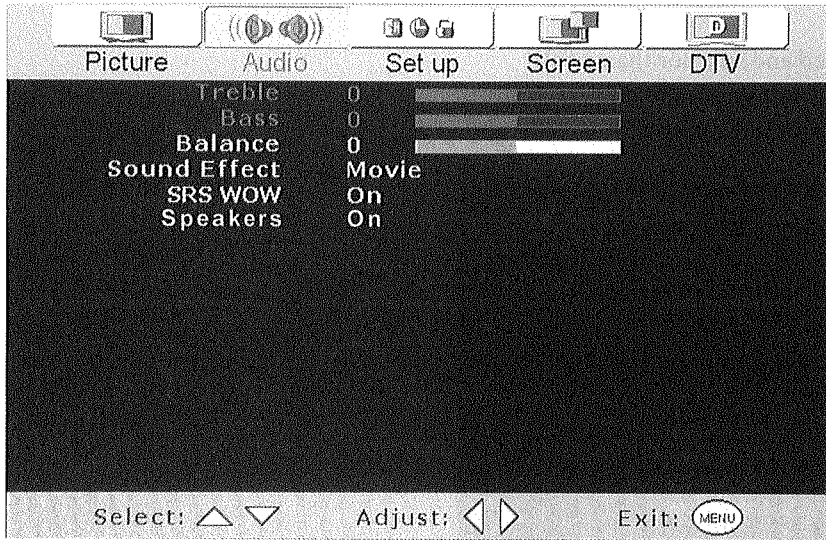

There are six adjustments to the TV Audio Function. You can adjust these individually to your personal preference.

Item	Adjustment	Function
Treble	-12~12	Adjusts higher pitched sounds
Bass	-12~12	Adjusts lower pitched sounds
Balance	-15~15	Adjusts volume balance in Left and Right
Sound Effect	Normal, Music, Speech, Movie	Speakers
SRS WOW * (not currently available)	On / Off	Creates a panoramic stereo audio image by producing deep and rich bass tones and clear treble tones. This enables you to enjoy powerful sound effects like those in a movie theatre.
Speakers	On / Off	Turns off the speakers of the TV when using a Receiver or Home Theater System.

*"SRS WOW" Creates a panoramic stereo audio image by producing deep and rich bass tones and clear treble tones. This enables you to enjoy powerful sound effects like those in a movie theater.

You can enhance certain sound effects while watching the TV with four options:

Sound Effect	Description
Normal	Balanced Treble and Base sound through both speakers
Music	Enhances instrumental music sound effects
Speech	Enhances vocal sound effects
Movie	Enhances background and surround sound

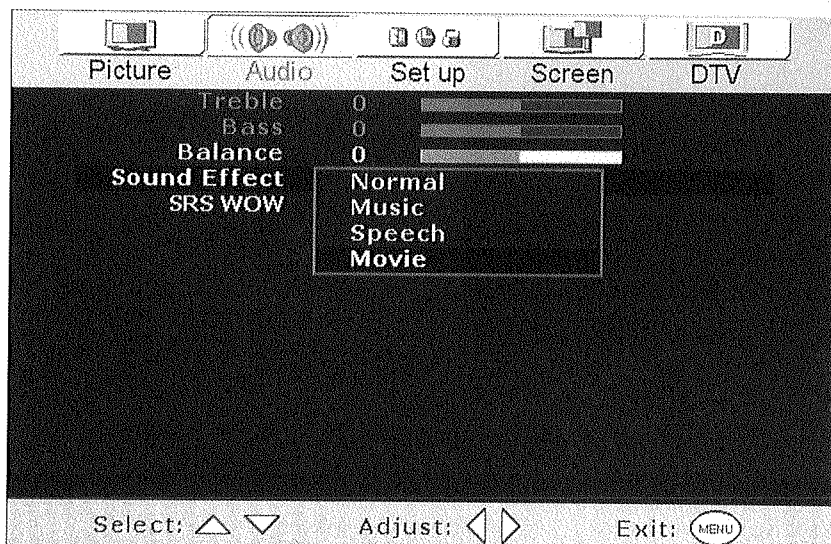

Selecting Stereo or Bilingual Programs

You can enjoy stereo, bilingual and mono programs.

Press the hotkey "MTS" until the desired sound indication appears. Each time you press the button, the sound indication changes as follows: **Mono, Auto SAP, Stereo***

Sound indication	Description
Stereo	Select for stereo reception when viewing a program broadcast in stereo
Auto SAP	Select to automatically switch the TV to Secondary Analog Program when a signal is received. (If no SAP signal is present, the TV remains in Stereo Mode)
Mono	Select for mono reception. (Use to reduce noise during weak stereo broadcasts)

Adjusting Personal TV Settings

In this Section, you can pre-select favorite channels, edit the setting of channels adjustment and selections that include: display "time" and "language", setting "alarm clock", "caption" option, "Parental control" and "OSD background type".

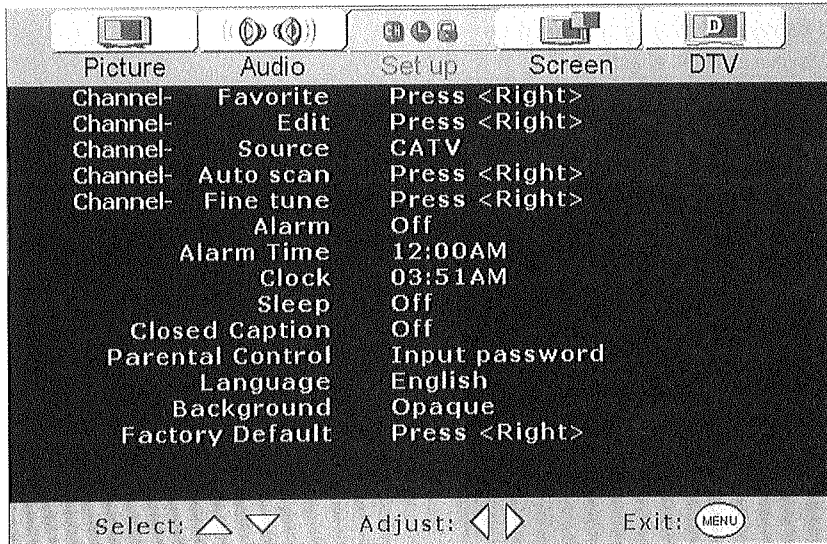

Description of Settings

Item	Adjustment	Function
Channel-Favorite	24 favorite channels setting	Stores the favorite channels
Channel-Edit	Add / Skip	Sets up available channels. Add : To add available channel. Skip : To cancel available channel
Channel-Source	CATV / TV	Chooses the source from ANT.
Channel-Auto scan		Selects to auto scan the available channels of the TV or CATV.
Alarm	ON / OFF	Sets the alarm on / off
Alarm time	Hour and minute adjustments	Adjusts the alarm time.
Clock	Hour and minute adjustments	Adjusts the clock.
Sleep	OFF / 30 min / 60min / 90 min	Sets a preset time interval for automatic shutoff.
Closed Caption	CC1 / CC2 / CC3 / CC4 Text1 / Text2 / Text3 / Text4 / OFF	Switches different types of caption or cancel caption functions.
Parental Control	MPAA G / PG / PG-13 / R / NC-17 / X TV (Child) TV-Y / TV-Y7 / TV-Y7-FV TV (Entire Audience) TV-G / TV-PG (V, S, L, D) / TV-14 (V, S, L, D) / TV-MA (V, S, L) Password	Sets up the parental locks.
Language	English / Deutsch / Francais / Espanol / Italiano / Portugues / Svenska / 繁體中文 / 簡中	Switches the OSD language
Background	Opaque / Translucent	Switches the OSD background.
Factory Default		Resets OSD setting to default.

Setting the Channels

After you finish connecting your TV, you can run Auto Scan program to setup your channels. The program will scan and preset all receivable channels automatically.

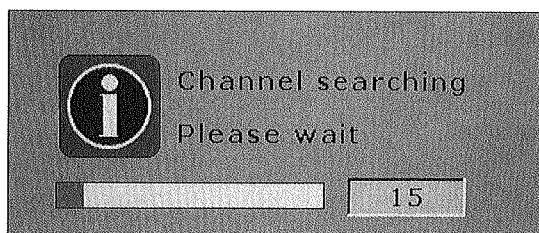

To Cancel Auto Program

Exit auto scan program by pressing "menu" Key.

Note: The Auto Scan is set to scan cable TV channels by default. You cannot receive and set the cable TV channels VHF/ UHF channels at the same time.

Setting Favorite Channels

You can select and store a list of your favorite channel settings.

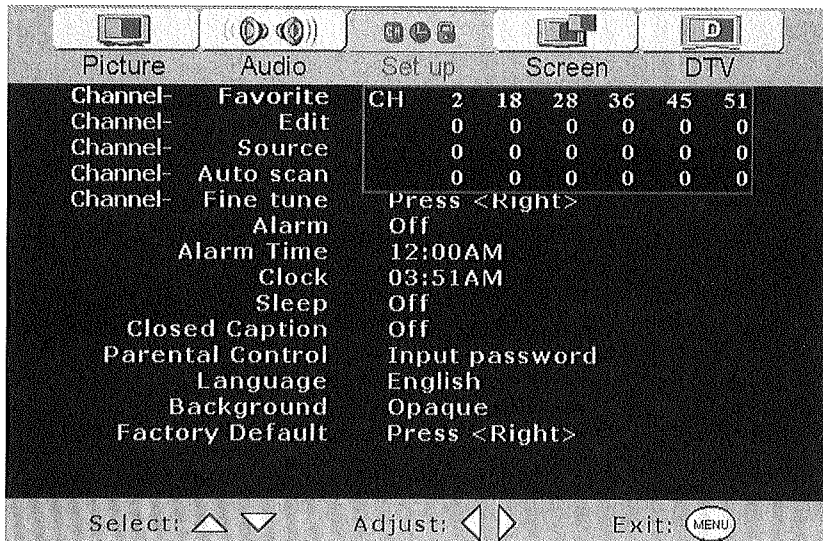

You can preset 24 favorite channels in this page. User can also access this function by pressing the "FAVORITE" hotkey on the remote control and select or switch between your favorite channels .

1. Press "VOL+ " to enter "Channel-Favorite" mode, you can see a pop window for favorite channel setting.
2. Press "CH + " and "CH - " to adjust the channel, you can also see the selected channel displays in real time.
3. Press "Enter" to exit when complete.

Watching favorite channels

To watch your favorite channels after specifying your preferences, just press the Hotkey "FAVORITE" to browse through each favorite channel.

Editing Channels

You can also edit channels to your personal preference. Once you edit a channel, it will be skipped when surfing through TV channels.

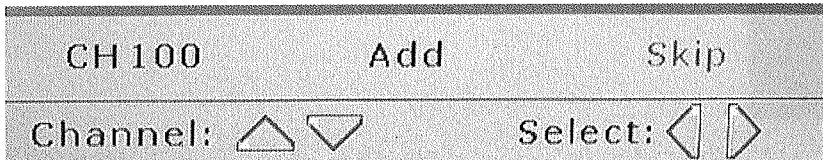

To Skip a Channel:

1. Enter Channel Edit, make sure SKIP is highlighted
2. Enter the channel number you wish to skip
3. Press "Enter" to exit when complete

To Undo a Skipped Channel:

1. Enter Channel Edit, make sure ADD is highlighted
2. Enter channel number you wish you edit
3. Press "Enter" to exit when complete

Setting up the TV Clock

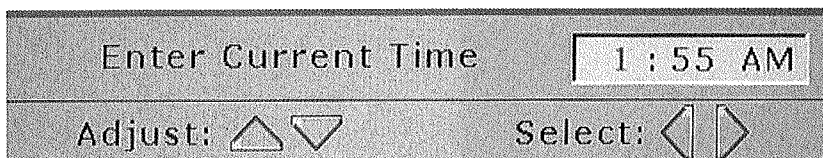

To setup the clock on the TV:

1. Using Vol+/- keys, enter in HH: MM: AM/PM sign
2. press "Enter" to exit when complete.

NOTE: Clock will NOT BE affected when Factory Default settings are reset.

However, when the power cord is not connected to the TV, you will lose all previous Clock adjustments.

Alarm: Turning ON the TV Automatically

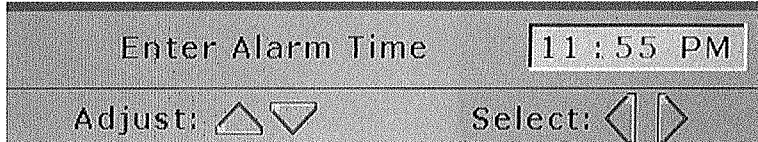

You can set the TV to turn on automatically at a predetermined time through the Alarm function.

Press Alarm ON/OFF button to setup the hour and minute adjustments. Your TV will automatically turn on when at the set time.

NOTE: Alarm WILL BE affected when Factory Default settings are reset.

When the power cord is not connected to the TV, you will lose all previous saved adjustments.

Sleep: Turning off the TV Automatically

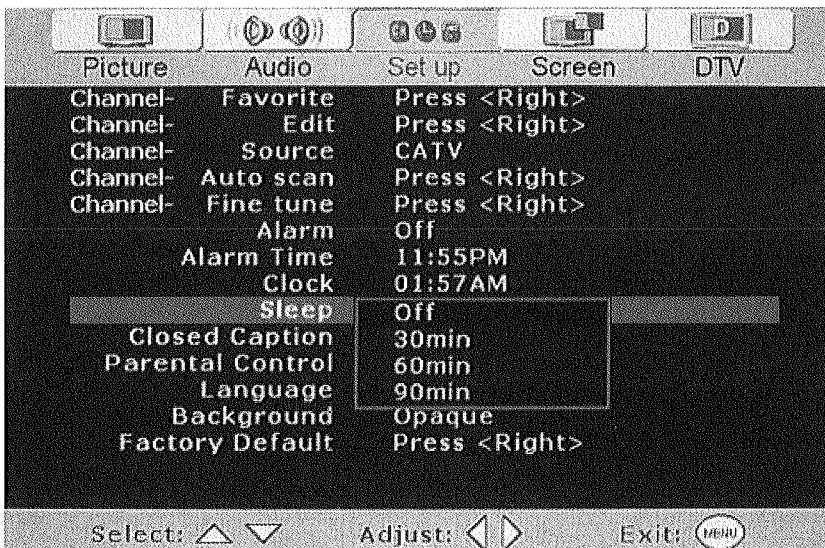

You can set the TV to turn off automatically after a predetermined period of time (30, 60, or 90 minutes). This is also available through hotkey "SLEEP".

Press SLEEP repeated until the desired period of time appears. Each time you press the button, you will see the options appear on the screen.

Note: When you press "DISPLAY", you will be able to see the channel number, TV Clock, and Sleep status.

Note:

1. If you turn the TV off, and then turn it on again, the Sleep timer automatically returns to "Off".
2. "The clock timer" appears one minute before the TV shuts off. This message may not appear if you perform any operation with the menu opened.

Watching with Closed Caption

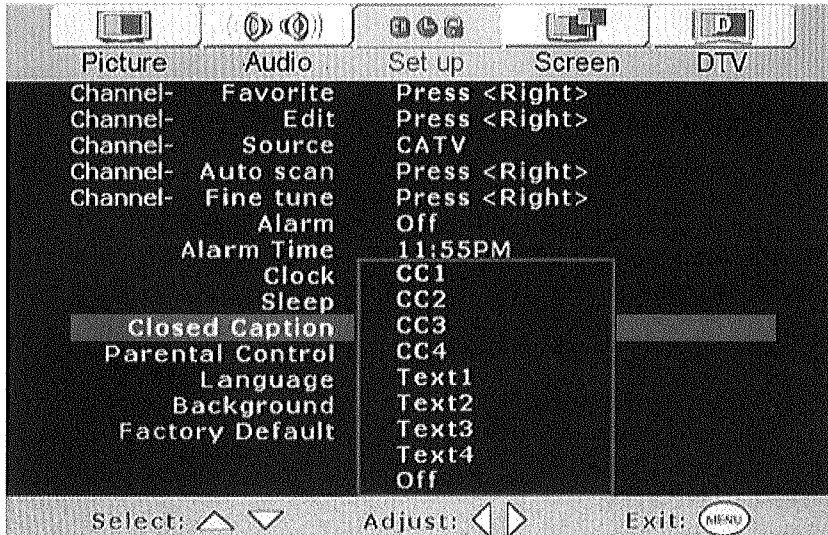

You can display closed captioning if the broadcaster offers this service.

Close Caption option can be set On/Off from the OSD page. This function also can be access by pressing "C.C " hotkey on the remote control.

1. Not all programs offer the Closed Caption option.
2. Closed Caption may not be seen clearly (white blocks, strange characters, etc.) if the signal condition is poor, or if there are technical difficulties with the broadcaster.
3. If no TEXT broadcast is being received while viewing in the [TEXT] mode, the screen may become dark and blank for some programs. Switch Off the Closed Caption mode.

Using the Parental Control Feature

To block programs you feel unsuitable for your children, you need to set the TV for desired rating systems. The TV Parental Control feature functions by receiving the rating signal from your local broadcasting station or cable service provider.

The TV programs and movies shown on TV are given a rating signal based on the following rating systems.

In U.S.A.: U.S. Television Parental Guidelines to rate television programs (U.S. TV Ratings) and Motion Picture Association of America (MPAA) Guidelines to rate movies including those shown on TV (Movie ratings).



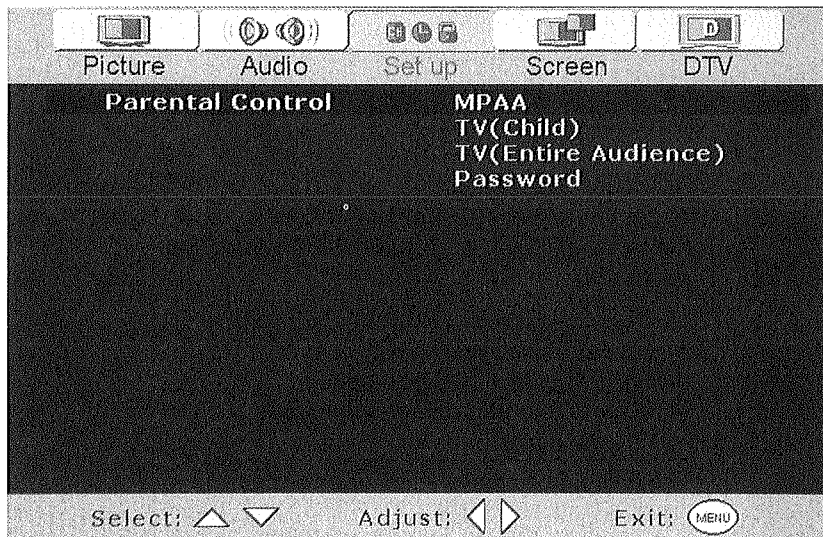





In Canada: Canadian English Language ratings to rate television programs in English, and Canadian French Language ratings to rate those in French.



Parental Control

1. This function allows programs to be restricted and controlled by parents based on FCC regulation. It prevents children from watching program contents that may be prohibited by parents.
2. Restriction of programs is based on three Rating Systems: MPAA Rating, TV (Child) Rating and TV (Entire Audience) Rating. The MPAA Rating restricts based on age. TV (Child) rating and TV (Entire Audience) Rating restrict based on age and contents.
3. When you block the lower rating, the higher age-based ratings are blocked automatically.
4. When you enter "Parental control" mode, those messages display for different state.

Activating the Parental Control Feature

To Setup Parental Lock	Illustration
 No password, Set it before use New password _ _ _ _	The message displays when you use "Parental control". Enter 4 numbers for the password setting.
 Confirm password _ _ _ _	Press the password again to confirm the password.
 Wrong password	The message displays when you enter the wrong number.
 The program is blocked, Enter password _ _ _ _	The message displays when you try to unblock the block program. Enter password to unblock it.
 The program is unblocked	The message displays when you unblock the program successfully.
 Enter password _ _ _ _	When you select "Change password", the message displays. Enter the pre-set password.
 Change password, Enter new password _ _ _ _	After enter the original password successfully, the message displays. Then press four numbers to set up the new password.
 Password changed	The message displays when you change password successfully.

Note: If you forget the password, press "9999" to lift the lock and enter the sub-page .

To View Blocked Programs

You can view blocked programs by entering the password. The Parental Control Feature will be cancelled temporarily until you turn off the TV.

Choosing Parental Control Settings

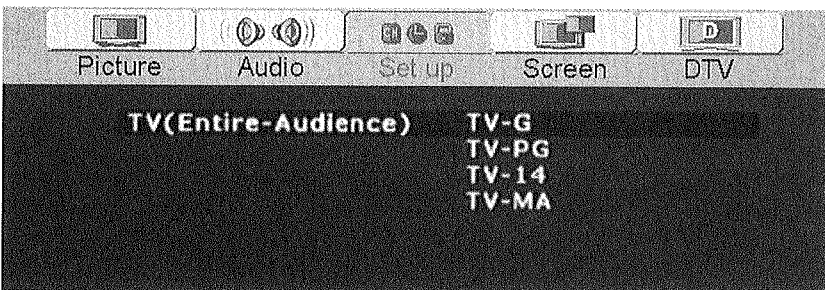
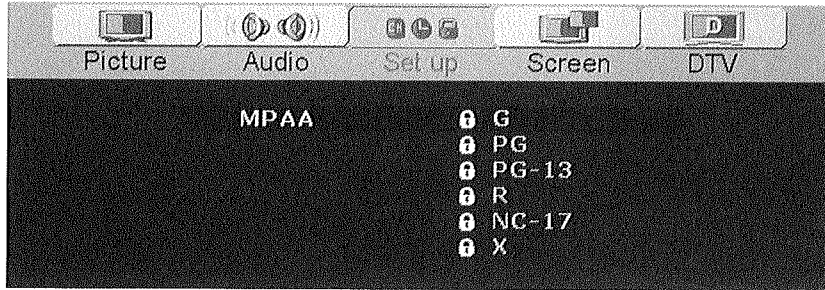

To Deactivate the Parental Control Feature

Set "Lock" to "Off" in the Parent Menu

Choosing your OSD Background

You can choose between two OSD background colors: Opaque and Translucent. This option is available for your personal preference.

Factory Default Option

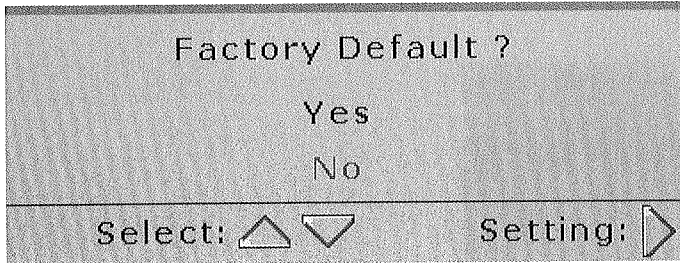

Reset Factory Settings:

Press "Factory Default" button, which will reset all OSD setting to original manufacture settings. The only items, which will remain unaffected, are:

- Clock**
- Auto Scan Channels**
- Edited Channels**

Adjusting Screen Modes

There are two options in the Screen Modes. "Aspect" and "View". The "Aspect" mode will allow you to watch normal broadcasts in wide screen modes and zoom modes. You can also view several screens at once through the "View" Mode.

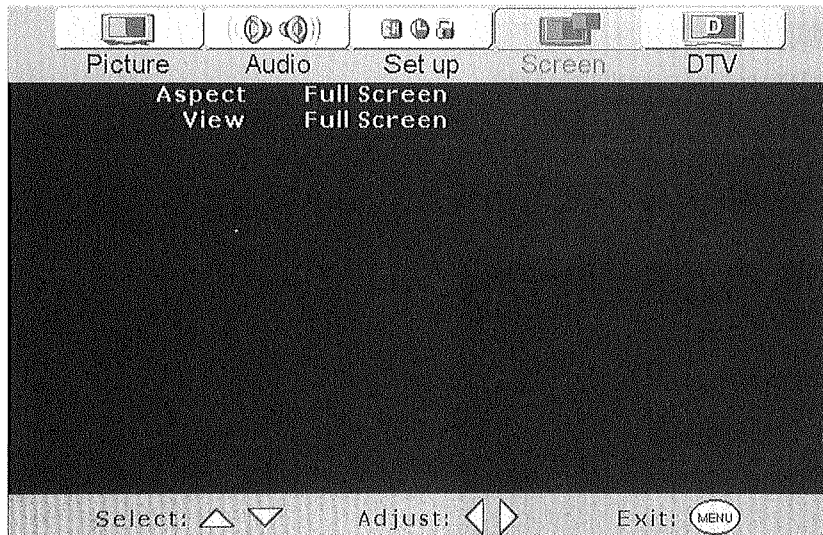

Changing the Screen Mode

You can alter the aspect ratio of a picture by choosing between these three options:

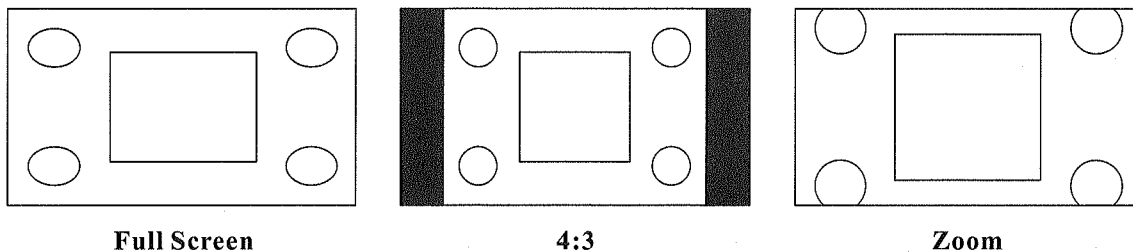

Full Screen: Enlarges the picture to 16:9 wide mode, by stretching the picture horizontally only.

4:3: Returns the 4:3 picture to its original size. This is considered the "normal" viewing mode.

Zoom: Enlarges (zoom-in) the size of a 4:3 picture on screen as geometric ratio, keeping the original image as much as possible.

Changing the View Modes

You can select four view types of picture modes that best suits the program you are watching. You can set a different view mode for each video input source and store it in memory.

View Modes	Function
PIP	Picture-in-Picture has a Main screen and small screen view
Split Screen	Full Screen split in two Views
POP3	Three Picture views outside Main Picture view
POP12	12 Picture views outside Main Picture view

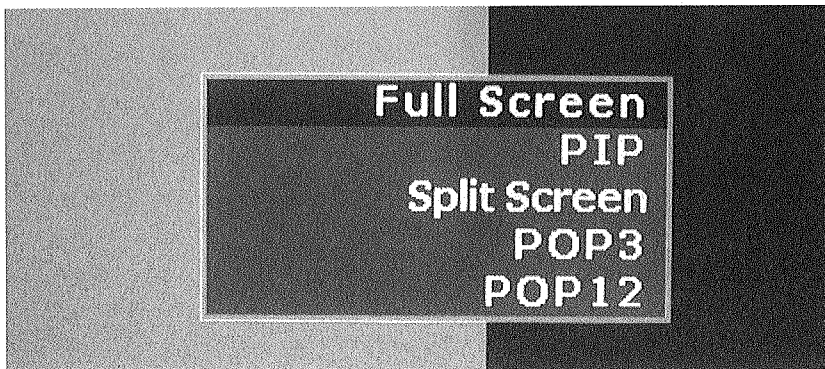

Picture in Picture (PIP)

Allows you to view a main screen (Picture 1) and a secondary small screen (Picture 2).

Press 'source' button to switch from P1 to P2 and vice versa.

OSD View

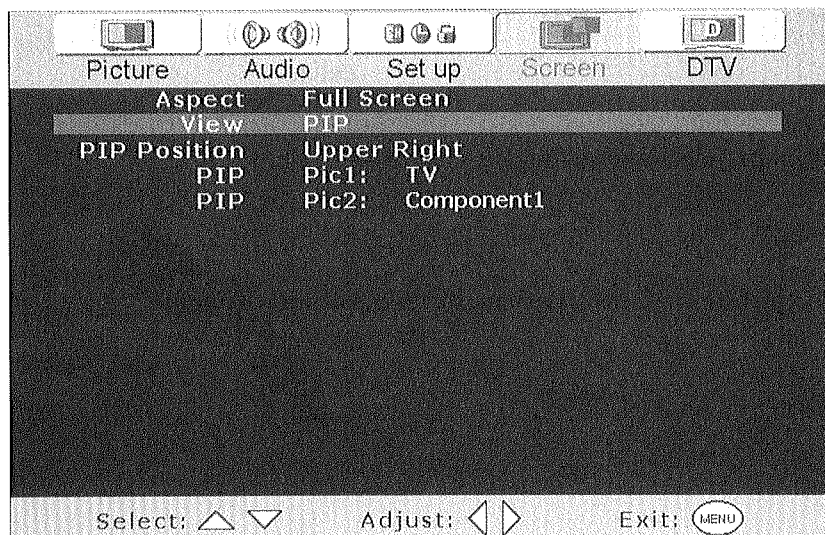

TV View

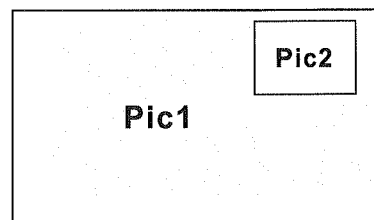
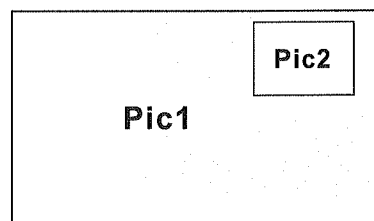

PIP mode

Item	Adjustment	Function
PIP Position	Upper Left / Upper Right / Lower Left / Lower Right	Changes the position of Picture 2
PIP-Pic1	Available sources	Switches the source of Picture 1
PIP-Pic2	Available sources	Switches the source of Picture 2

Note: Picture 1 allows for TV, Video 1, Video 2, and Video 3 connection source only. Picture 2 allows for TV, Component, VGA, DVI and DTV (this option not currently available) connection sources only.

Split Screen

Allows you to view two separate screens simultaneously (Picture 1 and Picture 2).

Press 'source' button to switch from P1 to P2 and vice versa.

OSD View

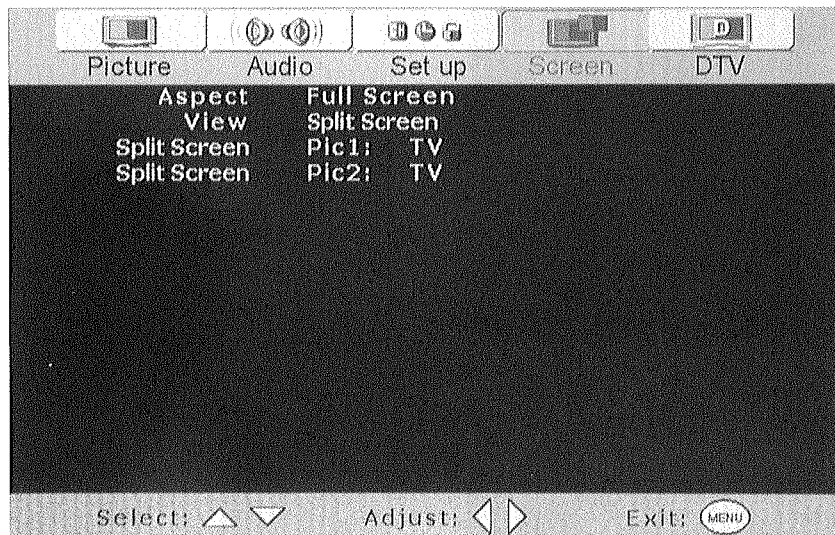

TV View

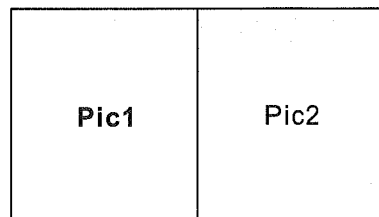
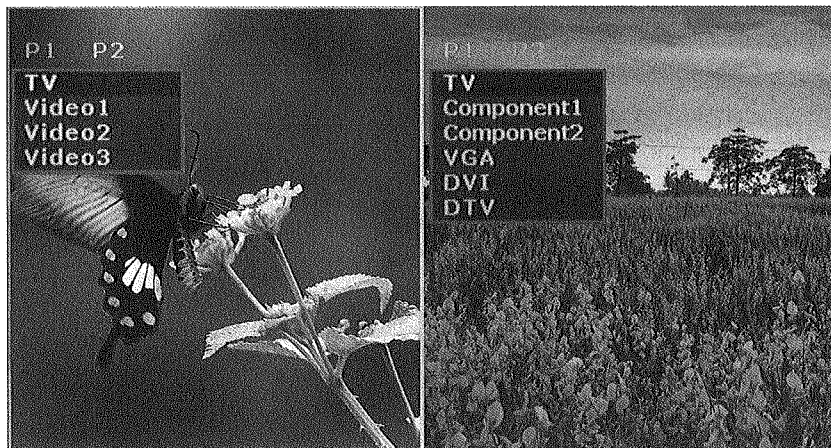

Split Screen mode

Item	Adjustment	Function
Pic1	Available sources	Switches the source of Picture 1
Pic2	Available sources	Switches the source of Picture 2

Note: Picture 1 allows for TV, Video 1, Video 2, and Video 3 connection source only. Picture 2 allows for TV, Component, VGA, DVI and DTV (DTV option is currently unavailable) connection sources only.

POP3

Allows you to view a main screen (Picture 1) with three smaller screens (Picture 2, 3, 4).

OSD View

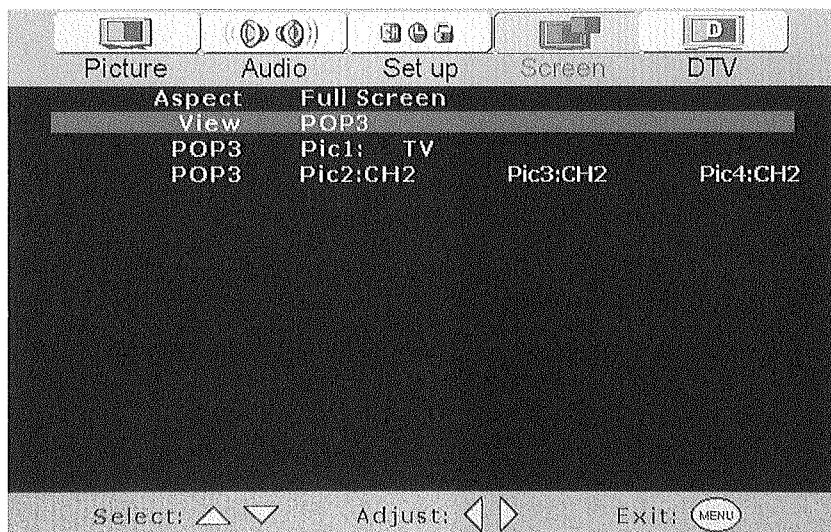

TV View

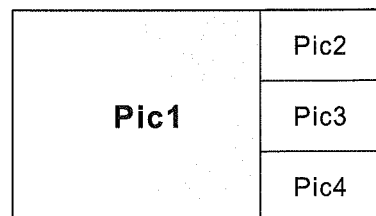
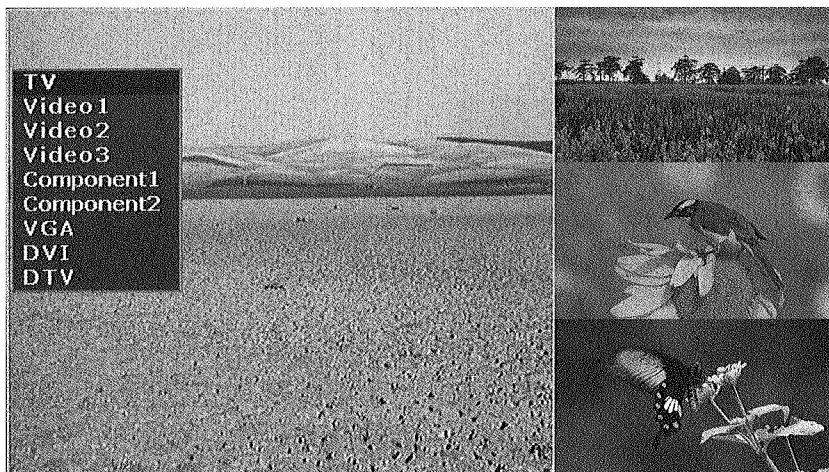

POP3 mode

Item	Adjustment	Function
POP3-Pic1	Available sources	Switches the source of Picture 1
POP3-Pic2	Channel setting	Switches the channel of Picture 2
POP3-Pic3	Channel setting	Switches the channel of Picture 3
POP3-Pic4	Channel setting	Switches the channel of Picture 4

Note: Picture 2, 3, 4 allows for TV connection source only. Please adjust viewing choices accordingly.

POP12

Allows you to view a main screen (Picture 1) with 12 smaller screens (Picture 2, 3, 4, 5, 6, 7, 8, 9, 10, 11, 12, 13).

OSD View

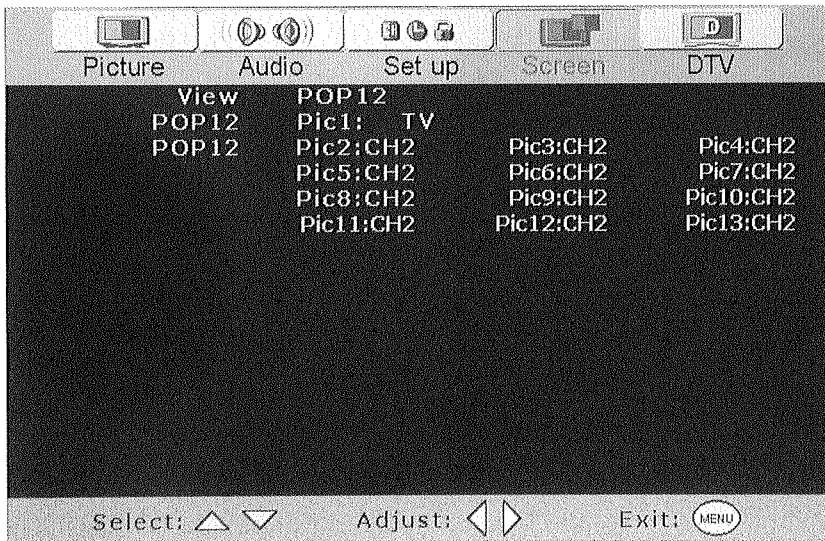

TV View



Pic2	Pic3	Pic4	Pic5
Pic13	Pic1		Pic6
Pic12			Pic7
Pic11	Pic10	Pic9	Pic8

POP12 mode

Item	Adjustment	Function
Pic1	Available Sources	Switches source or channel of picture
Pic2 - Pic13	Channel setting	Switches channel of each picture

Note: Picture 1 offers several choice for Connection source. Picture 2-13 allows for TV connection source only. Please adjust viewing choices accordingly.

Hint: To switch the channels between two Pictures (Picture 1 and Picture 2-13), use the hotkey "SWAP" to switch the current channel. Frame must be highlighted on index frame (Pictures 2-13) in order to complete SWAP function.

DTV: Currently unavailable

Troubleshooting

If you are still experiencing some difficulties with the TV Setup, please refer to the following suggested solutions for common problems and symptoms.

Problem	Possible Solution
Power On failed	Power plug is not securely inserted into the socket.
No picture or sound	<ol style="list-style-type: none">1. Check LCD TV power status.2. Check if the terminal is properly connected and the input mode has a right connection.3. Check if the cable is well connected between the video source and the TV.
Full of spots or noise on the screen	Check if any interference from automobiles, trains, high-voltage transmission lines, neon signs or other potential sources of interference.
Poor color display	Check OSD and adjust in "Picture" function
Image distortion	Check aspect ratio in "Screen" function.
The image is blue	Check the setting of source in the TV and set it in the right type.
The image is too bright, and the image is saturation in the brightest areas.	<ol style="list-style-type: none">1. Check if the contrast setting is too high.2. The DVD player is set for a high-level output.
The screen shows searching for signal but no image.	<ol style="list-style-type: none">1. Check if the signal cable is disconnected2. Check if the terminal is properly connected and the input mode has a right connection.
Out of range	Check if input signal is suitable to the display.
Remote control does not work	<ol style="list-style-type: none">1. Check if the batteries are properly installed.2. Check if the batteries are out of power.3. Check both distance and angle from the TV's infrared (IR receiver) to remote control.4. Check if any object is in between remote control and IR receiver.5. Check if the IR is under strong fluorescent lighting.
No sound	<ol style="list-style-type: none">1. Check if the display's sound volume is set on "mute" or set to minimum.2. Check if the headphone is connected.3. Check if audio cable is properly connected.4. Check if the speaker wires are both properly connected.
Stripes on the screen	Check if any interference from the radiation wave. Any antenna of radio or cell phone may also cause interference. Keep display away from those devices.

Specifications

TFT LCD Panel

Specificatinos	32"	37"
Panel size	32"	37"
Aspect Ratio	16:9	16:9
Pixels	1366 X 768	1366 X 768
Brightness	800 Nits	800 Nits
Contrast	1200:1*	1200:1*
H/V(View Angle)	178° (H) / 178° (V)	178° (H) / 178° (V)
Gray to Gray Response Time	8 ms	8ms
Video/Graphic Processing		
PC compatible frequency	30~85 KHz(H) / 50~85Hz(V) Max. 1366x768 @60Hz	30~85 KHz(H) / 50~85Hz(V) Max. 1366x768 @60Hz
Video Compatibility	NTSC only, unless specified by manufacturer	NTSC only, unless specified by manufacturer
DTV & HDTV Compatability	480i, 480p, 720p, 1080i	480i, 480p, 720p, 1080i
Aspect Ratio Adjustment	zoom, full screen, 4:3	zoom, full screen, 4:3
3D Comb Filter	Y	Y
3 : 2 / 2 : 2 Pull Down	Y	Y
Digital Noise Reduction	ON/OFF, High, Low	ON/OFF, High, Low
Adjustable Color Temperature	Cool, Normal, Warm	Cool, Normal, Warm
De-interlacer	Y	Y
VGA Auto Frequency Correction	Y	Y
TV Auto Frequency Detection	Y	Y
Audio Processing		
Auto Sound Level Control	Y	Y
Output Watt	15W + 15W	20W + 20W
Sound Effect	MTS (Mono / Stereo / SAP) SRS / WOW (currently unavailable)	MTS (Mono / Stereo / SAP) SRS / WOW (currently unavailable)
Input Terminals		
TV Tuner	NTSC tuner x1 + ATSC tuner x1 (ATSC tuner is optional function) NTSC tuner x2	NTSC tuner x1 + ATSC tuner x1 (ATSC or tuner is optional function) NTSC tuner x2
Video Input(rear side)	Input 1:AV x1, S-Video x1, RL x1 Input 2:AV x1, S-Video x1, RL x1 Input 3:Y, Pb/Cr, Pr/Cr x1, RLx1 Input 4:Y, Pb/Cb, PrCr x1, RLx1	Input 1:AV x1, S-Video x1, RL x1 Input 2:AV x1, S-Video x1, RL x1 Input 3:Y, Pb/Cr, Pr/Cr x1, RLx1 Input 4:Y, Pb/Cb, PrCr x1, RLx1
Video Input(front side)	Input 1:Video x1, S-Video x1, RL x1	Input 1:Video x1, S-Video x1, RL x1
Graphic Input(Rear)	Input 1:RGB D-Sub 15 pin x1 Input 2:DVI-D(HDCP)x1, RL x1	Input 1:RGB D-Sub 15 pin x1 Input 2:DVI-D(HDCP)x1, RL x1
Service Port(Rear)	RS-232 mini DIN 6 pins X 1	RS-232 mini DIN 6 pins X 1

* DCR : Dynamic Contrast Ratio

TFT LCD Panel

Output Terminals		32"	37"
Audio Output(Rear)		Output 1: Stereo Audio R/L x1	Output 1: Stereo Audio R/L x1
		Output 2: Sub Woofer RCA x1	Output 2: Sub Woofer RCA x1
Audio Output(Front)		Output 1: Earphone 1/8"	Output 1: Earphone 1/8"
		Stereo Min Jack X1	Stereo Min Jack X1
Others		32"	37"
Power	(Voltage)	100~240 VAC / 50-60 Hz	100~240 VAC / 50-60 Hz
	(Power Consumption)	145W	175W
	Stand-by	< 3W	< 3W
Dimensions (W x D x H)		39.8 in x 5.1 in x 22.4 in	45.6 in x 5.9 in x 26.3 in
Weight		45 lbs	65 lbs
Weight w/ stand		55 lbs	75 lbs

Dimensional drawing

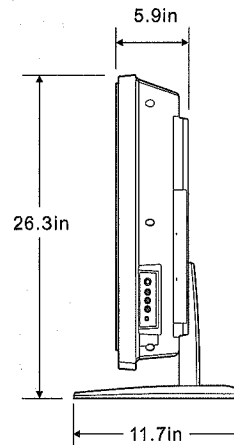
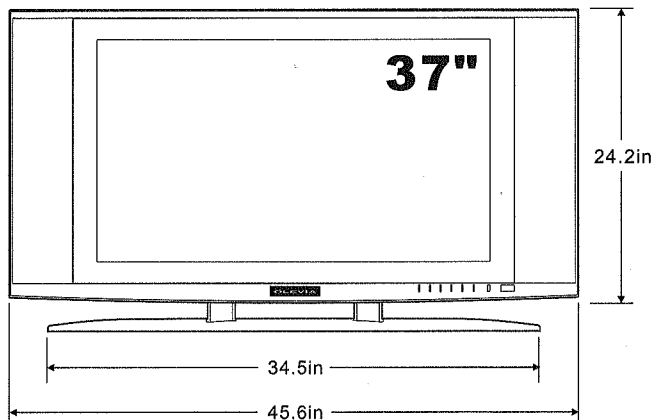
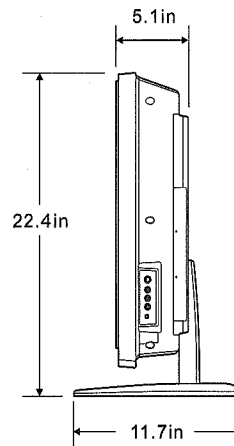
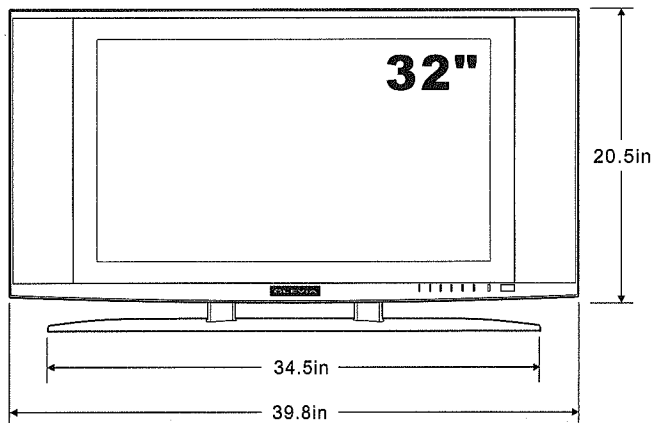

Timing Mode for VGA and DVI

Source	Resolution	Horizontal frequency (Khz)	Vertical frequency(Hz)	Pixel rate (MHZ)
YPbPr	480p	59.94	31.469	27
	720p	60	45	74.25
	1080i	60	33.75	74.25
VGA	512 x 384	60.147	24.48	15.667
	640 x 350	85	37.861	31.5
	640 x 400	85	37.861	31.5
		56	24.823	21.05
		59	30.296	24.964
	640x480	59	30.295	25.024
		66	35	30.24
		66	34.975	31.34
		66	35	30.24
		72	37.861	31.5
		75	37.5	31.5
		75	39.375	31.5
		85	43.269	36
	720 x 350	70	31.469	28.32
	720 x 400	70	31.469	28.32
		85	37.927	35.5
		87	39.444	35.5
	800 x 600	56	35.156	36
		60	37.879	40
		72	48.077	50
		75	46.875	49.5
		85	53.674	56.25
	832 x 624	74.6	49.725	55
	1024 x 768	86	35.522	44.9
		59	48.193	64
		60	47.699	64.1
		60	48.363	65
70		56.476	75	
70		56.287	77	
71		57.87	75	
75		60.241	80	

Source	Resolution	Horizontal frequency (Khz)	Vertical frequency(Hz)	Pixel rate (MHZ)	
VGA	1024 x 768	75	60.241	80	
		75	62.937	84.6	
		75	61.08	86	
		75	60.023	78.75	
		77	62.04	84.4	
		85	68.677	94.5	
	1053 x 754	86.907	35.414	45.5	
	1056 x 768	86.939	35.602	45.57	
	1120x750	80.042	32.857	47.8	
	1152 x 864	70.012	63.851	94.5	
		75	67.5	108	
	1152 x 870	75.062	68.681	100	
		1152 x 900	65.95	61.795	92.9
			66.004	61.846	94.5
			76.047	71.713	105.6
	1024 x 1024	76.149	71.809	108	
		60	63.36	89.2	
		61.399	65.286	92.9	
	1280x 960	60	60	108	
	1280 x 720	60	45	74.25	
	1028 x 1024	63.362	59.974	111.518	
	1136 x 768	47.7	60	85.765	
	1280 x 768	48.36	60	81.631	
DVI	1024 x 768	50.014	48.363	32.5	
		56.041	48.363	32.5	
	1280 x 720	60	45	74.25	
	800 x 600	60.317	37.879	40	
	1400 x 788	60	65.52	54	
	1400 x 1050	60	65.52	54	
	1024 x 768	60.004	48.363	65	
	1388 x 780	60	65.52	54	
	1028 x 1024	63.362	59.974	111.518	
	1136 x 768	47.7	60	85.765	
	1280 x 768	48.36	60	81.63	

Glossary

3:2 pull down - Process of converting 24 frames per second film to video by repeating one film frame as three fields, then the next film frame as two fields.

1	1	1	2	2	1	1	1	2	2
---	---	---	---	---	---	---	---	---	---

480I - 480 lines of display every 1/60 of a second; image is displayed by interlace scanning. See also Interlaced

480P - 480 lines of display every 1/60 of a second; image is displayed by progressive scanning. See also Progressive.

720P - 720 lines of display every 1/60 of a second; image is displayed by progressive scanning. See also Progressive.

1080I - 540 lines of display x 2 every 1/30 of a second; image is displayed by interlace scanning. See also Interlaced

16:9 - Aspect ratio under Hi Def. and theater movie formats. Also known as widescreen; see Aspect Ratio

4:3 - Aspect ratio under SDTV; see Aspect Ratio

Active Matrix TFT (Thin Film Transfer) - A type of display technology where the three primary colors are modulated. Results in better contrast ratios suitable for video.

Alarm - Feature on the Syntax Olevia models. Allows the unit to power on from the stand by mode.

Alarm Time - Time specified as to when the unit will power on. See Alarm.

Aspect Ratio - The ratio of an image according to the width and height of a picture.

ATSC - Advanced Television Systems Committee; international, non-profit organization that is committed to developing standards for digital television.
Reference: <http://www.atsc.org>

Bezel - Refers to the plastic or metal frame that acts like a shell around the LCD glass.

Backlight - Refers to the component, that lights up the LCD display.

Balance - Feature on the OSD for the Syntax Olevia models that adjust the left and right sound output from the speakers.

Background - Feature on the OSD for the Syntax Olevia models, which allows the user to change the OSD background, display to transparent or opaque.

Brightness - The measurement of color that is illuminated. Colors range from black to white.

CATV - Community Antenna Television (Cable Television)

LCD - Liquid Crystal Display

LCoS - Liquid Crystal on Silicon

LED - Light Emitting Diode

Luminance - refers to the brightness of an image.

Lux - 1 Lux = 1 footcandle; measurement of brightness

Moiré - A visual illusion in which a succession of parallel curved lines produces a pattern to the naked eye, but does not really exist. Otherwise known as the moiré effect.

NCTA - National Cable Television Association

Noise reduction - Feature on the OSD for the Syntax Olevia models that enables channels from the tuner box to reduce noise displayed on the LCD unit.

NTSC - National Television systems Committee

OSD - On Screen Display; brought up by pressing the menu button on the TV or the Remote.

Over Scanning - An image displayed is larger than the display area

PAL - Phase Alternating Line

Parental Control - The ability to block access to specified content from an unsuitable audience.

PIP - Picture In Picture; feature that enables one source to be displayed on top of another source.

Pixel Resolution - Refers to the number of rows horizontal and vertical that produces the image.

PIP - Picture in Picture; Allows an image to be displayed in front of another image.

POP3 - Otherwise known as Grid 3, which allows one main viewable box and 3 sub viewable boxes that refresh one after the other.

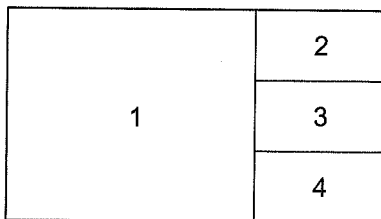

POP12 - Otherwise known as Grid 12, which allows one main viewable box and 12 sub viewable boxes that refresh one after the other.

2	3	4	5
13	1		6
12	1		7
11	10	9	8

Plug and Play - Describes the hardware or software that is installed and does not require any configuration before using.

Progressive - An image or lines of data that is reassembled from top to bottom sequentially.

Antonym: Interlaced

RGB - Red, green & blue These primary colors provide the basis for many different colors.

Refresh Rate - Refers to the maximum number of frames that the monitor can display per second. Usually measured in hertz.

Saturation - The amount of a particular color present in an image.

SCART - An industry standard for interconnecting audio-video equipment developed by Peritel. Usually associated with PAL video equipment.

SDTV - Standard Definition Television usually in 480I/P format.

SECAM - Sequential Color with Memory or Sequential Couleur Avec Memoire

Set-Top-Box - box that is capable of receiving and decoding digital transmissions (i.e. High Definition Cable Box, Digital Cable box).

Sharpness - Tries to artificially enhance the edges of a picture.

Single Link - supports a maximum bandwidth of 165 MHz (1920 x 1080 @ 60 Hz, 1280 x 1024 @ 85 Hz).

Split screen - Feature that places two images side by side.

1	2
---	---

Swap - Button featured on the Olevia remote. Used in the POP3 or PIP12 views to swap the sub viewable boxes with the main viewable box.

Tint - Adjusts the whiteness level within the color. Similar to Hue.

Under- scanning Term used where the image displayed is smaller than the display area.

Up convert - Process of converting a 480P/I signals to 720P or 1080I.

V-Chip - Chip that controls access to forbidden content specified by an adult.

VGA - 1. Video Graphics Array (DB15) 2.

Video Display - Refers to the display resolution

Video Resolution

Aspect Ratio 4:3		Aspect Ratio 16:9	
VGA	640 x 480	WXGA	1280 X 800
SVGA	800 x 600	SXGA	1280 X 1024
XGA	1024 x 768	WXGA+	1400 X 1050
QVGA	1280 x 960	WSXGA	1680 X 1050
SXGA+	1400 x 1050	WUXGA	1920 X 1200
UXGA	1600 x 1200	QSXGA	2560 X 2048
QXGA	2048 x 1536		
QSXGA+	2800 x 2100		
QUXGA	3200 x 2400		

Viewable Angle - Angle at which the screen is still viewable.

Widescreen - See 16:9

YCbCr - Used often with standard interlaced video equipment. See Component

YPbPr - Used often with progressive video equipment. See Component

Notes

Lined area for taking notes, consisting of 21 horizontal lines.

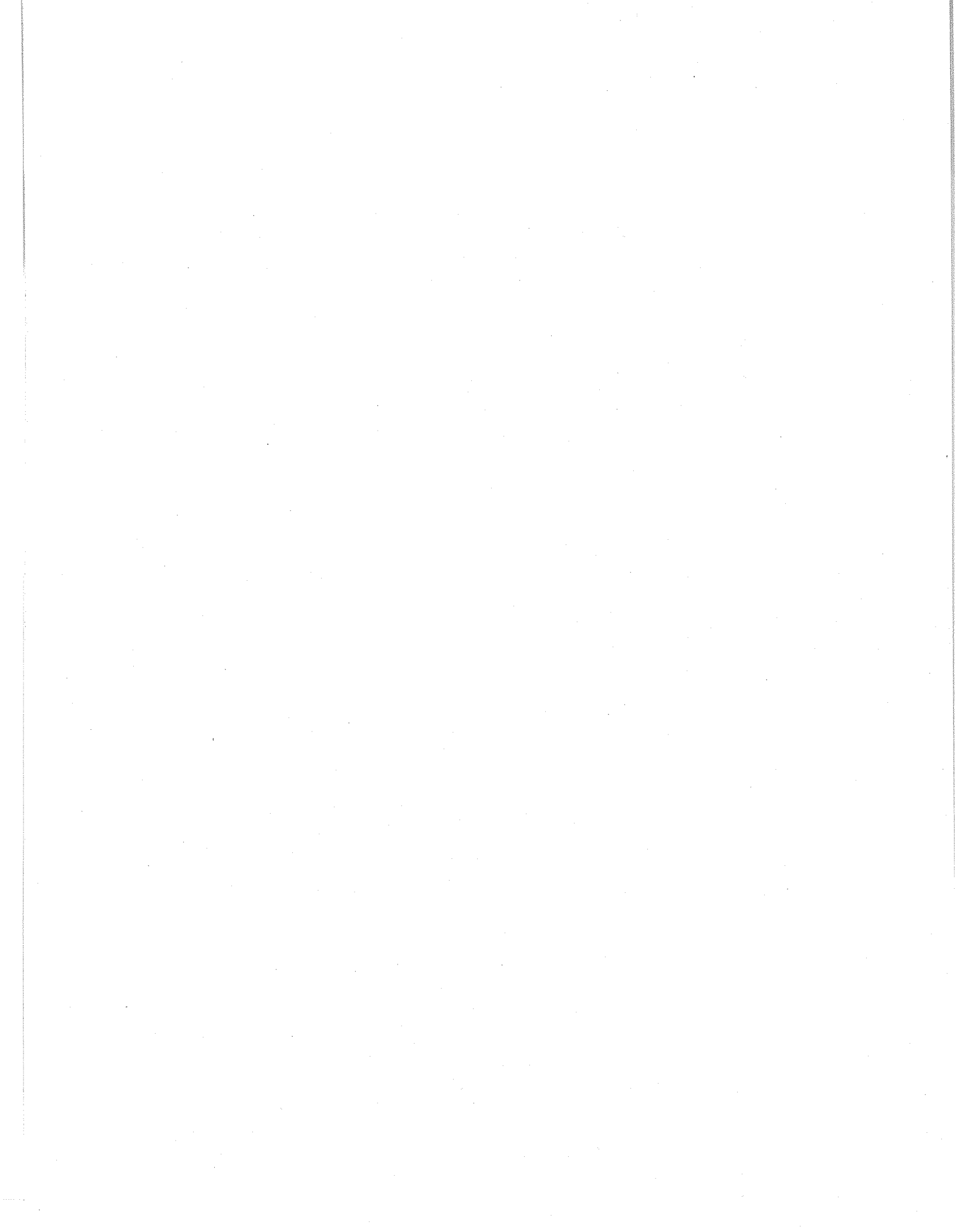

ÖLEVIA
By **S SYNTAX**

Syntax Groups Corporation © 2005 All Rights Reserved
www.syntaxgroups.com
For Customer Service Call 888-SYNTAX-8