



# *Your* **VIZIO** P4 46inch Plasma Television *User's Guide*



Setting Up

Troubleshooting



WHERE VISION MEETS VALUE!

## Table of Contents

<b>1. Safety Guidelines.....</b>	<b>1</b>
<b>2. Before Use.....</b>	<b>5</b>
<b>2.1 Opening the Package.....</b>	<b>5</b>
<b>2.2 Installation .....</b>	<b>5</b>
<b>3. Safety .....</b>	<b>6</b>
<b>4. Product Features.....</b>	<b>12</b>
<b>4.1 Available input signals .....</b>	<b>12</b>
<b>4.2 Power Management Function .....</b>	<b>12</b>
<b>4.3 Fan-free Design.....</b>	<b>12</b>
<b>4.4 Other Features.....</b>	<b>12</b>
<b>5. Standard Accessories .....</b>	<b>13</b>
<b>6. Names and Functions of Parts.....</b>	<b>14</b>
<b>6.1 Side View.....</b>	<b>14</b>
<b>6.2 Front View .....</b>	<b>15</b>
<b>6.3 Rear View.....</b>	<b>16</b>
<b>6.4 Remote Control .....</b>	<b>19</b>
6.4.1 Key Functions .....	20
6.4.2 Insertion of Batteries in the Remote Control.....	22
6.4.3 Remote Control Range .....	23
6.4.4 Using the Remote Control.....	23
<b>7. Connection to External Equipment.....</b>	<b>24</b>
<b>7.1 Connection to Antenna .....</b>	<b>24</b>
<b>7.2 PC Module .....</b>	<b>25</b>
<b>7.3 PC Module + Video Module .....</b>	<b>26</b>
<b>7.4 Connection to External Speakers.....</b>	<b>27</b>
<b>8. Basic Operation.....</b>	<b>28</b>
<b>8.1 Power On / Off.....</b>	<b>28</b>
<b>8.2 Input Mode Selection .....</b>	<b>28</b>
8.2.1 Selection of TV Mode .....	29
8.2.3 Selection of PC Input Mode .....	30
<b>8.3 OSD Option Adjustment .....</b>	<b>31</b>
<b>8.4 Sound Adjustment.....</b>	<b>32</b>
<b>8.5 Zoom Functions.....</b>	<b>32</b>
<b>8.6 Other Functions.....</b>	<b>33</b>
<b>8.7 OSD Functions.....</b>	<b>34</b>

8.7.1 General Description of the OSD Function Pages ..... 34  
8.7.2 OSD Menus and Functions..... 35

**9 Optional Accessories.....46**

**10 Technical Specification.....47**

**11 Factory Preset Timings.....48**

**12 Cleaning and Simple Troubleshooting .....49**

    12.1 Important.....49

    12.2 Cleaning the Housing and the Remote Control .....49

    12.3 Cleaning the Screen .....49

    12.4 Simple Troubleshooting .....50

**13 Installation of Wall Mount (Optional) .....50**

**14 Telephone & Technical Support.....58**

*Appendix A Warranty .....Error! Bookmark not defined.*

## 1. Safety Guidelines

Caution: Always use a power cable that is properly grounded. Please use the AC cords listed below for each area.

USA	UL
Canada	CSA
Germany	VDE
Britain	BASE/BS
Japan	Electric Appliance Control Act

### FCC Information

This equipment has been tested and found to comply with the limits for a Class B digital device, pursuant to part 15 of the FCC Rules. These limits are designed to provide reasonable protection against harmful interference in a residential installation. This equipment generates, uses, and can radiate radio frequency energy, and if not installed and used in accordance with the instructions, may cause harmful interference to radio communications. However, there is no guarantee that interference will not occur in a particular installation. If this equipment does cause unacceptable interference to radio or television reception, which can be determined by turning the equipment off and on, the user is encouraged to try to correct the interference by one or more of the following measures:

- Reorient or relocate the receiving antenna.
- Increase the separation between the equipment and receiver.
- Connect the equipment into an outlet on a circuit different from that to which the receiver is connected.
- Consult the dealer or an experienced radio/TV technician for help.

### FCC Warning

**To assure continued FCC compliance, the user must use the provided grounded power supply cord and the provided shielded video interface cables to connect to this equipment. Also, any unauthorized changes or modifications to this equipment would void the user's authority to operate this device.**

## Important Safeguards

- Read all the Safety Instructions and the User Manual before using the Display. Keep these instructions in a safe place for future reference.
- To avoid the risk of electric shock or component damage, switch off the power before connecting other devices to the Display.
- Unplug the power cord before cleaning the Display. A damp cloth is sufficient for cleaning the Display. Do not use a liquid or a spray cleaner for cleaning the product. Do not use abrasive cleaners.
- Always use the accessories recommended by the manufacturer to insure compatibility.
- When moving the Display from an area of low temperature to an area of high temperature, condensation may form on the housing. Do not turn on the Display immediately after this to avoid causing fire, electric shock or component damage. Do not use the monitor near water, e.g. near a bathtub, washbowl, kitchen sink, laundry tub, swimming pool or in a wet basement.
- Do not place the monitor on an unstable cart, stand, or table. If the monitor falls, it can injure a person and cause serious damage to the appliance. Use only a cart or stand recommended by the manufacturer or sold with the monitor. If you mount the monitor on a wall or shelf, use a mounting kit approved by the manufacturer and follows the kit instructions.
- A distance of at least 3 feet should be maintained between the Display and any heat source, i.e. radiator, heater, oven, amplifier etc.
- Slots and openings in the back and bottom of the cabinet are provided for ventilation. To ensure reliable operation of the monitor and to protect it from overheating, be sure these openings are not blocked or covered. Do not place the monitor on a bed, sofa, rug, or similar surface. Do not place the monitor near or over a radiator or heat register. Do not place the monitor in a bookcase or cabinet unless proper ventilation is provided.
- Never push any object into the slot on the monitor cabinet. It could short circuit parts causing a fire or electric shock. Never spill liquids on the monitor.
- The monitor should be operated only from the type of power source indicated on the label. If you are not sure of the type of power supplied to your home, consult your dealer or local power company.
- The power cable must be replaced when using different voltage from that specified in the User Manual. For more information, contact your dealer.
- The monitor is equipped with a three-pronged grounded plug, a plug with a third (grounding) pin. This plug will fit only into a grounded power outlet as a safety feature. If your outlet does not accommodate the three-wire plug, have an electrician install the correct outlet, or use an adapter to ground the appliance safely. Do not defeat the safety purpose of the grounded plug.
- Unplug the unit during a lightning storm or when it will not be used for long period of time. This will protect the monitor from damage due to power surges.
- Do not overload power strips and extension cords. Overloading can result in fire or electric shock.
- The wall socket shall be installed near the equipment and shall be easily accessible.
- Do not attempt to repair or service the product yourself. Opening or removing the back cover may expose you to high voltages, the risk of electric shock, and other hazards. If repair is required, please contact your dealer and refer all servicing to qualified service personnel.
- If any of the following occurs please contact the dealer:
  - The power supply or connector fails.
  - Liquid sprays or any object drops into the Display.
  - The Display is exposed to rain or other moisture.
  - The Display is dropped or damaged in any way.
  - The performance of the Display changes substantially.
- Operating environment:
  - Temperature: 32°F~104°F (0°C ~ 40°C)
  - Humidity: 20% to 85% non-condensing
  - Atmospheric pressure: 800 to 1100hPa
- Handling the remote control
  - Do not drop or mishandle the remote control.
  - Do not get the remote control wet. If the remote control gets wet, wipe it dry immediately.
  - Avoid heat and humidity.
  - When not using the remote control for a long period, remove the batteries.
  - Do not take apart the batteries, heat them, or throw them into a fire.

## 2. Before Use

The Vizio P4 is a 46" WVGA (wide-screen with VGA resolution) Plasma Display. It has passed the Class-B EMC test and the UL and CSA safety certifications, and is an ideal product for individual users and commercial exhibitors.

The product is a precise electronic product; Users should read the following instructions carefully to maximize the performance of the product.

### 2.1 Opening the Package

- The Vizio P4 is packaged in a carton together with other standard accessories. Any optional accessories are packed separately in another carton.
- The weight of the Plasma Display is approximately 82 Lbs. (37 kg.) Due to the size and weight of the product, it is recommended that it be handled by a minimum of 2 persons.
- The protective glass and the glass substrate are installed on the front of the product. Since both glasses can be easily scratched or broken, please handle the product gently. Never place the unit on a surface with the glass facing downwards unless it is on protective padding.
- When opening the carton, check that the product is in good condition and that all standard accessories and items are included.

### 2.2 Installation

- Please read the user manual carefully before performing the installation.
- A qualified technician from the distributor or authorized agent should always install the product.
- The power consumption of the display is approximately 350 Watts, significantly higher than a typical TV set. Please use the power cord designated for the product. When an extension cord is required, use one with the correct power rating.
- The product should be installed on a flat surface to avoid tipping. Space should be maintained between the back of the product and the wall for proper ventilation.
- Avoid installing the product in the kitchen, bathroom or other places with high humidity dust or smoke, so as not to shorten the service life of the electronic components.
- Please ensure the product be installed with the screen in landscape orientation, any 90° clockwise or counterclockwise installation may induce poor ventilation and subsequent component damage.
- To protect the screen and avoid screen burn, do not keep a static picture displayed for a prolonged period of time. **This can result in "sticking" of the image, and is not covered by the warranty.**

### 3. Safety

This product is designed and manufactured to operate within defined design limits, and misuse may result in electric shock or fire. To prevent the product from being damaged, the following rules should be observed for the installation, use and maintenance of the product. Read the following safety instructions before operating the display.

The User Manual uses the following symbols to ensure safe operation and prevent user injury or property damage:



WARNING - Disregarding or inappropriate use may cause damage to the product.



ATTENTION - Disregarding or inappropriate use may cause injury to the user.

Examples



Prohibition



Warning (Attention) symbol (indicating "Electric Shock").

	<h2>WARNING</h2>
---	------------------

**Do not install the product on sloping or unstable surfaces**

The product may fall over and incur damage or cause injury.



**Only the marked power source can be used for the product**

Any power source other than the specified one may cause fire or electric shock.





**WARNING**

**Keep the product away from moisture**

Do not expose this appliance to rain or moisture.

If water penetrates into the product, unplug the power cord and contact with your dealer. Continuous use in this case may result in fire or electric shock.



**Do not place any objects on the top of the product**

Spilled water or metal objects may cause short circuit, fire or electric shock if they penetrate into the housing of the product.



**Never use a damaged power cord**

Heavy objects, heat or tensile force may damage the power cord and cause fire or electric shock.



**Do not modify or open the back cover**

Removing the back cover of the product may cause fire or electric shock.

Contact the manufacturer when inspection or adjustment is required.



**Do not use the product if any abnormality occurs**

If any smoke or odor becomes apparent, unplug the power cord and contact dealer immediately. Do not try to repair the product yourself.







**WARNING**

**Avoid using dropped or damaged appliances**

If the product is dropped and the housing is damaged, the internal components may function abnormally. Unplug the power cord immediately and contact dealer for repair. Continued use of the product may cause fire or electric shock



**Do not touch the power cord during lightning**

To avoid electric shock, avoid handling the power cord during electrical storms.



**ATTENTION**

**Do not install the product close to smoke or moisture**

Operating the product close to smoke or moisture may cause fire or electric shock.



**Do not install the product in an area with heavy dust or high humidity**

Operating the product in environments with heavy dust or high humidity may cause fire or electric shock.

**Instructions for moving the product**

Ensure that the power connector and any other cables are unplugged before moving the product.



**The power cable should be kept away from heat sources**

Heat sources may melt the covering of the power cable, causing fire or electric shock.





**ATTENTION**

**Hold the power connector when removing the power cable**

Pulling the power cable itself may damage the wires inside the cable and cause fire or electric shock.



**Do not touch the connector with wet hands**

To avoid risk of electric shock.



**Insert batteries in accordance with instructions**

Insert the batteries with correct polarities (positive + and negative -). Incorrect polarities may cause damage and leakage of the batteries, operator injury and contamination the remote controller.



**Do not block or cover the vents**

Blocking the vents may cause overheating and fire.

Do not install the product in a place with little or no ventilation. Never cover the vents with towels, blankets or dusters.

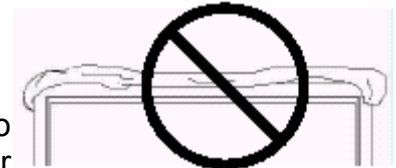

**Unplug the connector**

Unplug the power connector when the product will not be used for an extended period of time.



**ATTENTION****Image Sticking**

The plasma monitor illuminates phosphors to display images. The phosphor has a finite illumination life. After extended periods of illumination, the brightness of the phosphor will be degraded to such an extent that stationary images would burn-in that part of the screen as grayed-out images.

Tips to prevent such image sticking are:

\*Do not display images having sharp brightness differences or hi-contrast images, such as monochrome characters and graphic patterns for extended periods.

\*Do not leave stationary images for extended periods, but try to refresh them at appropriate intervals, or try to move them using the screen saver function.

\*Turn down the contrast and brightness levels.

NOTE: Such "Image Sticking" constitutes misuse and is **NOT COVERED** by the manufacturer's warranty.



## 4. Product Features

The 46" PDP provides quality image displays and is suitable for a variety of multimedia applications.

### 4.1 Available input signals

- The standard PC module provides RGB (D-SUB15 PIN) and digital DVI input connectors, and a RS-232 communication connector (D-SUB 9 PIN MALE).
- The Video + Tuner module provides composite video (RCA), S-video (DIN4P) and component video (RCA) input connectors, and a composite video (BNC) output connector. It supports the quality input images of DVD and HDTV (480P/720P/1080i), as well as the images of TV systems such as NTSC, PAL and SECAM. The Video module also provides two sets of stereo audio input connectors (RCA).
- The product supports PC image resolutions up to XGA (1024X768) with a vertical frequency of 85Hz.

### 4.2 Power Management Function

The display can switch to a power saving mode using the PC input.

### 4.3 Fan-free Design

The unit does not require any fans for ventilation, providing quiet operation and lower power consumption.

### 4.4 Other Features

- PIP Function: The user may watch video while working on their PC.
- The product includes a set of built-in 2W loudspeakers or can be connected to two external 10W speakers.
- The Display provides High, Medium and Low color temperature options. The user may also set a custom color temperature to suit individual preference.

## 5. Standard Accessories



This User Manual x1

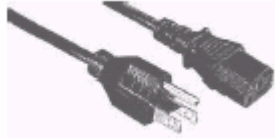

Power Cord x1

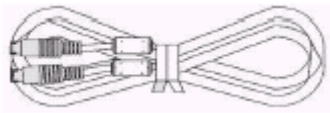

S-Video Cable x1



15-Pin D-Sub Cable x1



AV Cable x1



AA Battery x2



Remote Control x1

**NOTE:** The style of the Remote Control included with the Display may not be identical to the one pictured.

## 6. Names and Functions of Parts

### 6.1 Side View

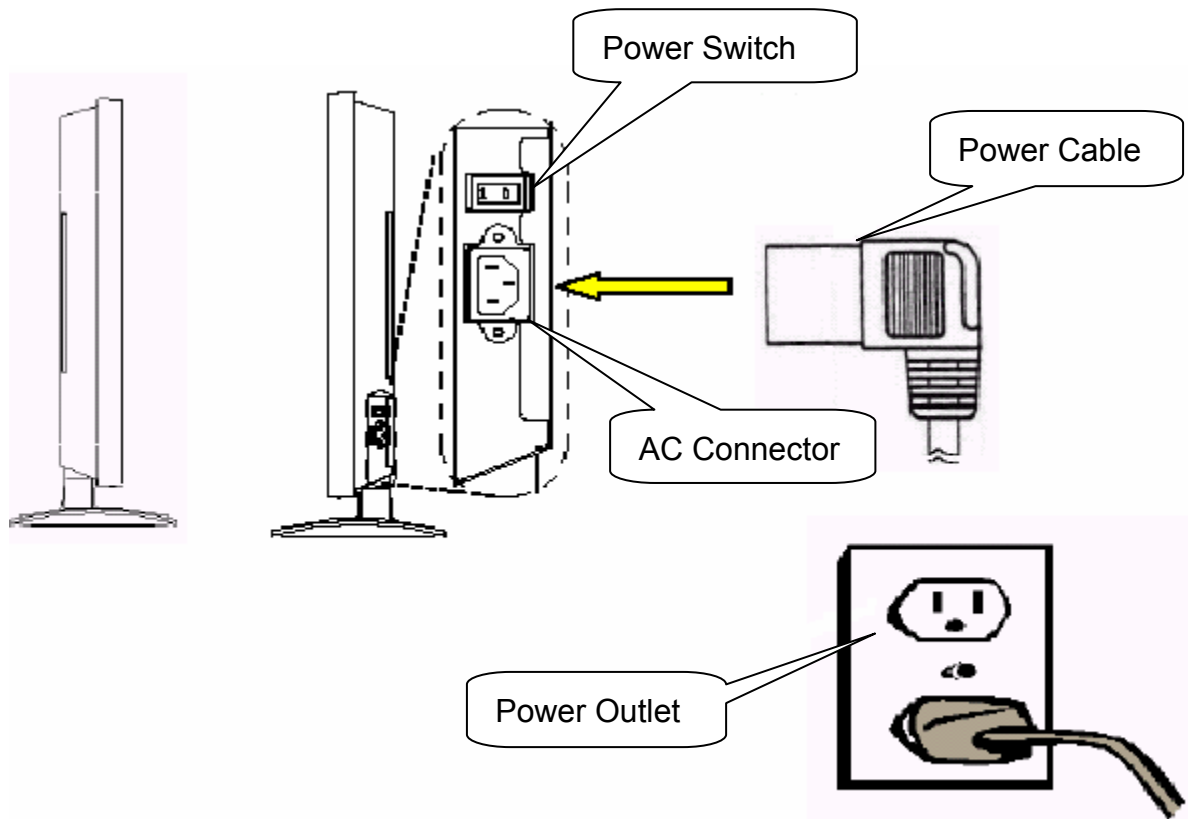

- Connect the power cable female end to the display, then connect the male plug to the wall outlet. Note: Male plug types vary among countries. The power plug shown above may vary from the type supplied with your product.
- Push the power switch (O: Off, I: On) to the I (On) position. The power indicator on the front panel will glow red, indicating that the plasma is in standby mode.

## 6.2 Front View

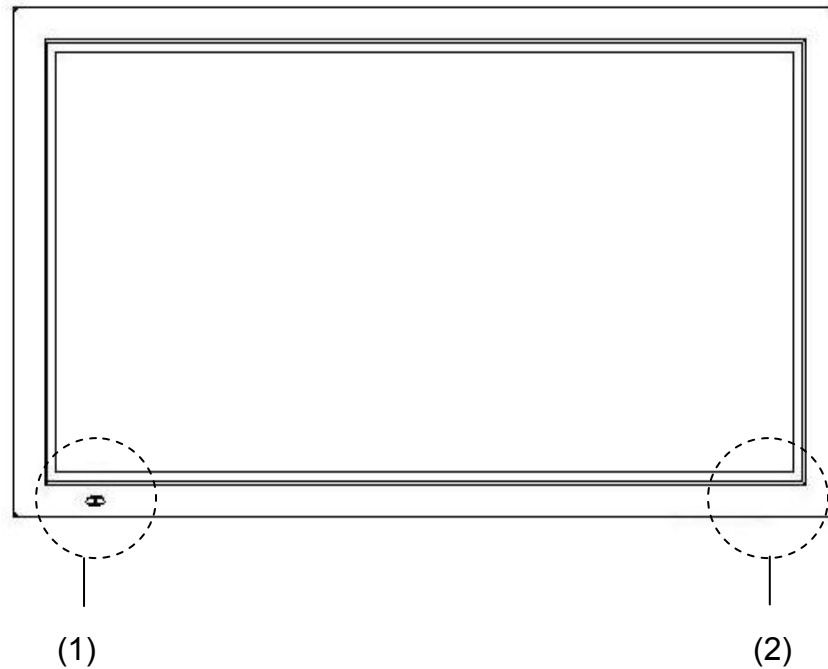

### (1) Remote Control Window

The window includes the power indicator and the IR remote control sensor. LED's are used to indicate the power status and the receiving of remote control signals.

Indicator ON (red)	Standby mode.
Indicator ON (green)	Power ON mode.
Indicator flashing (red/green) alternately	Power Saving mode.

### (2) Buttons



The functions of the buttons are described as follows:

- **INPUT:** Selects the signal inputs in the following sequence, RGB1⇒RGB2⇒AV1⇒S-Video⇒YCbCr/PbPr⇒TV/CATV (displayed sequentially).  
**Note:** This button can display the input selection as an OSD so that the signal sources may be chosen with the ▲/▼ buttons and selected with the ► button.
- **MENU:** Activates the OSD Menu and selects an OSD Menu page; the pages appear in the following sequence, Display⇒Image (PC Input) or AV System (Video Input) ⇒Audio⇒Language ⇒Screen Saver⇒Miscellaneous⇒Status (displayed sequentially)
- **▲/▼:** A – Used as Up/Down buttons in the OSD Menu screen.



B – Used for quick adjustment when the OSD Menu is not displayed on the screen. The selections appear in the following sequence, Balance⇒Bass⇒Treble⇒Volume⇒PIP Source\*⇒Contrast\*⇒Brightness\* (sequential display). The adjustments are made in conjunction with the ◀/▶ buttons.

\*Note: The PIP source is only for the PC Input and the Contrast and Brightness are only for the Video Input.

- ◀/▶: A – Used as Left/Right buttons in the OSD Menu screen.  
The ▶ button also functions as Enter.  
B – Used for the adjustment of Volume when the OSD Menu is not active on the screen. Press ◀ to reduce the volume, press ▶ to increase the volume.
- STANBY/ON: Is used to activate the Display or return it to Standby mode.



is the trademark of SRS Labs, Inc.  
Licensed from SRS Labs, Inc.

### 6.3 Rear View

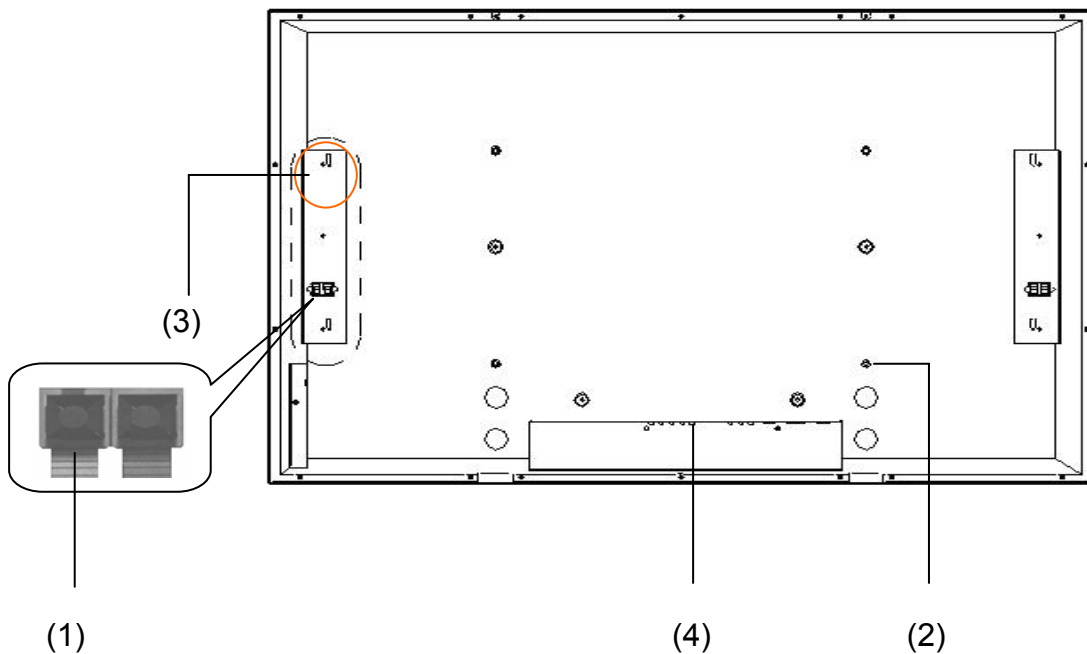

- (1) Speaker Terminals:  
Can be used to connect external speakers to the Display. Maximum power output 10W (each) into 8 Ohm impedance.
- (2) Wall Mount attachment holes:  
Use the standard screws to attach the wall mount (optional accessory).

(3) Speaker Mounting Holes:

Use the brackets and screws supplied with the optional speakers to attach them to the product.

(4) Signal Input Connectors:

- **PC Module**



- i. D-Sub: For PC display purposes. Connects to the 15-Pin D-Sub analog output connector of the PC.
- ii. DVI: For high quality PC display purposes. Connects to the DVI-I digital output connector of the PC.
- iii. RS-232C: is a 9-Pin D-Sub male connector used as a control port for serial communication between a PC and the Display.

- **Video Module**



- i. CVBS Out: Is a Composite Video output (BNC) connector for connection to other displays.
- ii. Audio 2: Are Audio input (RCA) connectors for connection to the Audio output of the associated Video source. CVBS In and S-Video share this Audio input pair.
- iii. CVBS In: Is a Composite Video input (RCA) connector for connection to a Composite Video source.
- iv. S-Video: Is a Y/C S-Video input (4-Pin DIN) connector for connection to a S-Video source.
- v. YCbCr/PbPr: Are Component Video input (RCA) connectors for connection to the Component outputs of the Video source.
- vi. Audio 1: Are Audio input (RCA) connectors for connection to the Audio output of the associated Video source. The Component Video and PC Input sources share this Audio input pair.

- **Tuner Module**



- The VHF/UHF Input can be connected to receive a TV/CATV signal from an antenna or CATV 75Ω coaxial cable.
- The TV Audio Output can be connected to an Audio Amplifier or other TV Audio Line Input.
- The Video Output can be connected to a Monitor or other TV with a Composite Video Input.

### 6.4 Remote Control

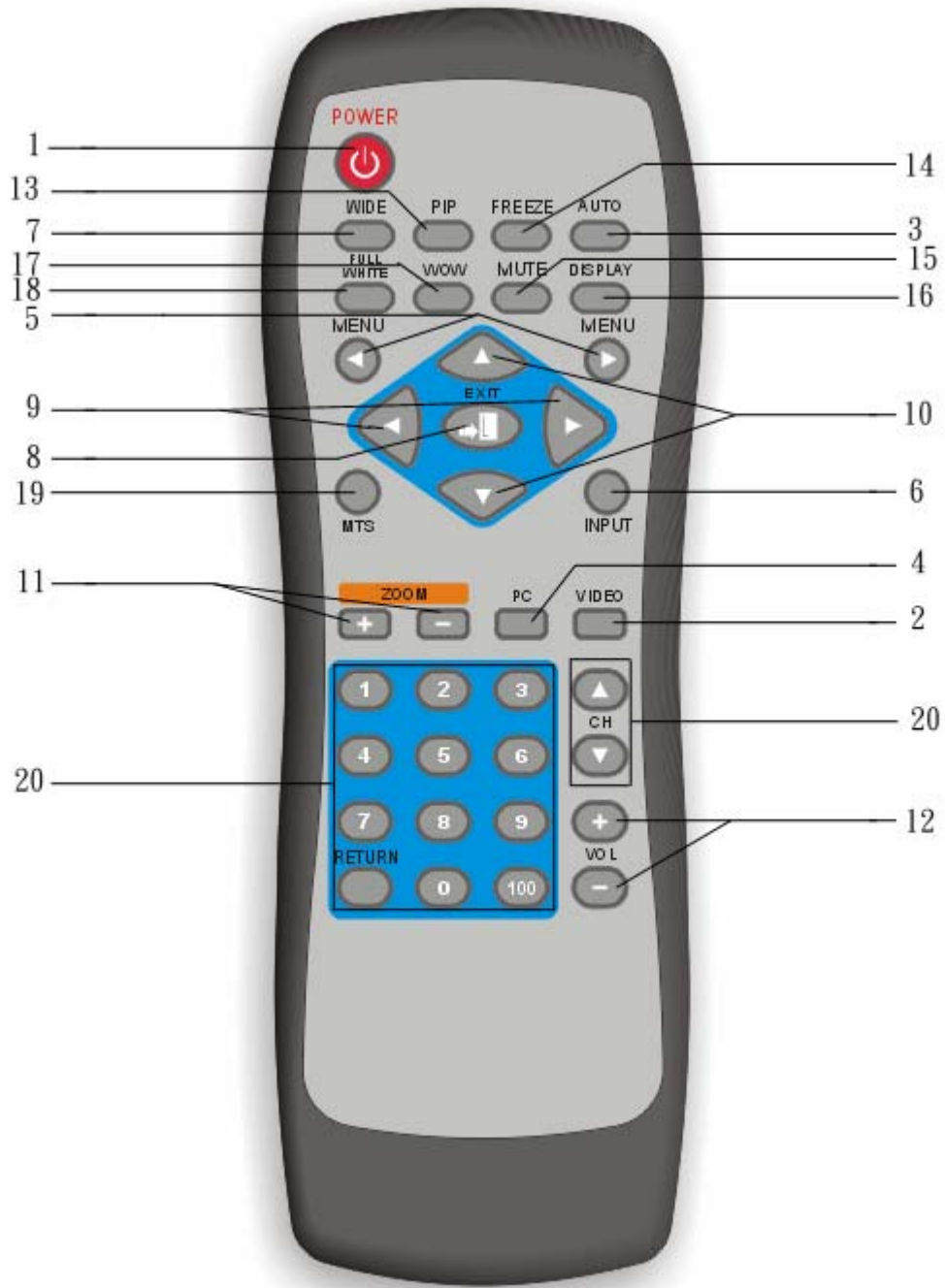

6.4.1 Key Functions

(1) **POWER**

Press this key to turn the Plasma Display On from Standby mode. Press it again to return to the Standby mode.

(2) **VIDEO**

Press this key to switch the Video input. The signal sources are selected in the following sequence: AV1⇒S-Video⇒YCbCr/PbPr.

(3) **AUTO**

Vertical and Horizontal position are adjusted automatically when pressing this key in the PC mode.

B: The appropriate video format is chosen automatically when pressing this key in the Video mode.

(4) **PC**

Press this key to select the PC input. The signal sources are selected in the following sequence, RGB 1 (PC Module D-Sub Terminal) ⇒RGB 2 (PC Module DVI Terminal).

(5) **MENU◀ and MENU▶**

Select OSD menu pages in the following sequence,

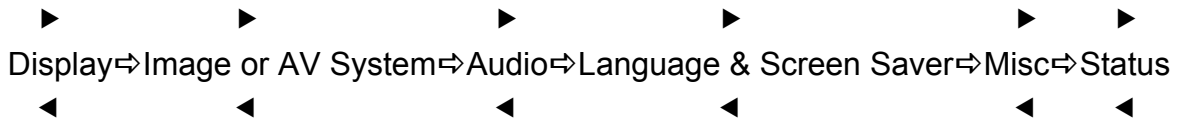

(6) **INPUT**

Press this key to select the signal sources directly.

RGB1⇒RGB2⇒AV1⇒S-Video⇒YCbCr/PbPr⇒TV/CATV(sequential display).

(7) **WIDE**

Press this key to switch to wide screen. Pressing this key again will restore the original size of the screen.

(8) **EXIT**

Press this key to exit the OSD Menu.

(9) **◀ and ▶**

Use these keys to increase or decrease the value of the selected function.

(10) **▲ and ▼**

Use these keys to scroll in the OSD Menu, or to select a function in the Quick Menu.

(11) **ZOOM+ and ZOOM –**

Use these keys to zoom the image in or out.

(12) **VOL + and VOL –**

Press the volume keys to increase or decrease the sound level.

(13) **PIP**

Use this key to activate and adjust the size of the picture-in-picture in the following sequence,

Picture-in-Picture On-Small⇒Medium⇒Large⇒Picture-in-Picture Off (sequential display).

(14) **FREEZE**

Press this key to "Freeze-Frame" the current screen. You may press this key again to continue playing or play will resume automatically after one minute.

(15) **MUTE**

Press this key to mute the sound. Press it again to reactivate the sound. The sound is also reactivated if the power is turned off then on, or if the volume level is changed.

(16) **DISPLAY**

Turns the Image and system information display On or Off.

(17) **WOW**

Press this key to turn the SRS Surround Sound feature On or Off.

(18) **FULL WHITE**

Displays a full white screen. This can be used to reduce image sticking after displaying a static picture for an extended period. (Refer to Page 7)

(19) **MTS**

Press this key to select Stereo, SAP or Mono audio. This function is available in the TV mode.

(20) **Number Keys**

TV direct channel selection.

**CH ▲ and CH ▼:** Use these buttons to step up or down through the available TV channels.

**RETURN:** Jumps to the last channel viewed.

Note: The Remote Control layout is for reference only.

## 6.4.2 Insertion of Batteries in the Remote Control

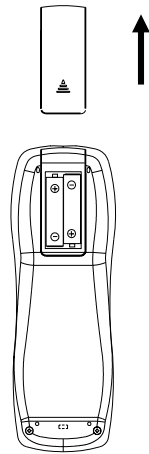

- (1) As shown in the figure above, turn the Remote Control upside down, press and slide off the battery cover.
- (2) Insert two AA batteries in the remote control as shown in the figure above. (Polarity + or - must match the markings in the compartment).
- (3) Replace the cover and slide in reverse until the lock snaps.

### 6.4.3 Remote Control Range

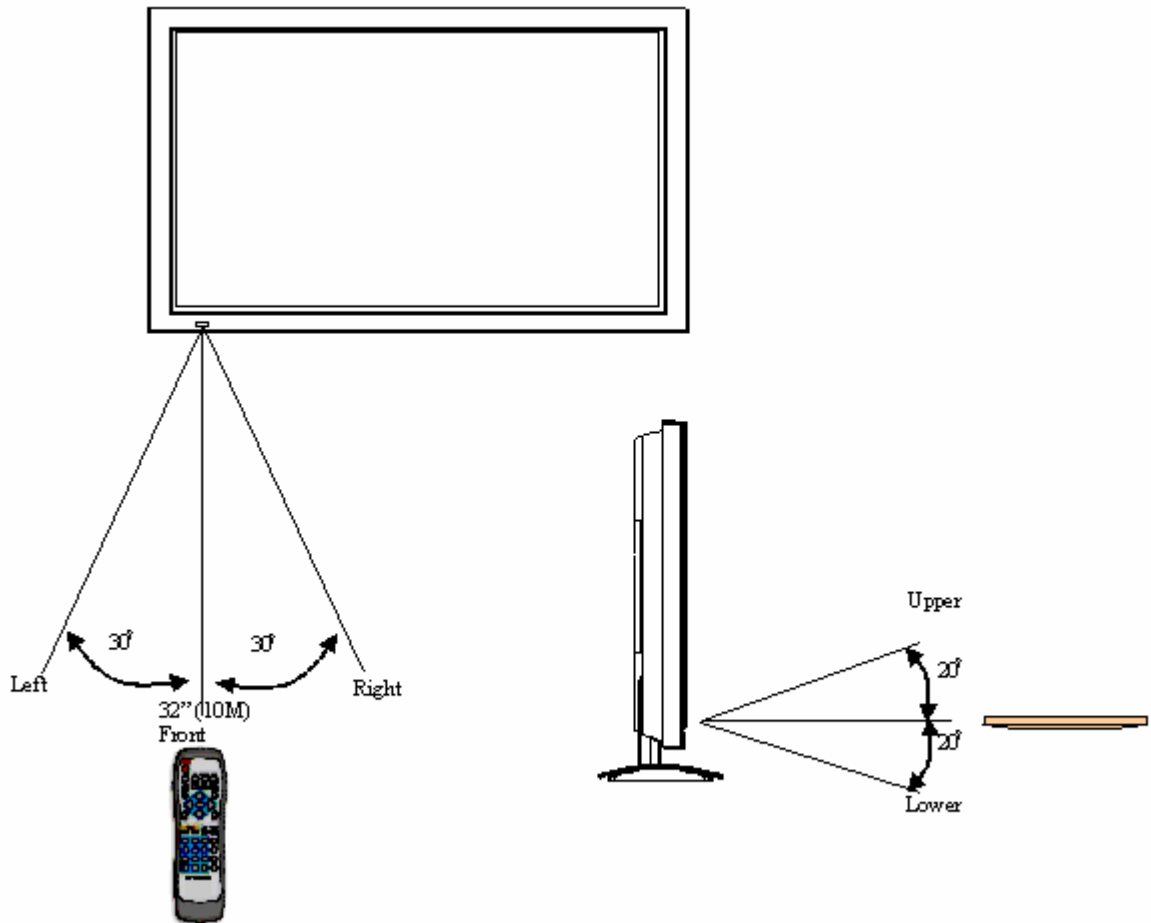

- Point the Remote Control at the receiver window (the window through which the power LED is illuminating) to transmit the commands.
- Do not place any obstacles between the Remote Control and the receiver window.
- The effective range of the Remote Control is approximately 32 feet (10 meters) from the front of the receiver window, 30° to the left and right, 20° up and down.

### 6.4.4 Using the Remote Control

- Do not subject the Remote Control to undue physical stress, such as striking or dropping it. It should be kept dry and away from heat sources.
- Do not attempt to clean the Remote Control with a volatile solvent. Wipe it with a clean, damp cloth.
- If the display responds erratically to the Remote Control, or does not respond at all, check the batteries. If they are low or exhausted, replace them with fresh batteries.



## 7. Connection to External Equipment

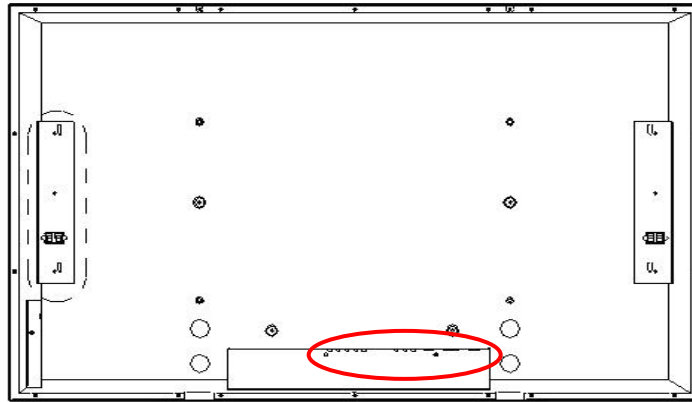

### 7.1 Connection to Antenna

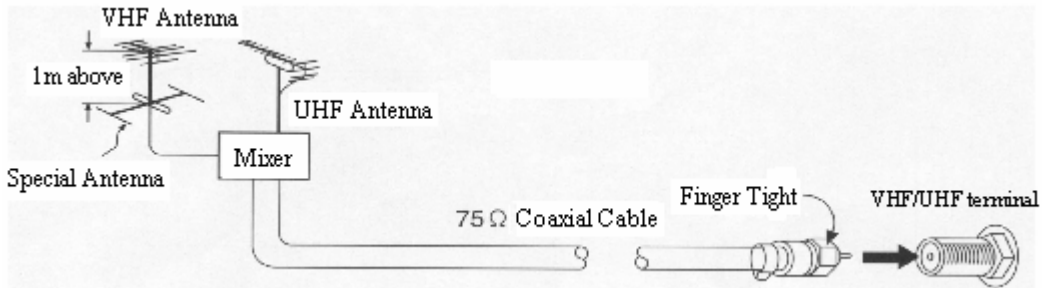

- When using a 75Ω Coaxial Cable it can be connected directly to the VHF/UHF terminal of the tuner.

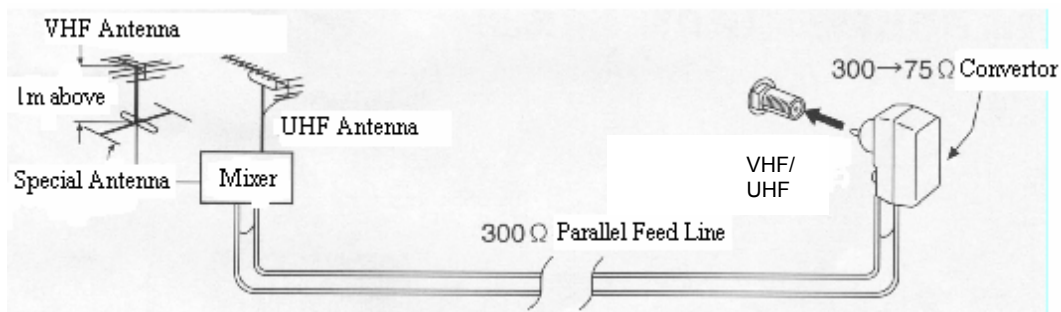

- When using a 300Ω parallel feed line it must be connected to a 300Ω to 75Ω converter and then connected to the VHF/UHF terminal of the tuner.

## 7.2 PC Module

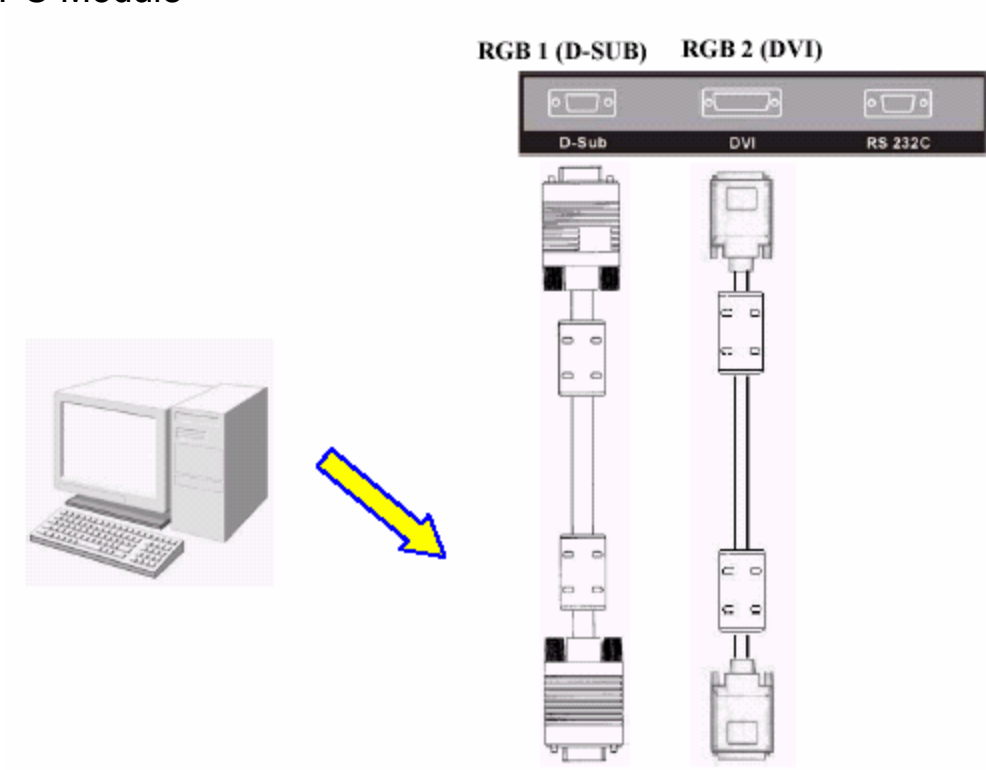

- For operating the Display as a PC monitor.  
 15-Pin D-Sub connects to analog RGB output interface (Input option RGB1).  
 DVI connects to digital RGB output interface (Input option RGB2).

Note 1: The DVI connector of the Display is DVI-D, which does not support analog inputs.

Note 2: The RS-232 connector of the Display provides a transmission interface for professional technicians to update firmware and does not provide additional communication functions.

### 7.3 PC Module + Video Module

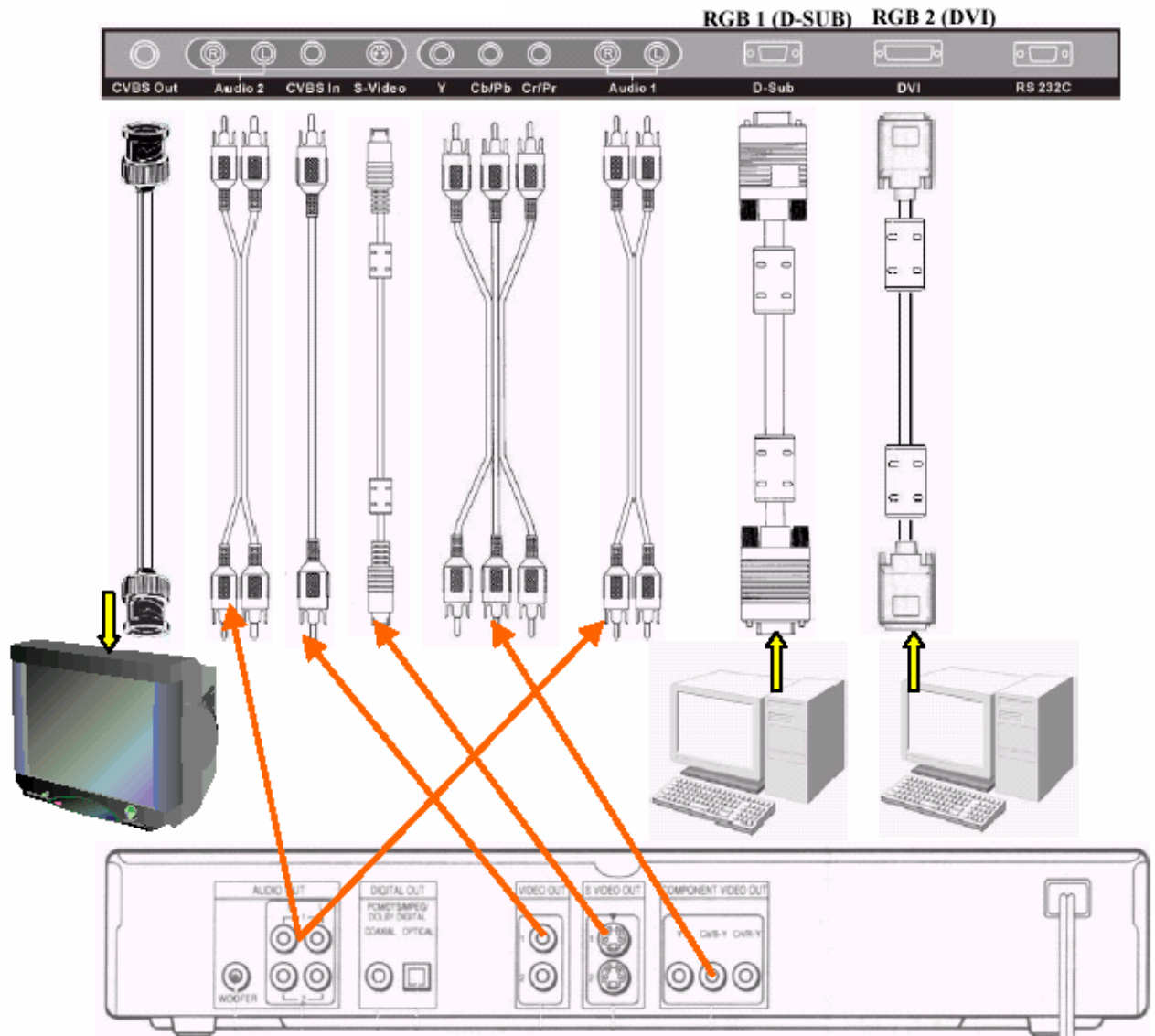

- The functions of D-Sub, DVI and RS-232 terminals are the same as for the PC module.
- The Component connectors (Y/PbCb/PrCr) accept the component output of a video device (such as a DVD or HDTV Receiver). The audio input is via Audio 1 (INPUT Option YCbCr/PbPr).
- The S-Video connector accepts the Y/C S-Video output of a video device (such as an S-VHS or DVD). The audio input is via Audio 2 (INPUT Option S-Video).
- The CVBS In connector accepts the CVBS (Video) output of a video device (such as a VHS, S-VHS or DVD). The audio input is via Audio 2 (INPUT Option AV1).
- The S-Video and CVBS inputs share the Audio2 input.

- The CVBS Out (BNC) connector can be used to connect the Display to another TV or display, transmitting the signal input via CVBS to the other display.

## 7.4 Connection to External Speakers

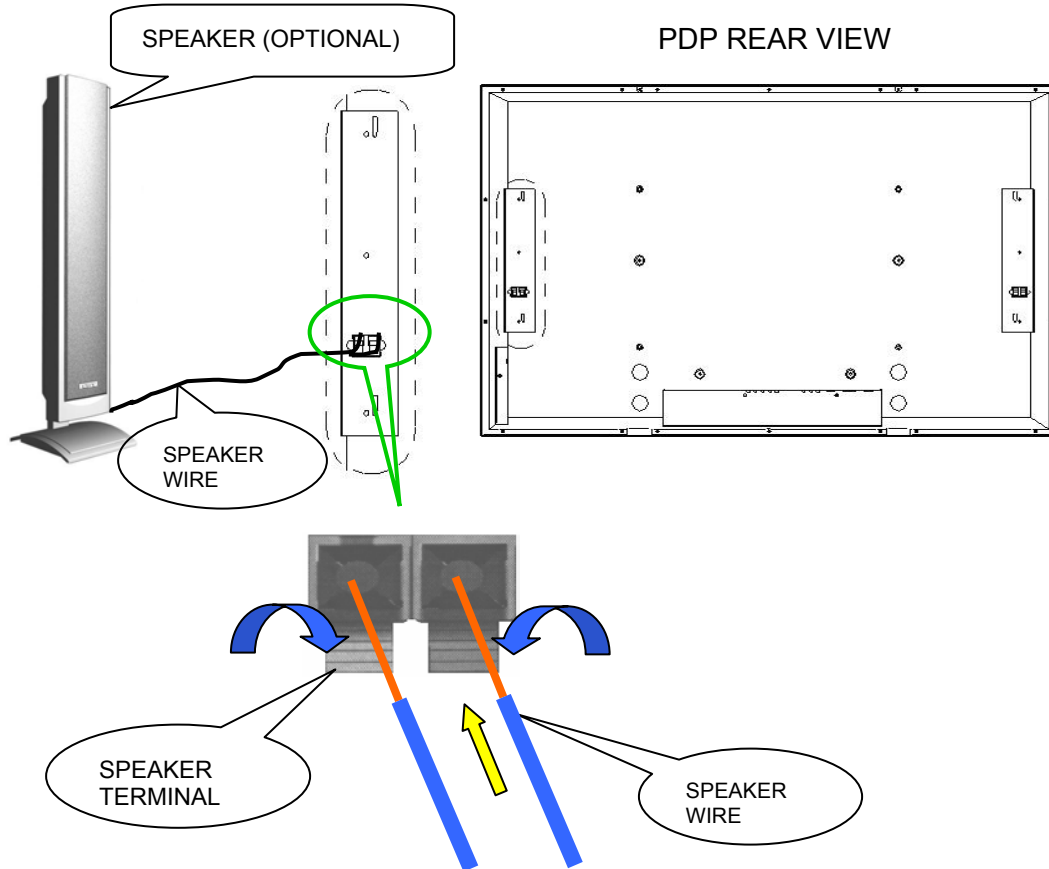

- Press the spring-loaded terminals and insert the speaker wires, making sure that the copper is making good contact with the metal terminal and the colors of the wire match those on the terminal (red to red and black to black). Release the terminals to clamp the speaker wires in place.

Note 1: When connecting the external speakers, remember to set the speaker output to External mode on the Audio page of the OSD Menu. (Refer to 8.7.2.)

Note 2: Please use the wires enclosed with the external speakers, to ensure electromagnetic interference is minimized.

## 8. Basic Operation

### 8.1 Power On / Off



- Press the **POWER** key to turn on the Display. The power indicator will change from red to green.
- Press the **POWER** key again to return the Display to Standby mode. The power indicator will change from green to red.

Note: The power indicator will flash for a few seconds before changing color.

### 8.2 Input Mode Selection



- Press the **INPUT** key. A menu of input signal sources will appear on-screen. Use the ▲/▼ keys to select the signal source desired and press the ► key to confirm the selection.
- You may also press the **INPUT** key repeatedly until the signal source you want is highlighted. The signal sources are displayed in the following sequence,

RGB1⇒RGB2⇒AV1⇒S-Video⇒YCbCr/PbPr⇒TV/CATV

RGB1 = Analog D-Sub input on the PC Module.

RGB2 = Digital DVI-D input on the PC Module.

### 8.2.1 Selection of TV Mode

Select the TV Input by one of three methods:



- Press the **INPUT** key. A menu of input signal sources will appear on-screen as shown in the picture opposite. Use the ▲/▼ keys to select the signal source desired and press the ► key to confirm the selection.

RGB 1 (D-sub)
RGB 2 (DVI)
AV 1
S-Video
Y Cb/Pb Cr/Pr
TV / CATV
TV / CATV

- Press the **VIDEO** key repeatedly to select a signal source from the Video module. The signal sources are displayed in the following sequence,  
AV1⇒S-Video⇒YCbCr/PbPr⇒TV/CATV
- The Display will search for the TV/CATV signal automatically if there is no other input.

### 8.2.2 Selection of Video Input Mode



- Press the **VIDEO** key repeatedly to select a signal source from the Video module. The signal sources are displayed in the following sequence,

AV1⇒S-Video⇒YCbCr/PbPr⇒TV/CATV

### 8.2.3 Selection of PC Input Mode



- Press the **PC** key repeatedly to select a signal source from the PC module. The signal sources are displayed in the following sequence,

RGB1⇒RGB2

RGB1 = Analog D-Sub input on PC Module.

RGB2 = Digital DVI-D input on PC Module.





## 8.4 Sound Adjustment



- Press and hold **VOL +** to increase the sound volume level and press and hold **VOL -** to decrease the sound volume level.
- Press the **MUTE** button to mute the internal or external speakers. Press the **MUTE** button again to restore the sound at the previous volume levels.
- Other audio adjustments (such as treble, bass and balance) can be adjusted on the OSD Menu or Quick Menu.

## 8.5 Zoom Functions



- The Zoom buttons include **WIDE**, **ZOOM+** and **ZOOM-**.
- By pressing the **WIDE** button, you can zoom in on the image to fill the screen. You can then restore the image to its original size by pressing the **WIDE** button again.

Note: 1. With PC input, you can switch between the full screen size and the original signal format.

2. When a video signal is selected, you can switch among six screen sizes, including Full, Fill Aspect Ratio, 4:3 to 16:9, LB to 16:9, LB Subtitles to 16:9 and Anamorphic. (LB=Letter Box.)

- By pressing and holding the **ZOOM+** button, you can zoom the image gradually. By pressing and holding the **ZOOM-** button, you can zoom out of the image gradually. Pressing the **EXIT** button will also restore the image to its original size.

Note: 1. You can only zoom the image out to its original size by pressing the **ZOOM-** button. The image cannot be made any smaller with this function.

2. When the image is zoomed in by using the **ZOOM+** button, you can use **▲**, **▼**, **◀** and **▶** keys to scroll the image within the viewing area.



## 8.7 OSD Functions

### 8.7.1 General Description of the OSD Function Pages

- PC

Display (DVI input)	Display (Analog input)	Image	Audio	Language & Screen Saver	Miscellaneous	Status
	Brightness	H. Position	Volume	Language	OSD Position	Resolution
	Contrast	V. Position	Treble	Image Reverse	OSD Timeout	V. Frequency
Red <sup>1</sup>		Phase Adj.	Bass	Image Move	OSD Rotation	H. Frequency
Green <sup>1</sup>		Sync Adj.	Balance	Move Time	Color Temp.	PP Input
Blue <sup>1</sup>		Aspect Ratio	Mute	WOW	Reset to default	PIP System
Reset	Reset	DPMS	Speaker	Advanced Mode	PIP Settings	
				Gamma		
				Color Space		
				PC User		

- PIP Setting

Display	Miscellaneous
Brightness	PIP Size
Contrast	PIP Source
Saturation	PIP Position
Reset	

- Video + Tuner

Display	AV System	Audio	Language & Screen Saver	Miscellaneous	Status
Brightness	TV Function	Volume	Language	OSD Position	Input Source
Contrast	Aspect Ratio	Treble	Image Reverse	OSD Timeout	System
Saturation	Video Format	Bass	Image Move	OSD Rotation	
Hue <sup>2</sup>		Balance	Move Time	Color Temp.	
Sharpness		Mute	WOW	Reset to Default	
Rest		Speaker	Advanced Mode	User Color Temp <sup>3</sup>	
			Gamma		
			Color Space		

- User Color Temp<sup>3</sup>

Display
Red
Green
Blue

Note: The adjustable items vary depending on the input source.

<sup>1</sup> When USER is selected from Color Temp. preset.

<sup>2</sup> Hue has no effect when using YCbCr/PbPr.

<sup>3</sup> Press the **EXIT** key to return to the Main Menu.

8.7.2 OSD Menus and Functions

8.7.2.1 Display Menu



- Only the Brightness, Contrast and Reset functions can be adjusted when using an analog PC input signal. The brightness of the Red, Green and Blue can be adjusted when **User Color Temp** is selected from the Miscellaneous Menu.
- The Brightness, Contrast, Saturation, Hue, Sharpness and Reset can all be adjusted when using Video input signals.
- When YCbCr/PbPr video is the primary source, Hue and Sharpness are not available. When YCbCr/PbPr is selected as a PIP source, Hue has no effect on the PIP image.

8.7.2.2 Image and AV System Menu

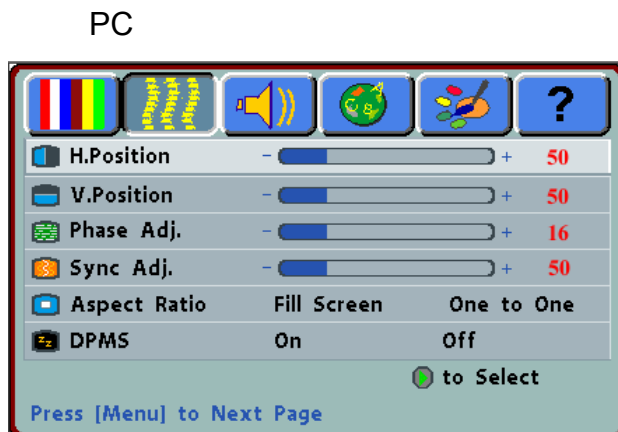

- With PC input signals, the Horizontal Position, Vertical Position, Phase, Sync and Aspect Ratio can be adjusted, and DPMS can be enabled or disabled.
- With a video signal you can adjust the TV Function, the Aspect Ratio and select the Video (signal) Format you want. If you do not know which Video format to select, choose Auto and the display will select the correct signal automatically.
- The Display provides six aspect ratio formats in the Video input modes, and two in the PC input modes. You can select the most suitable format for the selected signal source. Press the on the remote control or the Display to select Full, Fill Aspect Ratio, 4:3 to 16:9, LB to 16:9, LB Subtitles to 16:9 or Anamorphic aspect ratios.

8.7.2.3 Channel Scan and Memory

- Highlight the TV Function and then press and ► key to select this option.



- Press the ▲ or ▼ key to highlight **Source** and then repeatedly press the ► key to cycle through **Antenna**, **CATV (STD, IRC, or HRC)** and select the one that matches the broadcasting system you are receiving.



- Now press the ▲ key to highlight **Channel Program** and then press the ► key to commence **Channel Scan** to automatically find and memorize the channels available. During this process all other functions will be disabled and the OSD icon shown in the picture opposite will be displayed.



- Once this process has been completed the channels stored in memory may be selected sequentially by pressing the CH▲ and CH▼ keys or directly by pressing the number keys on the Remote Control.

8.7.2.4 Audio Menu



- The adjustable items on the Audio Menu are Volume, Treble, Bass, Balance and Mute. These items are the same for both PC and Video signals. Internal or External speakers can also be selected from this menu.

8.7.2.5 Language and Screen Saver Menu

PC

Options in Advanced Mode

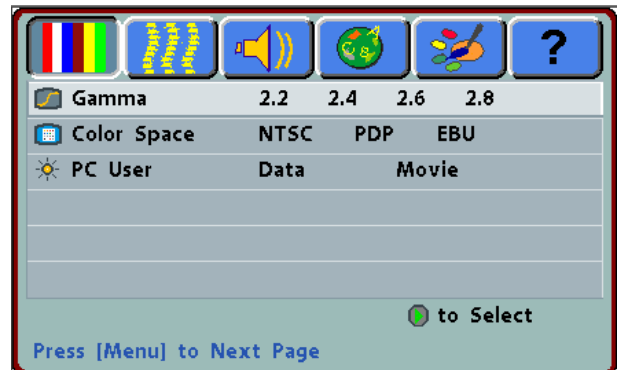

VIDEO

Options in Advanced Mode

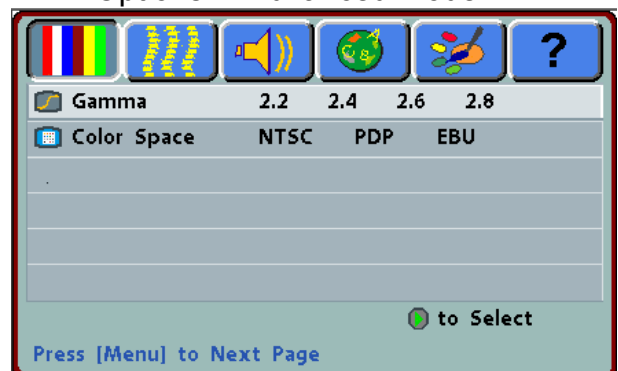

- You can select the languages provided by OSD from the **Language** option.
- When a static image is being displayed on the screen for a long period of time, use the **Image Reverse** or **Image Move** features to prevent screen burn and protect your screen. The **Move Time** function allows you to adjust the time between the stages of the **Image Move** feature.

8.7.2.6 Miscellaneous Menu

PC

VIDEO



- The **OSD Position** and **OSD Timeout** options allow you to select the location of the OSD on the screen and the length of time that OSD will remain on screen. The **OSD Rotation** option allows you to rotate the OSD 90° CCW.
- The **PIP Settings option** can be accessed when the input signal is from a PC (Note: The Video, S-Video or Component input must have an input signal in order to use this option).
- Your preferred screen color temperature can be selected from the Color Temp. option. You can choose from Warm, Standard, Cool or User. By selecting User, you can then adjust the brightness of Red, Green and Blue individually in order to adjust the white point to suit your preference, by making the adjustments in the Display Menu. Note: Only User Color Temperature is adjustable. The Warm, Standard and Cool settings are preset at the factory.

8.7.2.6.1 PIP Setting (for PC Mode only)



- To access these options, select **PIP Settings** from the Miscellaneous menu.
- The **Display** menu is the same as the **Display** menu in Video mode. The **Image** menu is used to enable and disable the PIP, set the PIP size and select the PIP source and position.
- Press the **Exit** key to exit the PIP Settings sub-menu and return to the Main Menus.

8.7.2.6.2 PIP Setting with Tuner (for PC Mode only)

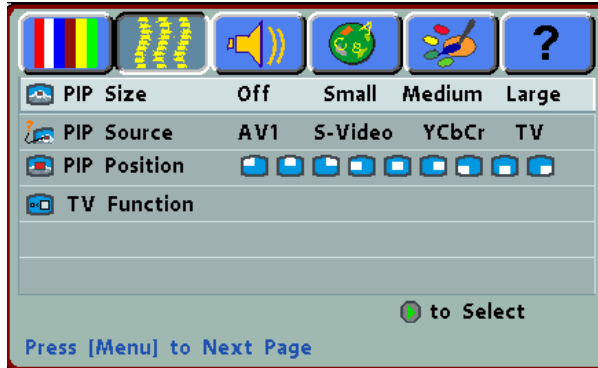

- The **TV Function** selection has the same effect as this selection in the Image and AV System Menu in section 8.7.2.3

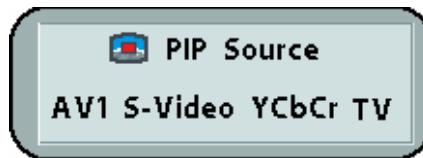

- Press the ▲/▼ keys to enter the Quick Menu to select TV for the PIP Source. (when OSD is not being displayed)



8.7.2.6.3 User Color Temp. Menu (for AV Mode only)

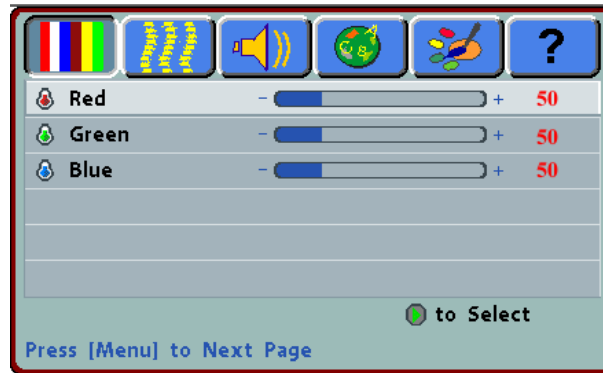

- To access these options, select the **User Color Temp.** option on the Miscellaneous menu. You can adjust the brightness of Red, Green and Blue to suit your personal preference for white point. **Note:** Only User Color Temperature is adjustable. The Warm, Standard and Cool settings are preset at the factory.

8.7.2.7 Status Menu

PC

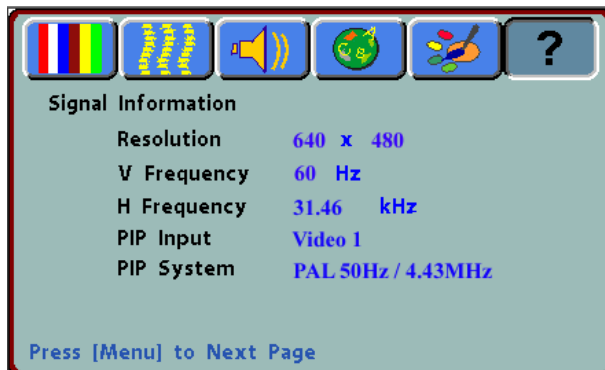

VIDEO



- This menu displays the Resolution, Vertical Frequency and Horizontal Frequency when a PC input is operating. If PIP is in use, the sub-picture source and system are also displayed.
- The Input source and System are displayed when using video signals.

8.7.2.8 CC and Parental Control Menus

- Select the **TV Function** on the Image and AV System Menu. Press the ► key to select the TV Function Menu. Pressing the **MENU►** key will recall the CC and Parental Control Menu. (See section 8.7.2.9)



- Select the **Channel Program** function and press the ► key to perform Channel Scan and Addressing.
- Select the **Source** function and press the ◀/▶ keys to select the TV/CATV system. You must select the broadcasting system before selecting the **Channel Program** function
- The **MTS Select** function allows you to choose from Stereo, Sap and Mono using the ◀/▶ keys. (This same process can be achieved by using the MTS key on the Remote Control.)
- Select the **Channel** function to Add or Erase Tuner Channels on the list used by the Channel Up / Down keys.
- The **Sleep Time** can set for automatic power off of the Display. The number "0" means the sleep timer is disabled.



8.7.2.9 CC and Parental Control Menu

- Select the **TV Function** on Image and AV System Menu. Press the ► key to display the CC and Parental Control Menu.



- Highlight the **Close Caption** function and use the ◀/▶ keys to select the options CC1, CC2, T1, T2, T3 and T4.
- The options are described below.

Option	Description	Option	Description
CC1	Show the first Subtitle	T1	Show the first Subtitle Message
CC2	Show the second Subtitle	T2	Show the second Subtitle Message
		T3	Show the third Subtitle Message
		T4	Show the fourth Subtitle Message
OFF	Turn off the Subtitle feature		

- Highlight the **Parent Control** function and press the ► key to select the function.
- A message will show on the screen and will wait for you to enter the password. The password has been set to “1234” at the factory so if you are using this feature for the first time you must use this number.
- If the password is correctly entered and accepted the Parental Control / V-Chip Menu will be displayed. If it is not accepted, check that the password was entered correctly.



8.7.2.9.1 MPAA Rating

- Highlight the **MPAA Rating** item and press the ► key to select the function.



- Press the ▲/▼ keys to highlight the rating items you want to set and then press the ◀ or ▶ key to **Show** or **Block** the selection.
- When an item is Blocked, all of the higher ratings will also be blocked. For example, if **PG-13** is set to **Block**, then ratings **R**, **NC-17** and **X** will be set to **Block** automatically.
- The MPAA Ratings are described below.



Rating	Description
G	General audience (appropriate for all ages).
PG	Parental Guidance suggested (some material may not be suitable for children).
PG-13	Parents strongly cautioned (some material may be inappropriate for children under 13 years of age).
R	Restricted (persons under 17 years of age requires accompanying parent or adult guardian).
NC-17	Not intended for any person 17 years of age or younger.
X	X-rated (for adults only).

8.7.2.9.2 US TV Rating

- Highlight the **US TV Rating** item and press the ► key to select the function.
- Press the ▲/▼ keys to highlight the rating items you want to set and then press the ◀ or ▶ key to **Show** or **Block** the selection.
- When an item is Blocked, all of the higher ratings will also be blocked. For example, if **TV-G** is set to **Block**, then ratings **TV-PG**, **TV-14** and **TV-MA** will be set to **Block** automatically.
- The US TV Ratings are described below.



Rating	FV (Fantasy)	V (Violence)	S (Sexual situations)	L (Adult language)	D (Sexually suggestive dialog)
TV-Y (All children)					
TV-Y7 (Children 7 years old or younger)	X				
TV-G (General audience)					
TV-PG (Parental guidance suggested)		X	X	X	X
TV-14 (Parents strongly cautioned)		X	X	X	X
TV-MA (Mature audience only)		X	X	X	

Note: “X” indicates that the content rating can be set.

8.7.2.9.3 Canadian English Rating

- Highlight the **Canadian English Rating** item and press the ► key to select the function.
- Press the ▲/▼ keys to highlight the rating items you want to set and then press the ◀ or ▶ key to **Show** or **Block** the selection.



- The Canadian English Ratings are described below.

Rating	Description
E	Exempt
C	Children
C8+	Children 8 years old and older
G	General programming, suitable for all audiences
PG	Parental guidance
14+	Viewers 14 years old and older
18+	Adult programming

8.7.2.9.4 French Canadian Rating

- Highlight the **Canadian France Rating** item and press the ► key to select the function.
- Press the ▲/▼ keys to highlight the rating items you want to set and then press the ◀ or ▶ key to **Show** or **Block** the selection.
- The French Canadian Ratings are described below.



Rating	Description
E	Exempt
C	Children
8 ans +	Children 8 years old and older
13 ans +	Viewers 13 years old and older
16 ans +	Viewers 16 years old and older
18 ans +	Adult programming

## 9 Optional Accessories

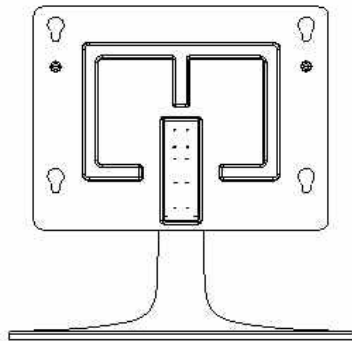
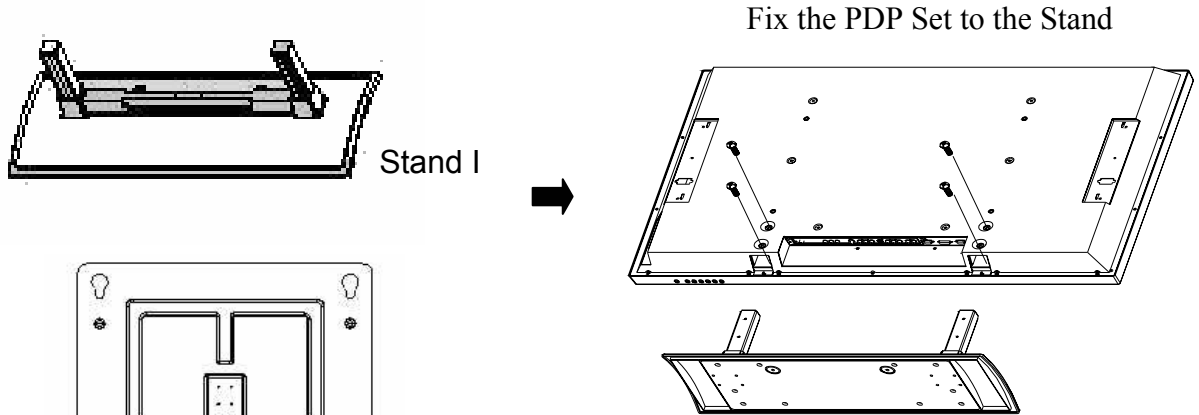

Stand II (refer to the stand assembly instruction)

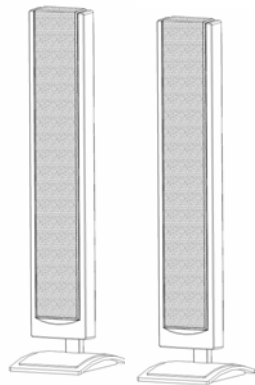

Speakers I

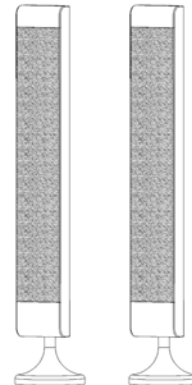

Speakers II

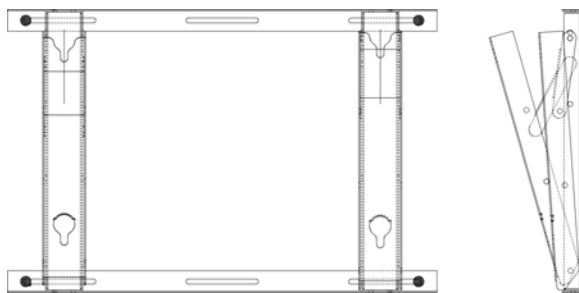

Wall Mount

Tilt Angle adjustable 0 - 20°

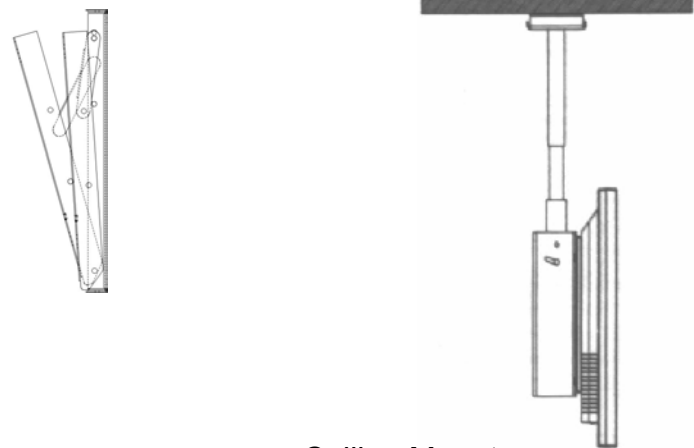

Ceiling Mount

## 10 Technical Specification

Screen Size	46-in, Wide Screen
Screen Area	39.7-in (1007mm) Wide x 22.3-in (567.4mm) High
Aspect Ratio	16:9
Overall Size	44.8-in (1138mm) Wide x 27.2-in (691mm) High x 3.8-in (98mm) Deep, without Stand
Weight	82lbs (37kg), without Stand
Resolution	852 (H) x 480 (V) Pixels (Each pixel has R/G/B 3-color cells.)
Pixel (Dot) Pitch	1.182mm (H) x 1.182mm (V)
Color	16.7 million colors
Gray Scale	256 steps (8-bit addressing for each color Red, Green and Blue)
Brightness (Peak Value)	700 cd/m <sup>2</sup> Typical (Panel Only)
Contrast (Dark Room)	800:1 Typical
Viewing Angle	More than 160° horizontally and vertically
Sound	SRS Sound
Power Input	100 ~ 120Vac/220 ~ 240Vac, 50 ~ 60Hz
Power Consumption	330W (Average)
Inputs	<p>PC Module</p> <ul style="list-style-type: none"> <li>Analog RGB Input, 15-Pin D-Sub</li> <li>Digital TMDS Input, DVI Connector</li> <li>RS-232 Communication, 9-Pin D-Sub</li> </ul> <p>Video Module</p> <ul style="list-style-type: none"> <li>S-Video Input, mini 4-Pin DIN</li> <li>CVBS (Composite) Input, RCA Phono</li> <li>YCbCr/PbPr (Component) Input, RCA Phono</li> <li>L+R Audio (x2) Inputs, RCA Phono (x4)</li> <li>CVBS (Composite) Output, BNC</li> </ul> <p>Enhanced PC Module</p> <ul style="list-style-type: none"> <li>Analog RGB Input, 15-Pin D-Sub</li> <li>Analog RGB Input, BNC (x5)</li> <li>Analog RGB Output, 15-Pin D-Sub</li> <li>PC Audio Input, 3.5mm Stereo Jack</li> </ul>
Agency Certifications	UL, CSA, FCC Class B
Standard Accessories	Remote Control, AA Batteries (x2), Power Cord (NA), 15-Pin D-Sub Cable, S-Video Cable, AV Cable, User Manual



## 11 Factory Preset Timings

There are 17 different timing formats that are preset at the factory for the RGB Mode.

#	Resolution	Horizontal Frequency (kHz)	Vertical Frequency (Hz)	Dot Clock Frequency (MHz)	Remarks
1	720x400	31.47	70.08	25.17	DOS
2	640x400	37.90	85.00	31.50	VESA
3	640x480	31.50	60.00	25.18	DOS
4	640x480	35.00	67.00	30.24	Mac (SOG)
5	640x480	37.50	75.00	31.50	VESA
6	640x480	37.86	72.81	31.50	VESA
7	640x480	43.30	85.00	36.00	VESA
8	800x600	35.16	56.25	36.00	VESA
9	800x600	37.90	60.32	40.00	VESA
10	800x600	46.90	75.00	49.50	VESA
11	800x600	48.08	72.19	50.00	VESA
12	800x600	53.70	85.00	56.25	VESA
13	832x24	49.00	74.00	57.27	Mac (H+V)
14	1024x78	48.40	60.00	65.00	VESA
15	1024x78	56.50	70.00	75.00	VESA
16	1024x78	60.00	75.00	78.75	VESA
17	1024x78	68.70	85.00	94.50	VESA

- When the signal received by the Display exceeds the allowed range, a warning message "Signal Out Of Range" will appear on the screen.
- You can confirm the input signal format by selecting the Status page from the OSD Menu.

## 12 Cleaning and Simple Troubleshooting

### 12.1 Important

1. Make sure that the power cable is removed from the socket before cleaning the Display.
2. Do not use volatile solvent (such as toluene, rosin and alcohol) to clean the Display. Such chemicals may damage the housing, screen glass and remote control, and cause the paint to peel.

### 12.2 Cleaning the Housing and the Remote Control

1. Use a soft cotton cloth for cleaning.
2. If the Housing or Remote Control are seriously contaminated, use a soft cloth moistened with diluted neutral cleaner to clean the Display. Wring water out of the cloth before cleaning to prevent water from penetrating into the housing. Wipe the Display with a dry cloth after cleaning.

### 12.3 Cleaning the Screen

1. Use a soft cotton cloth to gently clean the screen.
2. The screen glass is very fragile. Do not scrape it with any sharp object. Do not press or tap the screen to avoid cracking. When the screen is seriously contaminated, use a soft cloth moistened with diluted neutral cleaner to clean the Display. Wring water out of the cloth before cleaning to prevent water from penetrating into the housing. Wipe the Display with a dry cloth after cleaning.

## 12.4 Simple Troubleshooting

If the display fails or the performance changes dramatically, check the Display in accordance with the following instructions. Remember to check the peripherals to pinpoint the source of the failure. If the Display still fails to perform as expected, contact the dealer for assistance.

Problem	Solution
Power cannot be turned on. (Power indicator does not light)	Check that both ends of the power cable are plugged into the socket appropriately.
"No Input Signal" message appears on the screen.	<ul style="list-style-type: none"> <li>- Check that the signal cable is connected properly.</li> <li>- Check that the power of the relevant peripherals are turned on.</li> <li>- Check that the Input option that has been selected matches with the input signal.</li> </ul>
The remote control does not function properly.	<ul style="list-style-type: none"> <li>- Check that the polarity of the batteries are correct.</li> <li>- Check that the batteries are not drained. (Use new batteries.)</li> <li>- Check that the Remote Control is within the operating range.</li> <li>- Check that the Remote Control is pointed at the Remote Control Window on the Display.</li> <li>- Check that there are no obstacles between the Remote Control and the Remote Control Window.</li> <li>- For more information about the Remote Control, refer to Chapter 8.</li> </ul>
Flashing spots or stripes appear on the screen.	Check for possible interference sources such as a Car, HV cable, Neon lamp, etc.
Image color or quality deteriorates.	<ul style="list-style-type: none"> <li>- Check that all the video settings are adjusted appropriately, such as Brightness, Contrast, Color, etc.</li> <li>- For more information about video settings, refer to OSD Functions in Chapter 8.</li> </ul>
Screen position and size are incorrect.	Check that the screen position and size is adjusted appropriately.
Image or color is incorrect.	<ul style="list-style-type: none"> <li>- Check that the signal cable is connected properly.</li> <li>- When connecting to a PC, change the resolution of the PC to acquire the correct image. The difference of the PC output signal may affect the display of the image.</li> </ul>
The external speaker has no sound.	<ul style="list-style-type: none"> <li>- Check that the speaker cables are connected appropriately.</li> <li>- Check that the external speakers are enabled in the OSD</li> <li>- For more information about audio settings, refer to OSD Functions in Chapter 8.</li> </ul>
The power indicator flashes	<ul style="list-style-type: none"> <li>- Check that the input signal cables are properly attached.</li> <li>- Check that the display is not in the Power Save mode.</li> </ul>
The input image and signal is not received appropriately. "Signal Out of Range" message appears on the screen.	<ul style="list-style-type: none"> <li>- Select the correct input signal.</li> <li>- For more information, refer to Factory Settings in Chapter 11.</li> </ul>

## 13. Optional Wall Mount Installation Instructions

### **Read these instructions before attempting installation**

#### **SAFETY ADVISORY**

13 The wall should be capable of supporting a weight of at least twice (2x) the weight of the Plasma TV, and the site should be studied carefully for correct Stud (Wood), Stud (Metal), Drywall and Concrete mounting procedures. For calculated weights of more than 160lbs, the wall or ceiling must be reinforced. V, Inc strongly recommends that the installation, as outlined in these installation instructions, is undertaken by qualified personnel who specialize in wall mount installation and are familiar with installation of this type of material. Failure to do so could result in serious personal injury. V, Inc is not liable for improper installation procedures that result in damage to mounts, adapters, Plasma Televisions or personal injury as a result of improper installation.

#### • **Before Commencing Installation**

Check that all of the parts listed below are in the package. If any parts are missing please contact V, Inc at 714-962-4848 or <http://www.vinc.com> so that the missing parts(s) can be sent to you.

13	ITEM	14	DESCRIPTION	15	QUANTITY
16	1	17	Plasma Brackets	18	1 Left, 1 Right
19	2	20	6x12mm Screws	21	8
22	3	23	Wall Plate	24	1
25	4	26	5/16" Lag Bolt	27	6
28	5	29	5/16" Flat Washer	30	6
31	6	32	1/4x20 Securing Knob	33	2

### Ventilation Requirements for Wall Mounting

To allow adequate ventilation for the Plasma TV use at least the minimum the space around the TV, as shown on the diagram below, when installing the TV in the desired location.

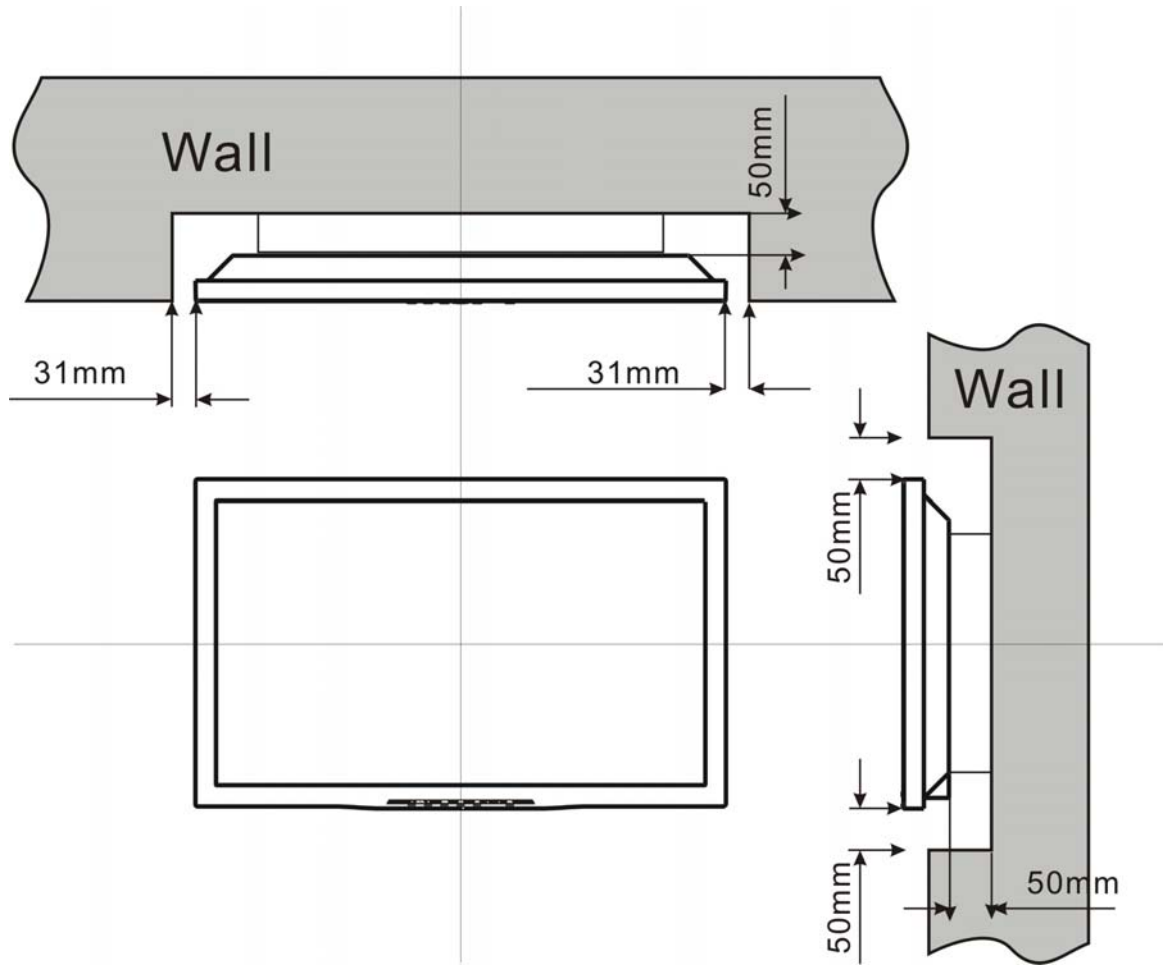

• **Attach the Plasma Brackets to the Plasma TV**

Carefully lay the display, screen down, on a soft and flat surface ensuring there are no hard objects on that surface that could damage the face of the Plasma TV. Refer to the User Manual instructions that were supplied with the display to locate the mounting points on the back of the Plasma TV. Identify the correct Plasma Bracket mounting holes for the Plasma TV from Fig 2 and secure the Left-hand and Right-hand Plasma Brackets to the Plasma TV using the 6x12mm screws making sure the moveable hooks are facing the outside edges of the display.

**Note:** Do not over tighten the bracket mounting screws as damage to the Plasma Display internal mounting threads could occur.

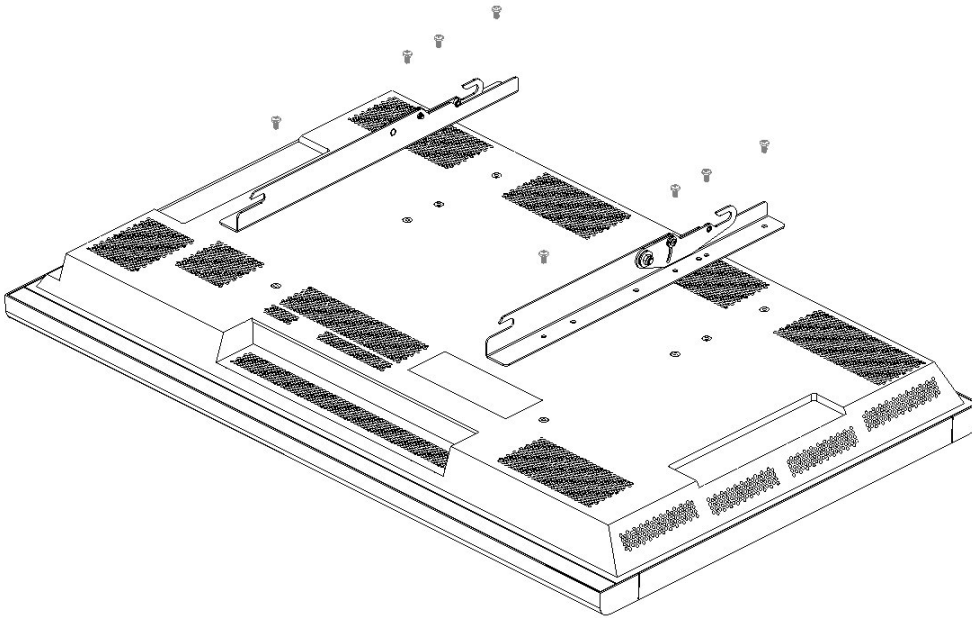

Fig 1. Mounting the Plasma Brackets on the Plasma TV.

To mount the Plasma Bracket -  
to the P2 Plasma TV use holes "A"  
to the P4 Plasma TV use holes "B"

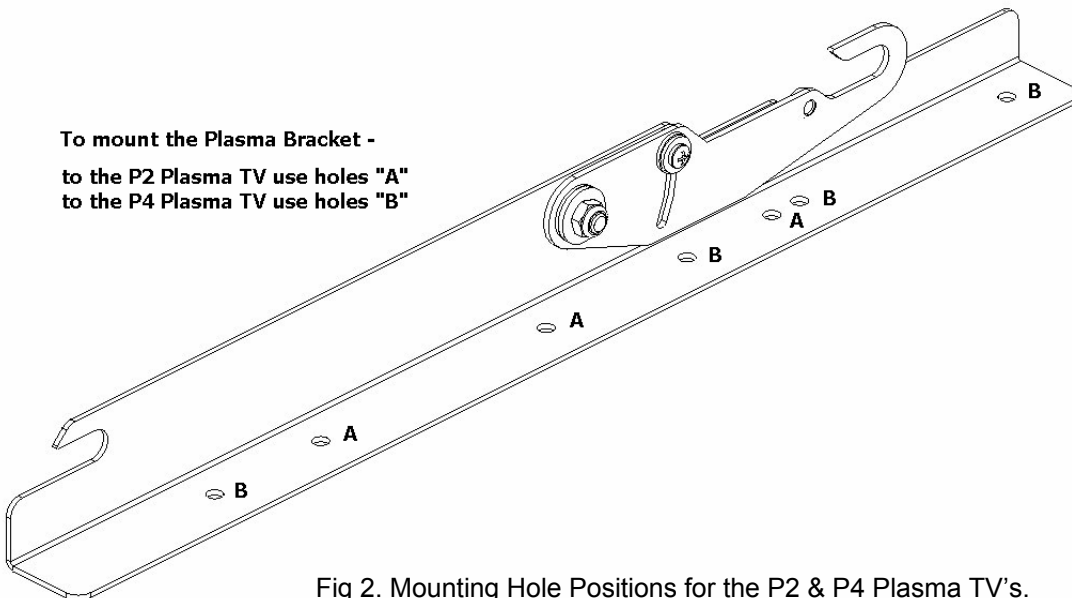

Fig 2. Mounting Hole Positions for the P2 & P4 Plasma TV's.

- **Mount the Wall Plate on the wall.**

Choose the desired wall location making sure it can support the weight of the Plasma TV as per the 'Safety Advisory' on page 2 of these instructions. Remember that the lower edge of the Plasma TV will be lower on the wall, (about 5 inches for the P4, 46 inch TV), than the bottom of the Wall Plate. Locate and mark the centers of two adjacent wood studs, usually 16 inches apart, closest to the middle of the desired location of the Plasma TV. Mark a reference line on the wall for the position of the bottom edge of the Wall Plate making sure that line is level. Place the Wall Plate bottom edge on the reference line and line-up the six mounting point slots with the centers of the wood studs already identified. Mark the locations of the six slots on the wall. Remove the Wall Plate from the wall and drill  $\frac{1}{4}$  inch pilot holes at the six points marked on the wall through the mounting slots in the Wall Plate. Level the wall plate on the wall in the correct orientation, (see Fig 3), and attach it to the wall using the  $\frac{5}{16}$ " Lag bolts and flat washers.

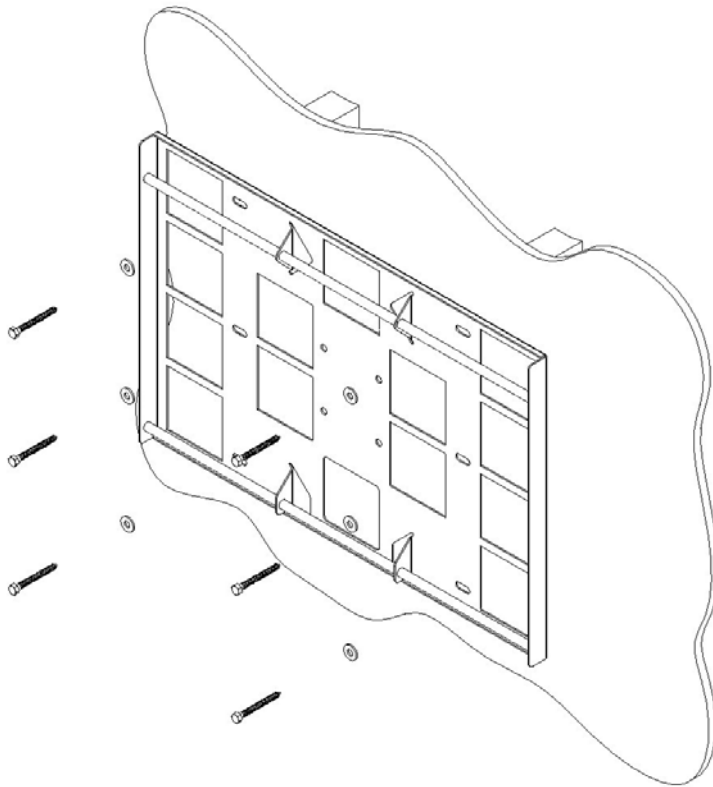

Fig 3. Mounting the CTM plate onto the Wall.

- **Mount the Plasma + Plasma Bracket onto the Wall Plate**

Make sure the moveable hooks on the Plasma Brackets are as shown in Fig 4, raise the Plasma TV (2 people minimum recommended) and place the Plasma TV flat against the Wall Plate with all of the hooks slightly higher than the rods on the Wall Plate. Holding it level, lower the Plasma TV to seat all four Plasma Bracket hooks, as indicated in Fig 4. Gently pull the left and right upper edges of the Plasma TV away from the wall to extend the mount to its maximum 12° tilt and screw in by hand the two ¼x20 Securing Knobs into the moveable hooks, one on each mounting bracket, as shown in Fig 4.

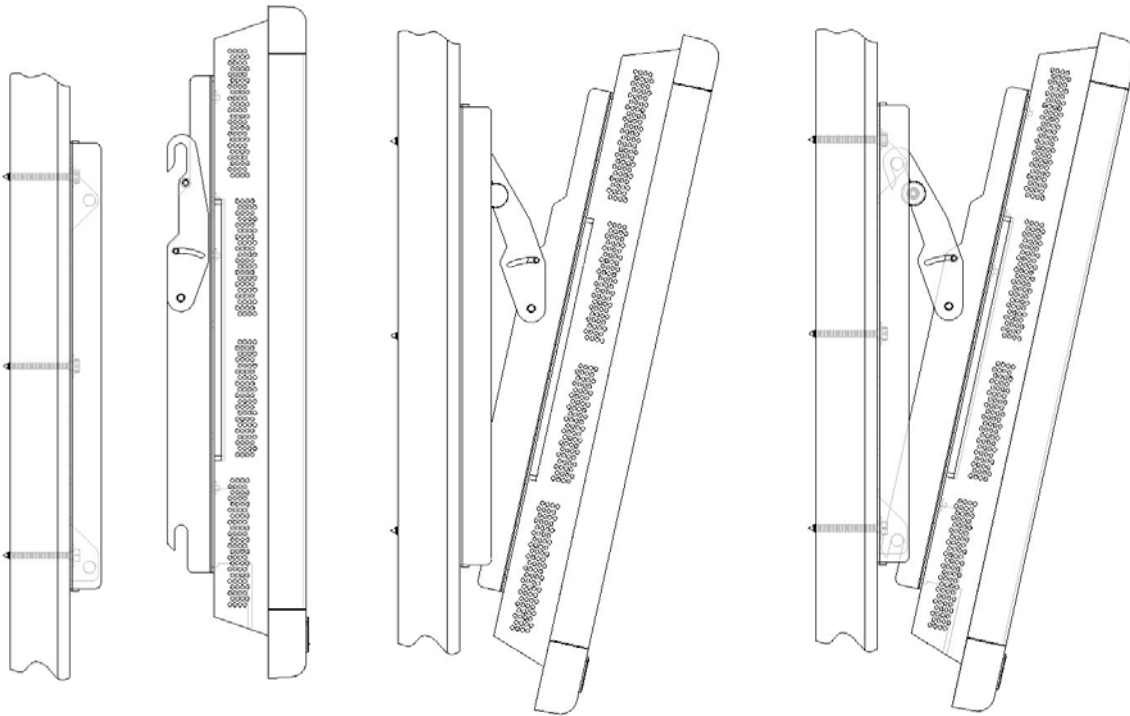

Fig 4. Mounting the Plasma TV on the Wall Plate and Installing the Securing Knobs



- **Adjust the Holding Tension of the Moveable Hooks**

To adjust the Moveable Hooks so that they can hold the weight of the Plasma TV at any position between 0° and 12° first adjust the nut so that it is just too tight to move the Plasma TV, then adjust the screw so that Plasma TV can be moved but will remain in any desired position within the tilt range.

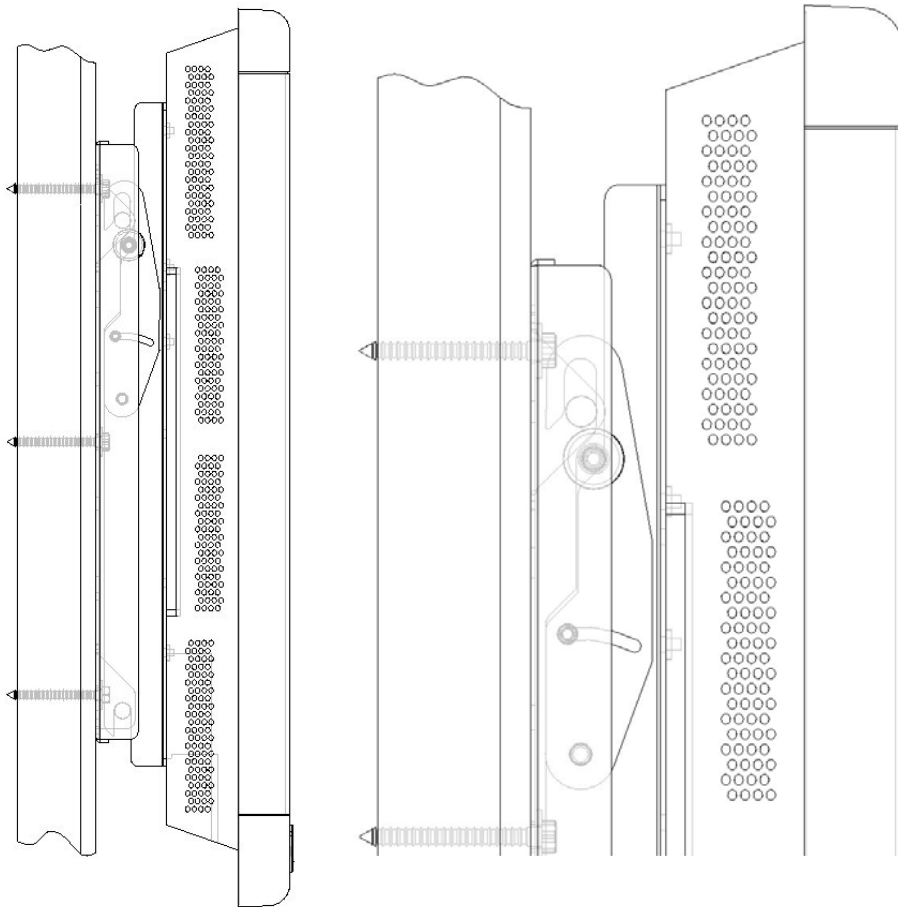

Fig 5. Space between Hook and Rod when Assembled

When the Wall Mount is assembled correctly and the Plasma TV is in the vertical position, there will be a 7/8" gap between the rod Moveable Hook, as shown in Fig 5. This gap is needed to allow the Wall Mount to tilt.

**Final Positioning of the Plasma TV.**

Fig 6. Final Position of the Plasma TV.

While the Plasma TV is on the Wall Mount you still can move the display from left to right or right to left to optimize the final position of the Plasma TV on the wall by gently sliding the unit on the steel rods of the Wall Plate.

- **Removal of the Plasma TV from the Wall Mount.**

To remove the display from the wall simply extend the display to its maximum 12° tilt, remove the two Securing Knobs, push the Plasma TV back to its flat vertical position and lift the unit up and out from the wall (2 people minimum recommended).

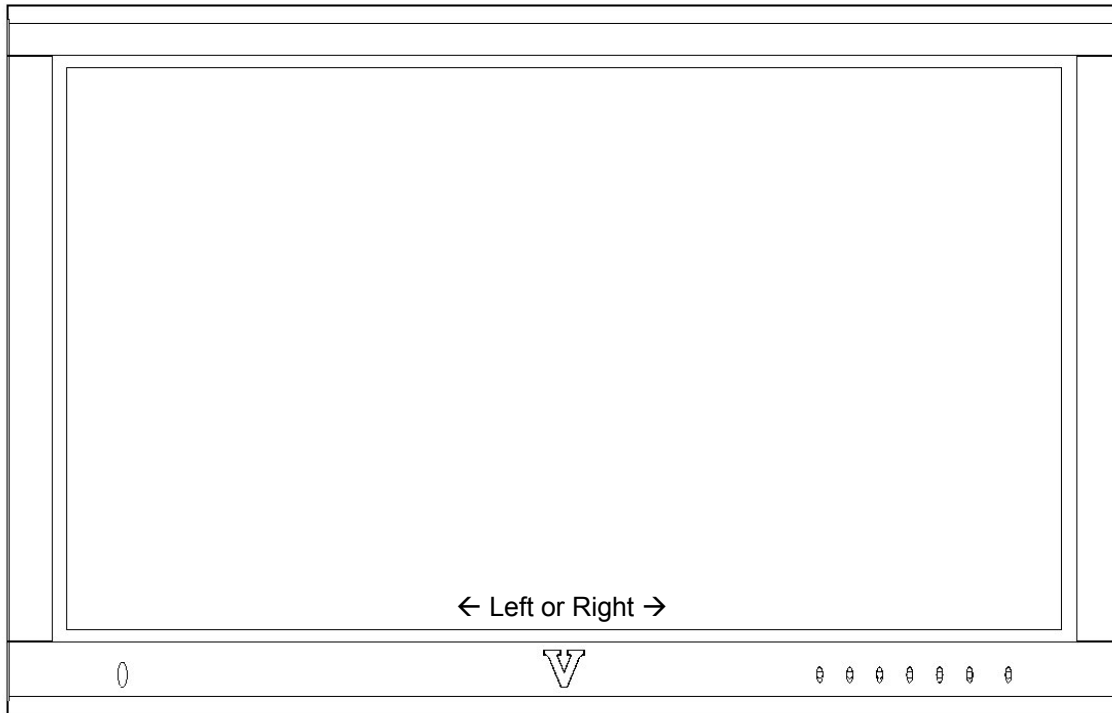
## 15. Telephone & Technical Support

Products are often returned due to a technical problem rather than a defective product which may result in unnecessary shipping charges billed to you. Our trained support personnel can often resolve the problem over the phone. For more information on warranty service or repair, after the warranty period, please contact our Support Department at the number below.

Quality service and consistent technical support are integral parts of V's commitment to service excellence. V's service representatives are dedicated to assist you with the utmost in customer satisfaction. To better assist you, please contact via email or phone.

**Email: [techsupp@vinc.us](mailto:techsupp@vinc.us) or Tel: (714) 593-8037, 6am-3pm PST**

### **Corporate Contact Information**

V Incorporated  
10910 Talbert Avenue  
Fountain Valley, CA 92708  
Tel: (714) 962.4848  
Fax: (714) 593-8932  
Web: [www.VINC.com](http://www.VINC.com)

# V INCORPORATED LIMITED WARRANTY

## For VIZIO PLASMA Displays

Welcome to the V, Inc. Digital Family! Please read this warranty carefully, it is a "ONE-YEAR LIMITED WARRANTY" on parts and labor.

### V, Inc.'s Responsibility

V, Inc. PLASMA Displays purchased in the United States are warranted to be free from defects in materials or workmanship for a period of one (1) year from the date of their original retail purchase. If the unit fails to conform to this warranty, we will service the monitor using new or refurbished parts.

#### Service Labor

During a period of one year from the effective warranty date, V, Inc. will provide, when needed, service labor to repair a manufacturing defect at its designated Service Center. To obtain warranty service in the United States, you must first call our Customer Support at (714) 962-4388, 9:30am-6pm EST. The determination of service will be made by V, Inc. Customer Support. PLEASE DO NOT RETURN YOUR UNIT TO V, INC. WITHOUT PRIOR AUTHORIZATION.

#### Parts

New or remanufactured replacements for defective parts will be used for repairs by V, Inc. at its designated Service Center for one (1) year from the effective warranty date. Such replacement parts are warranted for the remaining portion of the original warranty period.

#### Service

During the one (1) year warranty period, V, Inc. will, at its option and sole discretion, repair or replace defective parts, including replacement of the entire PLASMA Panel. The Customer will be required to ship the unit to the Service Center indicated at the time Customer Support is contacted to make the necessary repairs. You are responsible for all transportation charges to and from the service facility. V, Inc. is not responsible for the de-installation or re-installation of the unit.

#### Packaging and Shipping Instructions

When you send the product to an authorized V, Inc. service facility you must use the original carton box and packing material or an equivalent as approved by V, Inc.

#### Not Covered

This warranty does not cover defects, malfunctions or failures resulting from shipping or transit accidents, abuse, misuse, operation contrary to furnished instructions, operation on incorrect power supplies, operation with faulty associated equipment, modification, alteration, improper servicing, tampering or normal wear and tear or TVs on which the serial number has been removed or defaced. Image Sticking caused by operating at excessive brightness levels for extended periods or mishandling are not covered by this warranty.

ANY IMPLIED WARRANTIES, INCLUDING ANY IMPLIED WARRANTY OF MERCHANTABILITY AND FITNESS FOR A PARTICULAR PURPOSE SHALL BE LIMITED IN DURATION TO THE PERIOD OF TIME SET FORTH ABOVE. OUR LIABILITY FOR ANY AND ALL LOSSES AND DAMAGES RESULTING FROM ANY CAUSE WHATSOEVER, INCLUDING OUR NEGLIGENCE, ALLEGED DAMAGE OR DEFECTIVE GOODS, WHETHER SUCH DEFECTS ARE DISCOVERABLE OR LATENT, SHALL IN NO EVENT EXCEED THE PURCHASE PRICE OF THE DISPLAY. WE SHALL NOT BE RESPONSIBLE FOR LOSS OF USE, COMMERCIAL LOSS OR OTHER INCIDENTAL OR CONSEQUENTIAL DAMAGES. SOME STATES DO NOT ALLOW LIMITATIONS ON HOW LONG AN IMPLIED WARRANTY LASTS OR THE EXCLUSION OR LIMITATION OF INCIDENTAL OR CONSEQUENTIAL DAMAGES, SO THE ABOVE LIMITATIONS OR EXCLUSIONS MAY NOT APPLY TO YOU. This warranty gives you specific legal rights, and you may also have other rights which vary from state to state. This is the only warranty applicable; no one is authorized to extend or modify it or to grant any other warranty.

V, Inc. retains the right to assess all warranty claims and to determine if damages are covered by the warranty. In case of a claim that is not covered by the warranty, you will be contacted to determine whether V, Inc. should repair the damage for a fee or whether the product should be returned to you as received by the repair center.

### Owner's Responsibility

#### Effective Warranty Date

Warranty begins on the date of sale to the end user. To ensure warranty service, keep the dated bill or sale receipt as evidence of the purchase date.

#### User Manual

Read your User Manual carefully so that you will understand the operation of your PLASMA Display and how to adjust the user controls.

#### Warranty Service

For warranty service information, contact V, Inc. Customer Support at (714) 962-4388, 9:30am-6pm EST. Parts and service labor that are V, Inc.'s responsibility (see above) will be provided without charge. Other service is at the owner's expense. You must provide the model, serial number and date of purchase. Before you ask for warranty service, read your User Manual. You might avoid a service call.

For Technical Support Call (714)962-4388 or E-mail [Techsupp@vinc.us](mailto:Techsupp@vinc.us)



VINC.COM

---

WHERE VISION MEETS VALUE!

---

Available in the Continental US only. Limited warranties and service agreements apply; visit [www.vinc.us](http://www.vinc.us) or call 714-962-4848 for a free copy. Copyright ©2003 V, Inc. All rights reserved. V, Inc., "V" logo, "where vision meets value" are trademarks or registered trademarks of V, Inc. in the US and other countries. V, Inc. Terms and conditions of sale apply. Trademarks mentioned are registered to their respective owners.