

User Guide

65" 1080p LED TV

INSIGNIA™

NS-65D260A13



Contents

CHILD SAFETY	1
Important Safety Instructions	2
WARNING	2
CAUTION	3
Introduction	4
INlink	4
Insignia Motion 120Hz	4
Game mode	4
Installing the stand or wall-mount bracket	5
Installing the stand	5
Installing a wall-mount bracket	5
TV components	6
Package contents	6
Front	6
Side	6
Back	7
Remote control	8
Making connections	9
What connection should I use?	9
Connecting power	10
Connecting a cable or satellite box	10
Connecting an antenna or cable TV (no box)	13
Connecting a DVD or Blu-ray player	13
Connecting a VCR	15
Connecting a camcorder or game console	16
Connecting a computer	16
Connecting a USB flash drive	17
Connecting headphones	18
Connecting a basic home theater system	18
Connecting a home theater system with multiple devices	19
Using the remote control	20
Installing remote control batteries	20
Aiming the remote control	20
Turning on your TV for the first time	20

Understanding the basics	23
Turning your TV on or off	23
Selecting the video input source	23
On-screen menu overview	23
Navigating the menus	24
Selecting a channel	24
Adjusting the volume	24
Viewing channel information	24
Viewing system information	25
Adjusting the picture	25
Adjusting the TV picture	25
Adjusting the computer image	26
Adjusting component video settings	27
Setting the power on picture mode	28
Displaying a banner at power on	28
Adjusting the sound	29
Adjusting sound settings	29
Playing TV audio only	30
Changing channel settings	30
Automatically scanning for channels	30
Hiding channels	31
Setting up a favorite channel list	32
Viewing a favorite channel	32
Adding or changing a channel label	33
Checking the digital signal strength	33
Automatically adjusting the aspect ratio	34
Setting parental controls	34
Setting or changing the password	34
Locking control buttons	35
Blocking unrated TV	36
Setting parental control levels	37
Downloading rating information	38
Using closed captioning	39
Turning closed captioning on or off	39
Selecting the analog closed captioning mode	39
Customizing digital closed captioning styles	40
Adjusting time settings	41
Setting the clock	41
Setting the sleep timer	42

Adjusting menu settings	43
Selecting the menu language	43
Turning Input Sensor on or off	43
Labeling an input source	44
Restoring settings to the defaults	44
Using INlink	45
Turning INlink on or off	45
Turning Device Auto Power Off on or off	46
Turning TV Auto Power On on or off	46
Turning Audio Receiver on or off	47
Displaying a list of INlink-compatible (HDMI CEC) devices	47
Using a USB flash drive	48
Switching to USB mode	48
Browsing photos	48
Viewing favorite photos	49
Viewing photos in a slideshow	49
Customizing slideshow settings	49
Maintaining	50
Cleaning the TV cabinet	50
Cleaning the TV screen	50
Troubleshooting	50
Video and audio	50
Remote control	51
General	51
Specifications	52
Programming universal remote controls	53
Programming a different universal remote control	53
Common universal remote control codes	54
Legal notices	54
One-year limited warranty - Insignia Televisions	55
Definitions:	55
How long does the coverage last?	55
What does this warranty cover?	55
How to obtain warranty service?	55
Where is the warranty valid?	55
What does the warranty not cover?	55

CHILD SAFETY

It makes a difference how and where you use your flat panel display

As you enjoy your new product, keep these safety tips in mind

The issue

The home theater entertainment experience is a growing trend, and larger TVs are popular purchases. However, TVs are not always supported on the proper stands or installed according to the manufacturer's recommendations. We and the consumer electronics industry are committed to making home entertainment enjoyable and safe.

TVs that are inappropriately placed on dressers, bookcases, shelves, desks, speakers, chests, or carts may fall over and cause injury.

Tune into safety

- One size of TV stand does **not** fit all. Use only a TV stand rated for the weight of your TV.
- Carefully read and understand all enclosed instructions for proper use of this product.
- Don't let children climb on or play with entertainment system furniture and TVs.
- Don't place TVs on furniture that can easily be used as steps, such as a crate or chest of drawers.
- Remember that children can become excited while watching a program, especially on a "larger-than-life" TV. Make sure that you place or install the TV where it cannot be pushed, pulled over, or knocked down.
- Make sure that you route all cords and cables so that they cannot be pulled or grabbed by curious children.



Wall mounting

If you decide to wall mount your TV, always remember:

- One size of wall mount does **not** fit all. Use only a wall mount rated for the weight of your TV and that has been recommended by this TV manufacturer, listed in this manual, or otherwise listed by an independent laboratory as suitable for your TV.
- Follow all instructions supplied by the TV and wall mount manufacturers.
- If you have any doubts about your ability to safely wall mount your TV, get help from a professional installer.
- Make sure that the wall where you are mounting the TV is appropriate. Some wall mounts are not designed to be mounted to walls backed with steel studs or cinder blocks. If you are unsure, ask a professional installer.



TVs can be heavy. At least two people are required for safe wall mount installation.

Important Safety Instructions



This symbol indicates that dangerous voltage constituting a risk of electric shock is present within your TV. This label is located on the back of your TV.



This symbol indicates that there are important operating and maintenance instructions in the literature accompanying your TV.

- 1 Read these instructions.
- 2 Keep these instructions.
- 3 Heed all warnings.
- 4 Follow all instructions.
- 5 Do not use this apparatus near water.
- 6 Clean only with dry cloth.
- 7 Do not block any ventilation openings. Install in accordance with the manufacturer's instructions.
- 8 Do not install near any heat sources such as radiators, heat registers, stoves, or other apparatus (including amplifiers) that produce heat.
- 9 Do not defeat the safety purpose of the polarized or grounding-type plug. A polarized plug has two blades with one wider than the other. A grounding type plug has two blades and a third grounding prong. The wide blade or the third prong are provided for your safety. If the provided plug does not fit into your outlet, consult an electrician for replacement of the obsolete outlet.
- 10 Protect the power cord from being walked on or pinched particularly at plugs, convenience receptacles, and the point where they exit from the apparatus.
- 11 Only use attachments/accessories specified by the manufacturer.
- 12 Use only with the cart, stand, tripod, bracket, or table specified by the manufacturer, or sold with the apparatus. When a cart is used, use caution when moving the cart/apparatus combination to avoid injury from tip-over.
- 13 Unplug this apparatus during lightning storms or when unused for long periods of time.
- 14 Refer all servicing to qualified service personnel. Servicing is required when the apparatus has been damaged in any way, such as power-supply cord or plug is damaged, liquid has been spilled or objects have fallen into the apparatus, the apparatus has been exposed to rain or moisture, does not operate normally, or has been dropped.



S3125A

- 15 The *wall plug* is the disconnecting device. The plug must remain readily operable.
- 16 An apparatus with three-prong, grounding-type plug is a Class I apparatus which needs to be grounded to prevent possible electric shock. Make sure that you connect the Class I apparatus to a grounding-type, three-prong outlet.
- 17 Remote control batteries should not be exposed to excessive heat such as sunshine, fire, or the like.
- 18 The apparatus should not be exposed to dripping or splashing, and no objects filled with liquids, such as vases, should be placed on the apparatus.

WARNING

Electric shock hazard

To reduce the risk of fire or electric shock, do not remove any cover or expose the device to rain or moisture. No user-serviceable parts are inside. Refer servicing to qualified service technicians.

Lightning

For added protection for your device receiver during a lightning storm, or when it is left unattended and unused for long periods of time, unplug it from the power outlet and disconnect any antenna or cable system. This helps prevent property damage and personal injury from lightning and power line surges.

Power lines

An outside antenna system should not be located in the vicinity of overhead power lines or other electric light or power circuits, or where it can fall into such power lines or circuits. When installing an outside antenna system, extreme care should be taken to keep from touching such power lines or circuits as contact with them might be fatal.

Handling the LCD panel

- Your TV's screen is made of glass. Do not drop your TV or hit, jolt, or press hard against the LCD panel. If the screen breaks, be careful of broken glass.
- If the LCD panel is broken, make absolutely sure that you do not touch the liquid in the panel. This may cause skin inflammation.
- If the liquid gets in your mouth, immediately gargle, rinse, and consult with your doctor. Also, if the liquid gets in your eyes or touches your skin, consult with your doctor after rinsing for at least 15 minutes or longer in clean water.

Replacement parts

When replacement parts are required, make sure that the service technician uses replacement parts specified by the manufacturer that have the same characteristics as the original part. Unauthorized substitutions may result in fire, electric shock, personal injury, or other hazards.

Safety check

After completing any service or repair to this device, ask the service technician to perform routine safety checks to determine that your TV is in correct operating condition.

Power source

Operate your TV only from the type of power source indicated on the marking label. If you are not sure of the type of power supplied to your home, consult an electrician or your local power company.

Servicing

These servicing instructions are for use by qualified service personnel only. To reduce the risk of electric shock, do not perform any servicing other than that contained in the operating instructions unless you are qualified to do so.

CAUTION

Damage requiring service

Unplug this TV from the power outlet and refer servicing to qualified service personnel under the following conditions:

- When the power supply cord or plug is damaged or frayed.
- If liquid has been spilled or objects have fallen into your TV.
- If your TV has been exposed to rain or water.
- If your TV does not operate normally by following the operating instructions. Adjust only those controls that are covered by the operating instructions because incorrect adjustment of other controls may result in damage and will often require extensive work by a qualified technician to restore your TV to its normal operation.
- If your TV has been dropped or damaged in any way.
- When your TV exhibits a distinct change in performance.

Outdoor antenna grounding

If an outside antenna or cable system is connected to your TV, make sure that the antenna or cable system is grounded to provide some protection against voltage surges and built-up static charges. Article 810 of the National Electrical Code, ANSI/NFPA No. 70, provides information with respect to correct grounding of the mast and supporting structure, grounding of the lead-in wire to an antenna discharge unit, size of grounding conductors, location of the antenna-discharge unit, connection to grounding electrodes, and requirements for the grounding electrode.

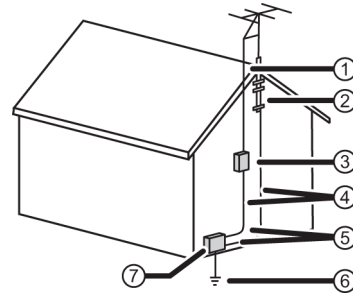

- ① Antenna lead-in wire
- ② Grounding clamp
- ③ Antenna discharge unit
- ④ Grounding conductors
- ⑤ Ground clamps
- ⑥ Power service grounding electrode system
- ⑦ Electric service equipment

Note to CATV system installer

Article 820 of the National Electrical Code, ANSI/NFPA No. 40 provides guidance for correct grounding. Specifically, it states that the cable ground must be connected to the grounding system of the building as close to the point of cable entry as practical.

Condensation

Moisture will form on the TV if the TV is brought from cool surroundings into a warm room or if the temperature of the room rises suddenly. When this happens, the TV's performance may be impaired. To prevent this, let the TV stand in its new surroundings for about an hour before switching it on, or make sure that the room temperature rises gradually.

Condensation may also form during the summer if the TV is exposed to the breeze from an air conditioner. In such cases, change the location of the TV.

Mobile telephone warning

To avoid interference with your TV picture and sound, operating problems, or even damage, keep your cordless and cellular telephones away from the TV.

End of life directives

Your TV contains tin-lead solder. Disposal of this material may be regulated for environmental reasons. Your TV also contains material that can be recycled and reused. For disposal or recycling information, contact your local authorities to find a recycler in your area.

Non-active pixels

The LCD panel contains almost 3 million thin film transistors, which provide exceptionally sharp video quality. Occasionally, a few non-active pixels may appear on the screen as a fixed blue, green, or red point. These non-active pixels do not adversely affect the performance of your TV, and are not considered defects.

Insignia 65" 1080p LED TV

Introduction

Congratulations on your purchase of a high-quality Insignia product. Your NS-65D260A13 represents the state of the art in LED TV design and is designed for reliable and trouble-free performance.

INlink

Enjoy the benefit of having HDMI CEC compatible products plug and play! No setup is needed! CEC technology lets different components discover and communicate with each other. (See page [45](#) for instructions on how to use INlink.)

Insignia Motion 120Hz

With a 120 Hz screen refresh rate twice the rate of a 60 Hz screen, a screen with 1,080 lines of resolution (up from 720 lines in the last generation of HDTVs), and special motion-detection technology, you will experience a picture with clearer detail and brightness, smoother transitions, and reduced motion blurring, particularly when watching fast-motion sports and action scenes. (See page [26](#) for instructions on how to adjust the TV picture.)

Game mode

Video games generally require adjustments to the television picture settings to get the maximum experience. By simply pressing a button on your remote control, your television settings will automatically adjust for video games. It couldn't be easier. (See page [25](#) for instruction on how to select Game mode.)

Installing the stand or wall-mount bracket

Notes

- If you plan to wall-mount your TV, do not install the stand.
- Store the stand and stand screws in case you decide to use the stand in the future.

Installing the stand

To install the stand:

- 1 Carefully place your TV face-down on a cushioned, clean surface to protect the screen from damages and scratches.

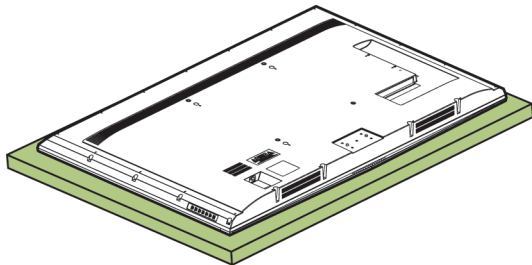

- 2 Secure the stand column to the TV using five M6 x 18 mm screws (provided).

Screw type	Screw length	# of screws
M6	18 mm	5

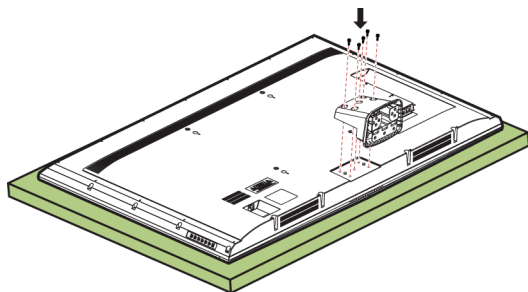

- 3 Secure the TV stand base to the stand column using seven M6 x 18 mm screws (provided).

Screw type	Screw length	# of screws
M6	18 mm	7

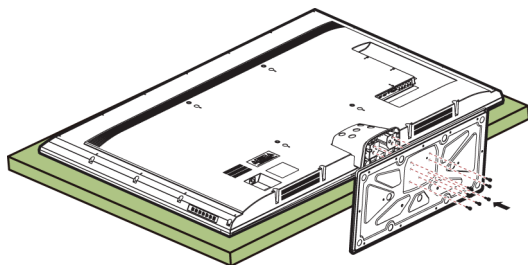

Installing a wall-mount bracket

Warning

This TV is intended to be supported by a UL Listed wall mount bracket with suitable weight/load. (See "Miscellaneous" on page 53.)

To attach your TV to a wall-mount bracket:

- 1 Carefully place your TV face-down on a cushioned, clean surface to protect the screen from damages and scratches.
- 2 Remove the five screws that secure the stand column to the TV, then remove the stand column.

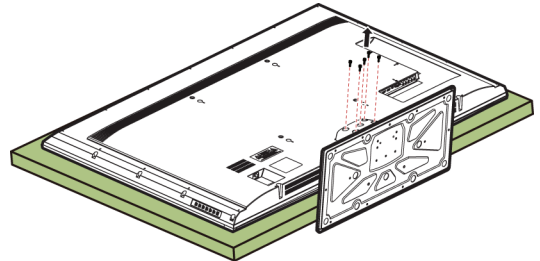

- 3 Attach the wall-mount bracket to your TV using the mounting holes on the back of your TV. See the instructions that came with the wall-mount bracket for information about how to correctly hang your TV.

Note

- The length of the wall-mount screws vary depending on the wall-mount bracket you purchased. See the instructions that came with the wall-mount bracket for screw lengths.
- The mounting holes on the back of your TV take type M6 screws.

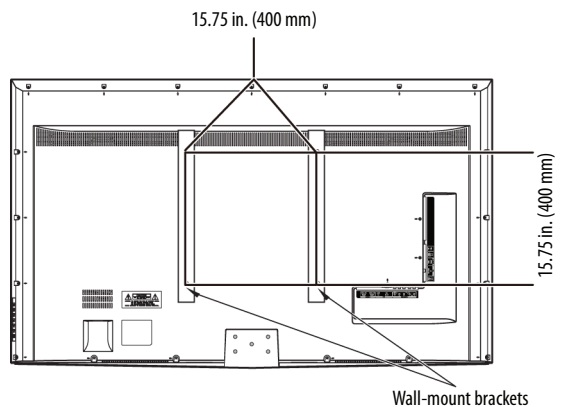

TV components

Package contents

- Remote control and batteries (2 AAA)
- Stand column
- TV stand base
- Screws (12)
- Power cord
- *Quick Setup Guide*
- *Important Information*

Front

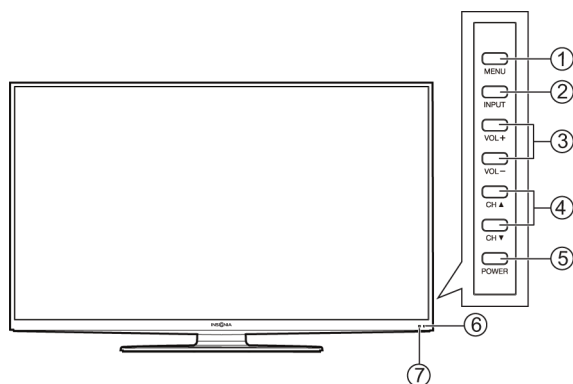

#	Item	Description
①	MENU	Press to open the on-screen menu. For more information, see "Navigating the menus" on page 24.
②	INPUT	Press to open the <i>INPUT SOURCE</i> list, press \wedge or \vee to select the video input source, then press INPUT again. For more information, see "Selecting the video input source" on page 23. In menu mode, press to confirm selections.
③	VOL+/VOL-	Press to increase or decrease the volume.
④	CH \blacktriangle /CH \blacktriangledown	Press to go to the next or previous channel in the channel list. For more information, see "Selecting a channel" on page 24.
⑤	⏻ (power)	Press to turn your TV on or off (standby mode). Warning: When your TV is off, power still flows through it. To completely disconnect power, unplug the power cord.
⑥	Power indicator	Turns off when your TV is on. Lights red when your TV is off (standby mode).
⑦	Remote control sensor	Receives signals from the remote control. Do not block.

Side

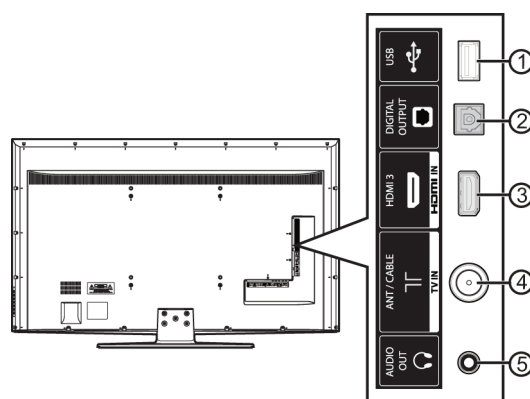

#	Item	Description
①	USB	Connect a USB flash drive to this jack to view compatible JPEG picture files. For more information, see "Connecting a USB flash drive" on page 17 and "Using a USB flash drive" on page 48.
②	DIGITAL OUTPUT (optical)	Connect a digital audio amplifier or home theater system to this jack to listen to TV audio through the amplifier speakers. For more information, see "Using digital audio" on page 18.
③	HDMI3	Connect an HDMI device to this jack. For more information, see "Using HDMI (best)" on pages 10, 13, or 17.
④	TV IN ANT/CABLE	Connect an antenna or cable TV to this jack. For more information, see "Connecting an antenna or cable TV (no box)" on page 13.
⑤	🎧 /AUDIO OUT	Connect headphones, an analog audio amplifier, a home theater system, or a sound bar to this jack. For more information, see "Using analog audio" on page 19.

Back

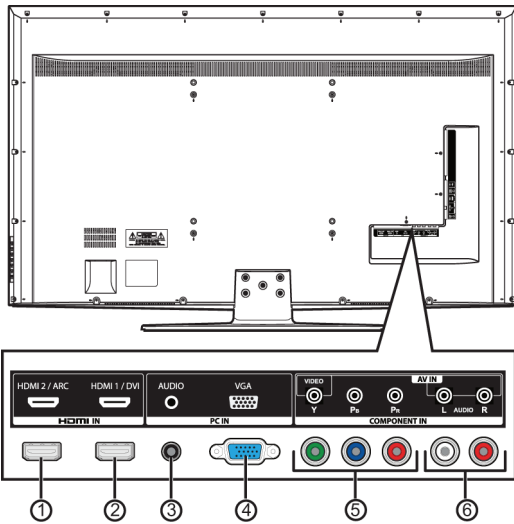

#	Item	Description
①	HDMI2/ARC	Connect an HDMI device to this jack. For more information, see " Using HDMI (best) " on pages 10, 13, or 17. If you are connecting a home theater system using HDMI, connect it to this jack.
②	HDMI1 (DVI)	Connect an HDMI device to this jack. For more information, see " Using HDMI (best) " on pages 10, 13, or 17. OR Connect the video for a DVI device to this jack. For more information, see " Using DVI (same as HDMI but requires a sound connection) " on pages 11 or 14.
③	PC IN AUDIO	Connect the audio for a computer to this jack. For more information see " Using VGA " on page 16. OR Connect the audio for a DVI device to this jack. For more information see, " Using DVI (same as HDMI but requires a sound connection) " on pages 11 or 14.
④	PC IN VGA	Connect the video (VGA) for a computer to this jack. For more information, see " Using VGA " on page 16. The COMPONENT IN Y/VIDEO jack works as one of the component video jacks or as a composite video jack.
⑤	COMPONENT IN Y/VIDEO, Pb, Pr OR AV IN Y/VIDEO	Connect the video for a component video device to these jacks. For more information, see " Using component video (better) " on page 11 or 14. OR Connect the video for a composite video device to the Y/VIDEO jack. For more information, see " Using composite video (good) " on page 12 or 15.
⑥	AV IN AUDIO L/R	Connect the audio for a component video device to these jacks. For more information, see " Using component video (better) " on page 11 or 14. OR Connect the audio for a composite video device to these jacks. For more information, see " Using composite video (good) " on page 12 or 15.

Remote control

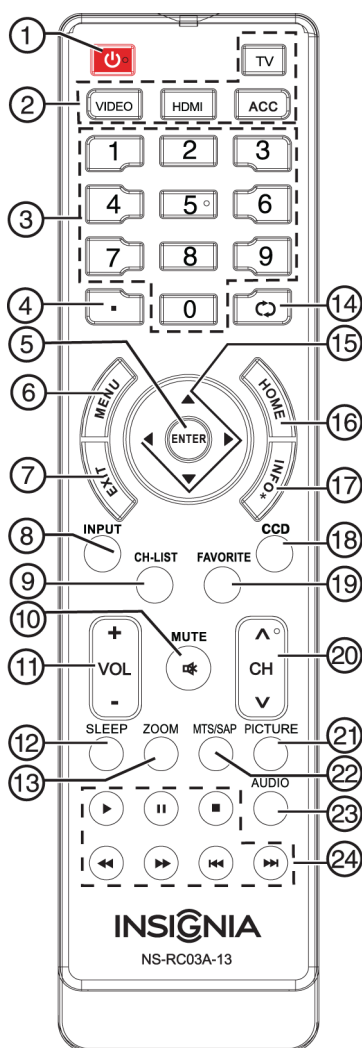







#	Button	Description
1	⏻ (power)	Press to turn your TV on or off (standby mode). Warning: When your TV is off, power still flows through it. To disconnect power, unplug the power cord.
2	Quick Launch Inputs	TV —Press to select the TV input source. VIDEO —Press to select the composite video device connected to the Y/VIDEO jack. HDMI —Press one or more times to select the device connected to the HDMI1 (DVI) , HDMI2 (ARC) , or HDMI3 jack. ACC —This button has no function.
3	Numbers	Press to enter channel numbers and the parental control password.
4	●	Press to enter a digital sub-channel number. For more information, see “Selecting a channel” on page 24.
5	ENTER	Press to confirm selections or changes.
6	MENU	Press to open the on-screen menu.
7	EXIT	Press to close the on-screen menu.
8	INPUT	Press to open the INPUT SOURCE list, press ▲ or ▼ on the remote control to select the video input source, then press ENTER . For more information, see “Selecting the video input source” on page 23.
9	CH-LIST	Press to open the channel list.

#	Button	Description
10	🔇 /MUTE	Press to mute the sound. Press again to restore the sound.
11	VOL+/-	Press to increase or decrease the volume.
12	SLEEP	Press to set the sleep timer. You can select Off , 5 , 10 , 15 , 30 , 60 , 90 , 120 , 180 , or 240 minutes. For more information, see “Setting the sleep timer” on page 42.
13	ZOOM	Press to change how the picture looks on the screen (aspect ratio). For more information, see “Aspect ratio options” on page 26.
14	○ (return)	In TV mode, press to return to the previous channel.
15	▲▼▶◀	Press to navigate in on-screen menus and to adjust settings.
16	HOME	Press to open the on-screen menu.
17	INFO	Press to display TV status information, such as the channel number, channel name (if available), or signal source. For more information, see “Viewing channel information” on page 24.
18	CCD	Press to turn closed captioning on or off. You can select CC Off , CC On , or CC on When Mute . For more information, see “Turning closed captioning on or off” on page 39.
19	FAVORITE	Press to open the Favorite channel list. For more information, see “Setting up a favorite channel list” on page 32 and “Viewing a favorite channel” on page 32.
20	CH ▲/CH ▼	Press to change TV channels. For more information, see “Selecting a channel” on page 24.
21	PICTURE	Press to select the picture mode. You can select Vivid , Standard , Energy Savings , Theater , Game , or Custom . For more information, see “Picture Mode” on page 25.
22	MTS/SAP	Press to select the audio mode for an analog program. You can select: <ul style="list-style-type: none"> Mono—Select this option if there is noise or static on weak stereo broadcasts. Stereo—Select this option for programs broadcast in stereo. SAP—Select this option to listen to a secondary audio program, if available.
23	AUDIO	Press to select the sound mode. You can select Standard , Theater , Music , News , or Custom . For more information, see “Sound Mode” in “Adjusting sound settings” on page 29.
24	INlink Controls	Press to control INlink-compatible (HDMI CEC) devices. For more information, see “Using INlink” on page 45.

Making connections

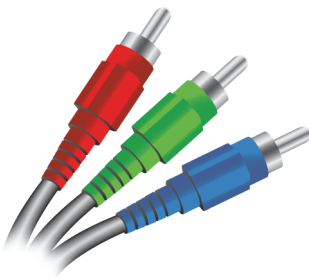
What connection should I use?

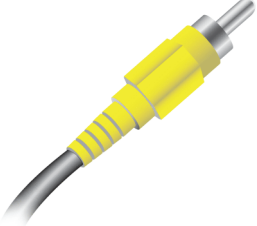
Your TV has several connection types for connecting devices to your TV. For the best video quality, you should connect a device to the best available connection. Use the following tables to identify cables:

Connection type and jack	Video quality	Cable connector
 HDMI video/audio	Best (use this if your devices have HDMI)	
 Component video (requires an audio connection)	Better than composite or coaxial	
 Composite video (requires an audio connection)	Better than coaxial	
 Coaxial video/audio	Good	

Connection type and jack	Cable connectors
--------------------------	------------------

Optical digital audio (SPDIF)



Analog audio

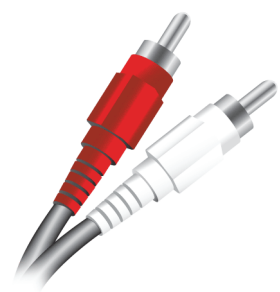

VGA (computer) video and audio

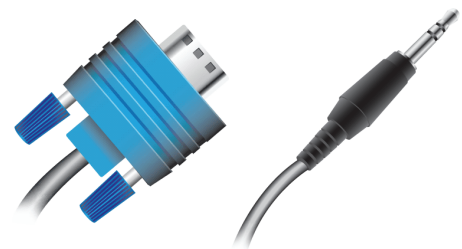

You can use the **HDMI1 (DVI)** jack on your TV to connect a DVI device to your TV. You need to attach an HDMI-to-DVI adapter to the end of the HDMI cable that connects to the DVI device.

Cautions

- Check the jacks for position and type before making any connections.
- Loose connections can result in image or color problems. Make sure that all connections are tight and secure.
- The external audio/video equipment shown may be different from your equipment. If you have questions, refer to the documentation that came with your equipment.
- Always unplug the power cord when connecting external equipment.

Connecting power

To connect the power:

- Connect the AC power cord to the AC connector on the back of your TV, then connect the other end of the power cord to a power outlet.

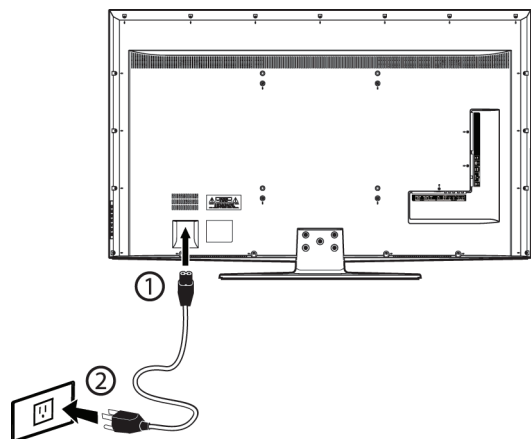

Cautions

- Your TV should only be operated from the power source indicated on the label.
- Always unplug the AC power cord from the power outlet when you will not be using your TV for an extended period of time.

Connecting a cable or satellite box

Many cable or satellite TV boxes have more than one connection type. To get the best video, you should use the best connection type available. For more information, see "[What connection should I use?](#)" on page 9.

Using HDMI (best)

To connect a cable or satellite box using HDMI:

- 1 Make sure that your TV's power cord is unplugged, and all connected equipment is turned off.
- 2 Connect the incoming cable from the cable wall jack to the cable-in jack on the cable or satellite box.
- 3 Connect an HDMI cable (not provided) to the HDMI jack on the side or back of your TV and to the HDMI OUT jack on the cable or satellite box.

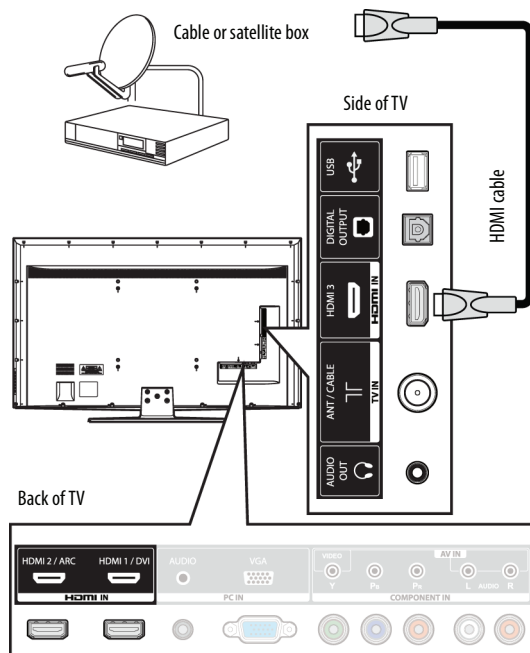

- 4 Plug your TV's power cord into a power outlet, turn on your TV, then turn on the cable or satellite box.
- 5 Go through the Setup Wizard on page 20.

Note

An HDMI cable carries both audio and video. You do not need to use any audio cables.

Using DVI (same as HDMI but requires a sound connection)

Note

You must use the **HDMI1/DVI** jack to connect a cable or satellite box using DVI. If you use another HDMI jack, you will not hear sound from the TV speakers.

To connect a cable or satellite box using DVI:

- 1 Make sure that your TV's power cord is unplugged, and all connected equipment is turned off.
- 2 Connect the incoming cable from the cable wall jack to the cable-in jack on the cable or satellite box.
- 3 Connect an HDMI-DVI adapter (not provided) to one end of an HDMI cable (not provided), then connect the adapter to the **DVI OUT** jack on the cable or satellite box.
- 4 Connect the other end of the cable to the **HDMI1 (DVI)** jack on the back of your TV.

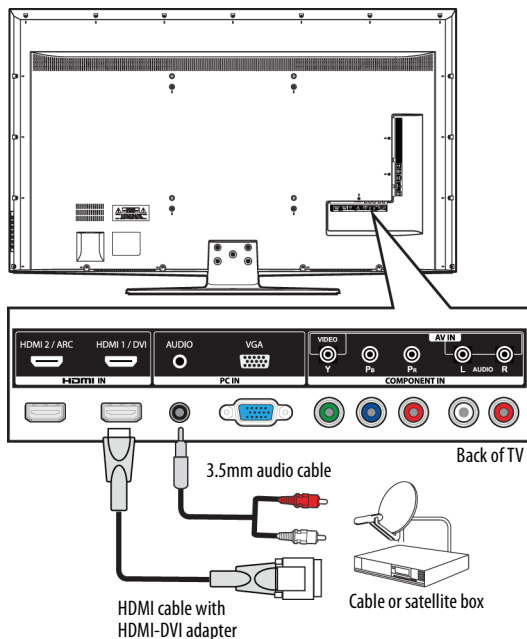

- 5 Connect a 3.5mm audio cable (not provided) to the **PC IN AUDIO** jack on the back of your TV and to the **AUDIO OUT** jacks on the cable or satellite box.

Note

When you connect the audio using the **PC IN AUDIO** jack, the audio output is analog.

- 6 Plug your TV's power cord into a power outlet, turn on your TV, then turn on the cable or satellite box.
- 7 Go through the Setup Wizard on page [20](#).

Using component video (better)

To connect a cable or satellite box using component video:

- 1 Make sure that your TV's power cord is unplugged, and all connected equipment is turned off.
- 2 Connect the incoming cable from the cable wall jack to the cable-in jack on the cable or satellite box.
- 3 Connect a component video cable (not provided) to the **Y/VIDEO**, **Pb**, and **Pr** video jacks on the back of your TV and the component video out jacks on the cable or satellite box.

Cables are often color-coded to match color-coded jacks.

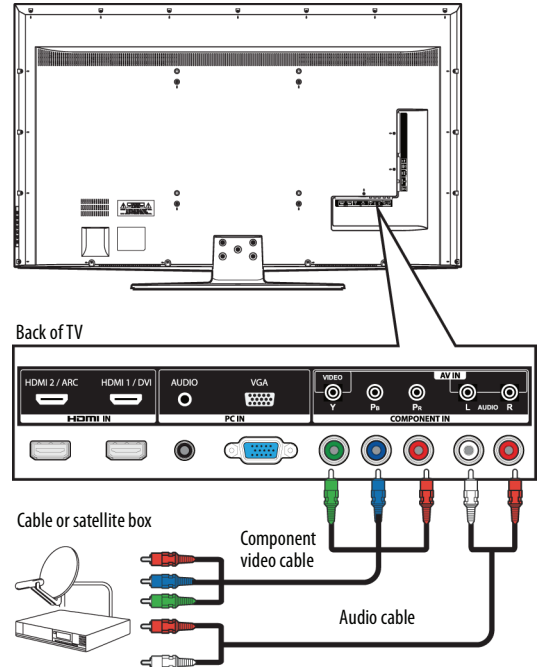

- 4 Connect an audio cable (not provided) to the **AV IN AUDIO L/R** jacks on the back of your TV and to the audio out jacks on the cable or satellite TV box.

Note

- The **Y/VIDEO**, **Pb**, and **Pr** video jacks (used to connect a component device) share the **AV IN AUDIO L/R** jacks with the **Y/VIDEO** jack (used to connect a composite device).
- When you connect the audio using the **AV IN AUDIO L/R** jacks, the audio output is analog.

- 5 Plug your TV's power cord into a power outlet, turn on your TV, then turn on the cable or satellite box.
- 6 Go through the Setup Wizard on page [20](#).

Using composite video (good)

To connect a cable or satellite box using composite video:

- 1 Make sure that your TV's power cord is unplugged, and all connected equipment is turned off.
- 2 Connect the incoming cable from the cable wall jack to the cable-in jack on the cable or satellite box.
- 3 Connect an AV cable (not provided) to the **Y/VIDEO** jack and **AV IN AUDIO L/R** jacks on the back of your TV and to the composite video and audio out jacks on the cable or satellite box.

Note

- The **Y/VIDEO**, **Pb**, and **Pr** video jacks (used to connect a component device) share **AV IN AUDIO L/R** jacks with the **Y/VIDEO** jack (used to connect a composite device).
- When you connect the audio using the **AV IN AUDIO L/R** jacks, the audio output is analog.

Cables are often color-coded to match color-coded jacks.

Note: The yellow video connector on the AV cable connects to the green **Y/VIDEO** jack.

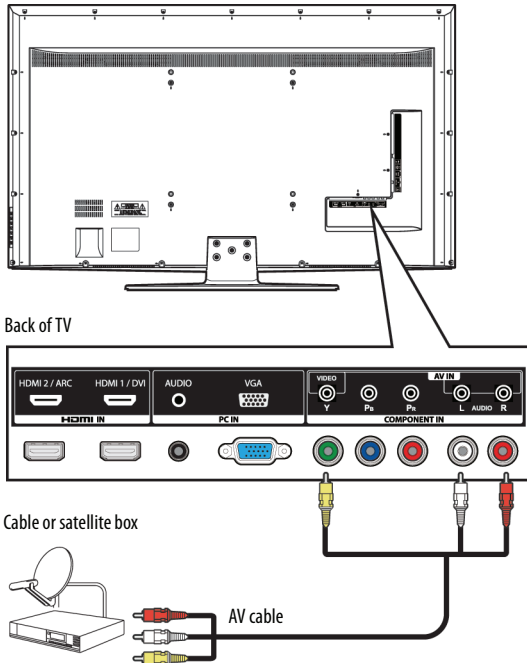

- 4 Plug your TV's power cord into a power outlet, turn on your TV, then turn on the cable or satellite box.
- 5 Go through the Setup Wizard on page [20](#).

Using coaxial (good)

To connect a cable or satellite box using coaxial:

- 1 Make sure that your TV's power cord is unplugged, and all connected equipment is turned off.
- 2 Connect the incoming cable from the cable wall jack to the cable-in jack on the cable or satellite box.
- 3 Connect a coaxial cable (not provided) to the **TV IN ANT/CABLE** jack on the side of your TV and to the coaxial out jack on the cable or satellite box.

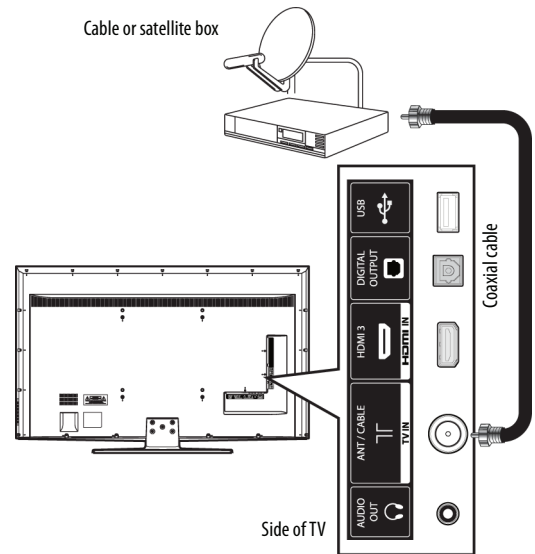

- 4 Plug your TV's power cord into a power outlet, turn on your TV, then turn on the cable or satellite box.
- 5 Go through the Setup Wizard on page [20](#).

Notes

- Use a coaxial cable to eliminate interference and noise from radio waves.
- Do not bundle the coaxial cable with the power cord or other cables.

Connecting an antenna or cable TV (no box)

To connect an antenna or cable TV (no box):

- 1 Make sure that your TV's power cord is unplugged, and all connected equipment is turned off.
- 2 Connect a coaxial cable (not provided) to the **TV IN ANT/CABLE** jack on the side of your TV and to the antenna or cable TV wall jack.

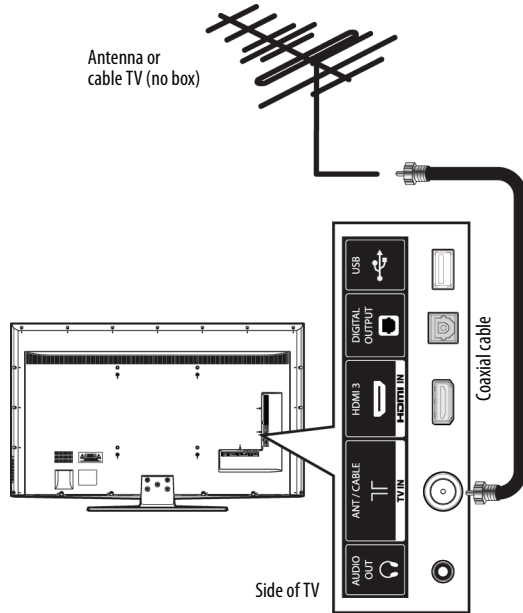

- 3 Plug your TV's power cord into a power outlet, then turn on your TV.
- 4 Go through the Setup Wizard on page 20.

Notes

- Use a coaxial cable to eliminate interference and noise from radio waves.
- Do not bundle the coaxial cable with the power cord or other cables.
- If the antenna is not installed correctly, contact qualified service personnel to correct the problem.
- If the signal level for a channel is weak, the picture may be distorted. Adjust the antenna or use a highly directional outdoor or set-top antenna with a built-in amplifier.
- If the picture quality is good on some channels and poor on others, the problem may be caused by a poor or weak signal from the broadcaster or cable TV provider.
- If you connect to cable or satellite TV without a set-top box and experience poor picture quality, you may need to install a set-top box to improve signal reception and picture quality. Contact your cable or satellite TV provider about upgrading to a set-top box.
- Many high-definition (HD) channels upscale standard-definition (SD) content. The picture displayed on your TV is still displayed as SD, thus the picture quality will not be as clear or crisp as it would be if the content was originally recorded in HD.

Connecting a DVD or Blu-ray player

Using HDMI (best)

To connect a DVD or Blu-ray player using HDMI:

- 1 Make sure that your TV's power cord is unplugged and the DVD or Blu-ray player is turned off.
- 2 Connect an HDMI cable (not provided) to the **HDMI** jack on the side or back of your TV and to the **HDMI OUT** jack on the DVD or Blu-ray player.

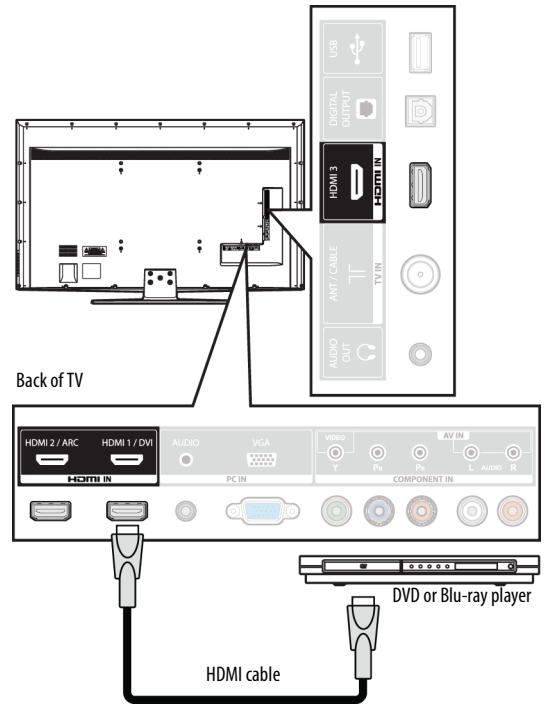

- 3 Plug your TV's power cord into a power outlet, then turn on your TV.
- 4 Turn on the DVD or Blu-ray player, then set it to the correct output mode. For more information, see the documentation that came with the player.
- 5 Press **INPUT** to open the **INPUT SOURCE** list.
- 6 Press **▲** or **▼** to highlight **HDMI1**, **HDMI2**, or **HDMI3**, then press **ENTER**.

Note

You can also press **HDMI** repeatedly to select the DVD or Blu-ray player.

Using DVI (same as HDMI but requires a sound connection)

Note

You must use the **HDMI 1 (DVI)** jack to connect a DVD or Blu-ray player using DVI. If you use another HDMI jack, you will not hear sound from the TV speakers.

To connect a DVD or Blu-ray player using DVI:

- 1 Make sure that your TV's power cord is unplugged and the DVD or Blu-ray player is turned off.
- 2 Connect an HDMI-DVI adapter (not provided) to one end of an HDMI cable (not provided), then connect the adapter to the **DVI OUT** jack on the DVD or Blu-ray player.
- 3 Connect the other end of the cable to the **HDMI1(DVI)** jack on the back of your TV.

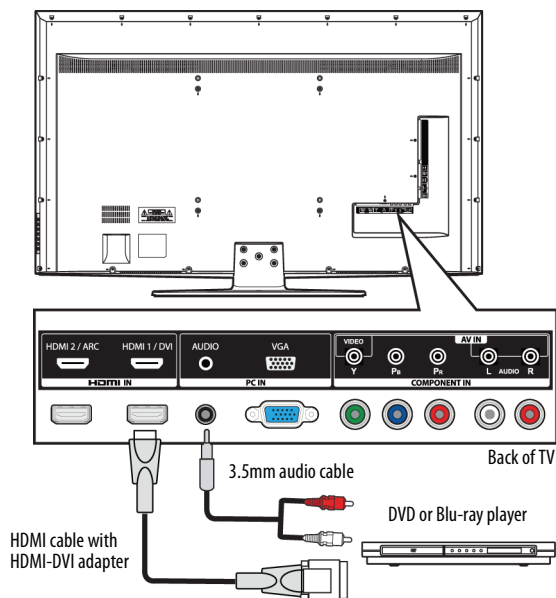

- 4 Connect a 3.5mm audio cable (not provided) to the **PC IN AUDIO** jack on the back of your TV and to the **AUDIO OUT** jacks on the DVD or Blu-ray player.
- 5 Plug your TV's power cord into a power outlet, then turn on your TV.
- 6 Turn on the DVD or Blu-ray player, then set it to the correct output mode. For more information, see the documentation that came with the player.
- 7 Press **INPUT** to open the **INPUT SOURCE** list.
- 8 Press **▲** or **▼** to select **HDMI1**, then press **ENTER**.

Note

You can also press **HDMI** one or more times to select the DVD or Blu-ray player.

Using component video (better)

To connect a DVD or Blu-ray player using component video:

- 1 Make sure that your TV's power cord is unplugged and the DVD or Blu-ray player is turned off.
- 2 Connect a component video cable (not provided) to the **Y/VIDEO**, **Pb**, and **Pr** jacks on the back of your TV and to the **COMPONENT OUT** jacks on the component video device.

Cables are often color-coded to match color-coded jacks.

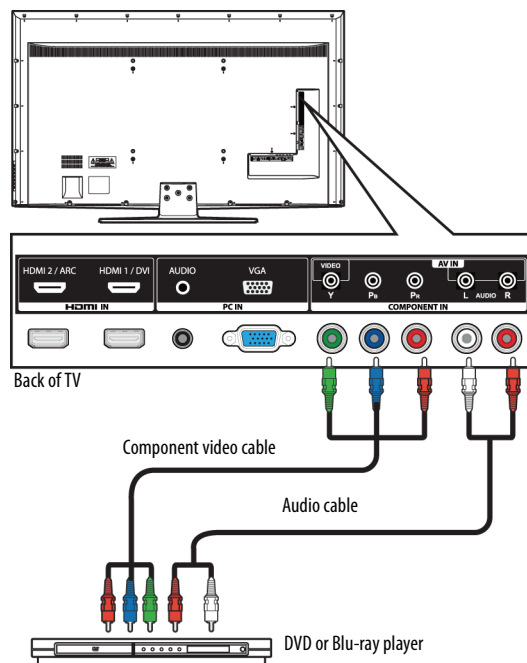

- 3 Connect an audio cable (not provided) to the **AV IN AUDIO L/R** jacks on the back of your TV and to the **L/R AUDIO OUT** jacks on the DVD or Blu-ray player.

Notes

- The **Y/VIDEO**, **Pb**, and **Pr** video jacks (used to connect a component device) share the **AV IN AUDIO L/R** jacks with the **Y/VIDEO** jack (used to connect a composite device).
- When you connect the audio using the **AV IN AUDIO L/R** jacks, the audio output is analog.

- 4 Plug your TV's power cord into a power outlet, then turn on your TV.
- 5 Turn on the DVD or Blu-ray player, then set it to the correct output mode. For more information, see the documentation that came with the player.
- 6 Press **INPUT** to open the **INPUT SOURCE** list.
- 7 Press **▲** or **▼** to select **Component**, then press **ENTER**.

Using composite video (good)

To connect a DVD or Blu-ray player using composite video:

- 1 Make sure that your TV's power cord is unplugged and the DVD or Blu-ray player is turned off.
- 2 Connect an AV cable (not provided) to the **Y/VIDEO** jack and **AV IN AUDIO L/R** jacks on the back of your TV and to the **AV OUT** jacks on the DVD or Blu-ray player.

Note

- The **Y/VIDEO**, **Pb**, and **Pr** video jacks (used to connect a component device) share the **AV IN AUDIO L/R** jacks with the **Y/VIDEO** jack (used to connect a composite device).
- When you connect the audio using the **AV IN AUDIO L/R** jacks, the audio output is analog.

Cables are often color-coded to match color-coded jacks.

Note: The yellow video connector on the AV cable connects to the green **Y/VIDEO** jack.

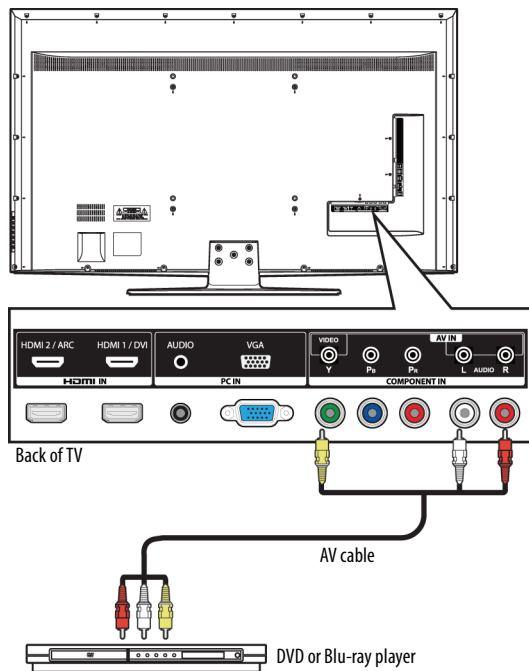

- 3 Plug your TV's power cord into a power outlet, then turn on your TV.
- 4 Turn on the DVD or Blu-ray player, then set it to the correct output mode. For more information, see the documentation that came with the player.
- 5 Press **INPUT** to open the **INPUT SOURCE** list.
- 6 Press **▲** or **▼** to select **AV**, then press **ENTER**.

Notes

You can also press **VIDEO** to select the DVD or Blu-ray player.

Connecting a VCR

To connect a VCR:

- 1 Make sure that your TV's power cord is unplugged and the VCR is turned off.
- 2 Connect an AV cable (not provided) to the **Y/VIDEO** jack and **AV IN AUDIO L/R** jacks on the back of your TV and to the **AV OUT** jacks on the VCR.

Note

- The **Y/VIDEO**, **Pb**, and **Pr** video jacks (used to connect a component device) share the **AV IN AUDIO L/R** jacks with the **Y/VIDEO** jack (used to connect a composite device).
- When you connect the audio using the **AV IN AUDIO L/R** jacks, the audio output is analog.

Cables are often color-coded to match color-coded jacks.

Note: The yellow video connector on the AV cable connects to the green **Y/VIDEO** jack.

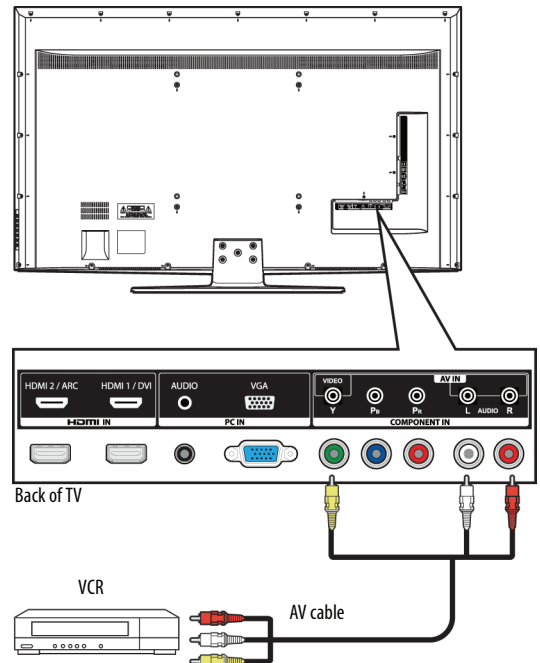

- 3 Plug your TV's power cord into a power outlet, then turn on your TV and the VCR.
- 4 Press **INPUT** to open the **INPUT SOURCE** list.
- 5 Press **▲** or **▼** to select **AV**, then press **ENTER**.

Note

You can also press **VIDEO** to select the VCR.

Connecting a camcorder or game console

Note

If your camcorder or game console has an HDMI connection, we recommend that you use the HDMI connection to get the best quality possible.

To connect a camcorder or game console:

- 1 Make sure that your TV's power cord is unplugged and the camcorder or game console is turned off.
- 2 Connect an AV cable (not provided) to the **Y/VIDEO** jack and **AV IN AUDIO L/R** jacks on the back of your TV and to the **AV OUT** jacks on the camcorder or game console.

Note

- The **Y/VIDEO**, **Pb**, and **Pr** video jacks (used to connect a component device) share the **AV IN AUDIO L/R** jacks with the **Y/VIDEO** jack (used to connect a composite device).
- When you connect the audio using the **AV IN AUDIO L/R** jacks, the audio output is analog.

Cables are often color-coded to match color-coded jacks.

Note: The yellow video connector on the AV cable connects to the green **Y/VIDEO** jack.

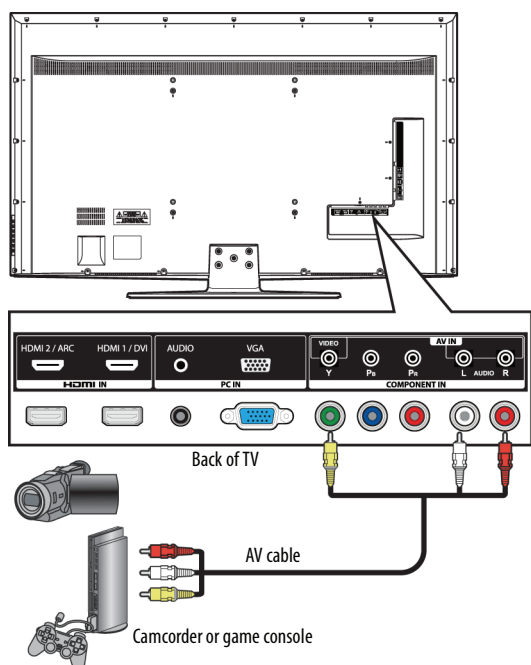

- 3 Plug your TV's power cord into a power outlet, then turn on your TV.
- 4 Turn on the camcorder or game console, then set it to the correct output mode. For more information, see the documentation that came with the camcorder or game console.
- 5 Press **INPUT** to open the *INPUT SOURCE* list.
- 6 Press **▲** or **▼** to select **AV**, then press **ENTER**.

Notes

You can also press **VIDEO** to select the camcorder or game console.

Connecting a computer

Using VGA

To connect a computer using VGA:

- 1 Make sure that your TV's power cord is unplugged and the computer is turned off.
- 2 Connect a VGA cable (not provided) to the **PC IN VGA** jack on the back of your TV and to the **VGA** jack on the computer.

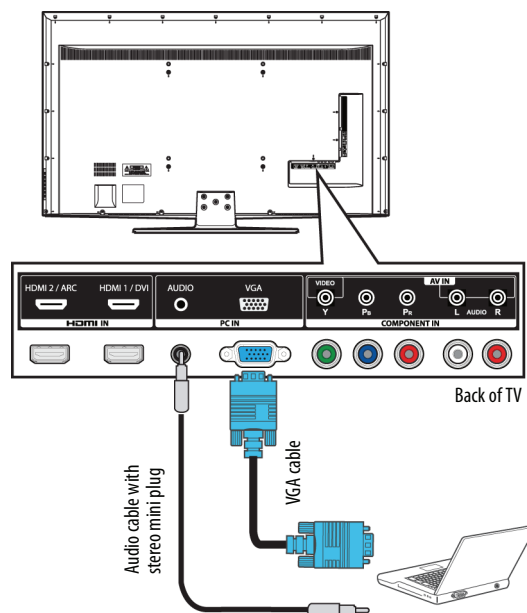

- 3 Connect an audio cable with a stereo mini plug (not provided) to the **PC IN AUDIO** jack on the back of your TV and to the **AUDIO OUT** jack on the computer.
- 4 Plug your TV's power cord into a power outlet, then turn on your TV and the computer.
- 5 Press **INPUT** to open the *INPUT SOURCE* list.
- 6 Press **▲** or **▼** to select **VGA**, then press **ENTER**.
- 7 Adjust the display properties on the computer, if necessary.

Using HDMI

To connect a computer using HDMI:

- 1 Make sure that your TV's power cord is unplugged and the computer is turned off.
- 2 Connect an HDMI cable (not provided) to the **HDMI** jack on the side or back of your TV and to the **HDMI OUT** jack on the computer.

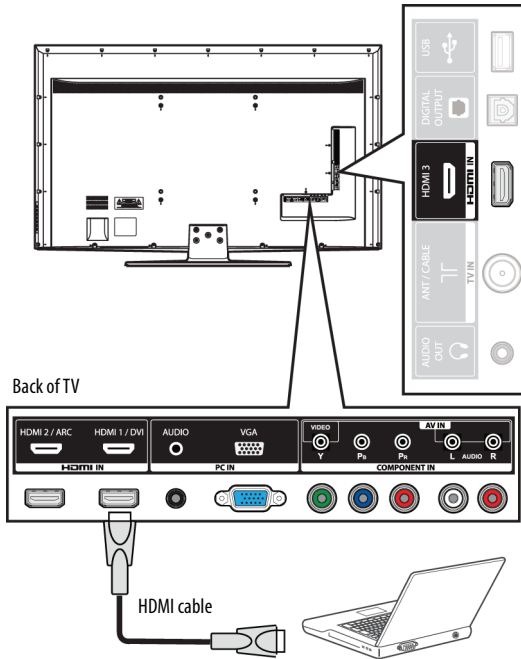

- 3 Plug your TV's power cord into a power outlet, then turn on your TV and the computer.
- 4 Press **INPUT** to open the *INPUT SOURCE* list.
- 5 Press **▲** or **▼** to highlight **HDMI1**, **HDMI2**, or **HDMI3**, then press **ENTER**.

Note

You can also press **HDMI** repeatedly to select the computer.

- 6 Adjust the display properties on the computer, if necessary.

Connecting a USB flash drive

To connect a USB flash drive:

- 1 Plug a USB flash drive into the **USB** port on the side of your TV.

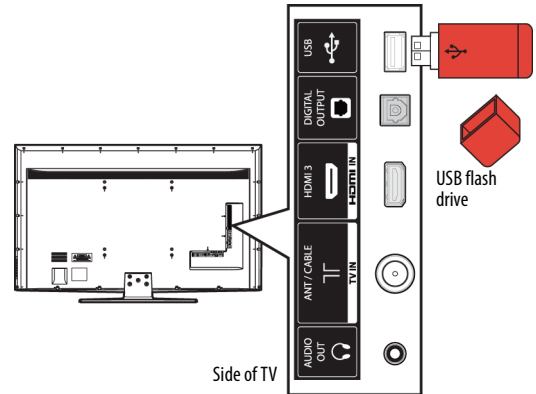

Caution

Do not remove the USB flash drive or turn off the TV while using the USB flash drive. You may lose data or damage the USB flash drive.

- 2 Turn on your TV.
- 3 Press **INPUT** to open the *INPUT SOURCE* list.
- 4 Press **▲** or **▼** to select **USB(Photos)**, then press **ENTER**.

Note

The **Photos** viewer only supports JPEG format images (with "jpg" file extensions) and not all JPEG files are compatible with your TV.

For more information, see "[Using a USB flash drive](#)" on page 48.

Connecting headphones

When you connect headphones, audio plays through the headphones and the TV speakers are muted. See "[Adjusting sound settings](#)" on page 29.

Warning

Loud noise can damage your hearing. When using headphones, use the lowest volume setting on your headphones that still lets you hear the sound.

To connect headphones:

- Connect the headphones to the /AUDIO OUT jack on the side of your TV.

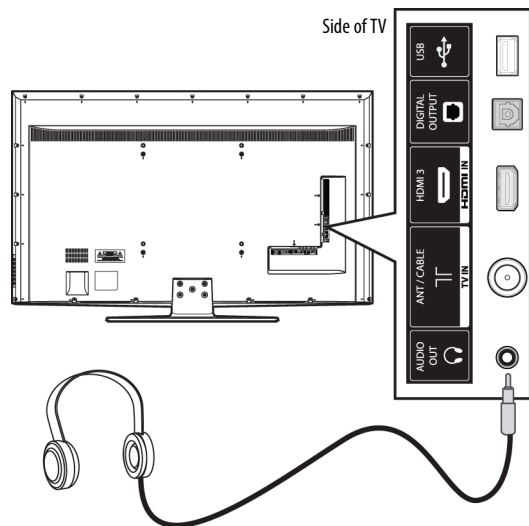

Note

You can also connect an amplifier, home theater system, or sound bar to the /AUDIO OUT jack. If you want to connect an amplifier, home theater system, or sound bar, you need to disconnect the headphones.

Connecting a basic home theater system

Using digital audio

To connect a basic home theater system using digital audio:

- 1 Make sure that your TV's power cord is unplugged and the home theater system is turned off.
- 2 Connect a digital optical audio cable (not provided) to the **DIGITAL OUTPUT** jack on the side of your TV and to the optical **AUDIO IN** jack on the digital home theater system.

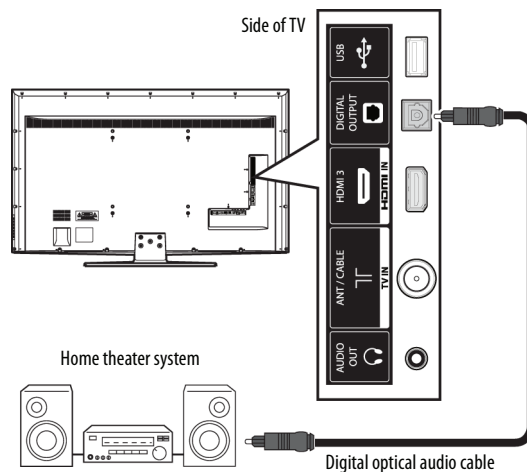

Using analog audio

To connect a home theater system using analog audio:

- 1 Make sure that your TV's power cord is unplugged and the home theater system is turned off.
- 2 Connect a 3.5mm audio cable (not provided) to the **AUDIO OUT** jack on the side of your TV and to the **AUDIO IN** jacks on the analog home theater system.

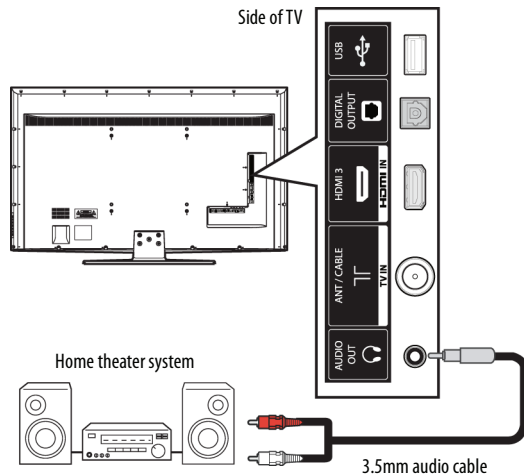

Note

You can connect headphones, an amplifier, a home theater system, or a sound bar to the **AUDIO OUT** jack. If you want to use headphones, you need to disconnect the amplifier, home theater system, or sound bar.

Connecting a home theater system with multiple devices

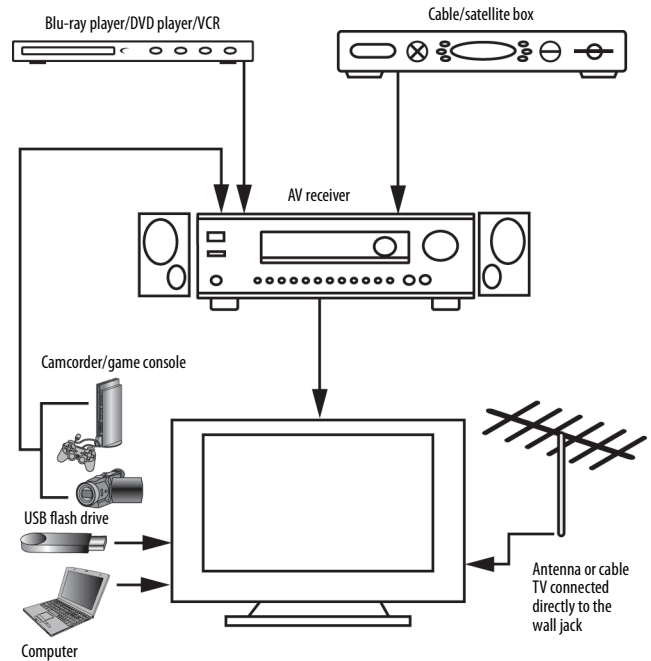

The connections you make depend on the video and audio jacks available on your devices. Refer to the documentation that came with your devices for connection information.

Just remember to use the best connection types available for the best picture and sound. For information about connection types, see "[What connection should I use?](#)" on page 9.

Using the remote control

Installing remote control batteries

To install remote control batteries:

- 1 While pressing the release latch on the back of the remote control, lift the battery compartment cover off the remote control.

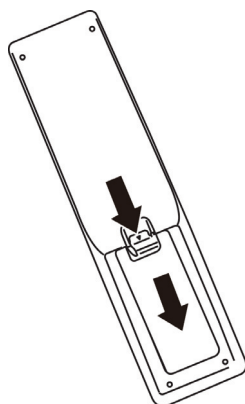

- 2 Insert two AAA batteries into the battery compartment. Make sure that you match the + and - symbols on the batteries with the + and - symbols in the battery compartment.

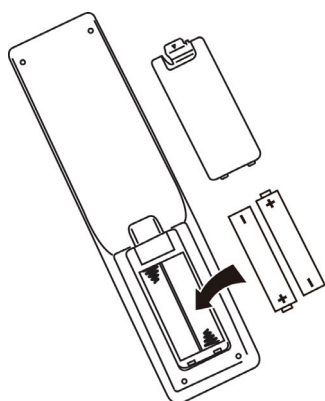

- 3 Replace the battery compartment cover.

Cautions

- Batteries should not be exposed to excessive heat, such as sunshine, heat registers, or fire.
- Battery chemicals can cause a rash. If the batteries leak, clean the battery compartment with a cloth. If chemicals touch your skin, wash immediately.
- Make sure that batteries are disposed of correctly. Do not burn or incinerate.

Notes

- Do not mix batteries of different types.
- Do not mix old and new batteries.
- Remove batteries when the charge is depleted.
- If the remote control is not going to be used for an extended period of time, remove the batteries.

Aiming the remote control

To aim the remote control:

- Point the remote control towards the remote sensor on the front of your TV.

Turning on your TV for the first time

The first time you turn on your TV, the Setup Wizard opens. The Setup Wizard guides you through setting up basic settings including the menu language, time setting, picture mode, TV signal source, and the channel list.

To set up your TV:

- 1 Make sure that you have:
 - Installed the remote control batteries. (See page [20](#) for details.)
 - Connected an antenna, cable TV, or satellite TV. (See page [10](#) through [13](#) for details.)
 - Connected the power cord. (See page [10](#) for details.)
- 2 Press **⏻** (power) to turn on your TV. The *Choose Your Menu Language* screen opens.



- 3 Press **▲** or **▼** to highlight the language you want, then press **ENTER**. The *Choose Your Time Setting* screen opens.

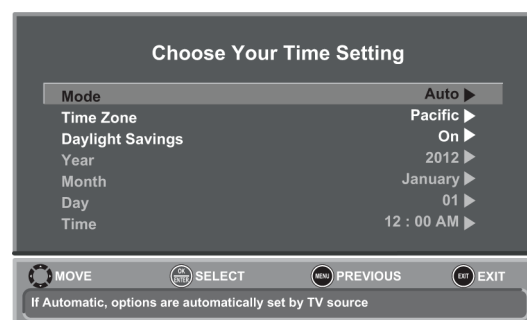

- 4 Press **▲** or **▼** to highlight **Mode**, then press **◀** or **▶** to select **Manual** (to set the date and time manually) or **Auto** (to set the date and time automatically from a TV signal source based on the time zone you select).

Note

If you select **Auto**, the displayed time will be incorrect until your TV gets the correct time from a TV signal source.

- 5 Press **▲** or **▼** to highlight **Time Zone**, then press **◀** or **▶** to select your time zone. You can select **Eastern, Central, Mountain, Pacific, Alaska, Hawaii, Newfoundland, or Atlantic**.
- 6 Press **▲** or **▼** to highlight **Daylight Savings**, then press **◀** or **▶** to select **On** (if your viewing area observes Daylight Savings Time) or **Off** (if your viewing area does not observe Daylight Savings Time).
- 7 If you selected **Manual for Mode**, set the date by pressing **▲** or **▼** to highlight **Year, Month, or Day**, then pressing **◀** or **▶** to adjust the setting.
- 8 If you selected **Manual for Mode**, set the time by pressing **▲** or **▼** to highlight **Time**, then pressing **◀** or **▶** to select the hour, minute, or AM/PM field. Press **▲** or **▼** to adjust the setting.
- 9 Press **ENTER**. The *Choose Your Picture Mode* screen opens.

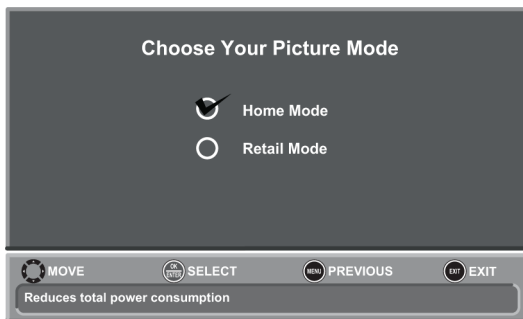

- 10 Press **▲** or **▼** to highlight **Home Mode** or **Retail Mode**, then press **ENTER**.

If you selected **Retail Mode**, a message asks you to confirm your selection. **Retail Mode** is not an energy savings mode. Select **Yes** to continue using **Retail Mode**, or select **No** to change your selection, then press **ENTER**.

The *Choose Your TV Source* screen opens.

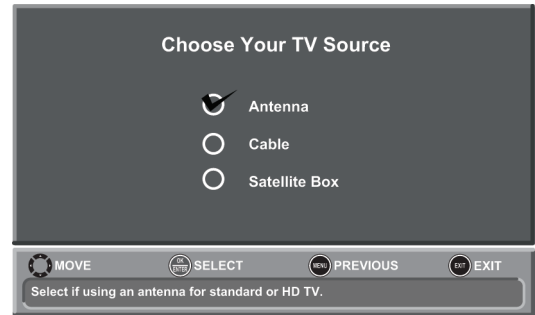

- 11 Press **▲** or **▼** to highlight **Antenna, Cable, or Satellite Box**, then press **ENTER**.

- A If you select **Antenna**, your TV scans for available channels. The scan may take several minutes.



During scanning, your TV searches for digital channels first. When the digital channel search is complete, a message appears asking if you want to search for analog channels. Select **Yes** to continue searching for analog channels, or select **No** to stop searching for channels.

Note

You can press **EXIT** to stop the auto channel search, but you will need to run the auto channel search again to create a channel list.

B If you select **Cable**, a message asks if you have a cable box:

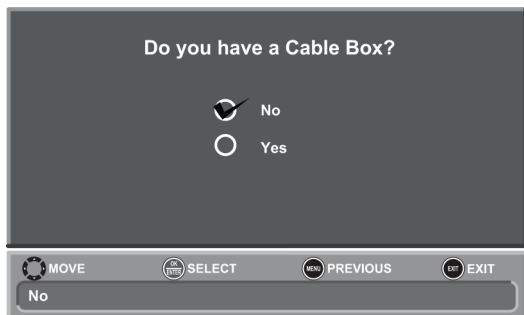

- Select **No**, then press **ENTER** if no cable box is connected. Your TV scans for available channels. The scan may take several minutes.
- Select **Yes**, then press **ENTER** if a cable box is connected. A message asks how you connected the cable box to your TV.

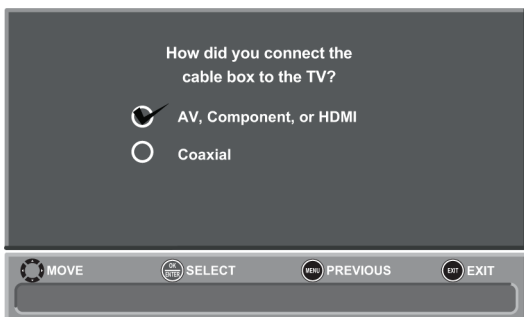

- Select **AV, Component, or HDMI**, then press **ENTER** if you connected a cable box to your TV using one of these cables. Read the message, then press **ENTER** to close the wizard.
- Select **Coaxial**, then press **ENTER** if you connected a cable box to your TV using a coaxial cable. Read the message, then press **ENTER** to start the channel scan (VHF channels only).

Note

You can press **EXIT** to stop the auto channel search, but you will need to run the auto channel search again to create a channel list.

C If you select **Satellite Box**, a message asks how you connected the satellite box to your TV:

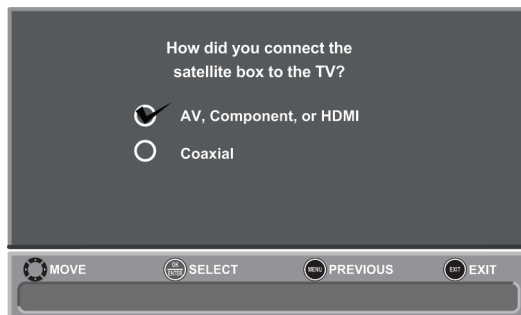

- Select **AV, Component, or HDMI**, then press **ENTER** if you connected a satellite box to your TV using one of these cables. Read the message, then press **ENTER** to close the wizard.
- Select **Coaxial**, then press **ENTER** if you connected a satellite box to your TV using a coaxial cable. Read the message, then press **ENTER** to start the channel scan (VHF channels only).

Note

You can press **EXIT** to stop the auto channel search, but you will need to run the auto channel search again to create a channel list.

- 12 To watch TV, press **INPUT**, press **▲** or **▼** to highlight the video input source for your TV in the *INPUT SOURCE* list, then press **ENTER**.
 - If your TV is connected to an antenna, cable TV (no box), or cable or satellite TV box using a coaxial cable, select **TV**.
 - If your TV is connected to a cable or satellite box using an HDMI cable or HDMI cable with a DVI adapter, select **HDMI1**, **HDMI2**, or **HDMI3**.
 - If your TV is connected to a cable or satellite box using a component video cable, select **Component**.
 - If your TV is connected to a cable or satellite box using a composite video cable, select **AV**.

Understanding the basics

Turning your TV on or off

To turn your TV on or off:

- 1 Make sure that the power cord is connected to your TV and to a power outlet.
- 2 Press **⏻** (power) to turn on your TV. The power indicator turns off.
- 3 Press **⏻** (power) again to turn off your TV. Your TV enters standby mode, and the power indicator turns red.

Warning

When your TV is in standby mode, it is still receiving power. To completely disconnect power, unplug the power cord.

Note

If your TV does not receive an input signal for several minutes, it automatically goes into standby mode.

Selecting the video input source

To select the video input source:

- 1 Turn on your TV, then press **INPUT**. The **INPUT SOURCE** list opens.

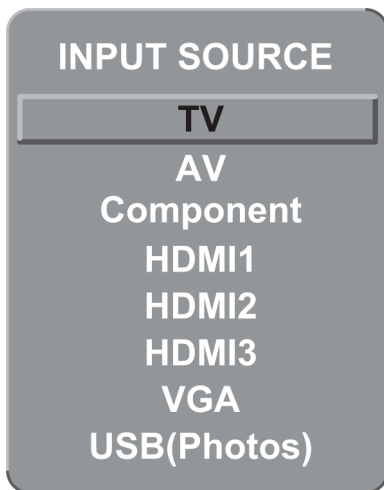

- 2 Press **▲** or **▼** to select a video input source, then press **ENTER**.

You can also press a Quick Launch Input button to select the video input source.

- Press **TV** to select TV (if your TV is connected to an antenna, cable TV (no box), or cable or satellite TV using a coaxial cable).
- Press **VIDEO** to select the composite input.
- Press **HDMI** one or more times to select one of the HDMI inputs.

On-screen menu overview

Notes

- Depending on the signal source selected, you may see different options on your screen. The following menus are shown in TV mode (except the *Photos* menu).
- Menu items that are not selectable are grayed out.
- Menus in this manual are described in TV mode, unless otherwise indicated.
- The screens shown in this manual are for explanation purposes and may vary from the actual screens on your TV.

Picture menu (TV mode)

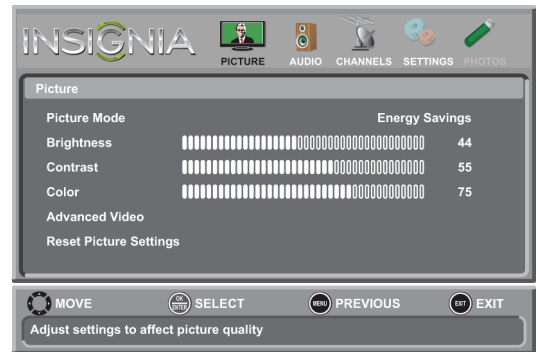

Audio menu (TV mode)



Channels menu (TV mode)



Settings menu (TV mode)



Photos menu (USB mode)



Navigating the menus

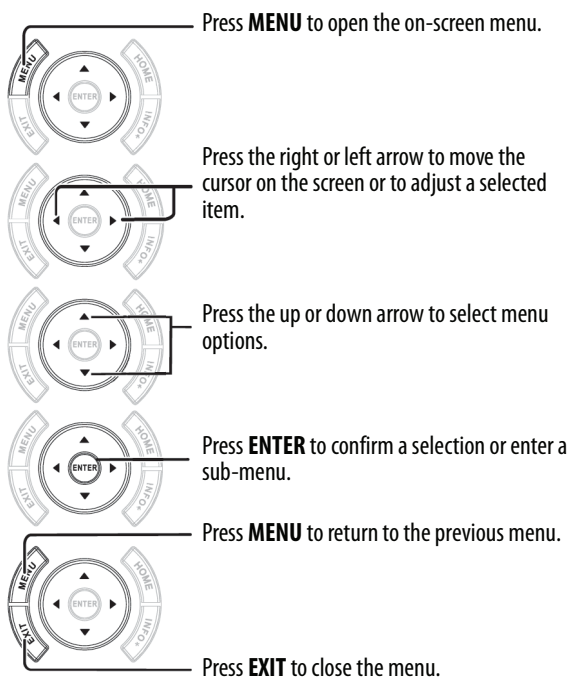

Selecting a channel

To select a channel:

- Press **CH** \wedge or **CH** \vee to go to the next or previous channel on the memorized channel list.
- Press the number buttons to enter the analog or main digital channel number you want, then wait for the channel to change or press **ENTER** to immediately change the channel.
- To select a digital sub-channel, press the number buttons to select the main digital channel, press **.** (dot), then press the number button for the sub-channel. Wait for the channel to change, or press **ENTER** to immediately change the channel. For example, to tune to channel 5.1, press **5**, **.** (dot), then **1**.

Note

Button presses must be within three seconds of each other.

- Press **○** (return) to go to the last viewed channel.
- Press **CH-LIST** to open the channel list, press \blacktriangle or \blacktriangledown to highlight a channel, then press **ENTER**. Hidden channels are grayed and cannot be selected. See "[Hiding channels](#)" on page 31.
- Press **FAVORITE** to open the favorite channel list, press \blacktriangle or \blacktriangledown to highlight a channel, then press **ENTER**.

Note

If a list has more than one page, press \blacktriangle OR \blacktriangledown to scroll through the pages.

Adjusting the volume

To adjust the volume:

- Press **VOL+** or **VOL-** to increase or decrease the volume.
- Press **MUTE** to turn off the sound. Press **MUTE** again to turn the sound back on.

Viewing channel information

To view channel information:

- Press **INFO** to view an information banner. The information banner shows the current program information such as channel number, video input source, and resolution.
 - Digital channel information—Displays the channel number, station name, channel label, broadcast program name, TV rating, signal strength, audio information, resolution, CC mode, current time, and current program start and end times.
 - Analog channel information—Displays channel number, channel label (if present), signal type, audio information, and resolution.

Viewing system information

To view system information:

- 1 Press **MENU**. The on-screen menu opens.

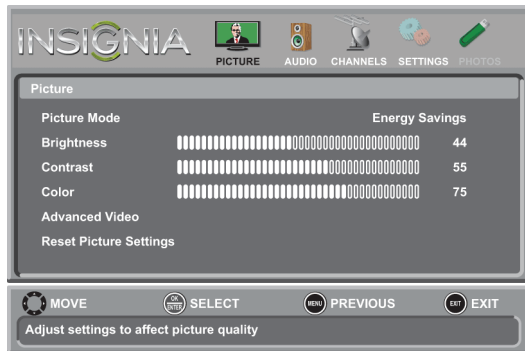

- 2 Press **◀** or **▶** to highlight **SETTINGS**, then press **▼** or **ENTER**. The *Settings* menu opens.



- 3 Press **▲** or **▼** to highlight **System Info**, then press **ENTER**. Information about the TV software version is displayed.
- 4 Press **MENU** to return to the previous menu, or press **EXIT** to close the menu.

Adjusting the picture

Adjusting the TV picture

To adjust the TV picture:

- 1 Press **MENU**. The on-screen menu opens with the *Picture* menu displayed.

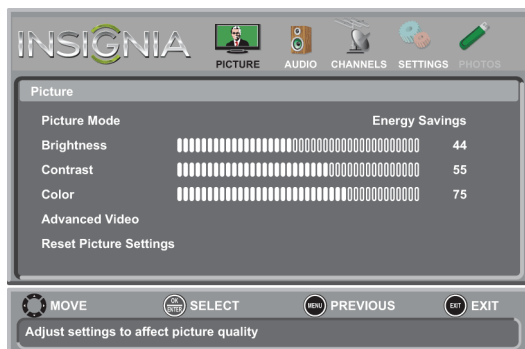

- 2 Press **▼** or **ENTER** to access the menu.

- 3 Press **▲** or **▼** to highlight an option, then press **ENTER** to access the option. You can select:

- **Picture Mode**—Selects the picture mode. You can select:
 - **Vivid**—(a bright and vivid picture). Significantly increases the contrast, brightness, and sharpness. This selection is good for video games, animation, and in bright light environments.
 - **Standard**—(a standard picture). Moderately increases the contrast, brightness, and sharpness. This selection is good for standard TV broadcasts.
 - **Energy Savings**—(the backlight brightness is decreased). Your TV has a backlight that provides light for displaying a picture. By reducing the amount of light, your TV uses less energy.
 - **Theater**—(a finely detailed picture). Adjusts the brightness and contrast and lowers the sharpness for a more realistic picture. This selection is good for watching the highest quality video such as Blu-ray Discs, DVDs, and HDTV.
 - **Game**—Adjusts the picture for the ultimate gaming experience.
 - **Custom**—(customized picture). Lets you manually adjust picture settings such as brightness, contrast, and sharpness.

Note

You can also press **PICTURE** to select the picture mode.

- **Brightness**—Adjusts the brightness of the dark areas of the picture.
- **Contrast**—Adjusts the brightness of the light areas of the picture.
- **Color**—Adjusts the color intensity of the picture. A low setting may make the color look faded. A high setting may make the color look artificial.
- **Advanced Video**—Opens the *Picture-Advanced Video* menu where you can adjust additional video options.



- **Dynamic Backlight (DCR)**—Enhances the contrast ratio between light and dark areas of the picture. You can select **Off**, **Low**, or **High**.

- **Backlight**—Sets the overall brilliance of the screen.
- **Insignia Motion 120Hz**—Eliminates motion blur with clear detail and smooth motion. You can select:
 - **Off**—Turns off Insignia Motion 120Hz.
 - **Low**—Sets the effect to minimum.
 - **Middle**—Provides smooth and clear picture motion for normal use.
 - **High**—Eliminates motion blur with clear detail and smooth motion.
 - **24p Film Mode**—Provides smooth and clear picture motion from film based video.
- **Aspect Ratio**—Selects the aspect ratio of the picture.

- **Sharpness**—Adjusts the color detail of images. If you set this control too high, dark images may appear with light or white edges.
 - **Adaptive Contrast**—Automatically adjusts picture detail and brightness. You can select **On** or **Off**.
 - **Reset Picture Settings**—Resets all picture settings to factory mode.
- 4 Press ◀ or ▶ to adjust the option, or press ▲ or ▼ to select a setting.
 - 5 Press **MENU** to return to the previous menu, or press **EXIT** to close the menu.

Adjusting the computer image

To adjust the computer image:

- 1 Make sure that your TV is in VGA mode. For more information, see “[Selecting the video input source](#)” on page 23.
- 2 Press **MENU**. The on-screen menu opens.

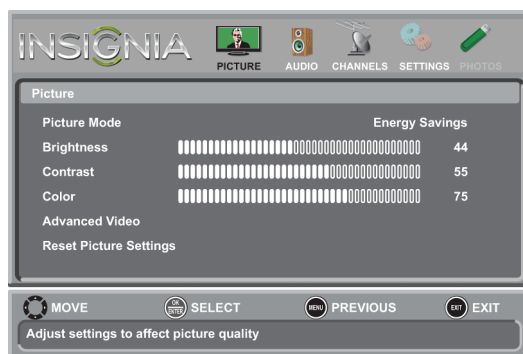

- 3 Press ◀ or ▶ to highlight **SETTINGS**, then press **ENTER**. The *Settings* menu opens.



Aspect ratio options	Example
----------------------	---------

Normal:
Displays the original 4:3 aspect ratio with vertical black bars on the left and right of the image.



Zoom:
Expands the image to fill the screen. The top and bottom of the image may be cropped.



Wide:
Use this option to view content recorded in a 16:9 (wide-screen) aspect ratio.



Cinema:
Stretches the image at the edges, but keeps a clear image in the center.



Auto:
Automatically adjusts the image based on the screen size and the TV program.



Note: **Auto** is only available when **Auto Zoom** in the *Channels* menu is set to **On**.

Note

You can also press **ZOOM** to select the aspect ratio.

- **Color Temperature**—Selects the color temperature. You can select **Cool** (to enhance the blues), **Normal**, or **Warm** (to enhance the reds).
- **Overscan**—Adjusts the picture’s reproduction rate. You can select **On** or **Off**.
- **Noise Reduction**—Selects the noise reduction mode to reduce picture noise (snow). You can select **Low**, **Middle**, **High**, or **Off**.
- **Tint**—Adjusts the color balance of the picture. Use this control to make skin tones look more natural.

- 4 Press **▲** or **▼** to highlight **Computer Settings**, then press **ENTER**. The *Settings - Computer Settings* menu opens.

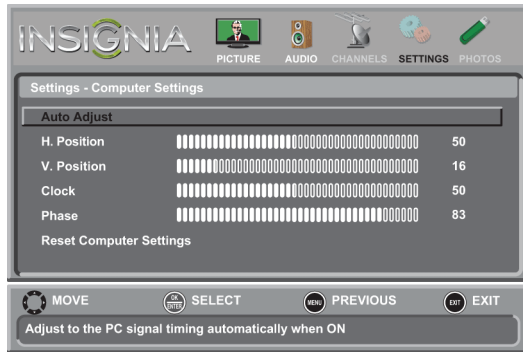

- 5 Press **▲** or **▼** to highlight an option, then press **ENTER** to access the option. You can select:
- **Auto Adjust**—Automatically adjusts the image settings such as position and phase.
 - **H. Position**—Moves the image right or left.
 - **V. Position**—Moves the image up or down.
 - **Clock**—Adjusts the sample frequency.
 - **Phase**—Adjusts the focus of stable images.
 - **Reset Computer Settings**—Resets all computer settings to factory mode.
- 6 Press **◀** or **▶** to adjust the option, or press **▲** or **▼** to select a setting.
- 7 Press **MENU** to return to the previous menu, or press **EXIT** to close the menu.

- 4 Press **◀** or **▶** to highlight **SETTINGS**, then press **ENTER**. The *Settings* menu opens.



- 5 Press **▲** or **▼** to highlight **Component Settings**, then press **ENTER**.
- 6 Press **▲** or **▼** to highlight an option, then press **ENTER** to access the option. You can select:
- **Phase**—Minimizes horizontal distortion.
 - **Reset Component Settings**—Resets all component video settings to factory mode.
- 7 Press **◀** or **▶** to adjust the option, or press **▲** or **▼** to select a setting.
- 8 Press **MENU** to return to the previous menu, or press **EXIT** to close the menu.

Adjusting component video settings

You can adjust the horizontal distortion that may occur when watching video from a component video device.

To adjust component video settings:

- 1 Make sure you have a device connected to the **COMPONENT IN Y/VIDEO**, **PB**, and **PR** jacks on the back of your TV.
- 2 Press **VIDEO** to select the component video device.
- 3 Press **MENU**. The on-screen menu opens.

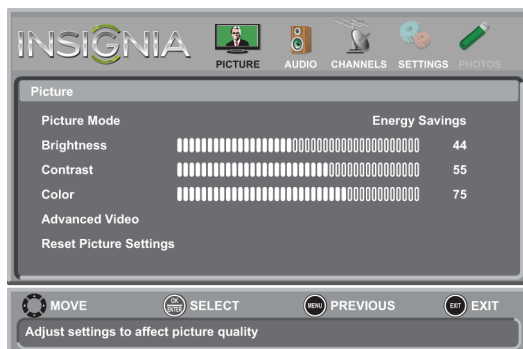

Setting the power on picture mode

You can set the picture mode your TV uses when you turn it on.

To set the power on picture mode:

- 1 Press **MENU**. The on-screen menu opens.

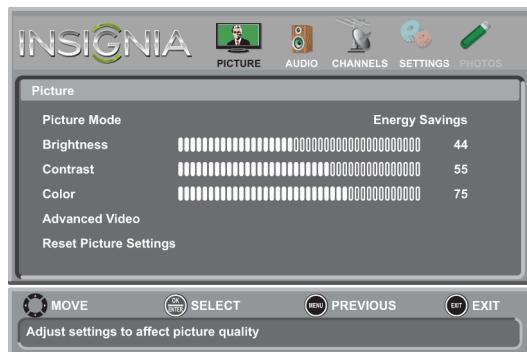

- 2 Press **◀** or **▶** to highlight **SETTINGS**, then press **ENTER**. The *Settings* menu opens.



- 3 Press **▲** or **▼** to highlight **Reset to Default**, then press **ENTER**. The *Settings-Reset to Default* menu opens.
- 4 Press **▲** or **▼** to highlight **Power on in Vivid Mode**, then press **ENTER**.
- 5 Press **▲** or **▼** to highlight **On** (when you turn on your TV, it will be in **Vivid** picture mode) or **Off** (when you turn on your TV, it will be in the picture mode it was in before you reset to defaults), then press **ENTER**.
- 6 Press **MENU** to return to the previous menu, or press **EXIT** to close the menu.

Displaying a banner at power on

If the picture mode is set to **Retail Mode**, your TV can display a retail banner when you turn on your TV.

Note

The picture mode is set during the first time setup. For more information, see "Turning on your TV for the first time" on page 20.

To display a banner at power on:

- 1 Press **MENU**. The on-screen menu opens.

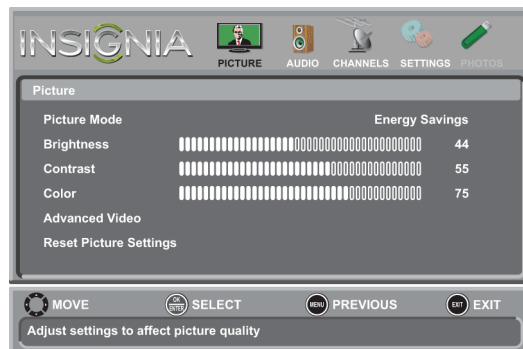

- 2 Press **◀** or **▶** to highlight **SETTINGS**, then press **ENTER**. The *Settings* menu opens.



- 3 Press **▲** or **▼** to highlight **Reset to Default**, then press **ENTER**. The *Settings-Reset to Default* menu opens.
- 4 Press **▲** or **▼** to highlight **Retail Banner**, then press **ENTER**.
- 5 Press **▲** or **▼** to highlight **On** (displays an electronic banner on the screen) or **Off** (does not display an electronic banner), then press **ENTER**.
- 6 Press **MENU** to return to the previous menu, or press **EXIT** to close the menu.

Adjusting the sound

Adjusting sound settings

To adjust sound settings:

- 1 Press **MENU**. The on-screen menu opens.

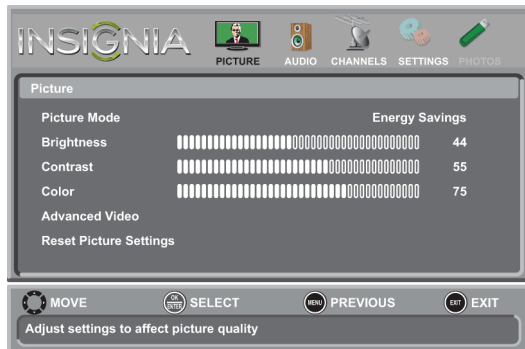

- 2 Press **◀** or **▶** to highlight **AUDIO**, then press **▼** or **ENTER**. The *Audio* menu opens.



- 3 Press **▲** or **▼** to highlight an option, then press **ENTER** to access the option. You can select:

- **Sound Mode**—Selects the sound mode. You can select:
 - **Standard**—Balances treble and bass. This setting is good for watching standard TV broadcasts.
 - **Theater**—Enhances treble and bass for a rich sound experience. This setting is good for watching DVDs, Blu-ray discs, and HDTV.
 - **Music**—Preserves the original sound. This setting is good for listening to music.
 - **News**—Enhances vocals for TV audio. This setting is good for watching news broadcasts.
 - **Custom**—Lets you manually adjust sound settings.
- **Balance**—Adjusts the balance between the left and right audio channels.

- **Advanced Audio**—Opens the *Audio · Advanced Audio* menu where you can adjust additional audio options.



- **Bass**—Adjusts the low sounds.
- **Treble**—Adjusts the high sounds.
- **TV Speakers**—Selects where to play TV audio. You can select **On** (default setting) to play audio through the TV speakers, or select **Off** to turn off the TV speakers and play audio through the speakers on an external audio system.
- **Digital Audio/SPDIF**—Sends digital audio to an external audio system. You can select **PCM** (to output audio in 2-channel stereo), or **RAW** (to pass through the original digital audio sound).
- **MTS/SAP**—(Analog channels only) Selects the audio mode. You can select:
 - **Mono**—Select this option if there is noise or static on weak stereo broadcasts.
 - **Stereo**—Select this option for programs broadcast in stereo.
 - **SAP**—Select this option to listen to a secondary audio program, if available.

Note

You can also press **MTS/SAP** one or more times to select the audio mode.

- **Audio Language**—(Digital channels only) Selects an alternate audio language, if available.
 - **Reset Audio Settings**—Reset all audio settings to factory defaults.
- 4 Press **◀** or **▶** to adjust the option, or press **▲** or **▼** to select a setting.
 - 5 Press **MENU** to return to the previous menu, or press **EXIT** to close the menu.

Playing TV audio only

You can turn off the picture on your TV and listen to the program audio only.

To play TV audio only:

- 1 Press **MENU**. The on-screen menu opens.

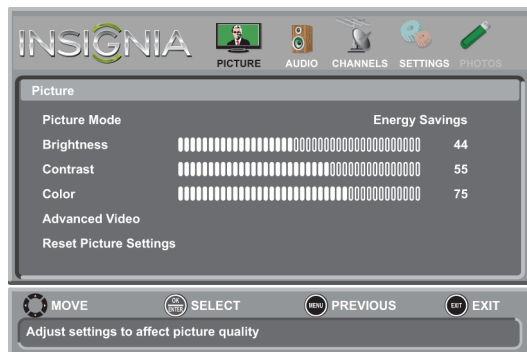

- 2 Press **◀** or **▶** to highlight **CHANNELS**, then press **▼** or **ENTER**. The *Channels* menu opens.



- 3 Press **▲** or **▼** to highlight **Audio Only**, then press **ENTER**.
- 4 Press **▲** or **▼** to select **On**.
- 5 Press **MENU** to return to the previous menu, or press **EXIT** to close the menu.

Notes

- **Audio Only** works only when the input source is TV, and your TV is receiving a broadcast signal.
- To exit audio only mode, press any button. When you exit audio only mode, the **Audio Only** option is automatically reset to **Off**.

Changing channel settings

Automatically scanning for channels

When you scan for channels, your TV searches for channels with signals and stores the channel information in the channel list. When you press **CH ▲** or **CH ▼**, your TV goes to the next or previous channel in the channel list.

If the TV signal source changes, for example you change from an outdoor antenna to cable TV (no box), you need to scan for channels.

To automatically scan for channels:

- 1 Press **MENU**. The on-screen menu opens.

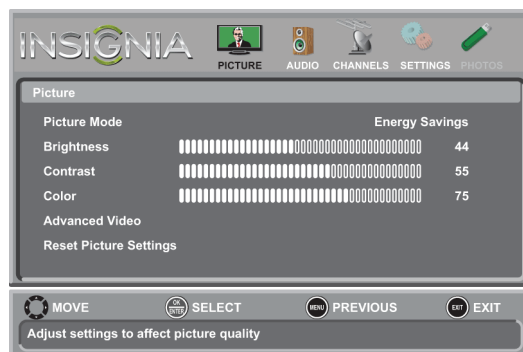

- 2 Press **◀** or **▶** to highlight **CHANNELS**, then press **▼** or **ENTER**. The *Channels* menu opens.



- 3 Press **▲** or **▼** to highlight **Auto Channel Search**, then press **ENTER**. The *Channels · Auto Channel Search* screen opens.

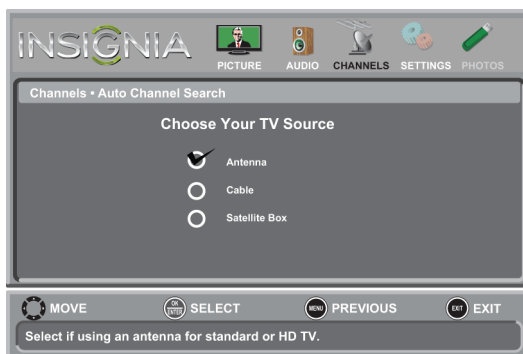

- 4 Press **▲** or **▼** to highlight **Antenna**, **Cable**, or **Satellite Box**, then press **ENTER**.

A If you select **Antenna**, your TV scans for available channels. The scan may take several minutes.

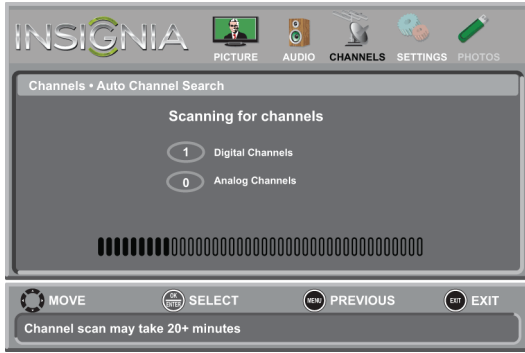

C If you select **Satellite Box**, a message asks how you connected the satellite box to your TV:

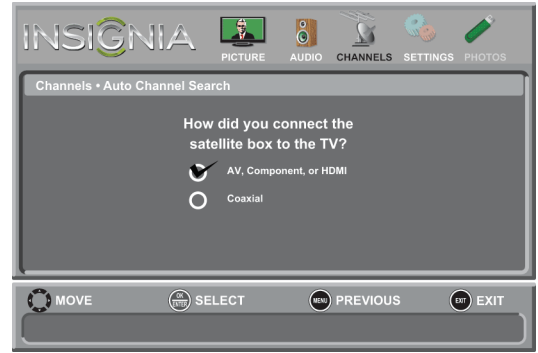

B If you select **Cable**, a message asks if you have a cable box:

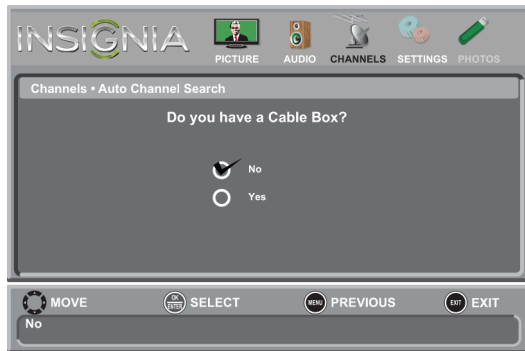

- Select **AV, Component, or HDMI**, then press **ENTER** if you connected a satellite box to your TV using one of these cables. Read the message, then press **ENTER** to close the wizard.
- Select **Coaxial**, then press **ENTER** if you connected a satellite box to your TV using a coaxial cable. Read the message, then press **ENTER** to start the channel scan (VHF channels only).

Note
You can press **EXIT** to stop the auto channel search, but you will need to run the auto channel search again to create a channel list.

- Select **No**, then press **ENTER** if no cable box is connected. Your TV scans for available channels. The scan may take several minutes.
- Select **Yes**, then press **ENTER** if a cable box is connected. A message asks how you connected the cable box to your TV:

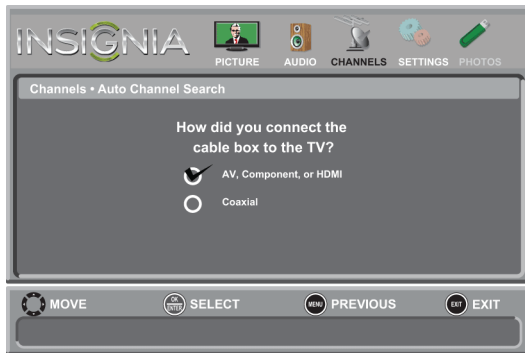

Hiding channels

You can hide channels in the channel list. When you press **CH ^** or **CH v**, your TV skips the hidden channels. You can still tune to a hidden channel by pressing the number buttons for the channel.

To hide channels:

- 1 Press **MENU**. The on-screen menu opens.

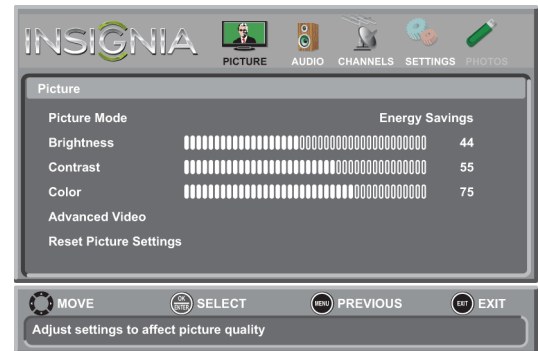

- Select **AV, Component, or HDMI**, then press **ENTER** if you connected a cable box to your TV using one of these cables. Read the message, then press **ENTER** to close the wizard.
- Select **Coaxial**, then press **ENTER** if you connected a cable box to your TV using a coaxial cable. Read the message, then press **ENTER** to start the channel scan (VHF channels only).

- Press **◀** or **▶** to highlight **CHANNELS**, then press **▼** or **ENTER**. The *Channels* menu opens.

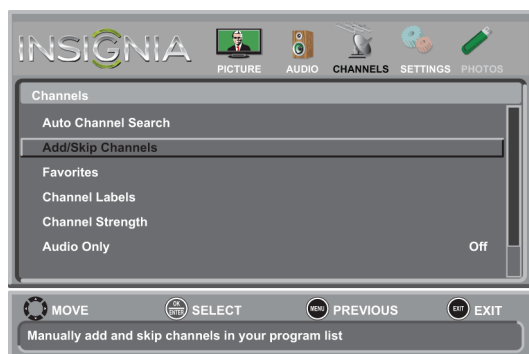

- Press **◀** or **▶** to highlight **CHANNELS**, then press **▼** or **ENTER**. The *Channels* menu opens.



- Press **▲** or **▼** to highlight **Add/Skip Channels**, then press **ENTER**. The *Channels-Add/Skip Channels* screen opens.



- Press **▲** or **▼** to highlight **Favorites**, then press **ENTER**. The *Channels-Favorites* screen opens.



- Press **▲** **▼** **◀** or **▶** to highlight the channel you want to hide, then press **ENTER**. The check mark disappears.

Notes

- A channel with a check mark is not hidden. A channel with no check mark is hidden.
- If the list has more than one page, press **▲** or **▼** to scroll through the pages.

- Press **MENU** to return to the previous menu, or press **EXIT** to close the menu.

Setting up a favorite channel list

You can create a favorite channel list so you can quickly browse through your favorite channels by pressing **FAVORITE**, then selecting a channel from the favorite channel list.

To set up a favorite channel list:

- Press **MENU**. The on-screen menu opens.

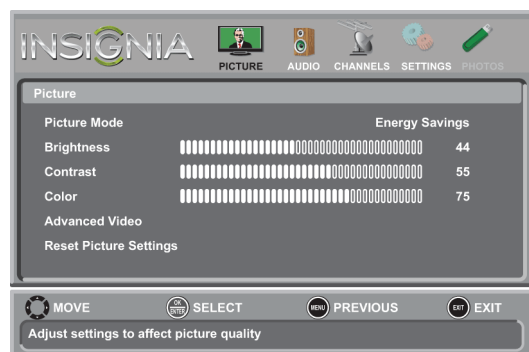

- Press **▲** **▼** **◀** or **▶** to highlight the channel you want to add to the favorites list, then press **ENTER**. A check mark appears next to the channel.

Notes

- To remove a channel from the favorites list, highlight the channel, then press **ENTER**. The check mark disappears and the channel is removed from the list.
- If the list has more than one page, press **▲** or **▼** to scroll through the pages.

- Press **MENU** to return to the previous menu, or press **EXIT** to close the menu.

Viewing a favorite channel

To view a favorite channel:

- Press **FAVORITE**. The favorite channel list opens.
- Press **▲** or **▼** to highlight a channel, then press **ENTER**.

Adding or changing a channel label

If a channel is not already labeled, you can label the channel to make it easier to identify. You can also relabel a channel that is already labeled.

To add or change a channel label:

- 1 Press **MENU**. The on-screen menu opens.

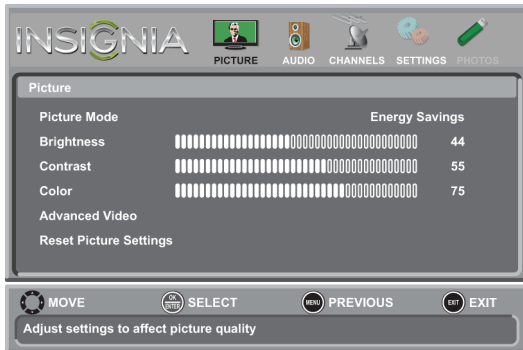

- 2 Press **◀** or **▶** to highlight **CHANNELS**, then press **▼** or **ENTER**. The *Channels* menu opens.

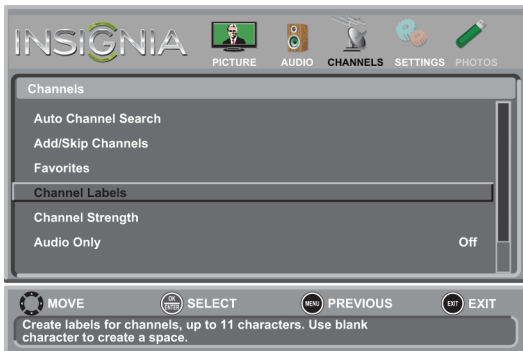

- 3 Press **▲** or **▼** to highlight **Channel Labels**, then press **ENTER**. The *Channels-Channel Labels* screen opens with the channel number field highlighted.



- 4 Press **▲** or **▼** to select the channel you want to label, then press **◀** or **▶** to move to the channel label field.



- 5 Press **▲** or **▼** to highlight a character, then press **◀** or **▶** to move to the previous or next character position. You can enter as many as 11 characters.
- 6 When you have completed the label, press **MENU**.
- 7 Press **EXIT** to close the menu.

Checking the digital signal strength

You can check the digital signal strength to determine if you need to adjust your antenna or digital cable input. The higher the signal strength, the less likely you are to experience picture degradation.

To check the digital signal strength:

- 1 Press **MENU**. The on-screen menu opens.

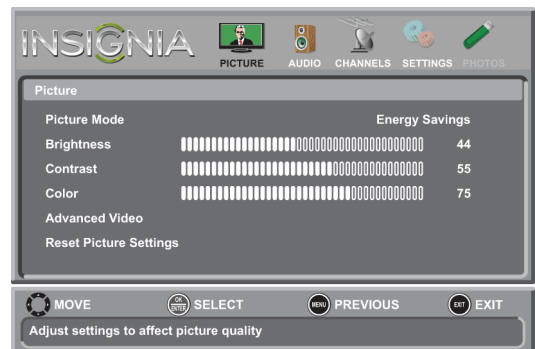

- 2 Press **◀** or **▶** to highlight **CHANNELS**, then press **▼** or **ENTER**. The *Channels* menu opens.



- Press **▲** or **▼** to highlight **Channel Strength**, then press **ENTER**. The signal strength meter is displayed.



- Press **MENU** to return to the previous menu, or press **EXIT** to close the menu.

Automatically adjusting the aspect ratio

Auto Zoom automatically changes how the picture looks on the screen (aspect ratio) based on the TV program you are viewing.

To automatically adjust the aspect ratio:

- Press **MENU**. The on-screen menu opens.

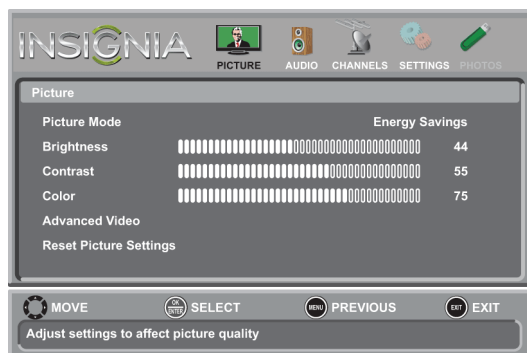

- Press **◀** or **▶** to highlight **CHANNELS**, then press **▼** or **ENTER**. The *Channels* menu opens.



- Press **▲** or **▼** to highlight **Auto Zoom**, then press **ENTER**.
- Press **▲** or **▼** to select **On** (automatically adjust the aspect ratio) or **Off** (does not automatically adjust the aspect ratio).
- Press **MENU** to return to the previous menu, or press **EXIT** to close the menu.

Setting parental controls

Setting or changing the password

Parental controls let you prevent your children from watching inappropriate material on TV. When set, parental controls read the rating of the program (with some exceptions, such as news and sports) and deny access to programs that exceed the ratings level you select. To watch programs that exceed the selected rating, you must enter a password.

To set or change the password:

- Press **MENU**. The on-screen menu opens.

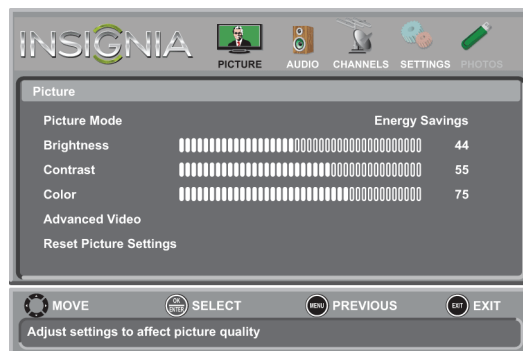

- Press **◀** or **▶** to highlight **SETTINGS**, then press **▼** or **ENTER**. The *Settings* menu opens with **Parental Controls** highlighted.



- Press **ENTER**. The *Enter Password* screen opens.



- Press the number buttons to enter the four-digit password. The default password is **0000**. You should change the password to a number you can remember. The *Settings-Parental Controls* menu opens.



- Press **▲** or **▼** to highlight **Change Password**, then press **ENTER**. The *Settings-Parental Controls-Change Password* screen opens.



- Press the number buttons to enter a password, then enter the password again. The *Parental Controls* menu opens again.

Note
If you forget your password, enter **9999**.

- Press **MENU** to return to the previous menu, or press **EXIT** to close the menu.

Locking control buttons

When the button lock is turned **On**, the buttons on the side of your TV are locked, and you can only operate your TV using the remote control.

To lock control buttons:

- Press **MENU**. The on-screen menu opens.

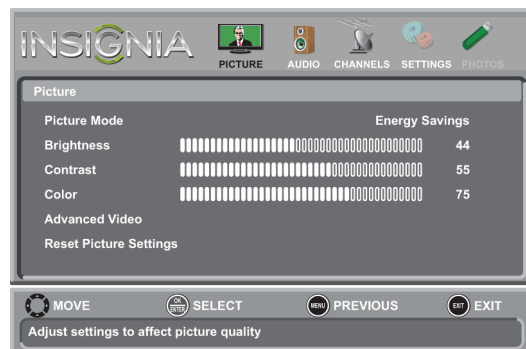

- Press **◀** or **▶** to highlight **SETTINGS**, then press **▼** or **ENTER**. The *Settings* menu opens with **Parental Controls** highlighted.



- Press **ENTER**. The *Enter Password* screen opens.



- Press the number buttons to enter the four-digit password. The *Settings-Parental Controls* menu opens with **Button Lock** highlighted.



- Press **ENTER**.
- Press **▲** or **▼** to select **On** (locks the buttons) or **Off** (unlocks the buttons).
- Press **MENU** to return to the previous menu, or press **EXIT** to close the menu.

Blocking unrated TV

To block unrated TV:

- 1 Press **MENU**. The on-screen menu opens.

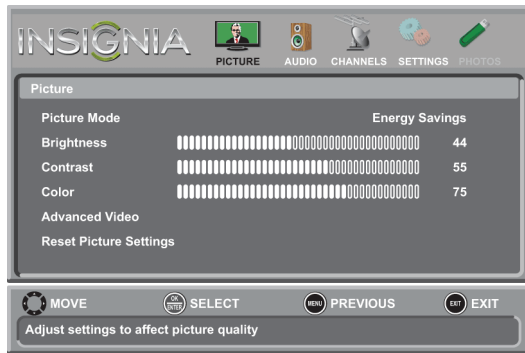

- 2 Press **◀** or **▶** to highlight **SETTINGS**, then press **▼** or **ENTER**. The *Settings* menu opens with **Parental Controls** highlighted.



- 3 Press **ENTER**. The *Enter Password* screen opens.



- 4 Press the number buttons to enter the four-digit password. The *Settings-Parental Controls* menu opens.



- 5 Press **▲** or **▼** to highlight **Block Unrated TV**, then press **ENTER**.
- 6 Press **▲** or **▼** to select **On** (to block unrated TV) or **Off** (to unblock unrated TV).
- 7 Press **MENU** to return to the previous menu, or press **EXIT** to close the menu.

Setting parental control levels

You can set parental controls for the U.S. and Canada.

U.S. rating levels

U.S. TV ratings	
NONE	Not rated
TV-Y	All children
TV-Y7	Suitable for children 7 and older
TV-G	General audiences
TV-PG	Parental guidance suggested
TV-14	Parental guidance strongly suggested
TV-MA	Mature audiences only

Some of the age-based TV Parental Guidelines ratings also have content-based ratings.

U.S. TV content ratings	
All	All ratings are blocked
FV	Fantasy violence
L	Strong language
S	Sexual situations
V	Violence
D	Suggestive dialog

U.S. movie (MPAA) ratings	
None	Movie not rated
G	General audiences
PG	Parental guidance suggested
PG-13	Suitable for children 13 and older
R	Parental guidance suggested for children under 17
NC-17	Not suitable for children under 17
X	Adults only

Canadian rating levels

Canadian English ratings	
E	Exempt programming
C	Suitable for all children
C8+	Suitable for children 8 and older
G	General audiences
PG	Parental guidance suggested
14+	Suitable for children 14 and older
18+	Adult only

Canadian French ratings	
E	Exempt programming
G	General audiences
8ans+	Suitable for children 8 and older
13ans+	Suitable for children 13 and older
16ans+	Suitable for children 16 and older
18ans+	Adult only

To set parental control levels:

- 1 Press **MENU**. The on-screen menu opens.

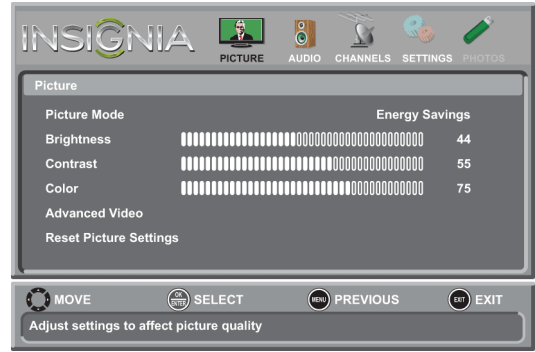

- 2 Press **◀** or **▶** to highlight **SETTINGS**, then press **▼** or **ENTER**. The *Settings* menu opens with **Parental Controls** highlighted.



- 3 Press **ENTER**. The *Enter Password* screen opens.



- 4 Press the number buttons to enter the four-digit password. The *Settings-Parental Controls* menu opens.



- Press **▲** or **▼** to highlight **USA Parental Locks**, then press **ENTER**. (To set Canadian ratings, select **Canadian Parental Locks**.)

USA Parental Locks



Canadian Parental Locks



- Press **◀** or **▶** to highlight:
 - **Movie Ratings** or **TV Ratings** for USA ratings.
 - **Canadian English** or **Canadian French** for Canadian ratings.
- Press **▲** or **▼** to select the rating. If a rating has sub-ratings, press **◀** or **▶** to highlight a sub-rating.

Note

When you block a rating, that rating and all higher ratings are blocked.

- Press **ENTER** to confirm. A lock symbol appears when a rating is blocked.
- Press **MENU** to return to the previous menu, or press **EXIT** to close the menu.

Downloading rating information

You can download rating information to use when setting parental controls.

To download rating information:

- Press **MENU**. The on-screen menu opens.

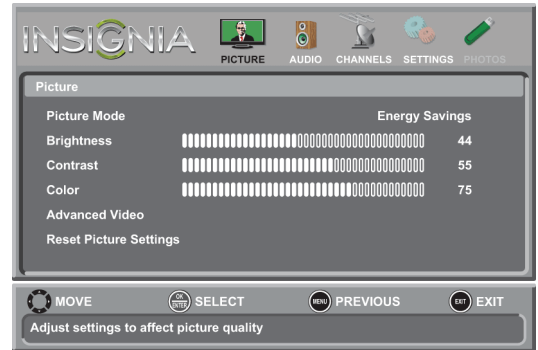

- Press **◀** or **▶** to highlight **SETTINGS**, then press **▼** or **ENTER**. The *Settings* menu opens with **Parental Controls** highlighted.



- Press **ENTER**. The *Enter Password* screen opens.



- Press the number buttons to enter the four-digit password. The *Settings-Parental Controls* menu opens.



- Press **▲** or **▼** to highlight **RRT5**, then press **ENTER**.

If the program is broadcast with RRT5 rating information, the information is downloaded automatically and can be used for parental controls.

- To reset the RRT5 information to the factory default, press **▲** or **▼** to highlight **Reset RRT5**, then press **ENTER**. A box opens. Follow the on-screen instructions.
- Press **MENU** to return to the previous menu, or press **EXIT** to close the menu.

- Press **◀** or **▶** to highlight **SETTINGS**, then press **▼** or **ENTER**. The *Settings* menu opens.



- Press **▲** or **▼** to highlight **Closed Caption**, then press **ENTER**. The *Settings-Closed caption* menu opens.



Using closed captioning

Turning closed captioning on or off

To turn closed captioning on or off:

- Press **MENU**. The on-screen menu opens.

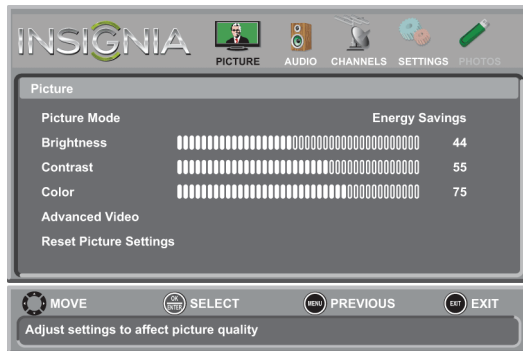

- Press **▲** or **▼** to highlight **Caption Control**, then press **ENTER**. A menu opens.
- Press **▲** or **▼** to select **CC Off** (turns off closed captioning), **CC On** (turns on closed captioning), or **CC On When Mute** (turns on closed captioning when the sound is muted).
- Press **MENU** to return to the previous menu, or press **EXIT** to close the menu.

Note

You can also press **CCD** to turn closed captioning on or off.

Selecting the analog closed captioning mode

To select the analog closed captioning mode:

- Press **MENU**. The on-screen menu opens.

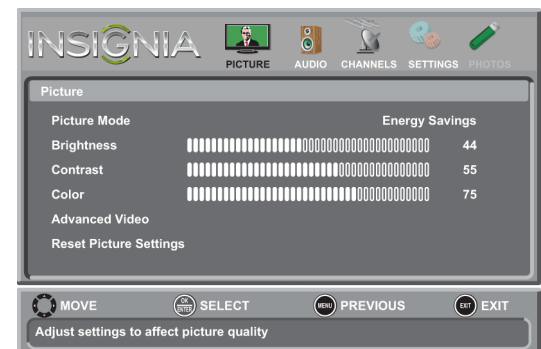

- Press **◀** or **▶** to highlight **SETTINGS**, then press **▼** or **ENTER**. The *Settings* menu opens.



- Press **▲** or **▼** to highlight **Closed Caption**, then press **ENTER**. The *Settings-Closed caption* menu opens.



- Press **▲** or **▼** to highlight **Analog Caption**, then press **ENTER**. A menu opens.

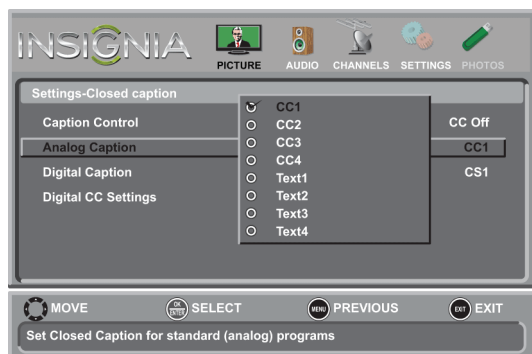

- Press **▲** or **▼** to select an analog caption setting. You can select:
 - CC1** through **CC4**—Closed captioning appears in a small banner across the bottom of the screen. **CC1** is usually the “printed” version of the audio. **CC2** through **CC4** display content provided by the broadcaster.
 - Text1** through **Text4**—Closed captioning covers half or all of the screen. **Text1** through **Text4** display content provided by the broadcaster.
- Press **MENU** to return to the previous menu, or press **EXIT** to close the menu.

Customizing digital closed captioning styles

To customize digital closed captioning styles:

- Press **MENU**. The on-screen menu opens.

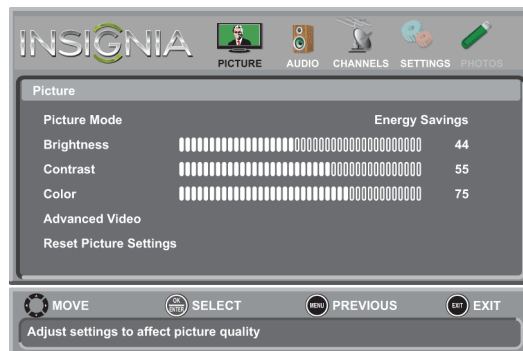

- Press **◀** or **▶** to highlight **SETTINGS**, then press **▼** or **ENTER**. The *Settings* menu opens.



- Press **▲** or **▼** to highlight **Closed Caption**, then press **ENTER**. The *Settings-Closed caption* menu opens.



- 4 Press **▲** or **▼** to highlight **Digital Caption**, then press **ENTER**. A menu opens.

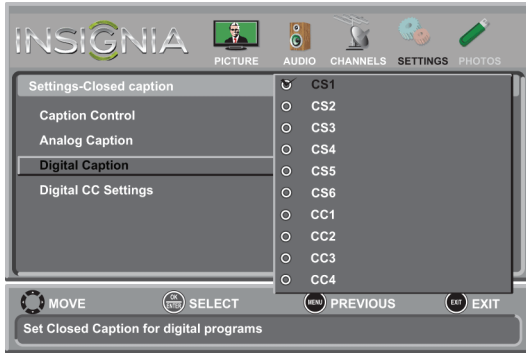

- 5 Press **▲** or **▼** to highlight a digital caption setting, then press **ENTER**. You can select **CS1** through **CS6** or **CC1** through **CC4**.
- 6 Press **MENU** to return to the previous menu.



- 7 Press **▲** or **▼** to highlight **Digital CC Settings**, then press **ENTER**. The *Settings · Closed Caption · Digital CC Settings* menu opens with **Style** highlighted.

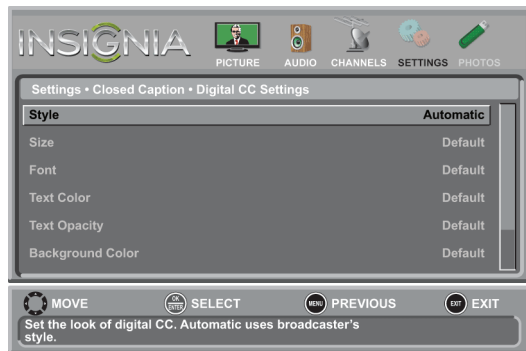

- 8 Press **ENTER**, then press **▲** or **▼** to select **Custom**.
- 9 Press **▲** or **▼** to highlight an option, then press **ENTER**. You can select:
- **Size**—Selects the font size.
 - **Font**—Selects the font style.
 - **Text Color**—Selects the color for the words.
 - **Text Opacity**—Selects the opacity level for the words.
 - **Background Color**—Selects the color for the background.

- **Background Opacity**—Selects the opacity level for the background.
- **Edge Effect**—Selects the style of the window edge.
- **Edge Color**—Selects the color of the window edge.

- 10 Press **MENU** to return to the previous menu, or press **EXIT** to close the menu.

Adjusting time settings

Setting the clock

To set the clock:

- 1 Press **MENU**. The on-screen menu opens.

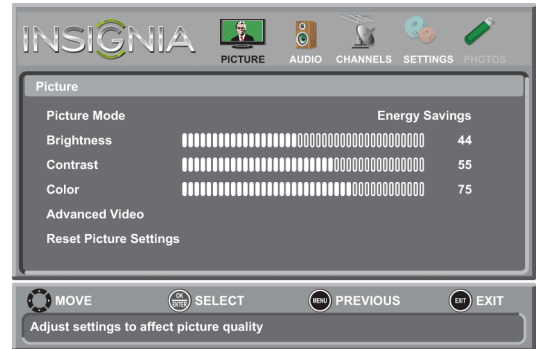

- 2 Press **◀** or **▶** to highlight **SETTINGS**, then press **▼** or **ENTER**. The *Settings* menu opens.



- 3 Press **▲** or **▼** to highlight **Time**, then press **ENTER**. The *Settings-Time* menu opens.

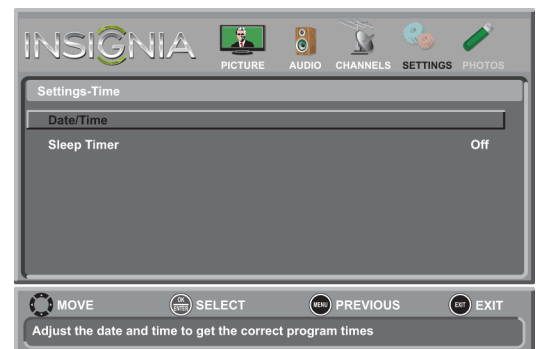

- Press **▲** or **▼** to highlight **Date/Time**, then press **ENTER**. The *Settings - Time - Date/Time* menu opens.

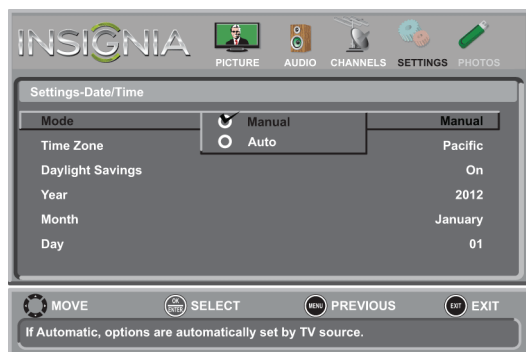

- Press **▲** or **▼** to highlight **Mode**, then press **ENTER**. A menu opens.
- Press **▲** or **▼** to highlight **Manual** (to set the options manually) or **Auto** (the options are automatically set by the TV signal source).
- Press **ENTER** to close the menu.
- Press **▲** or **▼** to highlight **Time Zone**, then press **ENTER**. A menu opens.
- Press **▲** or **▼** to select your time zone, then press **ENTER**. You can select **Atlantic, Eastern, Central, Mountain, Pacific, Alaska, Hawaii, or Newfoundland**.
- Press **ENTER** to close the menu.
- If your viewing area observes daylight savings time, press **▲** or **▼** to highlight **Daylight Savings**, then press **ENTER**.
- Press **▲** or **▼** to select **On** or **Off**, then press **ENTER** to close the menu.
- If you selected **Manual** for **Mode**:
 - Press **▲** or **▼** to highlight **Year, Month, or Date**, press **◀** or **▶** to adjust the setting, then press **ENTER**.
 - Press **▲** or **▼** to highlight **Time**, press **◀** or **▶** to highlight the hour, minute, or AM/PM field, then press **▲** or **▼** to adjust the setting. When you are finished, press **ENTER**.
- Press **MENU** to return to the previous menu, or press **EXIT** to close the menu.

Setting the sleep timer

You can specify the amount of time before your TV automatically turns off.

To set the sleep timer:

- Press **MENU**. The on-screen menu opens.

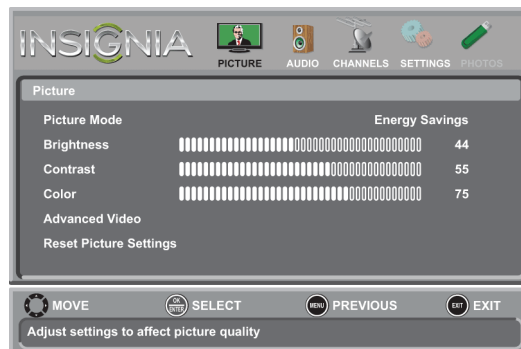

- Press **◀** or **▶** to highlight **SETTINGS**, then press **▼** or **ENTER**. The *Settings* menu opens.



- Press **▲** or **▼** to highlight **Time**, then press **ENTER**. The *Settings-Time* menu opens.

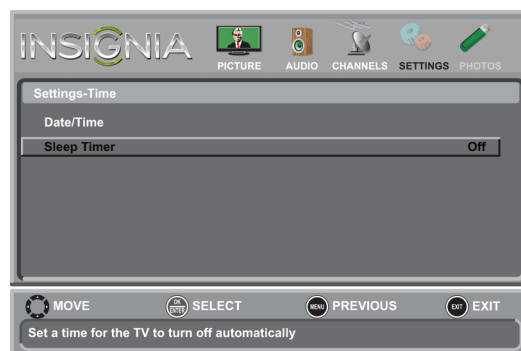

- Press **▲** or **▼** to highlight **Sleep Timer**, then press **ENTER**. A menu opens.

- 5 Press **▲** or **▼** to select the amount of time before your TV turns off automatically. You can select **Off, 5, 10, 15, 30, 60, 90, 120, 180, or 240** minutes.

To turn off the sleep timer, select **Off**.

- 6 Press **MENU** to return to the previous menu, or press **EXIT** to close the menu.

Note

You can also press **SLEEP** to set the sleep timer.

Adjusting menu settings

Selecting the menu language

To select the menu language:

- 1 Press **MENU**. The on-screen menu opens.

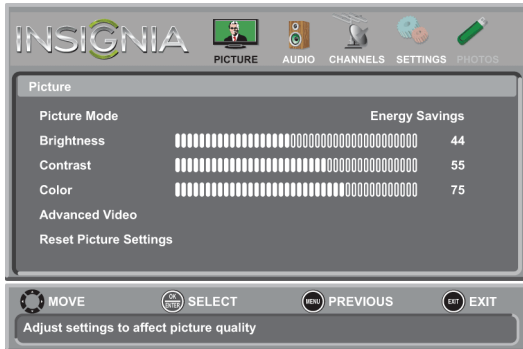

- 2 Press **◀** or **▶** to highlight **SETTINGS**, then press **▼** or **ENTER**. The *Settings* menu opens.



- 3 Press **▲** or **▼** to highlight **Menu Language**, then press **ENTER**. A menu opens.



- 4 Press **▲** or **▼** to highlight a language, then press **ENTER**. You can select **English, Français, or Español**.

- 5 Press **MENU** to return to the previous menu, or press **EXIT** to close the menu.

Turning Input Sensor on or off

When the Input Sensor feature is turned on, your TV automatically detects which video jacks have devices connected to them. Your TV uses this information to determine what options you can select on the *INPUT SOURCE* list when you press **INPUT**.

To turn Input Sensor on or off:

- 1 Press **MENU**. The on-screen menu opens.

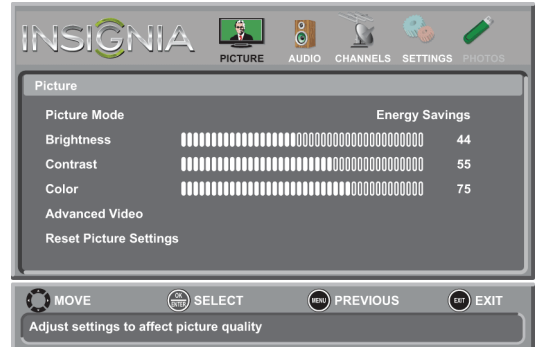

- 2 Press **◀** or **▶** to highlight **SETTINGS**, then press **▼** or **ENTER**. The *Settings* menu opens.



- 3 Press **▲** or **▼** to highlight **Auto Input Sensing**, then press **ENTER**. A menu opens.

- 4 Press **▲** or **▼** to select **On** (turns on the input sensor) or **Off** (turns off the input sensor).

- 5 Press **MENU** to return to the previous menu, or press **EXIT** to close the menu.

Labeling an input source

You can add a label to an input source to make it easier to identify.

To label an input source:

- 1 Press **MENU**. The on-screen menu opens.

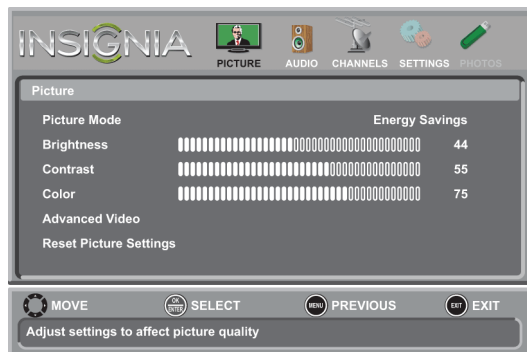

- 2 Press **◀** or **▶** to highlight **SETTINGS**, then press **▼** or **ENTER**. The *Settings* menu opens.



- 3 Press **▲** or **▼** to highlight **Input Labels**, then press **ENTER**. The *Settings-Input Labels* screen opens with the input source field highlighted.



- 4 Press **▲** or **▼** to select the input source you want to label, then press **▶** to move to the custom label field.



- 5 Press **▲** or **▼** to highlight a character, then press **◀** or **▶** to move to the previous or next character position. Repeat this step to enter additional characters. You can enter as many as 11 characters.
- 6 When you have completed the label, press **ENTER**. A message asks if you want to save the label.
- 7 Select **Yes**, then press **ENTER**.
- 8 Press **MENU** to return to the previous menu, or press **EXIT** to close the menu. The next time you press **INPUT**, your label will appear in the *INPUT SOURCE* list.

Restoring settings to the defaults

When you restore default settings, all the settings you have customized (except the password and parental rating) are reset.

To restore settings to the defaults:

- 1 Press **MENU**. The on-screen menu opens.

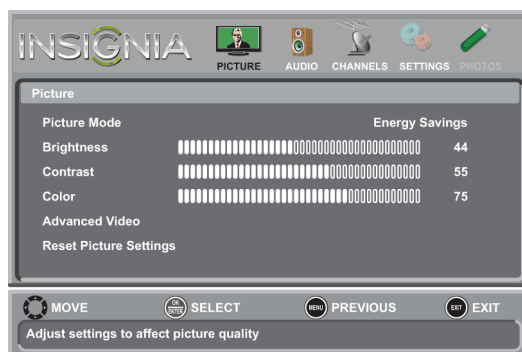

- Press **◀** or **▶** to highlight **SETTINGS**, then press **▼** or **ENTER**. The *Settings* menu opens.



- Press **▲** or **▼** to highlight **Reset to Default**, then press **ENTER**. The *Settings-Reset to Default* menu opens.

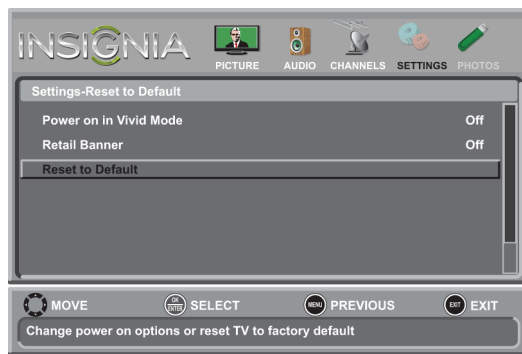

- Press **▲** or **▼** to highlight **Reset to Default**, then press **ENTER**. A confirmation message opens.
- Press **◀** or **▶** to select **Yes** (to reset) or **No** (to not reset), then press **ENTER**.
- Press **MENU** to return to the previous menu, or press **EXIT** to close the menu.

Using INlink

INlink lets you control HDMI CEC-compatible devices connected to the HDMI jacks on your TV using the remote control that came with your TV. To use INlink, you must set the **INlink Control** setting on the *Settings-INlink* menu to **On**.

Note

- HDMI cables must be used to connect HDMI CEC-compatible devices to your TV.
- The connected device's HDMI CEC feature must be turned on.
- If you connect an HDMI device that is not HDMI CEC-compatible, all the **INlink Control** features do not work.
- Depending on the connected HDMI device, the **INlink Control** feature may not work.

Turning INlink on or off

To turn INlink on or off:

- Press **MENU**. The on-screen menu opens.

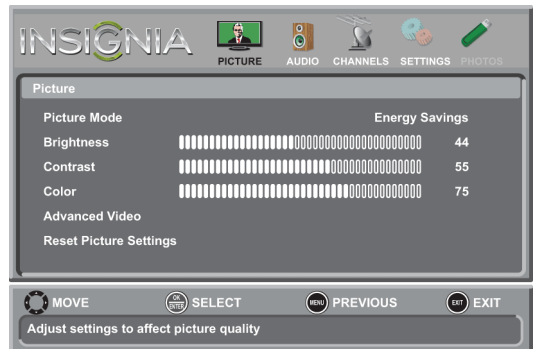

- Press **◀** or **▶** to highlight **SETTINGS**, then press **▼** or **ENTER**. The *Settings* menu opens.



- 3 Press **▲** or **▼** to highlight **INlink**, then press **ENTER**. The *Settings-INlink* menu opens.



- 4 Press **▲** or **▼** to highlight **INlink Control**, then press **ENTER**.
- 5 Press **▲** or **▼** to highlight **On** or **Off**, then press **ENTER**.
- 6 Press **MENU** to return to the previous menu, or press **EXIT** to close the menu.

Turning Device Auto Power Off on or off

When INlink is turned on, **Device Auto Power Off** turns off HDMI CEC devices when you turn off your TV.

To turn Device Auto Power Off on or off:

- 1 Press **MENU**. The on-screen menu opens.

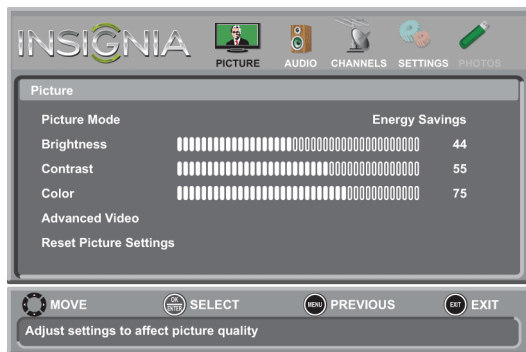

- 2 Press **◀** or **▶** to highlight **SETTINGS**, then press **▼** or **ENTER**. The *Settings* menu opens.



- 3 Press **▲** or **▼** to highlight **INlink**, then press **ENTER**. The *Settings-INlink* menu opens.

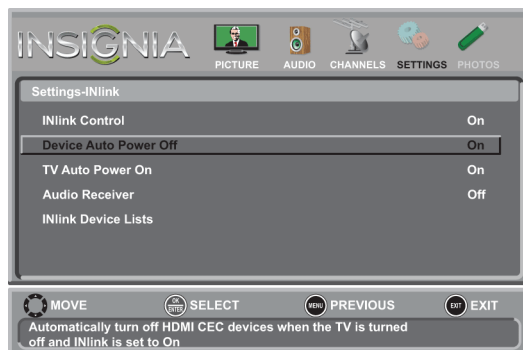

- 4 Press **▲** or **▼** to highlight **Device Auto Power Off**, then press **ENTER**.
- 5 Press **▲** or **▼** to highlight **On** (turns off the connected devices when you turn off your TV) or **Off** (does not turn off the connected devices when you turn off your TV), then press **ENTER**.
- 6 Press **MENU** to return to the previous menu, or press **EXIT** to close the menu.

Turning TV Auto Power On on or off

When INlink is turned on and you turn on an HDMI CEC device, **TV Auto Power On** turns on your TV automatically.

To turn TV Auto Power On on or off:

- 1 Press **MENU**. The on-screen menu opens.

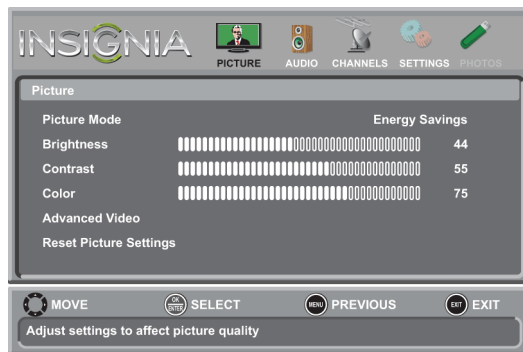

- 2 Press **◀** or **▶** to highlight **SETTINGS**, then press **▼** or **ENTER**. The *Settings* menu opens.



- 3 Press **▲** or **▼** to highlight **INlink**, then press **ENTER**. The *Settings-INlink* menu opens.

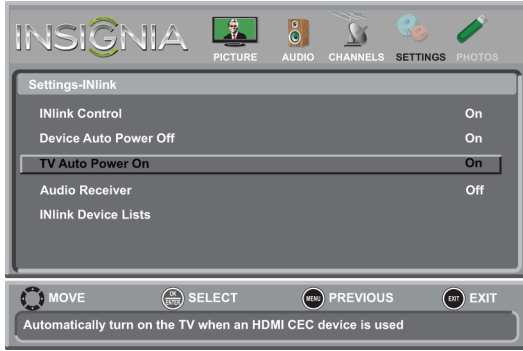

- 4 Press **▲** or **▼** to highlight **TV Auto Power On**, then press **ENTER**.
- 5 Press **▲** or **▼** to highlight **On** (turns on your TV when you turn on the connected device) or **Off** (does not turn on your TV when you turn on the connected device), then press **ENTER**.
- 6 Press **MENU** to return to the previous menu, or press **EXIT** to close the menu.

Turning Audio Receiver on or off

When INlink is turned on and you have connected an audio receiver to your TV, turning on **Audio Receiver** lets you use your TV's remote control to control the volume on the audio receiver.

To turn Audio Receiver On on or off:

- 1 Press **MENU**. The on-screen menu opens.

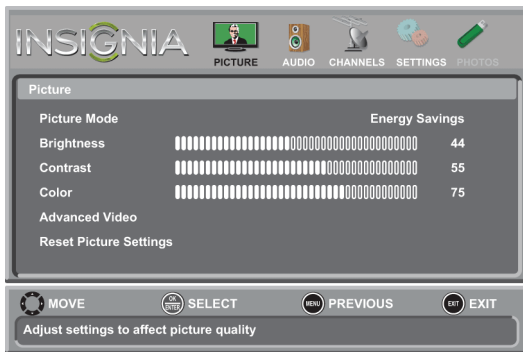

- 2 Press **◀** or **▶** to highlight **SETTINGS**, then press **▼** or **ENTER**. The *Settings* menu opens.



- 3 Press **▲** or **▼** to highlight **INlink**, then press **ENTER**. The *Settings-INlink* menu opens.



- 4 Press **▲** or **▼** to highlight **Audio Receiver**, then press **ENTER**.
- 5 Press **▲** or **▼** to highlight **On** (your TV's remote control controls the connected audio receiver's volume) or **Off** (your TV's remote control does not control the connected audio receiver's volume), then press **ENTER**.
- 6 Press **MENU** to return to the previous menu, or press **EXIT** to close the menu.

Displaying a list of INlink-compatible (HDMI CEC) devices

You can display a list of HDMI CEC devices that are connected to your TV.

To display a list of INlink-compatible (HDMI CEC) devices:

- 1 Press **MENU**. The on-screen menu opens.

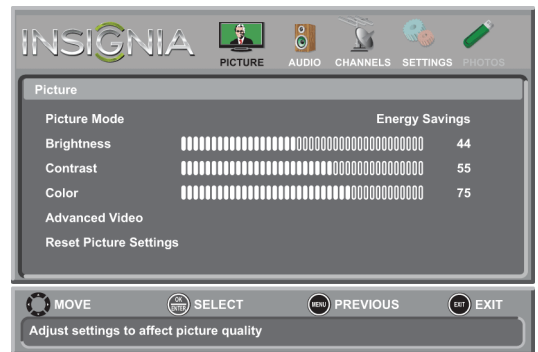

- 2 Press **◀** or **▶** to highlight **SETTINGS**, then press **▼** or **ENTER**. The *Settings* menu opens.



- Press **▲** or **▼** to highlight **INlink**, then press **ENTER**. The *Settings-INlink* menu opens.



- Press **▲** or **▼** to highlight **INlink Device Lists**, then press **ENTER**. A list of the HDMI CEC-compatible devices you have connected appears.
- Press **MENU** to return to the previous menu, or press **EXIT** to close the menu.

Using a USB flash drive

You can connect a USB flash drive to your TV to view compatible JPEG pictures.

Notes

- Never remove the USB flash drive or turn off your TV while viewing JPEG pictures.
- The JPEG picture viewer only supports JPEG format images (with ".jpg" file extensions) and not all JPEG files are compatible with your TV.

Switching to USB mode

To switch to USB mode:

- Make sure that you have connected the USB flash drive to the USB port on your TV.
- Press **INPUT**. The *INPUT SOURCE* list opens.
- Press **▲** or **▼** to highlight **USB(Photos)**, then press **ENTER**. The *Photos* menu opens.

Note

To exit USB mode, press **INPUT** to open the *INPUT SOURCE* list, then select another input source, or press a Quick Launch Input button.

Browsing photos

To browse photos:

- Switch to USB mode. See "[Switching to USB mode](#)" on page 48. The *Photos* menu opens.



- Press **▲** or **▼** to highlight **Browse Photos**, then press **ENTER**. The screen displays folder names and photo files stored on the USB flash drive in a thumbnail index with the first photo or folder highlighted. A control bar appears at the bottom of the screen.

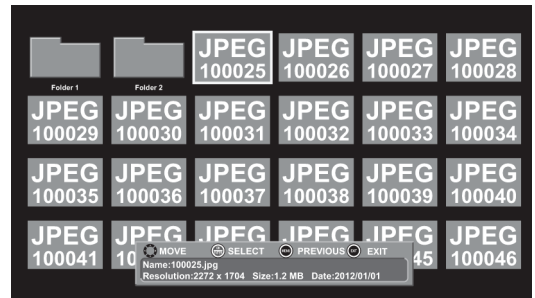

- To navigate the thumbnail index screen, press:
 - ▲ ▼ ◀ ▶** to browse through the files and folders.
 - ENTER** to view a highlighted photo full-screen or open a highlighted folder.
 - MENU** to open the *Photos* menu.
 - FAVORITE** to add or remove a photo from the favorite photo list. A heart appears on a photo that has been added to the favorite photos list.

When a photo is displayed full-screen, a control bar appears at the bottom of the photo. The file name, picture resolution, size, and date are displayed on the bottom of the control bar. If you do not press a button within 10 seconds, the control bar closes. Press any button to open the control bar again.

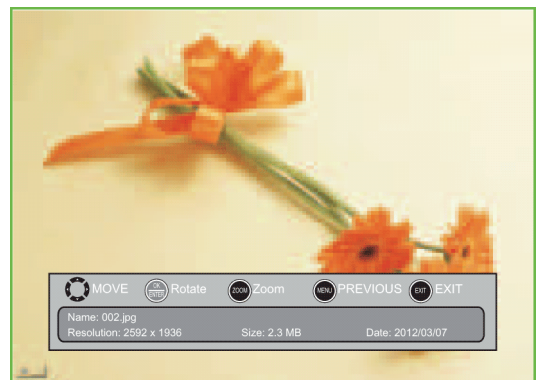

- To navigate on the photo screen, press:
 - ◀** to go to the previous photo.
 - ▶** to go to the next photo.
 - ENTER** to rotate the photo clockwise.
 - ZOOM** one or more times to enlarge the image by $\times 1$, $\times 2$, or $\times 4$ or to select **Fill** (to fill the screen). You can press **▲ ▼ ◀ ▶** to pan the photo.
 - EXIT** to return to the thumbnail index.
 - MENU** to return to the *Photos* menu.

Viewing favorite photos

After you created your favorite photo list, you can browse among your favorite photos quickly.

To view favorite photos:

- 1 Switch to USB mode. See "[Switching to USB mode](#)" on page 48. The *Photos* menu opens.



- 2 Press **▲** or **▼** to highlight **Favorite Photos**, then press **ENTER**. A thumbnail index of your favorite photos opens with a control bar at the bottom of the screen. A heart appears on a favorite photo.

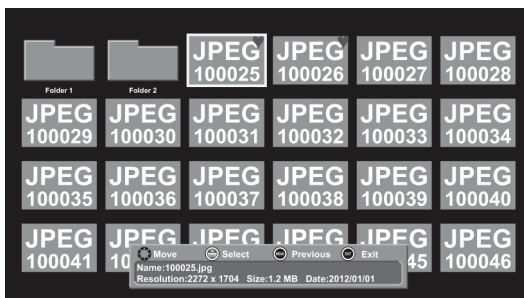

You select photos and navigate on the photo screen in the same way you do when you are browsing through photos. For more information, see "[Browsing photos](#)" on page 48.

Viewing photos in a slideshow

You can view your photos in a slideshow.

To view photos in a slideshow:

- 1 Switch to USB mode. See "[Switching to USB mode](#)" on page 48. The *Photos* menu opens.



- 2 Press **▲** or **▼** to highlight **View Slideshow**, then press **ENTER**. A slideshow starts with the first photo in the current folder.
- 3 To control the slideshow, press:
 - **ENTER** to pause or start the slideshow.
 - **EXIT** to exit the slideshow and return to the thumbnail index.
 - **MENU** to go to the *Photos* menu.

Customizing slideshow settings

You can customize the slideshow settings, including **Repeat**, **Shuffle**, **Speed**, and **Transition**.

To customize slideshow settings:

- 1 Switch to USB mode. See "[Switching to USB mode](#)" on page 48. The *Photos* menu opens.



- 2 Press **▲** or **▼** to highlight **Settings**, then press **ENTER**. The *Photos-Settings* menu opens.



- 3 Press **▲** or **▼** to highlight an option, then press **ENTER**. You can select:
 - **Repeat**—Repeats the slideshow when it reaches the end. You can select **On** or **Off**.
 - **Shuffle**—Displays the slideshow photos in random order. You can select **On** or **Off**.
 - **Speed**—Sets the amount of time a photo is displayed before the slideshow moves to the next photo. You can select **4 sec.**, **6 sec.**, or **8 sec.**
 - **Transition**—Selects the way photos transition when moving to the next file in the slideshow. You can select:
 - **None**—No transition effect.
 - **Fade to Black**—Fades the screen to black between photos.
 - **Vertical Wipe**—Wipes the screen from left to right between photos.

- **Horizontal Wipe**—Wipes the screen from top to bottom between photos.
- **Random**—Randomly selects a transition effect.

4 Press **EXIT** to close the menu.

Maintaining

- Do not use your TV in areas that are too hot or too cold, because the cabinet may warp or the screen may malfunction. Your TV works best in temperatures that are comfortable to you.
- Storage temperatures are 32° to 122°F (0° to 50°C).
- Working temperatures are 41° to 104°F (5° to 40°C).
- Do not place your TV in direct sunlight or near a heat source.

Cleaning the TV cabinet

Clean the cabinet with a soft, lint-free cloth. If the cabinet is especially dirty, moisten a soft, lint-free cloth in a weak detergent solution, squeeze the excess moisture from the cloth, then wipe the cabinet with the cloth. Use a clean cloth to dry the cabinet.

Cleaning the TV screen

Clean the screen with a soft, lint-free cloth.

Troubleshooting

Warning

Do not try to repair your TV yourself. Contact authorized service personnel.

Video and audio

Problem	Solution
Picture does not fill the screen. There are black bars around the picture.	<ul style="list-style-type: none"> • Change the aspect ratio. An increasing amount of digital TV and movies are presented in wide screen (16:9). See "Aspect ratio options" on page 26.
No picture (screen is not lit) and no sound.	<ul style="list-style-type: none"> • Press ⏻ on the TV or the remote control. • Make sure that the Audio Only option is set to Off. See "Playing TV audio only" on page 30. • Make sure that the video cables are connected securely to your TV. • Adjust the contrast and brightness. See "Adjusting the TV picture" on page 25. • Make sure that the power cord is plugged in. • Make sure that the correct video input source is selected. See "Selecting the video input source" on page 23. • Try another channel. The station may be experiencing problems. • Make sure that the incoming signal is compatible. • Make sure that the antenna or cable TV is connected correctly and securely. See "Connecting a cable or satellite box" on page 10 or "Connecting an antenna or cable TV (no box)" on page 13. • Check the closed caption settings. Some TEXT modes can block the screen.

Problem	Solution
Dark, poor, or no picture (screen is lit), but sound is good.	<ul style="list-style-type: none"> • Try another channel. The station may be experiencing problems. • Make sure that the antenna or cable TV is connected correctly and securely. See "Connecting a cable or satellite box" on page 10 or "Connecting an antenna or cable TV (no box)" on page 13. • Adjust the brightness. See "Adjusting the TV picture" on page 25. • Make sure that the correct picture mode is selected. See "Adjusting the TV picture" on page 25. • If you are using an antenna, the digital channel signal may be low. To check the digital channel signal strength, see "Checking the digital signal strength" on page 33. • If you are using an antenna and the signal strength is low, adjust the antenna or use a highly directional outdoor antenna or set-top antenna with a built-in amplifier. • Make sure that the video cables are connected securely to your TV. • The video cable(s) you are using may be bad. Try a new set. • Try another channel. The station may be experiencing problems.
No color, dark picture, or color is not correct.	<ul style="list-style-type: none"> • Try another channel. The station may be experiencing problems. • Adjust the color settings. See "Adjusting the TV picture" on page 25. • Make sure that the video cables are connected correctly and securely to your TV. • Make sure that the antenna or cable TV is connected correctly and securely. See "Connecting a cable or satellite box" on page 10 or "Connecting an antenna or cable TV (no box)" on page 13. • If you are using an antenna, the digital channel signal may be low. To check the digital channel signal strength, see "Checking the digital signal strength" on page 33. • If you are using an antenna and the signal strength is low, adjust the antenna or use a highly directional outdoor antenna or set-top antenna with a built-in amplifier.
Only snow (noise) appears on the screen.	<ul style="list-style-type: none"> • Try another channel. The station may be experiencing problems. • Make sure that the antenna or cable TV is connected correctly and securely. See "Connecting a cable or satellite box" on page 10 or "Connecting an antenna or cable TV (no box)" on page 13. • If you are using an antenna, the digital channel signal may be low. To check the digital channel signal strength, see "Checking the digital signal strength" on page 33. • If you are using an antenna and the signal strength is low, adjust the antenna or use a highly directional outdoor antenna or set-top antenna with a built-in amplifier.
Picture quality is good on some channels and poor on others. Sound is good.	<ul style="list-style-type: none"> • The problem may be caused by a poor or weak signal from the broadcaster or cable TV provider. • If you connect to cable or satellite TV without a set-top box and experience poor picture quality, you may need to install a set-top box to improve signal reception and picture quality. Contact your cable or satellite TV provider about upgrading to a set-top box.

Problem	Solution
Dotted lines or stripes appear on the screen.	<ul style="list-style-type: none"> Make sure that the antenna or cable TV is connected correctly and securely. See “Connecting a cable or satellite box” on page 10 or “Connecting an antenna or cable TV (no box)” on page 13. If you are using an antenna, the digital channel signal may be low. To check the digital channel signal strength, see “Checking the digital signal strength” on page 33. If you are using an antenna and the signal strength is low, adjust the antenna or use a highly directional outdoor antenna or set-top antenna with a built-in amplifier. Make sure that the video cables are connected securely to your TV. The video cable(s) you are using may be bad. Try a new set. Other devices (for example, a surround sound receiver, external speakers, fans, or hair dryers) may be interfering with your TV. Try turning off one device at a time to determine which device is causing interference. After you have determined which device is causing interference, move it further from the TV to eliminate the interference.
Double images.	<ul style="list-style-type: none"> Use a highly directional outdoor antenna, cable TV, or satellite TV.
The picture has a few bright or dark spots.	<ul style="list-style-type: none"> A few bright or dark spots on an LCD screen is normal. It does not affect the operation of your TV.
Good picture, but no sound.	<ul style="list-style-type: none"> Increase the volume. Make sure that the sound is not muted. Make sure you do not have headphones connected. When headphones are connected, no sound comes from the TV speakers. Make sure that the correct audio mode is selected. Make sure that the audio cables are connected correctly and securely to your TV. Make sure that the antenna or cable TV is connected correctly and securely. See “Connecting a cable or satellite box” on page 10 or “Connecting an antenna or cable TV (no box)” on page 13. If you are using an antenna, the digital channel signal may be low. To check the digital channel signal strength, see “Checking the digital signal strength” on page 33. The audio cable(s) you are using may be bad. Try a new set.
Poor picture.	<ul style="list-style-type: none"> Make sure that the room is not too bright. Light reflecting off the screen can make the picture difficult to see. If an S-VHS camera or a camcorder is connected while another connected device is turned on, the picture may be poor. Turn off one or more devices.
Good sound but poor color.	<ul style="list-style-type: none"> Adjust the contrast, color, and brightness settings. See “Adjusting the TV picture” on page 25.
Audio noise.	<ul style="list-style-type: none"> Other devices (for example, a surround sound receiver, external speakers, fans, or hair dryers) may be interfering with your TV. Try turning off one device at a time to determine which device is causing interference. After you have determined which device is causing interference, move it further from the TV to eliminate the interference.

Problem	Solution
No output from one of the speakers.	<ul style="list-style-type: none"> Adjust the audio balance. See “Adjusting sound settings” on page 29. Make sure that the audio cables are connected correctly and securely to your TV.
After images appear.	<ul style="list-style-type: none"> Do not display a still image, such as a logo, game, or computer image, for an extended period of time. This can cause a permanent after-image to be burned into the screen. This type of damage is not covered by your warranty.

Remote control

Problem	Solution
Remote control does not work.	<ul style="list-style-type: none"> Make sure that the power cord is correctly connected to your TV and a power outlet. Make sure that there are no obstructions between the remote control and the remote control sensor on the front of the TV. Point the remote control directly at the remote control sensor on your TV. For the location of the remote control sensor, see “Aiming the remote control” on page 20. The supplied batteries are wrapped tightly in clear plastic. Make sure that you have removed this plastic from the batteries. Make sure that the batteries are installed correctly. See “Installing remote control batteries” on page 20. Replace dead batteries with new batteries. See “Installing remote control batteries” on page 20.
Trouble programming your existing universal remote control.	<ul style="list-style-type: none"> See instructions and a table of common codes in “Programming a different universal remote control” on page 53. Codes are subject to change. For up-to-date codes, go to www.insigniaproducts.com/remotecodes Replace dead batteries with new batteries. See “Installing remote control batteries” on page 20. Refer to the User Guide that accompanied your universal remote control and contact the manufacturer if problems persist.

General

Problem	Solution
No power.	<ul style="list-style-type: none"> Make sure that the power cord is correctly connected to your TV and a power outlet. Unplug the power cord, wait 60 seconds, then plug the cord back in and turn on your TV. Other devices (for example, a surround sound receiver, external speakers, fans, or hair dryers) may be interfering with your TV. Try turning off one device at a time to determine which device is causing interference. After you have determined which device is causing interference, move it further from the TV to eliminate the interference.
“No signal” error message is displayed.	<ul style="list-style-type: none"> Press INPUT and make sure that you have selected the correct input for the device or service you are trying to use. If you are using a cable or satellite box, use the remote that came with that box to change channels. Make sure that you have the correct input selected to view channels from the cable or satellite box.

Problem	Solution
After Auto Channel Search, there are no channels.	<ul style="list-style-type: none"> Reception can vary by channel depending on the broadcast power level of a given station. Contact your cable or satellite TV provider. Make sure that the antenna or cable/satellite TV is connected securely to your TV. Try replacing the cable between the antenna/cable or cable/satellite box and your TV.
One or more channels do not display.	<ul style="list-style-type: none"> Make sure that the channels are not blocked. See "Setting parental control levels" on page 37. Make sure that the channels are not hidden. The channel may have been deleted from the channel list. You can tune to the channel by pressing the number buttons or you can add the channel back to the channel list. See "Hiding channels" on page 31. If you are using a cable or satellite box, use the remote that came with that box to change channels. Make sure that you have the correct input selected to view channels from the cable or satellite box. If you are using an antenna, the digital channel signal may be low. To check the digital channel signal strength, see "Checking the digital signal strength" on page 33.
Password is lost.	<ul style="list-style-type: none"> Enter 9999 to access parental controls, then set a new password. See "Setting or changing the password" on page 34.
Some settings cannot be accessed.	<ul style="list-style-type: none"> If a setting is grayed, the setting is not available in the current video input mode.
TV cabinet creaks.	<ul style="list-style-type: none"> When the TV is in use, the temperature rises naturally and may cause the cabinet to expand or contract which can cause a creaking noise. This is not a malfunction.
Control buttons do not work.	<ul style="list-style-type: none"> Make sure that the Button Lock option is set to Off. See "Locking control buttons" on page 35. Unplug the power cord, wait a few seconds, then plug the cord back in and turn on your TV.
TV keeps turning off.	<ul style="list-style-type: none"> Make sure that the sleep timer is not turned on. See "Setting the sleep timer" on page 42.

Note: If the problem is not solved by using these troubleshooting instructions, turn off your TV, then turn it on again.

Specifications

Specifications are subject to change without notice.

Dimensions and weight

Without stand	57.7 × 34.5 × 3.5 in. (146.6 × 87.8 × 8.9 cm) 56.2 lbs (25.5kg)
With stand	57.7 × 37 × 12.6 in. (146.6 × 94 × 32 cm) 67.2 lbs (30.5kg)

Screen

Screen size measured diagonally	64.5 in.
Display type	LED
Panel 60 Hz vs. 120 Hz	120Hz
Display resolution	1080p
Panel resolution	1920 (H) × 1080 (V)
Aspect ratio	16:9
Contrast ratio (typical)–panel	7000:1
Dynamic contrast ratio–list value	165,000:1
Brightness (center typical) cd/m ²	350 nits
Comb filter	3d y/c digital
Response time	6.5 ms
Horizontal viewing angle	178
Vertical viewing angle	178

Display resolutions and VGA scan rates

HDMI suggested resolutions	1080p, 1080i, 720p, 480p, 480i
Component video suggested resolutions	1080i, 720p, 480p, 480i

Tuner

Analog	NTSC
Digital	ATSC, 8-VSB, Clear-QAM

Inputs

HDMI	1 (side)/2 (back) E-EDID compliant HDCP compliant
Component video	1 (back)
Composite video	1 (back) Shared with component Y
Shared audio (component and composite)	Yes
S-Video	No
PC/VGA	1 (back)
3.5mm PC audio input	1 (back)
DVI	1 (back) HDMI 1/DVI jack
USB	1 (side) Supports JPEG and firmware upgrade
Antenna/Cable	1 (side)

Outputs

Video	No
Analog audio/Headphone	1 (side)
Digital audio	1 (optical) (side)
WiFi	No
Ethernet	No

Audio

Speakers	Number: 2 Watts per channel: 10W
----------	-------------------------------------

Power

Power consumption	On: 260W Standby: <1W
Power input	AC 120 V, 60Hz

Miscellaneous

OSD languages	English, French, Spanish
INlink	Yes
Game Mode	Yes
ENERGY STAR qualified	No
Internet connectable	No
TV base screws	Stand column to TV screen: M6 type (18 mm length) (5 pcs) Base to stand column: M6 type (18 mm length) (7 pcs)
V-Chip (version 2.0)	Yes
Sleep timer	Yes
Channel labeling	Yes
VESA mount (mm) (horizontal × vertical)	400 × 400

Note

The length of the wall-mount screws vary depending on the wall-mount bracket you purchased. See the instructions that came with the wall-mount bracket for screw lengths.

Programming universal remote controls

Programming a different universal remote control

You can operate your Insignia TV with a new or existing universal remote control.

To program a different universal remote control:

- 1 See the table in "[Common universal remote control codes](#)" for common codes. If you have problems programming your remote or need a different remote control code, visit www.insigniaproducts.com/remotecodes for the latest remote control code information.
- 2 Follow your universal remote control's instructions to enter the TV code you found in Step 1.

Tips

- If your universal remote control has a code search feature, run a code search to identify a code that matches your TV. See your universal remote control's instructions for details.
- If your universal remote control has a "Learn" feature, you can manually program it using the Insignia TV remote to "teach" the commands one at a time. See your universal remote control's instructions for details.

For additional help and information:

- Visit: <http://www.insigniaproducts.com/remotecodes>
- Call technical support for the universal remote control or cable/satellite company of the remote/set-top box you are trying to program.
- Call the Insignia Customer Care Center 1-877-467-4289.

Common universal remote control codes

The following is a list of the most common remote control codes. Codes for other remote controls are available online at:

<http://www.insigniaproducts.com/remotecodes>

or check with your cable or satellite TV provider for the remote control code.

Insignia TV codes for universal remote controls (for all Insignia TVs manufactured after Jan. 1, 2007)

Universal remote control makes and models	
One for All	0054
Phillips	0198, 0490
RCA	135
Sony	068, 069, 078, 096, 100, 164, 168, 229, 026

Set-top box makes and models	
Cablevision	068, 069, 078, 096, 100, 164, 168, 229, 026
Charter	2002, 1204, 1423, 1517, 0171, 1963, 0463, 1463, 0842, 1326, 167, 415, 424, 450, 456, 461, 507, 523, 567, 577, 586
Comcast	10171, 11204, 11326, 11463, 11517, 11641, 11780, 11785, 11892, 11963, 12002
Cox	1326, 1463
DirectTV	10171, 11204, 11326, 11517, 11564, 11641, 11963, 12002
Dish Network	720
Time Warner	400, 450, 461, 456, 10463, 1463, 0463
TiVo	0091
Verizon	0198, 0490

Tips

- The brand name is often visible on the front of the universal remote control, and the model number is often visible on the back.
- If your universal remote control isn't listed on the chart, refer to your universal remote control's instructions and try codes for the brands Orion, Emerson, Memorex, Sansui, Sylvania, or Zenith. You may need to try several codes before finding a match.

Legal notices

FCC Part 15

This device complies with Part 15 of the FCC Rules. Operation of this product is subject to the following two conditions: (1) this device may not cause harmful interference, and (2) this device must accept any interference received, including interference that may cause undesired operation.

This equipment has been tested and found to comply within the limits for a class B digital device, pursuant to Part 15 of the FCC Rules. These limits are designed to provide reasonable protection against harmful interference in a residential installation. This equipment generates, uses, and can radiate radio frequency energy and, if not installed and used in accordance with the instructions, may cause harmful interference to radio communications. However, there is no guarantee that interference will not occur in a particular installation. If this equipment does cause harmful interference to radio or television reception, which can be determined by turning the equipment off and on, the user is encouraged to try to correct the interference by one or more of the following measures:

- Reorient or relocate the receiving antenna.
- Increase the separation between the equipment and receiver.
- Connect the equipment into an outlet on a circuit different from that to which the receiver is connected.
- Consult the dealer or an experienced radio/TV technician for help.

FCC warning

Changes or modifications not expressly approved by the party responsible for compliance with the FCC Rules could void the user's authority to operate this equipment.

Cables

Connections to this device must be made with shielded cables with metallic RF/EMI connector hoods to maintain compliance with FCC Rules and Regulations.

Canada ICES-003 statement

This Class B digital apparatus complies with Canadian ICES-003. Standard Television Receiving Apparatus — Appareil de réception télévision ordinaire, Canada BETS-7 / NTMR-7

Dolby License Notice and Trademark Acknowledgement



Manufactured under license from Dolby Laboratories. Dolby and the double-D symbol are trademarks of Dolby Laboratories.

HDMI



HDMI, the HDMI logo, and High-Definition Multimedia Interface are trademarks or registered trademarks of HDMI Licensing LLC.

One-year limited warranty - Insignia Televisions

Definitions:

Insignia Products ("Insignia") warrants to you, the original purchaser of this new Insignia-branded television ("Product"), that the Product shall be free of defects in the original manufacturer of the material or workmanship for a period of one (1) year from the date of your purchase of the Product ("Warranty Period"). For this warranty to apply, your Product must be purchased in the United States or Canada from a Best Buy or Future Shop authorized dealer of Insignia brand products only that are packaged with this warranty statement.

How long does the coverage last?

The Warranty Period lasts for 1 year (365 days) from the date you purchased the Product. Your purchase date is printed on the receipt you received with the Product.

What does this warranty cover?

During the Warranty Period, if the original manufacture of the material or workmanship of the Product is determined to be defective by an authorized Insignia repair center or store personnel, Insignia will (at its sole option): (1) repair the Product with new or rebuilt parts; or (2) replace the Product at no charge with new or rebuilt comparable products or parts. Products and parts replaced under this warranty become the property of Insignia and are not returned to you. If service of Products or parts are required after the Warranty Period expires, you must pay all labor and parts charges. This warranty lasts as long as you own your Insignia Product during the Warranty Period. Warranty coverage terminates if you sell or otherwise transfer the Product.

How to obtain warranty service?

If you purchased the Product at a Best Buy or Future Shop retail store location and your television Product has a screen size of less than 42 inches, please take your original receipt and the Product to any Best Buy or Future Shop store. Make sure that you place the Product in its original packaging or packaging that provides the same amount of protection as the original packaging. If you purchased the Product from a Best Buy or Future Shop online web site, mail your original receipt and the Product to the address listed on the web site. Make sure that you put the Product in its original packaging or packaging that provides the same amount of protection as the original packaging.

To obtain in-home warranty service for a television with a screen 42 inches or larger, in the United States call 1-888-BESTBUY, Canada call 1-866-BESTBUY for Future Shop call 1-800-663-2275. Call agents will diagnose and correct the issue over the phone or will have a Insignia-approved repair technician dispatched to your home.

Where is the warranty valid?

This warranty is valid only in the United States and Canada at Best Buy or Future Shop branded retail stores or websites to the original purchaser of the product in the county where the original purchase was made.

What does the warranty not cover?

This warranty does not cover:

- Customer instruction/education
- Installation
- Set up adjustments
- Cosmetic damage
- Damage due to acts of God, such as power surges
- Accident(s)
- Misuse
- Abuse
- Negligence
- Commercial purposes/use, including but not limited to use in a place of business or in communal areas of a multiple dwelling condominium or apartment complex, or otherwise used in a place of other than a private home.
- Modification of any part of the Product, including the antenna
- Plasma display panel damaged by static (non-moving) images applied for lengthy periods (burn-in).
- Damage due to incorrect operation or maintenance

- Connection to an incorrect voltage or power supply
- Attempted repair by any person not authorized by Insignia to service the Product
- Products sold "as is" or "with all faults"
- Consumables, including but not limited to batteries (i.e. AA, AAA, C etc.)
- Products where the factory applied serial number has been altered or removed
- Loss or Theft of this product or any part of the product
- Up to three (3) pixel failures (dots that are dark or incorrectly illuminated) grouped in an area smaller than one tenth (1/10) of the display size or up to five (5) pixel failures throughout the display. (Pixel based displays may contain a limited number of pixels that may not function normally.)
- Failures or Damage caused by any contact including but not limited to liquids, gels or pastes.

REPAIR REPLACEMENT AS PROVIDED UNDER THIS WARRANTY IS YOUR EXCLUSIVE REMEDY FOR BREACH OF WARRANTY. INSIGNIA SHALL NOT BE LIABLE FOR ANY INCIDENTAL OR CONSEQUENTIAL DAMAGES FOR THE BREACH OF ANY EXPRESS OR IMPLIED WARRANTY ON THIS PRODUCT, INCLUDING, BUT NOT LIMITED TO, LOST DATA, LOSS OF USE OF YOUR PRODUCT, LOST BUSINESS OR LOST PROFITS. INSIGNIA PRODUCTS MAKES NO OTHER EXPRESS WARRANTIES WITH RESPECT TO THE PRODUCT, ALL EXPRESS AND IMPLIED WARRANTIES FOR THE PRODUCT, INCLUDING, BUT NOT LIMITED TO, ANY IMPLIED WARRANTIES OF AND CONDITIONS OF MERCHANTABILITY AND FITNESS FOR A PARTICULAR PURPOSE, ARE LIMITED IN DURATION TO THE WARRANTY PERIOD SET FORTH ABOVE AND NO WARRANTIES, WHETHER EXPRESS OR IMPLIED, WILL APPLY AFTER THE WARRANTY PERIOD. SOME STATES, PROVINCES AND JURISDICTIONS DO NOT ALLOW LIMITATIONS ON HOW LONG AN IMPLIED WARRANTY LASTS, SO THE ABOVE LIMITATION MAY NOT APPLY TO YOU. THIS WARRANTY GIVES YOU SPECIFIC LEGAL RIGHTS, AND YOU MAY ALSO HAVE OTHER RIGHTS, WHICH VARY FROM STATE TO STATE OR PROVINCE TO PROVINCE.

Contact Insignia:

For customer service please call 1-877-467-4289

www.insigniaproducts.com

Distributed by Best Buy Purchasing, LLC

7601 Penn Avenue South, Richfield, Minnesota, U.S.A.

55423-3645

© 2012 BBY Solutions, Inc.

All rights reserved. INSIGNIA is a trademark of BBY Solutions, Inc. Registered in some countries. All other products and brand names are trademarks of their respective owners.

INSIGNIA™

INSIGNIA is a registered trademark of BBY Solutions, Inc.
Registered in some countries.

Distributed by Best Buy Purchasing, LLC, 7601 Penn Ave South, Richfield, MN 55423 U.S.A.

©2012 BBY Solutions, Inc.

All Rights Reserved

1-877-467-4289

www.insigniaproducts.com

ENGLISH
12-1079