



NÜVISION

Operating Manual

NVX37HDU2

37-inch High Definition LCD Monitor

Table of Contents

Important Information.....	1
Important Safety Precautions	2
Preparations	5
Using the Remote Control.....	5
Batteries for the Remote Control	5
Power Connection.....	5
Identification of Controls.....	6
Main Unit.....	6
Remote Control.....	8
Connections.....	9
Cautions Before Connecting	9
Connect a VCR	9
Connect a Camcorder	10
Connect a DVD player.....	11
Connect a product to HDMI.....	12
Connect a PC.....	13
Connect a VCR for Recording.....	14
Turning the Unit On and Off.....	15
Viewing the Menus and Displays	15
Displaying Status Information.....	15
Adjusting the Volume.....	15
Using the Mute	15
Basic Operations	16
Selecting Input Source Signal	16
Editing Input Label.....	16
Selecting a Menu Language.....	16
Setting Picture	17
Customizing the Picture	17
Using the Preset Picture Mode.....	17
Setting Auto Color Function On or Off	18
Selecting the Preset Color Warmth Mode	18
Changing Screen Aspect Ratio	18
Setting Sound	19
Customizing the Sound	19
Setting the Line Output.....	19
Using the Preset Sound Mode	19
Adjusting On-Screen Display.....	20
Adjusting OSD Position	20
Setting OSD Timeout.....	20
Adjusting OSD Transparency	20

Table of Contents (continued)

Setting System	21
Setting Clock Timer	21
Setting Wake Up Timer	21
Displaying Signal Source Information	21
Loading Default Values	21
PIP Operations	22
Viewing and adjusting the Size of PIP Frame	22
Turning Off the PIP Frame	22
Adjusting the Volume for the PIP Frame	22
Swapping the Contents of the PIP Frame and Main Frame	22
Changing the Position of the PIP Frame.....	22
Selecting Speaker Output Source	23
Viewing Picture-by-Picture	23
Viewing Picture-out-Picture	23
Adjustment in VGA/HDMI/Component Mode.....	24
Selecting the Preset Color Warmth Mode	24
Adjusting the Picture Automatically	24
Adjusting the Clock	24
Adjusting the Phase	25
Changing the Position of Image.....	25
Setting Over Scan Function	25
Using Hotkeys.....	26
Viewing Closed Captions.....	27
Setting Closed Caption.....	27
Setting CC When Mute.....	27
Adjusting Parental Control Settings.....	28
Parental Control	28
Password Setup	30
Turning Parental Control On or Off.....	30
Adjusting the Movie Rating.....	30
Adjusting the TV PG Rating	30
Adjusting Canadian English Rating	31
Adjusting Canadian French Rating.....	31
Troubleshooting	32
Care and Maintenance	33
Specification	34

Important Information

WARNING: TO REDUCE THE RISK OF FIRE OR ELECTRIC SHOCK, DO NOT EXPOSE THIS APPARATUS TO RAIN OR MOISTURE.

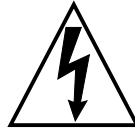
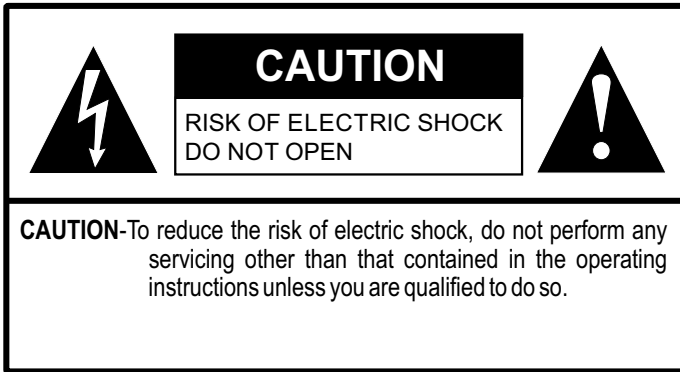

The lightning flash with arrowhead symbol, within an equilateral triangle is intended to alert the user to the presence of uninsulated dangerous voltage within the product's enclosure that may be of sufficient magnitude to constitute a risk of electric shock to persons.



The exclamation point within an equilateral triangle is intended to alert the user to the presence of important operating and maintenance (servicing) instructions in the literature accompanying the appliance.

This product utilizes tin-lead solder, and fluorescent lamp containing a small amount of mercury. Disposal of these materials may be regulated due to environmental considerations. For disposal or recycling information, please contact your local authorities or the Electronic Industries Alliance: www.eia.org

FCC STATEMENT

FCC Notice

LCD Monitor: A CLASS B digital device

This equipment has been tested and found to comply with the limits for a Class B digital device, pursuant to part 15 of the FCC Rules. These limits are designed to provide reasonable protection against harmful interference when the equipment is operated in a commercial environment.

This equipment generates, uses, and can radiate radio frequency energy and, if not installed and used in accordance with the instruction manual, may cause harmful interference to radio communications. Operation of this equipment in a residential area is likely to cause harmful interference in which case the user will be required to correct the interference at his own expense.

FCC CAUTION:

Pursuant to 47CFR, Part 15.21 of the FCC rules, any changes or modifications to this monitor not expressly approved by the manufacturer could cause harmful interference and would void the user's authority to operate this device.

WARNING: This is a CLASS B product. In a domestic environment this product may cause radio interference in which case the user may be required to take adequate measures to counter interference.

Important Safety Precautions

Electrical energy can perform many useful functions, but it can also cause personal injuries and property damage if improperly handled. This product has been engineered and manufactured with the highest priority on safety. But **IMPROPER USE CAN RESULT IN POTENTIAL ELECTRICAL SHOCK OR FIRE HAZARD**. In order to prevent potential danger, please observe the following instructions when installing, operating and cleaning the product. To ensure your safety and prolong the service life of your LCD Monitor product, please read the following precautions carefully before using the product.

- 1. Read these instructions**---All operating instructions must be read and understood before the product is operated.
- 2. Keep these instructions**---These safety and operating instructions must be kept in a safe place for future reference.
- 3. Heed all warnings**---All warnings on the product and in the instructions must be observed closely.
- 4. Follow all instructions**---All operating instructions must be followed.

5. Do not use this apparatus near water---for example, near a bathtub, washbowl, kitchen sink, or laundry tub, in a wet basement, or near a swimming pool, and the like. Do not use immediately after moving from a low temperature to high temperature environment, as this causes condensation, which may result in fire, electric shock, or other hazards. Apparatus shall not be exposed to dripping or splashing and no objects filled with liquids, such as vases, shall be placed on the apparatus.



6. Clean only with dry cloth---Unplug this product from the wall outlet before cleaning. Do not use liquid cleaners or aerosol cleaners. Use a damp cloth for cleaning.

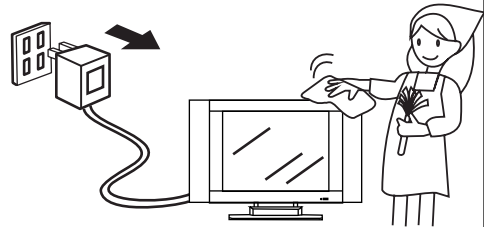

7. Ventilation---Do not block any ventilation openings. Install in accordance with the manufacturer instructions. The vents and other openings in the cabinet are designed for ventilation. Do not cover or block these vents and openings since insufficient ventilation can cause overheating and/or shorten the life of the product. Do not place the product on a bed, sofa, rug or other similar surface, since they can block ventilation openings. This product is not designed for built-in installation; do not place the product in an enclosed place such as a bookcase or rack, unless proper ventilation is provided or the manufacturer's instructions are followed.

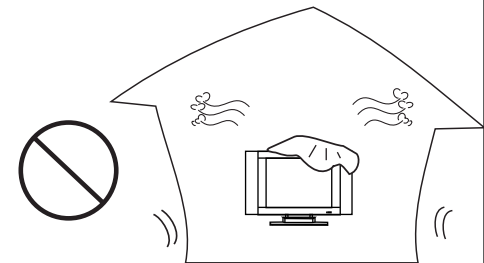

8. Heat sources---Do not install near any heat sources such as radiators, heat registers, stoves, or other apparatus (including amplifiers) that produce heat.

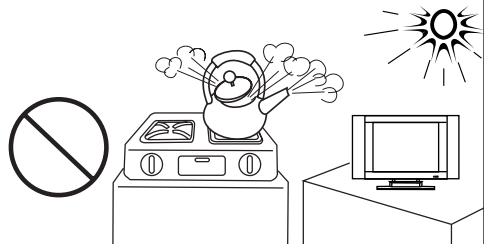

9. Grounding or Polarization---Do not defeat the safety purpose of the polarized or grounding-type plug. A polarized plug has two blades with one wider than the other. A grounding type plug has two blades and a third grounding prong. The wide blade or the third prong are provided for your safety. If the provided plug does not fit into your outlet, consult an electrician for replacement of the obsolete outlet.

10. Power cord protection---Protect the power cord from being walked on or pinched particularly at plugs, convenience receptacles, and the point where they exit from the apparatus. Never attempt to move the monitor unless the AC plug has been disconnected.

11. Attachments---Only use attachments/accessories specified by the manufacturer. Do not use attachments not recommended by the manufacturer. Use of improper attachments can result in accidents.

Important Safety Precautions (continued)

12. Stand---Use only with the cart, stand, tripod, bracket, or table specified by the manufacturer, or sold with the apparatus. Do not place the product on an unstable trolley, stand, tripod or table. Placing the product on an unstable base can cause the product to fall, resulting in serious personal injuries as well as damage to the product. When mounting the product on a wall, be sure to follow the manufacturer's instructions. Use only the mounting hardware recommended by the manufacturer.

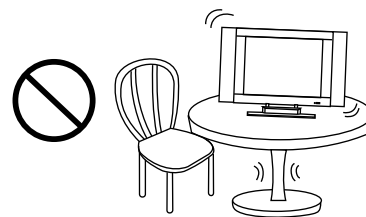

13. Move Carefully---When a cart is used, use caution when moving the cart/apparatus combination to avoid injury from tip-over. Sudden stops, excessive force and uneven floor surfaces can cause the product to fall from the trolley.



14. Lightning---Unplug this apparatus during lightning storms or when unused for long periods of time.

For added protection for this apparatus during a lightning storm, or when it is left unattended and unused for long periods of time, unplug it from the wall outlet. This will prevent damage to the equipment due to lightning and power-line surges.

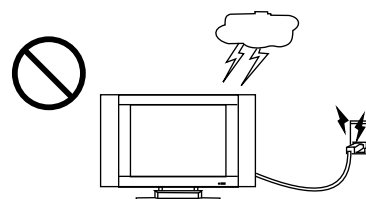

15. Servicing---Refer all servicing to qualified service personnel. Servicing is required when the apparatus has been damaged in any way, such as power-supply cord or plug is damaged, liquid has been spilled or objects have fallen into the apparatus, the apparatus has been exposed to rain or moisture, does not operate normally, or has been dropped.

16. Replacement parts---In case the product needs replacement parts, make sure that the service person uses replacement parts specified by the manufacturer, or those with the same characteristics and performance as the original parts. Use of unauthorized parts can result in fire, electric shock and/or other danger.

17. Overloading---Do not overload wall outlets, extension cords, or convenience receptacles on other equipment as this can result in a risk of fire or electric shock.

18. Entering of objects and liquids---Never insert an object into the product through vents or openings. High voltage flows in the product, and inserting an object can cause electric shock and/or short internal parts. For the same reason, do not spill water or liquid on the product.

19. Damage requiring service---If any of the following conditions occurs, unplug the power cord from the AC outlet, and request a qualified service person to perform repairs.

- When the power cord or plug is damaged.
- When a liquid is spilled on the product or when objects have fallen into the product.
- When the product has been exposed to rain or water.
- When the product does not operate properly as described in the operating instructions.

Do not touch the controls other than those described in the operating instructions. Improper adjustment of controls not described in the instructions can cause damage, which often requires extensive adjustment work by a qualified technician.

- If the product has been dropped or the cabinet has been damaged in any way.
- When the product displays an abnormal condition or exhibits a distinct change in performance. Any noticeable abnormality in the product indicates that the product needs servicing.

20. Safety checks---Upon completion of service or repair work, request the service technician to perform safety checks to ensure that the product is in proper operating condition.

21. Wall or ceiling mounting---When mounting the product on a wall or ceiling, be sure to install the product according to the method recommended by the manufacturer. This is a safety feature.

Important Safety Precautions (continued)

22. Power source---This product is intended to be supplied by a listed power supply indicated on the marking label. If you are not sure of the type of power supply to your home, consult your product dealer or local power company. For added protection for this product during a lightning storm, or when it is left unattended and unused for long periods of time, unplug it from the wall outlet and disconnect the cable system. This will prevent damage to the product due to lightning and power line surges. When the unit has to be used with another power supply voltage, the power cable must be changed. Consult your product dealer. The socket outlet should be installed near the equipment and easily accessible. Use only the power cord designated by our dealer to ensure safety and EMC. When connecting other products such as VCRs and personal computers, you should turn off the power of the unit for protection against electric shock.

23. Panel protection---The LCD panel used in this product is made of glass. Therefore, it can break when the product is dropped or impacted upon by other objects. Be careful not to be injured by broken glass pieces in case the LCD panel breaks.

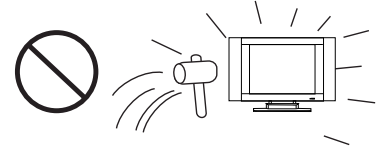

24. Pixel defect---The LCD panel is a very high technology product, giving you finely detailed pictures. Occasionally, a few non-active pixels may appear on the screen as a fixed point of blue, green or red. Please note that this does not affect the performance of your product.

Preparations

Using the Remote Control

- Use the remote control by pointing it towards the remote sensor window of the set. Objects between the remote control and sensor window may prevent proper operation.

Note: This illustration is for reference only. The remote sensor may be in different locations on different models.

Cautions regarding use of remote control

- Do not expose the remote control to shock. In addition, do not expose the remote control to liquids, and do not place in an area with high humidity.
- Do not install or place the remote control under direct sunlight. The heat may cause deformation of the unit.
- The remote control may not work properly if the remote sensor window of the main unit is under direct sunlight or strong lighting. In such a case, change the angle of the lighting or the LCD Monitor, or operate the remote control closer to the remote sensor window.

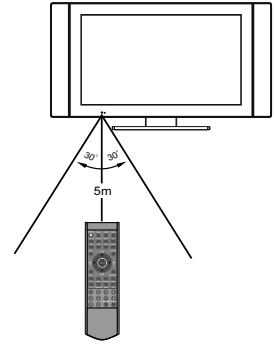

Batteries for the Remote Control

If the remote control fails to operate the LCD Monitor functions, replace the batteries in the remote control.

1 Open the battery cover.

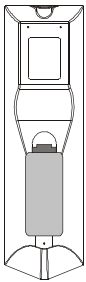

2 Insert two size-AAA batteries.

- (Place the batteries with their terminals corresponding to the (+) and (-) indications in the battery compartment.)

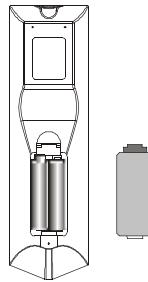

3 Replace the cover.

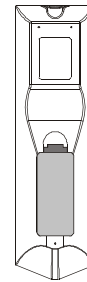

Precaution on battery use

Improper use of batteries can result in a leakage of chemicals and/or explosion. Be sure to follow the instructions below.

- Place batteries with their terminals corresponding to the (+) and (-) indications.
- Different types of batteries have different characteristics. Do not mix batteries of different types.
- Do not mix old and new batteries. Mixing old and new batteries can shorten the life of new batteries and/or cause old batteries to leak chemicals.
- Remove batteries as soon as they are non-operable. Chemicals that leak from batteries can cause a rash. If chemical leakage is found, wipe with a cloth.
- The batteries supplied with the product may have a shorter life expectancy due to storage conditions.
- If the remote control is not used for an extended period of time, remove the batteries from the remote control.

Power Connection

Insert the AC plug into a conveniently located AC outlet.

Note:

- This product should be operated only from the type of power source indicated on the marking label.
- Always unplug the AC cord from power outlet when not using for a long period of time.

Identification of Controls

Main unit

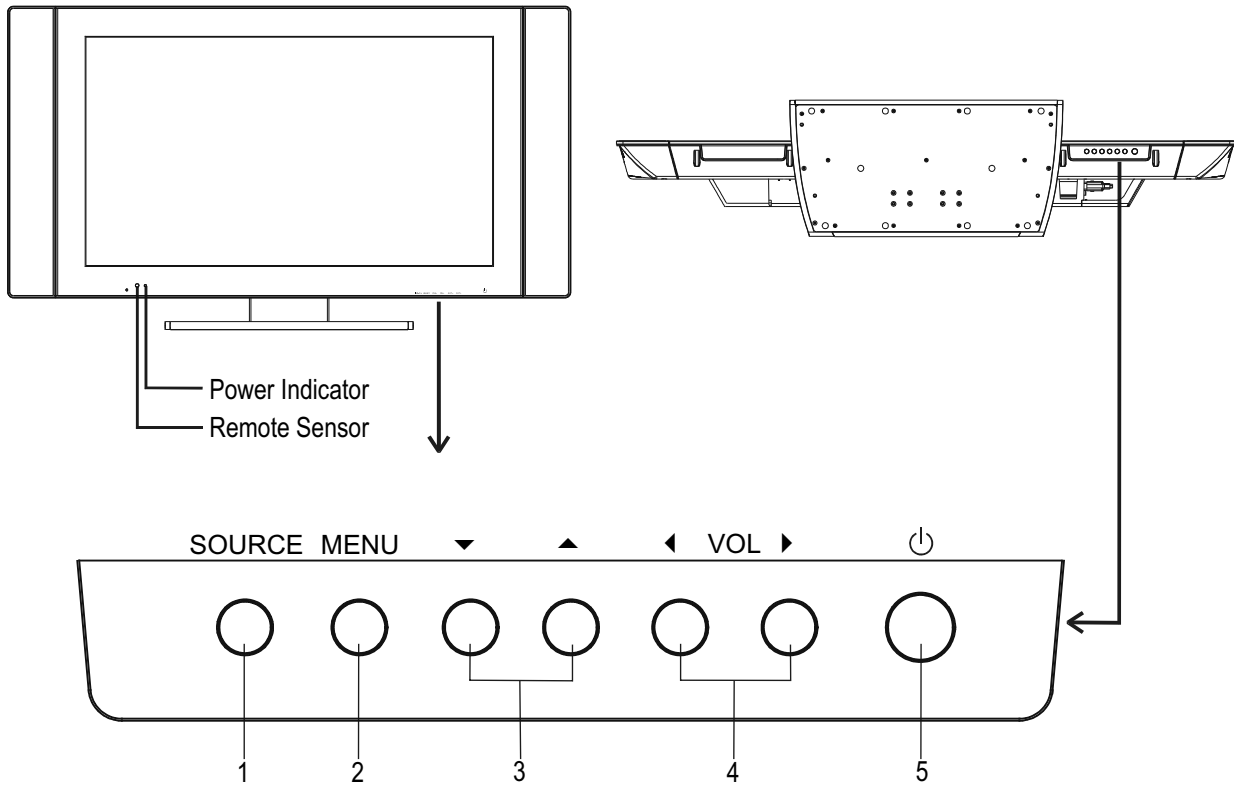

1. SOURCE

To access signal source select menu

2. MENU

Press this button to access the Menu main page

3. ∇/\blacktriangle

In OSD menu, press these buttons to select OSD items.

4. VOL $\blacktriangle/\blacktriangleleft$

Press the **VOL \blacktriangle** or **VOL \blacktriangleleft** button to directly increase or decrease the sound volume level;

In OSD Menu, press these buttons to adjust the value or setting of each item

5. POWER ⏻

Press this button to turn the unit ON from STANDBY mode. Press it again to turn the set back to STANDBY.

Note:

Functions of VOL $\blacktriangle/\blacktriangleleft$, $\blacktriangle/\blacktriangledown$, MENU, SOURCE and POWER ⏻ are also provided to the remote control. This operation manual provides a description based on operating functions with the remote control.

Identification of Controls (continued)

Main Unit

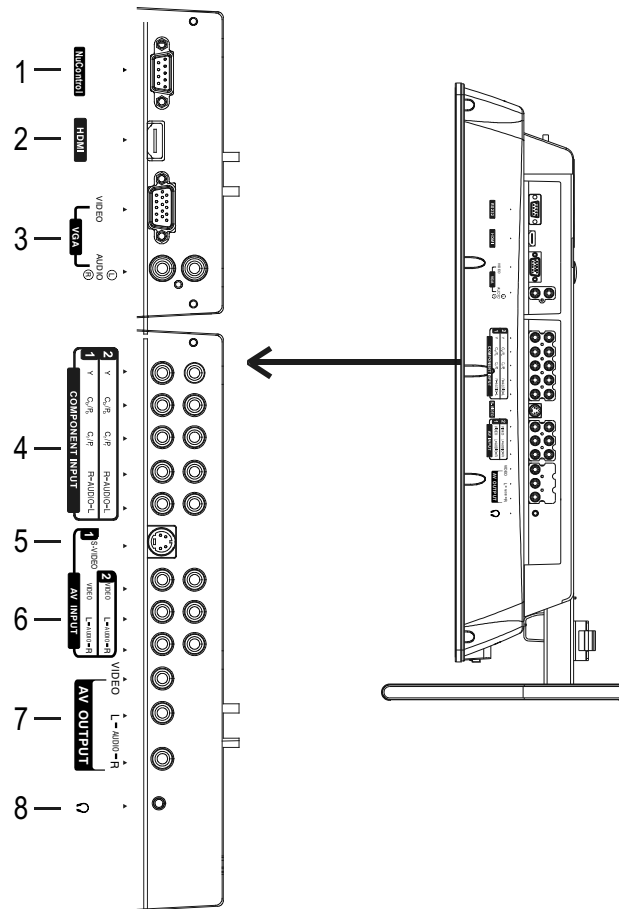

1. Nucontrol interface

For service only. The user cannot operate the unit through the NuControl interface.

2. HDMI interface

3. VGA input

Connect to the VGA/audio output jacks from your computer.

4. Component inputs (Y, Cb/Pb, Cr/Pr, Audio R, L)

Connect to the component and audio output sockets of a DVD player or Set-Top Box.

5. S-VIDEO input

Receive an S-Video signal from external source such as VCR or DVD player.

6. AV inputs (Video, Audio L, R)

Receive video/audio signals from external sources such as VCR or DVD player.

7. AV Outputs (Video, Audio L, R)

8. Headphone Jack

Identification of Controls (continued)

Remote Control

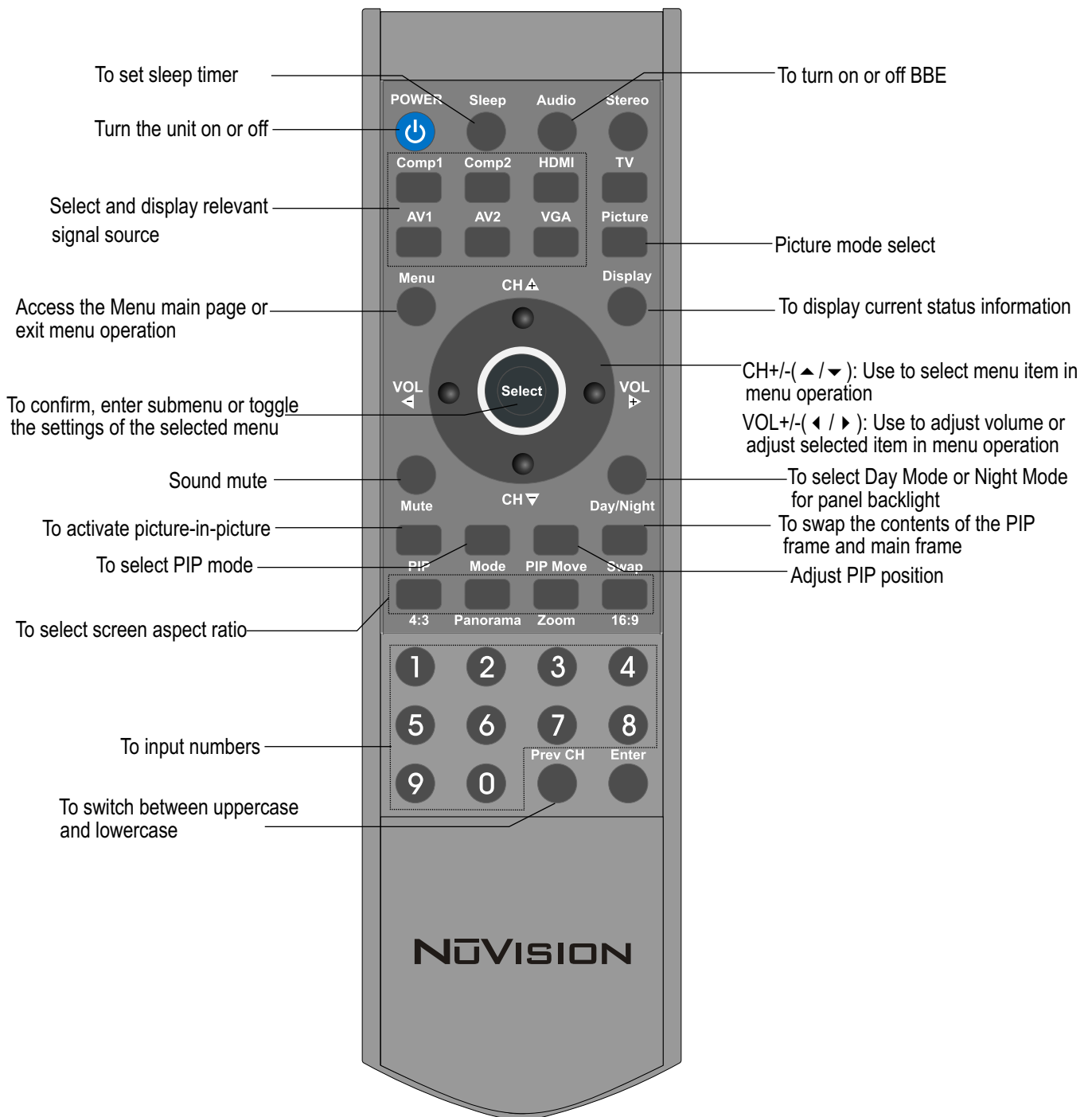

Note: The above buttons without description are not active.

Connections

Cautions Before Connecting

- Carefully check the terminals for position and type before making any connections.
- The illustration of the external equipment may be different depending on your model.
- Loose connectors can result in image or color problems. Make sure that all connectors are securely inserted into their terminals. Refer to the operating manual of the external device as well.
- When connecting an external device, turn the power off on the panel to avoid any issues.

Connect a VCR

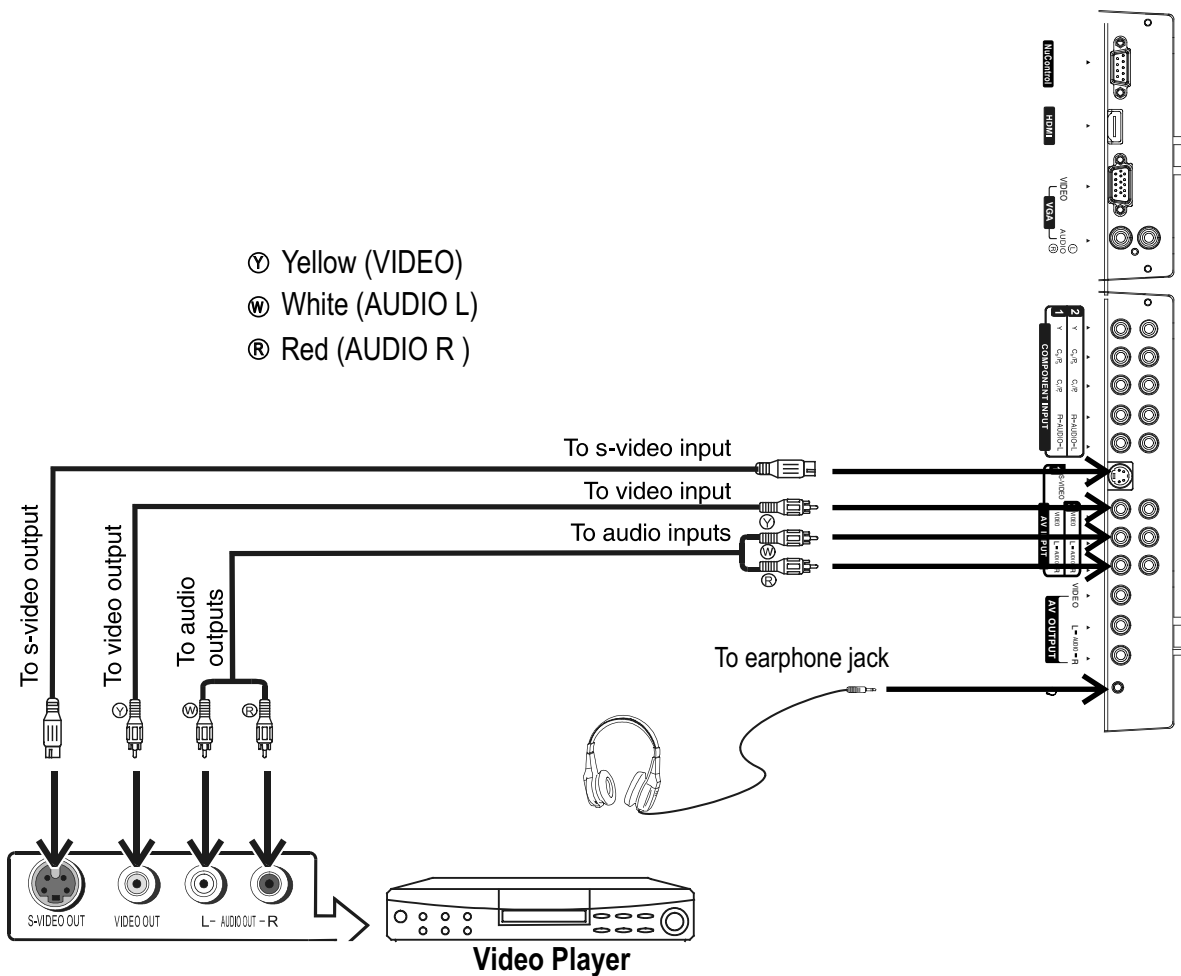

How to connect:

Connect the Audio/Video cables between the Audio (L/R)/Video jacks on the unit and VCR.

Note:

The Video terminal of the AV INPUT(1) and the S-Video terminal share the same audio input terminals. For better video, you can use the S-Video terminal if your source supports it.

The S-Video terminal is prior to Video terminal when they are connected at the same time. To use Video terminal, you should disconnect S-Video.

To play VCR

1. Turn on your LCD monitor, press **AV1** button on the remote control.
2. Turn on your VCR, insert a videotape and press the Play button.

Connections (continued)

Connect a Camcorder

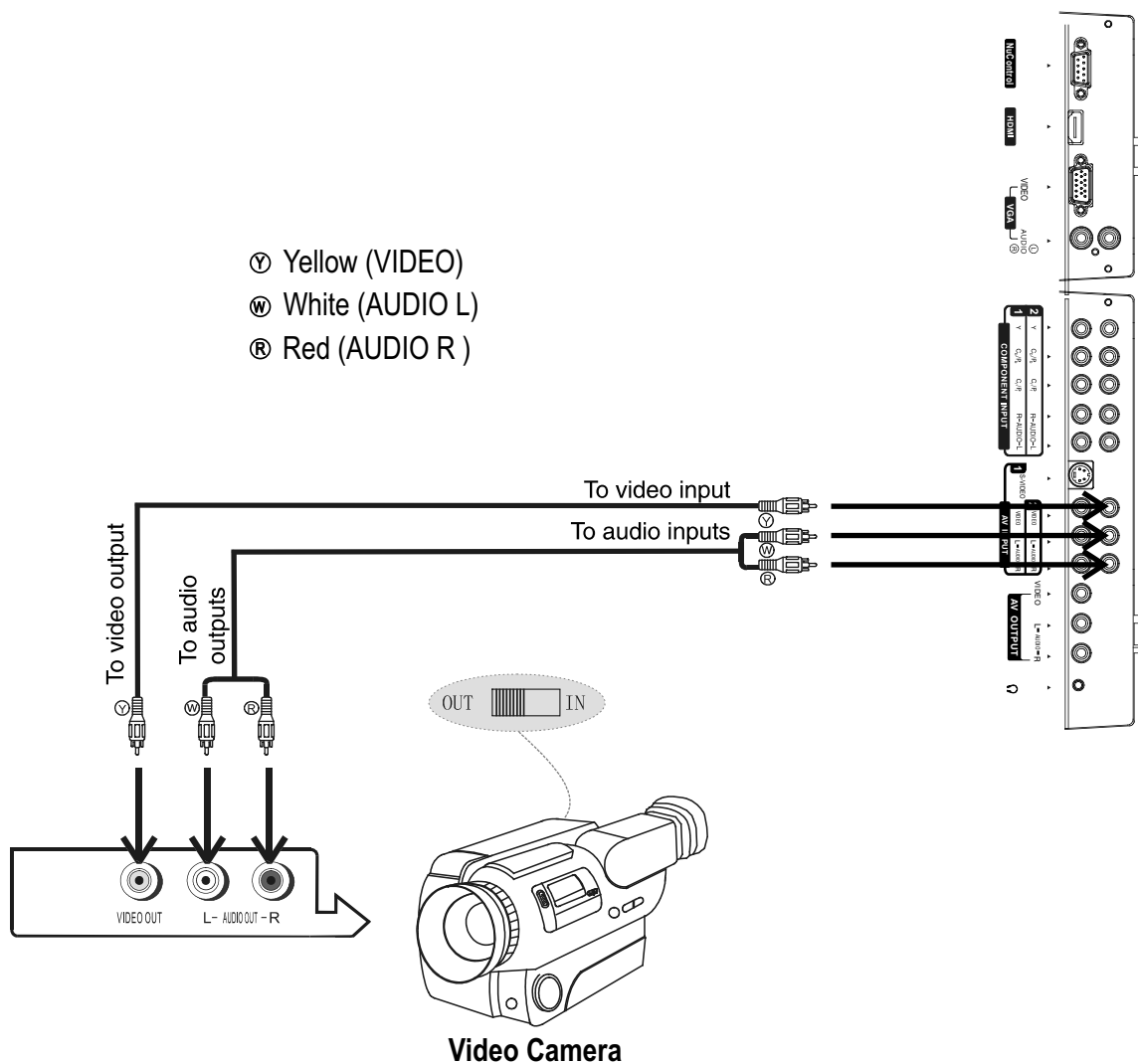

How to connect:

Connect the Audio/Video cables between the Audio (L/R)/Video jacks on the unit and camcorder.

To playback Camcorder

1. Turn on your LCD monitor, press **AV2** button on the remote control.
2. Turn on your camcorder and set it to output mode. (For details, refer to your camcorder owner's manual.)
3. Insert the tape into the camcorder and press Play button.

Note:

The operations of the camcorder may be different and is dependent on your model.
Please read the owner's manual of your camcorder to confirm operation.

Connections (continued)

Connect a DVD player

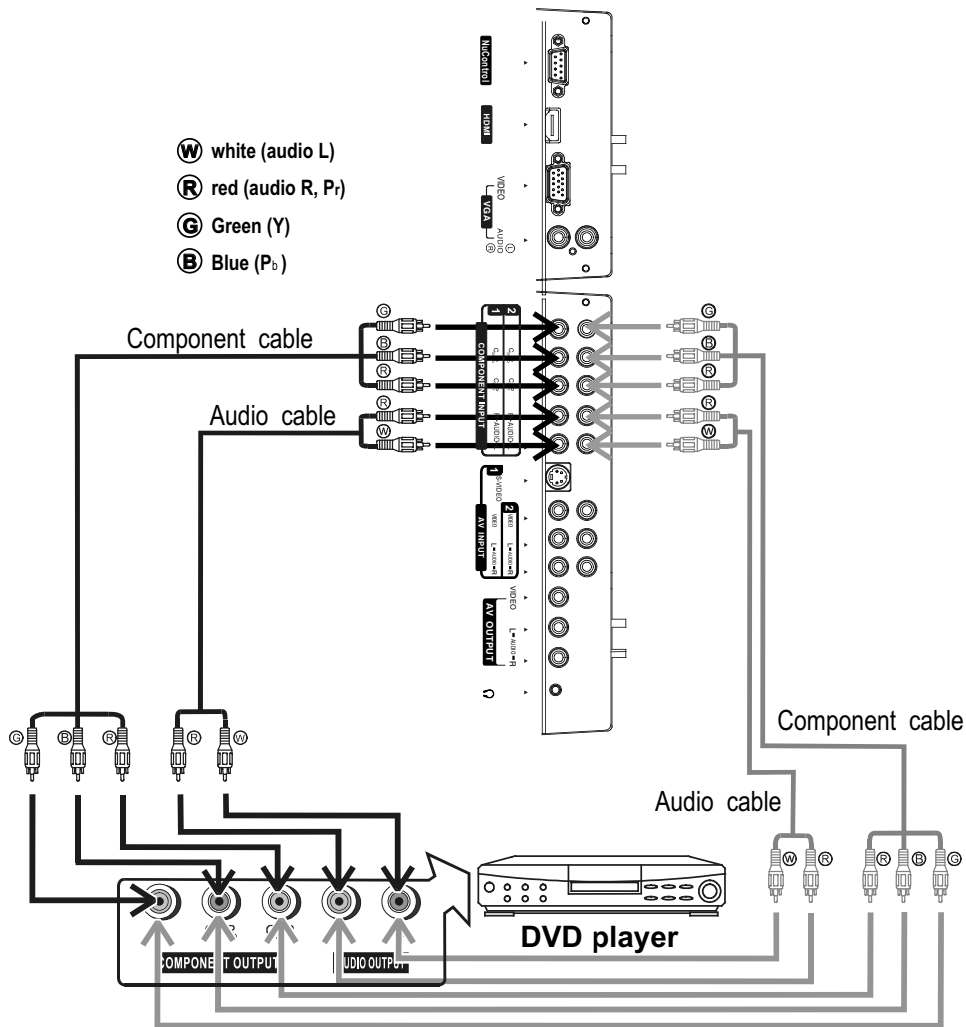

How to connect a DVD Player using Component Video Connections:

Connect the Video cable between the Y, Cb/Pb, Cr/Pr input jacks on the unit and Y, Cb/Pb, Cr/Pr output jacks on the DVD player .
Connect the Audio cable between the AUDIO input jacks on the unit and AUDIO output jacks on the DVD player.

To play DVD

1. Turn on your LCD monitor, press **Comp1** button or **Comp2** button on the remote control.
2. Turn on your DVD player.

Connect a product to HDMI

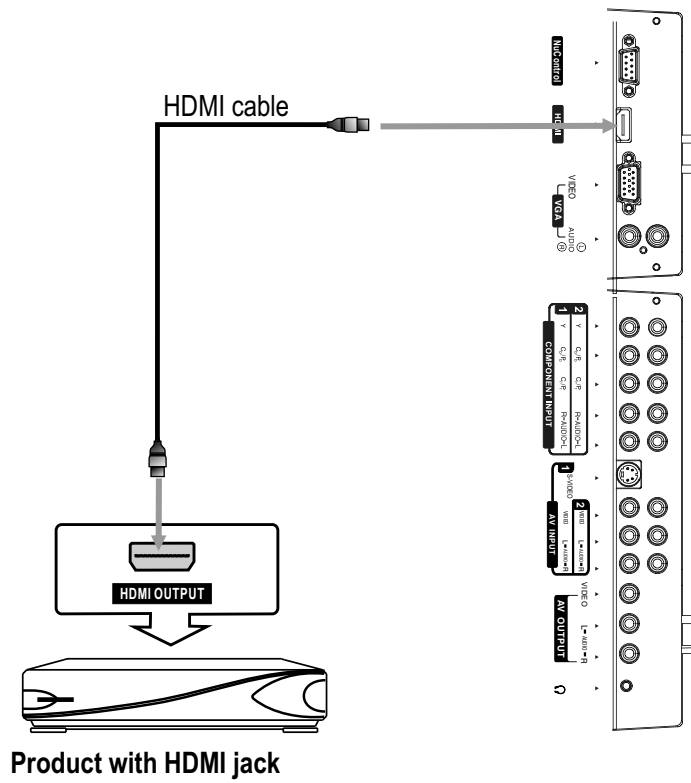

How to connect:

Connect the HDMI cable between the HDMI input jack on the unit and HDMI output jack on the product.

Note:

The HDMI Sources are compatible with DVI displays through the use of a passive cable converter. So you may connect product with DVI output jack to the unit.

Connect a passive cable converter between the HDMI input jack on the unit and DVI output jack on the product.

Connect an Audio cable between the AUDIO output on your product and AUDIO input jack of **VGA** on the unit.

To Watch your Product

1. Turn on your LCD monitor, press **HDMI** button on the remote control.
2. Turn on your product.

Connections (continued)

Connect a PC

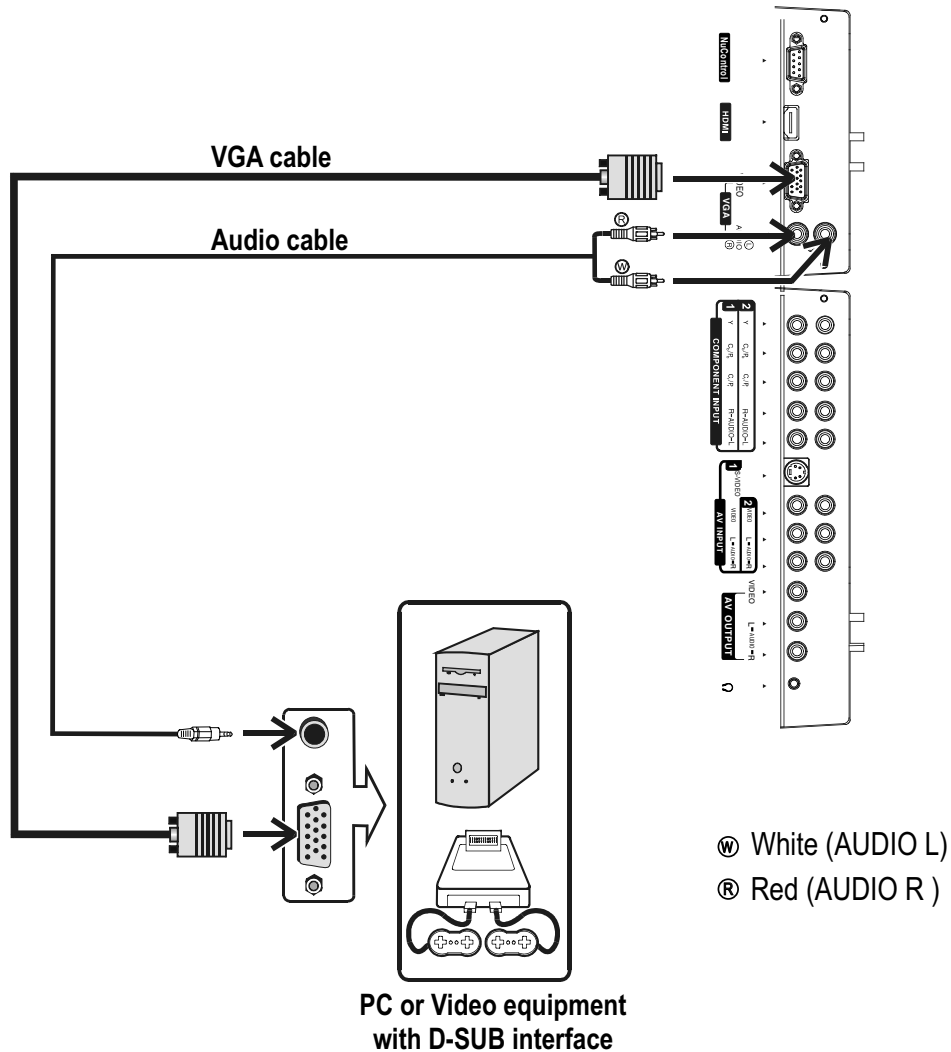

How to connect:

Connect a VGA cable between the VGA jack on the PC and the VGA input jack on the unit.

Connect an Audio cable between the AUDIO output on the PC and AUDIO input jacks on the unit.

To Watch the PC screen

1. Turn on your LCD monitor, press **VGA** button on the remote control.
2. Turn on your PC and check for PC system requirements.
3. Adjust the screen resolution and settings on your computer to the preferred settings.
4. For better picture quality set the computer's screen resolution to 1024x768 or 1280x768.

Turning the Unit On and Off

Turning the Unit On and Off

Turning On

Insert the power cord into the wall outlet.
Press the **Power** button on the remote control.
The unit will be turned on and you will be ready to use its features.

Turning Off

With the power on, press the **Power** button on the remote control to turn off the unit.

Note:

You can also use the **Power** button on the control panel on the main unit.

Viewing the Menu and Displays

Your LCD monitor has a easy-to-use menu system that appears on the screen. This system makes it convenient and fast to use features on the unit. The unit also lets you display the status of many of your LCD monitor features.

Viewing the Menus

- 1 With the power on, press the **MENU** button on the remote control. The main menu appears on the screen.
- 2 Use ◀ or ▶ to select menu page, use ▼ to enter the menu page.
- 3 Use the ▲ or ▼ to select menu item. Use ◀ or ▶ to adjust value of item. Use ▶ or **Select** button to confirm or enter submenu .
You can press the **MENU** button repeatedly to exit the menu operations.

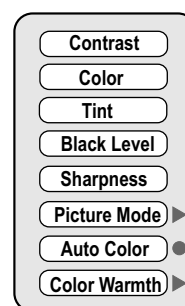

(The above OSD is shown as an example.)

Note:

1. To clearly introduce the menu operations , this operation manual provides a description based on operation with the remote control.
2. In most cases the function of Select button is equal to ▶ button.

Displaying Status Information

Press the **Display** button on the remote control, the unit will display current status information such as signal source etc.

Adjusting the Volume

Using the volume buttons (VOL+ and VOL-)

Press the **VOL +** or **VOL-** to increase or decrease the volume.

Using the Mute

Using the MUTE button

At any time, you can temporarily cut off the sound using the **MUTE** button.

- 1 Press the **MUTE** button and the sound cuts off.
- 2 To turn sound on, press the **MUTE** button again.

Basic Operations

Selecting Input Signal

You can directly select input source by using buttons on the remote control.

Comp1 -----Select signal from COMPONENT INPUT(1) terminals.

Comp2 -----Select signal from COMPONENT INPUT(2) terminals.

HDMI -----Select signal from HDMI interface.

AV1-----Select signal from AV INPUT(1)/S-VIDEO terminals.

AV2-----Select signal from AV INPUT(2) terminals.

VGA-----Select signal from VGA interface.

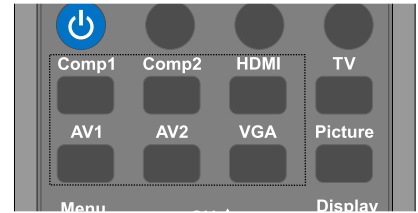

Editing Input Label

- 1 Press **MENU** to display the menu main page.
- 2 Press **◀** or **▶** repeatedly to select **Input Settings** menu.
- 3 Press **▼** to select **Input Label** item.
- 4 Press **▶** to access the submenu.
- 5 Use **▲** or **▼** to select input source which you want to edit.
- 6 Press **Select** and then use **◀ ▶ ▲ ▼** or 0-9 number buttons to edit the Input Label. After finishing editing, press **Select** to exit editing.
You can use **Prev CH** to switch between uppercase and lowercase.

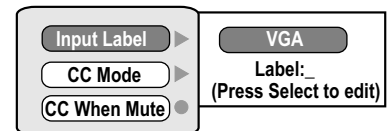

Selecting a Menu Language

- 1 Press **MENU** to display the menu main page.
- 2 Press **◀** or **▶** repeatedly to select **Preferences Settings** menu.
- 3 Press **▼** repeatedly to select **Language** item.
- 4 Press **▶** access the submenu.
- 5 Press **▲** or **▼** to select among **English**, **Français** and **Español** .

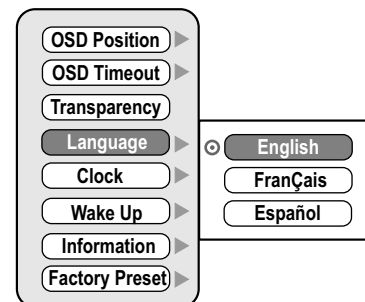

Setting Picture

Customizing the Picture

- 1 Press **MENU** to display the menu main page.
The **Picture** menu page will be displayed automatically.
- 2 Press **▼** to access .
- 3 Press **▲** or **▼** to select the item you wish to adjust.
- 4 Press **◀** or **▶** to adjust the value of the item.

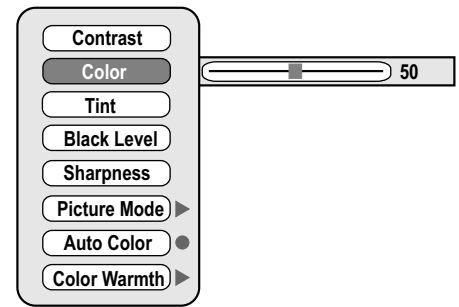

In AV mode

Option	Function	Operation
Contrast	Adjusts image contrast.	◀ : weaker ▶ : stronger
Color	Adjusts color saturation.	▶ : deeper ◀ : paler
Tint	Adjusts tint for image.	▶ : greenish ◀ : purplish
Black Level	Adjusts screen brightness for easier viewing of dark picture such as night scenes.	▶ : lighter ◀ : darker
Sharpness	Adjusts image sharpness and displays a sharp image.	▶ : sharper ◀ : softer

Using the Preset Picture Mode

- 1 Press **MENU** to display the menu main page.
The **Picture** menu page will be displayed automatically.
- 2 Press **▼** repeatedly to select **Picture Mode** item.
- 3 Press **▶** access the submenu.
- 4 Press **▲** or **▼** to select a desired picture mode.

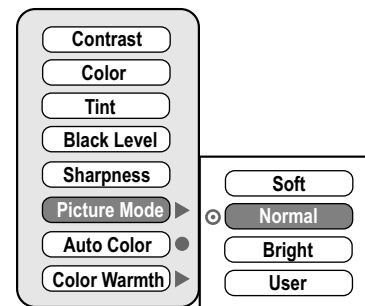

There are three preset picture modes (**Soft**, **Normal** and **Bright**) and one user-set picture mode (**User**). Each preset mode has its own picture settings.

Soft: Select for a finely detailed picture.

Normal: Select for a normal picture.

Bright: Select for a bright picture.

This item will be set to **User** automatically when you customize the picture.

You may directly use the **Picture** button on the remote control to select a desired picture mode.

Setting Picture (continued)

Setting Auto Color Function On or Off

1 Press **MENU** to display the menu main page.
The **Picture** menu page will be displayed automatically.

2 Press **▼** repeatedly to select **Auto Color** item.

3 Press **▶** repeatedly to activate the function or not.

If you want to activate the function, please press **▶** to confirm when the item is selected, you use this function to reduce color and tint variations.



Selecting the Preset Color Warmth Mode

1 Press **MENU** to display the menu main page.
The **Picture** menu page will be displayed automatically.

2 Press **▼** repeatedly to select **Color Warmth** item.

3 Press **▶** access the submenu.

4 Press **▲** or **▼** to select between **Warm**, **Normal** and **Cool**.

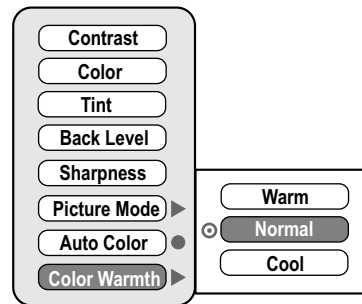

Changing Screen Aspect Ratio

You can select the image aspect ratio by using **16:9**, **4:3**, **Panorama** and **Zoom** button.

16:9 — For 16:9 signal format. This mode expands the picture into a full 16:9 picture.

4:3 — For 4:3 signal format. This mode displays a 4:3 picture at its standard 4:3 size without any stretching.

Panorama — For 4:3 signal format. In this mode the picture is progressively stretched toward each side of the screen.

Zoom — For 4:3 letterbox signal format. This mode stretches the picture horizontally and crops the top and bottom black bars of the picture.

Setting Sound

Customizing the Sound

- 1 Press **MENU** to display the menu main page.
- 2 Press ◀ or ▶ repeatedly to select **Audio** menu.
- 3 Press ▼ to access.
- 4 Press ▲ or ▼ repeatedly to select items you want to adjust.
- 5 Press ◀ or ▶ to adjust the value or ▶ to confirm.

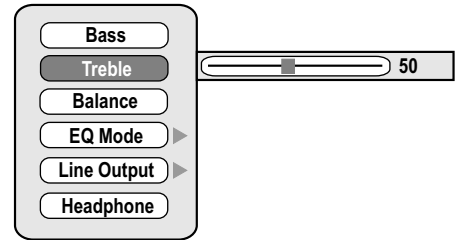

Option	Function	Operation
Bass	Adjusts Bass (low sounds)	▶ : stronger ◀ : weaker
Treble	Adjusts Treble (high sounds).	▶ : stronger ◀ : weaker
Balance	Adjusts volume balance (left and right volumes).	▶ :Higher volume from right speaker. ◀ :Higher volume from left speaker.
Headphone	Headphone volume control	▶ : increase the headphone volume ◀ : decrease the headphone volume

Note:

Only when the headphone is inserted or PIP is activated, the **Headphone** item can be adjusted.

Setting the Line Output

- 1 Press **MENU** to display the menu main page.
- 2 Press ◀ or ▶ repeatedly to select **Audio** menu.
- 3 Press ▼ repeatedly to select **Line Output** item.
- 4 Press ▶ to access submenu.
- 5 Press ▲ or ▼ to select a desired Line Output mode.

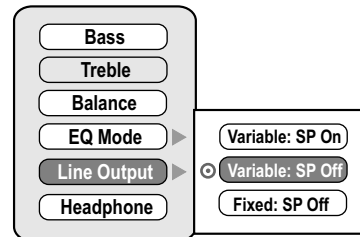

There are three Line output modes (**Variable: SP On**, **Variable: SP Off** and **Fixed: SP Off**)

Variable: SP On: When this mode is selected, the sound is output from speaker and you can adjust the volume from the monitor.

Variable: SP Off: In this mode, the monitor is mute while the sound is output from the connected Audio Amplifier and you can adjust the volume from the monitor.

Fixed: SP Off : In this mode, the monitor is mute while the sound is output from connected Audio Amplifier and you cannot adjust the volume from the monitor.

Note: Be sure the external audio amplifier is connected properly.

Using the Preset Sound Mode

- 1 Press **MENU** to display the menu main page.
- 2 Press ◀ or ▶ repeatedly to select **Audio** menu.
- 3 Press ▼ repeatedly to select **EQ Mode** item.
- 4 Press ▶ to access submenu.
- 5 Press ▲ or ▼ to select a desired sound mode.

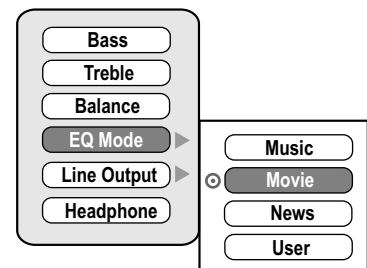

There are three preset sound modes (**Music**, **Movie** and **News**) and one user-set sound mode (**User**). Each preset mode has its own sound settings(Bass and Treble).

Music: Select for a music program.

Movie: Select for a movie program.

News: Select for a speech or conversation program.

This item will be set to **User** automatically when you customize the sound.

Adjusting On-Screen Display

Adjusting OSD Position

- 1 Press **MENU** to display the menu main page.
- 2 Press **◀** or **▶** repeatedly to select **Preferences Settings** menu.
- 3 Press **▼** to select **OSD Position** item.
- 4 Press **▶** to access.
- 5 Press **▲/▼/◀/▶** to adjust OSD position.

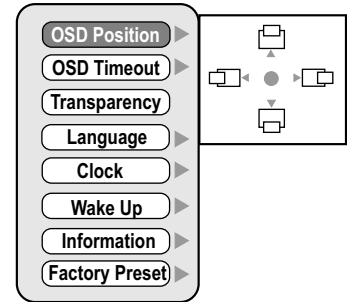

Setting OSD Timeout

This setting allows you to set the time for the main OSD menu to be displayed on the screen.

- 1 Press **MENU** to display the menu main page.
- 2 Press **◀** or **▶** repeatedly to select **Preferences Settings** menu.
- 3 Press **▼** repeatedly to select **OSD Timeout** item.
- 4 Press **▶** to access the submenu.
- 5 Press **▲** or **▼** to select a proper time.

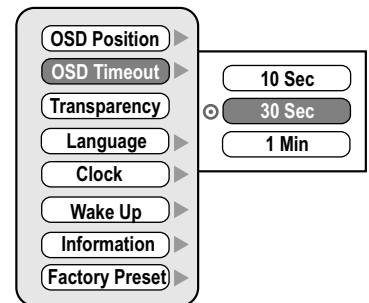

Adjusting OSD Transparency

- 1 Press **MENU** to display the menu main page.
- 2 Press **◀** or **▶** repeatedly to select **Preferences Settings** menu.
- 3 Press **▼** repeatedly to select **Transparency** item.
- 4 Press **◀** or **▶** to adjust.

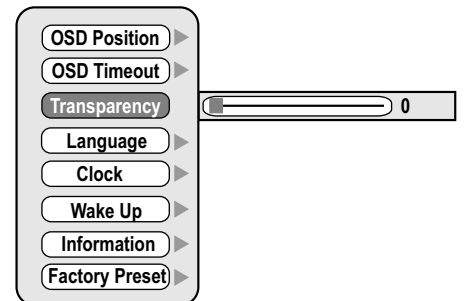

Setting System

Setting Clock timer

- 1 Press **MENU** to display the menu main page.
- 2 Press **◀** or **▶** repeatedly to select **Preferences Settings** menu.
- 3 Press **▼** to select **Clock** item.
- 4 Press **▶** to enter.
- 5 Press **▲ ▼ ◀ ▶** or 0-9 number buttons to adjust clock time.

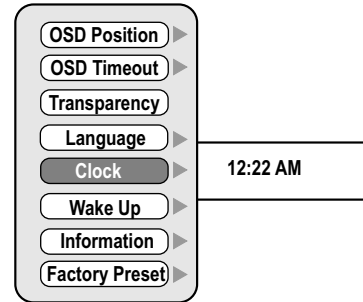

Setting Wake Up Timer

- 1 Press **MENU** to display the menu main page.
- 2 Press **◀** or **▶** repeatedly to select **Preferences Settings** menu.
- 3 Press **▼** to select **Wake Up** item.
- 4 Press **▶** to enter.
- 5 Press **▲ ▼ ◀ ▶** or 0-9 number buttons to obtain desired wake up time.

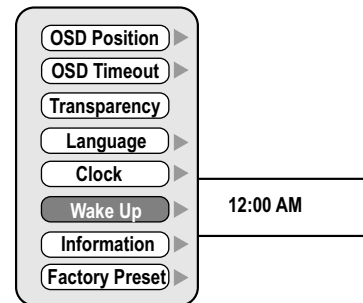

Displaying Signal Source Information

This setting allows you to obtain the detailed information about the input source signal.

- 1 Press **MENU** to display the menu main page.
- 2 Press **◀** or **▶** repeatedly to select **Preferences Settings** menu.
- 3 Press **▼** repeatedly to select **Information** item.

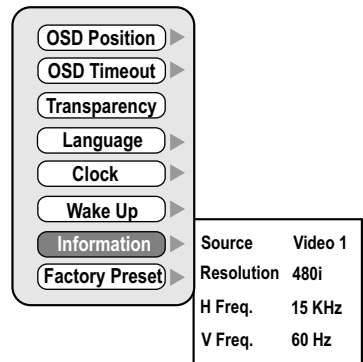

Loading Default Values

- 1 Press **MENU** to display the menu main page.
- 2 Press **◀** or **▶** repeatedly to select **Preferences Settings** menu.
- 3 Press **▼** repeatedly to select **Factory Reset** item.
- 4 Press **▶** twice to select **Yes**.
- 5 Press **▶** to confirm.

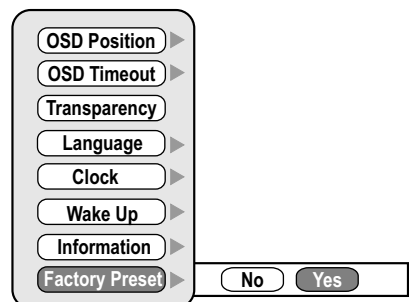

Note:

Be careful to use this function, once you confirm to use this function, all your settings will be reset and the unit loads default values.

PIP Operations

Viewing and adjusting the Size of PIP Frame

- 1 Press **MENU** to display the menu main page.
- 2 Press ◀ or ▶ repeatedly to select **PIP Mode** menu.
- 3 Press ▼ repeatedly to select a desired size of PIP frame.
You may select between **Small**, **Medium** and **Large**.
- 4 Press ▶ to confirm.

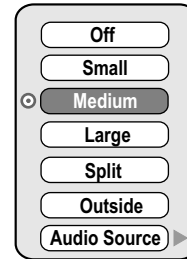

You may directly use the **PIP** button to activate picture-in-picture and **MODE** button to change the size of the PIP frame when viewing picture-in-picture.

Turning Off the PIP Frame

- 1 Press **MENU** to display the menu main page.
- 2 Press ◀ or ▶ repeatedly to select **PIP Mode** menu.
- 3 Press ▼ to select **Off** item.
- 4 Press ▶ to confirm.

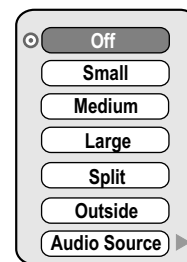

Adjusting the Volume for the PIP Frame

- 1 With the PIP working, press **MENU** to display the menu main page.
- 2 Press ◀ or ▶ repeatedly to select **Audio** menu.
- 3 Press ▼ repeatedly to select **Headphone** item.
- 4 Press ◀ or ▶ to adjust.

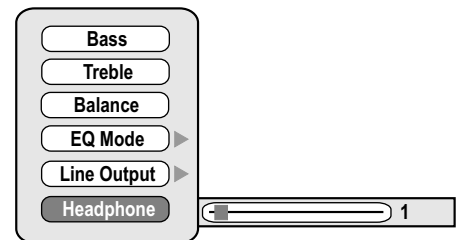

Normally the PIP audio is output through the headphone jack. (But you can change it).

Swapping the Contents of the PIP Frame and Main Frame

With the PIP working, press **SWAP** button to swap the contents of the PIP frame and main frame.

Changing the Position of the PIP Frame

With the PIP working, use **PIP Move** button on the remote control to move PIP frame to a different position on the screen.

PIP Operations(continued)

Selecting Speaker Output Source

- 1 Press **MENU** to display the menu main page.
- 2 Press **◀** or **▶** repeatedly to select **PIP Mode** menu.
- 3 Press **▼** repeatedly to select **Audio Source** item.
- 4 Press **▶** to access submenu.
- 5 Press **▲** or **▼** to select either Main Source or Pip Source.

If you choose **Main Source**, the speaker outputs main frame sound; if **Pip Source** is selected, the speaker output PIP frame sound.

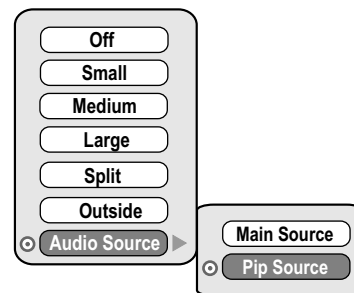

Viewing Picture-by-Picture

- 1 Press **MENU** to display the menu main page.
- 2 Press **◀** or **▶** repeatedly to select **PIP Mode** menu.
- 3 Press **▼** repeatedly to select **Split** item.
- 4 Press **▶** to confirm.

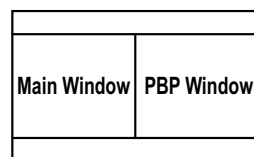
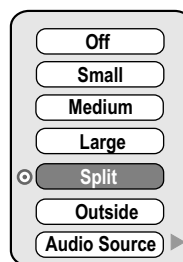

Viewing Picture-out-Picture

- 1 Press **MENU** to display the menu main page.
- 2 Press **◀** or **▶** repeatedly to select **PIP Mode** menu.
- 3 Press **▼** repeatedly to select **Outside** item.
- 4 Press **▶** to confirm.

You may directly use the **MODE** button to activate the Split (PBP) or Outside (POP) function.

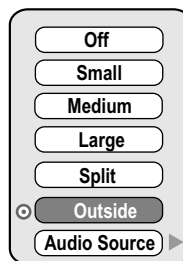

POP Window

Adjustment in VGA/HDMI/Component Mode

Be sure to select the correct source before operation.

Selecting the Preset Color Warmth Mode

- 1 Press **MENU** to display the menu main page.
The **Picture** menu page will be displayed automatically.
- 2 Press **▼** repeatedly to select **Color Warmth** item.
- 3 Press **▶** access the submenu.
- 4 Press **▲** or **▼** to select between **Warm**, **Normal** and **Cool**.

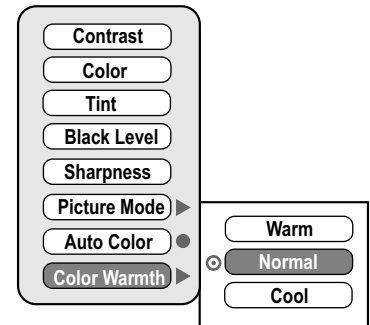

Adjusting the Picture Automatically(for VGA mode only)

- 1 Press **MENU** to display the menu main page.
- 2 Press **◀** or **▶** repeatedly to select **Screen Settings** menu.
- 3 Press **▼** to select **Auto VGA** item.
- 4 Press **▶** repeatedly to select **Yes**.
- 5 Press **▶** to start adjusting.

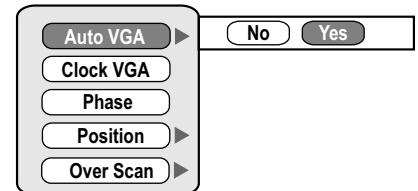

Adjusting the Clock (for VGA mode only)

- 1 Press **MENU** to display the menu main page.
- 2 Press **◀** or **▶** repeatedly to select **Screen Settings** menu.
- 3 Press **▼** repeatedly to select **Clock VGA** item.
- 4 Press **◀** or **▶** to adjust.

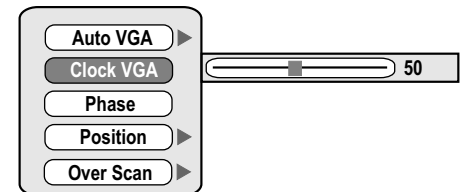

If shimmering or rainbow-like noise is apparent in the image, try to adjust the Clock item.

Adjustment in VGA/HDMI/Component Mode(continued)

Adjusting the Phase(for VGA and Component mode)

- 1 Press **MENU** to display the menu main page.
- 2 Press **◀** or **▶** repeatedly to select **Screen Settings** menu.
- 3 Press **▼** repeatedly to select **Phase** item.
- 4 Press **◀** or **▶** to adjust.

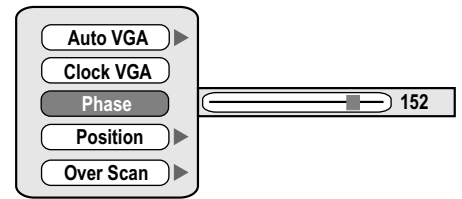

You may find that images blur, as the clock phase of your Pc's display varies. If you experience blurring, you can obtain a clearer image by adjusting the Phase item.

Changing the Position of Image(for VGA and Component mode)

Adjust the position of the screen if it is not well-aligned, you may try the **[Auto]** function firstly to adjust the picture in VGA mode.

- 1 Press **MENU** to display the menu main page.
- 2 Press **◀** or **▶** repeatedly to select **Screen Settings** menu.
- 3 Press **▼** repeatedly to select **Position** item.
- 4 Press **▶** to access.
- 5 Press **▲**/**▼**/**◀**/**▶** to adjust.

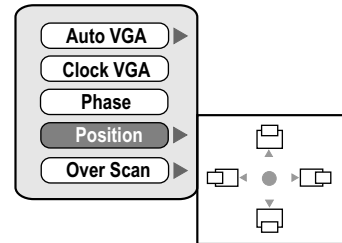

Setting Over Scan Function(for HDMI and Component mode)

- 1 Press **MENU** to display the menu main page.
- 2 Press **◀** or **▶** repeatedly to select **Screen Settings** menu.
- 3 Press **▼** repeatedly to select **Over Scan** item.
- 4 Press **▶** to access the submenu.
- 5 Press **▲** or **▼** to select.
This function is designed for you to adjust the reproduction ratio, you may activate this function to obtain a cleaner picture.
This item only works under HDTV signal source.

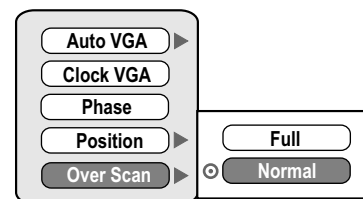

Using Hotkeys

Setting Sleep Timer

Press the Sleep button repeatedly to set a sleep time to automatically turn off the unit. With each press of the button, the value changes as below.

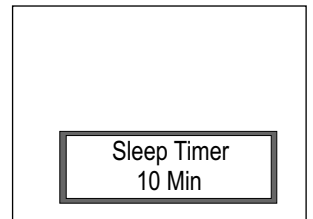
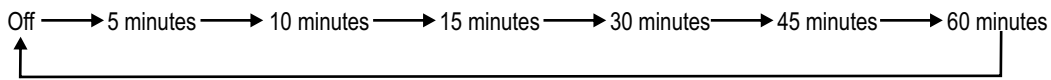

Setting BBE effect

Use the **Audio** button to quickly turn on or off the **BBE** effect.

BBE VIVA™ is a High Definition 3D Sound (HD3D) technology combines 3D audio processing with BBE High Definition Sound. VIVA creates an authentic and exciting 3D sound effect from stereo speakers while preserving the clarity, definition, presence and texture for which BBE High Definition Sound is noted.

Adjusting Back Light of the Panel

Press the **Day/Night** button repeatedly to select the back light brightness of the panel. There are two levels of the back light: **Day Mode** and **Night Mode**. Day Mode provides a brighter picture, while Night Mode provides a darker picture.

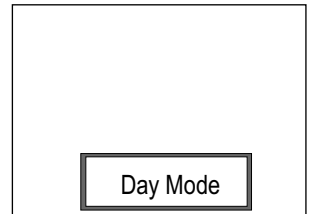

Viewing Closed Captions

Closed Caption will display text on the screen for hearing impaired viewers or it will translate and display text in another language.

Note:

The Caption feature only works in AV 1 and AV 2 mode.

Not all the programs and videos will offer closed captioning. Please look for the  symbol to ensure that captions will be shown.

Setting Closed Caption

- 1 Press **MENU** to display the menu main page.
- 2 Press **◀** or **▶** repeatedly to select **Input Settings** menu.
- 3 Press **▼** to select **CC Mode** item.
- 4 Press **▶** to access the submenu.
- 5 Press **▲** or **▼** to select a desired item.

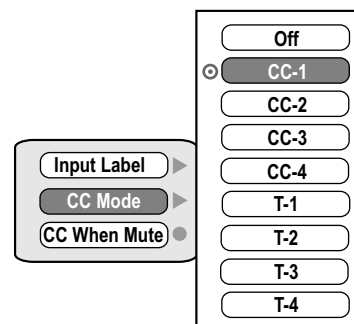

You may select between Off, CC-1, CC-2, CC-3, CC-4, T-1, T-2, T-3 and T-4.

The Closed Caption broadcasts can be viewed in two modes: CAPTION and TEXT. For each mode, four channels are available.

The [CAPTION] mode shows subtitles of dialogues and commentaries of video programs while allowing a clear view of the picture.

The [TEXT] mode displays various information over the picture that is independent of the video programs.

Setting CC When Mute

- 1 Press **MENU** to display the menu main page.
- 2 Press **◀** or **▶** repeatedly to select **Input Settings** menu.
- 3 Press **▼** repeatedly to select **CC When Mute** item.
- 4 Press **▶** repeatedly to activate this function or not.

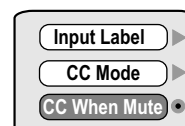

If you activate this function, the unit will automatically display closed caption when you mute the sound.

Adjusting Parental Control Settings

Parental Control

This function allows video programs to be restricted and video usage to be controlled based on FCC data. It prevents children from watching violent or sexual scenes that may be harmful.

Restriction of video programs includes two ratings that contain information about the program: the MPAA rating and the TV Parental Guidelines. The MPAA rating is restricted by age. TV Parental Guidelines are restricted by age and content.

Since a video program may use either the MPAA rating or the TV Guidelines, both should be adjusted for complete control.

Note: Parental Control function only works under AV1 and AV2 mode.

[1] Movie Rating (MPAA)

Rating		
age based	N/A	NOT RATED.
	G	GENERAL AUDIENCES. All ages admitted.
	PG	PARENTAL GUIDANCE SUGGESTED. Some material may not be suitable for children.
	PG-13	PARENTAL STRONGLY CAUTIONED. Some material may be inappropriate for children under 13.
	R	RESTRICTED. Under 17 requires accompanying parent or adult guardian.
	NC-17	NO ONE 17 AND UNDER ADMITTED.
	X	X Rating is an older rating that is unified with NC-17 but may be encoded in the data of older movies.

Note:

The Movie rating is only age-based.

Example 1:

“PG-13” in the age-based rating is blocked, this will automatically block the higher ratings “R”, “NC-17”, “X” also.

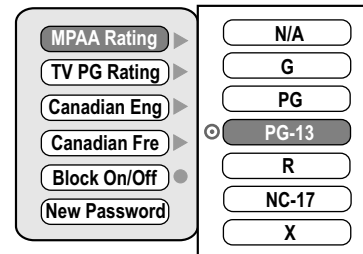

Example 2:

“R” in the age-based rating is blocked, this will automatically block the higher rating “NC-17”, “X” also.

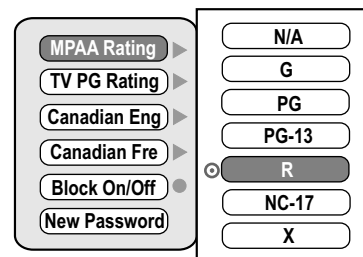

Adjusting Parental Control Settings (continued)

[2] TV PG Rating

Rating		← content based →				
		D	L	S	V	F-V
age based	TV-Y (All children)	×	×	×	×	×
	TV-Y7 (Direct to Older Children)	×	×	×	×	●
	TV-G (General Audience)	×	×	×	×	
	TV-PG (Parental Guidance Suggested)	●	●	●	●	
	TV-14 (Parents Strongly Cautioned)	●	●	●	●	
	TV-MA (Mature Audience Only)		●	●	●	

- × ——— Content Rating can be set but this Rating is not normally used.
- ——— Content Rating can be set.

D: Sexually Suggestive Dialog
 L: Adult Language
 S: Sexual Situation
 V: Violence
 F-V: Fantasy Violence

Note:

Age-based ratings can be modified by the content-based ratings but only in the combinations indicated by an ● in the table above. Choosing lower age-based rating blocks the higher age-based ratings regardless of content ratings settings.

Example 1:

When TV-Y7 in the age-based rating is set to BLOCK, this will automatically block the higher ratings: TV-G, TV-PG, TV-14 and TV-MA.

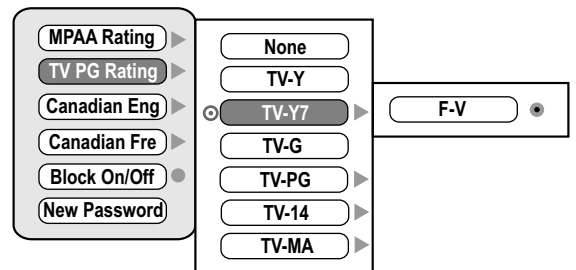

Example 2:

When TV-PG in the age-based rating is set to BLOCK, this will automatically block the higher ratings: TV-14 and TV-MA.

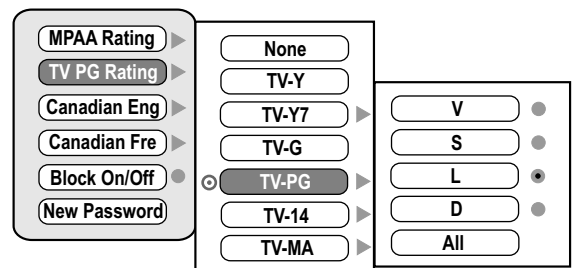

Adjusting Parental Control Settings (continued)

Password Setup

- 1 Press the **MENU** button to display the menu main page.
- 2 Press ◀ or ▶ repeatedly to select **Parental Controls** menu.
- 3 Press ▼ to access, now the unit requires you to input password.
Enter password with the **number buttons**, the default password is 0000. The unit allows you to access the Parental Controls menu if you input the right password, or you will be denied.
- 4 After entering the Parental Control menu, press ▼ repeatedly to select **New Password** item.
- 5 Press ▶ to access the submenu.
- 6 Input a new 4-digit password using number buttons, then confirm again, now the password has been modified successfully.
Be sure to write down your password and retain it for future use.

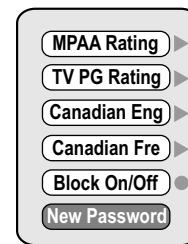

Turning Parental Control On or Off

- 1 After entering the **Parental Controls** menu page, press ▼ repeatedly to select **Block On/Off** item.
- 2 Press ▶ repeatedly to activate this function or not.
Only when this function is activated that all the Parental Control settings works.

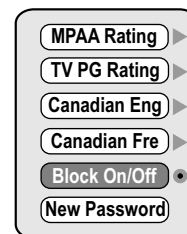

Adjusting the Movie Rating

- 1 Select **MPAA Rating** item after entering the **Parental Controls** menu page.
- 2 Press ▶ to access the submenu.
- 3 Press ▲ or ▼ repeatedly to select a desired rating you want to block.
For example, "PG-13" in the age-based rating is selected, this will automatically block the higher ratings "R", "NC-17", "X" also.

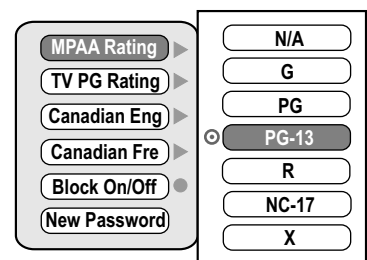

Adjusting the TV PG Rating

- 1 After entering the **Parental Controls** menu page, press ▼ repeatedly to select **TV PG Rating** item.
- 2 Press ▶ to access the submenu.
- 3 Press ▲ or ▼ repeatedly to select a desired rating you want to block.
This will automatically block the higher age-based ratings. You may set the individual content-based ratings as follow.
- 4 Press ▶ to access if you want to set content-based ratings.
- 5 Press ▲ or ▼ repeatedly to select a desired content rating.
- 6 Press ▶ repeatedly to block or unblock this rating.
- 7 Press **MENU** repeatedly to exit.

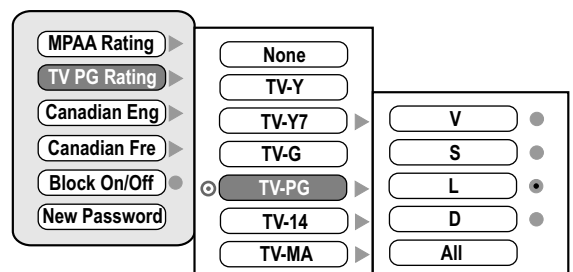

Adjusting Parental Control Settings (continued)

Adjusting Canadian English Rating

- 1 After entering the **Parental Controls** menu page, press ▼ repeatedly to select **Canadian Eng** item.
- 2 Press ▶ to access the submenu.
- 3 Press ▲ or ▼ repeatedly to select a desired rating you want to block.
- 4 Press the **MENU** button repeatedly to exit.

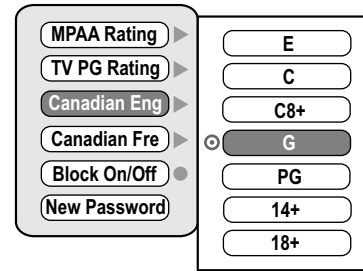

CANADIAN ENGLISH RATING CHART

E	Exempt - Exempt programming
C	Programming intended for children under age 8. No offensive language, nudity or sexual content.
C8+	Programming generally considered acceptable for children 8 years and over. No profanity, nudity or sexual content.
G	General programming, suitable for all audiences.
PG	Parental Guidance suggested. Some material may not be suitable for children.
14+	Programming contains themes or content which may not be suitable for viewers under the age of 14. Parents are strongly cautioned to exercise discretion in permitting viewing by pre-teens and early teens.
18+	Intended for viewers 18 years and older and might contain depictions of violence.

Adjusting Canadian French Rating

- 1 After entering the **Parental Controls** menu page, press ▼ repeatedly to select **Canadian Fre** item.
- 2 Press ▶ to access the submenu.
- 3 Press ▲ or ▼ repeatedly to select a desired rating you want to block.
- 4 Press **MENU** repeatedly to exit.

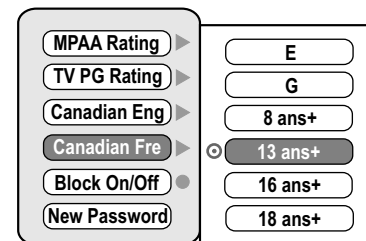

CANADIAN FRENCH RATING CHART

E	Exempt - Exempt programming.
G	General - Programming intended for audience of all ages. Contains no violence, or the violence content is minimal or is depicted appropriately.
8 ans+	8+ General - Not recommended for young children. Programming intended for a broad audience but contains light or occasional violence. Adult supervision recommended.
13 ans+	Programming may not be suitable for children under the age of 13 - Contains either a few violent scenes or one or more sufficiently violent scenes to affect them. Adult supervision strongly suggested.
16 ans+	Programming may not be suitable for children under the age of 16 - Contains frequent scenes of violence or intense violence.
18 ans+	Only for adult viewing. Could contain frequent violent scenes and extreme violence.

Troubleshooting

Before calling for repair service, check the following items for possible remedies to the encountered symptoms.

Symptoms	Check item
No power	<ul style="list-style-type: none"> ✍ Check that the AC power cord is plugged into the mains socket. ✍ Unplug the power cord, wait for 60 seconds. Then re-insert plug into the mains socket and turn on the unit again.
No picture	<ul style="list-style-type: none"> ✍ Check video connections at the rear of the unit to see if it is properly connected to the unit. ✍ Adjust the contrast and brightness settings. ✍ Select a correct input. ✍ Is a non-compatible signal being input?
Good picture but no sound	<ul style="list-style-type: none"> ✍ Increase the VOLUME. ✍ Check that the unit is not muted.
Good sound but poor color	✍ Adjust the contrast, color and brightness settings.
Poor picture	<ul style="list-style-type: none"> ✍ Sometimes, poor picture quality occurs when an activated S-VHS camera or camcorder is connected while another activated peripheral is connected. In this case, switch off one of the peripherals. ✍ Check whether the room is too bright.
Horizontal dotted line	<ul style="list-style-type: none"> ✍ This may be caused by electrical interference (e.g. hairdryer, nearby neon lights, etc.). ✍ Turn off the equipment.
Remote operation fails.	<ul style="list-style-type: none"> ✍ Check whether the batteries are working. Replace if necessary. ✍ Clean the remote control sensor lens on the unit. ✍ Do not use the remote control under strong or fluorescent lighting. ✍ The batteries should be inserted with polarity (+, -) aligned.
Snowy picture and noise	✍ Check the A/V connections.
No stable or not synchronized VGA picture	✍ Check if you have selected the correct VGA mode in your PC.
No output from one of the speakers	✍ Adjust Balance in the Audio menu.
Control buttons do not work.	✍ Unplug the power cord, wait for a few seconds. Then re-plug the power cord and turn on the unit again.

☞ Do not use in hot and cold rooms (locations)

- When the unit is used in rooms (locations) with low temperature, the picture may leave trails or appear slightly delayed. This is not a malfunction, and the unit will recover when the temperature returns to normal.
- Do not leave the unit in a hot or cold location. Also, do not leave the unit in a location exposed to direct sunlight or near a heater, as this may cause the cabinet to deform and the LCD panel to malfunction.
(Storage temperature: 0°C to +50°C Working temperature: 5°C to +40°C)

Note:

*If your problem is not solved, turn your unit off and then on again once.
Never attempt to repair an LCD monitor yourself.*

Care and Maintenance

LCD Display panel information

Important Information Regarding Use of Video Games, Computers, Captions or Other Fixed Image Displays.

The extended use of fixed image program material can cause a permanent "shadow image" on the LCD panel.

This background image is viewable on normal programs in the form of a stationary fixed image. This type of irreversible LCD panel deterioration can be limited by observing the following steps:

- A. Reduce the brightness/contrast setting to a minimum viewing level.
- B. Do not display the fixed image for extended periods of time.
- C. Turn the power off when not in actual use.

Note:

The marking or retained image on the LCD panel resulting from fixed image use is not an operating defect and as such is not covered by Warranty. This product is not designed to display fixed image patterns for extended periods of time.

Cleaning and Maintenance

To clean this unit, wipe with a soft, dry cloth.

If the surfaces are extremely dirty, use a soft cloth dipped in a soap and water solution or a weak detergent solution.

- Use eyeglass cleaner to remove stubborn dirt from the LCD.
- Never use alcohol, paint thinner or benzine to clean this unit.
- Before using a chemically treated cloth, read the instructions that came with the cloth carefully.

Specification

Type:	LCD Monitor
Display Size diagonal:	37"
Power Supply:	AC100-240V 50/60Hz
Power Consumption:	200W
Dimensions(inch):	44.7 (W) X 25.7 (H) X 9.8 (D)
Unit Weight(lbs):	61.6

 Design and specifications are subject to change without notice.

What the warranty covers:

NuVision warrants its LCD display products to be free from defects in material and workmanship for a period of two (2) years for parts, labor and LCD back light. If a product proves to be defective in material or workmanship during the warranty period, NuVision will, at its sole option, repair or replace the product with a similar product. Replacement Product or parts may include remanufactured or refurbished parts or components. The replacement unit will be covered by the balance of the time remaining on the customer's original limited warranty.

Who the warranty protects:

This warranty is valid only for the original consumer purchaser.

What the warranty does not cover:

Any product on which the serial number has been defaced, modified. Removed or was not purchased from an authorized NuVision Dealer, Distributor, or Reseller.

Damage, deterioration or malfunction resulting from:

Accident, misuse, neglect, fire, water, lightning, or other acts of nature, unauthorized product modification, or failure to follow instructions supplied with the product.

Repair or attempted repair by anyone not authorized by NuVision.

Any damage of the product due to shipment.

Removal or installation of the product.

Causes external to the product, such as electric power fluctuations or failure.

Use of supplies or parts not meeting NuVision's specifications.

Normal wear and tear.

Any other cause which does not relate to a product defect.

Damage to, or abuse of, the coating on the surface of the display.

Removal, installation, and set-up service charges.

How to obtain service:

For information on obtaining warranty service, visit www.nuvision.com or call NuVision. NuVision's Customer Support telephone numbers are:

800-605-8022 in the U.S. or Canada; From outside the U.S.: **480-970-1466** or please refer to the contact information located in each country's corresponding web site.

NOTE: NuVision is not responsible for any returned product without an assigned RMA. Within the warranty period, the customer pays for inbound shipping charges and NuVision pays return shipping charges.

Limitation of implied warranties:

THERE ARE NO WARRANTIES, EXPRESS OR IMPLIED, WHICH EXTEND BEYOND THE DESCRIPTION CONTAINED HEREIN INCLUDING THE IMPLIED WARRANTY OF MERCHANTABILITY AND FITNESS FOR A PARTICULAR PURPOSE.

Exclusion of damages:

NUVISION'S LIABILITY IS LIMITED TO THE COST OF REPAIR OR REPLACEMENT OF THE PRODUCT. NUVISION SHALL NOT BE LIABLE FOR:

DAMAGE TO OTHER PROPERTY CAUSED BY ANY DEFECTS IN THE PRODUCT, DAMAGES BASED UPON INCONVENIENCE, LOSS OF USE OF THE PRODUCT, LOSS OF TIME, LOSS OF PROFITS, LOSS OF BUSINESS OPPORTUNITY, LOSS OF GOODWILL, INTERFERENCE WITH BUSINESS RELATIONSHIPS, OR OTHER COMMERCIAL LOSS, EVEN IF ADVISED OF THE POSSIBILITY OF SUCH DAMAGES.

ANY OTHER DAMAGES, WHETHER INCIDENTAL, CONSEQUENTIAL OR OTHERWISE.

ANY CLAIM AGAINST THE CUSTOMER BY ANY OTHER PARTY.

Effect of local law:

This warranty gives you specific legal rights, and you may also have other rights which vary from locality to locality. Some localities do not allow limitations on implied warranties and/or do not allow the exclusion of incidental or consequential damages, so the above limitations and exclusions may not apply to you.

Sales outside the U.S.A. and Canada:

For NuVision products sold outside the U.S. and Canada, contact your NuVision dealer or NuVision for warranty information and service.



PRINTED ON
RECYCLED PAPER