



# PlasmaVision™



### Contents

	Page		Page
<b>Before Use</b>			
• INFORMATION.....	E-2	• ADJUSTING AUDIO .....	E-22
<b>Usage</b>			
• INSTALLATION .....	E-3	• OTHER ADJUSTMENTS.....	E-23
• PART NAMES AND FUNCTIONS.....	E-4	• INITIALIZATION OF USER ADJUSTMENT VALUE..	E-27
• USING THE REMOTE CONTROL .....	E-7	• OPTIONS.....	E-28
• CONNECTING THE DISPLAY TO EXTERNAL EQUIPMENT .....	E-9	• MAIN SUPPORTED SIGNALS .....	E-29
• BASIC OPERATIONS .....	E-10	• SPECIFICATIONS .....	E-30
• WATCHING PICTURES ON THE WIDE SCREEN ...	E-12	<b>Others</b>	
• CLEANING AND MAINTENANCE..... E-31			
<b>Adjustments</b>			
• ADJUSTMENT MENU .....	E-14		
• BASIC PROCEDURES OF ADJUSTMENT MENU ...	E-15		
• ADJUSTING THE PICTURE .....	E-16		
• ADJUSTING SCREEN POSITION AND SIZE.....	E-21		

Before using the display, read this manual carefully so that you know how to use the display correctly. Refer to this manual whenever questions or problems about operation arise. Be sure to read and observe the safety precautions (see the separate "Safety Precautions" manual). Keep this manual where the user can see it easily.

- \* Installation and removal require special expertise. Consult your product dealer for details.
- \* When "English" is selected at "Language" of the on-screen display, "colour" will be displayed in the case of the E model and "color" will be displayed for all other models. The notation used in this user's manual is "color".
- \* The last digit of MODEL NO. (10 digit alphanumeric characters) indicated on the product means the body color indication alphabet or the management number.
- \* The Illustration of external appearance is for 42" model. Please acknowledge some differences in the actual product of other models.

# INFORMATION

- Receptacle

Make sure that the power cord's grounding wire is grounded.

The plasma display comes with a 3-prong power plug; one prong is connected to the grounding wire. If you have only a 2-hole receptacle, you will need to have it replaced. Contact your dealer for more information.

- Have the plasma display inspected and cleaned by your dealer at regular intervals.
- Do not display the same picture for a long time, because part of the screen may "burn-in" and create a residual image if the same picture is displayed for an extended period of time. To prolong the life of the plasma display, we recommend the use of the "Screen Orbiter" settings. (See P. E-25) When a residual image was created, reduce the residual image by using the "White screen" settings. Note that there may also be cases when it can not be recovered completely. (See P. E-26)
- When the screen size is set to "Normal" and a picture was displayed for a long time, a residual image may be created at the boundary with the part at which an image is not displayed. We recommend that you use a screen size other than "Normal". (See P. E-12)
- High-precision technology has been used in the manufacture of the plasma display panel, in which the effective pixels exceeds 99.99%. However, please be aware, that fewer than 0.01% of the pixels may be missing or remain constantly lit.
- Some models are fitted with a radiator fan to prevent the plasma display's internal temperature from rising during operation. Be careful of the air emitted by the radiator fan, as it may be hot.
- Contact your dealer when causing a bad influence to the plasma display and other audio-visual equipment mutually.  
You may need to move your plasma display if it produces degraded pictures or noise due to electromagnetic radiation, or if the infrared remote control does not function properly.
- Pictures may not be displayed properly if you connect a non-standard PC to the RGB input terminal. In this case, contact your dealer for more information.
- The protective circuit, built into the display, automatically turns off the power if the display has a problem. In this case, you will see that the power indicator lamp flashes red or green.

## Warning

If the power indicator lamp flashes red or green, this signifies that the display has developed a problem. When this happens, be sure to unplug from the receptacle to prevent fire or electric shock. Then contact your dealer.

- It is important to install the plasma display in a location close to a receptacle, and where the emergency stop button can be easily reached.

## CHECKING ACCESSORIES

User's Manual



Safety Precautions



Remote control



AA battery (2)

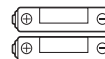

Power cord

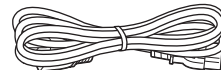

Small ferrite core (2)



No.:ZCAT1518-0730  
Mfr.:TDK

Large ferrite core (2)

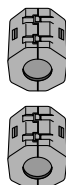

No.:SFT-72SN  
Mfr.:TKK

## Note

- Cables for connecting the display to external equipment are not supplied. Contact your dealer for more information on these products.
- In order to facilitate the explanations, pictures and diagrams in this manual may differ slightly from the actual items.

# INSTALLATION

- To prevent the plasma display's internal components from overheating, make sure that the plasma display is installed in a well-ventilated location.
- Be sure to use the optional stand, wall-mounting unit or the other mounting unit when installing the plasma display. Also, be sure that your dealer performs the installation.
- See the appropriate instruction manual for additional information on the mounting hardware you select.
- To prevent an accident and ensure safety in the event of an earthquake, fix the plasma display securely into the position as described below.
- Use the diagram below to determine how much space is needed to ensure proper heat radiation. This is a minimum space requirement; therefore, provide at least as much space as indicated below.
  - \* Make sure that the plasma display is installed in a location where the temperature can be maintained between 0°C and 40°C (between 32°F and 104°F)
  - \* Never attempt to tilt the plasma display sideways or backward.
  - \* To prevent the power cord and other cables from being accidentally pulled, make sure that they run along the wall or through corners.
  - \* To prevent accidents and ensure safety in the event of an earthquake, secure the plasma display to prevent it from tipping over.

## Display Section

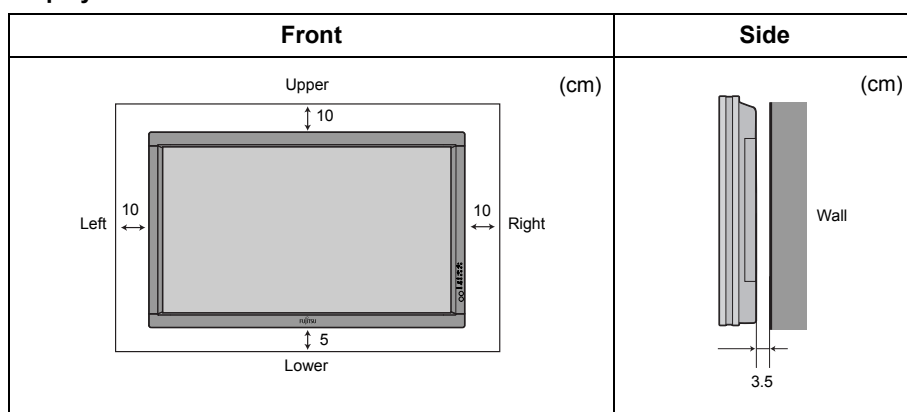

## ATTACHING THE FERRITE CORES

- The ferrite cores are used to reduce noise. Attach them correctly as shown in the following illustrations.
- Be sure to turn off power of the plasma display and external equipment before making any connections.
- Carefully check the terminals for position and type before making any connections.
- Loose connectors can result in picture or color problems. Make sure that all connectors are securely inserted into their terminals.

### 2 large ferrite cores

When connecting the cord to the power input terminal, RS232C input terminal, attach one of these ferrite cores to the cord and the cable near the terminal.

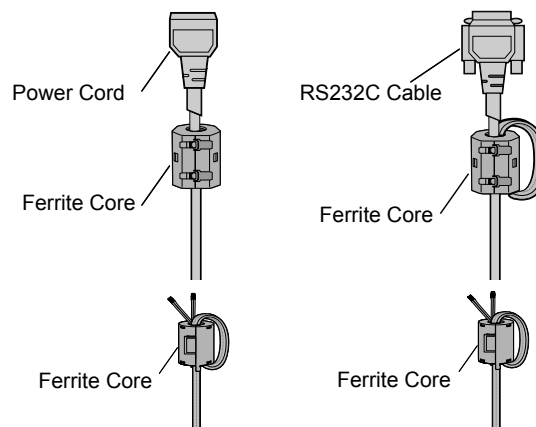

### 2 small ferrite cores

When connecting a cable to the external speaker output terminal attach one of these ferrite cores to the cable near the terminal.

### Note

- The external view is meant to be a representation of the actual unit and is not to scale; therefore, it may differ from the actual shape and size of the product.
- Due to the fragile and highly precise equipment, it is very important to pack properly before transportation using only the packing materials provided.

### Reference

See P. E-28 for more information on options.

# PART NAMES AND FUNCTIONS

## DISPLAY SECTION – FRONT

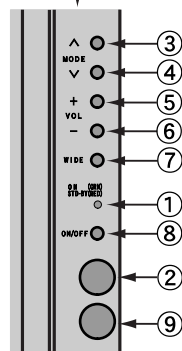

### ① Power indicator lamp

This lamp shows the state of the power supply.

Lit (red): Stand-by state

Lit (green): Power ON state

Flashing (red or green): Malfunction (Flashes differently depending on the type of malfunction.)

### ② Remote control signal receiver

Receives signals from the remote control.

### ③ Input mode selector button ▲

### ④ Input mode selector button ▼

Switches between picture input modes.

### ⑤ Volume + button

### ⑥ Volume - button

Adjusts the audio volume.

### ⑦ Wide screen selector button

Switches the screen over to a desired wide screen.

### ⑧ ON/OFF button

Turns the power “ON” and “OFF (standby state)”.

### ⑨ Ambient Sensor

Detects the brightness of ambient light.

It is important not to obstruct it for full functionality of the feature.

## DISPLAY SECTION – BACK

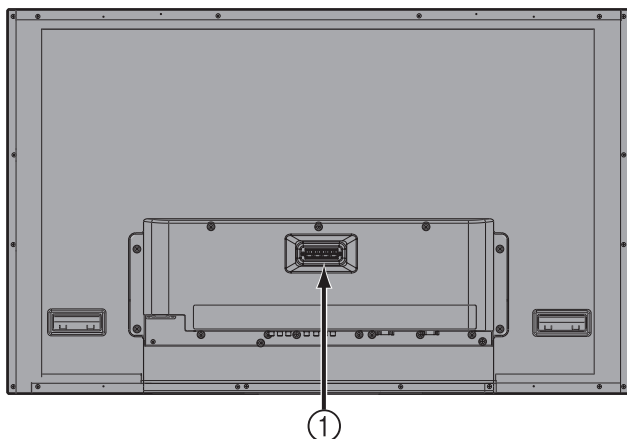

### ① External speaker output terminal (EXT SP)

Connect this terminal to the optionally available speaker.

When connecting a cable, attach a ferrite core to the cable. (See P. E-3.)

\* See the speaker instruction manual for more information.

### Warning

If the power indicator lamp flashes red or green, this signifies that the plasma display has developed a problem. When this happens, be sure to remove the power plug from the receptacle and contact your dealer. In this circumstance, leaving the plasma display power ON can result in fire or electric shock.

## DISPLAY SECTION – BOTTOM

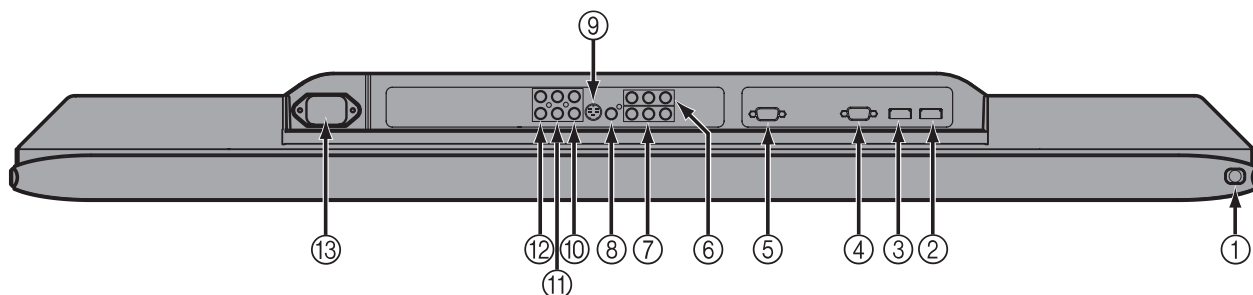

### ① **⏻ / I power switch**

If this button is pressed when the power indicator lamp is off, the indicator lamp will light.

The power can be turned on and the standby mode selected by using the remote control or the control panel of the display.

If this button is pressed when the power indicator lamp is lit, the indicator lamp will go out.

\*Power is still supplied to parts of the display even if the indicator lamp is off.

### ② **HDMI input terminal (VIDEO5 INPUT/HDMI)**

### ③ **HDMI input terminal (VIDEO6 INPUT/HDMI)**

Connect this terminal to the HDMI output terminal of DVD recorder/player or other video equipment.

If the HDMI output is connected, an Audio signal cable does not need to be connected.

### ④ **RS-232C terminal (RS-232C)**

This terminal is provided for you to control the display from the PC. Connect it to the RS-232C terminal on the PC.

When connecting a cable, attach a ferrite core to the cable. (See P. E-3.)

### ⑤ **RGB1 input terminal (RGB1 INPUT/mD-sub)**

Connect this terminal to the output terminal of a PC, set-top box, game, etc.

### ⑥ **Component video input terminal (VIDEO3 INPUT)**

### ⑦ **Component video input terminal (VIDEO4 INPUT)**

Connect this terminal to the Component video output terminal of DVD recorder/player or satellite receiver.

### ⑧ **Video input terminal (VIDEO1 INPUT)**

Connect this terminal to the video output terminal of your VCR.

### ⑨ **S-Video input terminal (VIDEO2 INPUT)**

Connect this terminal to the S-video output terminal of your VCR.

### ⑩ **Audio3 input terminal (AUDIO3 INPUT)**

### ⑪ **Audio2 input terminal (AUDIO2 INPUT)**

### ⑫ **Audio1 input terminal (AUDIO1 INPUT)**

Connect this terminal to the audio output terminal of VCR or PC, etc.

### ⑬ **Power input terminal**

Connect this terminal to the power cord supplied with the plasma display.

When connecting the cord, attach a ferrite core to the cord. (See P. E-3.)

• The table below shows the settings of Audio inputs. (Factory setting)

\* For changing of Audio input settings, see Audio Input on P. E-25.

Video input	Audio input
RGB1(mD-sub)	Audio1
Video1(Video)	Audio2
Video2(S-video)	Audio2
Video3(Component Video)	Audio3
Video4(Component Video)	Audio3
Video5(HDMI)	Audio4(HDMI)
Video6(HDMI)	Audio5(HDMI)

### Note

• The illustration of external appearance is for 42" model. Please acknowledge some differences in the actual product of other models.

# PART NAMES AND FUNCTIONS (Continued)

## DESCRIPTION OF INPUT TERMINALS

mD-sub input terminal  
(RGB1 INPUT/mD-sub)

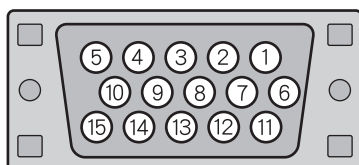

Pin No.	Input signal	Pin No.	Input signal
1	Red	9	—
2	Green	10	Ground
3	Blue	11	—
4	—	12	—
5	Ground	13	Horizontal synchronization
6	Ground	14	Vertical synchronization
7	Ground	15	—
8	Ground	Frame	Ground

RS-232C terminal (RS-232C)

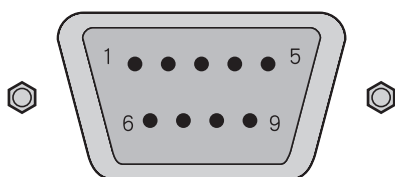

Pin No.	Signal
1	DCD (Data Carrier Detect)
2	RD (Received Data)
3	TD (Transmit Data)
4	DTR (Data Terminal ready)
5	GND (Ground)
6	DSR (Data Set Ready)
7	RTS (Request To send)
8	CTS (Clear To Send)
9	RI (Ring Indication)

HDMI input terminal (VIDEO5,6 INPUT/HDMI)



Pin No.	Input signal	Pin No.	Input signal
1	T.M.D.S. Data2+	11	T.M.D.S. Clock Shield
2	T.M.D.S. Data2 Shield	12	T.M.D.S. Clock-
3	T.M.D.S. Data2-	13	CEC
4	T.M.D.S. Data1+	14	Reserve
5	T.M.D.S. Data1 Shield	15	DDC Clock
6	T.M.D.S. Data1-	16	DDC Data
7	T.M.D.S. Data0+	17	Ground (for +5V)
8	T.M.D.S. Data0 Shield	18	+5V Power
9	T.M.D.S. Data0-	19	Hot Plug Detect
10	T.M.D.S. Clock+	Frame	FG

## TRADEMARK INFORMATION









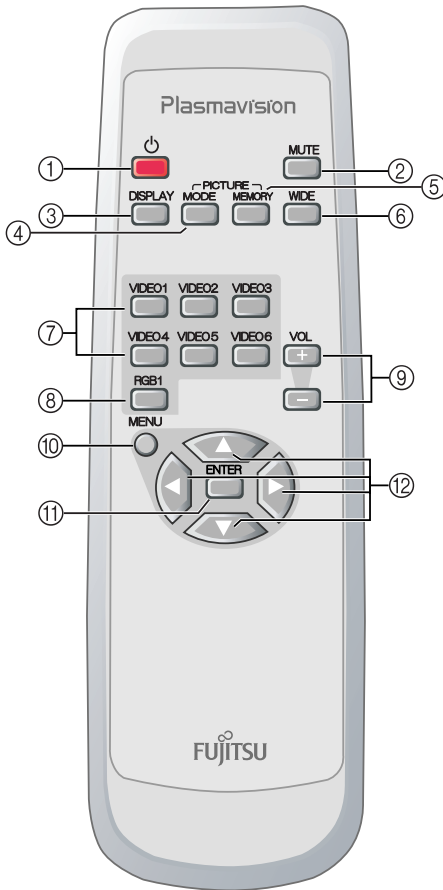





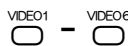

HDMI, the HDMI logo and High-Definition Multimedia interface are trademarks or registered trademarks of HDMI Licensing LCC.

## REMOTE CONTROL

For details, see page →.



- ①  **button → E-10**  
Switches between Power On and Standby.
- ②  **(MUTE button) → E-10**  
Press to temporarily mute the audio.  
To return the audio to normal, press this button once again, or press the  does the  work also.
- ③  **(DISPLAY button) → E-11**  
Press to display the input mode and screen size status.  
The status is displayed for about five seconds.
- ④  **(PICTURE MODE button) → E-11**  
Press to switch the Picture Mode.
- ⑤  **(PICTURE MEMORY button) → E-11**  
Press to recall a Picture Memory.
- ⑥  **(WIDE button) → E-12**  
Press to switch the screen size.
- ⑦  **(Video input mode selector button) → E-10**  
Press to select VIDEO1 - 6.
- ⑧  **(RGB input mode selector button) → E-11**  
Press to select RGB1.
- ⑨  **(Volume adjustment buttons) → E-10**  
Press to adjust the volume.
- ⑩  **(MENU button) → E-15-E-27**  
Press to display or hide the menu screen.  
Use for picture or audio adjustment.
- ⑪  **(ENTER button) → E-15-E-27**  
Press to confirm the setting you made with the adjustment buttons.
- ⑫  **(Adjustment buttons) → E-15-E-27**  
Press to select the adjustment item or adjust the value in the menu screen.

### Note

- Functions may not be available with some models and some device options.

# USING THE REMOTE CONTROL (Continued)

## PUTTING BATTERIES IN THE REMOTE CONTROL



(1) To remove the cover, slide it outwards while pressing it down.

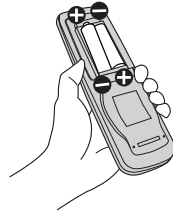

(2) Place two AA batteries in the remote control. Make sure that the batteries are properly oriented.



(3) Close the cover until it snaps into place.

## PRECAUTIONS

To prevent malfunction, do not apply any form of severe shock to the remote control. To prevent malfunction or deformation, do not allow the remote control to become wet and keep it away from hot surfaces or heating equipment. Do not clean the remote control using a cloth dampened in a volatile solvent, such as benzene or thinner.

## EFFECTIVE RANGE FOR THE REMOTE CONTROL

When using the remote control, be sure to point it directly at the plasma display's signal receiver. Make sure that there are no obstacles between the remote control and the plasma display's signal receiver.

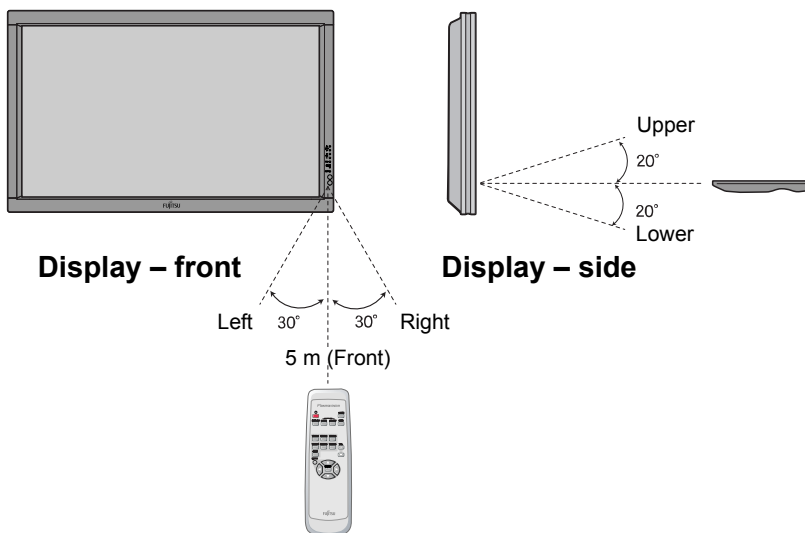

### CAUTION

It is very important to use replacement batteries of the same type as the originally used. Do not use rechargeable batteries (Ni-Cd, etc.). When disposing of used batteries, please comply with governmental regulations or environmental public institution's rules that apply in your country/area.

### Note

- The remote control will not function properly if the batteries are dead. Be sure to replace them as needed.
- The remote control may not function properly if a high-frequency fluorescent lamp or the like is used. In this case, move the lamp or use the remote control from a different position.



# CONNECTING THE DISPLAY TO EXTERNAL EQUIPMENT

## DVD RECORDER/PLAYER, SATELLITE TUNER

- Connect the video signal cable to the HDMI input terminal, component video input terminal, S-video input terminal, or the video input terminal.
- If the equipment to be connected is equipped with HDMI output terminal and component video output terminal, it is recommended to connect to one side or the other. (If the HDMI output is connected, an Audio signal cable does not need to be connected.)

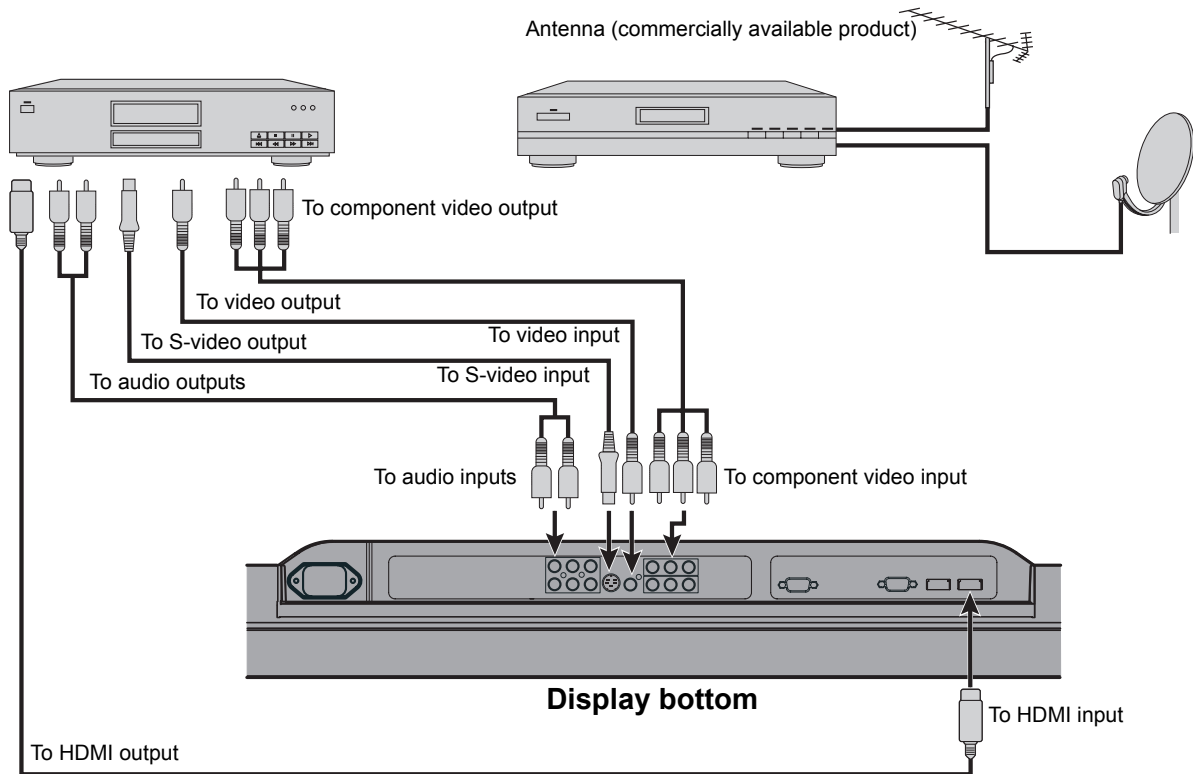

## VCR/PC

- Connect the video signal cable to either the S-video input terminal or the video input terminal.
- If the unit to be connected is equipped with S-video output terminal, it is recommended to connect to the S-video terminal.
- As the cable for connecting a PC differs with the PC model, please consult your dealer for information on the right cable to purchase.

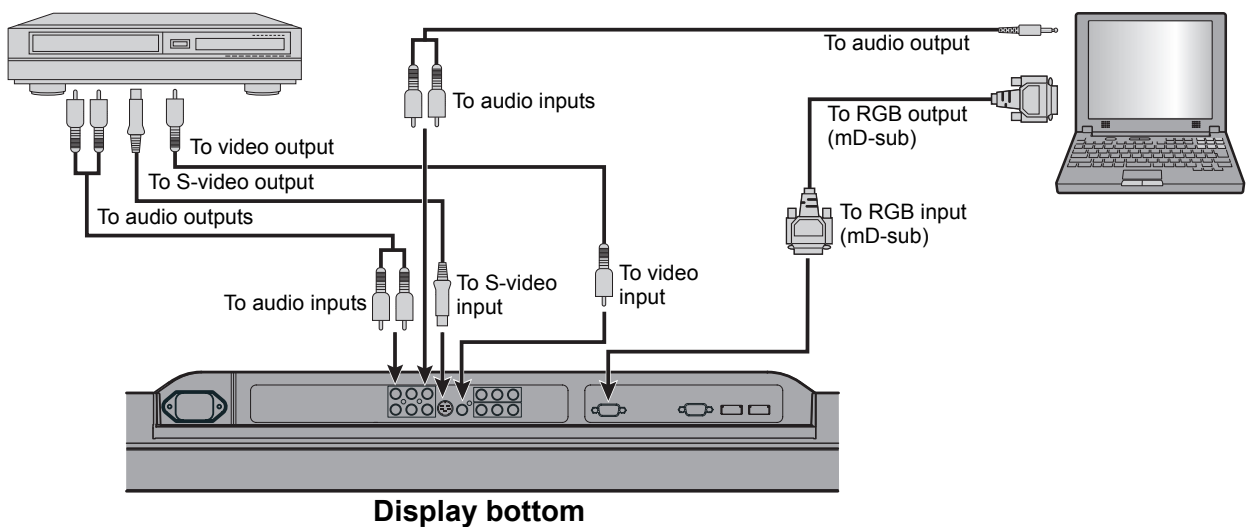

### Note







- Unplug the power cord from the AC outlet before you connect external components.
- Also refer to the instructions for the component to be connected.
- When inputting audio, connect to the terminals corresponding to the used video input or RGB input.

# BASIC OPERATIONS

## TURNING THE POWER ON AND STAND-BY



\* You can also use the buttons on the display's control panel to perform these steps.

- 1 Press  to the left at the bottom of the display to the ON  state.**  
The power lamp lights up.
- 2 Press  on the remote control.**  
The color of the power lamp changes from "Red" to "Green".
- 3 Press  -  or .**  
Select the video mode to input.
- 4 Press  when the power is ON.**  
The color of the power lamp changes from "Green" to "Red" and the power turns "OFF (Stand-by state)".

## ADJUSTING THE VOLUME



\* You can also use the buttons on the display's control panel to perform these steps.

### Adjusting the volume

Press  to increase the volume.

Press  to reduce the volume.

\* Note that the volume level remains stored even when you turn OFF the power.

### Muting the audio

Press .

The audio is removed.

Press again to restore the audio to the original level.

The mute mode can also be released by pressing the volume buttons.

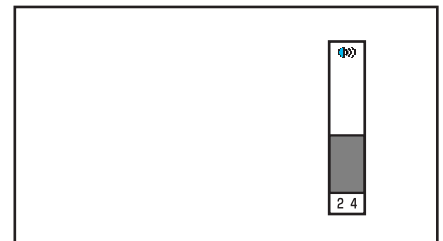

When the volume adjustment button is pressed

## VIDEO INPUT MODE



\* You can also use the buttons on the display's control panel to perform these steps.

- 1 Press  -  to select the input mode.**

You can select from VIDEO1 mode to VIDEO6 mode.

The video modes corresponding to each input terminal are as follows.

- VIDEO1: Video
- VIDEO2: S-video
- VIDEO3: Component video
- VIDEO4: Component video
- VIDEO5: HDMI
- VIDEO6: HDMI



Video1 mode

\* For selection of the input terminal, see "SETTING THE INPUT TERMINALS" on P. E-24.

### Note

- Functions may not be available with some models and some device options.

## RGB INPUT MODE



### 1 Press to select the input mode.

You can select RGB1.

- RGB1: mD-sub

\* For selection of the input terminal, see “SETTING THE INPUT TERMINALS” on P. E-24.



RGB1 mode

\* You can also use the button on the display's control panel to perform these steps

## CONVENIENT FUNCTIONS



### On-screen information

Press  .

The mode is indicated on the screen for 5 seconds.

### Picture Mode

Press  .

This button can be used to switch the picture mode.

In the picture mode, you can switch between the set status and the fine mode.

\* For the picture mode settings, see “Setting Picture Mode (P. E-17)”.

### Picture Memory

Press  .

This button can be used to recall the settings of the picture memories 1 – 8. Each time this button is pressed, the setting changes as follows.

→ **Memory1** → **Memory2** → **Memory3** → **Memory4** → **Memory5** → **Memory6** → **Memory7** → **Memory8** →

\* For the picture memory settings, see “Setting Picture Memory (P. E-17)”.

### Note

- Functions may not be available with some models and some device options.

# WATCHING PICTURES ON THE WIDE SCREEN

## SWITCHING BETWEEN SCREEN SIZES



\* You can also use the buttons on the display's control panel to perform these steps.

**1** Press .

The currently selected mode will appear.

**2** Press  to select a desired Screen Size.

Each time you press , a different Screen Size appears. The sequences used are as follows:

When you are in a Video input mode

→ **Normal** → **Wide1** → **Wide2** → **Zoom1** → **Zoom2** →

When you are in an RGB input mode

→ **Normal** → **Wide** → **Zoom** →

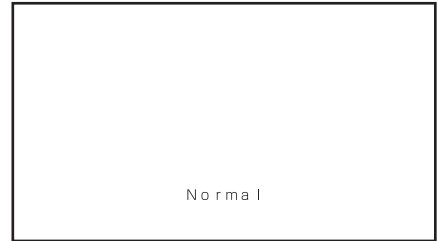

Normal mode



Wide1 mode

\* Depending on the type of signal, some aspects may not be selected.

### Note

- When the WIDE mode is set to "Normal", and pictures are shown for an extended time, a residual image or "burn-in" may be created. The burn-in may occur at the boundary where the left and right borders of the picture meet the vertical bars. To reduce the chance of "burn-in" when watching in the "Normal", we recommend you set the "Background" to "Light Gray". (See P. E-26)
- When a residual image was created, it is reduced by using the "White screen" settings. Note that there may also be cases when it can not be recovered completely. (See P. E-26)
- A variety of Screen Sizes are available with this display. Remember that if you select a mode with an aspect ratio (ratio of frame width to frame height) different from that of the TV program or video media, the pictures will appear differently than if you had selected a mode having the same aspect ratio.
- Showing a movie or similar premium event at a different aspect ratio from its original one at any event site, restaurant, or bar for profit-making purposes or for a public audience may constitute a copyright infringement.  
For films, try to select a mode having the same aspect ratio as the original picture; this enables the director's original intentions to be preserved.
- See P. E-21 for how to adjust the picture size and position.

## SCREEN SIZE

### Normal (Video/RGB)

Displays pictures of normal size (i.e., a 4:3 aspect ratio).

### Wide1 (Video)

Displays natural-looking pictures of standard size on the wide screen.

### Wide2 (Video)/Wide (RGB)

Ideal for displaying vertically extended pictures such as squeezed pictures.

### Zoom1 (Video)/Zoom (RGB)

Enlarges horizontally extended pictures equally in all directions to maintain the aspect ratio constant.

### Zoom2 (Video)

Reduces the height of horizontally extended pictures with captions, without eliminating the caption. Only the height of pictures is reduced, not the height of the caption.

(Captions may not be easy to read, however, depending on the picture.)

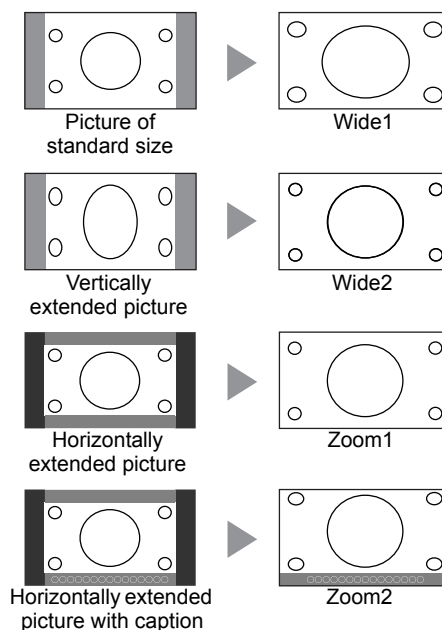

## ASPECT RATIO

The following aspect ratios are available.

4:3 aspect ratio  
(VHF/UHF broadcasting, BS broadcasting)

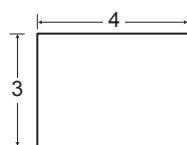

16:9 aspect ratio  
(HDTV broadcasting)

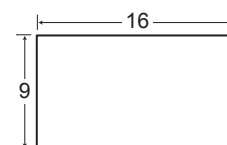

1.85:1 aspect ratio  
(Vista Vision size)

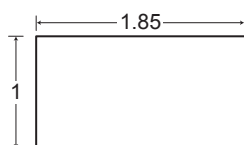

2.35:1 aspect ratio  
(Cinema Vision size)

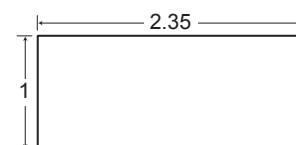

### Note

You may find dark areas on top and at the bottom of the screen if you select one of the Zoom modes for media while using the Vista Vision or Cinema Vision size i.e., the sizes used frequently for picture software.

- Functions may not be available with some models and some device options.

# ADJUSTMENT MENU

The numbers in parentheses ( ) indicate the reference page numbers.

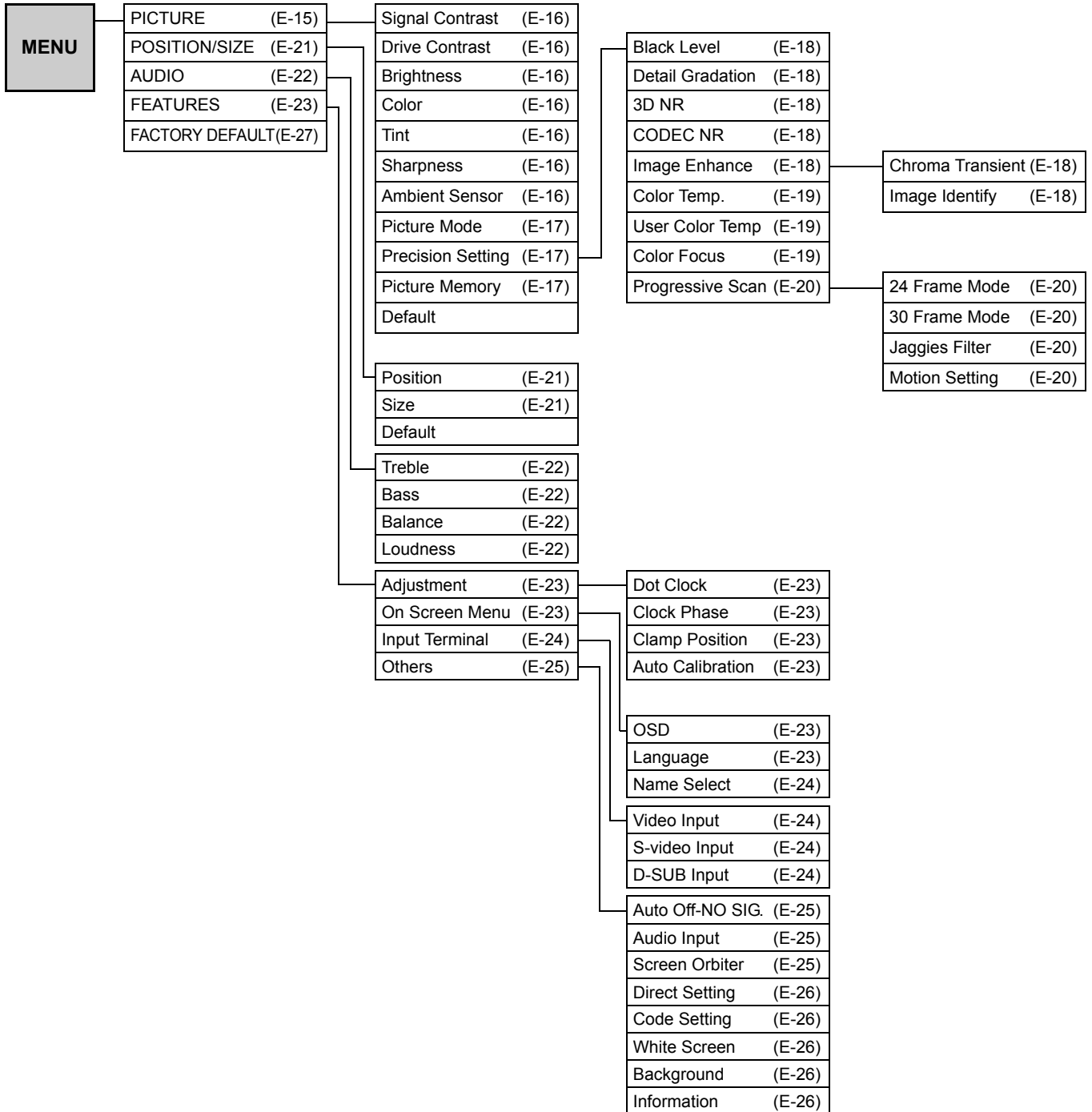

**Note**

- Some type of signal can not be selected.

# BASIC PROCEDURES OF ADJUSTMENT MENU

- Shown below is the basic procedure used to change the options on the ADJUSTMENT MENU. (Ex.: Adjusting tint setting (Tint))  
Selecting the adjustment mode for adjustment or setting. (The items to be adjusted or set are stored for each adjustment mode.)



**1** Press .  
The main menu screen will appear.

**2** Press or to select "PICTURE".  
Each time you press or , one of the available menus appears in the following sequence:

**PICTURE ↔ POSITION/SIZE ↔ AUDIO ↔ FEATURES  
↔ FACTORY DEFAULT**

The PICTURE Menu screen will appear.

**3** Press or to select "Tint".

**4** Press .  
The "Tint" adjustment screen will appear.

**5** Press or to change tint values.

: More greenish colors

: More purplish colors

**6** Press to store.

**7** Press when you finish.

\* Repeat steps 3, 4, 5 and 6 when you wish to make changes to other options.

\* Select "Default" and press .  
The PICTURE items are changed back to the default settings available when the plasma display was purchased.

\* Press to halt the operation in progress.

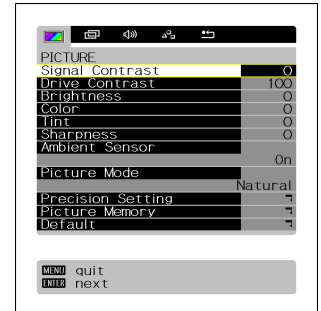

"PICTURE" selected in the main menu screen

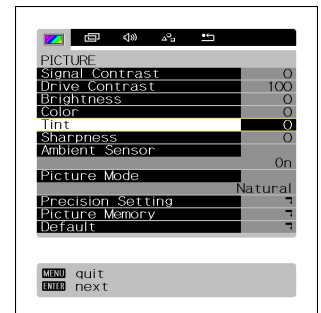

"Tint" selected in the PICTURE Menu screen

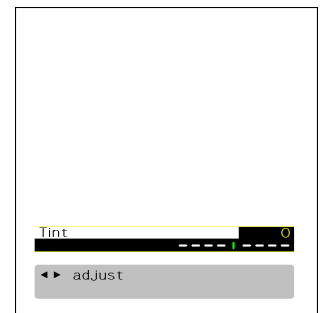

"Tint" adjustment screen

## Note

- On-screen information disappears if you do not take any action for about 60 seconds.
- Functions may not be available with some models and some device options.
- The adjustment range varies with the display signal. You can adjust the display quality to the value you want within the adjustable range.

# ADJUSTING THE PICTURE

- Picture-related items can be set and adjusted in the Picture Adjustment Screen. See BASIC PROCEDURES OF ADJUSTMENT MENU on page E-15 for the basic procedures.

## Adjusting the Signal Contrast

Press  to increase the input signal contrast.

Press  to reduce the input signal contrast.

Press  to store.

## Adjusting the Drive Contrast

Press  to raise the display's luminance level, and increase the contrast.

Press  to lower the display's luminance level, and reduce the contrast.

Press  to store.

\* If Ambient Sensor is ON, the change made by this adjustment may be difficult to be recognized in too bright or dark a place.

## Adjusting the Brightness

Press  to increase the brightness.

Press  to reduce the brightness.

Press  to store.

## Adjusting the Color

Press  to darken the color.

Press  to lighten the color.

Press  to store.

## Adjusting the Tint

Press  to change the tint to a more greenish color.

Press  to change the tint to a more purplish color.

Press  to store.

## Adjusting the Sharpness

Press  to sharpen the Sharpness.



Press  to soften the Sharpness.

Press  to store.

## Adjusting the Ambient Sensor

Ambient Sensor can be set.

Automatically adjusts the picture quality to an optimized level that matches the brightness of the ambient light.



Each time  or  is pressed, the setting is switched.

↔ On ↔ Off ↔

Press  to store.



## Setting the Picture Mode

Each time you press  or , the available choices appear in the following sequence.

↔ **Natural** ↔ **Fine** ↔ **Effective** ↔ **Conventional** ↔ **Still** ↔

<b>Natural</b>	Enables you to watch pictures with natural color tones and high picture clarity. This mode is suitable for watching movies or TV.
<b>Fine</b>	Best for watching movies in darkened rooms.
<b>Effective</b>	Best for watching TV in bright environments.
<b>Conventional</b>	Displays a screen approximating that of a conventional TV screen.
<b>Still</b>	Suitable for watching static images such as computer or still camera images.

Press  to store.

## Precision Setting

Enables advanced picture quality adjustments.



See page E-18 for details.

## Setting the Picture Memory

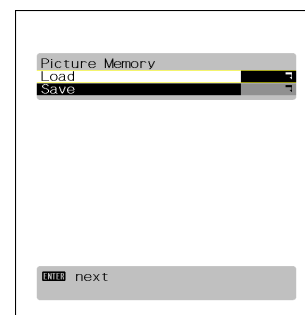
Eight groups of picture adjustment settings can be stored, enabling you to quickly switch to your desired group of settings for watching picture.



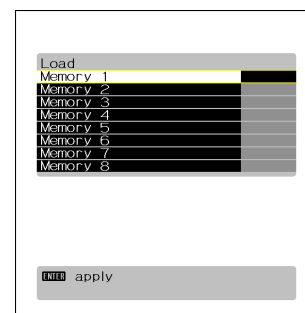

Picture Memory Selection Screen

**[Load]:** Use  or  to select Memory 1 - 8. When  is pressed, the values becomes the picture adjustment values stored in the selected Memory.



"Load" Selection Screen

**[Save]:** Use  or  to select Memory 1 - 8. If  is pressed, the current picture adjustment values are stored to the selected Memory.

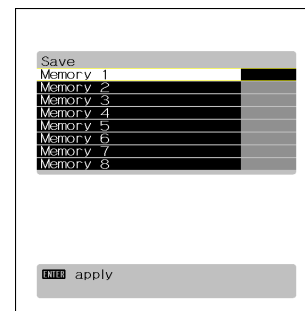

"Save" Selection Screen

### Note

- If the operation is not executed for about 60 seconds, the menu disappears.
- Depending on the model or the optional devices, some of the functions may not be available.
- The adjustment range varies according to the display signals. Make adjustments to your preferred picture quality within the adjustment range.
- Depending on the type of signal, it may not be possible to make some of the settings or adjustments.

# ADJUSTING THE PICTURE (Continued)

## PRECISION SETTING

Even more advanced picture quality adjustments can be made as required.

### Adjusting the Black Level

Press to strengthen the reproduction of black. (Provides a picture quality with deep blacks.)

Press to weaken the reproduction of black.

Press to store.

### Setting the Detail Gradation

Corrects the gradation of the light and dark areas of the picture.

Each time or is pressed, the setting is switched.

↔ On ↔ Off ↔

Press to store.

### Setting the 3D NR

This enables noise reduction processing with respect to the input signal noise level (reduces screen flicker for more comfortable viewing).

Each time you press or , the available choices appear in the following sequence.

↔ Off ↔ Min. ↔ Mid. ↔ Max. ↔

Press to store.

### Setting the CODEC NR

This enables noise reduction processing of mosquito noise or block noise generated when digital picture signals are recorded or replayed.

Each time you press or , the available choices appear in the following sequence.

↔ Off ↔ Min. ↔ Mid. ↔ Max. ↔

Press to store.

### Setting the Image Enhance

This performs detailed image quality settings.

#### • Chroma Transient

This function corrects the color contours.

Each time or is pressed, the setting is switched.

↔ Off ↔ On ↔

Press to store.

#### • Image Identify (RGB)

This function discerns between the natural image display section and the text display section, and performs correction to enable an optimized display for each.

Each time or is pressed, the setting is switched.

↔ Off ↔ On ↔

Press to store.

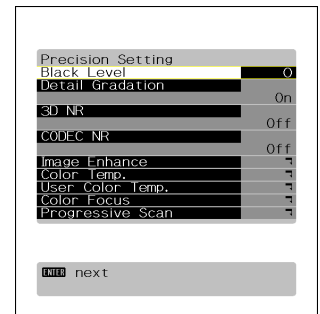

Precision Setting Selection Screen

## Adjusting the Color Temp.

Use  $\leftarrow$  or  $\rightarrow$  to specify a desired color temperature. Each time you press  $\leftarrow$  or  $\rightarrow$ , one of the available choices appears in the following sequence:

$\leftrightarrow$  **-3500K**  $\leftrightarrow$  ...  $\leftrightarrow$  **Std.**  $\leftrightarrow$  ...  $\leftrightarrow$  **+3500K**  $\leftrightarrow$  **User**  $\leftrightarrow$

**[-3500K]:** More reddish colors

**[+3500K]:** More bluish colors

**[User]:** User Color Temp. setup

Press  $\text{ENTER}$  to store.

## Setting the User Color Temp.

Use  $\triangleleft$  or  $\triangleright$  to select Red, Green, or Blue, and adjust the color temp. for each.

Press  $\rightarrow$ : to strengthen the selected color.

Press  $\leftarrow$ : to weaken the selected color.

Press  $\text{ENTER}$  to store.

## Setting the Color Focus

This enables correction with respect to specific color hues within the image.

Independent correction of the hue of skin colors, blue skies, and so on, enables a more brilliant display.

### • [Reddish Color]

With red at the center, performs the following corrections with respect to the range from magenta to yellow.

**[Tint]:** Use  $\rightarrow$  and  $\leftarrow$  to adjust the hue.

**[Color]:** Use  $\rightarrow$  and  $\leftarrow$  to adjust the color depth.

**[Red]:** Use  $\rightarrow$  and  $\leftarrow$  to adjust the strength of the red color range.

**[Green]:** Use  $\rightarrow$  and  $\leftarrow$  to adjust the strength of the green color range.

**[Blue]:** Use  $\rightarrow$  and  $\leftarrow$  to adjust the strength of the blue color range.

Press  $\text{ENTER}$  to store.

Adjustments can be made in the same way for:

- **[Greenish Color]:** (With green at the center, performs corrections with respect to the range from yellow to cyan.)
- **[Bluish Color]:** (With blue at the center, performs corrections with respect to the range from cyan to magenta.)

### • [Targeting Red]

This function corrects the hue and color depth with respect to Red.

**[Tint]:** Use  $\rightarrow$  and  $\leftarrow$  to adjust the hue.

**[Color]:** Use  $\rightarrow$  and  $\leftarrow$  to adjust the color depth.

Press  $\text{ENTER}$  to store.

Adjustments can be made in the same way for:

- **[Targeting Yellow]** (Performs correction with respect to Yellow.)
- **[Targeting Green]** (Performs correction with respect to Green.)
- **[Targeting Cyan]** (Performs correction with respect to Cyan.)
- **[Targeting Blue]** (Performs correction with respect to Blue.)
- **[Targeting Magenta]** (Performs correction with respect to Magenta.)

### Note

- If the operation is not executed for about 60 seconds, the menu disappears.
- Depending on the model or the optional devices, some of the functions may not be available.
- The adjustment range varies according to the display signals. Make adjustments to your preferred picture quality within the adjustment range.
- Depending on the type of signal, it may not be possible to make some of the settings or adjustments.

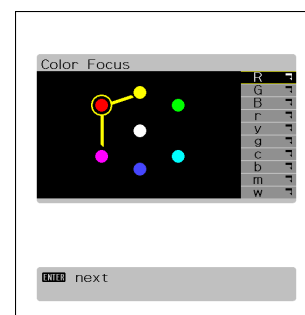





Color Focus (Reddish color)  
Settings Screen



# ADJUSTING THE PICTURE (Continued)

- **[Targeting White]**

Corrects red, green, and blue with respect to white.

**[Red]:** Use  and  to adjust Red.

**[Green]:** Use  and  to adjust Green.

**[Blue]:** Use  and  to adjust Blue.



Press  to store.

## Making the Progressive Scan Settings

This sets the conversion processing of interlace signals to block receive signals.

- **24 Frame Mode**

This function enables the optimized display of movies, etc. with 24 frames/second signals.



Each time  or  is pressed, the setting is switched.

↔ **Auto** ↔ **Off** ↔

Press  to store.

- **30 Frame Mode**

This function enables the optimized display of movies, etc. with 30 frames/second signals.



Each time  or  is pressed, the setting is switched.

↔ **Auto** ↔ **Off** ↔

Press  to store.

- **Jaggies Filter**

This function alleviates the phenomenon where jagged diagonal lines can be seen when interlace signals are input, thus enabling a smoother motion picture display.

Each time  or  is pressed, the setting is switched.

↔ **Auto** ↔ **Off** ↔

Press  to store.

- **Motion Setting**

The detecting sensitivity for motion picture is set.

The response of the picture processing is valued in the motion picture priority setting.

Press : to specify still picture priority.

Press : to specify motion picture priority.

Press  to store.

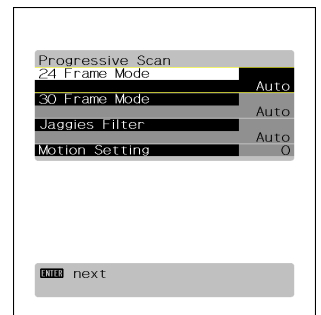

Progressive Scan Settings Screen

### Note

- If the operation is not executed for about 60 seconds, the menu disappears.
- Depending on the model or the optional devices, some of the functions may not be available.
- The adjustment range varies according to the display signals. Make adjustments to your preferred picture quality within the adjustment range.
- Depending on the type of signal, it may not be possible to make some of the settings or adjustments.

# ADJUSTING SCREEN POSITION AND SIZE

- You can make changes to all screen adjustment options in the POSITION/SIZE Menu. See Page E-15 for the basic procedures.
- The changes you make will be stored for the selected input mode. Therefore, you need to select a desired input mode before making any changes.

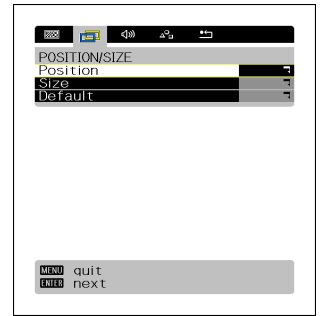

POSITION/SIZE Menu screen

## Adjusting Screen Position (Position)

Horizontal position (Horizontal)

⬆️: Moves screen to the right.



⬆️: Moves screen to the left.

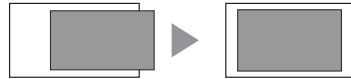

Vertical position (Vertical)

⬆️: Moves screen up.



⬆️: Moves screen down.



Press **ENTER** to store.

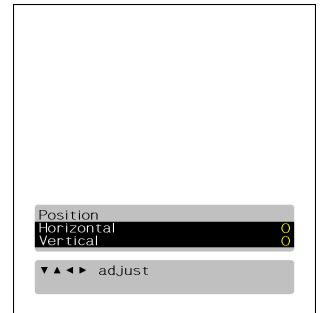

"Position" adjustment screen

## Adjusting Screen Size (Size)

Screen width (Width)

⬆️: Increases width.



⬆️: Reduces width.



Screen height (Height)

⬆️: Increases height.



⬆️: Reduces height.



Press **ENTER** to store.

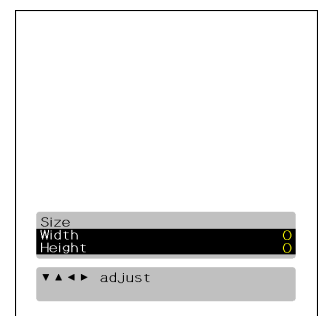



"Size" adjustment screen

# ADJUSTING AUDIO

- You can make changes to all audio adjustment options in the AUDIO Menu. See Page E-15 for the basic procedures.
- The changes you make will be stored for the selected input mode. Therefore, you need to select a desired input mode before making any changes.

## Adjusting Treble (Treble)



Press   to make adjustments.

: Stronger treble

: Weaker treble

Press  to store.

## Adjusting Bass (Bass)



Press   to make adjustments.

: Stronger bass

: Weaker bass

Press  to store.

## Adjusting Volume Balance (Balance)

Press   to make adjustments.



: Shifts the volume balance towards the right.

: Shifts the volume balance towards the left.

Press  to store.

## Setting Loudness (Loudness)

Corrects the balance between bass and treble for easy listening even with weak volume.

Each time you press  or , one of the available choices appears in the following sequence:

↔ **Off** ↔ **On** ↔

Press  to store.

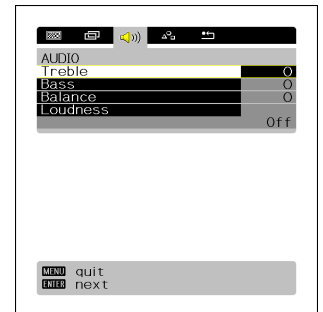

AUDIO Menu screen

### Note

- If the operation is not executed for about 60 seconds, the menu disappears.
- Depending on the model or the optional devices, some of the functions may not be available.
- The adjustment range varies according to the display signals. Make adjustments to your preferred picture quality within the adjustment range.
- Depending on the type of signal, it may not be possible to make some of the settings or adjustments.
- AUDIO menu will not be displayed when “No Audio” is selected. (See P. E-25.)

**FEATURES** setup screen has the following 4 options.

See Page E-15 for the basic procedures.

**[Adjustment]:** Can make a fine adjustment of pictures such as Dot Clock, Clamp Position.

**[On Screen Menu]:** Can make a display setting such as OSD, Language. (See P. E-23.)











**[Input Terminal]:** Can make an input terminal setting such as Video Input. (See P. E-24.)

**[Others]:** Used to make Screen Orbiter and other settings. (See P. E-25–E-26.)

## ADJUSTMENT

**Dot Clock, Clock Phase, Clamp Position, and Auto Calibration are adjusted as shown in the following chart.**



Select the item with  , and then adjust with  . Finally, press  to implement the adjustments.

Adjustment Item	Contents of Adjustments	Operation
Dot Clock (mD-sub)	You may find the vertically-striped pattern in pictures, depending on the clock frequency of your PC's processor. If you experience blurring, you can obtain a clearer picture by adjusting the "Dot Clock".	Use   to adjust to minimize vertically-striped pattern in pictures.
Clock Phase (mD-sub)	Pictures and the outline of letters may blur or flicker as the clock phase of your PC may be different. In this case, adjust the clock phase manually. Normally, the automatic setting ensures the optimal value.	When "Manual" is selected, use   to adjust to minimize pictures blur.
Clamp Position (mD-sub, Comp. video)	Adjusts the extremely dark or bright pictures. Normally, the automatic setting ensures the optimal value.	Use   to adjust pictures optimally.
Auto Calibration (mD-sub)	Adjusts the dynamic range of images to the optimum. Performed while a white screen signal is received.	Display the Auto Calibration screen. Select "Execute" and press  . Press  or  to select "Yes", and press  .

## ON SCREEN MENU

### Setting Display Information (OSD)

You can use this option to select from following display indication.

Each time you press  or , one of the available choices appears in the following sequence:

↔ On (OSD:bright) ↔ On (OSD:dark) ↔

**[On (OSD:bright)]:** On-screen information shown in light color.

**[On (OSD:dark)]:** On-screen information shown in dark color.

Press  to store.

\* If the screen picture is too bright, some characters may be difficult to watch when [On (OSD:dark)] is selected.

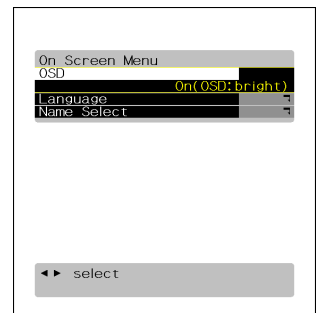



OSD selection screen

### Selecting Language (Language)

You can use this option to select the language displayed on the screen.

(1) Select "Language" and press .

The "Language" selection screen will appear.

(2) Press  or  to select your desired language.

- English
- Deutsch (German)
- Español (Spanish)
- Français (French)
- Italiano (Italian)
- Nederlands (Dutch)
- Русский (Russian)

(3) Press .

The menu is displayed in the selected language.

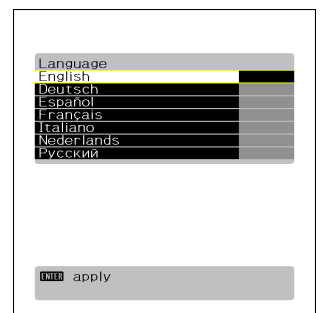

"Language" selection screen

# OTHER ADJUSTMENTS (Continued)

## Selection of indications (Name Select)

You can change the settings for indications for video inputs and RGB inputs.

### Video input

You can change the settings for indications for the VIDEO inputs.

Select the desired indication in accordance with the connected equipment.

Each time  $\leftarrow$   $\rightarrow$  is pressed, the setting is switched. (In the case of VIDEO1)

$\leftrightarrow$  **Video1**  $\leftrightarrow$  **DVD1**  $\leftrightarrow$  **DVD2**  $\leftrightarrow$  **VCR1**  $\leftrightarrow$  **VCR2**  $\leftrightarrow$  **GAME**  $\leftrightarrow$  **Camcorder**  $\leftrightarrow$  **STB**  $\leftrightarrow$  **Satellite**  $\leftrightarrow$  **Cable TV**  $\leftrightarrow$

Press  $\text{ENTER}$  to store.

### RGB input

You can change the settings for indications for the RGB inputs.

Select the desired indication in accordance with the connected equipment.

Each time  $\leftarrow$   $\rightarrow$  is pressed, the setting is switched. (In the case of RGB 1)

$\leftrightarrow$  **RBG1**  $\leftrightarrow$  **PC1**  $\leftrightarrow$  **PC2**  $\leftrightarrow$  **DVD1**  $\leftrightarrow$  **DVD2**  $\leftrightarrow$  **STB**  $\leftrightarrow$  **Satellite**  $\leftrightarrow$  **Cable TV**  $\leftrightarrow$

Press  $\text{ENTER}$  to store.

## SETTING THE INPUT TERMINALS

### Selecting the settings of Video/S-video Input terminal

You can use this option to select the color format appropriate for the input signal.

Each time you press  $\leftarrow$  or  $\rightarrow$ , one of the available modes appears in the following sequence:

$\leftrightarrow$  **Auto1**  $\leftrightarrow$  **Auto2**  $\leftrightarrow$  **NTSC**  $\leftrightarrow$  **PAL**  $\leftrightarrow$  **SECAM**  $\leftrightarrow$  **PAL60**  $\leftrightarrow$  **N-PAL**  $\leftrightarrow$  **M-PAL**  $\leftrightarrow$  **4.43NTSC**  $\leftrightarrow$

**[Auto1]:** Automatically selects NTSC, PAL and SECAM.

**[Auto2]:** Automatically selects NTSC and M-PAL.

**[Other than Auto]:** You need to select a system appropriate to the input signal.

Press  $\text{ENTER}$  to store.

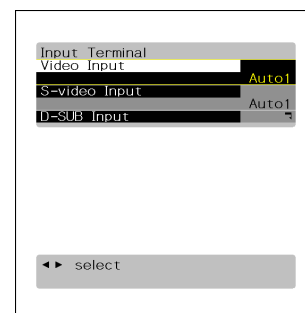

Input Terminal Settings Screen

### Selecting the settings of D-SUB Input terminal

You can use this option to select the signal system it will receive to D-SUB Input terminal.

(1) Select D-SUB Input and press  $\text{ENTER}$ .

D-SUB Input screen appears.

(2) Select the signal system to receive.

Each time you press  $\leftarrow$  or  $\rightarrow$ , one of the available choices appears in the following sequence:

$\leftrightarrow$  **RGB-PC**  $\leftrightarrow$  **Decoder**  $\leftrightarrow$

**[RGB-PC]:** For using RGB of PC

**[Decoder]:** For using digital broadcast tuner

(3) Press  $\text{ENTER}$  to store.

### Note

- If the operation is not executed for about 60 seconds, the menu disappears.
- Depending on the model or the optional devices, some of the functions may not be available.
- The adjustment range varies according to the display signals. Make adjustments to your preferred picture quality within the adjustment range.
- Depending on the type of signal, it may not be possible to make some of the settings or adjustments.



## OTHER SETTINGS

### Auto Off-NO SIG.

You can make to the standby state automatically when the no signal state continued during set up time.

Press to select the "Time".

Press to select the amount of time before the standby state starts.

↔ **Off** ↔ **1 min.** ↔ **15 min.** ↔ **45 min.** ↔ **60 min.** ↔

Press to store.

\* The numerical value is the approximate amount of time before the standby state starts.

You can assign the black or white color for the background color at the no signal state.

Press to select the "Background".

Press to select the displayed background displayed.

↔ **Black** ↔ **White** ↔

Press to store.

\* The background color changes to assigned color state after approximate 20 seconds at the no signal state.

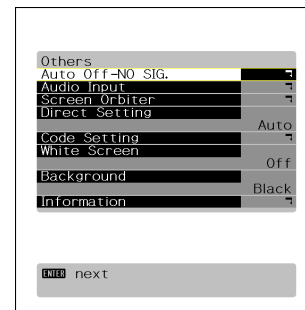

"Auto Off-NO SIG." selection screen

### Selecting input terminals (Audio Input)

You can use this option to select the available terminals to receive the audio from input equipment.

(1) Select "Audio Input" and press .

The "Audio Input" selection screen will appear.

(2) Press or to select video input terminal.

(3) Select a related audio input terminal.

Each time you press or , one of the available choices appears in the following sequence:

↔ **No Audio** ↔ **Audio 1** ↔ **Audio 2** ↔ • • • • • ↔

**[No Audio]:** No audio in the corresponding mode.

**[Audio 1-3]:** Selects Audio 1 through 3 for receiving audio in the corresponding mode.

**[Audio 4-5]:** HDMI

\* There is also "Audio Input" that cannot be selected.

\* Repeat steps (2) and (3) for each piece of input equipment.

(4) Press to store.

\* AUDIO menu will not be displayed when "No Audio" is selected.

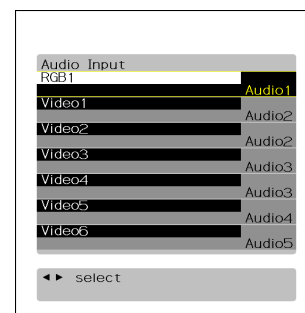

"Audio Input" setting screen

### Minimizing phosphor burn-in (Screen Orbiter)

for RGB

You can use this option to move the screen position to minimize phosphor-induced "burn-in".

Follow the steps below.

(1) Select "Screen Orbiter" and press .

The "Screen Orbiter" setting screen will appear.

(2) Press or to select "Mode/Time".

(3) Select a desired pattern.

Each time you press or , one of the available choices appears in the following sequence:

↔ **Off** ↔ **Time** ↔ **Mode** ↔

**[Off]:** Disables Screen Orbiter.





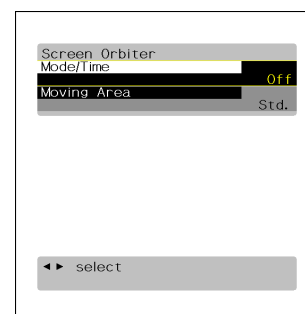

**[Time]:** Moves the pattern approximately every one hour.

**[Mode]:** Moves the pattern when the power is turned ON or when you switch between modes.



"Screen Orbiter" setting screen



# OTHER ADJUSTMENTS (Continued)

- (4) Press  or  to select "Moving Area".
- (5) Press  or  to select the range for moving the pattern.  
Each time you press  or , one of the available choices appears in the following sequence:  
**↔ Min. ↔ Std. ↔ Max. ↔**
- [Min.]:** Pattern moves in small range. (About 5 pixels)  
**[Std.]:** Pattern moves in moderate range. (About 10 pixels)  
**[Max.]:** Pattern moves in wide range. (About 15 pixels)
- (6) Press  to store.

\* When the Screen Orbiter function is operated, some screen contents at the top, bottom, right or left of the screen may move offscreen.

## Setting RGB Input Signal Compulsorily (Direct Setting)

for RGB

You can use this option to switch the setting for RGB input signal.  
Each time you press  or , one of the available choices appears in the following sequence:  
**↔ Auto ↔ VGA ↔ WVGA ↔ 480P ↔ XGA ↔ WXGA ↔ SXGA ↔ SXGA<sup>+</sup> ↔**

**[Auto]:** The optimum display is obtained automatically for input signals.

**[Others]:** The optimum resolution setting is fixed for each signal.

Press  to store.

\* In Auto mode, the resolution of VGA, WVGA, 480P, XGA, WXGA, SXGA and SXGA<sup>+</sup> may not be automatically distinguished.  
Switch to the fixed display when the image is not displayed properly.

\* Signals that are not applicable depending on the model or input terminals may not be displayed.



## Specifying RGB Input Signal (Code Setting)

for RGB

Normally, use this option in Auto mode.

## Displaying white over entire screen (White Screen)

You can use this option to display white over the entire screen to minimize phosphor burn-in.



Each time you press  or , one of the available choices appears in the following sequence:

**↔ Off ↔ On ↔**

Press  to store.

## Minimizing phosphor burn-in (Background)

When the screen size was set to "Normal", to reduce "burn-in", the brightness of the part at which left and right images are not displayed can be set. Normally, we recommend that "Light Gray" be used.

Each time you press  or , the settings is switched.

**↔ Black ↔ Dark Gray ↔ Light Gray ↔**

Press  to store.

\*Burn-in can still occur if the Normal mode is shown for extended periods.

## Displaying System Status (Information)

Displays system operation status.

Select "Information" and press .

The "Information" screen will appear.

**[Mode]:** Input mode appears at the upper right corner of the screen

**[Freq. Scan Mode]:** Frequency scanning

**[Input Signal]:** Video mode

**[Input Sync]:** Signal type

**[Freq.]:** Synchronized signal frequency, polarity

**[Preset No.]:** RGB code number

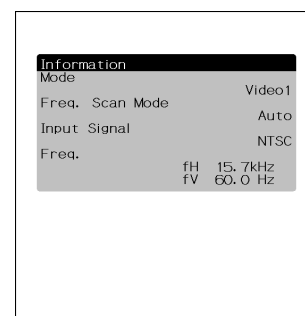

Information screen  
(Video Mode)

### Note



- If the operation is not executed for about 60 seconds, the menu disappears.
- Depending on the model or the optional devices, some of the functions may not be available.
- The adjustment range varies according to the display signals. Make adjustments to your preferred picture quality within the adjustment range.
- Depending on the type of signal, it may not be possible to make some of the settings or adjustments.



# INITIALIZATION OF USER ADJUSTMENT VALUE

You can restore the values of the adjustment/setting made in the MENU to factory settings.



**1** Press  .  
The main menu screen will appear.

**2** Press  or  to select "FACTORY DEFAULT".

Each time you press  or , one of the available menus appears in the following sequence:

**PICTURE ↔ POSITION/SIZE ↔ AUDIO ↔ FEATURES  
↔ FACTORY DEFAULT**

The FACTORY DEFAULT Menu screen will appear.

**3** Press  .  
• Displays the message of whether to proceed with the initialization.

**4** Press  or  to select the Yes.

**5** Press  .  
• The message of having completed the initialization will be displayed after initializing.

**6** Press  when you finish.

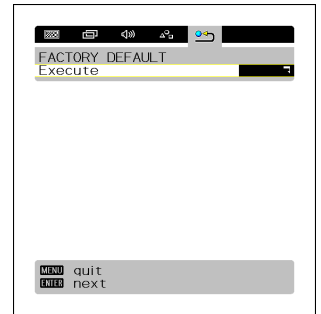

"FACTORY DEFAULT" selected in the main menu screen

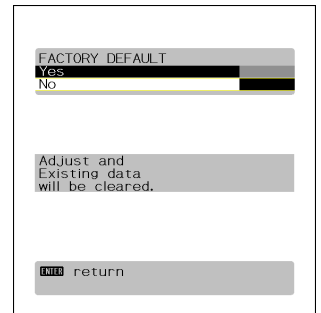

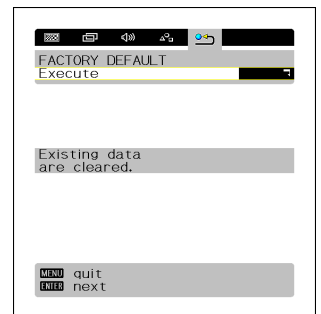

Displays the message of whether to proceed the initialization

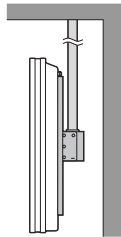
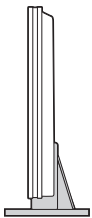
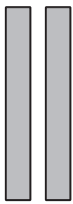

Displays the message of having completed the initialization

# OPTIONS

Wall-mounting Bracket	0° to 15° mounting angle	P-WB4201 (for 42" model/50" model)	
Ceiling unit	5° to 25° mounting angle	P-CT4200 (for 42" model/50" model)	
Desktop Stand unit		P-TT4202 (for 42" model/50" model)	
Speaker (1 set of 2 speakers)		P-SP1000 (for attaching to the display) for 42" model/50" model P-SP4200 (for mounting on the speaker stands) for 42" model P-SP5010 (for mounting on the speaker stands) for 50" model	
Desktop Speaker Stand (1 set of 2 speaker stands)		P-ST4200 (for P-SP4200) P-ST5000 (for P-SP5010)	

- \* When installing an option, make sure that all installation requirements for that option (as given in the relevant instruction manual) are met.
- \* The colors of options do not match the display colors perfectly.
- \* To improve the function and performance of optional accessories, specifications and part names may change. Consult your local dealer before purchasing.

## Warning

To prevent injury, fire, and electric shock, arrange for options to be initially installed (or installed at a different location) by your dealer.

## CAUTION

This display (P42XHA58/P50XHA58) is for use only with Fujitsu General Limited's option (P-WB4201, P-CT4200, P-TT4202). Using this display with other option can cause instability resulting in possible injury.

# MAIN SUPPORTED SIGNALS

The plasma display can store up to four types of signals for RGB adjustment values. The plasma display uses the first-in, first-out method; therefore, the first input signal is cleared when the fifth one is input.

Input the signal you want to store and adjust to a desired screen according to “ADJUSTING SCREEN POSITION AND SIZE”.

When the adjustment has been made, it is automatically stored. Thus, when the plasma display receives the same signal later, pictures will be displayed in accordance with the adjustment value most recently stored.

## Main corresponding signals (RGB mode)

Display (dots x lines)	Horizontal frequency (kHz)	Vertical frequency (Hz)	Signal
640 x 480	31.47	59.94	VGA
640 x 480	37.50	75.00	VGA 75 Hz
640 x 480	43.27	85.01	VGA 85 Hz
720 x 400	31.47	70.09	400 lines
800 x 600	37.88	60.32	SVGA 60 Hz
800 x 600	46.88	75.00	SVGA 75 Hz
800 x 600	53.67	85.06	SVGA 85 Hz
1024 x 768	48.36	60.00	XGA 60 Hz
1024 x 768	60.02	75.03	XGA 75 Hz
1024 x 768	68.68	84.99	XGA 85 Hz
1280 x 1024	63.98	60.02	SXGA 60 Hz
1280 x 1024	79.98	75.03	SXGA 75 Hz
848 x 480	31.02	60.00	
852 x 480	31.72	59.97	
1360 x 768	47.71	60.01	
720 x 485	15.73	59.94	60 fields
720 x 575	15.63	50.00	50 fields

\* With some input signals, “Out of range” may appear even when the horizontal and vertical frequencies are within their permissible ranges. In this event, match the input signals to another frequency rather than those listed above.

In the Comp.video and Video/S-video, the display has been factory-set as follows for different input signals:

## Main corresponding signals (Comp.video, HDMI mode)

Horizontal frequency (kHz)	Vertical frequency (Hz)	Signal	HDMI
15.73	59.94	SDTV 480i	○
15.63	50.00	SDTV 576i	○
31.47	59.94	SDTV 480p	○
31.25	50.00	SDTV 576p	○
45.00	60.00	HDTV 720p	○
37.50	50.00	HDTV 720p	○
33.75	60.00	HDTV 1080i	○
28.13	50.00	HDTV 1080i	○

## Main corresponding signals (Video, S-video mode)

Horizontal frequency (kHz)	Vertical frequency (Hz)	Signal
15.73	59.94	NTSC
15.63	50.00	PAL
15.63	50.00	SECAM
15.63	59.52	PAL60
15.63	50.00	N-PAL
15.73	59.95	M-PAL
15.73	59.94	4.43NTSC

## Note

- Depending on the input signal, the display may show pictures of reduced size due to size reduction and interpolation.
- You can check input signals through “Information” on the FEATURES Menu screen. (See P. E-26.)
- In order to facilitate the explanations, pictures and diagrams in this manual may differ slightly from the actual items.
- All terms (i.e., company and product names) used in this document are trademarks or registered trademarks.

# SPECIFICATIONS

## WIDE PLASMA DISPLAY

Model	Series Name	P42XHA58E	P50XHA58E
	Product Name	P42XHA58EBb	P50XHA58EBb
Screen size		42" wide screen: 92.2 cm (W) x 52.2 cm (H) (106.0 cm diagonal) 36.3 inch (W) x 20.6 inch (H) (41.7 inch diagonal)	50" wide screen: 110.6 cm (W) x 62.2 cm (H) (126.9 cm diagonal) 43.5 inch (W) x 24.5 inch (H) (50 inch diagonal)
Aspect ratio		16:9 (wide)	
Number of pixels		1024 (H) x 768 (V)	1366 (H) x 768 (V)
Weight		30 kg / 66.1 lbs	41 kg / 90.4 lbs
Outer dimensions		103.9 (W) x 64.0 (H) x 8.7 (D) cm 40.9 (W) x 25.2 (H) x 3.4 (D) inch (does not include outer projections)	121.6 (W) x 72.6 (H) x 10.0 (D) cm 47.9 (W) x 28.6 (H) x 3.9 (D) inch (does not include outer projections)
Power supply		110-240 VAC 50/60 Hz	
Current rating		4.2-1.5 A	5.1-2.0 A
External equipment terminals			
Video input terminals	VIDEO1 INPUT (Video input)	RCA terminal	1 Vp-p/75 Ω
	VIDEO2 INPUT (S-video input)	S terminal	Y: 1 Vp-p/75 Ω C: 0.286 Vp-p/75 Ω
	VIDEO3/VIDEO4 INPUT (Component video input)	3 RCA terminals	Y: 1 Vp-p/75 Ω P <sub>B</sub> /C <sub>B</sub> : 0.7 Vp-p/75 Ω P <sub>R</sub> /C <sub>R</sub> : 0.7 Vp-p/75 Ω
	VIDEO5/VIDEO6 INPUT (HDMI input, Video/Audio)	HDMI terminal (HDMI type A connector)	
PC input terminal	RGB1 input	mD-sub, 3 rows, 15-pin Picture signal: 0.7 Vp-p/75 Ω Synchronization signal: TTL level	
Audio terminals	2 audio input pin jacks (L/R) (3 lines) 500 mVrms/at least 22 kΩ		
Control terminal	RS-232C connector (D-sub 9-pin)		
External speaker output terminal	Max. output: 10 W + 10 W, 6 Ω		
Operating conditions	Temperature: 0 to 40 °C / 32 to 104 °F Humidity: 20 to 80 %		
Accessories	User's manual, Safety Precautions, Remote control, AA battery (2), Power cord, Small ferrite core (2), Large ferrite core (2)		

## Regulation

- CE Safety: EN60065
- EMC: EN55022 (CISPR22)
- EN55024 (CISPR24)
- EN61000-3-2
- EN61000-3-3

## Precautions

Be sure to remove the power plug from the receptacle before cleaning the display.

Be sure not to clean the display using a cloth dampened with volatile solvents, such as benzene or thinner. Such solvents can harm the display's cabinet, the filter at the screen front, and the remote control. They can also cause paint to come off these sections.

## Cleaning the Screen

Clean the screen gently with a soft cloth.

The screen surface is fragile. Never attempt to clean it with a hard material, press on it forcefully, or tap it.

## Cleaning the Cabinet and Remote Control

Use a soft cloth for cleaning.

If the cabinet or remote control is heavily stained, soak a soft cloth in a mixture of water and detergent and squeeze it dry before wiping off the stains. Use a soft, dry cloth for final cleaning.

## Cleaning the ventilation grille

Remove dust from the ventilation grille in the rear of the main unit periodically with a vacuum cleaner as the accumulated dust can increase the internal temperature of the main unit causing machine failure or fire hazard.

## BEFORE OBTAINING SERVICE

In the event of problems with the display, check the following explanations before contacting your dealer for servicing.

Problem	Action
<ul style="list-style-type: none"> <li>• Power does not turn ON.</li> </ul>	<ul style="list-style-type: none"> <li>• Check whether the power plug is securely inserted into the receptacle.</li> </ul>
<ul style="list-style-type: none"> <li>• No pictures are displayed.</li> </ul>	<ul style="list-style-type: none"> <li>• Check cables for disconnection.</li> <li>• Check whether the power for all input equipment is ON.</li> <li>• Check for connection to wrong terminals or for wrong input mode.</li> <li>• Check whether the input mode display is colored pink. Special setup may have been made. Return to original setup or initialize the User adjustment value.</li> </ul>
<ul style="list-style-type: none"> <li>• Remote control does not function properly.</li> </ul>	<ul style="list-style-type: none"> <li>• Check for incorrect battery orientation.</li> <li>• Check for dead batteries.</li> <li>• Check for distance from the display.</li> <li>• Check whether you are pointing the remote control transmitter properly at the display's receiver.</li> <li>• Check for any obstacle between the remote control and the display.</li> </ul>
<ul style="list-style-type: none"> <li>• The display makes a snapping sound.</li> </ul>	<ul style="list-style-type: none"> <li>• This sound is produced when the cabinet expands or contracts due to variations in temperature. This sound does not indicate that the display has a problem.</li> </ul>
<ul style="list-style-type: none"> <li>• The display makes a buzzing sound.</li> </ul>	<ul style="list-style-type: none"> <li>• The display has fans to maintain the temperature of internal components at a constant level. This sound is produced by the fan as it rotates. (Applies to models equipped with a fan)</li> </ul>
<ul style="list-style-type: none"> <li>• There are spots on the screen.</li> </ul>	<ul style="list-style-type: none"> <li>• Check whether your AV equipment is affected by interference from automobiles, trains, high-voltage transmission lines, neon signs or other potential sources of interference.</li> </ul>
<ul style="list-style-type: none"> <li>• Degraded colors/tints</li> </ul>	<ul style="list-style-type: none"> <li>• Check whether all picture adjustments have been properly made. (See "Adjusting the Picture" on P. E-16–E-17.)</li> </ul>
<ul style="list-style-type: none"> <li>• Improper screen position/size</li> </ul>	<ul style="list-style-type: none"> <li>• Check whether screen position and size have been properly adjusted. (See "Adjusting Screen Position and Size" on P. E-21.)</li> </ul>
<ul style="list-style-type: none"> <li>• No audio</li> </ul>	<ul style="list-style-type: none"> <li>• Check cables for disconnection.</li> <li>• Check whether the proper audio input has been selected. (See "Audio Input" on P. E-25.)</li> </ul>
<ul style="list-style-type: none"> <li>• If "Out of range" appears, the display is receiving a signal whose picture or signal cannot be reproduced by the display.</li> <li>• The screen turns to black and white.</li> </ul>	<ul style="list-style-type: none"> <li>• Signals that are not supported by this display have been input. Check which signals are supported. (See "MAIN SUPPORTED SIGNALS" on P. E-29.)</li> </ul>
<ul style="list-style-type: none"> <li>• If "Error message Condition 1" appears, the fan is defective.</li> </ul>	<ul style="list-style-type: none"> <li>• Remove the power plug from the receptacle, and contact your dealer for repairs. (Applies to models equipped with a fan)</li> </ul>
<ul style="list-style-type: none"> <li>• If "Error message Condition 2" appears, the display's internal components are extremely hot.</li> </ul>	<ul style="list-style-type: none"> <li>• Remove the power plug from the receptacle. (You can turn the power back ON again when the components have cooled sufficiently.) If the message appears again when you turn the power back on, remove the power plug from the receptacle, and contact your dealer for a repairs.</li> </ul>
<ul style="list-style-type: none"> <li>• If "Change refresh rate to 60Hz" appears.</li> </ul>	<ul style="list-style-type: none"> <li>• The picture may get blurred with vertical frequency of other than 48.3-51.8 or 58.4-61.4 (Hz). Change the setting of your PC, etc.</li> </ul>
<ul style="list-style-type: none"> <li>• If the power indicator lamp flashes red or green.</li> </ul>	<ul style="list-style-type: none"> <li>• Remove the power plug from the receptacle, and inform your dealer about how the lamp flashed. The power indicator lamp flashes differently depending on the type of problem.</li> </ul>

## Note

- Functions may not be available with some models and some device options.

