

User's Manual



PlasmaSync 42XP10
PlasmaSync 50XP10
PlasmaSync 60XP10

Package Contents

- Plasma Monitor
- Remote control and AA Batteries
- Power cord
- Users Manual (CD-ROM)
- Start Up Guide (Paper / CD-ROM)
- Main Power Switch cover and screw
- Cable clamps

Table of Contents

Important Safety Instructions.....	English-1
Important Information	English-2
Safety Precautions and Maintenance.....	English-3
Recommended Use.....	English-4
Installation	
Using Optional Stands/Mounts.....	English-6
Mounting Location	English-6
Mounting on Ceiling.....	English-7
Maintenance, Orientation, Cable Management	English-7
Using the Remote	English-8
Part Names and Functions	
Control Panel	English-9
Terminal Panel.....	English-10
Remote Control Functions.....	English-11
Power, Display, Digital Zoom, Pointer, Main Power Switch Cover	English-12
Remote Control ID.....	English-13
On-Screen Display (OSD)	
Using the OSD.....	English-14
OSD.....	English-15
Operation	
Picture Size Using Video Signals.....	English-19
Picture Size Using Computer Signals.....	English-20
Split Screen Mode	English-21
Picture in Picture Mode.....	English-22
Creating a Video Wall.....	English-23
Using the Timer.....	English-24
Repeat Timer	English-25
RS-232C	English-26
Troubleshooting.....	English-30
Specifications	
P42XP10	English-31
P50XP10	English-32
P60XP10.....	English-33
Supported Resolutions	
P42XP10	English-34
P50XP10	English-36
P60XP10.....	English-38
Pin Assignment.....	English-40

Important Safety Instructions

Read Before Operating Equipment.

1. Read these instructions.
 2. Keep these instructions.
 3. Heed all warnings.
 4. Follow all instructions.
 5. Do not use this apparatus near water.
 6. Clean only with a dry cloth.
 7. Do not block any of the ventilation openings. Install in accordance with the manufacturer's instructions.
 8. Do not install near any heat sources such as radiators, heat registers, stoves, or other apparatus (including amplifiers) that produce heat.
 9. Do not defeat the safety purpose of the polarized or grounding-type plug. A polarized plug has two blades with one wider than the other. A grounding type plug has two blades and third grounding prong. The wide blade or third prong are provided for your safety. If the provided plug does not fit into your outlet, consult an electrician for replacement of the obsolete outlet.
 10. Protect the power cord from being walked on or pinched particularly at plugs, convenience receptacles, and the point where they exit from the apparatus.
 11. Only use attachments/accessories specified by the manufacturer
 12. Use only with the cart, stand, tripod, bracket, or table specified by the manufacturer, or sold with the apparatus. When a cart is used, use caution when moving the cart or apparatus combination to avoid injury from tip-over.
- 
13. Unplug this apparatus during lightning storms or when unused for long periods of time
 14. Refer all servicing to qualified service personnel. Servicing is required when the apparatus has been damaged in any way, such as when the power-supply cord or plug is damaged, liquid has been spilled or objects have fallen into the apparatus, the apparatus has been exposed to rain or moisture, does not operate normally, or has been dropped
 15. Damage Requiring Service -The appliance should be serviced by qualified service personnel when:
 - A. The power supply cord or the plug has been damaged;
 - or
 - B. Objects have fallen, or liquid has been spilled into the appliance;
 - or
 - C. The appliance has been exposed to rain;
 - or
 - D. The appliance does not appear to operate normally or exhibits a marked change in performance;
 - or
 - E. The appliance has been dropped, or the enclosure damaged.
 16. Tilt/Stability - All monitors must comply with recommended international global safety standards for tilt and stability properties of its cabinet design. Do not compromise these design standards by applying excessive pull force to the front, or top, of the cabinet which could ultimately overturn the product. Also, do not endanger yourself, or children, by placing electronic equipment/toys on the top of the cabinet. Such items could unsuspectingly fall from the top of the set and cause product damage and/or personal injury.
 17. Wall/Ceiling Mounting - The appliance should be mounted to a wall/ceiling only as recommended by the manufacturer.
 18. Power Lines - An outdoor antenna should be located away from power lines.
 19. Outdoor Antenna Grounding - If an outside antenna is connected to the receiver, be sure the antenna system is grounded so as to provide some protection against voltage surges and built up static charges. Section 810 of the National Electric code. ANSI/NFPA No.70-1984, provides information with respect to proper grounding of the mats and supporting structure, grounding of the lead-in wire to an antenna-discharge unit, size of grounding connectors, location of antenna discharge unit, connection to grounding electrodes and requirements for the grounding electrode.
 20. Objects and Liquid Entry - Care should be taken so that objects do not fall and liquids are not spilled into the enclosure through openings. Apparatus shall not be exposed to dripping or splashing and no objects filled with liquids, such as vases, shall be placed on apparatus

Additional Safety Information

15. This product may contain lead. Disposal of these materials may be regulated due to environmental considerations.
For disposal or recycling information, please contact your local authorities or the Electronic Industries Alliance: www.eiae.org.

WARNING

To reduce the risk of fire or electric shock, do not expose this apparatus to rain or moisture.

Important Information

WARNING



TO PREVENT FIRE OR SHOCK HAZARDS, DO NOT EXPOSE THIS UNIT TO RAIN OR MOISTURE. DO NOT USE THIS UNIT'S POLARIZED PLUG WITH AN EXTENSION CORD RECEPTACLE OR OTHER OUTLETS UNLESS THE PRONGS CAN BE FULLY INSERTED.



REFRAIN FROM OPENING THE CABINET AS THERE ARE HIGH VOLTAGE COMPONENTS INSIDE. REFER SERVICING TO QUALIFIED SERVICE PERSONNEL.

CAUTION

CAUTION: TO REDUCE THE RISK OF ELECTRIC SHOCK, MAKE SURE POWER CORD IS UNPLUGGED FROM WALL SOCKET. TO FULLY DISENGAGE THE POWER TO THE UNIT, PLEASE DISCONNECT THE POWER CORD FROM THE AC OUTLET. DO NOT REMOVE COVER (OR BACK). NO USER SERVICEABLE PARTS INSIDE. REFER SERVICING TO QUALIFIED SERVICE PERSONNEL.



This symbol warns user that uninsulated voltage within the unit may have sufficient magnitude to cause electric shock. Therefore, it is dangerous to make any kind of contact with any part inside this unit.



This symbol alerts the user that important literature concerning the operation and maintenance of this unit has been included. Therefore, it should be read carefully in order to avoid any problems.

CAUTION: Please use the power cord provided with this display in accordance with the table below. If a power cord is not supplied with this equipment, please contact your supplier. For all other cases, please use a power cord that matches the AC voltage of the power outlet and has been approved by and complies with the safety standard of your particular country.

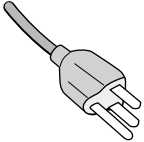
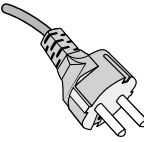
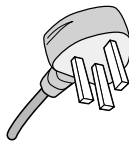
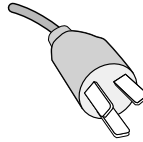
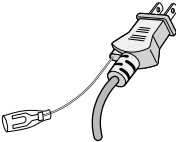
Plug Type	North America	European Continental	U.K.	Chinese	Japanese
Plug Shape					
Country	U.S.A./Canada	EU (except U.K.)	U.K.	China	Japan
Voltage	120*	230	230	220	100

*When operating the PlasmaSync monitor with its AC 125-240V power supply, use a power supply cord that matches the power supply voltage of the AC power outlet being used.

Canadian Department of Communications Compliance Statement

DOC: This Class B digital apparatus meets all requirements of the Canadian Interference-Causing Equipment Regulations.

C-UL: Bears the C-UL Mark and is in compliance with Canadian Safety Regulations according to CAN/CSA C22.2 No. 60950-1.

FCC Information

- Use the attached specified cables with the P426Y0(P42XP10), P506Y1(P50XP10), or P606Y2(P60XP10) color monitor so as not to interfere with radio and television reception.
 - Please use the supplied power cord or equivalent to ensure FCC compliance.
 - Please use shielded video signal cable, 15-pin mini D-SUB to 15-pin mini D-SUB with ferrite cores on both ends (not included).
- This equipment has been tested and found to comply with the limits for a Class B digital device, pursuant to part 15 of the FCC Rules. These limits are designed to provide reasonable protection against harmful interference in a residential installation. This equipment generates, uses, and can radiate radio frequency energy, and, if not installed and used

in accordance with the instructions, may cause harmful interference to radio communications. However, there is no guarantee that interference will not occur in a particular installation. If this equipment does cause harmful interference to radio or television reception, which can be determined by turning the equipment off and on, the user is encouraged to try to correct the interference by one or more of the following measures:

- Reorient or relocate the receiving antenna.
- Increase the distance between the equipment and receiver.
- Connect the equipment into an outlet on a circuit different from that to which the receiver is connected.
- Consult your dealer or an experienced radio/TV technician for help.

If necessary, the user should contact the dealer or an experienced radio/television technician for additional suggestions. The user may find the following booklet, prepared by the Federal Communications Commission, helpful: "How to Identify and Resolve Radio-TV Interference Problems." This booklet is available from the U.S. Government Printing Office, Washington, D.C., 20402, Stock No. 004-000-00345-4.

WARNING

This product equipped with a three-wire grounding (earthed) plug - a plug that has a third (grounding) pin. This plug only fits a grounding-type power outlet. If you are unable to insert the plug into an outlet, contact a licensed electrician to replace the outlet with a properly grounded one. Do not defeat the safety purpose of the grounding plug.

Safety Precautions and Maintenance

Safety Precautions and Maintenance

FOR OPTIMUM PERFORMANCE, PLEASE NOTE THE FOLLOWING WHEN SETTING UP AND USING THE MONITOR:

The plasma display's panel is made up of fine picture elements (cells), of which more than 99.99 percent are active cells. Some cells may not produce light or remain constantly lit. For safe operation and to avoid damaging the unit, read carefully and observe the following instructions.

- DO NOT OPEN THE MONITOR. There are no user-serviceable parts inside and opening or removing covers may expose you to dangerous shock hazards or other risks. The manufacturer is not liable for any bodily harm or damage caused if unqualified persons attempt service or open the back cover. Refer all servicing to qualified service personnel.
- Do not spill any liquids into the cabinet or use your monitor near water.
- Do not insert objects of any kind into the cabinet slots, as they may touch dangerous voltage points, which can be harmful or fatal or may cause electric shock, fire or equipment failure.
- Do not bend, crimp or otherwise damage the power cord. Do not place any heavy objects on the power cord. Damage to the cord may cause shock or fire.
- Do not place this product on a sloping or unstable cart, stand or table, as the monitor may fall, causing serious damage to the monitor.
- Do not use in a moving vehicle, as the unit could drop or topple over and cause injuries.
- The power cable connector is the primary means of detaching the system from the power supply. The monitor should be installed close to a power outlet that is easily accessible.
- This equipment shall be connected to a MAIN outlet with a protective earth-ground connection. Do not place any objects onto the monitor and do not use the monitor outdoors.
- Do not use this unit's polarized plug with an extension cord or with outlets unless the prongs can be inserted fully.
- The power supply cord you use must have been approved by and comply with the safety standards of your country. (Type H05VV-F 3G 1mm² should be used in Europe)
- In UK, use a BS-approved power cord with molded plug having a black (13A) fuse installed for use with this monitor.
- Use only with 100 V to 240 V 50 Hz/60 Hz AC power supply. Continued operation at line voltages greater than 100 V to 240 V AC will shorten the life of the unit, and might even cause a fire hazard.
- Unplug the power cord during electrical storms or when the unit will not be in use for a long period.
- Do not use monitor in high temperature, humid, dusty, or oily areas.
- Do not cover vent on monitor.
- Clean plasma ventilation areas using a vacuum cleaner with a soft brush nozzle attachment.
- To ensure proper ventilation, cleaning the ventilation areas must be carried out monthly. More frequent cleaning may be necessary depending on the environment in which the plasma monitor is installed.
- Allow adequate ventilation around the monitor so that heat can properly dissipate. Do not block ventilated openings or place the monitor near a radiator or other heat sources. Do not put anything on top of monitor.
- Handle with care when transporting. Save packaging for transporting.
- As is the case with any phosphor-based display (like a CRT monitor, for example) light output will gradually decrease over the life of a Plasma Display Panel.
- To avoid sulfurization it is strongly recommended not to place the unit in a dressing room in a public bath or hot spring bath.



CAUTION

Immediately unplug your monitor from the wall outlet and refer servicing to qualified service personnel under the following conditions:

- When the power supply cord or plug is damaged.
- If liquid has been spilled on, or objects have fallen into the monitor.
- If the monitor has been exposed to rain or water.
- If the monitor has been dropped or the cabinet damaged.
- If the monitor does not operate normally by following operating instructions.

CAUTION

CORRECT PLACEMENT AND ADJUSTMENT OF THE MONITOR CAN REDUCE EYE, SHOULDER AND NECK FATIGUE. CHECK THE FOLLOWING WHEN POSITIONING THE MONITOR:

- For optimum performance, allow 20 minutes for warm-up.
- Rest your eyes periodically by focusing on an object at least 5 feet away. Blink often.
- Position the monitor at a 90 degree angle to windows and other light sources to minimize glare and reflections.
- Clean the monitor surface with a lint-free, nonabrasive cloth. Avoid using any cleaning solution or glass cleaner.
- Adjust the monitor's brightness and contrast controls to enhance readability.
- Get regular eye checkups.

Ergonomics

To realize the maximum ergonomic benefits, we recommend the following:

- Use the preset Size and Position controls with standard signals.
- Use the preset Color Setting.
- Do not use primary color blue on a dark background, as it is difficult to see and may produce eye fatigue due to insufficient contrast.
- This equipment is not for use at video display work station according to Bildscharb V.

For more detailed information on setting up a healthy work environment, refer to the following document:

*American National Standard for Human Factors
Engineering of Visual Display Terminal Workstations
ANSI-HFS Standard No. 100-1988*

Published by:

The Human Factors and Ergonomics Society
P.O. Box 1369, Santa Monica, California 90406.

Cleaning the Panel

- When the panel becomes dusty or dirty, wipe gently with soft cloth.
- Do not rub the panel with coarse material.
- Do not apply pressure to the surface.
- Do not use OA cleaner. OA cleaner will cause deterioration or discolor the surface.

Cleaning the Cabinet

- Unplug the power supply.
- Gently wipe the cabinet with a soft cloth.
- To clean the cabinet, dampen the cloth with a neutral detergent and water, wipe the cabinet and follow with a dry cloth.

NOTE: The surface of the cabinet is composed of many types of plastic. DO NOT clean with benzene thinner, alkaline detergent, alcoholic system detergent, glass cleaner, wax, polish cleaner, soap powder, or insecticide. Rubber or vinyl should not be in contact with the cabinet for an extended period of time. These types of fluids and materials can cause the paint to deteriorate, crack or peel.

CLEANING THE VENT HOLES

- Clean plasma ventilation areas using a vacuum cleaner with a soft brush nozzle attachment.
- To ensure proper ventilation, cleaning the ventilation areas must be carried out monthly. More frequent cleaning may be necessary depending on the environment in which the plasma monitor is installed.

Recommended Use - *continued*

To avoid or minimize image retention:

Like all phosphor-based display devices and all other gas plasma displays, plasma monitors can be susceptible to image retention under certain circumstances. Certain operating conditions, such as the continuous display of a static image over a prolonged period of time, can result in image retention if proper precautions are not taken. To protect your investment in this plasma monitor, please adhere to the following guidelines and recommendations for minimizing the occurrence of image retention:

- Always enable and use your computer's screen saver function during use with a computer input source.
- Display a moving image whenever possible.
- Change the position of the menu display from time to time.
- Always power down the monitor when you are finished using it.

To reduce the likelihood of image retention from long-term use:

- Lower the Brightness and Contrast levels as much as possible without impairing image readability.
- Display an image with many colors and color gradations (i.e. photographic or photo-realistic images).
- Create image content with minimal contrast between light and dark areas. Use complementary or pastel colors whenever possible.
- Avoid displaying images with few colors and distinct, sharply defined borders between colors.

Plasma monitor driving sound

- The panel of the Plasma monitor is composed of extremely fine pixels and these pixels emit light according to received video signals. This principle may cause you to hear a buzz or electrical hum coming from the Plasma monitor. Also note that the rotation speed of the cooling fan motor increases when the ambient temperature of the Plasma monitor becomes high. You may hear the sound of the motor at that time.

NOTE: The following items are not covered by the warranty.

- Image retention
- Panel generated sound. Examples: Fan motor and electrical noises circuit humming /glass panel buzzing.

OPERATING ENVIRONMENT

Operating environment temperature and humidity: 0 °C to +40 °C (+32 °F to +104 °F); less than 80%RH (cooling vents not blocked) Do not install this unit in a poorly ventilated area, or in locations exposed to high humidity or direct sunlight (or strong artificial light)

WARNING

Not for use in a computer room as defined in the Standard for the Protection of Electronic Computer/Data Processing Equipment ANSI/NFPA 75.

NOTE: Please use shielded video signal cable, 15-pin mini D-SUB to 15-pin mini D-SUB with ferrite cores on both ends (not included).

Using Optional Stand/Mounts

An optional stand or mounting apparatus can be installed .

When stand or mounting apparatus is to be installed while the unit is face-down (Figure 1), be sure to lay the protective sheet (the foam sheet that the unit was wrapped in) underneath the unit on order to prevent damage to the screen.

This unit must be used with a stand or some type of mounting apparatus. This unit is not designed for use without additional support.

- For correct Installation and Mounting it is recommended to use a trained, authorized dealer.
- Failure to follow correct mounting procedures could result in damage to the unit or to the installer.
- Product warranty does not cover damage caused by improper installation.

CAUTION:

- To install, follow those instructions included with the stand or mounting apparatus. Use only those devices recommended by the manufacturer.
- Make sure to install stand or mounting apparatus to the unit while on a surface that is strong and stable enough to support the weight of the unit, such as a floor or sturdy table.
- Use the specified clasps for installation.
- Take necessary steps to prevent the unit from tipping or falling.

Mounting Location

The ceiling and wall must be strong enough to support the monitor and mounting accessories.

- DO NOT install in locations where a door or gate can hit the unit.
- DO NOT install in areas where the unit will be subjected to strong vibrations and dust.
- DO NOT install near where the main power supply enters the building.
- DO NOT install in where people can easily grab and hang onto the unit or the mounting apparatus.
- When mounting in an enclosure or in a recessed area, as in a wall, leave at least 2 inches (50mm) of space between the monitor and the wall for proper ventilation (Figure 2).
- Allow adequate ventilation or provide air conditioning around the unit, so that heat can properly dissipate away from the unit and mounting apparatus.

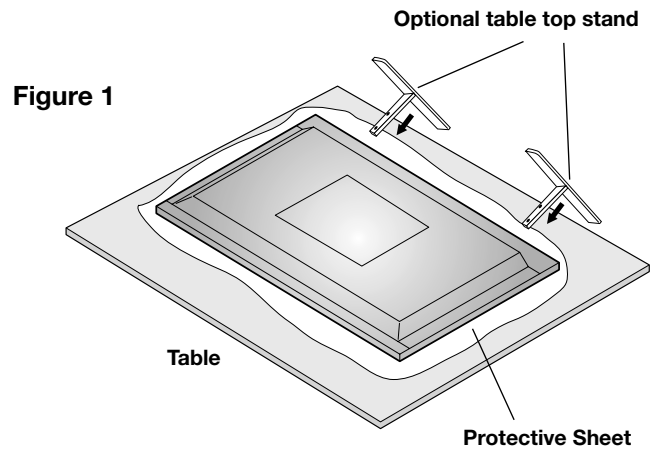
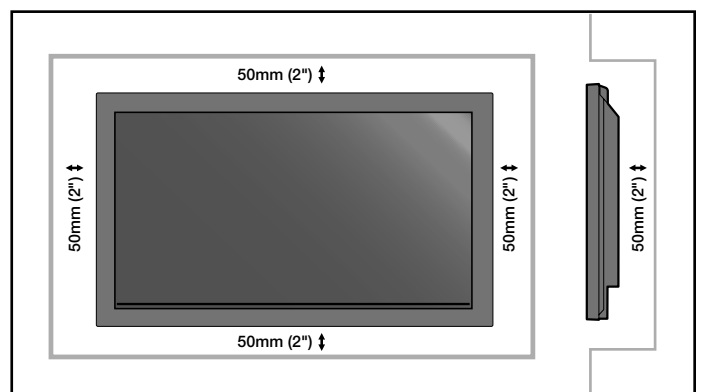

Figure 2



Installation - continued

Mounting on Ceiling

- Ensure that the ceiling is sturdy enough to support the weight of the unit and the mounting apparatus over time, against earthquakes, unexpected vibrations, and other external forces.
- Be sure the unit is mounted to a solid structure within the ceiling, such as a support beam. Secure the monitor using bolts, spring lock washers, washer and nut.
- DO NOT mount to areas that have no supporting internal structure. DO NOT use wood screws or anchor screws for mounting. DO NOT mount the unit to trim or to hanging fixtures.

Maintenance

- Periodically check for loose screws, gaps, distortions, or other problems that may occur with the mounting apparatus. If a problem is detected, please refer to qualified personnel for service.
- Regularly check the mounting location for signs of damage or weakness that may occur over time.

Please note the following when mounting on wall or ceiling.

- When using mounting accessories other than those that are NEC approved, they must comply with the VESA-compatible (FDMLv1) mounting method.
- NEC strongly recommends using size M8 screws (16mm + thickness of bracket in length). If using screws longer than 16mm, check the depth of the hole. (Recommended Fasten Force: 1125 - 1375N•cm) NEC recommends mounting interfaces that comply with UL1678 standard in North America.

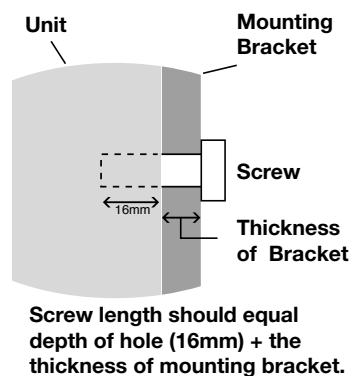

Orientation

When using the display in the portrait position, the monitor should be rotated clockwise so that the left side is moved to the top and the LED indicator light is on the bottom. This will allow for proper ventilation and will extend the lifetime of the monitor. Improper ventilation may shorten the lifetime of the monitor.

When using the display in the portrait position, please turn the Cooling Fan "ON" in the OPTION2 OSD menu.

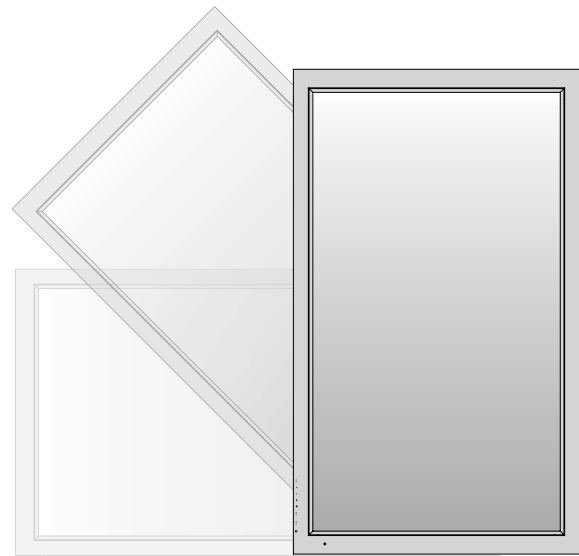

Cable Management

To conveniently manage cables, use the cable clamps provided to bundle the power cord together with the signal and audio cables at the back of the display.

To attach cable clamps:

1. Attach the cable clamps to the display. Insert the anchor of the clamp into the hole on the back of the display. There are 4 cable clamps and 4 clamp holes on the unit.
2. After the cable clamp is positioned on the display, wrap the end around the cables. Place the end of the clamp into the slot near the anchor. Pull until cables are snug.

Clamps are designed to stay in place. Once in position, they will be difficult to remove.

3. Cables can be routed to the right or left of the clamp. Use the beaded bands to secure the cables together along their length. Make sure the cables are fully supported.

To detach clamps:

Using pliers, twist the clamp 90 degrees and pull outward. It is possible that the clamp can weaken over time and removing it may cause damage to the clamp.

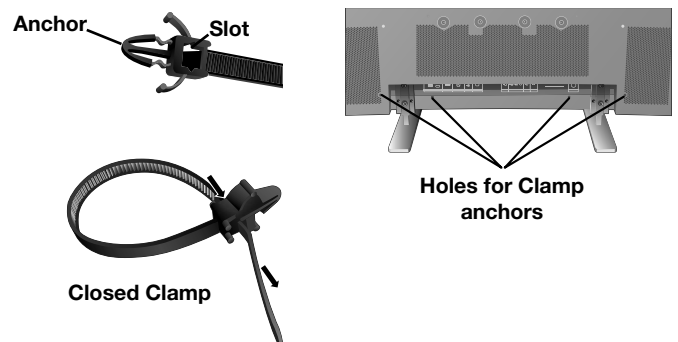

Using the Remote:

Install the remote control batteries.

The remote control is powered by AA batteries. To install or replace batteries:

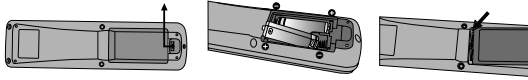

- A. Press and slide to open the cover.
- B. Align the batteries according to the (+) and (-) indications inside the case.
- C. Replace the cover.

CAUTION: Incorrect usage of batteries can result in leaks or bursting. NEC recommends the following battery use:

- Place “AA” size batteries matching the (+) and (-) signs on each battery to the (+) and (-) signs of the battery compartment.
- Do not mix battery brands.
- Do not combine new and old batteries, or mix brands. This can shorten battery life or cause liquid leakage of batteries.
- Remove dead batteries immediately to prevent battery acid from leaking into the battery compartment.
- Do not touch exposed battery acid, it may injure skin.
- Do not drop or mishandle the remote.
- Do not get the remote control wet. If the remote does get wet, wipe dry immediately.
- Avoid excessive heat and humidity.
- Do not dispose of batteries in fire.
- Please follow government regulations or public environmental rules that apply in your country/area when disposing of used batteries.
- When replacing, use only conventional non-rechargeable alkaline or manganese batteries.
- There is a risk of explosion if batteries are replaced incorrectly.

Operating Range for the Remote Control

Point the top of the remote control toward the monitor's remote sensor while pressing buttons. The remote control can be used from the front of the monitor at a maximum distance of 7 m/23 ft. from the front of the Plasma monitor's remote control sensor. The maximum horizontal and vertical angle for use of the remote is 30 degree within a distance of 3.5 m/11.5 ft.

CAUTION

The remote control may not function when direct sunlight or strong illumination strikes the remote control sensor of the Plasma monitor, or when there is an object in the path of the sensor.

Handling the Remote Control

Do not open the remote control other than to install batteries. Do not allow water or other liquid to splash onto the remote control. If the remote control gets wet, wipe it dry immediately.

Avoid exposure to heat and steam.

NOTE: If you do not intend to use the Remote Control for a long period of time, remove the batteries.

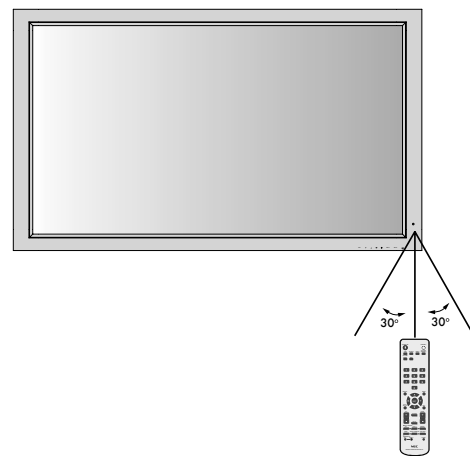

Part Names and Functions

Control Panel

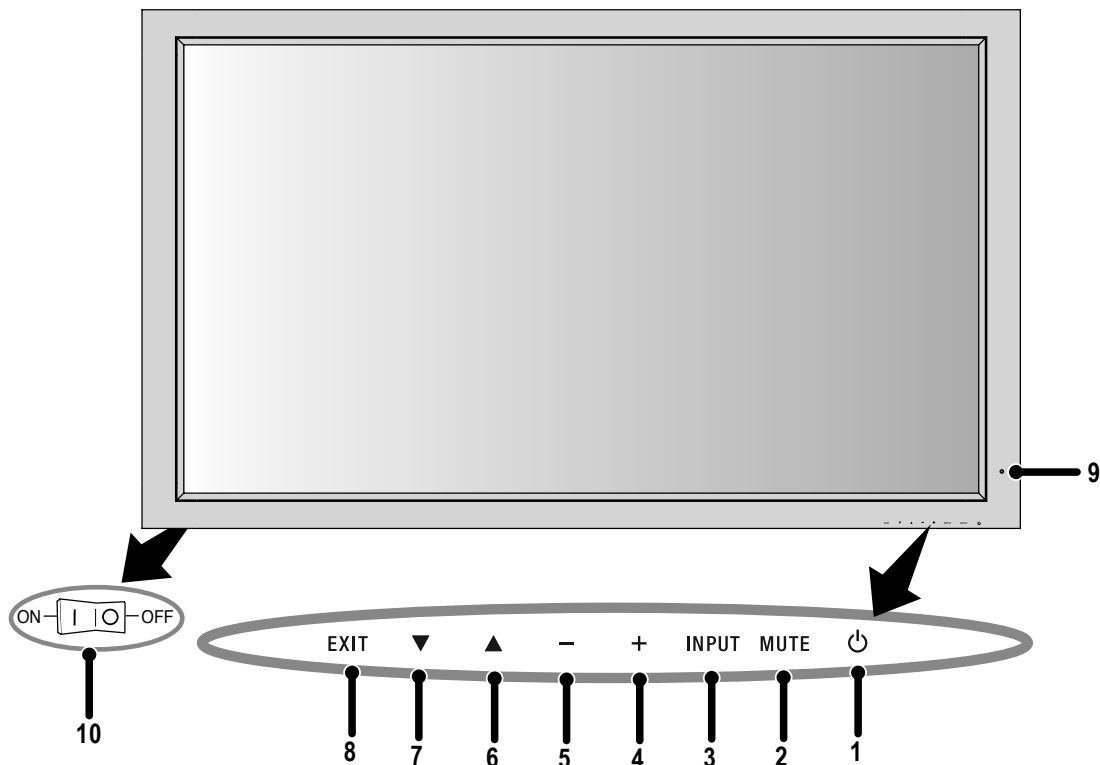

- 1) **POWER**
Switches the power on/standby.
- 2) **MUTE**
Switches the audio mute ON/OFF.
- 3) **INPUT**
Switches between input sources.
Acts as SET button within the OSD menu.
- 4) **PLUS (+)**
Increases the setting adjustment within OSD menu.
- 5) **MINUS (-)**
Decreases the setting adjustment within OSD menu.
- 6) **UP (▲)**
Increases the volume level when the OSD is off.
Moves area up to select which setting to be adjusted within OSD menu.
- 7) **DOWN (▼)**
Decreases the volume level when the OSD is off.
Moves down to select which setting to be adjusted within OSD menu.
- 8) **EXIT**
Activates the OSD menu when the OSD menu is off.
Exits from the current menu being displayed to the previous menu within the OSD.
- 9) **Remote control sensor and Power indicator**
Receives the signal when using the wireless remote control.
Glows green when the monitor is active. Glows red when the monitor is in Standby mode. Glows Amber when the monitor is in POWER SAVE mode.

A red blinking Power indicator means that the monitor has detected a failure. Contact qualified personnel in case of failure.
- 10) **Main Power Switch**
Seesaw switch to turn the main power on/off.

Mode	Status indicator light
Power On	Green
Standby	Red
Power save	Amber
Diagnosis (Detecting failure)	Red blinking

NOTE:
The **POWER** button does not completely turn off the display. Use the **Main Power Switch** to completely turn off the display.

Part Names and Functions

Terminal Panel

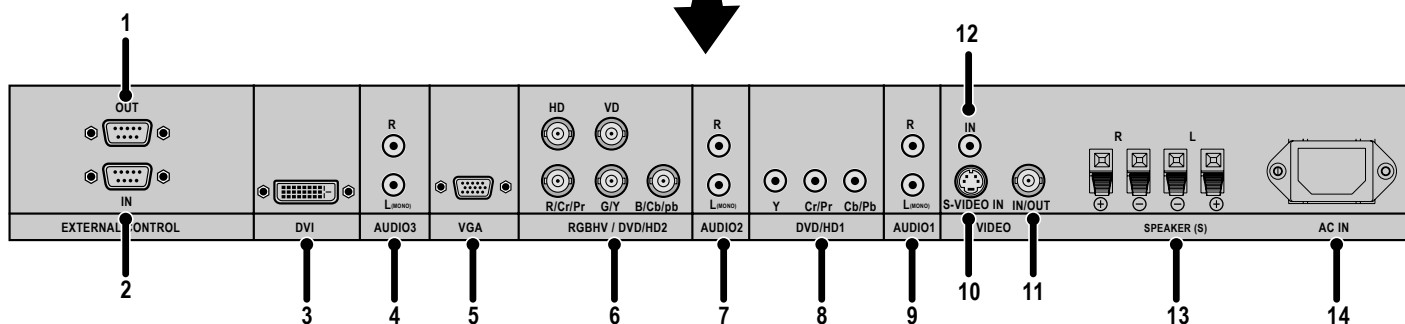
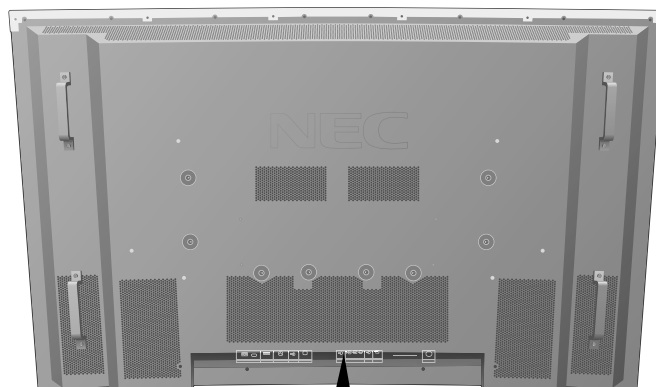

- 1) **EXTERNAL CONTROL OUT (D-Sub 9 pin)**
Connect RS-232C output to a second monitor.
- 2) **EXTERNAL CONTROL (D-Sub 9 pin)**
Connect RS-232C input to external equipment such as a PC in order to control RS-232C functions.
- 3) **DVI**
Input digital RGB signals from a computer or HDTV device having a digital RGB output.
- 4) **AUDIO3**
Input the audio signal from external equipment such as a computer, VCR or DVD player.
- 5) **VGA (Mini D-Sub 15 pin)**
Analog computer input or output.
For proper operation select "D-SUB INPUT" in the OPTION1 OSD menu.
- 6) **RGBHV/DVD/HD2**
RGBHV: Input RGB signals from RGB equipment.
A Sync-on-Green signal can be connected using the G connector.

DVD/HD2: Connect equipment such as a DVD player, HDTV device, or set-top box.
This input can be used with an RGB or component source.
For proper operation select "BNC INPUT" in the OPTION1 OSD menu.
- 7) **AUDIO2**
Input the audio signal from external equipment such as a computer, VCR or DVD player.
- 8) **DVD/HD1**
Connect equipment such as a DVD player, HDTV device, or set-top box.
- 9) **AUDIO1**
Input the audio signal from external equipment such as a computer, VCR or DVD player.
- 10) **S-VIDEO in**
Input S-video.
- 11) **VIDEO1**
Composite video input or output.
- 12) **VIDEO2**
Composite video input.
- 13) **EXTERNAL SPEAKER (L and R) connector**
Connects to optional speakers. Output the audio signal from AUDIO 1, 2, and 3 to external speakers.
NOTE: Speaker Terminal is for 8W + 8W (8 ohm).
- 14) **AC IN**
Connects with the supplied power cord.

Information:

For Y/Cb/Cr connections, use the DVD/HD1 or DVD/HD2 terminals.

For SCART connections there are 3 ways to connect:

SCART1: Connect R/G/B to the DVD/HD2 terminals and composite sync. to the HD terminal.

SCART2: Connect R/G/B to the DVD/HD2 terminals and composite sync. to the VIDEO1 terminal.

SCART3: Connect R/G/B + composite sync. to the VGA terminal.

Part Names and Functions - continued

Remote Control Functions

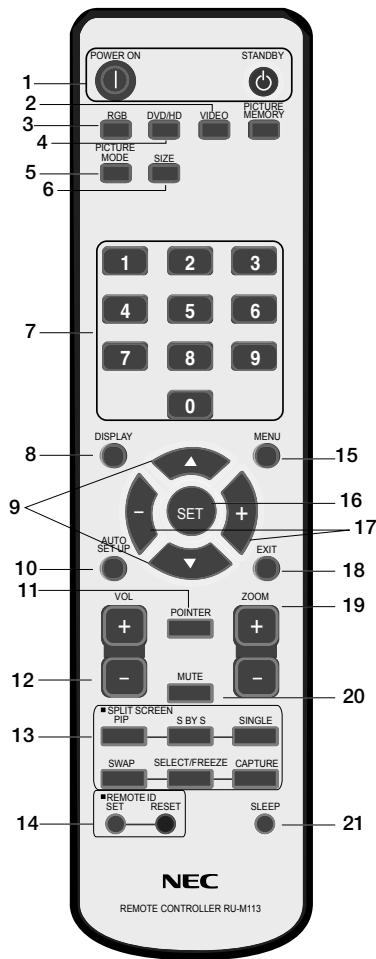

1) POWER ON/STANDBY

Switches the power on/standby.
*If the Power Indicator on the display is not glowing, then no controls will work.

2) VIDEO

Switches the input signal to the VIDEO source.

3) RGB

Switches the input signal to the RGB source.

4) DVD/HD

Switches the input signal to the DVD/HD source.

5) PICTURE MODE

Selects Picture Mode: [STANDARD], [BRIGHT], [CINEMA1], [CINEMA2], [DEFAULT].

STANDARD: for viewing in a bright room

BRIGHT: brighter picture than STANDARD

CINEMA1, 2: for viewing in a dark room, good for movies

DEFAULT: factory default settings

6) SIZE

Set the aspect ratio of the image.

7) KEYPAD

Set REMOTE ID.

8) DISPLAY

Turn on/off the Information OSD.

9) ▲ ▼

Move selection up or down

10) AUTO SETUP

Adjusts the CLOCK PHASE, CLOCK, and POSITION settings automatically. (Analog RGB signal input only)

11) POINTER

Turn on/off the pointer.

12) VOLUME

Increases/Decreases sound level.

13) SPLIT SCREEN

PIP: Picture-in-Picture mode.

S BY S: Side-by-side mode.

SINGLE: Returns to normal mode.

SWAP: Swaps the Split Screen images.

When the QUICK SWAP function (see OSD OPTION4) is ON, SWAP can be used to change signal input. (Single screen mode)

SELECT/FREEZE: Selects which input is active when in split screen mode.

When the PIC FREEZE function (see OSD Option4) is operating, SELECT/FREEZE can be used to display still pictures on the sub screen.

CAPTURE : Captures still picture.

14) REMOTE ID

Activates REMOTE ID function.

15) MENU

Turns ON/OFF menu mode.

16) SET

Makes selection.

17) -, +

Increases or decreases amount of adjustment.

18) EXIT

Goes to the previous menu.

19) ZOOM

Enlarges or reduces the picture.

20) MUTE

Mutes audio output.

21) SLEEP

Sleep timer.

NOTE: Any buttons without a corresponding explanation will not work with the Plasmasync display.

POWER

To turn the unit ON and OFF:

1. Plug the power cord into an AC outlet.
2. Press the Power button (on the unit).

The monitor's ON/STANDBY indicator turns red and the unit will be in STANDBY mode.

3. Press the POWER ON button on the remote control. The ON/STANDBY indicator will turn green when the unit is active.
4. Press the STANDBY button (on the remote) or the Power button (on the unit) to turn off the monitor.

DISPLAY

To check display settings press the DISPLAY button on the remote. The screen changes each time the DISPLAY button is pressed. Display information will disappear after 3 seconds.

DIGITAL ZOOM

Digital zoom can change the picture position or enlarge the image on the screen.

1. Be sure ZOOM NAV function is off. Press the ZOOM button (+ or -) to display the magnifying glass.

Press the ZOOM + button to enlarge the image.

Press the ZOOM - button to reduce the image.

Press the UP and DOWN or PLUS and MINUS buttons to reposition the picture.

2. Press the POINTER button to hide the pointer.

POINTER

Use the Pointer to point to a specific area on the screen.

Press the UP and DOWN or PLUS and MINUS buttons to reposition the Pointer.

Main Power Switch Cover

Included with the display is a cover for the Main Power Switch. Use this cover to prevent the unit from being inadvertently powered off.

Place the tab on the cable cover into the rectangular slot on the display.

Then using the screw provided, secure the cover to the display.

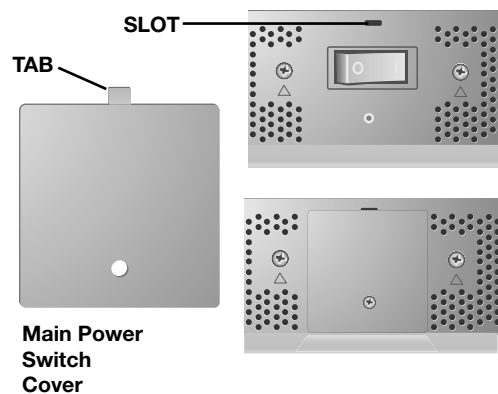
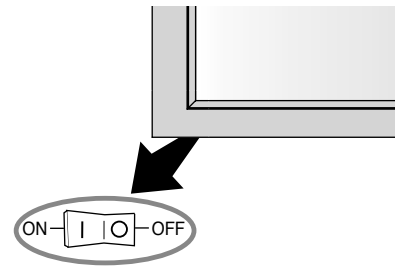

Part Names and Functions - *continued*

REMOTE CONTROL ID

The remote control included with the display can be used to control up to 26 individual monitors using what is called the REMOTE CONTROL ID mode. The REMOTE CONTROL ID mode works in conjunction with the Monitor ID, allowing control of up to 26 individual monitors. For example: if there are many monitors being used in the same area, a remote control in normal mode would send signals to every monitor at the same time Figure 1. Using the remote in REMOTE CONTROL ID mode will only operate one specific monitor within the group Figure 2.

TO SET REMOTE CONTROL ID:

While holding down the REMOTE ID SET button on the remote control, use the KEYPAD to input the Monitor ID (1-26) of the display to be controlled via remote. The remote can then be used to operate the monitor having that specific Monitor ID number.

When 0 is selected or when the remote control is in normal mode, all monitors will be operated.

TO USE REMOTE CONTROL ID MODE

ID Mode - To enter ID Mode press the REMOTE ID SET button and hold down for 2 seconds.

Normal Mode - To return to Normal Mode press the REMOTE ID RESET button and hold down for 2 seconds.

In order for this feature to work properly, the display must be assigned a Monitor ID number. The Monitor ID number can be assigned under the OPTION3 menu in the OSD (See page 17).

If monitor ID is set to "ALL", monitor is controlled by remote control not depend on remote ID.

Remote Control ID Function

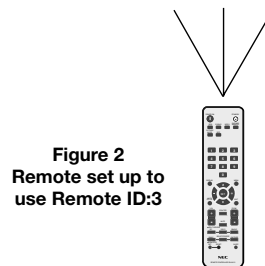
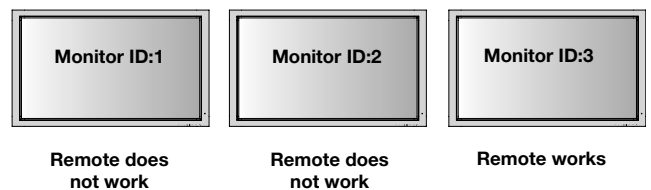
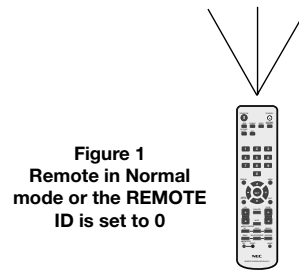
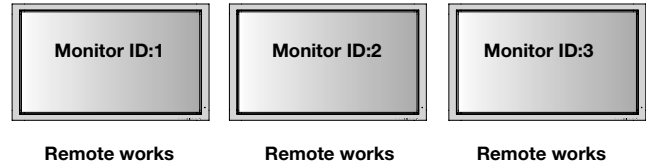

On-Screen Display (OSD)

Using the OSD

Use the Remote Control or the control panel on the front of the unit to enter the on-screen display menu to adjust settings.

1. Press the MENU button on the remote or the EXIT button on the Control Panel.
2. Use the up and down buttons to select the desired menu.
3. Press the SET button to select a sub-menu or item for adjustment.

4. Change the setting or adjustment by pressing the + and - buttons on the Control Panel or the Remote Control.
5. Press the EXIT button on the Remote Control, on the Control Panel to return to the previous menu.

NOTE: Not all menu functions may be available. To access all functions the Advanced OSD option must be turned on in the ADVANCED OSD menu.

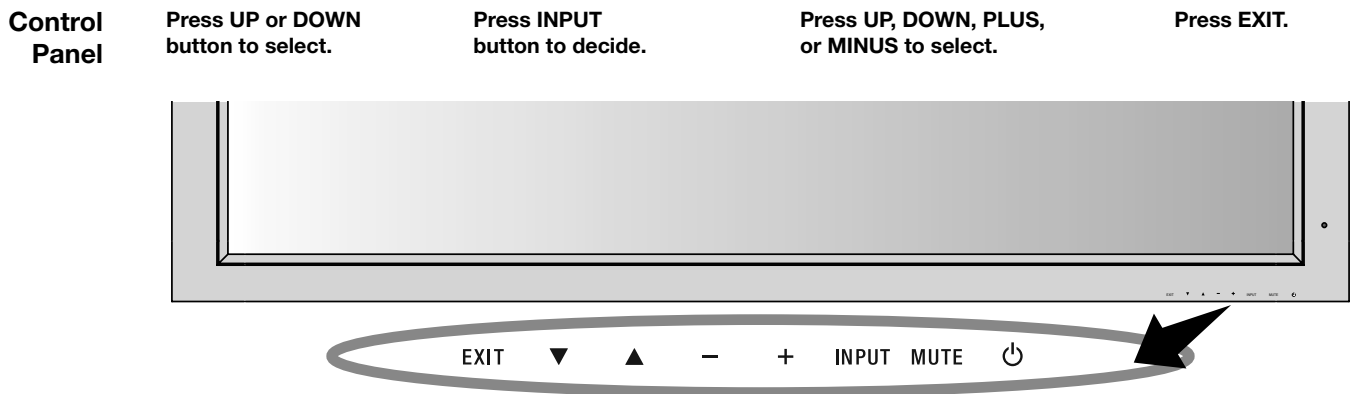
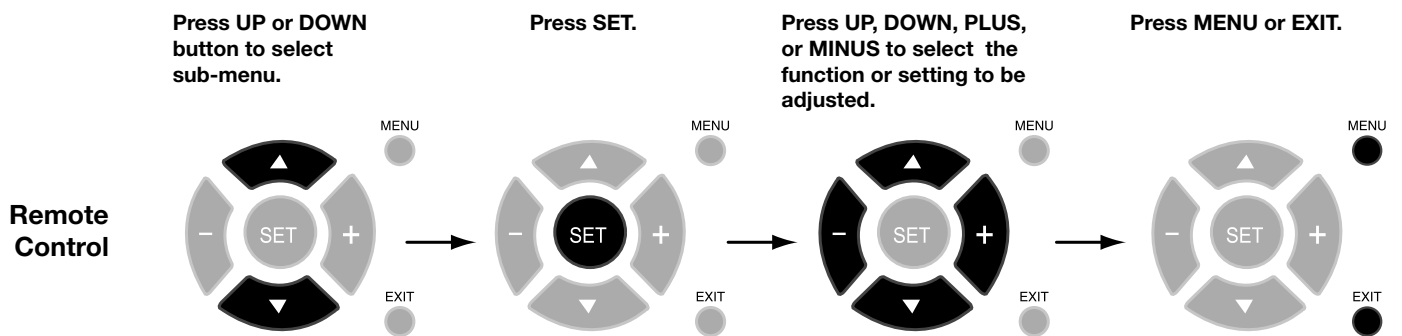

OSD Screen

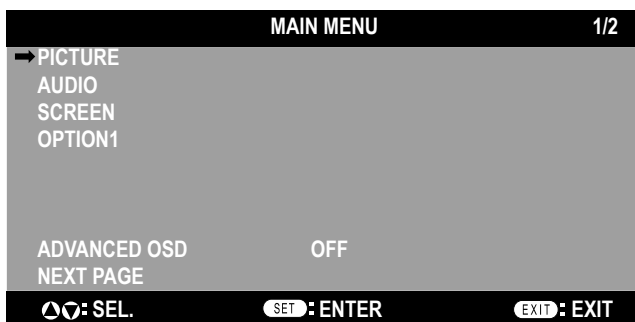

ADVANCED OSD is OFF. Not all OSD functions will be available when the ADVANCED OSD is off.

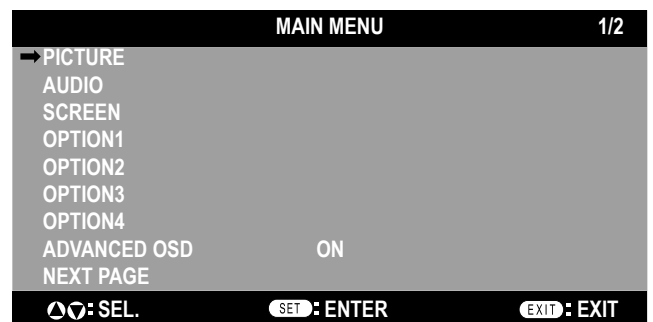

Advanced OSD is ON. All OSD functions are shown, but some OSD functions may not be available.

On-Screen Display (OSD)

Main Menu	Sub Menu	Sub Menu2	Sub Menu3	Explanation	Default	Reset
PICTURE	CONTRAST			Adjusts the image brightness in relationship to the white level. Press + or - to adjust.	50	YES
	BRIGHTNESS			Adjusts the image brightness in relationship to the background. Press + or - to adjust.	50	YES
	SHARPNESS			Adjusts the crispness of the image. Press + or - to adjust.	50	YES
	COLOR			Adjusts the color depth of the screen. Press + or - to adjust.	50	YES
	TINT			Adjusts the tint of the screen. Press + or - to adjust.	50	YES
	PICTURE MODE			Selects picture mode, [BRIGHT], [STANDARD], [CINEMA1], [CINEMA2], [DEFAULT]. STANDARD: For watching in a bright room. CINEMA1, 2: For watching in a dark room, especially good for movies. BRIGHT: Brighter picture than STANDARD. DEFAULT: Restores factory default settings.	STANDARD	YES
	NR			Adjusts the amount of noise reduction. Press + or - to adjust.	OFF	YES
	COLOR TEMP.			Adjusts the color temperature of the entire screen. A low color temperature will make the screen reddish. A high color temperature will make the screen bluish.	MID	YES
	WHITE BALANCE <i>Available only when the Advanced OSD function is enabled.</i>	GAIN RED		The "WHITE BALANCE" appears when the SET button is pressed on the "COLOR TEMP." OSD menu. GAIN RED/GREEN/BLUE: Adjusts the white level of the white balance.	50	YES
		GAIN GREEN			50	YES
		GAIN BLUE			50	YES
		RESET			OFF	YES
	GAMMA <i>Available only when the Advanced OSD function is enabled.</i>			Select a display gamma for best picture quality. 2.1, 2.2, 2.3, 2.4: The picture becomes darker as the number increases. S: Special gamma for certain types of movies. Raises the dark parts and lowers the light parts of the image. (S-Curve) These values are approximate.	2.2	YES
	COLOR CONTROL <i>Available only when the Advanced OSD function is enabled.</i>	RED		Adjusts the levels of the Red, Green, Blue, Yellow, Magenta and Cyan. VIDEO and DVD/HD input only.	50	YES
		GREEN			50	YES
		BLUE			50	YES
		YELLOW			50	YES
MAGENTA			50		YES	
CYAN			50		YES	
RESET			Resets the factory default settings. Select "ON", then press the SET button to reset.	OFF	YES	
AUDIO	BASS			Adjusts the low frequency sound. Press + or - to adjust.	0	YES
	TREBLE			Adjusts the high frequency sound. Press + or - to adjust.	0	YES
	BALANCE			Adjusts the balance of L/R volume. Press + or - to adjust.	0	YES
	AUDIO INPUT1			Select which audio input to use with the video source.	VIDEO1	YES
	AUDIO INPUT2				DVD/HD1	YES
	AUDIO INPUT3				VGA	YES

On-Screen Display (OSD)

Main Menu	Sub Menu	Sub Menu2	Sub Menu3	Explanation	Default	Reset
SCREEN	ASPECT MODE			Selects aspect ratio of the displayed image. Press + or - to select.		
	V-POSITION			Controls the vertical position of the image within the Display area of the PDP. Press + to move up. Press - to move down.	0	YES
	H-POSITION			Controls the horizontal position of the image within the Display area of the PDP. Press + to move right. Press - to move left.	0	YES
	V-HEIGHT			Adjusts the vertical size of the image.	0	YES
	H-WIDTH			Adjusts the horizontal size of the image.	0	YES
	AUTO PICTURE			ON: H-Position, V-Position, Clock and Clock Phase are adjusted automatically. OFF: H-Position, V-Position, Clock and Clock Phase are adjusted manually. <i>VGA and RGBHV input only.</i>	OFF	NO
	CLOCK PHASE			Adjusts the visual "noise" on the image. <i>VGA and RGBHV input only.</i>	0	YES
	CLOCK			Press + to expand the width of the image on the right of the screen. Press - to narrow the width of the image on the left. <i>VGA and RGBHV input only.</i>	0	YES
	UNDER SCAN <i>Available only when the Advanced OSD function is enabled.</i>			ON: UNDERSCAN is selectable in the ASPECT MODE menu. OFF: UNDERSCAN item is not selectable in the ASPECT MODE menu. <i>Video signal input only.</i>	OFF	YES
OPTION1	OSD	DISPLAY OSD		ON: Information about inputs, screen size, etc. is shown. OFF: No information is shown.	ON	YES
		OSD POSITION		Change the position of the menu between 1 and 6. Press + or - to adjust.	1	YES
		OSD ORBITER		ON: The menu position intermittently shifts eight dots while the OSD is being displayed. OFF: The menu position does not shift.	OFF	YES
		OSD TRANSP.		Adjusts the transparency level of the OSD. Press + or - to adjust.	70%	YES
	BNC INPUT			Selects the input type when using 5BNC connectors. RGB: For RGB input. COMP.: For Component input (3BNC connectors). SCART1: For SCART input (4BNC connectors). SCART2: For SCART input (3BNC connectors and VIDEO1 input). <i>SCART1, SCART2 available for Europe and World-Wide models only.</i>	RGB	YES
	D-SUB INPUT			Selects the input type when using a mini D-SUB connector. RGB: For RGB input. SCART3: for SCART input. <i>SCART3 available for Europe and World-Wide models only.</i>	RGB	YES
	RGB SELECT			If there is a problem with signal detection, this function forces the monitor to display the signal at the desired resolution. If no problem is detected, the only available option will be "AUTO". <i>VGA and RGBHV input only.</i>	AUTO	YES
	HD SELECT			Manually selects signal output when similar 1080I signal are detected. 1080B: Standard digital broadcasts. 1080A: Special digital broadcasts (ex. DTC100).	1080B	NO
	INPUT SKIP			Skips to next input if present input signal is not detected. <i>This function is valid only for INPUT key on the display.</i>	OFF	YES
	ALL RESET			Resets settings back to factory default values.	OFF	

On-Screen Display (OSD)

Main Menu	Sub Menu	Sub Menu2	Sub Menu3	Explanation	Default	Reset	
OPTION2 <i>Available only when the Advanced OSD function is enabled.</i>	POWER SAVE			Sets how long the monitor waits before going into power save mode after a signal is lost. <i>VGA, RGBHV, and DVI input and Separate HV Sync. only.</i>	OFF	YES	
	FILM MODE			Selects Film mode.	ON	YES	
	SCREEN SAVER				Use SCREEN SAVER functions to reduce the risk of image retention.		
		PLE			PLE: The brightness is decreased in order of Lock mode. (the higher number is darker)	AUTO	YES
		ORBITER			ORBITER: The screen image moves and is slightly squeezed or expanded.	AUTO1	YES
		INVERSE	WORKING TIME /WAITING TIME		INVERSE: The screen image is displayed alternately between positive image and negative image, or the screen image is displayed full white.	OFF	YES
	COOLING FAN			Cooling fan reduces the temperature of the display.	AUTO	NO	
	SIDE MASK			Adjusts the color of the side mask when a 4:3 image is displayed. Press + button, the bar will become lighter. Press - button, the bar will become darker.	3	YES	
	PICTURE SIZE			When it is set to "OFF", TRUE of picture size appears only RGB signals.	ON	YES	
	DVI MODE	PLUG/PLAY			Choose the DVI mode based on the input device connected via DVI connector and set the black level. When a PC or similar equipment is connected, the PLUG/PLAY setting should be "DVI-PC" and the BLACK LEVEL setting should be "LOW". When a DVD player or similar equipment is connected, PLUG/PLAY setting should be "DVI-HD" and the BLACK LEVEL setting should be "HIGH".	DVI-PC	NO
		BLACK LEVEL				LOW	NO
	PROTOCOL SET				Sets protocol setting for use with RS-232C connection. OFF: When NEC protocol is used (normal). ON: When special protocol is used. <i>Consult dealer for details of protocol.</i>	OFF	YES
	CLOSED CAPTION <i>U.S. models only</i>				Choose the closed caption setting.	OFF	YES
	CAPTION CONT <i>U.S. models only</i>				Chooses the brightness of the closed captions.	NORMAL	YES
OPTION3 <i>Available only when the Advanced OSD function is enabled.</i>	TIMER	PRESENT TIME	DAYLIGHT SAVING TIME	Sets the date, time, and daylight saving region. Day & time must be set in order for the "TIMER" function to operate.	OFF	NO	
			DAY/HOUR/ MINUTE			NO	
		TIMER			Creates a working schedule for the monitor to use. See page 24 for instructions.	OFF	YES
	INPUT DETECT	INPUT			Sets the input mode and the sound volume when the power is turned on. LAST: Uses the input that was last selected when the power was turned off. MULTI to DVI: Fixed input mode. AUTO: Automatically searches for the input signal. PRIORITY: Sets which input has priority when using the AUTO setting.	LAST	YES
		VOLUME				LAST	YES
	CONTROL LOCK				This function completely locks out access to all Control Key functions. When this item is set to "ON", the front panel is disabled as soon as the on-screen menu goes off.	OFF	YES
	IR REMOTE				When "OFF", prevents the monitor from being controlled by wireless remote controller. The remote becomes ineffective disabled as soon as the on-screen menu goes off. To return to normal operation, press the "DISPLAY" button on the remote controller for 5 seconds.	ON	YES
	LOOP OUT				Change the loop out setting.	OFF	YES
	MONITOR ID				Sets the Monitor ID to a number from 1-26 and or to ALL.	ALL	YES
	RS232C CONTROL				Selects the mode of the monitor when using the RS-232C daisy chain.	NORMAL	YES

On-Screen Display (OSD)

Main Menu	Sub Menu	Sub Menu2	Sub Menu3	Explanation	Default	Reset			
OPTION3 <i>(continued)</i>	VIDEO WALL			Sets the configuration of video wall.					
		DIVIDER		Sets the video wall.	OFF	YES			
		POSITION		Sets the position of each display.					
		DISP. MODE		Sets the mode of seam processing for each display.	SPLIT	YES			
		SCREEN	ASPECT MODE	Adjusts detail position.					
				V-POSITION			0	YES	
				H-POSITION			0	YES	
				V-HEIGHT			0	YES	
				H-WIDTH			0	YES	
				AUTO PICTURE			OFF	YES	
				CLOCK PHASE			0	YES	
				CLOCK			0	YES	
				UNDER SCAN			OFF	YES	
P.ON DELAY			Adjusts the delay time between being in "standby" mode and entering "power on" mode.	OFF	YES				
OPTION4 <i>Available only when the Advanced OSD function is enabled.</i>	SUB PICTURE			Automatically detects if there is an input signal for the sub screen. This feature is available only picture-in-picture mode.					
		SUB P. DETECT		Automatically detects sub screen.	AUTO	YES			
		DISPLAY		Sets the appearance of the sub screen.	NORMAL	YES			
		SUB P. RATE		Sets the transparency of the sub screen.	100%	YES			
	ZOOM NAV			Sets the position of the zoom navigation image.	BTM LFT	YES			
	PIC FREEZE			Sets the position of the captured still picture.	S BY S1	YES			
	QUICK SWAP			Enables quick swapping of input.	OFF	YES			
		SELECT1		Sets which input terminals are used.	VIDEO1	YES			
		SELECT2			VGA	YES			
	TEXT INSERT			Allows text insertion within main screen.	OFF	YES			
		INPUT		Sets the input of text image of the VGA, RGBHV, and DVI.	VGA	YES			
		SUB P. DETECT		Automatically detects sub screen.	AUTO	YES			
		DISPLAY		Sets the appearance of the sub screen.	NORMAL	YES			
		SUB P. RATE		Sets the transparency of the sub screen.	100%	YES			
	ADVANCED OSM			ON: All menu items are shown for advanced users. OFF: Some of the advanced menu items are not shown.	OFF	YES			
LANGUAGE			Select the language used by the OSD.	ENGLISH	NO				
COLOR SYSTEM			The Color System that is used depends on the video format of the input signal. <i>VIDEO input only.</i>	AUTO	NO				
SOURCE INFORMATION			Display information about the display: frequencies, polarities, etc.						

Operation

Picture Size Using Video Signals

Select one of seven picture sizes manually.

While viewing videos or digital video discs, perform the following actions:

1. Press the SIZE button on the remote control.
2. To switch the screen sizes, press the SIZE button again within 3 seconds. The available sizes are **NORMAL**, **FULL**, **DYNAMIC**, **ZOOM**, **2.35:1**, **14:9**, and **UNDERSCAN**.

If a 720p, 1080i, or 1080p signal is displayed, the available sizes are **FULL**, **2.35:1**, **DYNAMIC**, and **UNDERSCAN**.

If displaying an enhanced split-screen, the available sizes are **NORMAL** and **FULL**.

NORMAL (4:3)

Images with a 4:3 (Normal) aspect ratio are displayed.

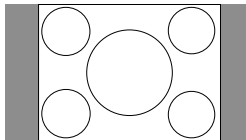

FULL

Horizontally expands anamorphic signals to display the correct linearity.

Normal (4:3) images are horizontally expanded to fill the entire screen.

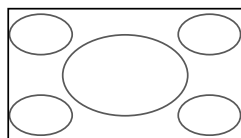

DYNAMIC

Vertically and horizontally expands the picture but at different aspect ratios.

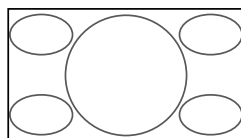

ZOOM

Vertically and horizontally expands the picture while maintaining the correct aspect ratio.

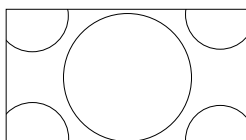

2.35:1

Image is expanded at a 2.35:1 ratio to fill the entire screen. The screen is filled vertically; however, some information will be lost on the left and right sides of the image.

Available for the following inputs:

Video, Component, or RGB input (480I, 480P, 576I, 576P, 720P, 1080I, 1080P)

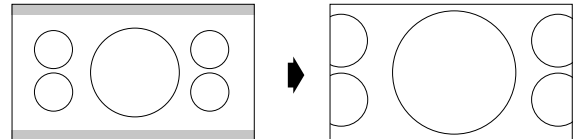

To avoid image retention, use the 2.35:1 image size if black bars are displayed at the top and bottom of the screen showing the displayed image.

14:9

Image is displayed at a 14:9 aspect ratio.

Available for the following inputs:

Video, Component, or RGB input (480I, 480P, 576I, 576P)

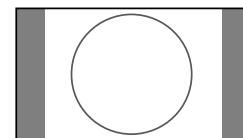

UNDERSCAN

Standard televisions crop (Underscan) images. Utilize the UNDERSCAN function in the SCREEN menu to display the entire image.

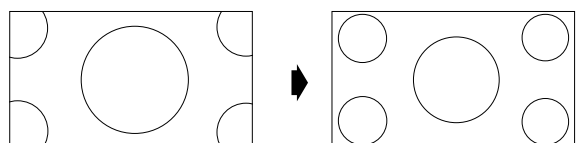

NOTE: Depending on the type of component used, black borders or signal noise may appear near the screen edges while in UNDERSCAN mode.

Over a period of time, image ghosting, shadowing, or burn-in may result from continuous display of underscanned images. While in UNDERSCAN mode, the brightness may change if a Macrovision signal is input.

NOTE: Do not display 4:3 content in NORMAL mode for extended periods of time to avoid image ghosting, shadowing, or burn-in.

Picture Size Using Computer Signals

To expand a 4:3 image to fill the entire screen, switch to the widescreen mode.

While viewing videos or digital video discs, perform the following actions:

1. Press the SIZE button on the remote control.
2. To switch the screen sizes, press the SIZE button again within 3 seconds. The available sizes are **NORMAL**, **FULL**, and **ZOOM**.

If an enhanced split-screen is displayed, the available sizes are **NORMAL** and **FULL**.

NORMAL (4:3 or SXGA 5:4)

Images are displayed normally.

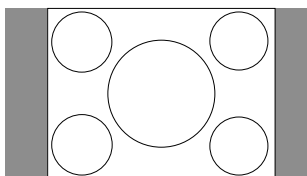

FULL

Horizontally expands anamorphic signals to display the correct linearity.

Normal (4:3) images are horizontally expanded to fill the entire screen.

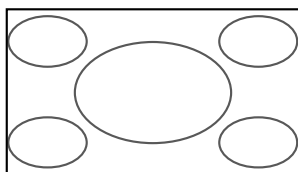

ZOOM

Vertically and horizontally expands the picture, while maintaining the correct aspect ratio.

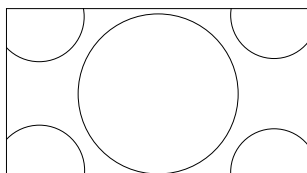

TRUE

The image is displayed at the native resolution.

When using a VGA or SVGA signal, PICTURE SIZE in the OPTION 2 OSD menu should be set to OFF to select TRUE mode.

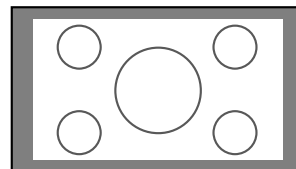

Information:

Supported resolutions: For further information on the display output of the various VESA signal standards supported by the unit, see pages 34 - 39.

When 1360 dot x 768 line wide XGA signals with a vertical frequency of 60 Hz and a horizontal frequency of 47.7 kHz are input:

1. Select an appropriate setting for the RGB SELECT mode.
2. Refer to the Resolutions Supported section of Model Information on pages 34 - 39.

NOTE: Do not display 4:3 content in NORMAL and TRUE mode for extended periods of time to avoid image shadowing, ghosting, or burn-in.

Operation - continued

Split Screen Mode

To display multiple pictures on the screen, perform the following actions:

1. Press the desired SPLIT SCREEN function button on the remote (PIP, S BY S, SINGLE).

Only certain RGB signals are supported.

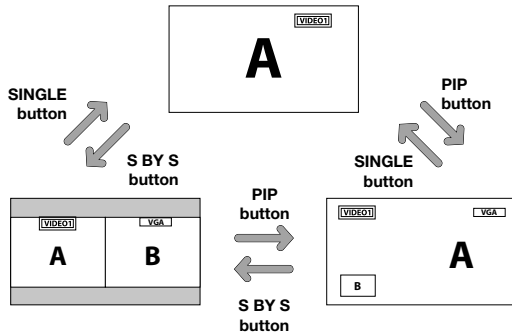

Split Screen mode works according to the table below.

Side by Side Mode

Press the -, +, ▲ or ▼ buttons to change the picture size.

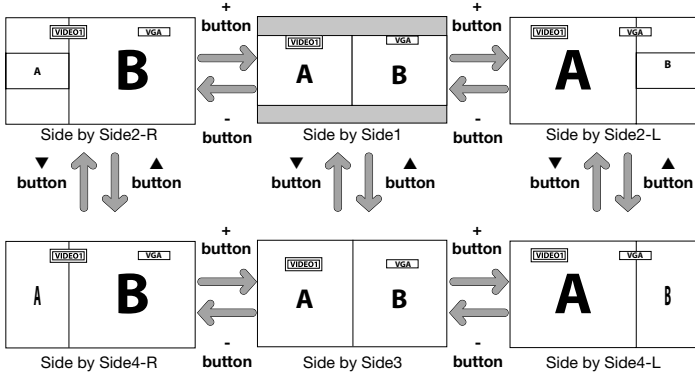

Press the SWAP button to swap pictures.

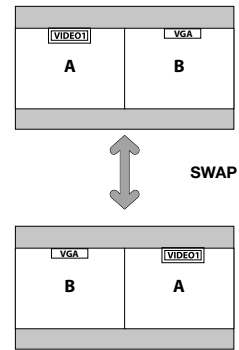

Press the SELECT/FREEZE button to change the active picture.

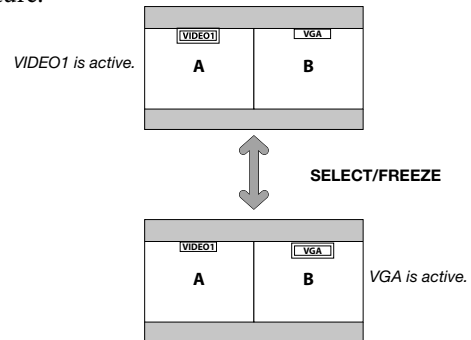

Picture displayed on the Left / Sub screen	Picture displayed on the Right / Main screen										
	VIDEO1	VIDEO2	S-VIDEO	DVD/HD1	DVD/HD2	SCART1	SCART2	SCART3	VGA	RGBHV	DVI
VIDEO1	—	YES	YES	YES	YES	—	—	—	YES	YES	YES
VIDEO2	YES	—	YES	YES	YES	—	—	—	YES	YES	YES
S-VIDEO	YES	YES	—	YES	YES	—	—	—	YES	YES	YES
DVD/HD1	YES	YES	YES	—	YES	—	—	—	YES	YES	YES
DVD/HD2	YES	YES	YES	YES	—	—	—	—	YES	—	YES
SCART1	—	—	—	—	—	—	—	—	—	—	YES
SCART2	—	—	—	—	—	—	—	—	—	—	YES
SCART3	—	—	—	—	—	—	—	—	—	—	YES
VGA	YES	YES	YES	YES	YES	—	—	—	—	—	YES
RGBHV	YES	YES	YES	YES	—	—	—	—	—	—	YES
DVI	YES	YES	YES	YES	YES	YES	YES	YES	YES	YES	—

Picture-in-Picture Mode

Press the + and - buttons to change the position of the sub-picture.

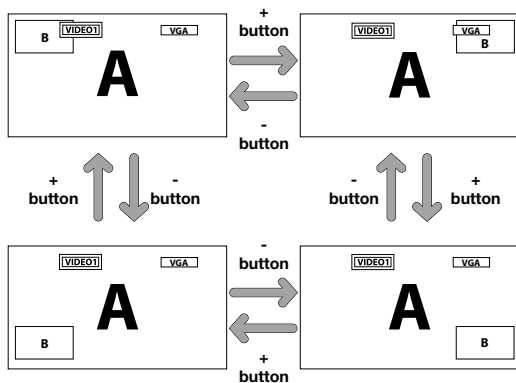

Press the ▲ and ▼ buttons to change the size of the sub-picture.

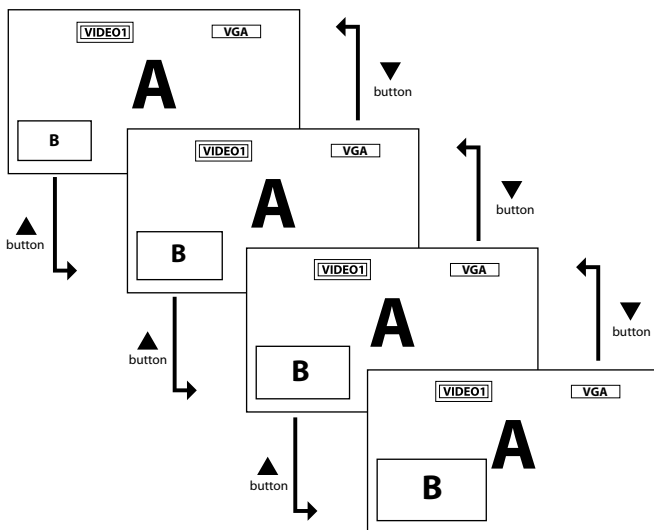

Press the SELECT/FREEZE button to change the active picture.

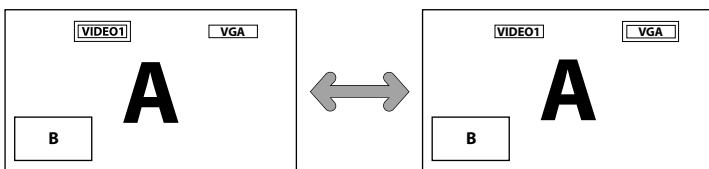

Displaying Input Signal

1. To make the desired picture active, press the SELECT/FREEZE button.
2. To change the active signal, press the VIDEO, DVD/HD, or RGB button.

The input selection may also be changed by pressing the INPUT button on the front of the unit.

Adjusting the OSD controls

1. To make the desired picture active, press the SELECT/FREEZE button.
2. To display the main menu, press the MENU button.
3. Adjust the settings as desired.

NOTE: Some OSD functions may not be available in Split-Screen mode.

Operation - continued

Creating a Video Wall

You can create a video wall consisting of up to 25 individual monitors with the built-in matrix display capability. Your Video Wall can have any of the following configurations: 2x2, 3x3, 4x4, 5x5, 5x1, 4x1, 3x1, 2x1, 1x2, 1x3, 1x4, or 1x5.

Connect the signal cables as shown:

1. Select VIDEO WALL in the OPTION 3 OSD menu, then press the SET button.
2. Select the desired video wall configuration in the DIVIDER field.
3. Select POSITION in the VIDEO WALL menu, then press the SET button. Appearing on the OSD is the current video wall configuration. Select the position of the monitor for the video wall.

NOTE: Each individual monitor within the video wall must have its own set position.

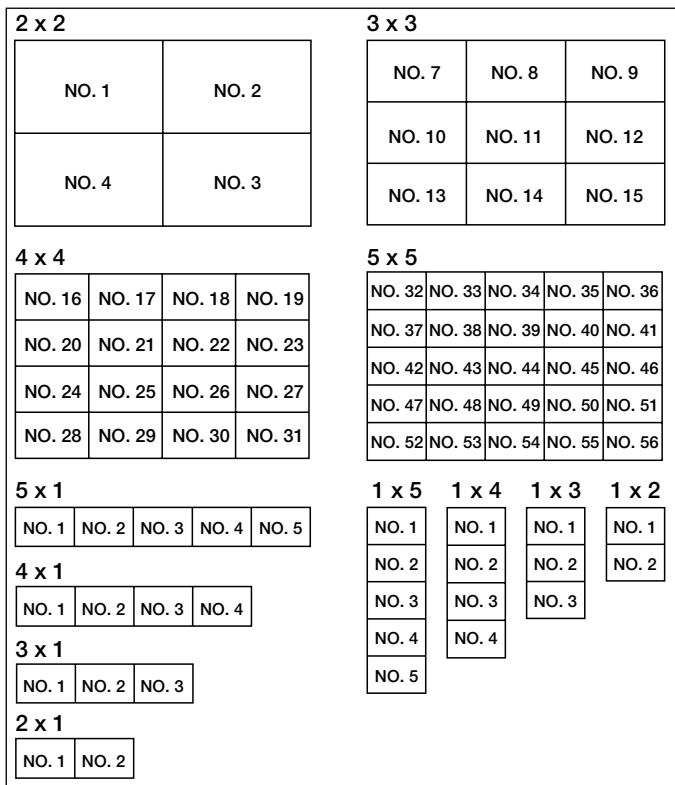

Video Wall Configurations

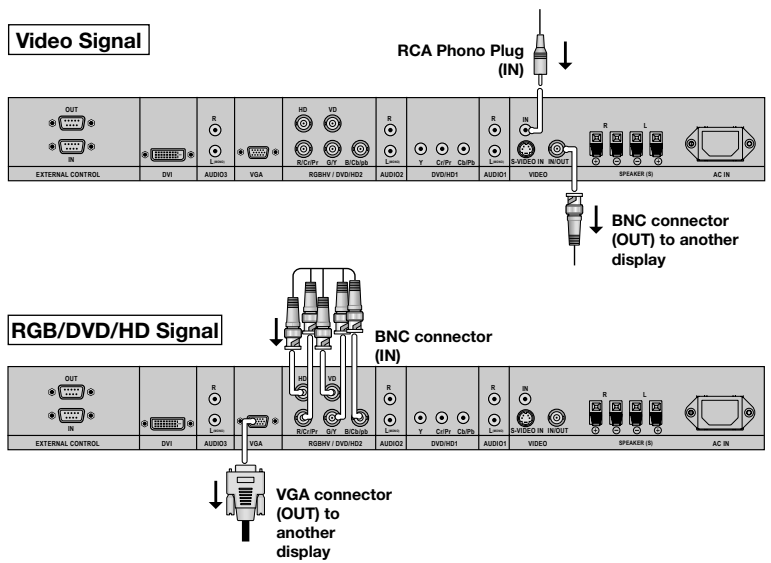

NOTE: 1. The VIDEO 1 and VGA terminals may be used either for INPUT or OUTPUT.

Do not connect an OUTPUT signal from another unit when LOOP OUT in the OPTION 3 OSD is set to ON, as it may damage the other unit due to an extraordinary load.

2. While signals are input to the VGA terminal, LOOP OUT should not be turned ON.

Information:

Set the LOOP OUT in OPTION3 to ON to loop signals out to another plasma display.

- Set the VIDEO WALL options properly when creating a video wall.
- Use the appropriate (length and efficiency) BNC cable to connect monitors.
- If the image quality is poor, do not use the monitor out terminal to link to another monitor. Use a commercially available distribution amplifier to connect the split signal to the appropriate monitor INPUT terminals.
- For a resolution of 1024x768 at 60 Hz (or lower), the maximum recommended size for a viewing wall is 4 displays.
- A distribution amplifier is highly recommended when setting up a 3 x 3 (or greater) video wall.
- When looping from plasma to plasma, an appropriate (length and efficiency) 15-pin male mini D-Sub - 5BNC conversion cable is required.

USING THE TIMER

Turn the "ADVANCED OSD" to "ON" in the MAIN MENU to access the TIMER feature in OPTION3.

To user the TIMER feature the first set the internal clock and the day of the week. The display can also be programmed to turn on or off at preset times, and which input the display will use at those times. The Program Timer which turns on or off the power at the day of the week, time and the input mode you want, or Repeat Timer which displays two input modes alternately can each be set also. In the "OPTION3" OSD menu, select "TIMER", then press the SET button. The "TIMER" screen appears.

PRESENT TIME

This sets the day of the week and present time. Example: Setting "WEDNESDAY", "22:05" In the "TIMER" menu, select "PRESENT TIME", then press the SET button.

The "PRESENT TIME" screen appears. Set the items.

Turn DAYLIGHT SAVING TIME on if daylight savings is observed.

Select the day of the week.

Set the clock using the 24-hour (HH/MM) format.

To accept PRESENT TIME settings, highlight "SET"* in the PRESENT TIME OSD menu, then press the SET button to store the settings.

* If you press the EXIT button instead of the SET button, Timer settings will not be accepted.

PROGRAM TIMER

The PROGRAM TIMER feature allows a series of scheduled operation times to be set. The display can be programmed to run on a particular day and time while using a desired input source. Under the Function setting (FUNC.) either a Screen Saver setting (ORBITER, INVERSE, WHITE) or a REPEAT TIMER program can be set for the monitor to use during the scheduled power-on time.

NOTE: When a REPEAT TIMER program is selected as the Function setting, the Program Timer's Input option is not available. The input used will use the input that is programmed for the Repeat Timer program.

Up to 10 individual PROGRAM TIMER schedules can be set. When schedules are set to perform functions at the same time, the schedule with the lower number has priority. For example schedule #1 has priority over schedule #10. When schedules overlap, each action is sequentially executed.

Using special characters in the PROGRAM TIMER setting.

Using an asterisk (*) alone in the DAY field means that the programmed schedule will run every day.

Using the asterisk (*) and the name of the day means the programmed schedule will run only on that day. For example "*FRI" means that the schedule will run every Friday.

A hyphen (-) in either the ON or OFF fields means that a time is not set. In order to use the Program Timer, at least either an ON or OFF time has to be set.

A hyphen (-) in the INPUT or that the monitor will use the previously used display mode for that particular schedule.

If a Repeat Timer sequence is selected in the FUNC. field, the Input field will show a hyphen (-).

Setting the PROGRAM TIMER using multiple inputs

Set the INPUT field to "MULTI", then press the SET button. The "MULTI SCREEN SETTING" will appear on the screen.

Use the ▲ and ▼ buttons to select "MULTI MODE", then use the + and - buttons to choose from "S BY S1, 2R, or 2L" and "PICTURE IN PICTURE MODE (BOTTOM LEFT~TOP LEFT)".

Use the ▲ and ▼ buttons to select "MAIN"/"SUB" and "LEFT"/"RIGHT", then use the + and - buttons to choose from "VIDEO1 to "DVI".

To set "REP.1~3" as the FUNC.

Set the FUNC. field to "REP.1", "REP.2" or "REP.3", then press the SET button. The "REPEAT TIMER" menu will appear on the screen.

Use the - and + buttons to choose from "SINGLE", "S BY S 1, 2R or 2L" and "PICTURE IN PICTURE MODE (BTM LFT to TOP LFT)", then adjust the items.

Operation - *continued*

REPEAT TIMER

The Repeat Timer allows the display to alternate between inputs at user-determined intervals.

For example the display can be programmed to show the signal from "VIDEO1" for 10 minutes and then switch to showing the signal from the DVI input for 10 minutes.

To set the Repeat Timer select "REPEAT" in the Timer menu, then press the SET button. To enter the REPEAT TIMER OSD screen. Then make the desired settings.

STATE Settings

There are 4 possible state settings to use. When all four STATES are set to "ON, the repeat timer schedules will operate consecutively (State1, State2, State3, State4, State1, State2, State3...).

When a STATE setting is set to OFF, i.e. STATE1-ON, STATE2-ON, STATE3-OFF, STATE4-ON, the repeat timer schedules use all but STATE3 (State1, State2, State4, State1, State2...).

Repeat Timer activates when the OSD menu is exited.

For SINGLE display configurations

WORK TIME: Set the time duration of the schedule. Time range is from 1 minute to 24 hours.

INPUT MODE: Choose the signal that will be used.

MULTI settings

MODE: Select the input mode to be displayed as "SINGLE", "S BY S 1, 2R or 2L" or "PICTURE IN PICTURE MODE (BTM LFT~TOP LFT)".

WORK TIME: Set the time duration of the schedule. Time range is from 1 minute to 24 hours.

INPUT MODE: Choose the signal that will be used.

Select "MAIN" or "SUB" for "PICTURE IN PICTURE MODE (BTM LFT~TOP LFT)" and "LEFT" or "RIGHT" for "S BY S1, 2R or 2L".

Only one signal is selected for "SINGLE".

This Plasma monitor can be controlled via personal computer using an RS-232C connection.

MONITOR ID and RS-232C CONTROL

Up to 26 individual monitors can be controlled through a daisy chain via RS-232C connection.

1. Connect PC to the monitor.

Connect a PC's RS-232C control output to the monitor's RS-232C input. You can then connect the RS-232C output from this monitor to another monitor's RS-232C input. Up to 26 monitors can be connected using RS-232C.

2. Set Monitor ID and RS-232C Control mode.

For proper operation, the Monitor ID should be set in the OSD menu of each monitor that is in the chain. The Monitor ID can be set under the "OPTION3" menu in the OSD. The Monitor ID number can be set within a range from 1 to 26 or set to "ALL". No two monitors should share the same Monitor ID number. It is recommended to number each monitor in a daisy chain sequentially from 1. The first monitor in the daisy chain is designated as the primary monitor. Subsequent monitors with the chain are secondary monitors.

In the "OPTION3" menu on the first monitor in the RS-232C daisy chain set the "RS232C CONTROL" to "NORMAL". Set the "RS232C CONTROL" to "2ND" on all other monitors.

Functions that can be controlled via RS-232C:

- Powering ON or OFF
- Switching input signals

NOTE: If your PC (IBM or IBM compatible) is equipped only with a 25-pin serial port connector, a 25-pin serial port adapter is required. Contact your dealer for details.

NOTE: In order to function, the RS-232C OUT terminal can only be connected to another monitor of the same model. Do not connect to other types of equipment.

This monitor uses RXD, TXD and GND lines for RS-232C control.

The reverse type cable (null modem cable) should be used for RS-232C control.

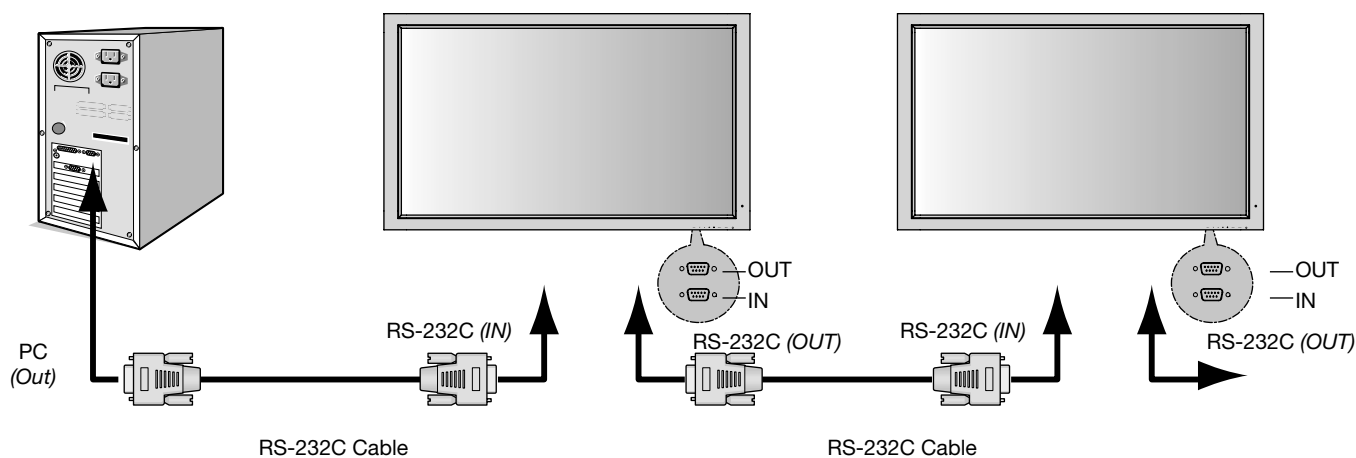

The following control sequence is used for a single monitor

When using the following control commands, all of the daisy-chained monitors can be controlled at the same time from the primary monitor. However, reply and status commands will only pertain to the primary monitor, and not to the secondary monitors.

1) Interface

PROTOCOL	RS-232C
BAUD RATE	9600 [bps]
DATA LENGTH	8 [bits]
PARITY BIT	NONE
STOP BIT	1 [bit]
FLOW CONTROL	NONE

2) Control command diagram

The command is structured by the address code, function code, data code and end code. The length of the command is different for each function.

	Address Code	Function Code	Data Code	End Code
HEX	30h 30h	Function	Data	0Dh
ASCII	'0' '0'	Function	Data	↵

[Address code] 30h 30h (In ASCII code, '0' '0') fixed.

[Function code] A code of each fixed control move.

[Data code] A code of each fixed control data (number) and not always indicated.

[End code] 0Dh (In ASCII code, '↵') fixed.

To control multiple monitors that are daisy-chained together please use the extended control command.

3) Control sequence

- 1) The command from a computer to the Plasma monitor will take 400ms.
- 2) The Plasma monitor will send a return command 400ms* after it has received an encode. If the command is not received correctly, the Plasma monitor will not send the return command.
- 3) The personal computer checks the command and confirms if the command which has been sent has been executed or not.
- 4) This Plasma monitor sends various codes other than the return code. When sending a control sequence via RS-232C, other codes from personal computers will be ignored.

**The sending time of the return command may be delayed depending on the monitor's current activity (changing of the input signal, etc.).*

[Example] Turn the power ON. (' ' is for ASCII code)

Sending commands from the PC etc.	Status code from Plasma monitor	Meaning
30 30 21 0D '0' '0' '!' '␣'		Command for POWER ON
	30 30 21 0D '0' '0' '!' '␣'	Command received (Command echo back)

4) Operation commands

Operation commands execute the basic operation setting of this Plasma monitor. It may not operate when changing the signal:

Operation	ASCII	HEX
POWER ON	!	21h
POWER OFF	"	22h
INPUT VIDEO1	_v1	5Fh 76h 31h
INPUT VIDEO2	_v4	5Fh 76h 34h
INPUT S-VIDEO	_v3	5Fh 76h 33h
INPUT DVD/HD1	_v2	5Fh 76h 32h
INPUT DVD/HD2	_v5	5Fh 76h 35h
INPUT SCART3	_v6	5Fh 76h 36h
INPUT VGA	_r2	5Fh 72h 32h
INPUT RGBHV	_r3	5Fh 72h 33h
INPUT DVI	_r1	5Fh 72h 31h

- POWER OFF command should not be used less than 1 minute after the power is turned on.
- POWER ON command should not be used less than 1 minute after the power is turned off.

5) Read command

Host computer sends the command without Data-code to monitor.

After receiving this command, the monitor returns the command with Data-code of current status to host computer.

<ex> When the Host computer checks the Power status of monitor, the status of monitor is powered-on.

Command from computer	Command from Monitor	Detail of command
30 30 76 50 0D '0"0"v"P'[enter]		Ask about the power status of monitor.
	30 30 76 50 31 0D '0"0"v"P"1'[enter]	Monitor is powered-on.

Structure of the Read-command

	ASCII		HEX	
	Function	Data	Function	Data
POWER ON	vP	1	76h 50h	31h
POWER OFF	vP	0	76h 50h	30h
INPUT VIDEO1	vl	v1	76h 49h	76h 31h
INPUT VIDEO2	vl	v4	76h 49h	76h 34h
INPUT S-VIDEO	vl	v3	76h 49h	76h 33h
INPUT DVD/HD1	vl	v2	76h 49h	76h 32h
INPUT DVD/HD2	vl	v5	76h 49h	76h 35h
INPUT SCART3	vl	v6	76h 49h	76h 36h
INPUT VGA	vl	r2	76h 49h	72h 32h
INPUT RGBHV	vl	r3	76h 49h	72h 33h
INPUT DVI	vl	r1	76h 49h	72h 31h
Picture Mode BRIGHT	vM	p1	76h 4Dh	70h 31h
Picture Mode STANDARD	vM	p2	76h 4Dh	70h 32h
Picture Mode CINEMA1	vM	p3	76h 4Dh	70h 33h
Picture Mode CINEMA2	vM	p4	76h 4Dh	70h 34h
Picture Mode DEFAULT	vM	p5	76h 4Dh	70h 35h

No picture

- The signal cable should be properly connected to the display card/computer.
- The display card should be properly seated in its slot.
- Front Power Switch and computer power switch should be in the ON position.
- Check to make sure that a supported mode has been selected on the display card or system being used. (Please consult display card or system manual to change graphics mode.)
- Check the monitor and your display card with respect to compatibility and recommended settings.
- Check the signal cable connector for bent or pushed-in pins.

Power Button does not respond

- Unplug the power cord of the monitor from the AC outlet to turn off and reset the monitor.

Image persistence

- Please be aware that Plasma Technology may experience a phenomena known as Image Persistence. Image Persistence occurs when a residual or “ghost” image of a previous image remains visible on the screen. Unlike CRT monitors, Plasma monitors’ image persistence is not permanent, but constant images being displayed for a long period of time should be avoided. To alleviate image persistence, turn off the monitor for as long as the previous image was displayed. For example, if an image was on the monitor for one hour and a residual image remains, the monitor should be turned off for one hour to erase the image.

NOTE: As with all personal display devices, NEC DISPLAY SOLUTIONS recommends displaying moving images and using a moving screen saver at regular intervals whenever the screen is idle or turning off the monitor when not in use.

Image is unstable, unfocused or swimming is apparent

- Signal cable should be properly attached to the Plasma monitor, computer, or other input device.
- Use the OSD screen controls to focus and adjust display by increasing or decreasing the clock phase total. When the display mode is changed, the OSD Image Adjust settings may need to be readjusted.
- Check the monitor and your display card with respect to compatibility and recommended signal timings.

Image of component signal is greenish

- Check to see if the DVD/HD input connector is selected.

LED on monitor is not lit

(no green or red color can be seen)

- Main Power Switch should be in the ON position and power cord should be connected.

Red LED on monitor is blinking

- A certain failure might have occurred, please contact your nearest authorized NEC DISPLAY SOLUTIONS service facility.

Display image is not sized properly

- Use the OSD screen controls to increase or decrease the clock total.
- Check to make sure that a supported mode has been selected on the display card or system being used. (Please consult display card or system manual to change graphics mode.)

Selected resolution is not displayed properly

- Use OSD information to enter Information menu and confirm that the appropriate resolution has been selected. If not, select appropriate resolution.

No Sound

- Check to see if speaker cable is properly connected.
- Check to see if mute is activated.
- Check to see if volume is set at minimum.

NOTE: It is possible to play audio from a source that is different from the video source.

RS-232C does not work

- Check the PROTOCOL SET in the OPTION2 menu.

Remote Control does not work

- Make sure the batteries are inserted properly.
- Test the batteries for strength/life.
- Make sure to point the remote directly at the sensor on the monitor.
- Check if the remote is in Remote ID mode.
- The remote control may not function when in direct sunlight or when there is strong illumination on the remote sensor of the monitor.
- Check the IR REMOTE setting in the OPTION3 menu.

Specifications P42XP10

PDP Module	Diagonal: 42 "/>1058 mm			
	Pixel Pitch	0.900 mm (W)/0.676 mm (H)		
	Resolution	1024 x 768		
Frequency	Horizontal	ANALOG: 15.625/15.734kHz, 31.0kHz - 108.5kHz		
		DIGITAL: 15.625/15.734kHz, 31.0kHz - 91.1kHz		
	Vertical	24Hz to 120.4Hz		
Panel Display Size	922 mm (W) x 519 mm (H) 36.3 in (W) x 20.4 in (H)			
Input Signals	DVI	DVI-D 24pin	Digital RGB	DVI (HDCP)
				VGA60, SVGA60, XGA60, WXGA60, SXGA60, UXGA60*, 1920X1080*
	VGA	15pin Mini D-sub	Analog RGB	0.7V p-p, Input Impedance 75 ohm
				VGA60, SVGA60, XGA60, WXGA60, SXGA60, UXGA60*
				Sync
	RGBHV	BNC (R,G,B,H,V)	Analog RGB	0.7V p-p, Input Impedance 75 ohm
				GA60, SVGA60, XGA60, WXGA60, SXGA60, UXGA60*
			Sync	Separate: TTL level (Pos./Neg.) Composite sync on Green Video: 0.3Vp-p Neg.
	DVD/HD	RCA (Y, Cb/Pb, Cr/Pr)	Component	Y : 1.0Vp-p/75ohm, Cb/Cr (Pb/Pr) : 0.7Vp-p/75 ohm
				HDTV/DVD:1080p*, 1080i*, 720p@50Hz/60Hz, 576p@50Hz, 480p@60Hz, 576i@50Hz, 480i@60Hz
	VIDEO1	BNC	Composite	1.0V p-p Input Impedance 75 ohm NTSC/PAL(B, G, M, N)/SECAM/4.43NTSC/PAL60
	VIDEO2	RCA	Composite	1.0V p-p Input Impedance 75 ohm NTSC/PAL(B, G, M, N)/SECAM/4.43NTSC/PAL60
S-VIDEO	DIN 4 pin	S-VIDEO	Y: 1.0Vp-p/75ohm C: 0.286Vp-p/75 ohm(NTSC), 0.3Vp-p/75ohm(PAL/SECAM) NTSC/PAL(B, G, M, N)/SECAM/4.43NTSC/PAL60	
Output Signal (VIDEO1 and VGA can also be used as OUTPUT terminals)	VGA	15pin Mini D-sub	Analog RGB	Analog RGB Video: 0.7V p-p with 75 ohm terminated Separate HV sync: TTL level (Pos / Neg)
	VIDEO1	BNC	Composite	Composite 1.0V p-p with 75 ohm terminated
Audio	AUDIO Input	RCA (L/R) X3	Analog Audio	Stereo L/R 0.5Vrms
Speaker Output	External Speaker Jack 8W + 8W (8 ohm)			
External Control	RS-232C: IN	9 Pin D-sub		
	RS-232C: OUT	9 Pin D-sub (daisy chain)		
Power Supply	4.4-1.8A@100-240V AC, 50/60Hz			
Operational Environment	Temperature	0° to 40°C / 32° F to 104° F		
	Humidity	20% to 80% (without condensation)		
Storage Environment	Temperature	-10°C to 50°C / 14° F to 122° F		
	Humidity	10 - 90% (without condensation)/ 90% - 2% x (Temp - 40°C) regarding over 40°C		
Dimensions	Net	1036mm(W) x 644mm(H) x 127mm(D) / 40.8"(W) x 25.4"(H) x 5.0"(D)		
	Gross	1220mm(W) x 900mm(H) x 360mm(D) / 48.0"(W) x 35.4"(H) x 14.2"(D)		
Weight (without speaker and stand)	Net	33.5 kg / 73.9 lbs		
	Gross	41.5 kg / 91.5 lbs		
VESA compatible arm mounting interface	700mm x 300mm 4 Holes (screw M8 Depth 16mm)			
Complied Regulatory and Guidelines	UL 60950-1/CSA C22.2 No.60950-1/EN60950-1/IEC60950-1 FCC-B/DOC-B/EN55022-B/EN55024/EN61000-3-2/EN61000-3-3/CE/C-Tick			
Power Management	VESA DPM (Separate HV Sync. only)			
Plug & Play	VESA DDC2B			
Accessories	Remote control, AA Batteries, Power cord, Users Manual (CD-ROM), Start Up Guide (Paper / CD-ROM), Main Power Switch cover and screw, Cable clamps			
*Compressed Image				

Specifications P50XP10

PDP Module	Diagonal: 50"/1269 mm				
	Pixel Pitch	0.81 mm (W)/0.81 mm (H)			
	Resolution	1365 x 768			
Frequency	Horizontal	ANALOG: 15.625/15.734kHz, 31.0kHz - 108.5kHz			
		DIGITAL: 15.625/15.734kHz, 31.0kHz - 91.1kHz			
	Vertical	24Hz to 120.4Hz			
Panel Display Size	1106 mm (W) x 622 mm (H) 43.5 in (W) x 24.5 in (H)				
Input Signals	DVI	DVI-D 24pin	Digital RGB	DVI (HDCP) VGA60, SVGA60, XGA60, WXGA60, SXGA60, UXGA60*, 1920X1080*	
			Analog RGB	0.7V p-p, Input Impedance 75 ohm VGA60, SVGA60, XGA60, WXGA60, SXGA60, UXGA60*	
	VGA	15pin Mini D-sub	Sync	Separate: TTL level (Pos./Neg.) Composite sync on Green Video: 0.3Vp-p Neg	
			Analog RGB	0.7V p-p, Input Impedance 75 ohm VGA60, SVGA60, XGA60, WXGA60, SXGA60, UXGA60*	
	RGBHV	BNC (R,G,B,H,V)	Sync	Separate: TTL level (Pos./Neg.) Composite sync on Green Video: 0.3Vp-p Neg.	
			Analog RGB	0.7V p-p, Input Impedance 75 ohm VGA60, SVGA60, XGA60, WXGA60, SXGA60, UXGA60*	
	DVD/HD	RCA (Y, Cb/Pb, Cr/Pr)	Component	Y : 1.0Vp-p/75ohm, Cb/Cr (Pb/Pr) : 0.7Vp-p/75 ohm HDTV/DVD:1080p*, 1080i*, 720p@50Hz/60Hz, 576p@50Hz, 480p@60Hz, 576i@50Hz, 480i@60Hz	
	VIDEO1	BNC	Composite	1.0V p-p Input Impedance 75 ohm NTSC/PAL(B, G, M, N)/SECAM/4.43NTSC/PAL60	
	VIDEO2	RCA	Composite	1.0V p-p Input Impedance 75 ohm NTSC/PAL(B, G, M, N)/SECAM/4.43NTSC/PAL60	
	S-VIDEO	DIN 4 pin	S-VIDEO	Y: 1.0Vp-p/75ohm C: 0.286Vp-p/75 ohm(NTSC), 0.3Vp-p/75ohm(PAL/SECAM) NTSC/PAL(B, G, M, N)/SECAM/4.43NTSC/PAL60	
	Output Signal (VIDEO1 and VGA can also be used as OUTPUT terminals)	VGA	15pin Mini D-sub	Analog RGB	Analog RGB Video: 0.7V p-p with 75 ohm terminated Separate HV sync: TTL level (Pos / Neg)
		VIDEO1	BNC	Composite	Composite 1.0V p-p with 75 ohm terminated
Audio	AUDIO Input	RCA (L/R) X3	Analog Audio	Stereo L/R 0.5Vrms	
Speaker Output	External Speaker Jack 8W + 8W (8 ohm)				
External Control	RS-232C: IN	9 Pin D-sub			
	RS-232C: OUT	9 Pin D-sub (daisy chain)			
Power Supply	6.0-2.6A@100-240V AC, 50/60Hz				
Operational Environment	Temperature	0° to 40°C / 32° F to 104° F			
	Humidity	20% to 80% (without condensation)			
Storage Environment	Temperature	-10°C to 50°C / 14° F to 122° F			
	Humidity	10 - 90% (without condensation)/ 90% - 2% x (Temp - 40°C) regarding over 40°C			
Dimensions	Net	1221mm(W) x 743mm(H) x 127mm(D) / 48.1"(W) x 29.3"(H) x 5.0"(D)			
	Gross	1400mm(W) x 980mm(H) x 360mm(D) / 55.1"(W) x 38.6"(H) x 14.2"(D)			
Weight (without speaker and stand)	Net	47.5 kg / 104.7 lbs			
	Gross	57.5 kg / 126.8 lbs			
VESA compatible arm mounting interface	700mm x 300mm 4 Holes (screw M8 Depth 16mm)				
Complied Regulatory and Guidelines	UL 60950-1/CSA C22.2 No.60950-1/EN60950-1/IEC60950-1 FCC-B/DOC-B/EN55022-B/EN55024/EN61000-3-2/EN61000-3-3/CE/C-Tick				
Power Management	VESA DPM (Separate HV Sync. only)				
Plug & Play	VESA DDC2B				
Accessories	Remote control, AA Batteries, Power cord, Users Manual (CD-ROM), Start Up Guide (Paper / CD-ROM), Main Power Switch cover and screw, Cable clamps				
*Compressed Image					

Specifications P60XP10

PDP Module	Diagonal: 60"/1514 mm			
	Pixel Pitch	0.966 mm (W)/0.966 mm (H)		
	Resolution	1366 x 768		
Frequency	Horizontal	ANALOG: 15.625/15.734kHz, 31.0kHz - 108.5kHz		
		DIGITAL: 15.625/15.734kHz, 31.0kHz - 91.1kHz		
	Vertical	24Hz to 120.4Hz		
Panel Display Size	1320 mm (W) x 742 mm (H) 51.9 in (W) x 29.2 in (H)			
Input Signals	DVI	DVI-D 24pin	Digital RGB	DVI (HDCP)
				VGA60, SVGA60, XGA60, WXGA60, SXGA60, UXGA60*, 1920X1080*
	VGA	15pin Mini D-sub	Analog RGB	0.7V p-p, Input Impedance 75 ohm
				VGA60, SVGA60, XGA60, WXGA60, SXGA60, UXGA60*
				Sync
	RGBHV	BNC (R,G,B,H,V)	Analog RGB	0.7V p-p, Input Impedance 75 ohm
				VGA60, SVGA60, XGA60, WXGA60, SXGA60, UXGA60*
			Sync	Separate: TTL level (Pos./Neg.) Composite sync on Green Video: 0.3Vp-p Neg.
	DVD/HD	RCA (Y, Cb/Pb, Cr/Pr)	Component	Y : 1.0Vp-p/75ohm, Cb/Cr (Pb/Pr) : 0.7Vp-p/75 ohm
				HDTV/DVD:1080p*, 1080i*, 720p@50Hz/60Hz, 576p@50Hz, 480p@60Hz, 576i@50Hz, 480i@60Hz
	VIDEO1	BNC	Composite	1.0V p-p Input Impedance 75 ohm NTSC/PAL(B, G, M, N)/SECAM/4.43NTSC/PAL60
	VIDEO2	RCA	Composite	1.0V p-p Input Impedance 75 ohm NTSC/PAL(B, G, M, N)/SECAM/4.43NTSC/PAL60
	S-VIDEO	DIN 4 pin	S-VIDEO	Y: 1.0Vp-p/75ohm C: 0.286Vp-p/75 ohm(NTSC), 0.3Vp-p/75ohm(PAL/SECAM)
				NTSC/PAL(B, G, M, N)/SECAM/4.43NTSC/PAL60
Output Signal (VIDEO1 and VGA can also be used as OUTPUT terminals)	VGA	15pin Mini D-sub	Analog RGB	Analog RGB Video: 0.7V p-p with 75 ohm terminated Separate HV sync: TTL level (Pos / Neg)
	VIDEO1	BNC	Composite	Composite 1.0V p-p with 75 ohm terminated
Audio	AUDIO Input	RCA (L/R) X3	Analog Audio	Stereo L/R 0.5Vrms
Speaker Output	External Speaker Jack 8W + 8W (8 ohm)			
External Control	RS-232C: IN	9 Pin D-sub		
	RS-232C: OUT	9 Pin D-sub (daisy chain)		
Power Supply	7.8-3.2A@100-240V AC, 50/60Hz			
Operational Environment	Temperature	0° to 40°C / 32° F to 104° F		
	Humidity	20% to 80% (without condensation)		
Storage Environment	Temperature	-10°C to 50°C / 14° F to 122° F		
	Humidity	10 - 90% (without condensation)/ 90% - 2% x (Temp - 40°C) regarding over 40°C		
Dimensions	Net	1447(W)mm x 871mm(H) x 127mm(D) / 57.0"(W) x 34.3"(H) x 5.0"(D)		
	Gross	1620mm(W) x 1100mm(H) x 360mm(D) / 63.8"(W) x 43.3"(H) x 14.2"(D)		
Weight (without speaker and stand)	Net	68.5 kg / 151.0 lbs		
	Gross	81.0 kg / 178.6 lbs		
VESA compatible arm mounting interface	700mm x 300mm 4 Holes (screw M8 Depth 16mm)			
Complied Regulatory and Guidelines	UL 60950-1/CSA C22.2 No.60950-1/EN60950-1/IEC60950-1 FCC-B/DOC-B/EN55022-B/EN55024/EN61000-3-2/EN61000-3-3/CE/C-Tick			
Power Management	VESA DPM (Separate HV Sync. only)			
Plug & Play	VESA DDC2B			
Accessories	Remote control, AA Batteries, Power cord, Users Manual (CD-ROM), Start Up Guide (Paper / CD-ROM), Main Power Switch cover and screw, Cable clamps			
*Compressed Image				

P42XP10 Supported Resolutions (PC)

S/g. no.	Resolution H X V	Specification of the signal			Analog				Digital				TEXT INSERT			RGB select Item			
		V freq. (kHz)	H freq. (kHz)	Signal Type	INPUT terminal	NORMAL (4:3)	FULL (16:9)	ZOOM (REAL)	TRUE (REAL)	INPUT terminal	NORMAL (4:3)	FULL (16:9)	ZOOM (REAL)	TRUE (REAL)	TOP+3MID HIGH/MID LOW/BOTTOM-3		Lef/Right	Gr. No.	
IBM PC/AT Compatible Computers	1	640 X 400	70.1	31.5	400line	VGA	--	Yes	--	--	--	--	Yes	Yes	Yes	Neg.	1	640X400	
	2	720 X 400	70.1	31.5	400line	RGBHV	--	Yes	--	Yes	--	Yes	Yes	Yes	Yes	Neg.	1	720X400	
	3	720 X 350	85	37.9	350line		--	Yes	--	Yes	--	Yes	Yes	Yes	Yes	Pos.	--	--	--
	4	640 X 480	70.1	31.5	VGA		--	Yes	--	Yes	--	Yes	Yes	Yes	Yes	Neg.	1	720X350	
	5	640 X 480	59.9	31.5			Yes	Yes	Yes	Yes	Yes	Yes	Yes	Yes	Yes	Neg.	2	640X480	
	6	640 X 480	72.8	37.9			Yes	Yes	Yes	Yes	Yes	Yes	Yes	Yes	Yes	Neg.	--	--	--
	7	720 X 400	75	37.5			Yes	Yes	Yes	Yes	Yes	Yes	Yes	Yes	Yes	Neg.	--	--	--
	8	720 X 400	85	43.3			Yes	Yes	Yes	Yes	Yes	Yes	Yes	Yes	Yes	Neg.	--	--	--
	9	848 X 480	100.4	51.1			Yes	Yes	Yes	Yes	Yes	Yes	Yes	Yes	Yes	Neg.	--	--	--
	10	848 X 480	120.4	61.3			Yes	Yes	Yes	Yes	Yes	Yes	Yes	Yes	Yes	Neg.	--	--	--
Apple Macintosh®	11	848 X 480	60	31	Wide-VGA		--	Yes	--	Yes	--	Yes	Yes	Yes	Pos.	2	848X480		
	12	852 X 480	60	31.7	Wide-VGA		--	Yes	--	Yes	--	Yes	Yes	Yes	Neg.	2	852X480		
	13	800 X 600	56.3	35.2	SVGA		Yes	Yes	Yes	Yes	Yes	Yes	Yes	Yes	Pos.	--	--	--	
	14	800 X 600	60.3	37.9			Yes	Yes	Yes	Yes	Yes	Yes	Yes	Yes	Pos.	--	--	--	
	15	1024 X 768	72.2	48.1			Yes	Yes	Yes	Yes	Yes	Yes	Yes	Yes	Pos.	--	--	--	
	16	1024 X 768	75	46.9			Yes	Yes	Yes	Yes	Yes	Yes	Yes	Yes	Pos.	--	--	--	
	17	1024 X 768	85.1	53.7			Yes	Yes	Yes	Yes	Yes	Yes	Yes	Yes	Pos.	--	--	--	
	18	1024 X 768	99.8	63			Yes	Yes	Yes	Yes	Yes	Yes	Yes	Yes	Pos.	--	--	--	
	19	1024 X 768	120	75.7			Yes	Yes	Yes	Yes	Yes	Yes	Yes	Yes	Pos.	--	--	--	
	20	1024 X 768	60	48.4	XGA		Yes	Yes	Yes	Yes	Yes	Yes	Yes	Yes	Neg.	3	1024X768		
EWS Series	21	1280 X 768	70.1	56.5			Yes	Yes	Yes	Yes	Yes	Yes	Yes	Yes	Neg.	5	1024X768		
	22	1280 X 768	71.9	57.9			Yes	Yes	Yes	Yes	Yes	Yes	Yes	Yes	Neg.	6	1024X768		
	23	1280 X 768	75	60			Yes	Yes	Yes	Yes	Yes	Yes	Yes	Yes	Pos.	--	--	--	
	24	1280 X 768	85	68.7			Yes	Yes	Yes	Yes	Yes	Yes	Yes	Yes	Pos.	--	--	--	
	25	1280 X 768	100.6	80.5			Yes	Yes	Yes	Yes	Yes	Yes	Yes	Yes	Pos.	--	--	--	
	26	1280 X 768	119.4	95.5			Yes	Yes	Yes	Yes	Yes	Yes	Yes	Yes	Neg.	--	--	--	
	27	1152 X 864	60	53.7	XGA		Yes	Yes	Yes	Yes	Yes	Yes	Yes	Yes	Pos.	--	--	--	
	28	1280 X 768	72	64.9			Yes	Yes	Yes	Yes	Yes	Yes	Yes	Yes	Pos.	--	--	--	
	29	1280 X 768	75	67.5			Yes	Yes	Yes	Yes	Yes	Yes	Yes	Yes	Pos.	--	--	--	
	30	1280 X 768	56.2	45.1	Wide-XGA		--	Yes	--	--	--	--	--	--	Pos.	--	--	--	
EWS Series	31	1280 X 768	59.8	48			Yes	Yes	Yes	Yes	Yes	Yes	Yes	Yes	Pos.	3	1280X768-1		
	32	1280 X 768	59.9	47.8			Yes	Yes	Yes	Yes	Yes	Yes	Yes	Yes	Neg.	3	1280X768-2		
	33	1280 X 768	69.8	56			Yes	Yes	Yes	Yes	Yes	Yes	Yes	Yes	Pos.	5	1280X768		
	34	1280 X 768	72	57.8			Yes	Yes	Yes	Yes	Yes	Yes	Yes	Yes	Neg.	6	1280X768		
	35	1280 X 768	59.8	49.7	Wide-XGA		--	Yes	--	--	--	--	--	--	Pos.	4	1280X800		
	36	1280 X 800	60	53.1	Wide-XGA		--	Yes	--	--	--	--	--	--	Pos.	--	--	--	
	37	1280 X 860	60	60	Wide-XGA		Yes	Yes	Yes	Yes	Yes	Yes	Yes	Yes	Pos.	--	--	--	
	38	1280 X 860	85	85.9	Wide-XGA		Yes	Yes	Yes	Yes	Yes	Yes	Yes	Yes	Pos.	--	--	--	
	39	1360 X 768	60	47.7	Wide-XGA		--	Yes	--	--	--	--	--	--	Pos.	3	1360X768		
	40	1376 X 768	59.9	48.3	Wide-XGA		--	Yes	--	--	--	--	--	--	Pos.	3	1376X768		
EWS Series	41	1280 X 1024	60	64	SXGA		Yes	Yes	Yes	Yes	Yes	Yes	Yes	Yes	Pos.	9	1400X1050		
	42	1400 X 1050	75	80			Yes	Yes	Yes	Yes	Yes	Yes	Yes	Yes	Pos.	7	1400X1050		
	43	1400 X 1050	85	91.1			Yes	Yes	Yes	Yes	Yes	Yes	Yes	Yes	Neg.	--	--	--	
	44	1400 X 1050	100.1	108.5			Yes	Yes	Yes	Yes	Yes	Yes	Yes	Yes	Pos.	9	1400X1050		
	45	1400 X 1050	60	64	SXGA+		Yes	Yes	Yes	Yes	Yes	Yes	Yes	Yes	Neg.	4	1280X800		
	46	1400 X 1050	60	65.3			Yes	Yes	Yes	Yes	Yes	Yes	Yes	Yes	Pos.	--	--	--	
	47	1400 X 1050	74.9	82.3			Yes	Yes	Yes	Yes	Yes	Yes	Yes	Yes	Neg.	--	--	--	
	48	1400 X 1050	85	93.9			Yes	Yes	Yes	Yes	Yes	Yes	Yes	Yes	Pos.	--	--	--	
	49	1400 X 1050	60	65.3	Wide-SXGA		--	Yes	--	--	--	--	--	--	Neg.	7	1680X1050		
	50	1600 X 1200	60	75	UXGA		Yes	Yes	Yes	Yes	Yes	Yes	Yes	Yes	Pos.	8	1600X1200		
EWS Series	51	1600 X 1200	65	81.3			Yes	Yes	Yes	Yes	Yes	Yes	Yes	Yes	Pos.	8	1600X1200		
	52	1600 X 1200	70	87.5			Yes	Yes	Yes	Yes	Yes	Yes	Yes	Yes	Pos.	--	--	--	
	53	1600 X 1200	75	93.8			Yes	Yes	Yes	Yes	Yes	Yes	Yes	Yes	Pos.	--	--	--	
	54	1600 X 1200	85	106.3			Yes	Yes	Yes	Yes	Yes	Yes	Yes	Yes	Pos.	--	--	--	
	55	1600 X 1200	50	56.2			--	Yes	--	--	--	--	--	--	Pos.	--	--	--	
	56	1600 X 1200	60	67.5			--	Yes	--	--	--	--	--	--	Pos.	--	--	--	
	57	1920 X 1200	59.9	74.6	Wide-UXGA		--	Yes	--	--	--	--	--	--	Neg.	8	1920X1200		
	58	1920 X 1200	60	74.6	Wide-UXGA		--	Yes	--	--	--	--	--	--	Neg.	8	1920X1200		
	59	1920 X 1200	66.7	75	Mac13*		Yes	Yes	Yes	Yes	Yes	Yes	Yes	Yes	Pos.	--	--	--	
	EWS Series	60	1920 X 1200	66.7	74	Mac13*		Yes	Yes	Yes	Yes	Yes	Yes	Yes	Yes	Pos.	--	--	--
61		1920 X 1200	74.6	81.3	Mac16*		Yes	Yes	Yes	Yes	Yes	Yes	Yes	Yes	Pos.	--	--	--	
62		1920 X 1200	74.9	80.2	Mac19*		Yes	Yes	Yes	Yes	Yes	Yes	Yes	Yes	Pos.	--	--	--	
63		1920 X 1200	75.1	88.7	Mac21*		Yes	Yes	Yes	Yes	Yes	Yes	Yes	Yes	Pos.	--	--	--	
64		1920 X 1200	59.9	55.9	Apple17		--	Yes	--	--	--	--	--	--	Neg.	--	--	--	
65		1920 X 1200	60	64.6	EWS4800		Yes	Yes	Yes	Yes	Yes	Yes	Yes	Yes	Neg.	--	--	--	
66		1920 X 1200	71.2	75.1			Yes	Yes	Yes	Yes	Yes	Yes	Yes	Yes	Neg.	--	--	--	
67		1920 X 1200	72	78.1	HP		Yes	Yes	Yes	Yes	Yes	Yes	Yes	Yes	Neg.	--	--	--	
68		1920 X 1200	66	61.8	SUN		Yes	Yes	Yes	Yes	Yes	Yes	Yes	Yes	Neg.	--	--	--	
69		1920 X 1200	76	71.7			Yes	Yes	Yes	Yes	Yes	Yes	Yes	Yes	C Sync	--	--	--	
EWS Series	70	1920 X 1200	76.1	81.1			Yes	Yes	Yes	Yes	Yes	Yes	Yes	Yes	C Sync	--	--	--	
	71	1920 X 1200	60	49.7	SGI		Yes	Yes	Yes	Yes	Yes	Yes	Yes	Yes	C Sync	--	--	--	
	72	1920 X 1200	60	63.9			Yes	Yes	Yes	Yes	Yes	Yes	Yes	Yes	C Sync	--	--	--	
	73	1920 X 1200	60	63.9			Yes	Yes	Yes	Yes	Yes	Yes	Yes	Yes	C Sync	--	--	--	
	74	1920 X 1200	60	63.9			Yes	Yes	Yes	Yes	Yes	Yes	Yes	Yes	C Sync	--	--	--	
	75	1920 X 1200	60	63.9			Yes	Yes	Yes	Yes	Yes	Yes	Yes	Yes	C Sync	--	--	--	
	76	1920 X 1200	60	63.9			Yes	Yes	Yes	Yes	Yes	Yes	Yes	Yes	C Sync	--	--	--	
	77	1920 X 1200	60	63.9			Yes	Yes	Yes	Yes	Yes	Yes	Yes	Yes	C Sync	--	--	--	
	78	1920 X 1200	60	63.9			Yes	Yes	Yes	Yes	Yes	Yes	Yes	Yes	C Sync	--	--	--	
	79	1920 X 1200	60	63.9			Yes	Yes	Yes	Yes	Yes	Yes	Yes	Yes	C Sync	--	--	--	

(*) FULL(16:9)
 Aspect ratio is 5:4 (720x768)
 Rough Sampling

P50XP10 Supported Resolutions (PC)

Sg. no.	Resolution H x V	Signal Type	Specification of the signal		Analog			Digital			TEXT INSERT			Gr. No.	RGB select Item		
			V freq. (kHz)	H freq. (kHz)	INPUT terminal	NORMAL (4:3)	FULL (16:9)	ZOOM (REAL)	TRUE (REAL)	INPUT terminal (DV+PC)	NORMAL (4:3)	FULL (16:9)	ZOOM (REAL)			TRUE (REAL)	Sync polarity
			(Hz)	(kHz)	VGA RGBHV					DVI							H
1	640 X 400	400line	70.1	31.5		Yes	Yes	Yes	Yes	Yes	Yes	Yes	Yes	Neg.	1	640X400	
2	720 X 400	400line	70.1	31.5		Yes	Yes	Yes	Yes	Yes	Yes	Yes	Yes	Neg.	1	720X400	
3	720 X 400	400line	85	37.9		Yes	Yes	Yes	Yes	Yes	Yes	Yes	Yes	Neg.	1	720X400	
4	720 X 350	350line	70.1	31.5		Yes	Yes	Yes	Yes	Yes	Yes	Yes	Yes	Neg.	1	720X350	
5	640 X 480	VGA	59.9	37.9		Yes	Yes	Yes	Yes	Yes	Yes	Yes	Yes	Neg.	2	640X480	
6	640 X 480	VGA	72.8	37.9		Yes	Yes	Yes	Yes	Yes	Yes	Yes	Yes	Neg.	2	640X480	
7	640 X 480	VGA	75	37.5		Yes	Yes	Yes	Yes	Yes	Yes	Yes	Yes	Neg.	2	640X480	
8	640 X 480	VGA	85	43.3		Yes	Yes	Yes	Yes	Yes	Yes	Yes	Yes	Neg.	2	640X480	
9	640 X 480	VGA	100.4	51.1		Yes	Yes	Yes	Yes	Yes	Yes	Yes	Yes	Neg.	2	640X480	
10	640 X 480	VGA	120.4	61.3		Yes	Yes	Yes	Yes	Yes	Yes	Yes	Yes	Neg.	2	640X480	
11	848 X 480	Wide-VGA	60	31.7		Yes	Yes	Yes	Yes	Yes	Yes	Yes	Yes	Pos.	2	848X480	
12	852 X 480	Wide-VGA	60	31.7		Yes	Yes	Yes	Yes	Yes	Yes	Yes	Yes	Neg.	2	852X480	
13	800 X 600	SVGA	56.3	35.2		Yes	Yes	Yes	Yes	Yes	Yes	Yes	Yes	Pos.	2	800X600	
14	800 X 600	SVGA	60.3	37.9		Yes	Yes	Yes	Yes	Yes	Yes	Yes	Yes	Pos.	2	800X600	
15	800 X 600	SVGA	72.2	48.1		Yes	Yes	Yes	Yes	Yes	Yes	Yes	Yes	Pos.	2	800X600	
16	800 X 600	SVGA	75	46.9		Yes	Yes	Yes	Yes	Yes	Yes	Yes	Yes	Pos.	2	800X600	
17	800 X 600	SVGA	85.1	53.7		Yes	Yes	Yes	Yes	Yes	Yes	Yes	Yes	Pos.	2	800X600	
18	800 X 600	SVGA	99.8	63		Yes	Yes	Yes	Yes	Yes	Yes	Yes	Yes	Pos.	2	800X600	
19	800 X 600	SVGA	120	75.7		Yes	Yes	Yes	Yes	Yes	Yes	Yes	Yes	Pos.	2	800X600	
20	1024 X 768	XGA	60	48.4		Yes	Yes	Yes	Yes	Yes	Yes	Yes	Yes	Pos.	3	1024X768	
21	1024 X 768	XGA	70.1	56.5		Yes	Yes	Yes	Yes	Yes	Yes	Yes	Yes	Neg.	3	1024X768	
22	1024 X 768	XGA	71.9	57.9		Yes	Yes	Yes	Yes	Yes	Yes	Yes	Yes	Neg.	3	1024X768	
23	1024 X 768	XGA	75	60		Yes	Yes	Yes	Yes	Yes	Yes	Yes	Yes	Pos.	6	1024X768	
24	1024 X 768	XGA	85	68.7		Yes	Yes	Yes	Yes	Yes	Yes	Yes	Yes	Pos.	6	1024X768	
25	1024 X 768	XGA	100.6	80.5		Yes	Yes	Yes	Yes	Yes	Yes	Yes	Yes	Pos.	6	1024X768	
26	1024 X 768	XGA	119.4	95.5		Yes	Yes	Yes	Yes	Yes	Yes	Yes	Yes	Neg.	6	1024X768	
27	1152 X 864	XGA	60	53.7		Yes	Yes	Yes	Yes	Yes	Yes	Yes	Yes	Pos.	6	1152X864	
28	1152 X 864	XGA	72	64.9		Yes	Yes	Yes	Yes	Yes	Yes	Yes	Yes	Neg.	6	1152X864	
29	1152 X 864	XGA	75	67.5		Yes	Yes	Yes	Yes	Yes	Yes	Yes	Yes	Pos.	6	1152X864	
30	1280 X 768	Wide-XGA	56.2	45.1		Yes	Yes	Yes	Yes	Yes	Yes	Yes	Yes	Pos.	3	1280X768	
31	1280 X 768	Wide-XGA	59.8	48		Yes	Yes	Yes	Yes	Yes	Yes	Yes	Yes	Neg.	3	1280X768	
32	1280 X 768	Wide-XGA	59.9	47.8		Yes	Yes	Yes	Yes	Yes	Yes	Yes	Yes	Pos.	5	1280X768	
33	1280 X 768	Wide-XGA	69.8	58		Yes	Yes	Yes	Yes	Yes	Yes	Yes	Yes	Pos.	6	1280X768	
34	1280 X 768	Wide-XGA	72	57.8		Yes	Yes	Yes	Yes	Yes	Yes	Yes	Yes	Neg.	4	1280X768	
35	1280 X 800	Wide-XGA	59.8	49.7		Yes	Yes	Yes	Yes	Yes	Yes	Yes	Yes	Pos.	4	1280X800	
36	1280 X 854	Wide-XGA	60	53.1		Yes	Yes	Yes	Yes	Yes	Yes	Yes	Yes	Pos.	4	1280X854	
37	1280 X 960	Wide-XGA	60	60		Yes	Yes	Yes	Yes	Yes	Yes	Yes	Yes	Pos.	4	1280X960	
38	1360 X 768	Wide-XGA	60	60		Yes	Yes	Yes	Yes	Yes	Yes	Yes	Yes	Pos.	3	1360X768	
39	1376 X 768	Wide-XGA	59.9	48.3		Yes	Yes	Yes	Yes	Yes	Yes	Yes	Yes	Pos.	3	1376X768	
40	1280 X 1024	SXGA	60	64		Yes	Yes	Yes	Yes	Yes	Yes	Yes	Yes	Pos.	9	1280X1024	
41	1280 X 1024	SXGA	75	80		Yes	Yes	Yes	Yes	Yes	Yes	Yes	Yes	Pos.	9	1280X1024	
42	1280 X 1024	SXGA	85	91.1		Yes	Yes	Yes	Yes	Yes	Yes	Yes	Yes	Pos.	9	1280X1024	
43	1280 X 1024	SXGA	100.1	108.5		Yes	Yes	Yes	Yes	Yes	Yes	Yes	Yes	Pos.	9	1280X1024	
44	1400 X 1050	SXGA+	60	64		Yes	Yes	Yes	Yes	Yes	Yes	Yes	Yes	Pos.	9	1400X1050	
45	1400 X 1050	SXGA+	60	65.3		Yes	Yes	Yes	Yes	Yes	Yes	Yes	Yes	Neg.	7	1400X1050	
46	1400 X 1050	SXGA+	60	82.3		Yes	Yes	Yes	Yes	Yes	Yes	Yes	Yes	Neg.	7	1400X1050	
47	1400 X 1050	SXGA+	74.9	92.3		Yes	Yes	Yes	Yes	Yes	Yes	Yes	Yes	Neg.	7	1400X1050	
48	1400 X 1050	SXGA+	85	93.9		Yes	Yes	Yes	Yes	Yes	Yes	Yes	Yes	Pos.	7	1400X1050	
49	1680 X 1050	Wide-SXGA	60	65.3		Yes	Yes	Yes	Yes	Yes	Yes	Yes	Yes	Pos.	7	1680X1050	
50	1680 X 1200	UXGA	60	75		Yes	Yes	Yes	Yes	Yes	Yes	Yes	Yes	Neg.	8	1680X1200	
51	1680 X 1200	UXGA	66	81.3		Yes	Yes	Yes	Yes	Yes	Yes	Yes	Yes	Pos.	8	1680X1200	
52	1680 X 1200	UXGA	70	87.5		Yes	Yes	Yes	Yes	Yes	Yes	Yes	Yes	Pos.	8	1680X1200	
53	1680 X 1200	UXGA	75	93.8		Yes	Yes	Yes	Yes	Yes	Yes	Yes	Yes	Pos.	8	1680X1200	
54	1920 X 1080		65	100.3		Yes	Yes	Yes	Yes	Yes	Yes	Yes	Yes	Pos.	8	1920X1080	
55	1920 X 1080		50	56.2		Yes	Yes	Yes	Yes	Yes	Yes	Yes	Yes	Pos.	8	1920X1080	
56	1920 X 1200	Wide-UXGA	60	67.5		Yes	Yes	Yes	Yes	Yes	Yes	Yes	Yes	Pos.	8	1920X1200	
57	1920 X 1200	Wide-UXGA	59.9	74.6		Yes	Yes	Yes	Yes	Yes	Yes	Yes	Yes	Neg.	8	1920X1200	
58	1920 X 1200	Wide-UXGA	60	74		Yes	Yes	Yes	Yes	Yes	Yes	Yes	Yes	Pos.	8	1920X1200	
59	1920 X 1200	Wide-UXGA	60	74		Yes	Yes	Yes	Yes	Yes	Yes	Yes	Yes	Pos.	8	1920X1200	
60	1920 X 1200	Wide-UXGA	66.7	35		Yes	Yes	Yes	Yes	Yes	Yes	Yes	Yes	Pos.	8	1920X1200	
61	640 X 480	Mac13"	66.7	74.6		Yes	Yes	Yes	Yes	Yes	Yes	Yes	Yes	Pos.	8	640X480	
62	832 X 624	Mac16"	74.6	49.7		Yes	Yes	Yes	Yes	Yes	Yes	Yes	Yes	Pos.	8	832X624	
63	1024 X 768	Mac19"	74.9	60.2		Yes	Yes	Yes	Yes	Yes	Yes	Yes	Yes	Pos.	8	1024X768	
64	1152 X 870	Mac21"	75.1	66.7		Yes	Yes	Yes	Yes	Yes	Yes	Yes	Yes	Pos.	8	1152X870	
65	1440 X 900	Apple17"	59.9	55.9		Yes	Yes	Yes	Yes	Yes	Yes	Yes	Yes	Pos.	8	1440X900	
66	1440 X 900	Apple17"	59.9	55.9		Yes	Yes	Yes	Yes	Yes	Yes	Yes	Yes	Pos.	8	1440X900	
67	1440 X 900	Apple17"	59.9	55.9		Yes	Yes	Yes	Yes	Yes	Yes	Yes	Yes	Pos.	8	1440X900	
68	1440 X 900	Apple17"	59.9	55.9		Yes	Yes	Yes	Yes	Yes	Yes	Yes	Yes	Pos.	8	1440X900	
69	1440 X 900	Apple17"	59.9	55.9		Yes	Yes	Yes	Yes	Yes	Yes	Yes	Yes	Pos.	8	1440X900	
70	1440 X 900	Apple17"	59.9	55.9		Yes	Yes	Yes	Yes	Yes	Yes	Yes	Yes	Pos.	8	1440X900	
71	1440 X 900	Apple17"	59.9	55.9		Yes	Yes	Yes	Yes	Yes	Yes	Yes	Yes	Pos.	8	1440X900	
72	1440 X 900	Apple17"	59.9	55.9		Yes	Yes	Yes	Yes	Yes	Yes	Yes	Yes	Pos.	8	1440X900	
73	1440 X 900	Apple17"	59.9	55.9		Yes	Yes	Yes	Yes	Yes	Yes	Yes	Yes	Pos.	8	1440X900	
74	1440 X 900	Apple17"	59.9	55.9		Yes	Yes	Yes	Yes	Yes	Yes	Yes	Yes	Pos.	8	1440X900	
75	1440 X 900	Apple17"	59.9	55.9		Yes	Yes	Yes	Yes	Yes	Yes	Yes	Yes	Pos.	8	1440X900	
76	1440 X 900	Apple17"	59.9	55.9		Yes	Yes	Yes	Yes	Yes	Yes	Yes	Yes	Pos.	8	1440X900	
77	1440 X 900	Apple17"	59.9	55.9		Yes	Yes	Yes	Yes	Yes	Yes	Yes	Yes	Pos.	8	1440X900	
78	1440 X 900	Apple17"	59.9	55.9		Yes	Yes	Yes	Yes	Yes	Yes	Yes	Yes	Pos.	8	1440X900	
79	1440 X 900	Apple17"	59.9	55.9		Yes	Yes	Yes	Yes	Yes	Yes	Yes	Yes	Pos.	8	1440X900	
80	1440 X 900	Apple17"	59.9	55.9		Yes	Yes	Yes	Yes	Yes	Yes	Yes	Yes	Pos.	8	1440X900	
81	1440 X 900	Apple17"	59.9	55.9		Yes	Yes	Yes	Yes	Yes	Yes	Yes	Yes	Pos.	8	1440X900	
82	1440 X 900	Apple17"	59.9	55.9		Yes											

P60XP10 Supported Resolutions (PC)

Sig. no.	Resolution H X V	Specification of the signal				Analog			Digital			TEXT INSERT			RGB select Item				
		V freq. (Hz)	H freq. (kHz)	Signal Type	INPUT terminal VGA RGBHV	NORMAL (4:3)	FULL (16:9)	ZOOM (REAL)	TRUE (REAL)	INPUT terminal DVI (DVI-PC)	NORMAL (4:3)	FULL (16:9)	ZOOM (REAL)	TRUE (REAL)		TOP1-MID HIGH/ MID LOW/BOTTOM1-3	Left/Right	Sync polarity H V	Gr. No.
IBM PC/AT Compatible Computers	1	640 X 400	70.1	31.5	400line	Yes	Yes	Yes	Yes	Yes	Yes	Yes	Yes	Yes	Yes	Neg.	1	640X400	
	2	720 X 400	70.1	31.5	400line	Yes	Yes	Yes	Yes	Yes	Yes	Yes	Yes	Yes	Yes	Neg.	1	720X400	
	3	720 X 350	85	37.9	350line	Yes	Yes	Yes	Yes	Yes	Yes	Yes	Yes	Yes	Yes	Neg.	1	720X350	
	4	640 X 480	59.9	31.5	VGA	Yes	Yes	Yes	Yes	Yes	Yes	Yes	Yes	Yes	Yes	Neg.	2	640X480	
	5	640 X 480	72.8	37.9	VGA	Yes	Yes	Yes	Yes	Yes	Yes	Yes	Yes	Yes	Yes	Neg.	2	640X480	
	6	720 X 480	75	37.5	VGA	Yes	Yes	Yes	Yes	Yes	Yes	Yes	Yes	Yes	Yes	Neg.	2	720X480	
	7	640 X 480	85	43.3	VGA	Yes	Yes	Yes	Yes	Yes	Yes	Yes	Yes	Yes	Yes	Neg.	2	640X480	
	8	640 X 480	100.4	51.1	VGA	Yes	Yes	Yes	Yes	Yes	Yes	Yes	Yes	Yes	Yes	Neg.	2	640X480	
	9	640 X 480	120.4	61.3	VGA	Yes	Yes	Yes	Yes	Yes	Yes	Yes	Yes	Yes	Yes	Neg.	2	640X480	
	10	640 X 480	60	31	Wide-VGA	Yes	Yes	Yes	Yes	Yes	Yes	Yes	Yes	Yes	Yes	Pos.	2	848X460	
Apple Macintosh®	11	852 X 480	60	31.7	Wide-VGA	Yes	Yes	Yes	Yes	Yes	Yes	Yes	Yes	Yes	Yes	Neg.	2	852X460	
	12	800 X 600	56.3	35.2	SVGA	Yes	Yes	Yes	Yes	Yes	Yes	Yes	Yes	Yes	Yes	Pos.	2	800X600	
	13	800 X 600	60.3	37.9	SVGA	Yes	Yes	Yes	Yes	Yes	Yes	Yes	Yes	Yes	Yes	Pos.	2	800X600	
	14	800 X 600	72.2	48.1	SVGA	Yes	Yes	Yes	Yes	Yes	Yes	Yes	Yes	Yes	Yes	Pos.	2	800X600	
	15	800 X 600	75	46.9	SVGA	Yes	Yes	Yes	Yes	Yes	Yes	Yes	Yes	Yes	Yes	Pos.	2	800X600	
	16	800 X 600	85.1	53.7	SVGA	Yes	Yes	Yes	Yes	Yes	Yes	Yes	Yes	Yes	Yes	Pos.	2	800X600	
	17	800 X 600	99.8	63	SVGA	Yes	Yes	Yes	Yes	Yes	Yes	Yes	Yes	Yes	Yes	Pos.	2	800X600	
	18	800 X 600	120	75.7	SVGA	Yes	Yes	Yes	Yes	Yes	Yes	Yes	Yes	Yes	Yes	Pos.	2	800X600	
	19	800 X 600	60	48.4	XGA	Yes	Yes	Yes	Yes	Yes	Yes	Yes	Yes	Yes	Yes	Neg.	3	1024X768	
	20	1024 X 768	70.1	56.5	XGA	Yes	Yes	Yes	Yes	Yes	Yes	Yes	Yes	Yes	Yes	Neg.	3	1024X768	
EWS Series	21	1024 X 768	71.9	57.9	XGA	Yes	Yes	Yes	Yes	Yes	Yes	Yes	Yes	Yes	Yes	Neg.	5	1024X768	
	22	1024 X 768	75	60	XGA	Yes	Yes	Yes	Yes	Yes	Yes	Yes	Yes	Yes	Yes	Neg.	6	1024X768	
	23	1024 X 768	85	68.7	XGA	Yes	Yes	Yes	Yes	Yes	Yes	Yes	Yes	Yes	Yes	Pos.	6	1024X768	
	24	1024 X 768	100.6	80.5	XGA	Yes	Yes	Yes	Yes	Yes	Yes	Yes	Yes	Yes	Yes	Pos.	6	1024X768	
	25	1024 X 768	119.4	95.5	XGA	Yes	Yes	Yes	Yes	Yes	Yes	Yes	Yes	Yes	Yes	Pos.	6	1024X768	
	26	1024 X 768	60	53.7	XGA	Yes	Yes	Yes	Yes	Yes	Yes	Yes	Yes	Yes	Yes	Neg.	3	1024X768	
	27	1152 X 864	72	64.9	XGA	Yes	Yes	Yes	Yes	Yes	Yes	Yes	Yes	Yes	Yes	Neg.	3	1152X864	
	28	1152 X 864	75	67.5	XGA	Yes	Yes	Yes	Yes	Yes	Yes	Yes	Yes	Yes	Yes	Neg.	3	1152X864	
	29	1152 X 864	85.2	75.7	XGA	Yes	Yes	Yes	Yes	Yes	Yes	Yes	Yes	Yes	Yes	Pos.	3	1152X864	
	30	1280 X 768	56.2	45.1	Wide-XGA	Yes	Yes	Yes	Yes	Yes	Yes	Yes	Yes	Yes	Yes	Pos.	3	1280X768	
IBM PC/AT Compatible Computers	31	1280 X 768	59.9	47.8	Wide-XGA	Yes	Yes	Yes	Yes	Yes	Yes	Yes	Yes	Yes	Yes	Neg.	3	1280X768	
	32	1280 X 768	69.8	56	Wide-XGA	Yes	Yes	Yes	Yes	Yes	Yes	Yes	Yes	Yes	Yes	Neg.	3	1280X768	
	33	1280 X 768	72	57.8	Wide-XGA	Yes	Yes	Yes	Yes	Yes	Yes	Yes	Yes	Yes	Yes	Neg.	3	1280X768	
	34	1280 X 768	59.8	49.7	Wide-XGA	Yes	Yes	Yes	Yes	Yes	Yes	Yes	Yes	Yes	Yes	Pos.	3	1280X768	
	35	1280 X 800	60	53.1	Wide-XGA	Yes	Yes	Yes	Yes	Yes	Yes	Yes	Yes	Yes	Yes	Pos.	3	1280X800	
	36	1280 X 854	60	60	Wide-XGA	Yes	Yes	Yes	Yes	Yes	Yes	Yes	Yes	Yes	Yes	Pos.	3	1280X854	
	37	1280 X 960	85	85.9	Wide-XGA	Yes	Yes	Yes	Yes	Yes	Yes	Yes	Yes	Yes	Yes	Pos.	3	1280X960	
	38	1360 X 768	60	47.7	Wide-XGA	Yes	Yes	Yes	Yes	Yes	Yes	Yes	Yes	Yes	Yes	Pos.	3	1360X768	
	39	1360 X 768	59.9	48.3	Wide-XGA	Yes	Yes	Yes	Yes	Yes	Yes	Yes	Yes	Yes	Yes	Neg.	3	1360X768	
	40	1376 X 768	60	48.3	Wide-XGA	Yes	Yes	Yes	Yes	Yes	Yes	Yes	Yes	Yes	Yes	Neg.	3	1376X768	
Apple Macintosh®	41	1280 X 1024	60	64	SXGA	Yes	Yes	Yes	Yes	Yes	Yes	Yes	Yes	Yes	Yes	Pos.	9	1280X1024	
	42	1280 X 1024	75	80	SXGA	Yes	Yes	Yes	Yes	Yes	Yes	Yes	Yes	Yes	Yes	Pos.	9	1280X1024	
	43	1280 X 1024	85	91.1	SXGA	Yes	Yes	Yes	Yes	Yes	Yes	Yes	Yes	Yes	Yes	Pos.	9	1280X1024	
	44	1280 X 1024	100.1	108.5	SXGA	Yes	Yes	Yes	Yes	Yes	Yes	Yes	Yes	Yes	Yes	Pos.	9	1280X1024	
	45	1400 X 1050	60	64	SXGA+	Yes	Yes	Yes	Yes	Yes	Yes	Yes	Yes	Yes	Yes	Neg.	9	1400X1050	
	46	1400 X 1050	60	65.3	SXGA+	Yes	Yes	Yes	Yes	Yes	Yes	Yes	Yes	Yes	Yes	Neg.	9	1400X1050	
	47	1400 X 1050	74.9	82.3	SXGA+	Yes	Yes	Yes	Yes	Yes	Yes	Yes	Yes	Yes	Yes	Neg.	9	1400X1050	
	48	1400 X 1050	85	93.9	SXGA+	Yes	Yes	Yes	Yes	Yes	Yes	Yes	Yes	Yes	Yes	Neg.	9	1400X1050	
	49	1680 X 1050	60	65.3	Wide-SXGA	Yes	Yes	Yes	Yes	Yes	Yes	Yes	Yes	Yes	Yes	Pos.	7	1680X1050	
	50	1600 X 1200	60	75	UXGA	Yes	Yes	Yes	Yes	Yes	Yes	Yes	Yes	Yes	Yes	Pos.	8	1600X1200	
Apple Macintosh®	51	1600 X 1200	65	81.3	UXGA	Yes	Yes	Yes	Yes	Yes	Yes	Yes	Yes	Yes	Yes	Pos.	8	1600X1200	
	52	1600 X 1200	70	87.5	UXGA	Yes	Yes	Yes	Yes	Yes	Yes	Yes	Yes	Yes	Yes	Pos.	8	1600X1200	
	53	1600 X 1200	75	93.8	UXGA	Yes	Yes	Yes	Yes	Yes	Yes	Yes	Yes	Yes	Yes	Pos.	8	1600X1200	
	54	1600 X 1200	85	106.3	UXGA	Yes	Yes	Yes	Yes	Yes	Yes	Yes	Yes	Yes	Yes	Pos.	8	1600X1200	
	55	1920 X 1080	50	56.2	Wide-UXGA	Yes	Yes	Yes	Yes	Yes	Yes	Yes	Yes	Yes	Yes	Pos.	8	1920X1080	
	56	1920 X 1080	60	67.5	Wide-UXGA	Yes	Yes	Yes	Yes	Yes	Yes	Yes	Yes	Yes	Yes	Pos.	8	1920X1080	
	57	1920 X 1200	59.9	74.6	Wide-UXGA	Yes	Yes	Yes	Yes	Yes	Yes	Yes	Yes	Yes	Yes	Neg.	8	1920X1200	
	58	1920 X 1200	60	74	Wide-UXGA	Yes	Yes	Yes	Yes	Yes	Yes	Yes	Yes	Yes	Yes	Neg.	8	1920X1200	
	59	1920 X 1200	66.7	81.3	Wide-UXGA	Yes	Yes	Yes	Yes	Yes	Yes	Yes	Yes	Yes	Yes	Pos.	8	1920X1200	
	60	1920 X 1200	74.6	93.8	Wide-UXGA	Yes	Yes	Yes	Yes	Yes	Yes	Yes	Yes	Yes	Yes	Pos.	8	1920X1200	
Apple Macintosh®	81	640 X 480	66.7	35	Mic13*	Yes	Yes	Yes	Yes	Yes	Yes	Yes	Yes	Yes	Yes	Sync on G	Sync on G	1	640X480
	82	640 X 480	74.6	49.7	Mic16*	Yes	Yes	Yes	Yes	Yes	Yes	Yes	Yes	Yes	Yes	Sync on G	Sync on G	1	640X480
	83	640 X 480	74.9	60.2	Mic19*	Yes	Yes	Yes	Yes	Yes	Yes	Yes	Yes	Yes	Yes	Sync on G	Sync on G	1	640X480
	84	640 X 480	75.1	68.7	Mic21*	Yes	Yes	Yes	Yes	Yes	Yes	Yes	Yes	Yes	Yes	Sync on G	Sync on G	1	640X480
	85	640 X 480	59.9	55.9	Apple17	Yes	Yes	Yes	Yes	Yes	Yes	Yes	Yes	Yes	Yes	Sync on G	Sync on G	1	640X480
	86	640 X 480	60	64.6	EWS4800	Yes	Yes	Yes	Yes	Yes	Yes	Yes	Yes	Yes	Yes	Neg.	1	640X480	
	87	640 X 480	71.2	75.1	HP	Yes	Yes	Yes	Yes	Yes	Yes	Yes	Yes	Yes	Yes	Neg.	1	640X480	
	88	640 X 480	72	78.1	SUN	Yes	Yes	Yes	Yes	Yes	Yes	Yes	Yes	Yes	Yes	Neg.	1	640X480	
	89	640 X 480	66	61.8	SUN	Yes	Yes	Yes	Yes	Yes	Yes	Yes	Yes	Yes	Yes	C-Sync	C-Sync	1	640X480
	90	640 X 480	76	71.7	SUN	Yes	Yes	Yes	Yes	Yes	Yes	Yes	Yes	Yes	Yes	C-Sync	C-Sync	1	640X480
Apple Macintosh®	91	640 X 480	76.1	81.1	SUN	Yes	Yes	Yes	Yes	Yes	Yes	Yes	Yes	Yes	Yes	C-Sync	C-Sync	1	640X480
	92	640 X 480	60	49.7	SUN	Yes	Yes	Yes	Yes	Yes	Yes	Yes	Yes	Yes	Yes	C-Sync	C-Sync	1	640X480
	93	640 X 480	60	49.7	SUN	Yes	Yes	Yes	Yes	Yes	Yes	Yes	Yes	Yes	Yes	C-Sync	C-Sync	1	640X480
	94	640 X 480	60	49.7	SUN	Yes	Yes	Yes	Yes	Yes	Yes	Yes	Yes	Yes	Yes	C-Sync	C-Sync	1	640X480
	95	640 X 480	60	49.7	SUN	Yes	Yes	Yes	Yes	Yes	Yes	Yes	Yes	Yes	Yes	C-Sync	C-Sync	1	640X480
	96	640 X 480	60	49.7	SUN	Yes	Yes	Yes	Yes	Yes	Yes	Yes	Yes	Yes	Yes	C-Sync	C-Sync	1	640X480

P60XP10 Supported Resolutions (Video)

Sig. no.	Resolution H X V	Specification of the signal		Analog SIZE				Digital SIZE				INPUT terminal	RGB select Item	Gr. No.	HD select Item		
		V freq. (Hz)	H freq. (kHz)	NORMAL (4:3)	FULL (16:9)	DYNAMIC ZOOM (non-linear)	14:9	2.35:1	UNDER SCAN	NORMAL (4:3)	FULL (16:9)					DYNAMIC ZOOM (non-linear)	14:9
Video Composite / S	101	3.58NTSC	59.9	15.8	Yes	Yes	Yes	Yes	Yes	Yes	Yes	Yes	Yes	Yes	Yes	Yes	
	102	4.43NTSC	59.9	15.8	Yes	Yes	Yes	Yes	Yes	Yes	Yes	Yes	Yes	Yes	Yes	Yes	
	103	PAL	50	15.6	Yes	Yes	Yes	Yes	Yes	Yes	Yes	Yes	Yes	Yes	Yes	Yes	Yes
	104	PAL60	59.9	15.8	Yes	Yes	Yes	Yes	Yes	Yes	Yes	Yes	Yes	Yes	Yes	Yes	Yes
	105	PAL-N	50	15.6	Yes	Yes	Yes	Yes	Yes	Yes	Yes	Yes	Yes	Yes	Yes	Yes	Yes
	106	PAL-M	59.9	15.8	Yes	Yes	Yes	Yes	Yes	Yes	Yes	Yes	Yes	Yes	Yes	Yes	Yes
	107	SECAM	50	15.6	Yes	Yes	Yes	Yes	Yes	Yes	Yes	Yes	Yes	Yes	Yes	Yes	Yes
	111	480i	59.9	15.8	Yes	Yes	Yes	Yes	Yes	Yes	Yes	Yes	Yes	Yes	Yes	Yes	Yes
	112	576i	50	15.6	Yes	Yes	Yes	Yes	Yes	Yes	Yes	Yes	Yes	Yes	Yes	Yes	Yes
	113	480P	59.9	31.5	Yes	Yes	Yes	Yes	Yes	Yes	Yes	Yes	Yes	Yes	Yes	Yes	Yes
114	576P	50	31.3	Yes	Yes	Yes	Yes	Yes	Yes	Yes	Yes	Yes	Yes	Yes	Yes	Yes	
115	720P	50	37.5	Yes	Yes	Yes	Yes	Yes	Yes	Yes	Yes	Yes	Yes	Yes	Yes	Yes	
116	720P	60	45	Yes	Yes	Yes	Yes	Yes	Yes	Yes	Yes	Yes	Yes	Yes	Yes	Yes	
117	1080i	50	28.1	Yes	Yes	Yes	Yes	Yes	Yes	Yes	Yes	Yes	Yes	Yes	Yes	Yes	
118	1080i	60	33.8	Yes	Yes	Yes	Yes	Yes	Yes	Yes	Yes	Yes	Yes	Yes	Yes	Yes	
119	1080P	50	56.3	Yes	Yes	Yes	Yes	Yes	Yes	Yes	Yes	Yes	Yes	Yes	Yes	Yes	
120	1080P	60	67.5	Yes	Yes	Yes	Yes	Yes	Yes	Yes	Yes	Yes	Yes	Yes	Yes	Yes	
121	1080P	60	33.8	Yes	Yes	Yes	Yes	Yes	Yes	Yes	Yes	Yes	Yes	Yes	Yes	Yes	
122	1080P	24	27	Yes	Yes	Yes	Yes	Yes	Yes	Yes	Yes	Yes	Yes	Yes	Yes	Yes	
123	1080P	25	28	Yes	Yes	Yes	Yes	Yes	Yes	Yes	Yes	Yes	Yes	Yes	Yes	Yes	
131	480i *4	59.9	15.8	Yes	Yes	Yes	Yes	Yes	Yes	Yes	Yes	Yes	Yes	Yes	Yes	Yes	
132	576i *4	50	15.6	Yes	Yes	Yes	Yes	Yes	Yes	Yes	Yes	Yes	Yes	Yes	Yes	Yes	
133	480P	59.9	31.5	Yes	Yes	Yes	Yes	Yes	Yes	Yes	Yes	Yes	Yes	Yes	Yes	Yes	
134	576P	50	31.3	Yes	Yes	Yes	Yes	Yes	Yes	Yes	Yes	Yes	Yes	Yes	Yes	Yes	
135	720P	50	37.5	Yes	Yes	Yes	Yes	Yes	Yes	Yes	Yes	Yes	Yes	Yes	Yes	Yes	
136	720P	60	45	Yes	Yes	Yes	Yes	Yes	Yes	Yes	Yes	Yes	Yes	Yes	Yes	Yes	
137	1080i	50	28.1	Yes	Yes	Yes	Yes	Yes	Yes	Yes	Yes	Yes	Yes	Yes	Yes	Yes	
138	1080i	60	33.8	Yes	Yes	Yes	Yes	Yes	Yes	Yes	Yes	Yes	Yes	Yes	Yes	Yes	
139	1080P	50	56.3	Yes	Yes	Yes	Yes	Yes	Yes	Yes	Yes	Yes	Yes	Yes	Yes	Yes	
140	1080P	60	67.5	Yes	Yes	Yes	Yes	Yes	Yes	Yes	Yes	Yes	Yes	Yes	Yes	Yes	
141	1080P	30	33.8	Yes	Yes	Yes	Yes	Yes	Yes	Yes	Yes	Yes	Yes	Yes	Yes	Yes	
142	1080P	24	27	Yes	Yes	Yes	Yes	Yes	Yes	Yes	Yes	Yes	Yes	Yes	Yes	Yes	
143	1080P	25	28	Yes	Yes	Yes	Yes	Yes	Yes	Yes	Yes	Yes	Yes	Yes	Yes	Yes	
144	1080A/540P	60	33.8	Yes	Yes	Yes	Yes	Yes	Yes	Yes	Yes	Yes	Yes	Yes	Yes	Yes	
161	640 X 480P	59.9 / 60.0	31.5 / 31.5	Yes	Yes	Yes	Yes	Yes	Yes	Yes	Yes	Yes	Yes	Yes	Yes	Yes	
162	720 (1440) X 480i	59.9 / 60.0	15.7 / 15.8	Yes	Yes	Yes	Yes	Yes	Yes	Yes	Yes	Yes	Yes	Yes	Yes	Yes	
163	720 X 480P	59.9 / 60.0	31.5 / 31.5	Yes	Yes	Yes	Yes	Yes	Yes	Yes	Yes	Yes	Yes	Yes	Yes	Yes	
164	720 (1440) X 576i	50	15.6	Yes	Yes	Yes	Yes	Yes	Yes	Yes	Yes	Yes	Yes	Yes	Yes	Yes	
165	720 X 576P	50	31.3	Yes	Yes	Yes	Yes	Yes	Yes	Yes	Yes	Yes	Yes	Yes	Yes	Yes	
166	1280 X 720P	59.9 / 60.0	45.0 / 45.0	Yes	Yes	Yes	Yes	Yes	Yes	Yes	Yes	Yes	Yes	Yes	Yes	Yes	
167	1920 X 1080i	59.9 / 60.0	33.7 / 33.8	Yes	Yes	Yes	Yes	Yes	Yes	Yes	Yes	Yes	Yes	Yes	Yes	Yes	
168	1920 X 1080P	59.9 / 60.0	67.4 / 67.5	Yes	Yes	Yes	Yes	Yes	Yes	Yes	Yes	Yes	Yes	Yes	Yes	Yes	
169	1280 X 720P	50	37.5	Yes	Yes	Yes	Yes	Yes	Yes	Yes	Yes	Yes	Yes	Yes	Yes	Yes	
170	1920 X 1080i	50	28.1	Yes	Yes	Yes	Yes	Yes	Yes	Yes	Yes	Yes	Yes	Yes	Yes	Yes	
171	1920 X 1080P	50	56.3	Yes	Yes	Yes	Yes	Yes	Yes	Yes	Yes	Yes	Yes	Yes	Yes	Yes	
172	1920 X 1080P	30	33.8	Yes	Yes	Yes	Yes	Yes	Yes	Yes	Yes	Yes	Yes	Yes	Yes	Yes	
173	1920 X 1080P	24	27	Yes	Yes	Yes	Yes	Yes	Yes	Yes	Yes	Yes	Yes	Yes	Yes	Yes	
174	1920 X 1080P	25	28	Yes	Yes	Yes	Yes	Yes	Yes	Yes	Yes	Yes	Yes	Yes	Yes	Yes	
191	Native Resolution	1366 X 768	60	47.3	Yes	Yes	Yes	Yes	Yes	Yes	Yes	Yes	Yes	Yes	Yes	Yes	
192	1024 X 768	60	47.3	Yes	Yes	Yes	Yes	Yes	Yes	Yes	Yes	Yes	Yes	Yes	Yes	Yes	
193	853 X 480	60	30	Yes	Yes	Yes	Yes	Yes	Yes	Yes	Yes	Yes	Yes	Yes	Yes	Yes	

...	NORMAL (4:3)	FULL (16:9)	(*)3	(*)4
Not Supported	1024 pixels x 768 lines	1866 pixels x 768 lines	Displayed by Underscan mode (100%)	SCART input available

Pin Assignment

1) Analog RGB Input (Mini D-SUB 15P) VGA

Pin No.	Name
1	Video Signal Red
2	Video Signal Green
3	Video Signal Blue
4	GND
5	DDC-GND
6	Red-GND
7	Green-GND
8	Blue-GND
9	+5V (DDC)
10	SYNC-GND
11	GND
12	DDC-SDA
13	H-SYNC
14	V-SYNC
15	DDC-SCL

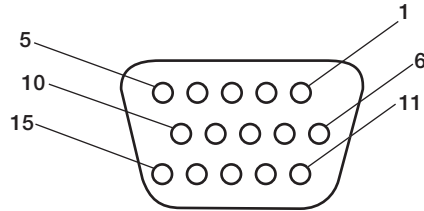

Mini D-SUB 15P

3) RS-232C Input (D-SUB 9P)

Pin No.	Name
1	Connected to 7 & 8
2	RXD
3	TXD
4	Connected to 6
5	GND
6	Connected to 4
7	Connected to 1 & 8
8	Connected to 1 & 7
9	NC

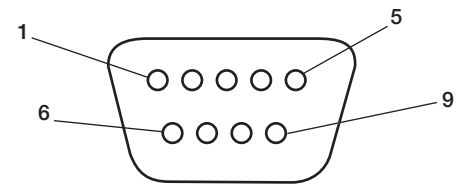

D-SUB 9P

2) Digital RGB Input (DVI-D) DVI

1	TX2-	9	TX1-	17	TX0-
2	TX2+	10	TX1+	18	TX0+
3	Shield (TX2/TX4)	11	Shield (TX1/TX3)	19	Shield (TXP/TX5)
4	NC	12	NC	20	NC
5	NC	13	NC	21	NC
6	DDC-Serial Clock	14	+5 power	22	Shield (TXC)
7	DDC-Serial Data	15	Ground (+5V)	23	TXC+
8	NC	16	Hot Plug Detect	24	TXC-

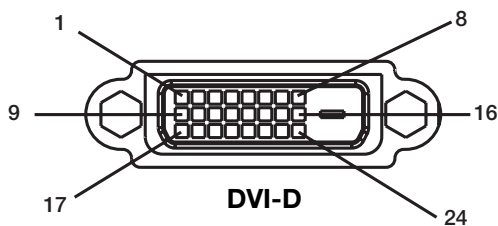

DVI-D

WEEE Mark (European Directive 2002/96/EC)

Within the European Union

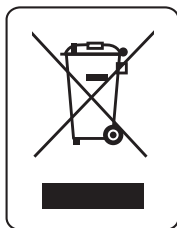

EU-wide legislation, as implemented in each Member State, requires that waste electrical and electronic products carrying the mark (left) must be disposed of separately from normal household waste. This includes monitors and electrical accessories, such as signal cables or power cords. When you need to dispose of your NEC display products, please follow the guidance of your local authority, or ask the shop where you purchased the product, or if applicable, follow any agreements made between yourself and NEC. The mark on electrical and electronic products only applies to the current European Union Member States.

The mark on electrical and electronic products only applies to the current European Union Member States.

Outside the European Union

If you wish to dispose of used electrical and electronic products outside the European Union, please contact your local authority so as to comply with the correct disposal method.

Declaration of the Manufacturer

We hereby certify that the color monitor
P426Y0, P506Y1 or P606Y2 is in compliance
with Council Directive 73/23/EEC:
– EN 60950-1

Council Directive 89/336/EEC:
– EN 55022
– EN 61000-3-2
– EN 61000-3-3
– EN 55024

and marked with



NEC Display Solutions Ltd.
4-13-23, Shibaura,
Minato-Ku
Tokyo 108-0023, Japan

DECLARATION OF CONFORMITY

This device complies with Part 15 of FCC Rules. Operation is subject to the following two conditions. (1) This device may not cause harmful interference, and (2) this device must accept any interference received, including interference that may cause undesired operation.

U.S. Responsible Party:	NEC Display Solutions of America, Inc.
Address:	500 Park Blvd. Suite 1100 Itasca, IL 60143
Tel. No.:	(630)467-3000

Type of Product:	Computer Monitor
Equipment Classification:	Class B Peripheral
Model:	PlasmaSync 42XP10 (P426Y0) PlasmaSync 50XP10 (P506Y1) PlasmaSync 60XP10 (P606Y2)



*We hereby declare that the equipment specified above
conforms to the technical standards as specified in the FCC Rules.*

Windows is a registered trademark of Microsoft Corporation. NEC is a registered trademark of NEC Corporation. All other brands and product names are trademarks or registered trademarks of their respective owners.