



## PLASMA TV OWNER'S MANUAL

42PG10	50PG10
42PG20	50PG20
42PG20C	50PG20C
50PG30	60PG30

Please read this manual carefully before operating your set.

Retain it for future reference.

Record model number and serial number of the set.

See the label attached on the back cover and quote this information to your dealer when you require service.

ENERGY STAR is a set of power-saving guidelines issued by the U.S. Environmental Protection Agency(EPA).



As an ENERGY STAR Partner LGE U. S. A.,Inc. has determined that this product meets the ENERGY STAR guidelines for energy efficiency.

P/NO : SAC30708031 (0802-REV01)



# WARNING / CAUTION



**WARNING / CAUTION**  
RISK OF ELECTRIC SHOCK  
DO NOT OPEN



**TO REDUCE THE RISK OF ELECTRIC SHOCK  
DO NOT REMOVE COVER (OR BACK). NO  
USER SERVICEABLE PARTS INSIDE. REFER TO  
QUALIFIED SERVICE PERSONNEL.**



The lightning flash with arrowhead symbol, within an equilateral triangle, is intended to alert the user to the presence of uninsulated “dangerous voltage” within the product’s enclosure that may be of sufficient magnitude to constitute a risk of electric shock to persons.



The exclamation point within an equilateral triangle is intended to alert the user to the presence of important operating and maintenance (servicing) instructions in the literature accompanying the appliance.

## WARNING/CAUTION

**TO REDUCE THE RISK OF FIRE AND ELECTRIC SHOCK, DO NOT EXPOSE THIS PRODUCT TO RAIN OR MOISTURE.**

## NOTE TO CABLE/TV INSTALLER

This reminder is provided to call the CATV system installer’s attention to Article 820-40 of the National Electric Code (U.S.A.). The code provides guidelines for proper grounding and, in particular, specifies that the cable ground shall be connected to the grounding system of the building, as close to the point of the cable entry as practical.

## WARNING / CAUTION

To prevent fire or shock hazards, do not expose this product to rain or moisture.

## FCC NOTICE

### Class B digital device

This equipment has been tested and found to comply with the limits for a Class B digital device, pursuant to Part 15 of the FCC Rules. These limits are designed to provide reasonable protection against harmful interference in a residential installation. This equipment generates, uses and can radiate radio frequency energy and, if not installed and used in accordance with the instructions, may cause harmful interference to radio communications. However, there is no guarantee that interference will not occur in a particular installation. If this equipment does cause harmful interference to radio or television reception, which can be determined by turning the equipment off and on, the user is encouraged to try to correct the interference by one or more of the following measures:

- Reorient or relocate the receiving antenna.
- Increase the separation between the equipment and receiver.
- Connect the equipment to an outlet on a circuit different from that to which the receiver is connected.
- Consult the dealer or an experienced radio/TV technician for help.

**Any changes or modifications not expressly approved by the party responsible for compliance could void the user’s authority to operate the equipment.**

## CAUTION

Do not attempt to modify this product in any way without written authorization from LG Electronics. Unauthorized modification could void the user’s authority to operate this product

# SAFETY INSTRUCTIONS

## IMPORTANT SAFETY INSTRUCTIONS

Important safety instructions shall be provided with each apparatus. This information shall be given in a separate booklet or sheet, or be located before any operating instructions in an instruction for installation for use and supplied with the apparatus.

This information shall be given in a language acceptable to the country where the apparatus is intended to be used. The important safety instructions shall be entitled “Important Safety Instructions”. The following safety instructions shall be included where applicable, and, when used, shall be verbatim as follows. Additional safety information may be included by adding statements after the end of the following safety instruction list. At the manufacturer’s option, a picture or drawing that illustrates the intent of a specific safety instruction may be placed immediately adjacent to that safety instruction:

**Read these instructions.**  
**Keep these instructions.**  
**Heed all warnings.**  
**Follow all instructions.**



**1** Do not use this apparatus near water.

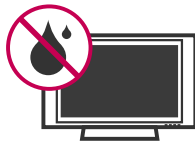

**2** Clean only with dry cloth.



**3** Do not block any ventilation openings. Install in accordance with the manufacturer’s instructions.



**4** Do not install near any heat sources such as radiators, heat registers, stoves, or other apparatus (including amplifiers) that produce heat.



**5** When mounting a TV it on the wall, make sure not to install TV by the hanging power and signal cables on the back of the TV.

**6** Do not defeat the safety purpose of the polarized or grounding-type plug. A polarized plug has two blades with one wider than the other. A grounding type plug has two blades and a third grounding prong. The wide blade or the third prong are provided for your safety. If the provided plug does not fit into your outlet, consult an electrician for replacement of the obsolete outlet.



**7** Protect the power cord from being walked on or pinched particularly at plugs, convenience receptacles, and the point where they exit from the apparatus.



**8** Only use attachments/accessories specified by the manufacturer.



**9** Unplug this apparatus when unused for long periods of time.

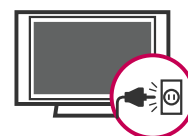

- 10** Use only with the cart, stand, tripod, bracket, or table specified by the manufacturer, or sold with the apparatus. When a cart is used, use caution when moving the cart/apparatus combination to avoid injury from tip-over.



- 11** Never touch this apparatus or antenna during a thunder or lightning storm.

- 12** Do not allow a impact shock or any objects to fall into the product, and do not drop onto the screen with something.

- 13** Refer all servicing to qualified service personnel. Servicing is required when the apparatus has been damaged in any way, such as power-supply cord or plug is damaged, liquid has been spilled or objects have fallen into the apparatus, the apparatus has exposed to rain or moisture, does not operate normally, or has been dropped.

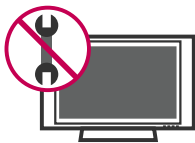

- 14** CAUTION concerning the Power Cord : Most appliances recommend they be placed upon a dedicated circuit; that is, a single outlet circuit which powers only that appliance and has no additional outlets or branch circuits. Check the specification page of this owner's manual to be certain.

Do not overload wall outlets. Overloaded wall outlets, loose or damaged wall outlets, extension cords, frayed power cords, or damaged or cracked wire insulation are dangerous. Any of these conditions could result in electric shock or fire. Periodically examine the cord of your appliance, and if its appearance indicates damage or deterioration, unplug it, discontinue use

of the appliance, and have the cord replaced with an exact replacement part by an authorized servicer. Protect the power cord from physical or mechanical abuse, such as being twisted, kinked, pinched, closed in a door, or walked upon. Pay particular attention to plugs, wall outlets, and the point where the cord exits the appliance.



- 15** Outdoor use marking :  
WARNING - To reduce the risk of fire or electric shock, do not expose this appliance to rain or moisture.



- 16** Wet Location Marking : Apparatus shall not be exposed to dripping or splashing and no objects filled with liquids, such as vases, shall be placed on or over apparatus.



## **17** GROUNDING

Ensure that you connect the earth ground wire to prevent possible electric shock. If grounding methods are not possible, have a qualified electrician install a separate circuit breaker.

Do not try to ground the unit by connecting it to telephone wires, lightening rods, or gas pipes.

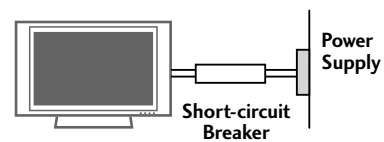

- 18** DISCONNECTING DEVICE FROM MAINS  
Mains plug is the disconnecting device. The plug must remain readily operable.

# CONTENTS

<b>WARNING / CAUTION</b> .....	1
<b>SAFETY INSTRUCTIONS</b> .....	2
<b>FEATURE OF THIS TV</b> .....	6

## PREPARATION

Accessories .....	7
Front Panel Information .....	8
Back Panel Information .....	9
Stand Installation .....	10
Cable Management .....	11
Desktop Pedestal Installation .....	12
Swivel Stand .....	12
VESA Wall Mounting .....	13
Protection Cover .....	13
Securing the TV to the wall to prevent falling ....	14
Antenna or Cable Connection .....	15

## EXTERNAL EQUIPMENT SETUP

HD Receiver Setup .....	16
DVD Setup .....	19
VCR Setup .....	21
Other A/V Source Setup .....	23
Audio Out Connection .....	23
PC Setup .....	24

## WATCHING TV / CHANNEL CONTROL

Remote Control Functions .....	30
Turning On TV .....	32
Channel Selection .....	32
Volume Adjustment .....	32
Initial Setting .....	33
Quick Menu .....	34
On-Screen Menus Selection .....	35
Channel Setup	
- Auto Scan (Auto Tuning) .....	36
- Add / Delete Channel (Manual Tuning) .....	37
- Channel Editing .....	38

Input List .....	39
Input Label .....	40
AV Mode .....	41
SIMPLINK .....	42

## PICTURE CONTROL

Picture Size (Aspect Ratio) Control .....	44
Preset Picture Settings	
- Picture Mode - Preset .....	46
- Color Tone - Preset .....	47
Manual Picture Adjustment	
- Picture Mode - User Mode .....	48
- Picture Mode - Expert Control .....	49
Picture Improvement Technology .....	50
Advanced Control - Black (Darkness) Level .....	51
Advanced Control - Film Mode .....	52
Picture Reset .....	53
Image Sticking Minimization (ISM) Method .....	54
Power Saving Picture Mode .....	55

## SOUND & LANGUAGE CONTROL

Auto Volume Leveler (Auto Volume) .....	56
Clear Voice .....	57
Preset Sound Setting (Sound Mode) .....	58
Sound Setting Adjustment - User Mode .....	59
Balance .....	60
TV Speakers On/Off Setup .....	61
Audio Reset .....	62
Stereo/SAP Broadcasts Setup .....	63
Audio Language .....	64
On-Screen Menus Language Selection .....	65
Caption Mode	
- Analog Broadcasting System Captions .....	66
- Digital Broadcasting System Captions .....	67
- Caption Option .....	68

## TIME SETTING

Clock Setting	
- Auto Clock Setup .....	69
- Manual Clock Setup .....	70
Auto On/Off Time Setting .....	71
Sleep Timer Setting .....	72
Auto Shut-off Setting .....	73

## PARENTAL CONTROL / RATINGS

Set Password & Lock System .....	74
Channel Blocking .....	77
Movie & TV Rating .....	78
Downloadable Rating .....	83
External Input Blocking .....	84
Key lock .....	85

## APPENDIX

Troubleshooting .....	86
Maintenance .....	88
Product Specifications .....	88
IR Codes .....	90
External Control Through RS-232C .....	92

# FEATURE OF THIS TV



**SRS** is a trademark of SRS Labs, Inc.  
TruSurround XT technology is incorporated under license from SRS Labs, Inc.



Manufactured under license from Dolby Laboratories.  
"Dolby" and the double-D symbol are trademarks of Dolby Laboratories.



# PREPARATION

## ACCESSORIES

Ensure that the following accessories are included with your TV. If an accessory is missing, please contact the dealer where you purchased the TV.

The accessories included may differ from the images below.

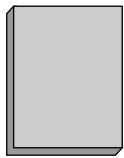

Owner's Manual



CD Manual

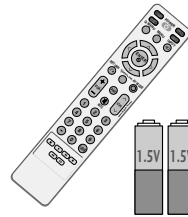

Remote Control,  
Batteries

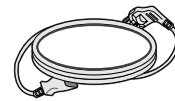

Power Cord

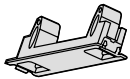

Protection Cover  
(Refer to P.13)

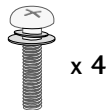

Bolts for stand assembly  
(Refer to P.10)  
(Only 42PG10/20/20C)



Cable Holder  
42PG10/20/20C: 1 EA,  
50PG10/20/20C: 2EA

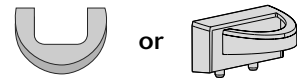

Cable Management Clip

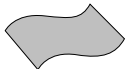

**Polishing Cloth**  
(This feature is not available  
for all models.)

- \* Wipe spots on the exterior only with the polishing cloth.
- \* Do not wipe roughly when removing stain. Please be cautious of that excessive pressure may cause scratch or discoloration.

### Option Extras

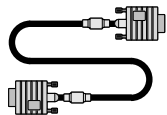

D-sub 15 pin Cable

When using the VGA (D-sub 15 pin cable) PC connection, the user must use shielded signal interface cables with ferrite cores to maintain standards compliance.

# PREPARATION

## FRONT PANEL INFORMATION

- Image shown may differ from your TV.
- NOTE:** If your TV has a protection tape attached, remove the tape. And then wipe the TV with a cloth (If a polishing cloth is included with your TV, use it).

### 42/50PG10

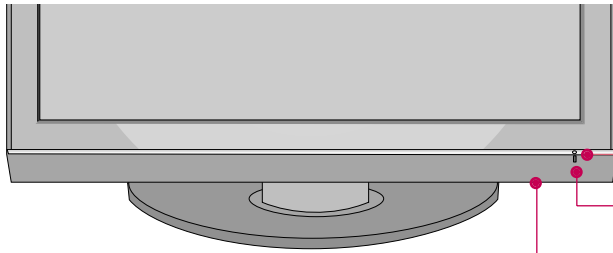

Remote Control Sensor

Power/Standby Indicator

Illuminates red in standby mode.

Illuminates blue when the TV is switched on.

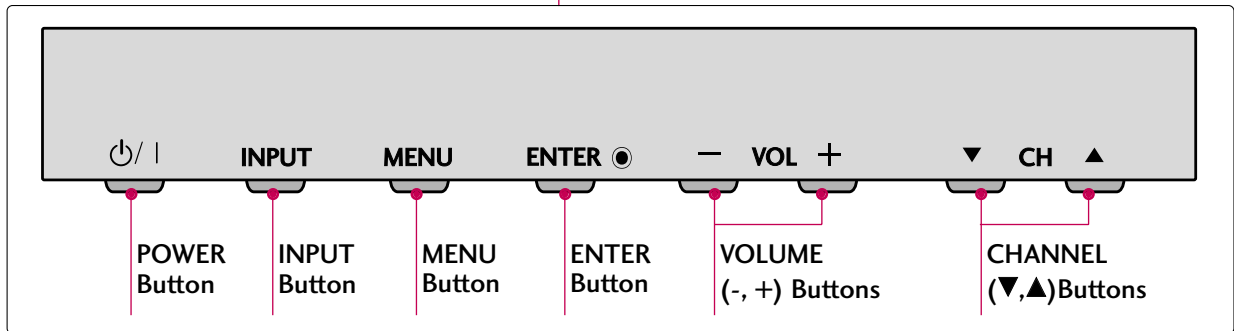

### 42/50PG20/20C, 50/60PG30

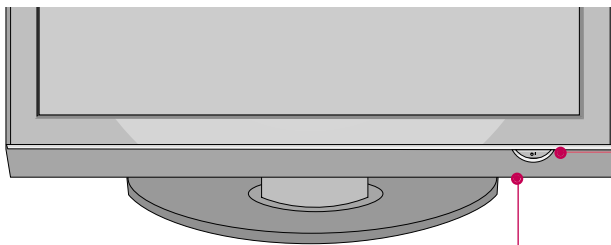

Remote Control Sensor

POWER Button

Power/Standby Indicator

Illuminates red in standby mode.

Illuminates blue when the TV is switched on.

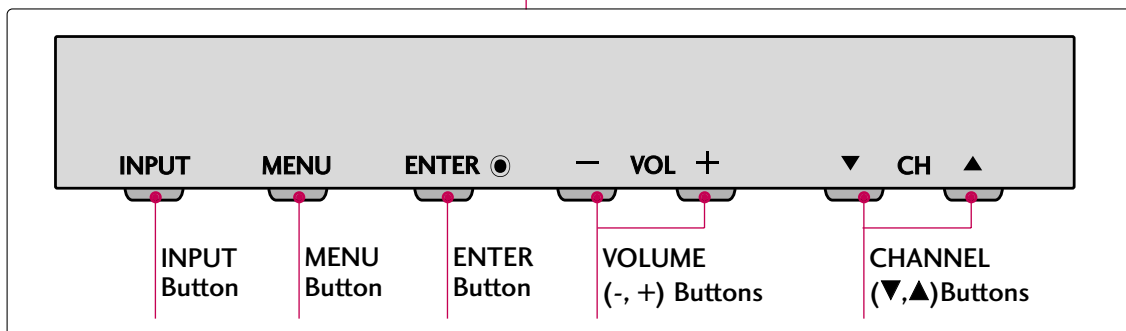

# BACK PANEL INFORMATION

■ Image shown may differ from your TV.

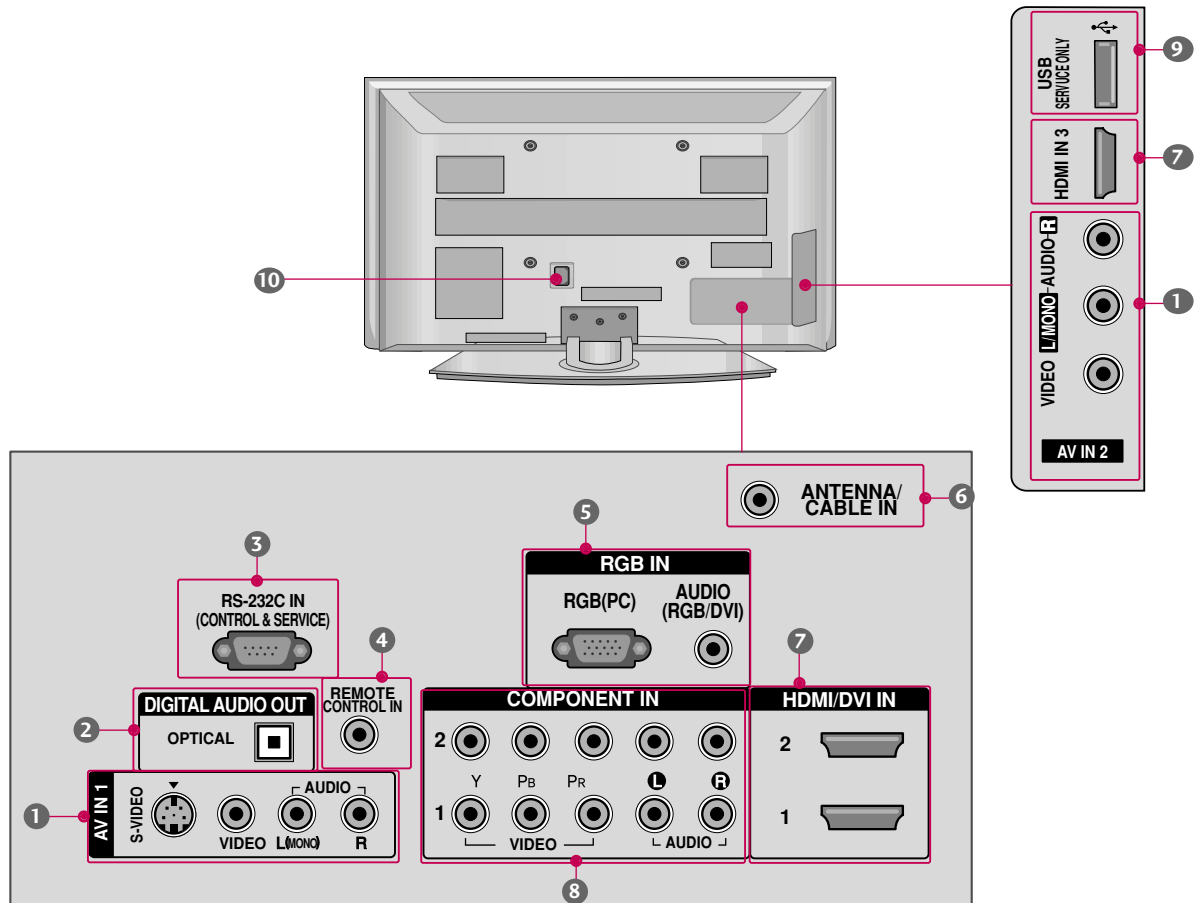

- 1 AV (Audio/Video) IN**  
Analog composite connection. Supports standard definition video only (480i).  
**S-VIDEO**  
Better quality than standard composition. Supports standard definition video only (480i).
- 2 DIGITAL AUDIO OUT**  
Digital audio output for use with amps and home theater systems.  
Includes an optical connection.  
Note: In standby mode, this port do not work.
- 3 RS-232C IN (CONTROL & SERVICE) PORT**  
Used by third party devices.
- 4 REMOTE CONTROL PORT**  
For a wired remote control.
- 5 RGB (PC)**  
Analog PC Connection. Uses a D-sub 15 pin cable (VGA cable).  
**AUDIO (RGB/DVI)**  
1/8" headphone jack for analog PC audio input.
- 6 ANTENNA/CABLE IN**  
Connect over-the air signals to this jack.  
Connect cable signals to this jack.
- 7 HDMI/DVI IN, HDMI IN**  
Digital Connection. Supports HD video and Digital audio. Doesn't support 480i.  
Accepts DVI video using an adapter or HDMI to DVI cable (not included)
- 8 COMPONENT IN**  
Analog Connection. Supports HD.  
Uses a red, green, and blue cable for video & red and white for audio.
- 9 USB SERVICE ONLY**  
Used for software updates.
- 10 Power Cord Socket**  
For operation with AC power.  
Caution: Never attempt to operate the TV on DC power.

# PREPARATION

## STAND INSTALLATION (Only 42PG10/20/20C)

■ Image shown may differ from your TV.

- 1 Carefully place the TV screen side down on a cushioned surface to protect the screen from damage.

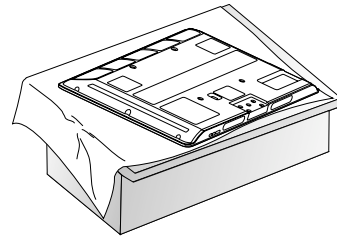

- 2 Assemble the TV as shown.

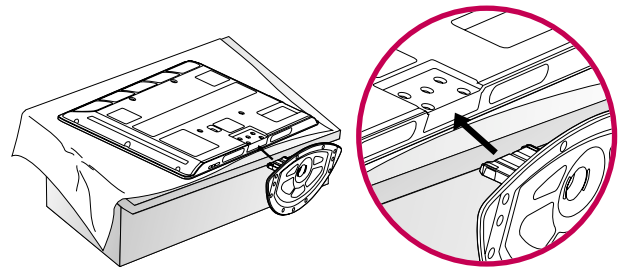

- 3 Fix the 4 bolts securely using the holes in the back of the TV.

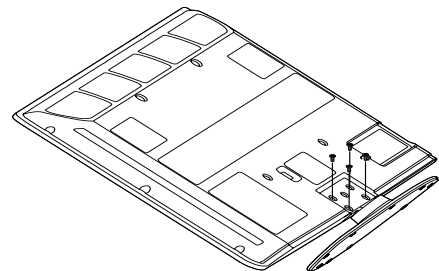

# CABLE MANAGEMENT

Image shown may differ from your TV.

- 1 Connect the cables as necessary.  
To connect additional equipment, see the **EXTERNAL EQUIPMENT SETUP** section.

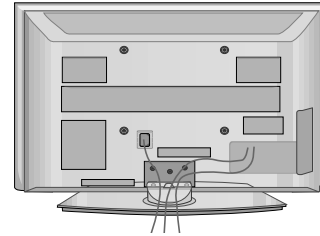

- 2 Install the **CABLE MANAGEMENT CLIP** as shown.  
If your TV has the **CABLE HOLDER**, install it as shown and bundle the cables.

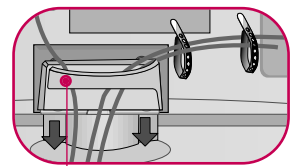
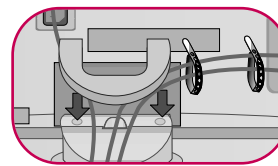
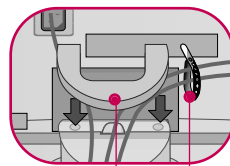
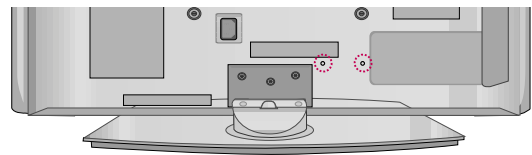

CABLE HOLDER

CABLE MANAGEMENT CLIP

CABLE MANAGEMENT CLIP

## How to remove the CABLE MANAGEMENT CLIP

### 42PG10/20/20C

- ▶ First, press the cable management. Hold the **CABLE MANAGEMENT CLIP** with both hands and pull it upward.

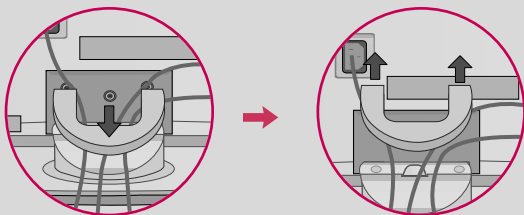

### 50PG10/20/20C, 50/60PG30

- ▶ Hold the **CABLE MANAGEMENT CLIP** with both hands and pull it upward.

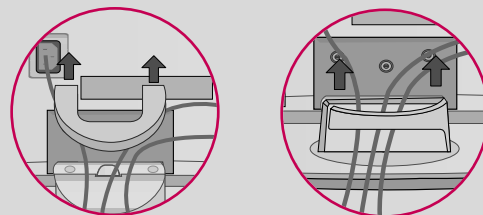

### ! NOTE

- ▶ Do not hold the **CABLE MANAGEMENT CLIP** when moving the TV.  
- If the TV is dropped, you may be injured or the TV may be broken.

# PREPARATION

## DESKTOP PEDESTAL INSTALLATION

- Image shown may differ from your TV.

For proper ventilation, allow a clearance of 4 inches on all four sides from the wall.

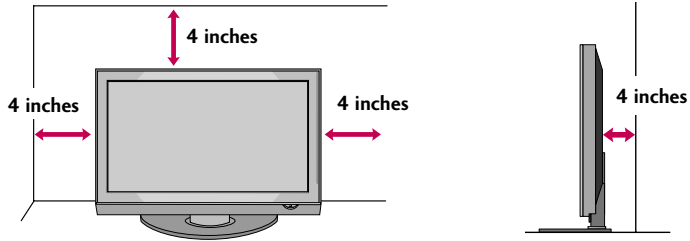

**CAUTION** ▶ Ensure adequate ventilation by following the clearance recommendations.

## SWIVEL STAND (Only 50/60PG30)

After installing the TV, you can adjust the TV manually to the left or right direction by 20 degrees to suit your viewing position.

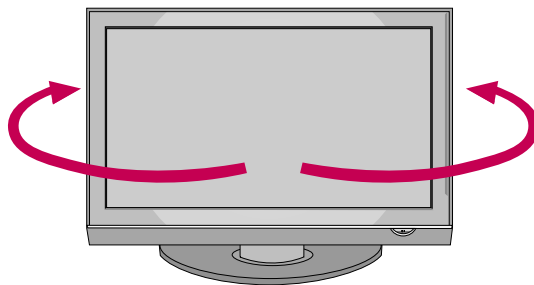

## VESA WALL MOUNTING

This TV accepts VESA FDMI compliant mounts via the four screw holes on the back of the TV. These mounts are sold by third parties and not available from LG. Refer to the instructions included with the mount for more info.

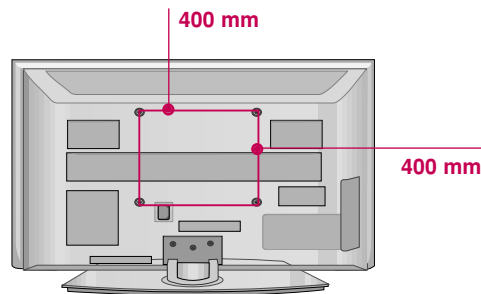

### ! NOTE

- ▶ Screw length needed depends on the wall mount used. For further information, refer to the instructions included with the mount.

## PROTECTION COVER

- Image shown may differ from your TV.

You can remove the stand before installing the TV on a wall mount by performing the previous stand instructions in reverse. After removing the stand, install the included **protection cover** over the hole for the stand.

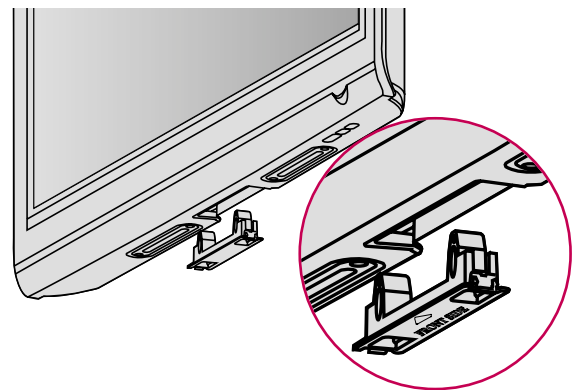

# PREPARATION

## SECURING THE TV TO THE WALL TO PREVENT FALLING

- You should purchase necessary components to prevent TV from falling off of the stand.
- Image shown may differ from your TV.

We recommend that you set up the TV close to a wall so it cannot fall over if pushed backwards. Additionally, we recommend that the TV be attached to a wall so it cannot be pulled in a forward direction, potentially causing injury or damaging the product.

Caution: Please make sure that children don't climb on or hang from the TV.

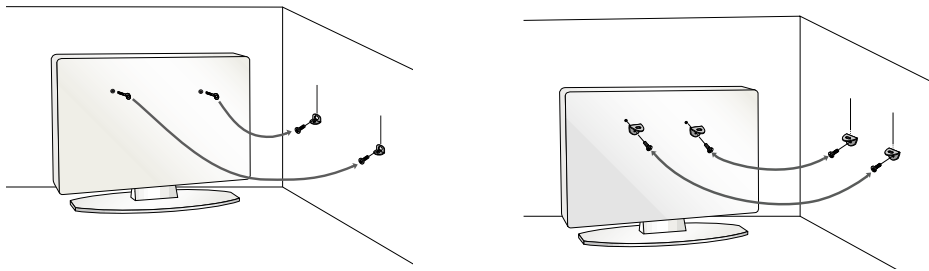

- Insert the eye-bolts (or TV brackets and bolts) to tighten the product to the wall as shown in the picture.

\* If your product has the bolts in the eye-bolts position before inserting the eye-bolts, loosen the bolts.

\* Insert the eye-bolts or TV brackets/bolts and tighten them securely in the upper holes.

Secure the wall brackets with the bolts (not provided as parts of the product, must purchase separately) to the wall. Match the height of the bracket that is mounted on the wall to the holes in the product.

Ensure the eye-bolts or brackets are tightened securely.

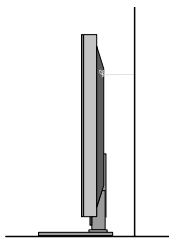

- Use a sturdy rope (not provided as parts of the product, must purchase separately) to tie the product. It is safer to tie the rope so it becomes horizontal between the wall and the product.

### ! NOTE

- ▶ Use a platform or cabinet strong enough and large enough to support the size and weight of the TV.
- ▶ To use the TV safely, make sure that the height of the bracket on the wall and the one on the TV are the same.



- To prevent damage do not connect to the power outlet until all connections are made between the devices.

## ANTENNA OR CABLE CONNECTION

### 1. Antenna (Analog or Digital)

Wall Antenna Socket or Outdoor Antenna without a Cable Box Connection.

For optimum picture quality, adjust antenna direction if needed.

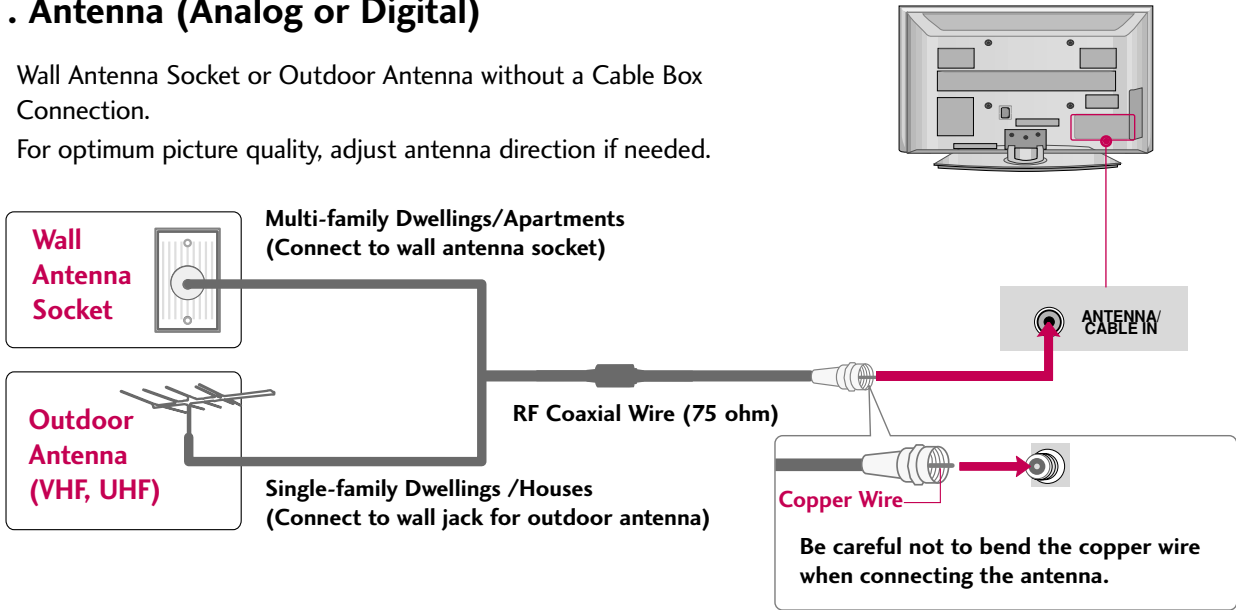

### 2. Cable

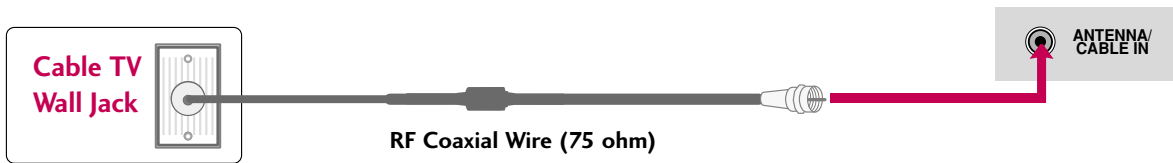

- To improve the picture quality in a poor signal area, please purchase a signal amplifier and install properly.
- If the antenna needs to be split for two TV's, install a 2-Way Signal Splitter.
- If the antenna is not installed properly, contact your dealer for assistance.



# EXTERNAL EQUIPMENT SETUP

- To prevent the equipment damage, never plug in any power cords until you have finished connecting all equipment.

## HD RECEIVER SETUP

This TV can receive Digital Over-the-air/Cable signals without an external digital set-top box. However, if you do receive digital signals from a digital set-top box or other digital external device, refer to the figure as shown below.

### Component Connection

#### 1. How to connect

- 1 Connect the video outputs (Y, PB, PR) of the digital set-top box to the **COMPONENT IN VIDEO 1** jacks on the TV. Match the jack colors (Y = green, PB = blue, and PR = red).
- 2 Connect the audio output of the digital set-top box to the **COMPONENT IN AUDIO 1** jacks on the TV.

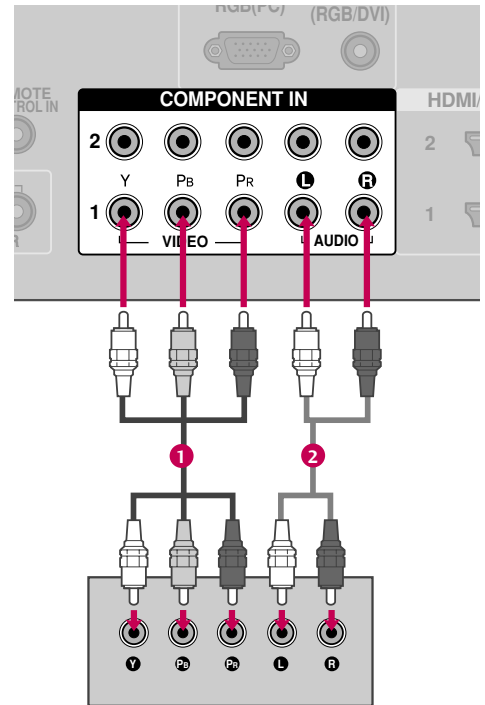

#### 2. How to use

- Turn on the digital set-top box.  
(Refer to the owner's manual for the digital set-top box operation)
- Select the **Component 1** input source on the TV using the **INPUT** button on the remote control.
- If connected to **COMPONENT IN2** input, select the **Component 2** input source on the TV.

#### Supported Resolutions

Signal	Component	HDMI
480i	Yes	No
480p	Yes	Yes
720p	Yes	Yes
1080i	Yes	Yes
1080p	Yes	Yes

#### Y, CB/PB, CR/PR

Resolution	Horizontal Frequency(KHz)	Vertical Frequency(Hz)
720x480i	15.73	59.94
	15.73	60.00
720x480p	31.47	59.94
	31.50	60.00
1280x720p	44.96	59.94
	45.00	60.00
1920x1080i	33.72	59.94
	33.75	60.00
1920x1080p	27.00	24.00
	33.75	30.00
	67.43	59.94
	67.50	60.00

## HDMI Connection

### 1. How to connect

- 1 Connect the digital set-top box to **HDMI/DVI IN1**, **2**, or **HDMI IN3** jack on the TV.
- 2 No separate audio connection is necessary. HDMI supports both audio and video.

### 2. How to use

- Turn on the digital set-top box.  
(Refer to the owner's manual for the digital set-top box.)
- Select the **HDMI1**, **HDMI2**, or **HDMI3** input source on the TV using the **INPUT** button on the remote control.

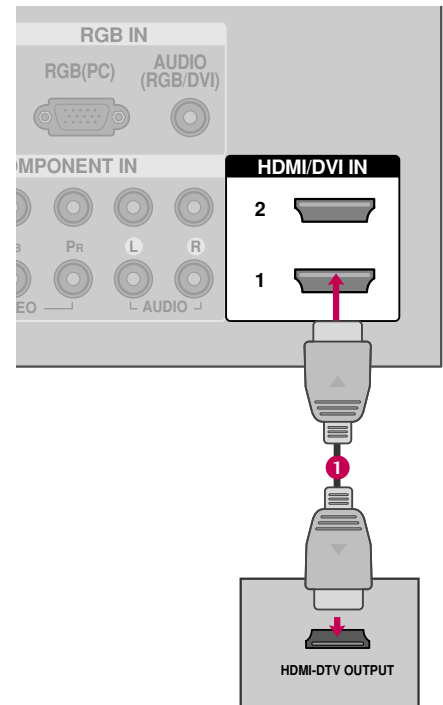

#### HDMI-DTV

Resolution	Horizontal Frequency(KHz)	Vertical Frequency(Hz)
720x480p	31.469	59.94
	31.50	60.00
1280x720p	44.96	59.94
	45.00	60.00
1920x1080i	33.72	59.94
	33.75	60.00
1920x1080p	27.00	24.00
	33.75	30.00
	67.43	59.94
	67.50	60.00

# EXTERNAL EQUIPMENT SETUP

## DVI to HDMI Connection

### 1. How to connect

- 1 Connect the DVI output of the digital set-top box to the **HDMI/DVI IN1**, **2**, or **HDMI IN3** jack on the TV.
- 2 Connect the audio output of the digital set-top box to the **AUDIO (RGB/DVI)** jack on the TV.

### 2. How to use

- Turn on the digital set-top box. (Refer to the owner's manual for the digital set-top box.)
- Select the **HDMI1**, **HDMI2**, or **HDMI3** input source on the TV using the **INPUT** button on the remote control.

#### ! NOTE

- ▶ A DVI to HDMI cable or adapter is required for this connection. DVI doesn't support audio, so a separate audio connection is necessary.

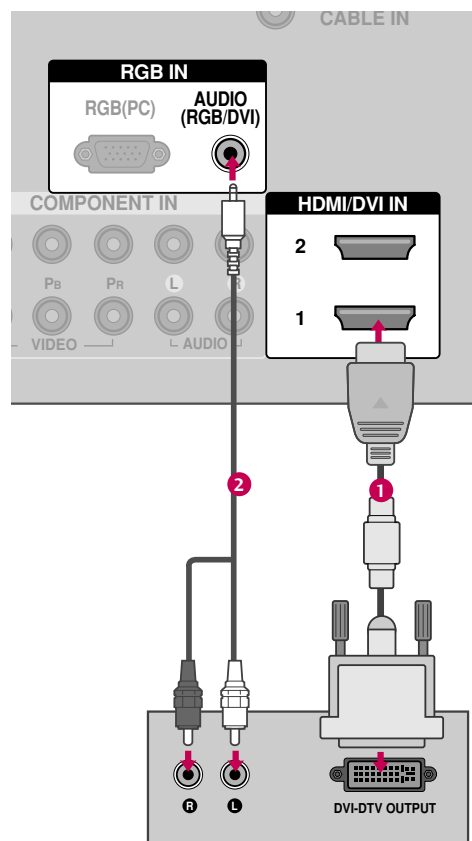

# DVD SETUP

## Component Connection

### 1. How to connect

- 1 Connect the video outputs (Y, PB, PR) of the DVD to the **COMPONENT IN VIDEO1** jacks on the TV. Match the jack colors (Y = green, PB = blue, and PR = red).

---

- 2 Connect the audio outputs of the DVD to the **COMPONENT IN AUDIO1** jacks on the TV.

### 2. How to use

- Turn on the DVD player, insert a DVD.
- Select the **Component 1** input source on the TV using the **INPUT** button on the remote control.
- If connected to **COMPONENT IN 2** input, select the **Component 2** input source on the TV.
- Refer to the DVD player's manual for operating instructions.

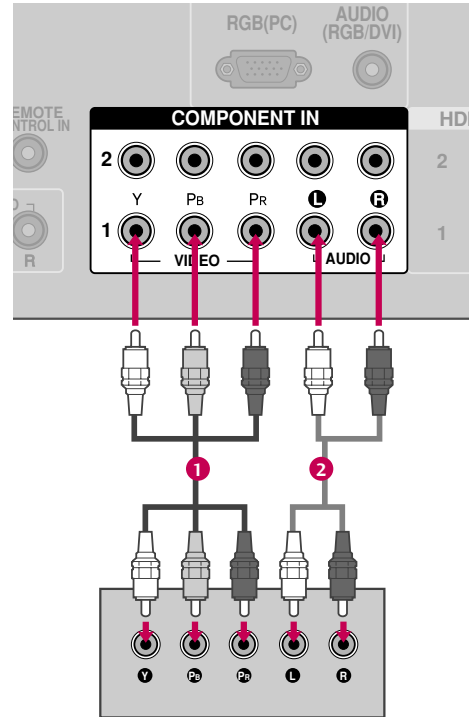

### Component Input ports

To get better picture quality, connect a DVD player to the component input ports as shown below.

Component ports on the TV	Y	P <sub>B</sub>	P <sub>R</sub>
Video output ports on DVD player	Y	P <sub>B</sub>	P <sub>R</sub>
	Y	B-Y	R-Y
	Y	C <sub>b</sub>	C <sub>r</sub>
	Y	P <sub>b</sub>	P <sub>r</sub>

# EXTERNAL EQUIPMENT SETUP

## S-Video Connection

### 1. How to connect

- 1 Connect the S-VIDEO output of the DVD to the S-VIDEO input on the TV.
- 2 Connect the audio outputs of the DVD to the AUDIO input jacks on the TV.

### 2. How to use

- Turn on the DVD player, insert a DVD.
- Select the **AV1** input source on the TV using the **INPUT** button on the remote control.
- Refer to the DVD player's manual for operating instructions.

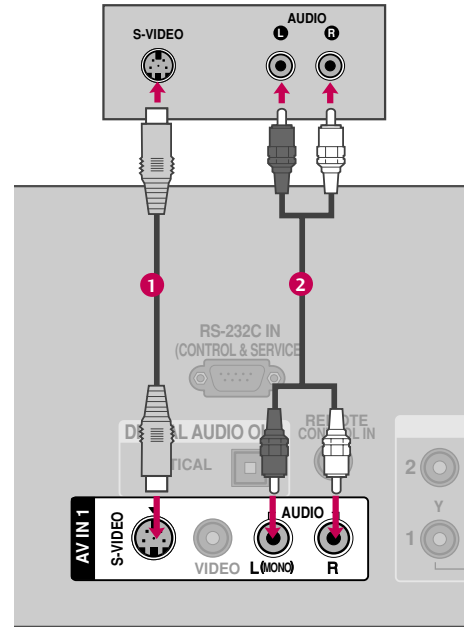

## HDMI Connection

### 1. How to connect

- 1 Connect the HDMI output of the DVD to the HDMI/DVI IN1, 2, or HDMI IN3 jack on the TV.
- 2 No separate audio connection is necessary. HDMI supports both audio and video.

### 2. How to use

- Select the **HDMI1**, **HDMI2**, or **HDMI3** input source on the TV using the **INPUT** button on the remote control.
- Refer to the DVD player's manual for operating instructions.

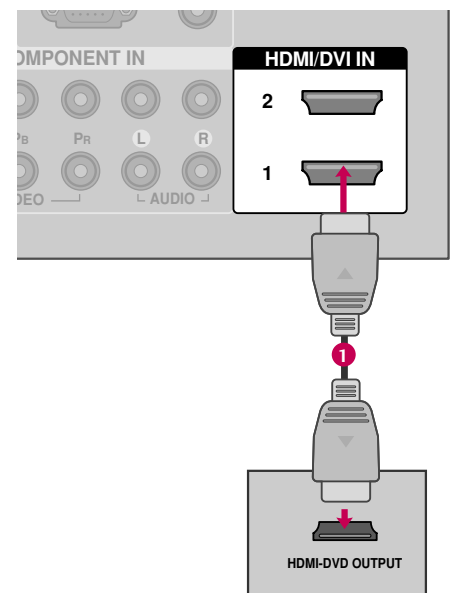

## VCR SETUP

- To avoid picture noise (interference), leave an adequate distance between the VCR and TV.
- Use the ISM feature in the Option menu to avoid having a fixed image remain on the screen for a long period of time. If the 4:3 picture format is used; the fixed images on the sides of the screen may remain visible on the screen. This phenomenon is common to all TVs and is not covered by warranty.

### Antenna Connection

#### 1. How to connect

- 1 Connect the RF antenna out socket of the VCR to the **ANTENNA/CABLE IN** socket on the TV.
- 2 Connect the antenna cable to the RF antenna in socket of the VCR.

#### 2. How to use

- Set VCR output switch to 3 or 4 and then tune TV to the same channel number.
- Insert a video tape into the VCR and press PLAY on the VCR. (Refer to the VCR owner's manual.)

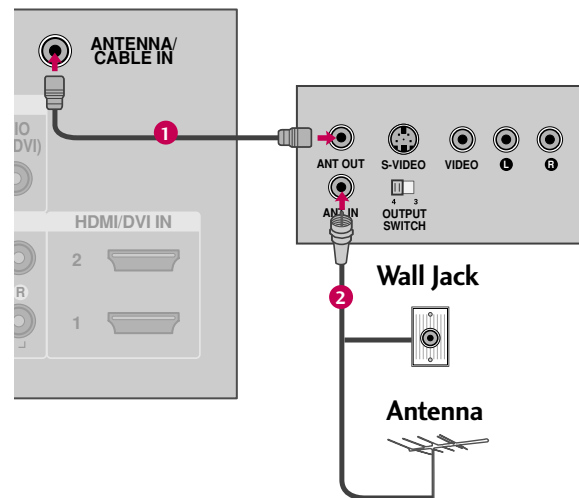

# EXTERNAL EQUIPMENT SETUP

## Composite (RCA) Connection

### 1. How to connect

- 1 Connect the **AUDIO/VIDEO** jacks between TV and VCR. Match the jack colors (Video = yellow, Audio Left = white, and Audio Right = red)

### 2. How to use

- Insert a video tape into the VCR and press PLAY on the VCR. (Refer to the VCR owner's manual.)
- Select the **AV1** input source on the TV using the **INPUT** button on the remote control.
- If connected to **AV IN2**, select **AV2** input source on the TV.

#### NOTE

- ▶ If you have a mono VCR, connect the audio cable from the VCR to the **AUDIO L/MONO** jack of the TV.

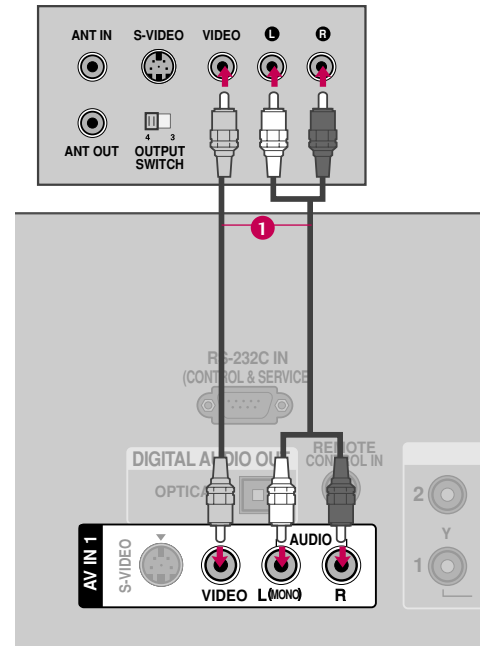

## S-Video Connection

### 1. How to connect

- 1 Connect the S-VIDEO output of the VCR to the S-VIDEO input on the TV.
- 2 Connect the audio outputs of the VCR to the **AUDIO** input jacks on the TV.

### 2. How to use

- Insert a video tape into the VCR and press PLAY on the VCR. (Refer to the VCR owner's manual.)
- Select the **AV1** input source on the TV using the **INPUT** button on the remote control.

#### NOTE

- ▶ S-Video provides better quality than composite. Use it when available.

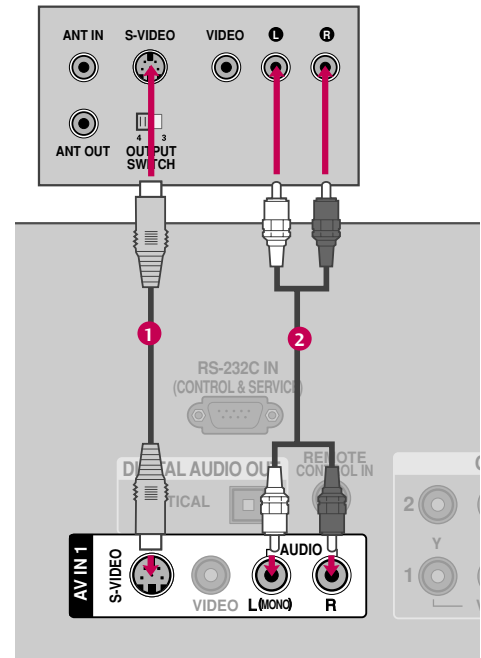

#### CAUTION

- ▶ Do not connect to both Video and S-Video at the same time. In the event that you connect both Video and the S-Video cables, only the S-Video will work.



## OTHER A/V SOURCE SETUP

### 1. How to connect

- 1 Connect the **AUDIO/VIDEO** jacks between TV and external equipment. Match the jack colors. (Video = yellow, Audio Left = white, and Audio Right = red)

### 2. How to use

- Select the **AV2** input source on the TV using the **INPUT** button on the remote control.
- If connected to **AV IN1** input, select the **AV1** input source on the TV.
- Operate the corresponding external equipment.

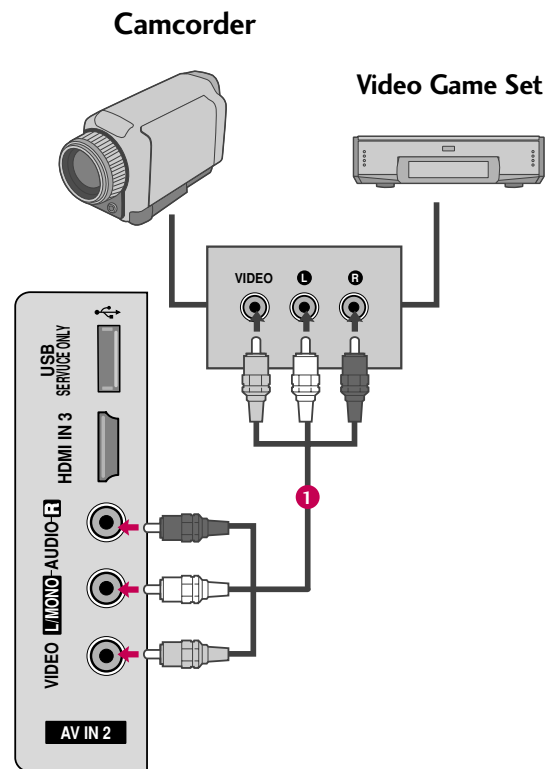

## AUDIO OUT CONNECTION

Send the TV's audio to external audio equipment via the Audio Output port.

### 1. How to connect

- 1 Connect one end of the optical cable to the TV's **OPTICAL** port of **DIGITAL AUDIO OUT**.
- 2 Connect the other end of the optical cable to the digital audio input on the audio equipment.
- 3 Set the "TV Speaker option - Off" in the AUDIO menu. (▶ p.61). See the external audio equipment instruction manual for operation.

#### NOTE

- ▶ When connecting with external audio equipments, such as amplifiers or speakers, you can turn the TV speakers off in the menu. (▶ p.61)

#### CAUTION

- ▶ Do not look into the optical output port. Looking at the laser beam may damage your vision.
- ▶ Block the SPDIF out (optical) about the contents with ACP (Audio Copy Protection) function.

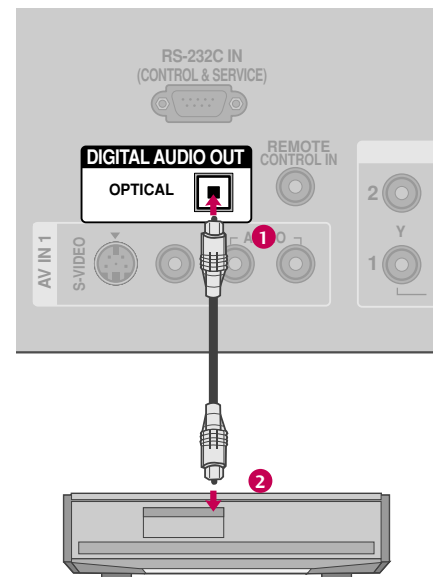

# EXTERNAL EQUIPMENT SETUP

## PC SETUP

This TV provides Plug and Play capability, meaning that the PC adjusts automatically to the TV's settings.

### VGA (D-Sub 15 pin) Connection

#### 1. How to connect

- 1 Connect the VGA output of the PC to the **RGB (PC)** jack on the TV.
- 2 Connect the PC audio output to the **AUDIO (RGB/DVI)** jack on the TV.

#### 2. How to use

- Turn on the PC and the TV.
- Select the **RGB-PC** input source on the TV using the **INPUT** button on the remote control.

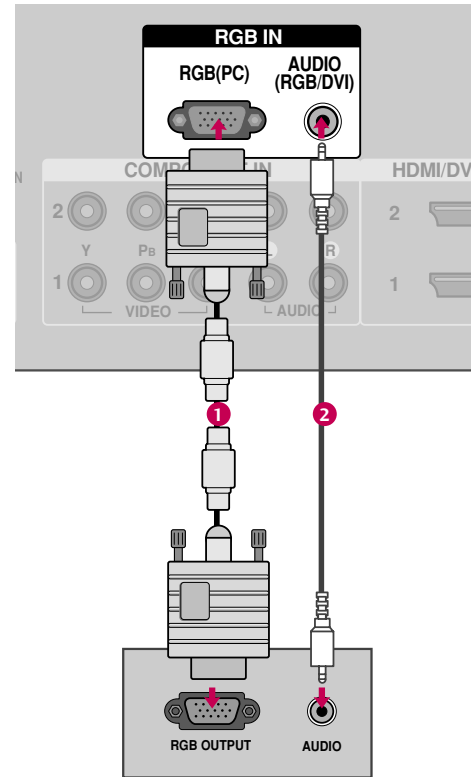

### DVI to HDMI Connection

#### 1. How to connect

- 1 Connect the DVI output of the PC to the **HDMI/DVI IN 1, 2, or HDMI IN3** jack on the TV.
- 2 Connect the PC audio output to the **AUDIO (RGB/DVI)** jack on the TV.

#### 2. How to use

- Turn on the PC and the TV.
- Select the **HDMI1, HDMI2** or **HDMI3** input source on the TV using the **INPUT** button on the remote control.

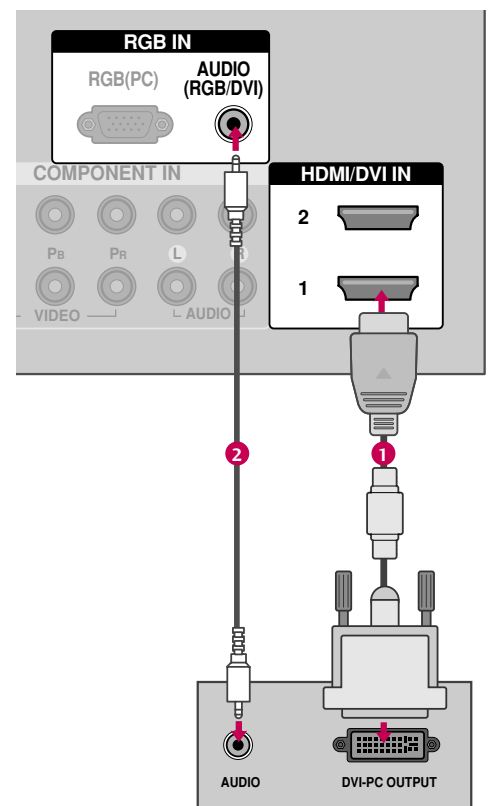

## Supported Display Specifications (RGB-PC, HDMI-PC)

Resolution	Horizontal Frequency(KHz)	Vertical Frequency(Hz)
640x350	31.468	70.09
720x400	31.469	70.08
640x480	31.469	59.94
	37.500	75.00
	37.861	72.80
800x600	35.156	56.25
	37.879	60.31
	46.875	75.00
	48.077	72.18
1024x768	48.363	60.00
	56.476	70.06
	60.023	75.02
1280x768	47.776	59.87
	60.289	74.893
1280x1024	63.981	60.02
	79.976	75.025
1360x768	47.712	60.015
1600x1200	75.00	60.00
1920x1080	67.50	60.00

\* Only RGB-PC mode

### ! NOTES

- ▶ To get the the best picture quality, adjust the PC graphics card to 1360x768.
- ▶ Depending on the graphics card, DOS mode may not work if a HDMI to DVI Cable is in use.
- ▶ In PC mode, there may be noise associated with the resolution, vertical pattern, contrast or brightness. If noise is present, change the PC output to another resolution, change the refresh rate to another rate or adjust the brightness and contrast on the PICTURE menu until the picture is clear.
- ▶ Avoid keeping a fixed image on the screen for a long period of time. The fixed image could become permanently imprinted on the screen.
- ▶ The synchronization input form for Horizontal and Vertical frequencies is separate.
- ▶ Depending on the graphics card, some resolution settings may not allow the image to be positioned on the screen properly.

# EXTERNAL EQUIPMENT SETUP







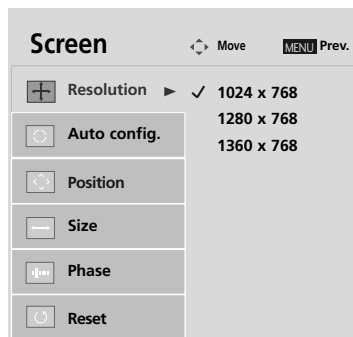
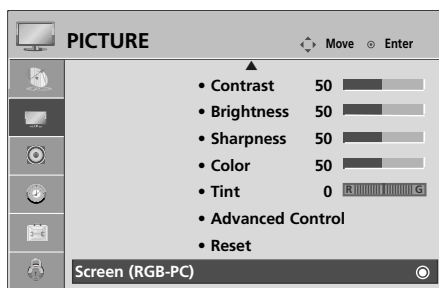

## Screen Setup for PC mode

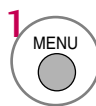
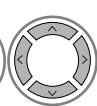
### Selecting Resolution

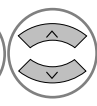
You can choose the resolution in RGB-PC mode.

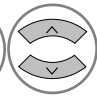
The **Position**, **Phase**, and **Size** can also be adjusted.

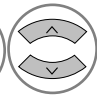







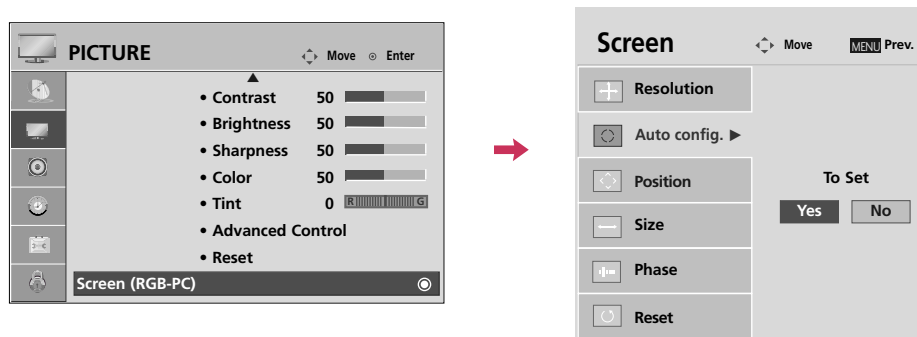

-   Select **PICTURE**.
-   Select **Screen (RGB-PC)**.
-   Select **Resolution**.
-   Select the desired resolution.
- 

## Auto Configure

Automatically adjusts picture position and minimizes image instability. After adjustment, if the image is still not correct, try using the manual settings or a different resolution or refresh rate on the PC.



- 1   Select **PICTURE**.
- 2   Select **Screen (RGB-PC)**.
- 3   Select **Auto config.**
- 4   Select **Yes**.
- 5  Start Auto Configuration.

- If the position of the image is still not correct, try Auto adjustment again.
- If picture needs to be adjusted again after Auto adjustment in RGB-PC, you can adjust the **Position**, **Size** or **Phase**.







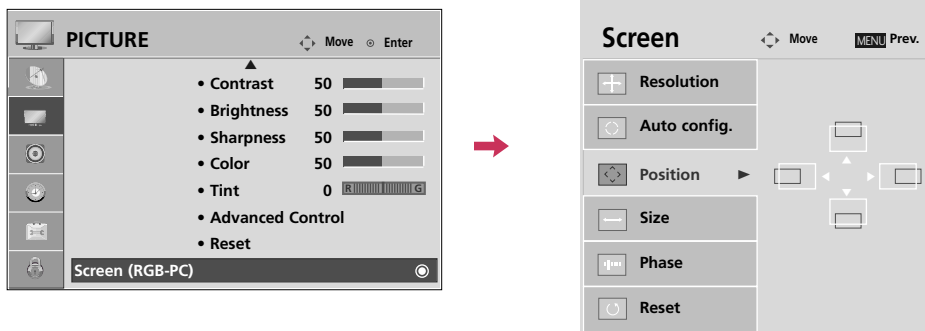

# EXTERNAL EQUIPMENT SETUP

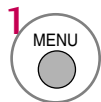
## Adjustment for screen Position, Size, and Phase

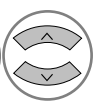
If the picture is not clear after auto adjustment and especially if characters are still trembling, adjust the picture phase manually.

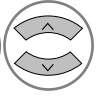
This feature operates only in RGB-PC mode.











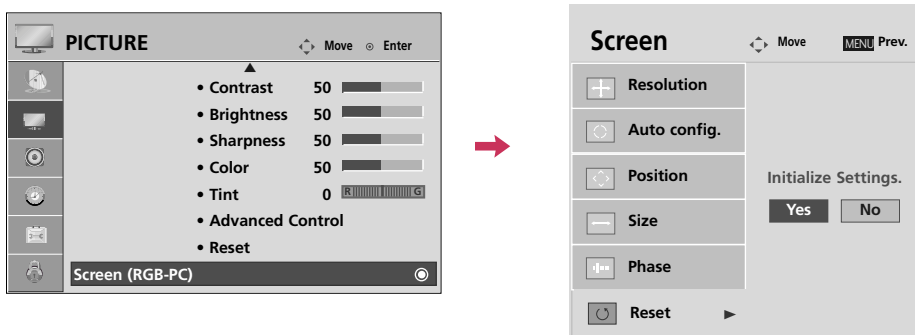

-   Select **PICTURE**.
-   Select **Screen (RGB-PC)**.
-   Select **Position, Size, or Phase**.
-   Make appropriate adjustments.
- 

- **Position:** This function is to adjust picture to left/right and up/down as you prefer.
- **Size:** This function is to minimize any vertical bars or stripes visible on the screen background. And the horizontal screen size will also change. The **Size** adjustment range is **-30 ~ 30**.
- **Phase:** This function allows you to remove any horizontal noise and clear or sharpen the image of characters. The **Phase** adjustment range is **-32 ~ 31**.

## Screen Reset (Reset to original factory values)

Returns **Position**, **Size**, and **Phase** to the default factory settings.  
This feature operates only in RGB-PC mode.



- 1   Select **PICTURE**.
- 2   Select **Screen (RGB-PC)**.
- 3   Select **Reset**.
- 4   Select **Yes**.
- 5 

# WATCHING TV / CHANNEL CONTROL

## REMOTE CONTROL FUNCTIONS

When using the remote control, aim it at the remote control sensor on the TV.

**RATIO** Change the aspect ratio. ▶ p.44

**SLEEP** Select the amount of time before your TV turns off automatically. ▶ p.72

**PICTURE** Selects the factory preset picture depend on the viewing environment. ▶ p.46

**SOUND** Selects the factory preset sound for type of program. ▶ p.58

**POWER** Turns your TV on or off.

**Q.MENU** Select the desired quick menu source. ▶ p.34

**MENU** Displays the main menu.  
Clear all on-screen displays and return to TV viewing from any menu.

**INPUT** External input modes rotate in regular sequence. ▶ p.39

### NUMBER button

**— (DASH)** Used to enter a program number for multiple program channels such as 2-1, 2-2, etc.

**FLASHBK** Tune to the last channel viewed.

### VCR/DVD, SIMPLINK Control buttons

- Control video cassette recorders or DVD players.
- Control the SIMPLINK compatible devices.

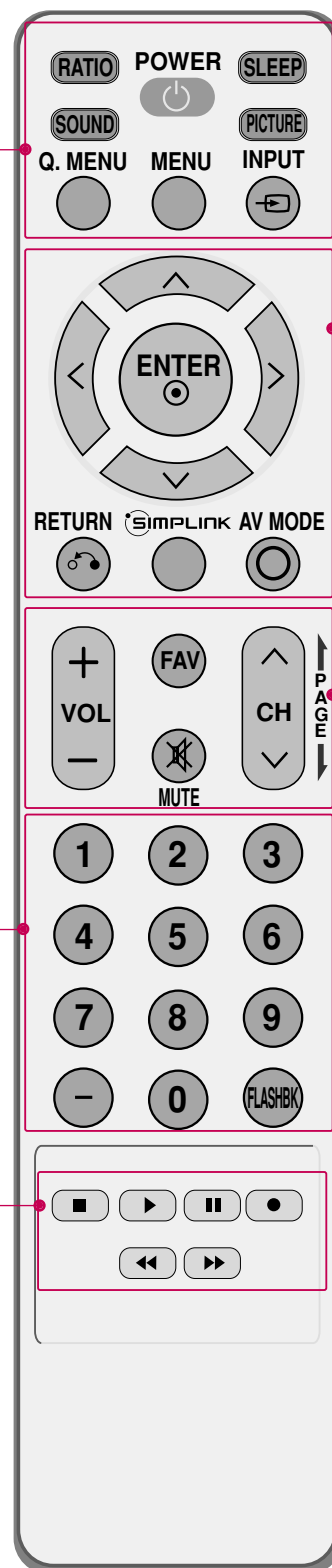



**THUMBSTICK**  
(Up/Down/Left  
Right/ENTER)

Navigate the on-screen menus and adjust the system settings to your preference.

**RETURN** Allows the user to move return one step in an interactive application or other user interaction function.

**SIMPLINK** See a list of AV devices connected to TV.  
When you toggle this button, the SIMPLINK menu appears at the screen. ► **p.42-43**

**AV MODE** It helps you select and set images and sounds when connecting AV devices. ► **p.41**

**VOLUME UP /DOWN** Increase/decrease the sound level.

**FAV** Scroll through the programmed Favorite channels. ► **p.34**

**MUTE** Switch the sound on or off. ► **p.32**

**CHANNEL UP/DOWN** Select available channels.

**PAGE UP/DOWN** Move from one full set of screen information to the next one.

## Installing Batteries

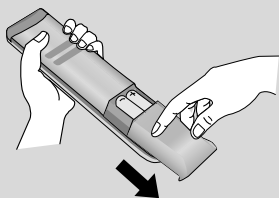

- Open the battery compartment cover on the back side and install the batteries matching correct polarity (+with +,-with -).
- Install two 1.5V AAA batteries. Don't mix old or used batteries with new ones.
- Close cover.

# WATCHING TV / CHANNEL CONTROL

## TURNING ON TV

---

- 1 First, connect power cord correctly. At this moment, the TV switches to standby mode.
    - In standby mode to turn TV on, press the  $\phi/|$  , **INPUT**, **CH** ( $\blacktriangle$  or  $\blacktriangledown$ ) button on the TV or press the **POWER**, **INPUT**, **CH** ( $\wedge$  or  $\vee$ ), **Number (0~9)** button on the remote control.
  - 2 Select the viewing source by using the **INPUT** button on the remote control.
    - This TV is programmed to remember which power state it was last set to, even if the power cord is out.
  - 3 When finished using the TV, press the **POWER** button on the remote control. The TV reverts to standby mode.
- 

**! NOTE** ▶ If you intend to be away on vacation, disconnect the power plug from the wall power outlet.

## CHANNEL SELECTION

---

- 1 Press the **CH** ( $\wedge$  or  $\vee$ ) or **NUMBER** buttons to select a channel number.
- 

## VOLUME ADJUSTMENT

Adjust the volume to suit your personal preference.

---

- 1 Press the **VOL (+ or -)** button to adjust the volume.
  - 2 If you want to switch the sound off, press the **MUTE** button.
  - 3 You can cancel the Mute function by pressing the **MUTE** or **VOL (+ or -)** button.
-

# INITIAL SETTING

This Function guides the user to easily set the essential items for viewing the TV for the first time when purchasing the TV. It will be displayed on the screen when turning the TV on for the first time. It can also be activated from the user menus.

- Default selection is “**Home**”. We recommend setting the TV to “**Home**” mode for the best picture in your home environment.
- “**In-store**” Mode is only intended for use in retail environments. Customers can adjust the “**Picture** menu - **Picture mode**” manually while inspecting the TV, but the TV will automatically return to preset in-store mode after 5 minutes.

## Step1. Mode Setting

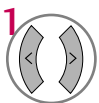
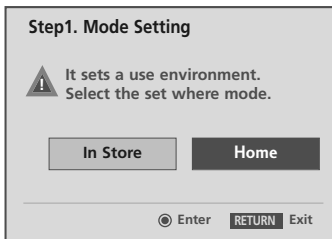

1 Select **Home** Mode.



## Step2. Time Setting

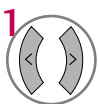
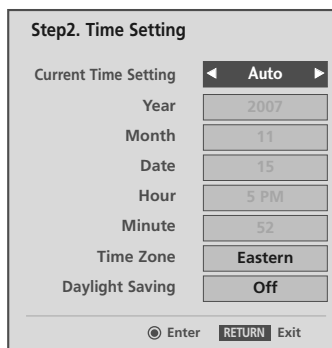

1 Select **Auto** or **Manual**.



2 Select desired time option.



## Step3. Option Setting

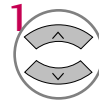
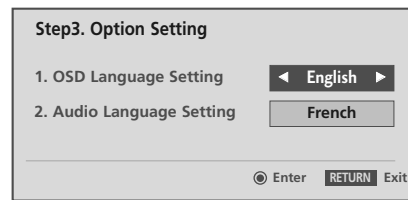

1 Select **OSD Language Setting** or **Audio Language Setting**.

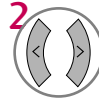

2 Select your desired language.

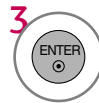

## Step4. Auto Tuning

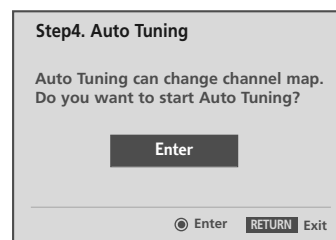

1 Start **Auto Tuning**.

### ! NOTE

- You can also adjust **Initial Setting** in the **OPTION** menu.

# WATCHING TV / CHANNEL CONTROL

## QUICK MENU

Your TV's OSD (On Screen Display) may differ slightly from what is shown in this manual.

Q.Menu (Quick Menu) is a menu of features which users might use frequently.

- **Aspect Ratio:** Selects your desired picture format.
- **Power Saving:** Adjusts screen brightness to reduce the power consumption of the TV.
- **Clear Voice:** By differentiating the human sound range from others, it helps make human voices sound better.
- **Picture Mode:** Selects the factory preset picture depend on the viewing environment.
- **Sound Mode:** Selects the factory preset sound for type of program.
- **Caption:** Select on or off.
- **Multi Audio:** Changes the audio language (Digital signal).  
**SAP:** Selects MTS sound (Analog signal).
- **Sleep Timer:** Select the amount of time before your TV turns off automatically.
- **Del/Add/Fav:** Select channel you want to add/delete or add the channel to the Favorite List.

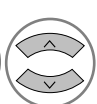

1   Display each menu.

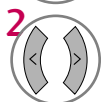



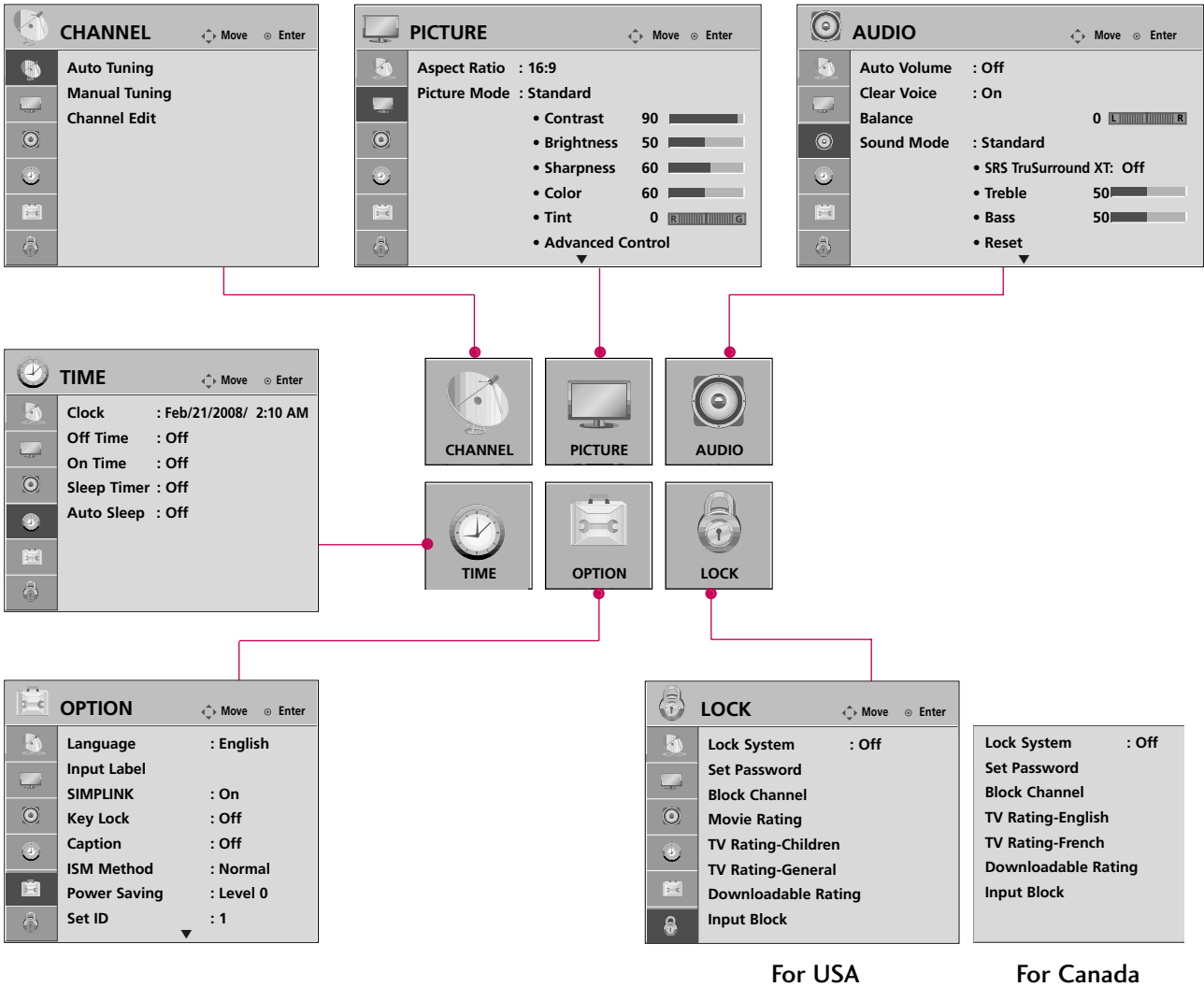

2  Make appropriate adjustments.

3  Return to TV viewing.

# ON-SCREEN MENUS SELECTION

Your TV's OSD (On Screen Display) may differ slightly from that shown in this manual.



- 1   Display each menu.
- 2   Select a menu item.
- 3  Enter to the pop up menu.
- 4  Return to TV viewing.

# WATCHING TV / CHANNEL CONTROL





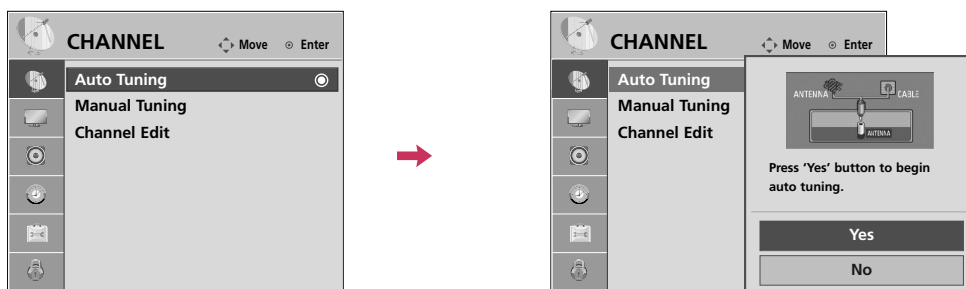

## CHANNEL SETUP

### Auto Scan (Auto Tuning)

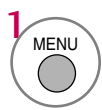
Automatically finds all channels available through antenna or cable inputs, and stores them in memory on the channel list.

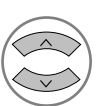
Run Auto Tuning again after any Antenna/Cable connection changes.

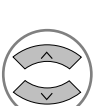

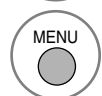







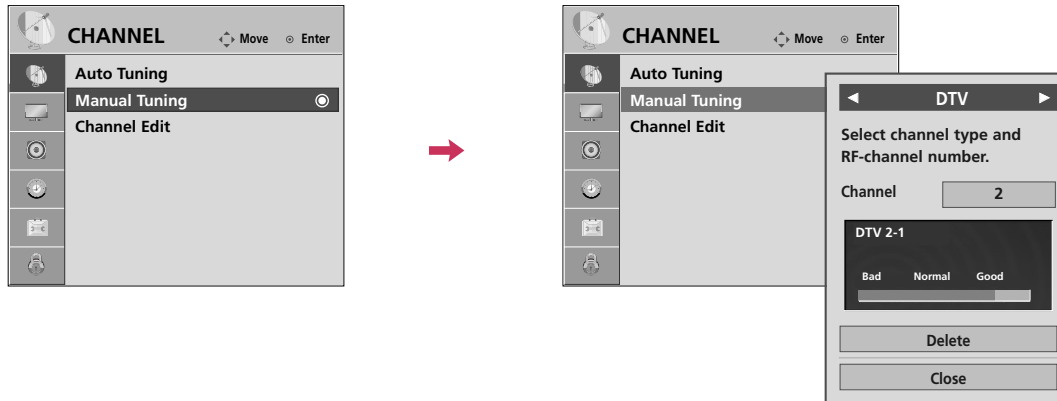



-   Select **CHANNEL**.
-   Select **Auto Tuning**.
-   Select **Yes**.
-  Run **Auto tuning**.
-  Return to the previous menu.
-  Return to TV viewing.

■ A password is required to gain access to Auto Tuning menu if the Lock System is turned on.

## Add/Delete Channel (Manual Tuning)

If selecting DTV or CADTV input signal, you can view the on-screen signal strength monitor to see the quality of the signal being received.



- 1   Select **CHANNEL**.
- 2   Select **Manual Tuning**.
- 3   Select **DTV, TV, CADTV, or CATV**.
- 4   Select channel you want to add or delete.
- 5   Select **Add** or **Delete**.
- 6  Return to the previous menu.
-  Return to TV viewing.

- A password is required to gain access to Manual Tuning menu if the Lock System is turned on.

# WATCHING TV / CHANNEL CONTROL







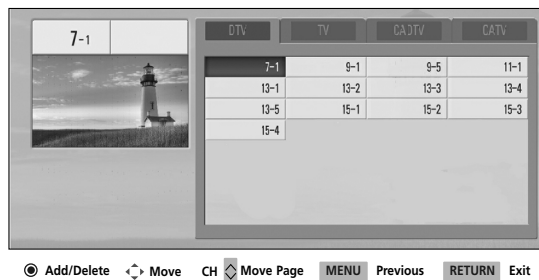

## CHANNEL SETUP

### Channel Editing

A channel list can be created by toggling each channel on or off with **ENTER** button. The channels in the list are displayed in black and the channels deleted from the Custom List are displayed in gray.

Once a channel is highlighted you can add or delete the channel by referring to the small window at the top-right corner of the screen.



-   Select **CHANNEL**.
-   Select **Channel Edit**.
-   Select a channel.
-  Select channel you want to add or delete.
-  Return to the previous menu.
-  Return to TV viewing.



# INPUT LIST

Only these input signals which are connected to a TV can be activated and selected.

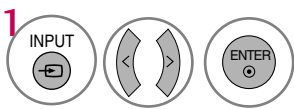
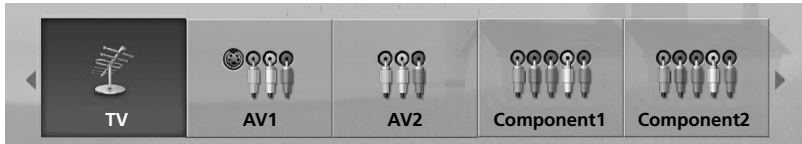

Select the desired input source.

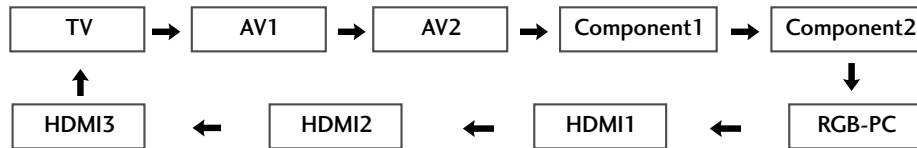

- **TV:** Select it to watch over-the-air, cable and digital cable broadcasts.
- **AV 1-2:** Select them to watch a VCR or other external equipment.
- **Component 1-2:** Select them to watch DVD or a Digital set-top box.
- **RGB-PC:** Select it to view PC input.
- **HDMI1-3:** Select them to watch high definition devices.

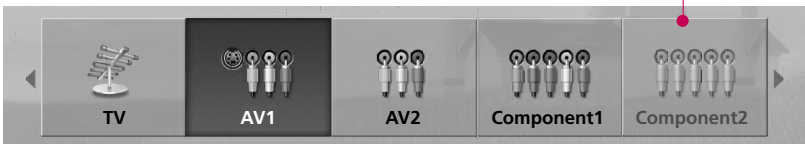

Disconnected input is inactivated.

Select a desired input source (except **TV**). Then, you can select your desired Input Label with using Q.MENU button. ► **p.40**

Q.MENU Input Label RETURN Exit







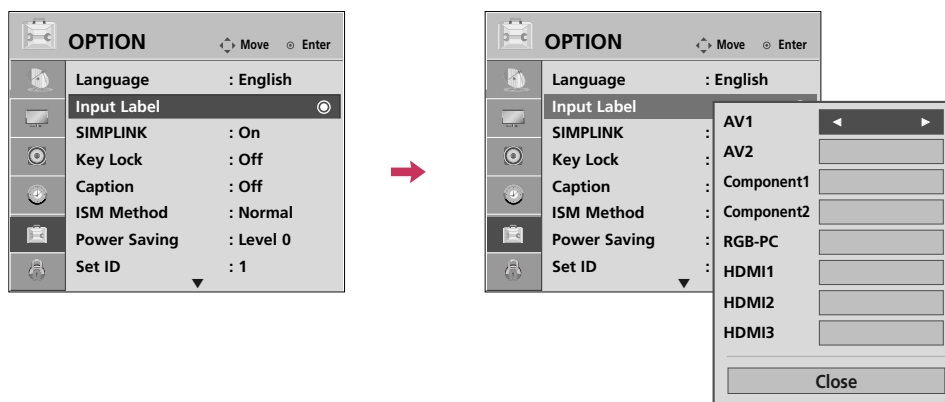

# WATCHING TV / CHANNEL CONTROL

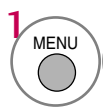
## INPUT LABEL



You can set a label for each input source when it's not in use.

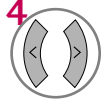

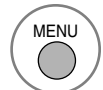
### With using OPTION menu

-   Select **OPTION**.
-   Select **Input Label**.
-   Select the source.
-  Select the label.
-  Return to the previous menu.
-  Return to TV viewing.

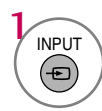
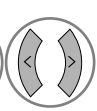
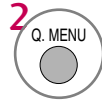
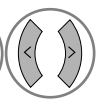
### With using INPUT button

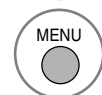
-   Select the source.
-   Select the label.
-  Return to the previous menu.
-  Return to TV viewing.

## AV MODE

You can select the optimal images and sounds.

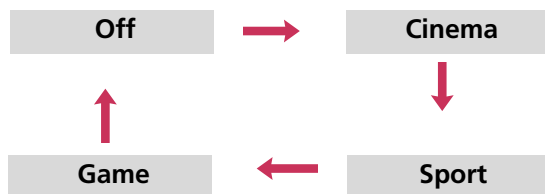

Press the **AV MODE** button repeatedly to select the desired source.



Return to TV viewing.

- If you select “**Cinema**” in AV mode, **Cinema** will be selected both for “**PICTURE** menu - Picture Mode” and “**AUDIO** menu - Sound Mode” respectively.
- If you select “**Off**” in AV mode, the “**Picture Mode**” and “**Sound Mode**” return to previous selected value.

# WATCHING TV / CHANNEL CONTROL



This function operates only with devices with the SIMPLINK logo.

The TV might not function properly when using it with other products with HDMI-CEC function.

This allows you to control and play other AV devices connected with HDMI cable without additional cables and settings.

To start using SIMPLINK, turn it on in the user menus.

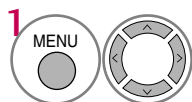
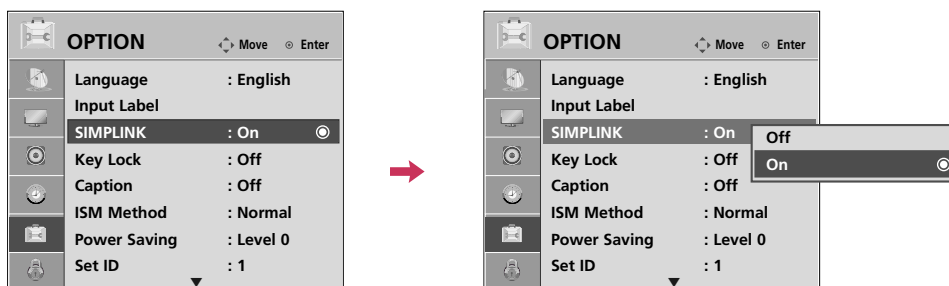

1 Select **OPTION**.

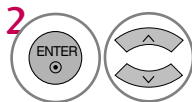

2 Select **SIMPLINK**.

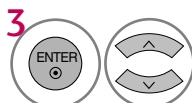

3 Select **On** or **Off**.



4 Return to the previous menu.

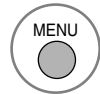

Return to TV viewing.

## ! NOTE

- ▶ Connect the HDMI/DVI IN or HDMI IN terminal of the TV to the rear terminal (HDMI terminal) of the SIMPLINK device with the HDMI cable.
- ▶ When you switch the Input source with the INPUT button on the remote control, the SIMPLINK device will stop.
- ▶ When you select a device with home theater functionality, the sound output automatically switches to the home theater speakers.
- ▶ If a connected SIMPLINK home theater system doesn't play the audio from the TV, connect the DIGITAL AUDIO OUT terminal on the back of the TV to the DIGITAL AUDIO IN terminal on the back of the SIMPLINK device with an OPTICAL cable.

## SIMPLINK Functions

- **Direct Play:** After connecting AV devices to the TV, you can directly control the devices and play media without additional settings.
- **Select AV device:** Enables you to select one of the AV devices connected to TV.
- **Disc playback:** Control connected AV devices by pressing the  $\wedge$   $\vee$   $\lt$   $\gt$ , ENTER,  $\blacktriangleright$ ,  $\blacksquare$ ,  $\parallel$ ,  $\blacktriangleleft$  and  $\blacktriangleright$  buttons.
- **Power off all devices:** When you power off the TV, all connected devices are turned off.
- **Switch audio-out:** Offers an easy way to switch audio-out.
- **Sync Power on:** When you play the connected AV device, TV will automatically turn on.

(A device, which is connected to the TV through a HDMI cable but does not support SIMPLINK, does not provide this function)

Note: To operate SIMPLINK, an HDMI cable over Version 1.2 with \*CEC function should be used. (\*CEC: Consumer Electronics Control).

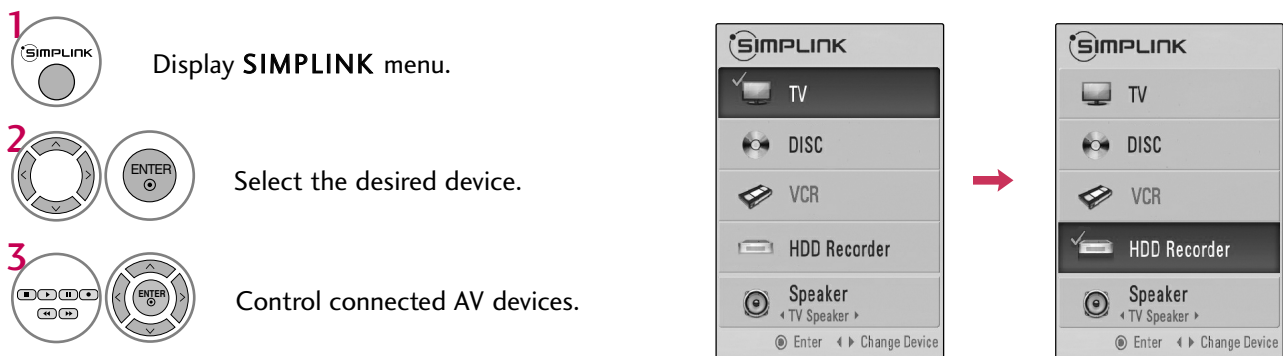

## SIMPLINK Menu

- 1 TV viewing:** Switch to the previous TV channel regardless of the current mode.
- 2 DISC playback:** Select and play discs. When multiple discs are available, the titles of discs are conveniently displayed at the bottom of the screen.
- 3 VCR playback:** Control the connected VCR.
- 4 HDD Recordings playback:** Control recordings stored in HDD.
- 5 Audio Out to Home Theater speaker/Audio Out to TV:** Select Home Theater speaker or TV speaker for Audio Out.



- ▶ When no device is connected (displayed in gray)
- ▶ Selected Device
- ▶ When a device is connected (displayed in bright color)

# PICTURE CONTROL

## PICTURE SIZE (ASPECT RATIO) CONTROL

This feature lets you choose the way an analog picture with a 4:3 aspect ratio is displayed on your TV.

- RGB-PC input source use 4:3 or 16:9 aspect ratio.

### NOTE

- ▶ If a fixed image is displayed on the screen for a long time, the image could become imprinted on the screen and remain visible.

This phenomenon is common to all manufacturers and is not covered by warranty. Although, after watching video that did not fill the screen, any after-image from the black bars will normally dissipate after a few minutes.

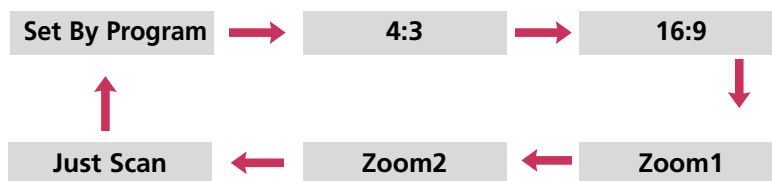

- 1  Select the desired picture format.

- 2  Return to TV viewing.

### Set by program

Selects the proper picture proportion to match the source's image.

(4:3 → 4:3)



(16:9 → 16:9)



### 4:3

Choose 4:3 when you want to view a picture with an original 4:3 aspect ratio.



### 16:9

Adjust the picture horizontally, in a linear proportion to fill the entire screen.



### Zoom 1

Choose Zoom 1 when you want to view the picture without any alteration. However, the top and bottom portions of the picture will be cropped.

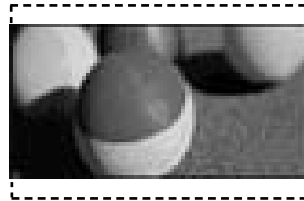

### Zoom 2

Choose Zoom 2 when you want the picture to be altered, both vertically extended and cropped. The picture taking a halfway trade off between alteration and screen coverage.

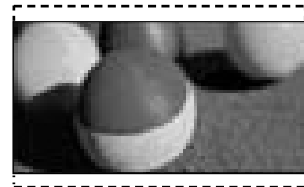

### Just Scan

Following selection will lead to you view the picture of best quality without loss of original picture in high resolution image.

Notes: If there are noise in original picture, you can see the noise at the edge.

**Just Scan** operates only in DTV/CADTV/Component/HDMI-DTV/DVI-DTV (720p/1080i/1080p) input source.





# PICTURE CONTROL

## PRESET PICTURE SETTINGS

### Picture Mode - Preset

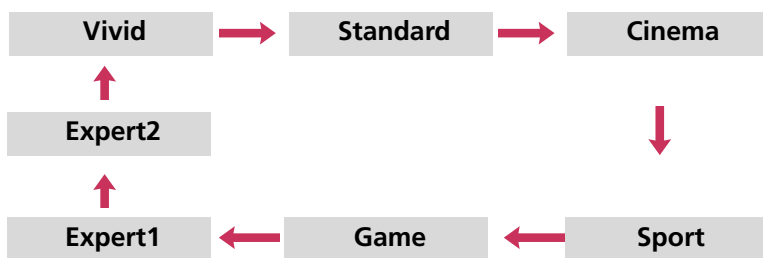
There are factory presets for picture settings available in the user menus. You can use a preset, change each setting manually.



1  Select **Vivid, Standard, Cinema, Sport, Game, Expert1, or Expert2.**

2  Return to TV viewing.









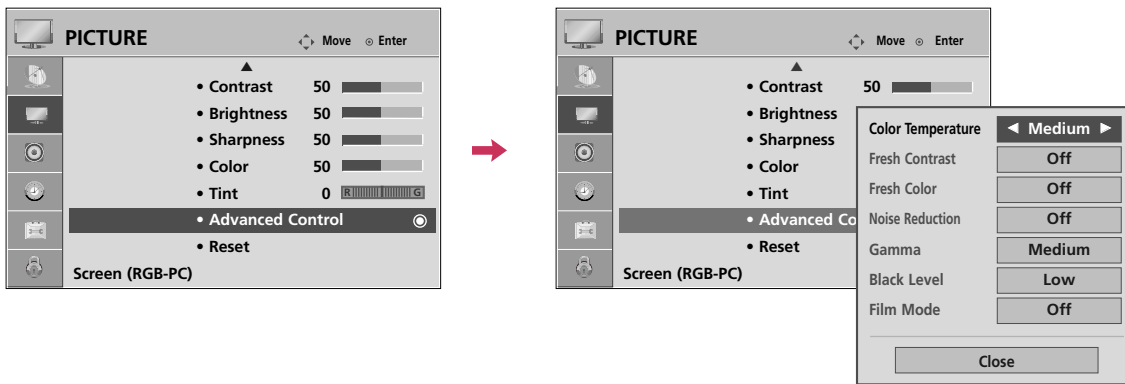

■ **Vivid, Standard, Cinema, Sport, Game, Expert1, or Expert2** Settings are preset for the optimum picture quality at the factory and are not adjustable.



## Color Tone - Preset

Choose one of three automatic color adjustments. Set to warm to enhance hotter colors such as red, or set to cool to see less intense colors with more blue.



-   Select **PICTURE**.
-   Select **Advanced Control**.
-   Select **Color Temperature**.
-   Select **Cool, Medium, or Warm**.
-  Return to the previous menu.
-  Return to TV viewing.









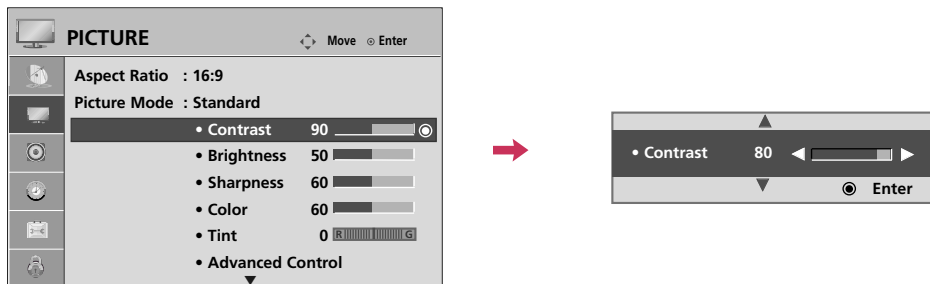

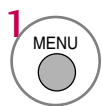
# PICTURE CONTROL

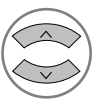
## MANUAL PICTURE ADJUSTMENT

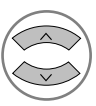
### Picture Mode - User Mode

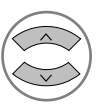
Adjust the picture appearance to suit your preference and viewing situations.

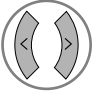







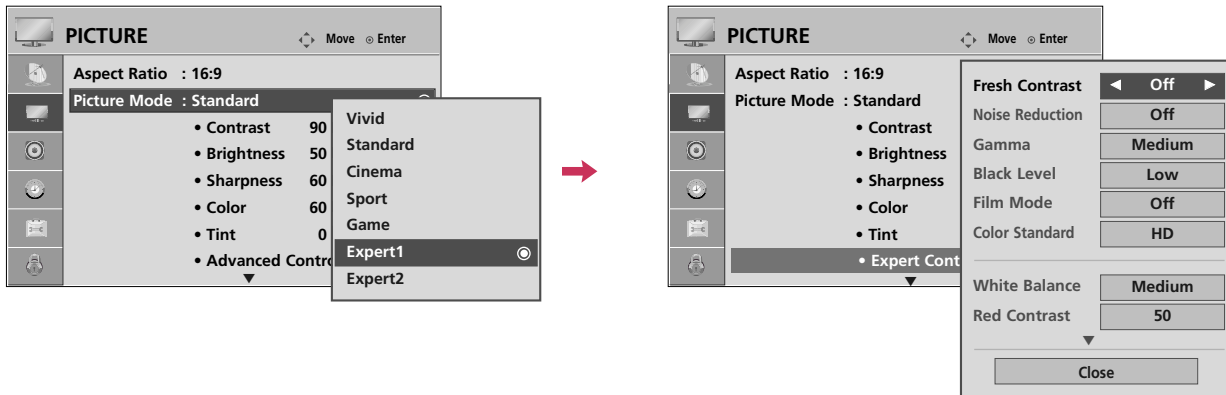





-   Select **PICTURE**.
-   Select **Picture Mode**.
-   Select **Vivid, Standard, Cinema, Sport, or Game**.
-   Select **Contrast, Brightness, Sharpness, Color, or Tint**.
-   Make appropriate adjustments.
-  Return to the previous menu.
-  Return to TV viewing.

## Picture Mode - Expert Control

By segmenting categories, **Expert1** and **Expert2** provide more categories which users can set as they see fit, offering the optimal picture quality for users.



- 1   Select **PICTURE**.
- 2   Select **Picture Mode**.
- 3   Select **Expert1** or **Expert2**.
- 4   Select **Expert Control**.
- 5   Select your desired menu option.
- 6  Make appropriate adjustments.
- 7  Return to the previous menu.
-  Return to TV viewing.

# PICTURE CONTROL

## PICTURE IMPROVEMENT TECHNOLOGY

**Fresh Contrast:** Optimizes the contrast automatically according to the brightness of the reflection.







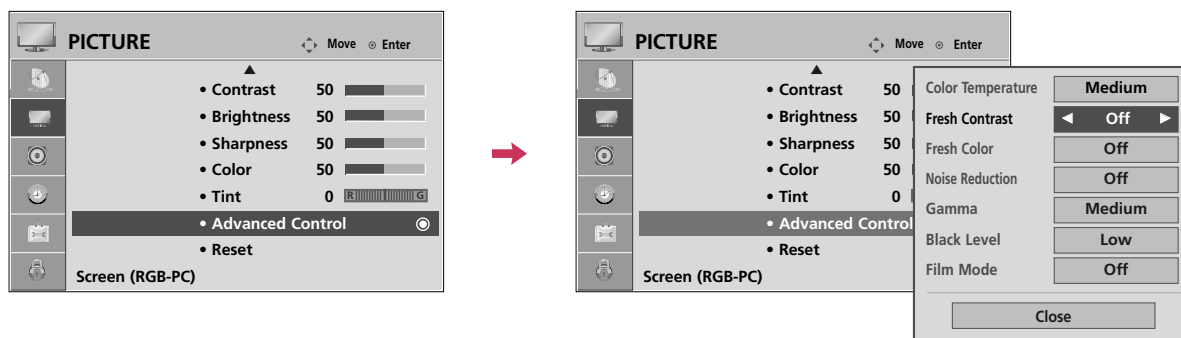

**Fresh Color:** Adjusts the color of the reflection automatically to reproduce as close as possible natural colors.

**Noise Reduction:** Removes interference up to the point where it does not damage the original picture.

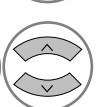
**Gamma:** High gamma values display whitish images and low gamma values display high contrast images.

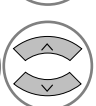



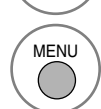





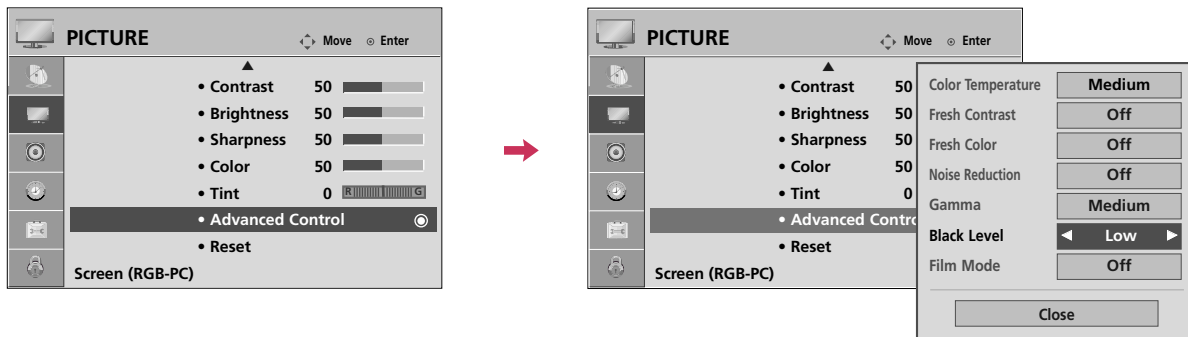

PICTURE CONTROL

-   Select **PICTURE**.
-   Select **Advanced Control**.
-   Select **Fresh Contrast, Fresh Color, Noise Reduction, or Gamma**.
-   Select your desired options.
-  Return to the previous menu.
-  Return to TV viewing.

# ADVANCED CONTROL - BLACK (DARKNESS) LEVEL

Adjusting the contrast and the brightness of the screen using the black level of the screen. This feature is disable in DTV and RGB-PC mode.



- 1   Select **PICTURE**.
- 2   Select **Advanced Control**.
- 3   Select **Black Level**.
- 4   Select **Low** or **High**.
- 5  Return to the previous menu.
-  Return to TV viewing.

- **Low:** The reflection of the screen gets darker.
- **High:** The reflection of the screen gets brighter.
- **Auto:** Realizing the black level of the screen and set it to High or Low automatically.

# PICTURE CONTROL









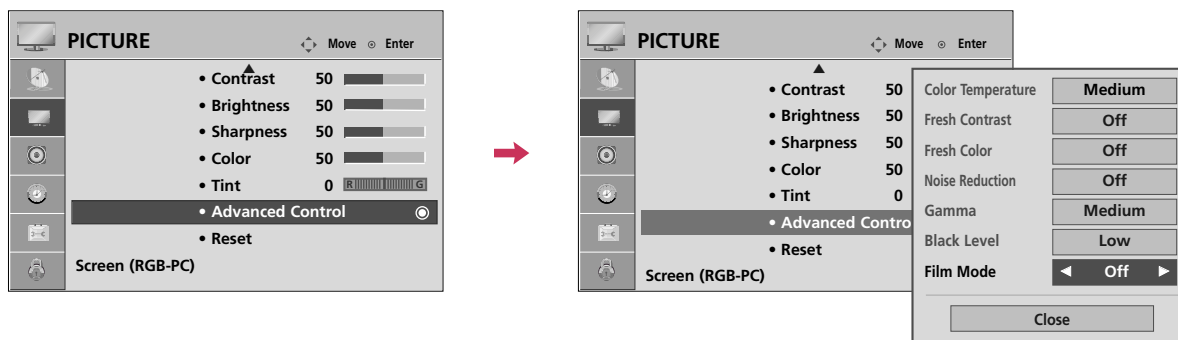

## ADVANCED CONTROL - FILM MODE

Set up the TV for the best picture appearance for viewing movies.

When you operate Film Mode (3:2 Pull-Down Mode or Cinema Correction Mode), the TV will adjust 24 fps video from movies to 30 fps video for display.

This feature operates only in TV (Analog TV/CATV, Digital DTV/CADTV), AV1, AV2, Component 480i/1080i, and HDMI 1080i mode.







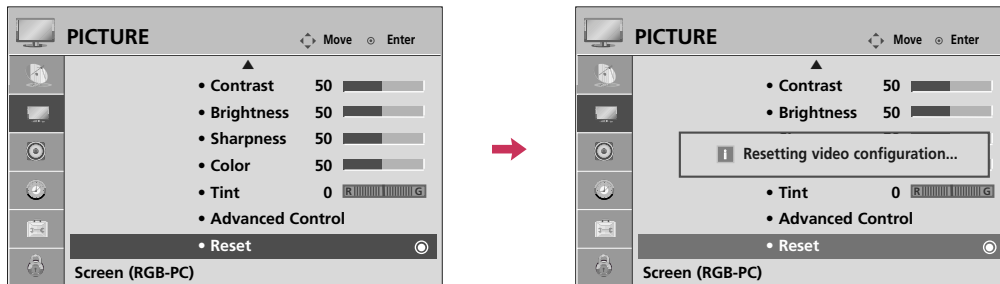

- 1   Select **PICTURE**.
- 2   Select **Advanced Control**.
- 3   Select **Film Mode**.
- 4   Select **On** or **Off**.
- 5  Return to the previous menu.
-  Return to TV viewing.

# PICTURE RESET

Settings of the selected picture modes return to the default factory settings.







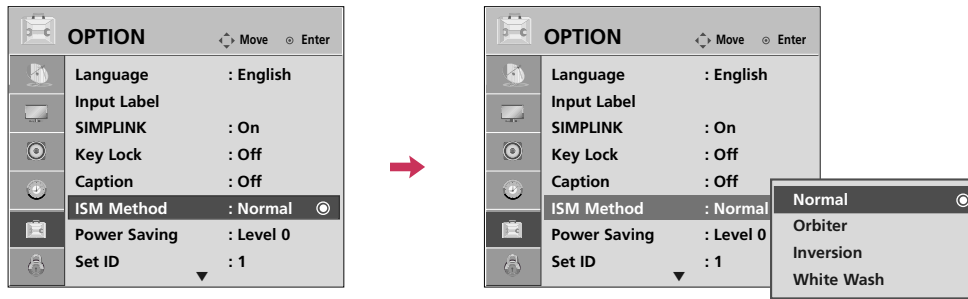

-   Select **PICTURE**.
-   Select **Reset**.
-  Initialize the adjusted value.
-  Return to TV viewing.

# PICTURE CONTROL

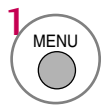
## IMAGE STICKING MINIMIZATION (ISM) METHOD

A frozen still picture from a PC/video game displayed on the screen for prolonged periods can result in a ghost image. You can use Orbiter to help prevent image sticking. The other two functions are for removing a ghost image.

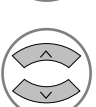

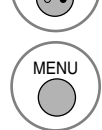
-   Select **OPTION**.
-   Select **ISM Method**.
-   Select **Normal, Orbiter, Inversion** or **White Wash**.
-  Return to the previous menu.
-  Return to TV viewing.

- **Normal:** If image sticking is never a problem, ISM is not necessary - set to Normal.
- **Orbiter:** Orbiter may help prevent ghost images. However, it is best not to allow any fixed image to remain on the screen. To avoid a ghost image on the screen, the image will move every 2 minutes.
- **Inversion:** Inversion will automatically invert the plasma display panel color every 30 minutes.
- **White Wash:** White Wash removes ghost images from the screen. Use sparingly. Watch the TV normally for a while before using this feature to see if the ghost image disappears on its own.

### ! NOTE







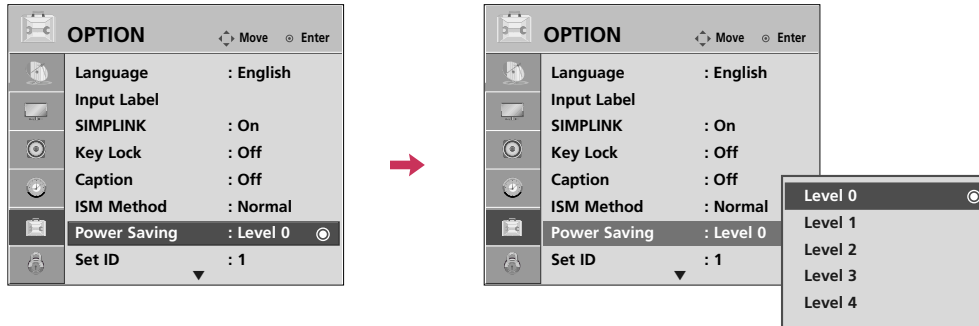

- ▶ An excessive ghosted image may be impossible to clear entirely with White Wash. To return to normal viewing, press the any button.



# POWER SAVING PICTURE MODE

It reduces the plasma display's power consumption.



-   Select **OPTION**.
-   Select **Power Saving**.
-   Select **Level 0, Level 1, Level 2, Level 3, or Level 4**.
-  Return to the previous menu.
-  Return to TV viewing.





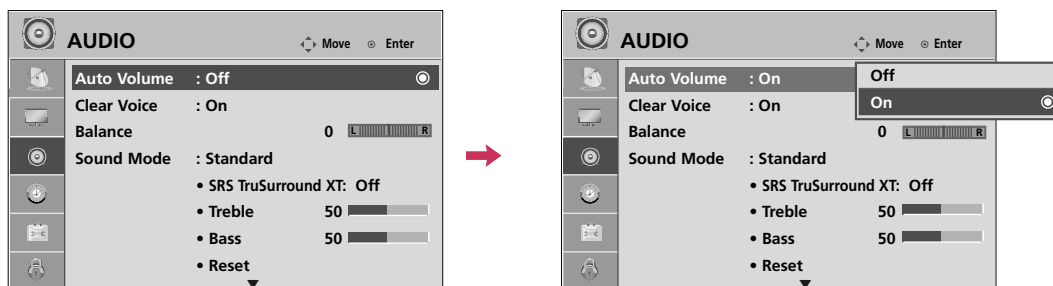

- Level 0 is the brightest.
- Level 0 > Level 1 > Level 2 > Level 3 > Level 4
- You can also adjust **Power Saving** in the **Q. Menu**.

# SOUND & LANGUAGE CONTROL

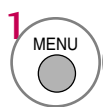
## AUTO VOLUME LEVELER (AUTO VOLUME)

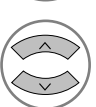
Auto Volume makes sure that the volume level remains consistent whether you are watching a commercial or a regular TV program.

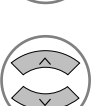

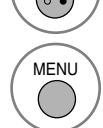





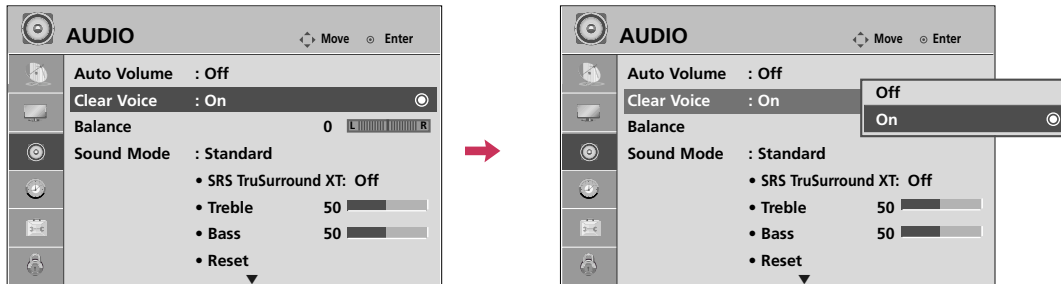

-   Select **AUDIO**.
-   Select **Auto Volume**.
-   Select **On** or **Off**.
-  Return to the previous menu.
-  Return to TV viewing.

# CLEAR VOICE

By differentiating the human sound range from others, it improves the sound quality of voices.



- 1   Select **AUDIO**.
- 2   Select **Clear Voice**.
- 3   Select **On** or **Off**.
- 4  Return to the previous menu.
-  Return to TV viewing.

- If you select “**Clear Voice-On**”, **SRS TruSurround XT** feature will not work.
- You can also adjust **Clear Voice** in the **Q-Menu**.

# SOUND & LANGUAGE CONTROL

## PRESET SOUND SETTINGS (SOUND MODE)

Sound Mode lets you enjoy the best sound without any special adjustment as the TV sets the appropriate sound options based on the program content.

**Standard, Music, Cinema, Sport, and Game** are preset for optimum sound quality at the factory and are not adjustable.

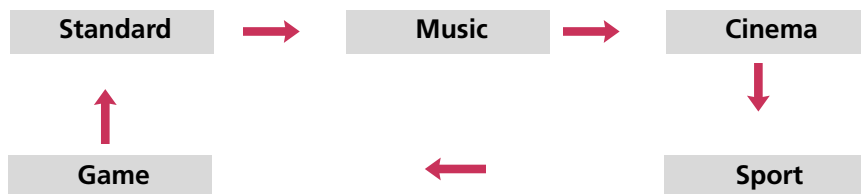







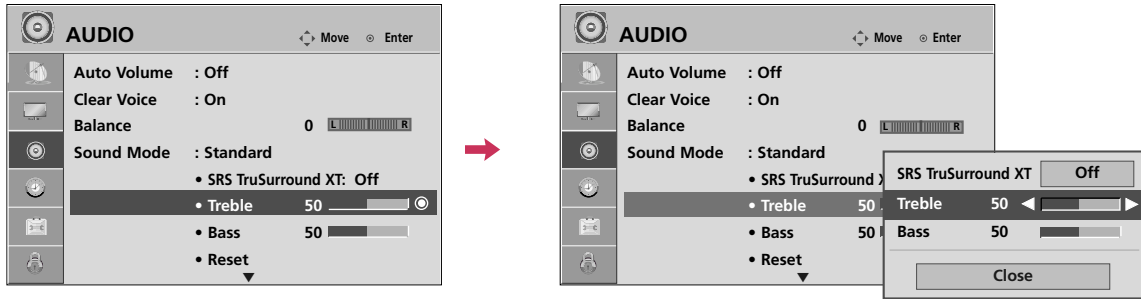

**1**  Select **Standard, Music, Cinema, Sport, or Game**.





**2**  Return to TV viewing.

# SOUND SETTING ADJUSTMENT - USER MODE









Adjust the sound to suit your taste and room situations.



- 1   Select **AUDIO**.
- 2   Select **Sound Mode**.
- 3   Select **Standard, Music, Cinema, Sport, or Game**.
- 4   Select **Treble or Bass**.

- 5   Make appropriate adjustments.
- 6  Return to the previous menu.
-  Return to TV viewing.

## SRS TRUSURROUND XT

- 1   Select **AUDIO**.
- 2   Select **SRS TruSurround XT**.
- 3   Select **On or Off**.
- 4  Return to the previous menu.
-  Return to TV viewing.







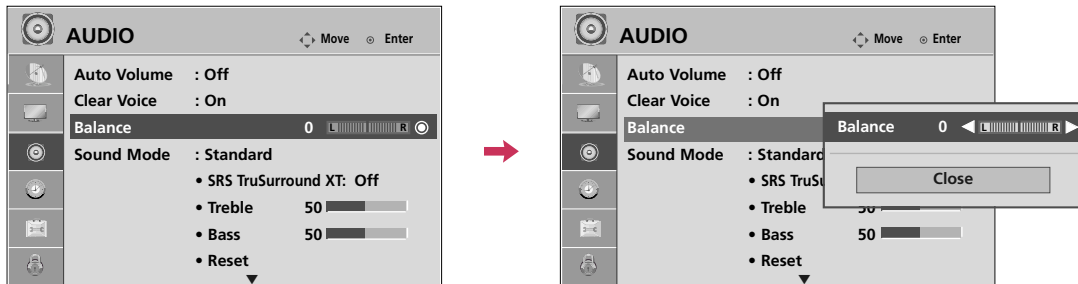

■ **SRS TruSurround XT:** Takes advantage of any multi-channel format without needing to add extra speakers or equipment. Dialog clarity, bass enrichment, and the addition of stereo audio enhancement produces an immersive sound experience from standard stereo material.

# SOUND & LANGUAGE CONTROL

## BALANCE

Adjust the left/right sound of speaker to suit your taste and room situations.









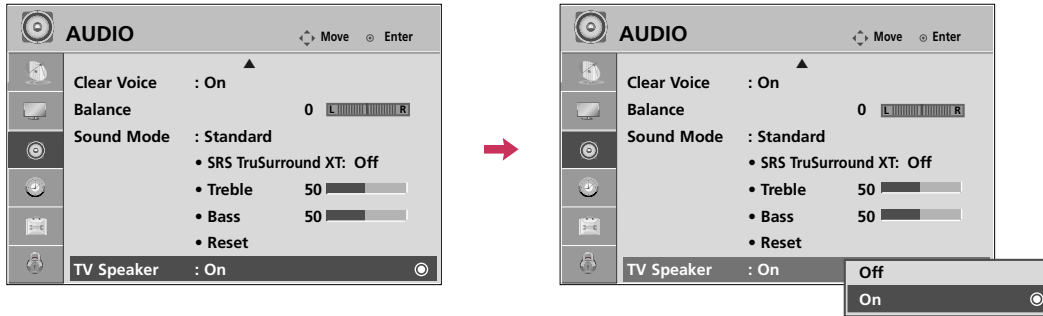

-   Select **AUDIO**.
-   Select **Balance**.
-   Make appropriate adjustments.
-  Return to the previous menu.
-  Return to TV viewing.

# TV SPEAKERS ON/OFF SETUP

Turn the TV speakers off if using external audio equipment.







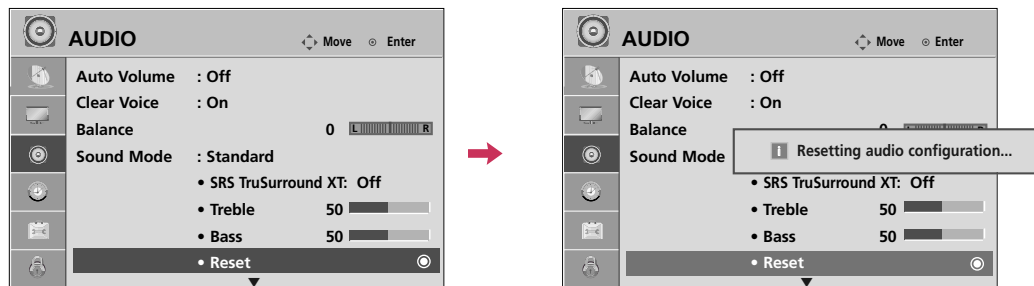

-   Select **AUDIO**.
-   Select **TV Speaker**.
-   Select **On** or **Off**.
-  Return to the previous menu.
-  Return to TV viewing.

# SOUND & LANGUAGE CONTROL

## AUDIO RESET

Settings of the selected Sound Mode return to the default factory settings.



-   Select **AUDIO**.
-   Select **Reset**.
-  Initialize the adjusted value.
-  Return to TV viewing.



## STEREO/SAP BROADCAST SETUP

For Analog only: This TV can receive MTS stereo programs and any SAP (Secondary Audio Program) that accompanies the stereo program if the station transmits an additional sound signal. Mono sound is automatically used if the broadcast is only in Mono.



### Analog TV

1   Select **SAP**.

2  Select **Mono, Stereo, or SAP**.

3  Return to TV viewing.

### Digital TV

1   Select **Multi Audio**.

2  Select other languages.

3  Return to TV viewing.

# SOUND & LANGUAGE CONTROL

## AUDIO LANGUAGE

Other languages may be available if a digital signal is provided by the broadcasting station.  
This feature operates only in DTV/CADTV mode.

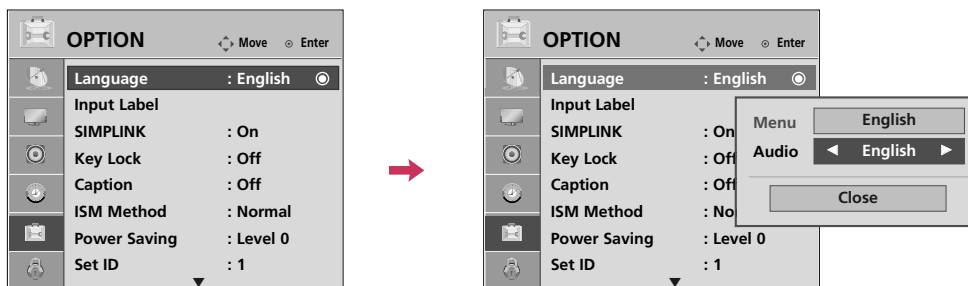







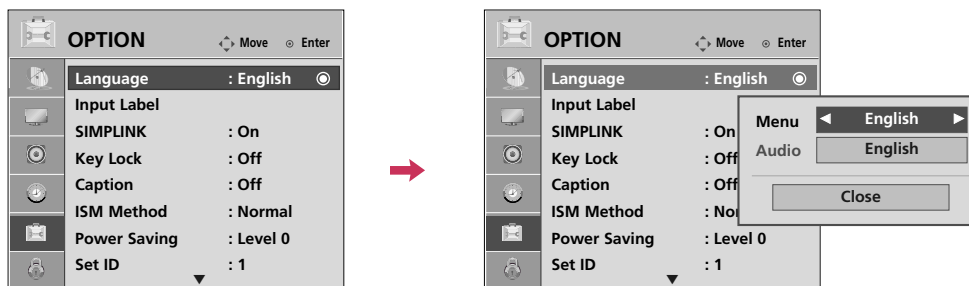

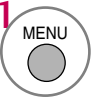
-   Select **OPTION**.
-   Select **Language**.
-   Select **Audio**.
-   Select your desired language:  
**English, Spanish, or French**
-  Return to the previous menu.
-  Return to TV viewing.

# ON-SCREEN MENUS LANGUAGE SELECTION

The menus can be shown on the screen in the selected language.



- 1   Select **OPTION**.
- 2   Select **Language**.
- 3   Select **Menu**.
- 4  Select your desired language.  
From this point on, the on-screen menus will be shown in the selected language.
- 5  Return to the previous menu.
-  Return to TV viewing.







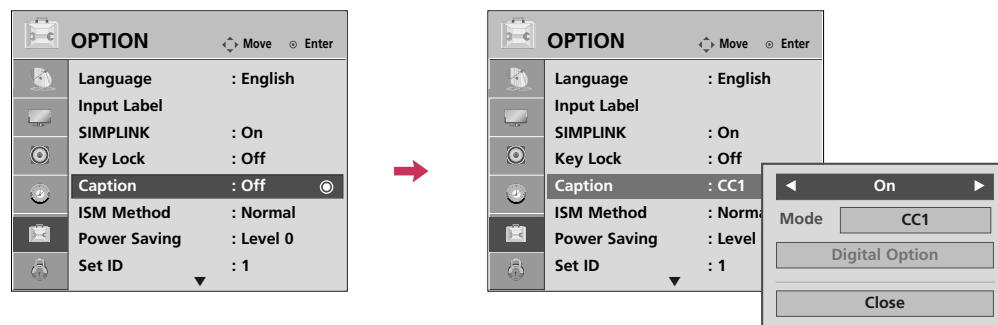

# SOUND & LANGUAGE CONTROL

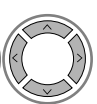
## CAPTION MODE

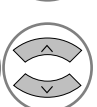
### Analog Broadcasting System Captions

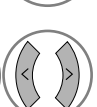
Caption must be provided to help people with hearing loss watch TV. Select a caption mode for displaying captioning information if provided on a program. Analog caption displays information at any position on the screen and is usually the program's dialog. Caption/Text, if provided by the broadcaster, would be available for both digital and analog channels on the Antenna/Cable. This TV is programmed to memorize the caption/text mode which was last set when you turned the power off. This function is only available when **Caption Mode** is set **On**.

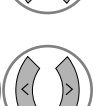

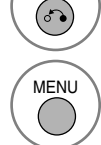
-   Select **OPTION**.
-   Select **Caption**.
-   Select **On**.
-   Select **CC1-4** or **Text1-4**.
-  Return to the previous menu.
-  Return to TV viewing.

- When selecting **Off**, Sub-menus for Analog, DTV, and Digital Option become disabled.
- **CAPTION**  
The term for the words that scroll across the bottom of the TV screen; usually the audio portion of the program provided for the hearing impaired.
- **TEXT**  
The term for the words that appear in a large black frame and almost cover the entire screen; usually messages provided by the broadcaster.









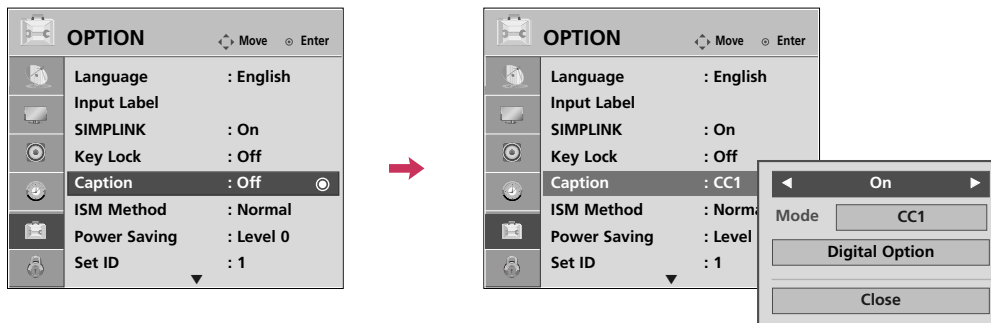

## Digital Broadcasting System Captions

Choose the language you want the DTV/CADTV Captions to appear in.

Other Languages can be chosen for digital sources only if they are included on the program.

This function is only available when **Caption Mode** is set **On**.











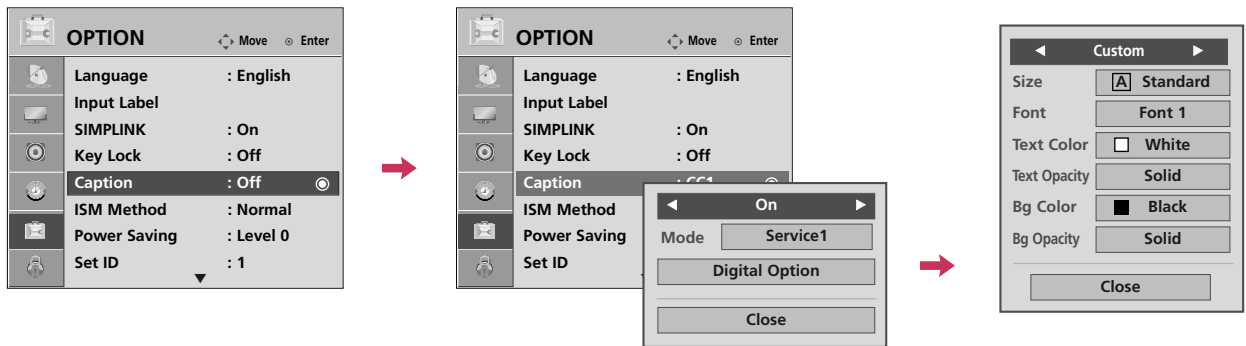





- 1   Select **OPTION**.
- 2   Select **Caption**.
- 3   Select **On**.
- 4   Select **CC1-4, Text1-4, or Service1 - 6**.
- 5  Return to the previous menu.
-  Return to TV viewing.

# SOUND & LANGUAGE CONTROL

## Caption Option

Customize the DTV/CADTV captions that appear on your screen.  
This function is only available when **Caption Mode** is set **On**.



- 1   Select **OPTION**.
- 2   Select **Caption**
- 3   Select **On**.
- 4   Select **Digital Option**.
- 5   Select **Custom**.
- 6   Customize the **Style, Font**, etc., to your preference. A preview icon is provided at the bottom of the screen, use it to see the caption language.
- 7  Return to the previous menu.
-  Return to TV viewing.

- **Size:** Set the word size.
- **Font:** Select a typeface for the text.
- **Text Color:** Choose a color for the text.
- **Text Opacity:** Specify the opacity for the text color.
- **Bg (Background) Color:** Select a background color.
- **Bg (Background) Opacity:** Select the opacity for the background color.

# TIME SETTING

## CLOCK SETTING









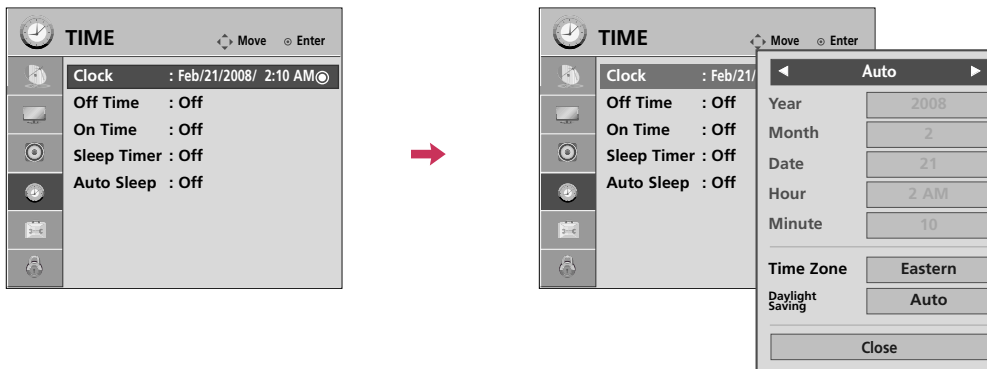



### Auto Clock Setup

The time is set automatically from a digital channel signal.

The digital channel signal includes information for the current time provided by the broadcasting station.

Set the clock manually if the current time is set incorrectly by the auto clock function.











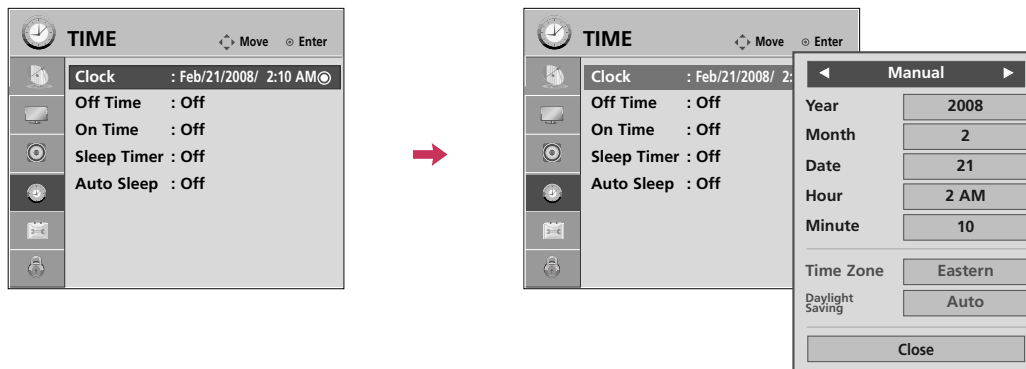

- 1   Select **TIME**.
- 2   Select **Clock**.
- 3   Select **Auto**.
- 4   Select your viewing area time zone.
  - U.S.A: **Eastern, Central, Mountain, Pacific, Alaska, or Hawaii.**
  - Canada: **Eastern, Central, Mountain, Pacific, New F.land, or Atlantic.**
- 5   Select **Auto, On, or Off** (depending on whether or not your viewing area observes Daylight Saving time).
- 6  Return to the previous menu.
-  Return to TV viewing.

# TIME SETTING

## Manual Clock Setup

If the current time setting is wrong, set the clock manually.



- 1   Select **TIME**.
- 2   Select **Clock**.
- 3   Select **Manual**.
- 4  Select the Year, Month, Date, Hour, or Minutes option.
- 5  Set the Year, Month, Date, Hour, or Minutes option.
- 6  Return to the previous menu.
-  Return to TV viewing.



# AUTO ON/OFF TIME SETTING

This function operates only if the current time has been set.

The **Off Time** function overrides the **On Time** function if they are both set to the same time.

The TV must be in standby mode for the **On Time** to work.

If you do not press any button within 2 hours after the TV turns on with the **On Time** function, the TV will automatically revert to standby mode.

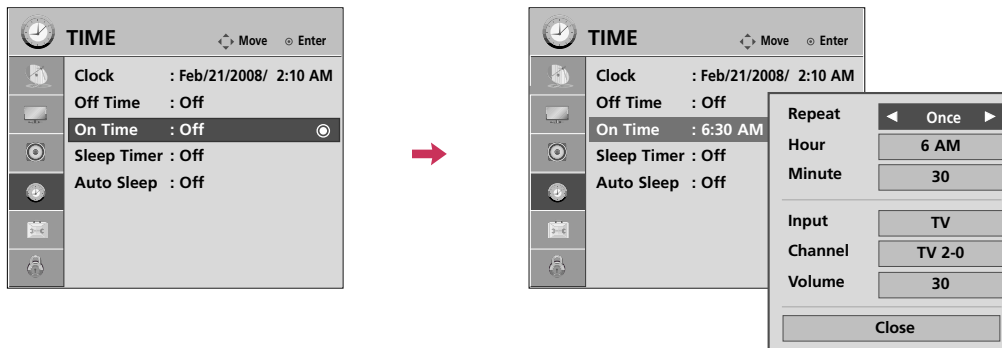

- 1 Select **TIME**.
- 2 Select **Off time** or **On time**.
- 3 Select **Repeat**.
- 4 Select **Off, Once, Everyday, Mon~Fri, Mon~Sat, Weekend, or Sunday**.
- 5 Select and set **Hour** or **Minute**.
- 6 Return to the previous menu.
- Return to TV viewing.



- To cancel **On/Off Time** function, select **Off**.
  - Only for **On Time** function
- 1 Select **Input**.
  - 2 Select **TV, AV1 -2, Component1 -2, RGB-PC, or HDMI1 -3**.
  - 3 When Selecting **TV**: set the channel at turn-on.
  - 4 Adjust to sound level at turn-on.

# TIME SETTING

## SLEEP TIMER SETTING

The Sleep Time turns the TV off at the preset time.  
Note that this setting is cleared when the TV is turned off.









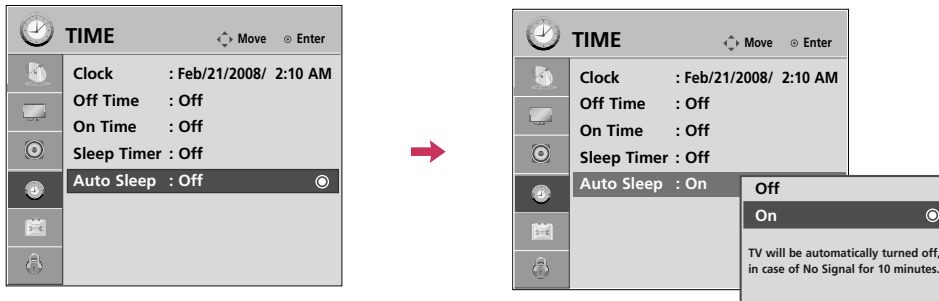

-  Select **Off**, **10**, **20**, **30**, **60**, **90**, **120**, **180**, or **240** minutes.
-  Return to TV viewing.

# AUTO SHUT-OFF SETTING

TV will be automatically turned off, in case of no signal for 10 minutes.



-   Select **TIME**.
-   Select **Auto Sleep**.
-   Select **On** or **Off**.
-  Return to the previous menu.
-  Return to TV viewing.

# PARENTAL CONTROL / RATINGS

Parental Control can be used to block specific channels, ratings and other viewing sources.

The Parental Control Function (V-Chip) is used to block program viewing based on the ratings sent by the broadcasting station. The default setting is to allow all programs to be viewed. Viewing can be blocked by choosing the type of the program and the categories. It is also possible to block all program viewing for a time period. To use this function, the following must be done :

1. Set ratings and categories to be blocked.
2. Specify a password
3. Enable the lock

## V-Chip rating and categories

Rating guidelines are provided by broadcasting stations. Most television programs and television movies can be blocked by TV Rating and/or Individual Categories. Movies that have been shown at the theaters or direct-to-video movies use the Movie Rating System (MPAA) only.

## Ratings for Television programs including made-for-TV movies :

- TV-G (General audience)
- TV-PG (Parental guidance suggested)
- TV-14 (Parents strongly cautioned)
- TV-MA (Mature audience only)
- TV-Y (All children)
- TV-Y7 (Children 7 years older)

## SET PASSWORD & LOCK SYSTEM

### Setting up Your Password

Set up blocking schemes to block specific channels, ratings, and external viewing sources. A password is required to gain access to this menu.



1 MENU Select LOCK.



2 Input the password.

- Enter the password as requested.
- The TV is set up with the initial password "0-0-0-0".

## Lock System

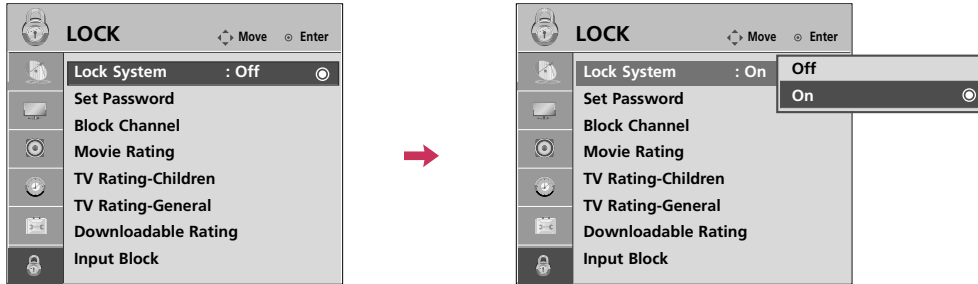
Enables or disables the blocking scheme you set up previously.





1    Select **LOCK**.

2  Input the password.

3  Select **Lock System**.

4   Select **On** or **Off**.

5  Return to the previous menu.

 Return to TV viewing.

- When you select **On**, the Lock System is enable.

# PARENTAL CONTROL / RATINGS

## Set Password

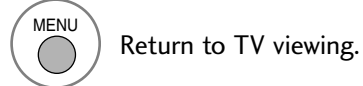
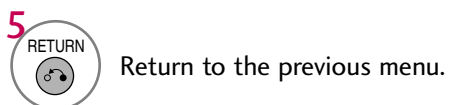
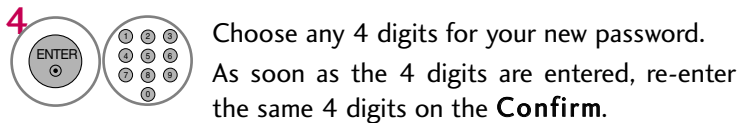
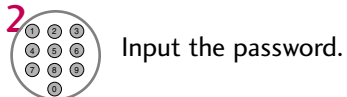
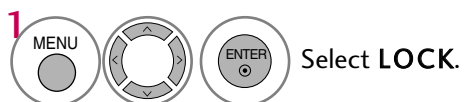
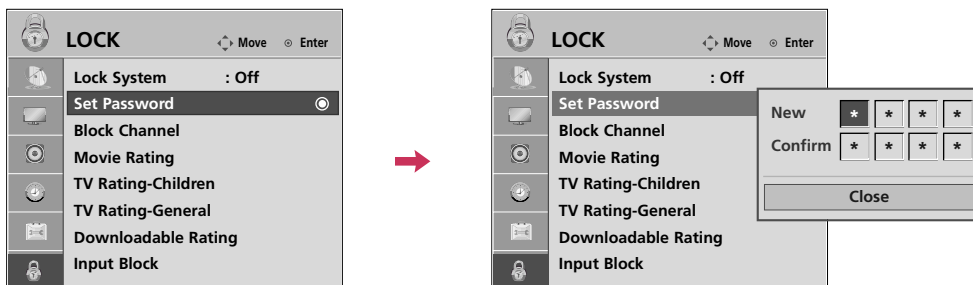

Change the password by inputting a new password twice.



# CHANNEL BLOCKING

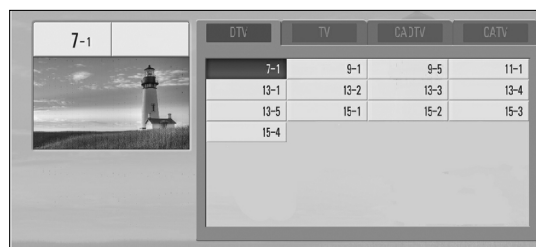
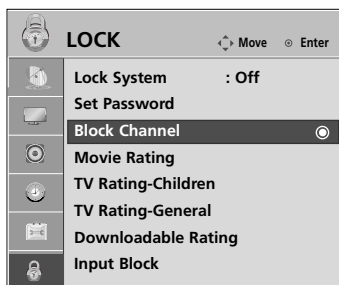

Blocks any channels that you do not want to watch or that you do not want your children to watch.





1    Select **LOCK**.

2  Input the password.

3  Select **Block Channel**.

4   Select a channel to block or unblock.

5  Block or unblock a channel.

6  Return to the previous menu.

 Return to TV viewing.

# PARENTAL CONTROL / RATINGS

## MOVIE & TV RATING

### Movie Rating (MPAA) - For USA only

Blocks movies according to the movie ratings limits specified, so children cannot view certain movies. You can set the ratings limit by blocking out all the movies with the ratings above a specified level. Keep in mind that the movie ratings limit only applies to movies shown on TV, not TV programs, such as soap operas.

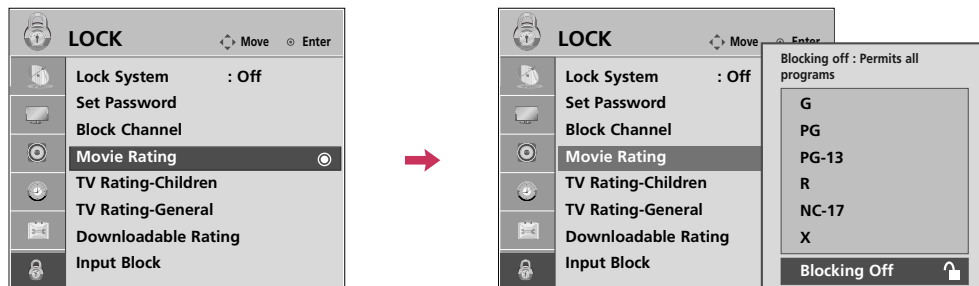

1 MENU Select LOCK.

2 Input the password.

3 Select **Movie Rating**.

4 Select **G, PG, PG-13, R, NC-17, X, or Blocking Off**.

5 RETURN Return to the previous menu.

MENU Return to TV viewing.



- G (General audience)
- PG (Parental guidance suggested)
- PG-13 (Parents strongly cautioned)
- R (Restricted)
- NC-17 (No one 17 and under admitted)
- X (Adult only)
- Blocking Off (Permits all programs)
- ▶ If you set PG-13: G and PG movies will be available, PG-13, R, NC-17 and X will be blocked.

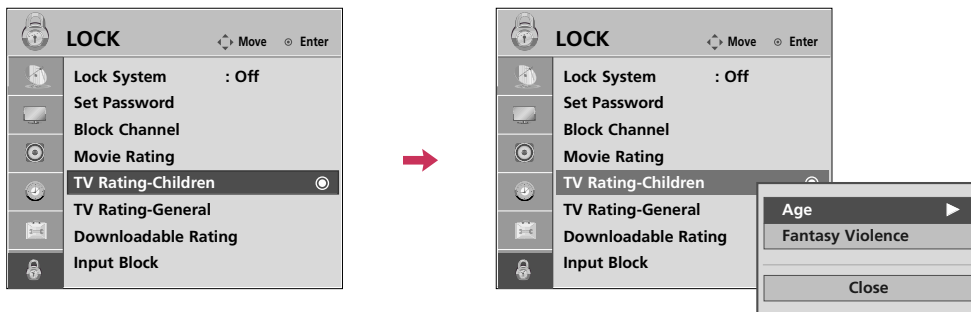

## TV Rating Children - For USA only

Prevents children from watching certain children's TV programs, according to the ratings limit set. The children rating does not apply to other TV programs. Unless you block certain TV programs intended for mature audiences in the TV Rating - sub menu, your children can view those programs.



1    Select **LOCK**.

2  Input the password.

3  Select **TV Rating-Children**.

4   Select **Age** or **Fantasy Violence**.

5   Select block options.

6  Return to the previous menu.

 Return to TV viewing.

- Age (applies to TV-Y, TV-Y7)
- Fantasy Violence (applies to TV-Y7)

# PARENTAL CONTROL / RATINGS

## TV Rating General - For USA only

Based on the ratings, blocks certain TV programs that you and your family do not want to view.

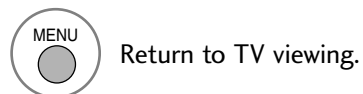
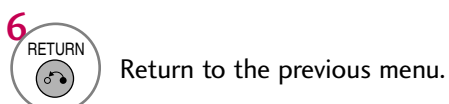
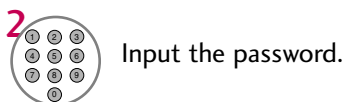
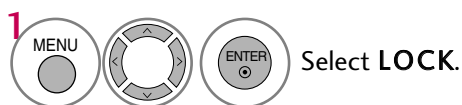
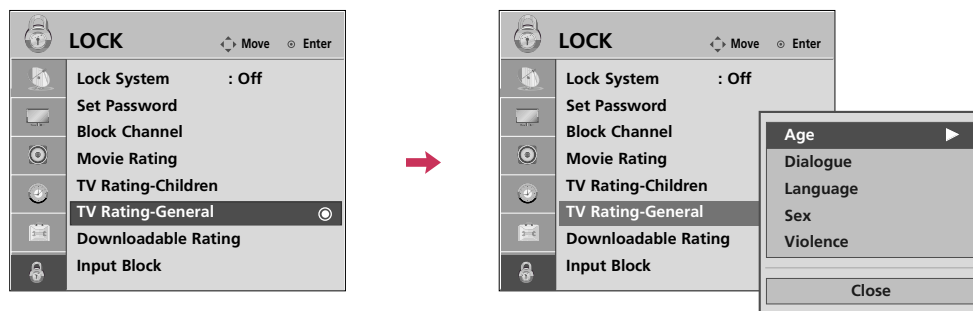



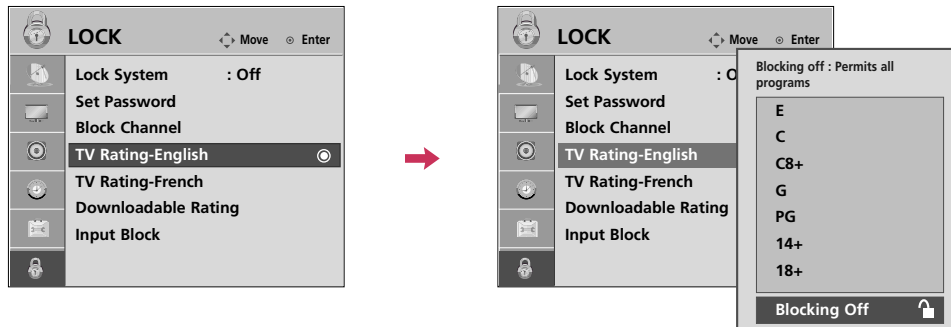

- Age (applies to TV-G,TV-PG,TV-14,TV-MA).
- Dialogue-sexual dialogue (applies to TV-PG,TV-14).
- Language-adult language (applies to TV-PG, TV-14, TV-MA).
- Sex-sexual situations (applies to TV-PG, TV-14, TV-MA).
- Violence (applies to TV-PG, TV-14, TV-MA).

## TV Rating English - For CANADA only



Selecting canadian english language rating system.





1    Select **LOCK**.

2  Input the password.

3  Select **TV Rating-English**.

4   Select **E, C, C8+, G, PG, 14+, 18+, or Blocking Off**.

5  Return to the previous menu.

 Return to TV viewing.

- E (Exempt)
- C (Children)
- C8+ (Children eight years and older)
- G (General programming, suitable for all audiences)
- PG (Parental Guidance)
- 14+ (Viewers 14 years and older)
- 18+ (Adult programming)
- Blocking Off (Permits all programs)

# PARENTAL CONTROL / RATINGS

## TV Rating French - *For CANADA only*

Selecting canadian french language rating system.

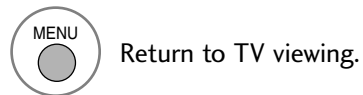
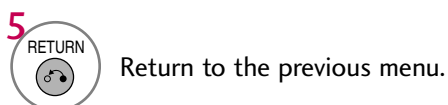
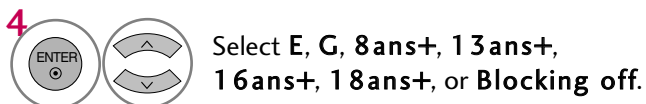
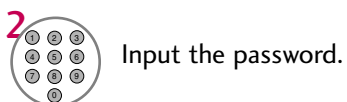
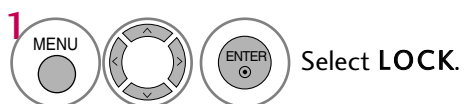
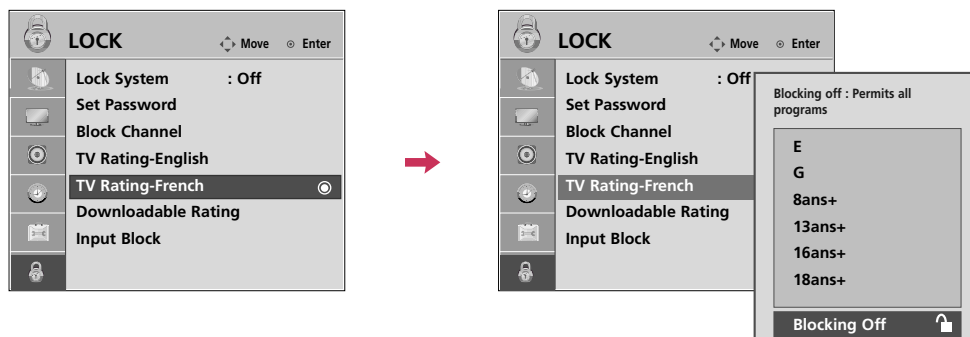







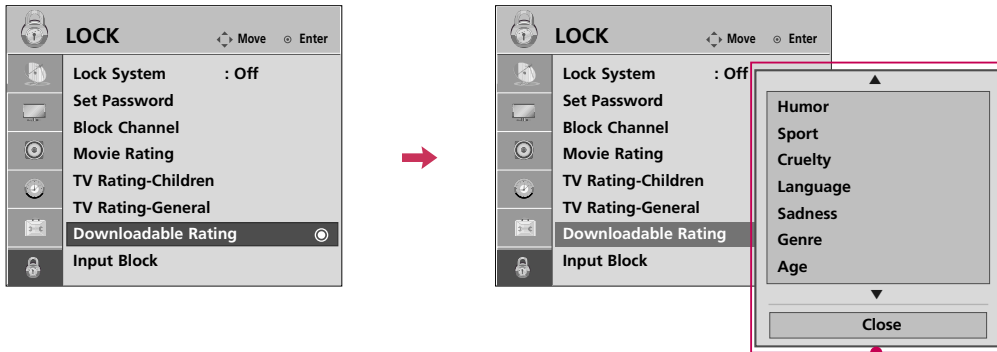



- E (Exempt)
- G (General)
- 8ans+ (General-Not convenient for little children)
- 13ans+ (Not convenient for children of 13 years and younger)
- 16ans+ (Not convenient for children of 16 years and younger)
- 18ans+ (This programs is only for adults)
- Blocking off (Permits all programs)

# DOWNLOADABLE RATING

This function may become available in the future and will be available only for digital channels.  
This function operates only when TV has received Region5 Rating data.



■ Based on rating table, your TV's OSD (On Screen Display) may differ slightly from what is shown in this manual.

- 1    Select **LOCK**.
- 2  Input the password.
- 3  Select **Downloadable Rating**.
- 4   Select desired **Downloadable Rating** option.
- 5   Select desired option and block it.
- 6  Return to the previous menu.
-  Return to TV viewing.

# PARENTAL CONTROL / RATINGS

## EXTERNAL INPUT BLOCKING

Enables you to block an input.

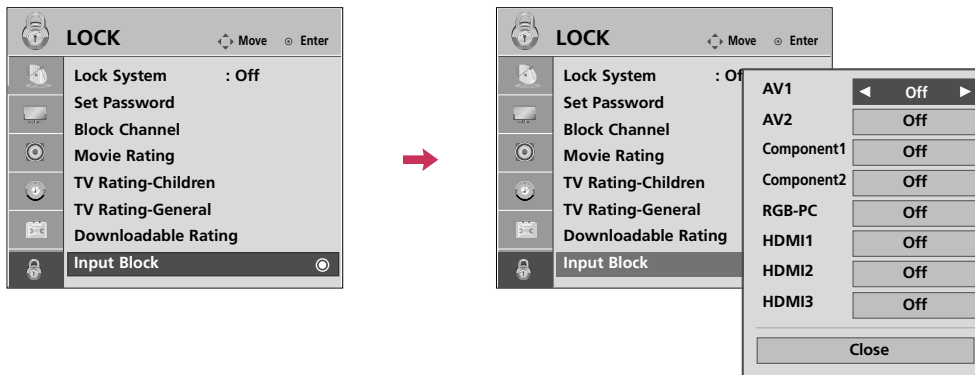

1 MENU Select **LOCK**.

2 Input the password.

3 Select **Input Block**.

4 Select input source.

5 Select **On** or **Off**.

6 RETURN Return to the previous menu.

MENU Return to TV viewing.







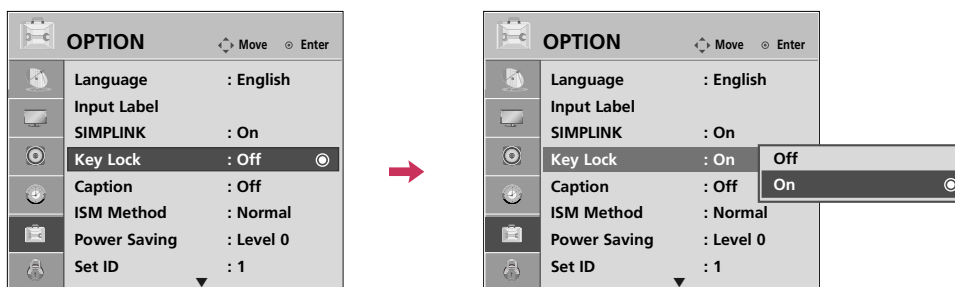

## KEY LOCK

The TV can be set up so that it can only be used with the remote control.

This feature can be used to prevent unauthorized viewing by locking out the front panel controls.

This TV is programmed to remember which option it was last set to even if you turn the TV off.



- 1   Select **OPTION**.
- 2   Select **Key Lock**.
- 3   Select **On** or **Off**.
- 4  Return to the previous menu.
-  Return to TV viewing.

- In **Key Lock 'On'**, if the TV is turned off, press the **⏻ / I**, **INPUT**, **CH ▲ ▼** button on the TV or **POWER**, **INPUT**, **CH ^ v** or **NUMBER** buttons on the remote control.
- With the **Key Lock On**, the display **'⚠ Key Lock'** appears on the screen if any button on the front panel is pressed while viewing the TV.

# APPENDIX

## TROUBLESHOOTING

### The operation does not work normally.

The remote control doesn't work

- Check to see if there is any object between the product and the remote control causing obstruction. Ensure you are pointing the remote control directly at the TV.
- Ensure that the batteries are installed with correct polarity (+ to +, - to -).
- Ensure that the correct remote operating mode is set: TV, VCR etc.
- Install new batteries.

Power is suddenly turned off

- Is the sleep timer set?
- Check the power control settings. Power interrupted.

### The video function does not work.

No picture & No sound

- Check whether the product is turned on.
- Try another channel. The problem may be with the broadcast.
- Is the power cord inserted into wall power outlet?
- Check your antenna direction and/or location.
- Test the wall power outlet, plug another product's power cord into the outlet where the product's power cord was plugged in.

Picture appears slowly after switching on

- This is normal, the image is muted during the product startup process. Please contact your service center, if the picture has not appeared after five minutes.

No or poor color or poor picture

- Adjust Color in menu option.
- Keep a sufficient distance between the product and the VCR.
- Try another channel. The problem may be with the broadcast.
- Are the video cables installed properly?
- Activate any function to restore the brightness of the picture.

Horizontal/vertical bars or picture shaking

- Check for local interference such as an electrical appliance or power tool.

Poor reception on some channels

- Station or cable product experiencing problems, tune to another station.
- Station signal is weak, reorient antenna to receive weaker station.
- Check for sources of possible interference.

Lines or streaks in pictures

- Check antenna (Change the direction of the antenna).



### The audio function does not work.

Picture OK & No sound	<ul style="list-style-type: none"><li>■ Press the VOL or VOLUME button.</li><li>■ Sound muted? Press MUTE button.</li><li>■ Try another channel. The problem may be with the broadcast.</li><li>■ Are the audio cables installed properly?</li></ul>
No output from one of the speakers	<ul style="list-style-type: none"><li>■ Adjust Balance in menu option.</li></ul>
Unusual sound from inside the product	<ul style="list-style-type: none"><li>■ A change in ambient humidity or temperature may result in an unusual noise when the product is turned on or off and does not indicate a fault with the product.</li></ul>

### There is a problem in PC mode. (Only PC mode applied)

The signal is out of range	<ul style="list-style-type: none"><li>■ Adjust resolution, horizontal frequency, or vertical frequency.</li><li>■ Check the input source.</li></ul>
Vertical bar or stripe on background & Horizontal Noise & Incorrect position	<ul style="list-style-type: none"><li>■ Work the Auto configure or adjust clock, phase, or H/V position. (Option)</li></ul>
Screen color is unstable or single color	<ul style="list-style-type: none"><li>■ Check the signal cable.</li><li>■ Reinstall the PC video card.</li></ul>

# APPENDIX

## MAINTENANCE

Early malfunctions can be prevented. Careful and regular cleaning can extend the amount of time you can enjoy your new TV.

**Caution:** Be sure to turn the power off and unplug the power cord before you begin any cleaning.

### Cleaning the Screen

- 1 Here's a great way to keep the dust off your screen for a while. Wet a soft cloth in a mixture of lukewarm water and a little fabric softener or dish washing detergent. Wring the cloth until it's almost dry, and then use it to wipe the screen.
- 2 Make sure the excess water is off the screen, and then let it air-dry before you turn on your TV.

### Cleaning the Cabinet

- To remove dirt or dust, wipe the cabinet with a soft, dry, lint-free cloth.
- Please be sure not to use a wet cloth.

### Extended Absence

#### ⚠ CAUTION

- ▶ If you expect to leave your TV dormant for a long time (such as a vacation), it's a good idea to unplug the power cord to protect against possible damage from lightning or power surges.

## PRODUCT SPECIFICATIONS

MODEL		42PG10 (42PG10-UA)	42PG20 (42PG20-UA) 42PG20C (42PG20C-UA)
Dimensions (Width x Height x Depth)	With stand	40.9 x 28.7 x 12.1 inches 1040.0 x 729.0 x 308.0 mm	40.9 x 28.7 x 12.1 inches 1040.0 x 731.3 x 308.0 mm
	Without stand	40.9 x 26.6 x 3.2 inches 1040.0 x 677.0 x 83.6 mm	40.9 x 26.6 x 3.3 inches 1040.0 x 677.0 x 86.0 mm
Weight	With stand	57.3 pounds / 26.0 kg	58.2 pounds / 26.4 kg
	Without stand	52.9 pounds / 24.0 kg	53.5 pounds / 24.3 kg
Power requirement Television System Program Coverage External Antenna Impedance		AC100-120V ~ 50/60Hz NTSC-M, ATSC, 64 & 256 QAM VHF 2-13, UHF 14-69, CATV 1-135, DTV 2-69, CADTV 1-135 75 ohm	
Environment condition	Operating Temperature Operating Humidity	32 ~ 104°F (0 ~ 40°C) Less than 80%	
	Storage Temperature Storage Humidity	-4 ~ 140°F (-20 ~ 60°C) Less than 85%	

- The specifications shown above may be changed without prior notice for quality improvement.

MODELS		50PG10 (50PG10-UA)	50PG20 (50PG20-UA) 50PG20C (50PG20C-UA)
Dimensions (Width x Height x Depth)	With stand	48.2 x 33.4 x 14.3 inches 1224.7 x 849.0 x 364.0 mm	48.2 x 33.4 x 14.3 inches 1224.7 x 849.0 x 364.0 mm
	Without stand	48.2 x 31.1 x 3.2 inches 1224.7 x 790.0 x 83.6 mm	48.2 x 31.1 x 3.3 inches 1224.7 x 790.0 x 86.0 mm
Weight	With stand	91.4 pounds / 41.5 kg	90.8 pounds / 41.2 kg
	Without stand	83.9 pounds / 38.1 kg	83.3 pounds / 37.8 kg
MODELS		50PG30 (50PG30F-UA)	60PG30 (60PG30F-UA)
Dimensions (Width x Height x Depth)	With stand	48.5 x 33.4 x 14.3 inches 1232.0 x 850.0 x 363.6 mm	57.7 x 39.7 x 16.2 inches 1468.0 x 1009.1 x 413.9 mm
	Without stand	48.5 x 31.2 x 3.3 inches 1232.0 x 793.0 x 84.0 mm	57.7 x 37.3 x 3.4 inches 1468.0 x 949.5 x 88.5 mm
Weight	With stand	93.2 pounds / 42.3 kg	177.6 pounds / 80.6 kg
	Without stand	84.4 pounds / 38.3 kg	160.0 pounds / 72.6 kg
Power requirement Television System Program Coverage External Antenna Impedance		AC100-240V ~ 50/60Hz NTSC-M, ATSC, 64 & 256 QAM VHF 2-13, UHF 14-69, CATV 1-135, DTV 2-69, CADTV 1-135 75 ohm	
Environment condition	Operating Temperature Operating Humidity	32 ~ 104°F (0 ~ 40°C) Less than 80%	
	Storage Temperature Storage Humidity	-4 ~ 140°F (-20 ~ 60°C) Less than 85%	

- The specifications shown above may be changed without prior notice for quality improvement.

## IR CODES

### 1. How to Connect

- Connect your wired remote control to the Remote Control port on the TV.

### 2. Remote Control IR Codes

#### ■ Output waveform

Single pulse, modulated with 37.917KHz signal at 455KHz

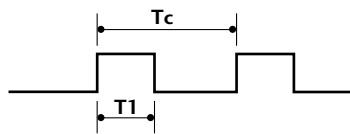

Carrier frequency  
 $FCAR = 1/TC = fOSC/12$   
 Duty ratio =  $T1/TC = 1/3$

#### ■ Configuration of frame

1st frame

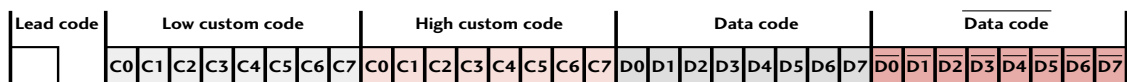

Repeat frame

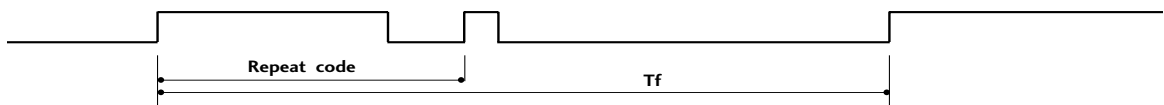

#### ■ Lead code

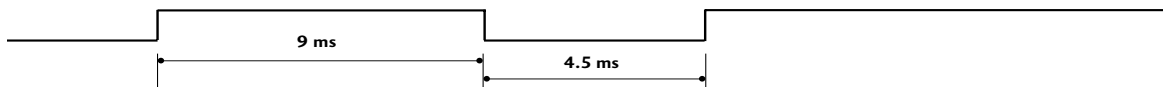

#### ■ Repeat code

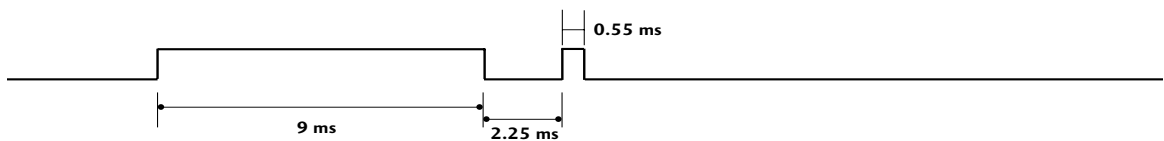

#### ■ Bit description

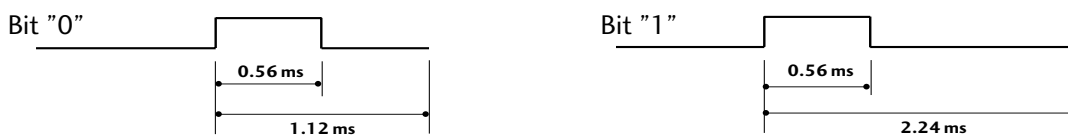

#### ■ Frame interval: Tf

The waveform is transmitted as long as a key is depressed.

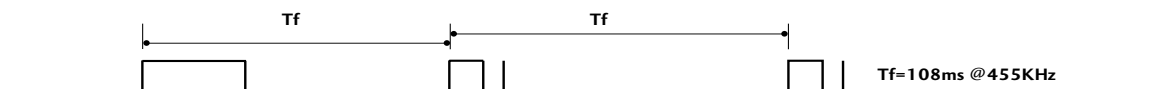

Code (Hexa)	Function	Note
08	POWER	Remote control Button (Power On/Off)
45	Q.MENU	Remote control Button
43	MENU	Remote control Button
0B	INPUT	Remote control Button
10-19	Number Key 0-9	Remote control Button
4C	- (Dash)	Remote control Button
1A	FLASHBK	Remote control Button
09	MUTE	Remote control Button
02	VOL +	Remote control Button
03	VOL -	Remote control Button
00	CH ^	Remote control Button
01	CH v	Remote control Button
1E	FAV	Remote control Button
40	^	Remote control Button
41	v	Remote control Button
07	<	Remote control Button
06	>	Remote control Button
44	ENTER	Remote control Button
5B	RETURN	Remote control Button
7E	SIMPLINK	Remote control Button
30	AV MODE	Remote control Button
79	RATIO	Remote control Button
0E	SLEEP	Remote control Button
52	SOUND	Remote control Button
4D	PICTURE	Remote control Button

## EXTERNAL CONTROL THROUGH RS-232C

The RS-232C port allows you connect the RS-232C input jack to an external control device (such as a computer or an A/V control system) to control the TV's functions externally.

- **Note:** RS-232C on this unit is intended to be used with third party RS-232C control hardware and software. The instructions below are provided to help with programming software or to test functionality using telenet software.

### RS-232C Setup

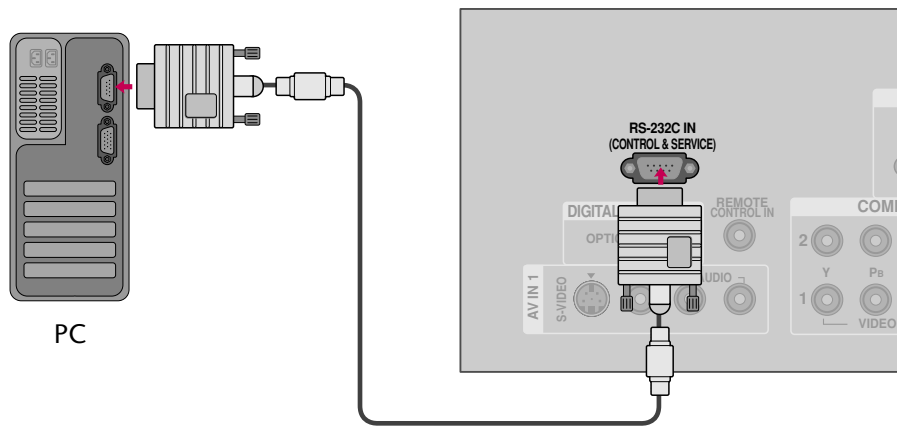

#### Type of Connector; D-Sub 9-Pin Male

No.	Pin Name
1	No connection
2	RXD (Receive data)
3	TXD (Transmit data)
4	DTR (DTE side ready)
5	GND
6	DSR (DCE side ready)
7	RTS (Ready to send)
8	CTS (Clear to send)
9	No Connection

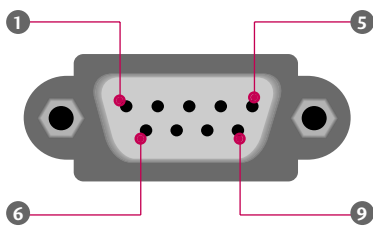

#### Communication Parameters

- Baud rate : 9600 bps (UART)
- Data length : 8 bits
- Parity : None
- Stop bit : 1 bit
- Communication code : ASCII code
- Use a crossed (reverse) cable.

## RS-232C Configurations

Either cable below can be used.

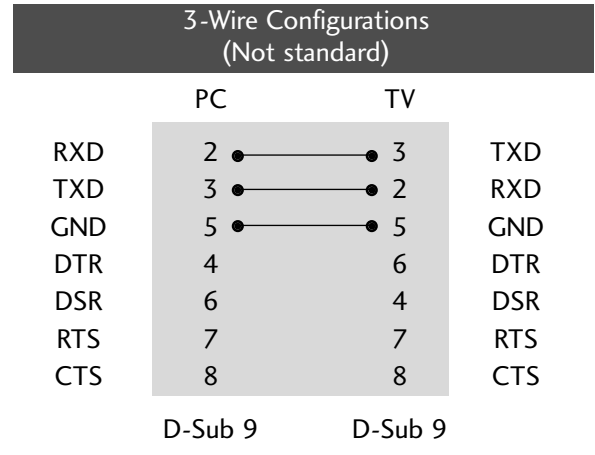
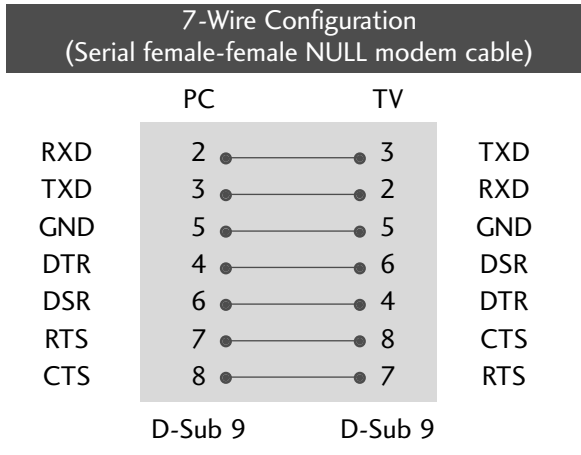







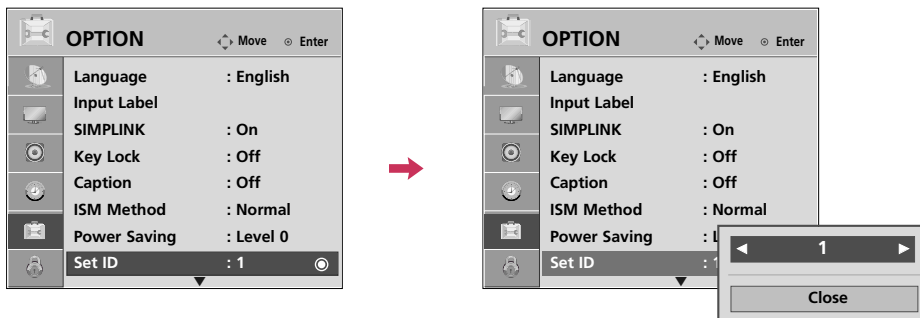

## Set ID

Use this function to specify a TV ID number.

Refer to 'Real Data Mapping' ► p.97.



- 1   Select **OPTION**.
- 2   Select **Set ID**.
- 3   Choose the desired TV ID number.  
The adjustment range of Set ID is 1~99.
- 4  Return to the previous menu.
-  Return to TV viewing.

## Command Reference List

	COMMAND1	COMMAND2	DATA (Hexadecimal)		COMMAND1	COMMAND2	DATA (Hexadecimal)
01. Power	k	a	00 ~ 01	14. Treble	k	r	00 ~ 64
02. Input Select	x	b	(▶ p.95)	15. Bass	k	s	00 ~ 64
03. Aspect Ratio	k	c	(▶ p.95)	16. Balance	k	t	00 ~ 64
04. Screen Mute	k	d	00 ~ 01	17. Color Temperature	k	u	00 ~ 02
05. Volume Mute	k	e	00 ~ 01	18. ISM Method	j	p	(▶ p.96)
06. Volume Control	k	f	00 ~ 64	19. Power Saving	j	q	00 ~ 01
07. Contrast	k	g	00 ~ 64	20. Auto Configuration	j	u	(▶ p.96)
08. Brightness	k	h	00 ~ 64	22. Channel Add/Del	m	b	00 ~ 01
09. Color	k	i	00 ~ 64	23. Key	m	c	(▶ p.97)
10. Tint	k	j	00 ~ 64				
11. Sharpness	k	k	00 ~ 64				
12. OSD Select	k	l	00 ~ 01				
13. Remote Control Lock Mode	k	m	00 ~ 01				

	COMMAND1	COMMAND2	DATA00 (Hexadecimal)	DATA01 (Hexadecimal)	DATA02 (Hexadecimal)	DATA03 (Hexadecimal)	DATA04 (Hexadecimal)	DATA05 (Hexadecimal)
21. Channel Tuning	m	a	physical program high	major program low	major low	minor high	minor low	attribute

## Transmission / Receiving Protocol

### Transmission

**[Command1][Command2][ ][Set ID][ ][Data][Cr]**

[Command 1] : First command to control the set.(j, k, m or x)

[Command 2] : Second command to control the set.

[Set ID] : You can adjust the set ID to choose desired TV ID number in Setup menu. Adjustment range is 1 ~ 99. When selecting Set ID '0', every connected the TV is controlled. Set ID is indicated as decimal (1 ~ 99) on menu and as Hexa decimal (0x0 ~ 0x63) on transmission /receiving protocol.

[DATA] : To transmit the command data.

Transmit the 'FF' data to read status of command.

[Cr] : Carriage Return

ASCII code '0x0D'

[ ] : ASCII code 'space (0x20)'

\* In this model, TV will not send the status during the standby mode.

### OK Acknowledgement

**[Command2][ ][Set ID][ ][OK][Data][x]**

The TV transmits ACK (acknowledgement) based on this format when receiving normal data. At this time, if the data is data read mode, it indicates present status data. If the data is data write mode, it returns the data of the PC computer.

\* In this model, TV will not send the status during the standby mode.

\* Data Format

[Command 2] : Use as command.

[Set ID] : Use the small character, if set ID is 10, it will send the '0', 'a'.

[DATA] : Use the small character, if data is 0 x ab, it will send the 'a', 'b'.

[OK] : Use the large character.

### Error Acknowledgement

**[Command2][ ][Set ID][ ][NG][Data][x]**

The TV transmits ACK (acknowledgement) based on this format when receiving abnormal data from non-viable functions or communication errors.

Data1: Illegal Code

Data2: Not supported function

Data3: Wait more time

\* In this model, TV will not send the status during the standby mode.

\* Data Format

[Command 2] : Use as command.

[Set ID] : Use the small character, if set ID is 10, it will send the '0', 'a'.

[DATA] : Use the small character, if data is 0 x ab, it will send the 'a', 'b'.

[NG] : Use the large character



**01. Power (Command: k a)**

To control Power On/Off of the TV.

**Transmission** [k][a][ ][Set ID][ ][Data][Cr]

Data 00: Power Off      Data 01: Power On

**Acknowledgement** [a][ ][Set ID][ ][OK/NG][Data][x]

\* In a like manner, if other functions transmit 'FF' data based on this format, Acknowledgement data feedback presents status about each function.

\* Note: In this model, TV will send the Acknowledge after power on processing completion.

There might be a time delay between command and acknowledge.

**02. Input Select (Command: x b)**

To select input source for TV.

**Transmission** [x][b][ ][Set ID][ ][Data][Cr]

Data 10: TV

Data 20: AV1      Data 21: AV2

Data 40: Component 1      Data 41: Component 2

Data 60: RGB-PC      Data 90: HDMI1

Data 91: HDMI2      Data 92: HDMI3

**Acknowledgement** [b][ ][Set ID][ ][OK/NG][Data][x]

**03. Aspect Ratio (Command: k c)**

To adjust the screen format.

**Transmission** [k][c][ ][Set ID][ ][Data][Cr]

Data 01: 4:3      05: Zoom 2

02: 16:9      06: Set by program

04: Zoom 1      09: Just scan

⋮

Reserved

**Acknowledgement** [c][ ][Set ID][ ][OK/NG][Data][x]

**04. Screen Mute (Command: k d)**

To select screen mute on/off.

**Transmission** [k][d][ ][Set ID][ ][Data][Cr]

Data 00: Screen mute off (Picture on)

Data 01: Screen mute on (Picture off)

**Acknowledgement** [d][ ][Set ID][ ][OK/NG][Data][x]

**05. Volume Mute (Command: k e)**

To control volume mute on/off.

You can also adjust mute using the MUTE button on remote control.

**Transmission** [k][e][ ][Set ID][ ][Data][Cr]

Data 00: Volume mute on (Volume off)

Data 01: Volume mute off (Volume on)

**Acknowledgement** [e][ ][Set ID][ ][OK/NG][Data][x]

**06. Volume Control (Command: k f)**

To adjust volume.

You can also adjust volume with the volume buttons on remote control.

**Transmission** [k][f][ ][Set ID][ ][Data][Cr]

Data Min: 00 ~ Max: 64 (\*transmit by Hexadecimal code)

\*Refer to 'Real data mapping'. See page 97.

**Acknowledgement** [f][ ][Set ID][ ][OK/NG][Data][x]

**07. Contrast (Command: k g)**

To adjust screen contrast.

You can also adjust contrast in the PICTURE menu.

**Transmission** [k][g][ ][Set ID][ ][Data][Cr]

Data Min: 00 ~ Max: 64 (\*transmit by Hexadecimal code)

\*Refer to 'Real data mapping'. See page 97.

**Acknowledgement** [g][ ][Set ID][ ][OK/NG][Data][x]

**08. Brightness (Command: k h)**

To adjust screen brightness.

You can also adjust brightness in the PICTURE menu.

**Transmission** [k][h][ ][Set ID][ ][Data][Cr]

Data Min: 00 ~ Max: 64 (\*transmit by Hexadecimal code)

\*Refer to 'Real data mapping'. See page 97.

**Acknowledgement** [h][ ][Set ID][ ][OK/NG][Data][x]

**09. Color (Command: k i)**

To adjust screen color.

You can also adjust color in the PICTURE menu.

**Transmission** [k][i][ ][Set ID][ ][Data][Cr]

Data Min: 00 ~ Max: 64 (\*transmit by Hexadecimal code)

\*Refer to 'Real data mapping'. See page 97.

**Acknowledgement** [i][ ][Set ID][ ][OK/NG][Data][x]

**10. Tint (Command: k j)**

To adjust screen tint.

You can also adjust tint in the PICTURE menu.

**Transmission** [k][j][ ][Set ID][ ][Data][Cr]

Data Red: 00 ~ Green: 64 (\*transmit by Hexadecimal code)

\*Refer to 'Real data mapping'. See page 97.

**Acknowledgement** [j][ ][Set ID][ ][OK/NG][Data][x]

**11. Sharpness (Command: k k)**

To adjust screen sharpness.

You can also adjust sharpness in the PICTURE menu.

**Transmission** [k][k][ ][Set ID][ ][Data][Cr]

Data Min: 00 ~ Max: 64 (\*transmit by Hexadecimal code)

\*Refer to 'Real data mapping'. See page 97.

**Acknowledgement** [k][ ][Set ID][ ][OK/NG][Data][x]

## 12. OSD Select (Command: k l)

To select OSD (On Screen Display) on/off.

*Transmission* [k][l][ ][Set ID][ ][Data][Cr]

Data 00: OSD off                      Data 01: OSD on

*Acknowledgement* [l][ ][Set ID][ ][OK/NG][Data][x]

## 13. Remote Control Lock Mode (Command: k m)

To lock the remote control and the front panel controls on the TV.

*Transmission* [k][m][ ][Set ID][ ][Data][Cr]

Data 00: Lock off                      Data 01: Lock on

*Acknowledgement* [m][ ][Set ID][ ][OK/NG][Data][x]

If you're not using the remote control and front panel controls on the TV, use this mode. When main power is on/off, remote control lock is released.

## 14. Treble (Command: k r)

To adjust treble.

You can also adjust treble in the AUDIO menu.

*Transmission* [k][r][ ][Set ID][ ][Data][Cr]

Data Min: 00 ~ Max: 64 (\*transmit by Hexadecimal code)

\*Refer to 'Real data mapping'. See page 97.

*Acknowledgement* [r][ ][Set ID][ ][OK/NG][Data][x]

## 15. Bass (Command: k s)

To adjust bass.

You can also adjust bass in the AUDIO menu.

*Transmission* [k][s][ ][Set ID][ ][Data][Cr]

Data Min: 00 ~ Max: 64 (\*transmit by Hexadecimal code)

\*Refer to 'Real data mapping'. See page 97.

*Acknowledgement* [s][ ][Set ID][ ][OK/NG][Data][x]

## 16. Balance (Command: k t)

To adjust balance.

You can also adjust balance in the AUDIO menu.

*Transmission* [k][t][ ][Set ID][ ][Data][Cr]

Data Min: 00 ~ Max: 64 (\*transmit by Hexadecimal code)

\*Refer to 'Real data mapping'. See page 97.

*Acknowledgement* [t][ ][Set ID][ ][OK/NG][Data][x]

## 17. Color Temperature (Command: k u)

To adjust color temperature.

You can also adjust color temperature in the PICTURE menu.

*Transmission* [k][u][ ][Set ID][ ][Data][Cr]

Data 00: Medium    01: Cool    02: Warm

*Acknowledgement* [u][ ][Set ID][ ][OK/NG][Data][x]

## 18. ISM Method (Command: j p)

To avoid having a fixed image remain on screen.

*Transmission* [j][p][ ][Set ID][ ][Data][Cr]

Data 01: Inversion                      02: Orbiter

04: White Wash                      08: Normal

*Acknowledgement* [p][ ][Set ID][ ][OK/NG][Data][x]

## 19. Power saving (Command: j q)

To control the low power function on/off.

*Transmission* [j][q][ ][Set ID][ ][Data][Cr]

Data 00: Power saving off (Power Saving Level 0)

01: Power saving on (Power Saving Level 4)

*Acknowledgement* [q][ ][Set ID][ ][OK/NG][Data][x]

## 20. Auto Configuration (Command: j u)

To adjust picture position and minimize image shaking automatically. Auto configuration only works in RGB-PC mode.

*Transmission* [j][u][ ][Set ID][ ][Data][Cr]

Data 1: To set

*Acknowledgement* [u][ ][Set ID][ ][OK/NG][Data][x]

## 21. Channel Tuning (Command: m a)

To tune channel to following physical/major/minor number.

*Transmission* [m][a][ ][Set ID][ ][Data00][ ][Data01][ ][Data02][ ][Data03][ ][Data04][ ][Data05][Cr]

Digital channels have a Physical, Major, and Minor channel number. The Physical number is the actual digital channel number, the Major is the number that the channel should be mapped to, and the Minor is the sub-channel. Since the ATSC tuner automatically maps the channel to the Major number, the Physical number is not required when sending a command.

Data 00: Physical Channel Number

NTSC air: 02~45, NTSC cable: 01, 0E~7D

ATSC air: 01~45, ATSC cable: 01~87

Data 01 & 02: Major Channel Number

Data 01: High byte

Data 02: Low byte

Two bytes are available for the Major and Minor, normally only the second byte is used.

Data 03 & 04: Minor Channel Number

Not needed for NTSC.

Data 05:

7	Main/Sub Picture	6	Two/One Part Channel	5	Using Physical Channel	4	Reserved	3	2	1	0	Step
0	Main	0	Two	0	Use	x		0	0	0	0	NTSC Air
1	Sub	1	One	1	No Use	x		0	0	0	1	NTSC Cable
						x		0	0	1	0	ATSC Air
						x		0	0	1	1	ATSC Cable_std
						x		0	1	0	0	ATSC Cable_hrc
						x		0	1	0	1	ATSC Cable_irc
						x		0	1	1	0	ATSC cable_auto
						x		0	1	1	1	Reserved
						x		x	x	x	x	...
						x		1	1	1	1	Reserved

The table above lists the binary code which must be converted to Hexadecimal before sending. For example: The binary code to tune the sub source to an NTSC cable channel is "1000 0001", which translates to "81" in Hex.

- \* 7th bit : For which source do you want to change the channel.
- \* 6th bit: Use a two part or one part channel. Most cases just use 0 since it's ignored when using NTSC.
- \* 5th bit: Use 0 with NTSC since it can only use the physical channel number. Normally use 1 for ATSC since most times it doesn't matter what the physical number is.
- \* 4th bit: Set to 0.
- \* 3-0 bits: Choose signal type.

\* Tune Command Examples:

1. Tune to the analog (NTSC) cable channel 35.

Data 00 = Physical of 35 = 23  
 Data 01 & 02 = No Major = 00 00  
 Data 03 & 04 = No Minor = 00 00  
 Data 05 = 0000 0001 in binary = 01  
 Total = ma 00 23 00 00 00 00 01

2. Tune to the digital (ATSC) local channel 30-3.

Data 00 = Don't know Physical = 00  
 Data 01 & 02 = Major is 30 = 00 1E  
 Data 03 & 04 = Minor is 3 = 00 03  
 Data 05 = 0010 0010 in binary = 22  
 Total = ma 00 00 00 1E 00 03 22

```
Acknowledgement[a][ ][Set ID][ ][OK][Data00][Data01]
[Data02][Data03][Data04][x][a][ ][Set ID]
[ ][NG][Data00][x]
```

## 22. Channel Add/Del (Command: m b)

To add and delete the channels.

```
Transmission [m][b][ ][Set ID][ ][Data][Cr]
```

Data 00: Channel Delete    Data 01: Channel Add

```
Acknowledgement [b][ ][Set ID][ ][OK/NG][Data][x]
```

## 23. Key (Command: m c)

To send IR remote key code.

```
Transmission [m][c][ ][Set ID][ ][Data][Cr]
```

Data Key code: Refer to page 91.

```
Acknowledgement [c][ ][Set ID][ ][OK/NG][Data][x]
```

\*Real data mapping

0 : Step 0  
 ⋮  
 A : Step 10 (SET ID 10)  
 ⋮  
 F : Step 15 (SET ID 15)  
 10 : Step 16 (SET ID 16)  
 ⋮  
 63 : Step 99 (SET ID 99)  
 64 : Step 100

**LG Electronics Inc.**