



**PlasmaView™**

**VP-42 / VP-42HD / VP-50 / VP-60**  
**Owner's Manual**

# TABLE OF CONTENTS

<b>Introduction .....</b>	<b>2</b>	<b>OSD (On Screen Display) Controls .....</b>	<b>28</b>
<b>Important Information .....</b>	<b>4</b>	Menu Operations .....	28
<b>Limited Warranty .....</b>	<b>8</b>	Picture Adjust Menu .....	33
<b>How to Attach Options to the Plasma Monitor .....</b>	<b>11</b>	Audio Setup Menu .....	40
<b>Part Names and Functions .....</b>	<b>12</b>	Image Options Settings Menu .....	42
Front View .....	12	SETTING 1 Menu .....	44
Rear View / Terminal Board .....	13	SETTING 2 Menu .....	50
Remote Control .....	15	SETTING 3 Menu .....	60
Battery Installation and Replacement .....	17	Language Settings Menu .....	76
Handling the Remote Control .....	18	Video Standard Menu .....	77
Operating Range .....	18	Signal Info. Menu .....	78
<b>Installation .....</b>	<b>19</b>	<b>External Controls .....</b>	<b>79</b>
Connecting Your Computer .....	20	Application .....	79
Connecting Your VCR or Laser Disk Player .....	21	Connections .....	79
Connecting Your DVD Player .....	21	Communication Parameters .....	79
Pin Assignments/Signal Levels for 15-pin RGB (analog) ....	22	Communication Format .....	79
Pin Configuration/Signal of the RGB 3-In Connector (DVI Connector) .....	22	Command Reference List .....	81
<b>Basic Operations .....</b>	<b>23</b>	<b>Table of Signals Supported .....</b>	<b>106</b>
Power .....	23	<b>Troubleshooting .....</b>	<b>109</b>
Volume .....	23	<b>Specifications .....</b>	<b>111</b>
Mute .....	23	<b>Dimensions .....</b>	<b>112</b>
Display .....	23		
Timer Off .....	24		
<b>Aspect Ratio Controls .....</b>	<b>25</b>		
Aspect Ratio Operations (Manual) .....	25		
Wide Screen Operation with Computer Signals .....	27		

# **INTRODUCTION**

## **» Introduction to the Vidikron PlasmaView™ VP-42 / VP-42HD / VP-50 / VP-60 Flat Panel Display Monitor**

Vidikron presents a full line-up of high performance plasma display monitors, perfect for every application. Three models, 42, 50 and 60 inch, all share common style, engineering and design, features and state-of-the-art performance.

These three popular sizes all feature HDTV capable, 16:9 native resolution display panels with advanced engineering innovations to give you the brightest, clearest images possible. Vidikron's superior video processing with 3:2 film detection circuitry is built into the monitors and provides exceptional detail and artifact-free video enhancement, elevating even standard NTSC material to near HD quality.

Multiple aspect ratio control includes Vidikron's IntelliWide mode, offering the ability to view standard video formats in widescreen without loss of image quality. IR and discrete RS-232 controls facilitate glitch-free custom installation, while Dynamic Pixel Protection™ helps to protect the plasma panel from stationery image burn.

A generous number of inputs and the sleekest styling around make these flat panel display monitors a great value and the ideal choice for discerning viewers.

» **The features you'll enjoy include:**

- 16:9 Native Resolution:
  - 853 x 480 (VP-42)
  - 1024 x 768 (VP-42HD)
  - 1365 x 768 (VP-50, VP-60)
- DVI Input with HDCP
- IR and discrete RS-232 Control for custom installation integration
- Dynamic Pixel Protection™ to help prevent stationary image burn
- HDTV Ready
- Less than 5 inches thin

**Contents of the package:**

- Plasma display monitor
- Power cord
- Remote control with two AAA batteries
- User's manual
- Safety metal fittings\*
- Screws for safety metal fittings\*
- Ferrite core (small x 2, large x 2), bands
- Cable clamps

\*These are fittings for fastening the unit to a wall to prevent tipping due to external shock when using the tablestand (optional). Fasten the safety fittings to the holes in the back of the plasma using the safety fitting mount screws.

**Options:**

- Wall mount unit
- Tilt mount unit
- Tablestand

## IMPORTANT INFORMATION

### » Precautions

Please read this manual carefully before using your plasma monitor and keep the manual handy for future reference.

### CAUTION



RISK OF ELECTRIC SHOCK  
DO NOT OPEN



CAUTION: TO REDUCE THE RISK OF ELECTRIC SHOCK, DO NOT REMOVE COVER. NO USER-SERVICEABLE PARTS INSIDE. REFER SERVICING TO QUALIFIED SERVICE PERSONNEL.

This symbol warns the user that uninsulated voltage within the unit may have sufficient magnitude, it is dangerous to make any kind of contact with any part inside this unit.

This symbol alerts the user that important literature concerning the operation and maintenance of this unit has been included. Therefore, it should be read carefully in order to avoid any problems.

### WARNING

TO PREVENT FIRE OR SHOCK HAZARDS, DO NOT EXPOSE THIS UNIT TO RAIN OR MOISTURE. ALSO DO NOT USE THIS UNIT'S POLARIZED PLUG WITH AN EXTENSION CORD RECEPTACLE OR OTHER OUTLETS, UNLESS THE PRONGS CAN BE FULLY INSERTED. REFRAIN FROM OPENING THE CABINET AS THERE ARE HIGH-VOLTAGE COMPONENTS INSIDE. REFER SERVICING TO QUALIFIED SERVICE PERSONNEL.

### WARNING

This equipment has been tested and found to comply with the limits for a Class B digital device, pursuant to Part 15 of the FCC Rules. These limits are designed to provide reasonable protection against harmful interference when the equipment is operated in a commercial environment. This equipment generates, uses, and can radiate radio frequency energy and, if not installed and used in accordance with the instruction manual, may cause harmful interference to radio communications. Operation of this equipment in a residential area is likely to cause harmful interference in which case the user will be required to correct the interference at his own expense.

» **Warnings and Safety Precautions**

No maintenance other than cleaning is required. Please see the section “Plasma monitor cleaning procedure” on page 7. The plasma display panel consists of fine picture elements (cells). There may be some cells that do not produce light or remain lit. For operating safety and to avoid damage to the unit, read carefully and observe the following instructions. To avoid shock and fire hazards:

1. Provide adequate space for ventilation to avoid internal heat build-up. Do not cover rear vents or install the unit in a closed cabinet or shelves. If you install the unit in an enclosure, make sure there is adequate space at the top of the unit to allow hot air to rise and escape. If the monitor becomes too hot, the overheat protector will be activated and the monitor will be turned off. If this happens, turn off the power to the monitor and unplug the power cord. If the room where the monitor is installed is particularly hot, move the monitor to a cooler location, and wait for 60 minutes to cool the monitor. If the problem persists, contact your dealer for service.
2. Do not use this unit’s polarized plug with extension cords or outlets unless the prongs can be completely inserted.
3. Do not expose the unit to water or moisture.
4. Avoid damage to the power cord, and do not attempt to modify the power cord.
5. Unplug the power cord during electrical storms or if the unit will not be used over a long period.
6. Do not open the cabinet which has potentially dangerous high voltage components inside. If the unit is damaged in this way the warranty will be void. Moreover, there is a serious risk of electric shock.
7. Do not attempt to service or repair the unit. The manufacturer is not liable for any bodily harm or damage caused if unqualified persons attempt service or open the back cover. Refer all service to authorized Service Centers.

## Important Information

### NOTE:

When you connect a computer to this monitor, use an RGB cable including the ferrite core on both ends of the cable. And regarding DVI and power cable, attach the supplied ferrite cores. If you do not do this, the monitor will not conform to mandatory FCC standards. Attaching the ferrite cores: Set the ferrite cores on both ends of the DVI cable (not supplied), and both ends of the power cable (supplied). Close the lid tightly until the clamps click. Use the band to fasten the ferrite core (supplied) to the DVI cable.

#### DVI cable (not supplied)



#### Power cable (supplied)

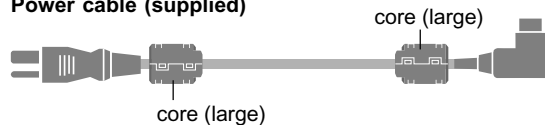

### » To avoid damage and prolong operating life:

1. Use only with 120V 50/60Hz AC power supply. Continued operation at line voltages greater than 120 Volts AC will shorten the life of the unit, and might even cause a fire hazard.
2. Handle the unit carefully when installing it and do not drop.
3. Set the unit away from heat, excessive dust, and direct sunlight.
4. Protect the inside of the unit from liquids and small metal objects. In case of accident, unplug the power cord and have it serviced by an authorized Service Center.
5. Do not hit or scratch the panel surface as this causes flaws on the surface of the screen.
6. For correct installation and mounting it is strongly recommended to use a trained, authorized dealer.
7. As is the case with any phosphor-based display (like a CRT monitor, for example) light output will gradually decrease over the life of a Plasma Display Panel.
8. To avoid sulfurization it is strongly recommended not to place the unit in a dressing room in a public bath or hot spring bath.

» **Plasma monitor cleaning procedure:**

1. Use a soft dry cloth to clean the front panel and bezel area. Never use solvents such as alcohol or thinner to clean these surfaces.
2. Clean plasma ventilation areas with a vacuum cleaner with a soft brush nozzle attachment.
3. To ensure proper ventilation, cleaning of the ventilation areas must be carried out monthly. More frequent cleaning may be necessary depending on the environment in which the plasma monitor is installed.

Recommendations to avoid or minimize phosphor burn-in:

Like all phosphor-based display devices and all other gas plasma displays, plasma monitors can be susceptible to phosphor burn under certain circumstances. Certain operating conditions, such as the continuous display of a static image over a prolonged period of time, can result in phosphor burn if proper precautions are not taken. To protect your investment in this plasma monitor, please adhere to the following guidelines and recommendations for minimizing the occurrence of image burn:

- \* Always enable and use your computer's screen saver function during use with a computer input source.
- \* Display a moving image whenever possible.

- \* Change the position of the menu display from time to time.
- \* Always power down the monitor when you are finished using it.  
If the plasma monitor is in long term use or continuous operation take the following measures to reduce the likelihood of phosphor burn:
  - \* Lower the Brightness and Contrast levels as much as possible without impairing image readability.
  - \* Display an image with many colors and color gradations (i.e. photographic or photo-realistic images).
  - \* Create image content with minimal contrast between light and dark areas, for example white characters on black backgrounds. Use complementary or pastel color whenever possible.
  - \* Avoid displaying images with few colors and distinct, sharply defined borders between colors.

**NOTE: BURN-INS ARE NOT COVERED BY THE WARRANTY**

Contact your dealer for other recommended procedures that will best suit your particular application needs.



## LIMITED WARRANTY

Congratulations on your purchase of a Vidikron video product and welcome to the Vidikron family! With proper installation, setup and care, you should enjoy many years of unparalleled video performance. This is a LIMITED WARRANTY as defined in the Magnuson-Moss Warranty Act. Please read it carefully and retain it with your other important documents.

### **WHAT IS COVERED UNDER THE TERMS OF THIS LIMITED WARRANTY:**

**SERVICE LABOR:** Vidikron will pay for service labor by a Vidikron Authorized Service Center when needed as a result of manufacturing defect for a period of one (1) year from the effective date of delivery to the end user.

**PARTS:** Vidikron will provide new or rebuilt replacement parts for the parts that fail due to defects in materials or workmanship for a period of one (1) year from the effective date of delivery to the end user. Such replacement parts are then subsequently warranted for the remaining portion (if any) of the original warranty period.

### **WHAT IS NOT COVERED UNDER THE TERMS OF THIS LIMITED WARRANTY:**

Image burn-in on plasma display panels are specifically excluded from coverage under this Limited Warranty. Image burn-in is the result of misuse of the product and therefore cannot be repaired under the terms of this Limited Warranty.

#### **TO AVOID IMAGE BURN-IN:**

Please ensure that still images are left on your plasma display panel for no more than a few minutes. Also ensure that images displayed

in the 4:3 aspect ratio mode (black or gray stripes, but no picture information is present on the left and right edges of the screen) are used as infrequently as possible. This will prevent permanent image burns on your plasma display panel, which can be seen permanently under certain conditions once burn-in has occurred.

The types of images to avoid include video games, still images and computer screens with stationary tool bars and icons. (This is why computers are equipped with screen savers – to prevent still images from burning into the monitor’s phosphors after being displayed continuously for an extended period of time).

Normal viewing material such as television/satellite broadcasts, videotape or DVDs (not put into pause for extended periods of time) will not cause damage to your display under normal conditions. Many DVD players are also equipped with screen savers for this reason.

This Limited Warranty only covers failure due to defects in materials and workmanship that occur during normal use and does not cover normal maintenance. This Limited Warranty does not cover cabinets or any appearance items; failure resulting from accident, misuse, abuse, neglect, mishandling, misapplication, faulty or improper installation or setup adjustments; improper maintenance, alteration, improper use of any input signal; damage due to lightning or power line surges, spikes and brownouts; damage that occurs during shipping or transit; or damage that is attributed to acts of God. In the case of remote control units, damage resulting from leaking, old,

damaged or improper batteries is also excluded from coverage under this Limited Warranty.

**CAUTION:** THIS LIMITED WARRANTY ONLY COVERS VIDIKRON PRODUCTS PURCHASED FROM VIDIKRON AUTHORIZED DEALERS. ALL OTHER PRODUCTS ARE SPECIFICALLY EXCLUDED FROM COVERAGE UNDER THIS LIMITED WARRANTY. MOREOVER, DAMAGE RESULTING DIRECTLY OR INDIRECTLY FROM IMPROPER INSTALLATION OR SETUP IS SPECIFICALLY EXCLUDED FROM COVERAGE UNDER THIS LIMITED WARRANTY.

**RIGHTS, LIMITS AND EXCLUSIONS:**

Vidikron limits its obligations under any implied warranties under state laws to a period not to exceed the warranty period. There are no express warranties. Vidikron also excludes any obligation on its part for incidental or consequential damages related to the failure of this product to function properly. Some states do not allow limitations on how long an implied warranty lasts, and some states do not allow the exclusion or limitation of incidental or consequential damages. So the above limitations or exclusions may not apply to you. This warranty gives you specific legal rights, and you may also have other rights that vary from state to state.

**EFFECTIVE WARRANTY DATE:**

This warranty begins on the effective date of delivery to the end user. For your convenience, keep the original bill of sale as evidence of the purchase date.

**IMPORTANT: WARRANTY REGISTRATION:**

Please fill out and mail your warranty registration card. It is imperative that Vidikron knows how to reach you promptly if we should discover a safety problem or product update for which you must be notified.

**CONTACT A VIDIKRON AUTHORIZED SERVICE CENTER TO OBTAIN SERVICE:**

Repairs made under the terms of this Limited Warranty covering your Vidikron video product will be performed at the location of the product, during usual working hours, providing location of product is within normal operating distance from a Vidikron Authorized Service Center. In some instances it may be necessary for the product to be returned to the Vidikron factory for repairs. If, solely in Vidikron's judgment, location of product to be repaired is beyond normal operating distance of the closest Vidikron Authorized Service Center, or the repair requires the unit be returned to the Vidikron factory, it is the owner's responsibility to arrange for shipment of the product for repair. These arrangements must be made through the selling Vidikron dealer. If this is not possible, contact Vidikron directly to locate an authorized Vidikron representative who will assist you in getting a return authorization. Vidikron will return product transportation prepaid in the United States, unless no product defect is discovered. In that instance, shipping costs will be the responsibility of the owner.

*Limited Warranty*

**ADDITIONAL INFORMATION:**

To locate the name and address of the nearest VIDIKRON authorized service location, or for additional information about this Limited Warranty, please call or write:

**VIDIKRON**

Attn: Customer Service Department  
2900 Faber Street  
Union City, CA 94587  
Ph (510) 324-5900  
Fax (510) 324-5905  
Toll Free 1-888-4-VIDIKRON

# HOW TO ATTACH OPTIONS TO THE PLASMA MONITOR

You can attach your optional mounts or stand to the plasma monitor in one of the following two ways:

1) While it is upright. (See drawing A)

2) As it is laid down with the screen face down (See drawing B). Lay the protective sheet, which was wrapped around the plasma monitor when it was packaged, beneath the screen surface so it does not scratch the screen face.

\* DO NOT touch or hold the screen face when carrying the unit.

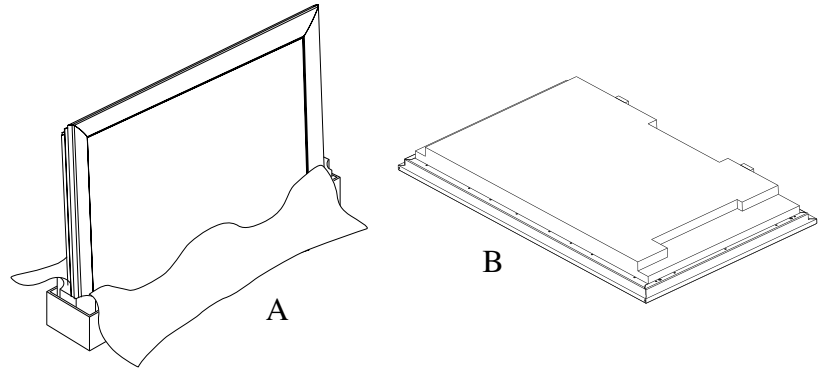

• This device cannot be installed on its own. Be sure to use a stand or original mounting unit. (wallmount unit, stand, etc.)

• For correct installation and mounting, it is required to use a trained, Vidikron Authorized Dealer. Failure to follow correct mounting procedures could result in damage to the equipment or injury to the installer. Product warranty does not cover damage caused by improper installation.

Use only the mounting kit or stand provided by Vidikron. Refer to mounting kit for detailed instructions.

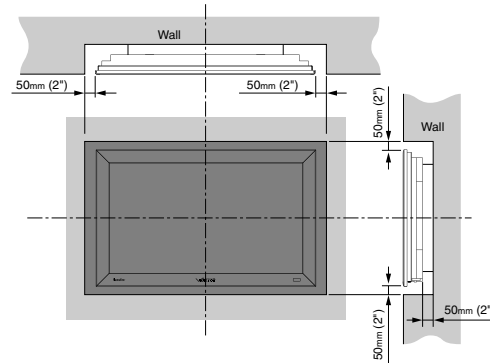

## **Ventilation Requirements for enclosure mounting**

To allow heat to disperse, leave space between surrounding objects as shown on the diagram to the right when installing.

# PART NAMES AND FUNCTIONS

## » Front View

### 1 POWER

Turns the plasma monitor's power on and off.

### 2 REMOTE SENSOR WINDOW

Receives the signals from the remote control.

### 3 POWER

When the power is on it will light GREEN. When the power is on the standby mode, it will light RED.

### 4 INPUT SELECT / EXIT

Switches the input, in the following order. The available inputs depend on the setting of "BNC INPUT".

RGB: → VIDEO1 → VIDEO2 → VIDEO3 → HD/COMP/DTV  
← RGB/PC3 ← RGB/PC2 ← RGB/PC1 ←

COMP: → VIDEO1 → VIDEO2 → VIDEO3 → HD1/COMP1/DTV1  
← RGB/PC2 ← RGB/PC1 ← HD2/COMP2/DTV2 ←

### 5 LEFT/- and RIGHT/+

Enlarges or reduces the image. Functions as the CURSOR (▲/▼) buttons in the On-Screen Display (OSD) mode.

### 6 VOLUME DOWN and UP

Adjusts the volume. Functions as the CURSOR (▲/▼) buttons in the On-Screen Menu mode.

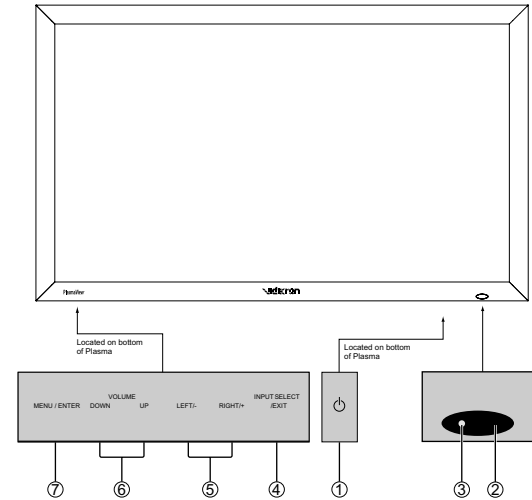

### 7 MENU

Sets the On-Screen Menu mode and displays the main menu.

» **Rear View / Terminal Board**

**A AC IN**

Connect the included power cord here.

**B** Connect speakers (not available from Vidikron) here.  
Maintain the correct polarity.

**C VIDEO 1,2,3 (BNC, RCA, S-Video)**

Connect VCR's, DVD's or Video Cameras, etc here.  
VIDEO1 can be used for INPUT or OUTPUT.

**D AUDIO1, AUDIO2, AUDIO3**

These are audio input terminals. The input is selectable.  
Set which video image to distribute them from the audio  
menu screen.

**E DVD1 / HD1**

Connect DVD's, High Definition or Laser Disks, etc here.

**F RGB2 / DVD2 / HD2**

RGB2: Connect an analog RGB signal and the  
synchronization signal.

DVD2 / HD2: Connect DVD's, High Definition sources,  
Laser Discs, etc. here. This input can be set for use with an  
RGB or Component source.

**G RGB1 (mini D-Sub 15pin)**

Connect an analog RGB signal from a computer, etc. here.  
This input can be used for Input or Output.

**H RGB3 (DVI 24pin)**

Connect a digital signal (TMDS) from a source with a DVI  
output.

**I EXTERNAL CONTROL**

This terminal is used when operating and controlling the  
monitor externally by RS-232.

Rear View / Terminal Board

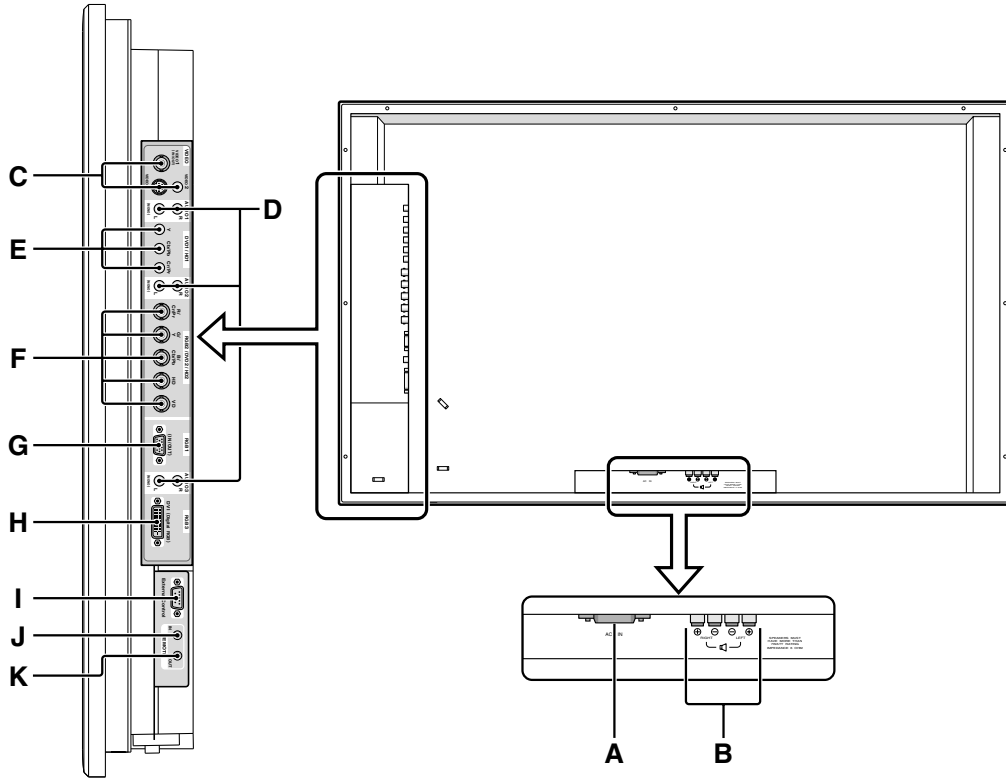

## » Remote Control

### 1 ON/OFF

Switches Power ON/OFF. (This does not operate when POWER/STANDBY indicator of the main unit is off.

### 2 CURSOR (▲/▼/◀/▶)

Use these buttons to select items or settings and to adjust settings or switch the display patterns.

### 3 EXIT

Press this button to exit the OSD controls in the main menu. Press this button during the display of the sub menu to return to the previous menu.

### 4 MENU

Press this button to access the OSD controls. Press this button during the display of the main menu to go to the sub menu.

### 5 VID 1-2-3

Press this button to select VIDEO as the source.  
VID1 → VID2 → VID3  
VIDEO can also be selected using the INPUT SELECT button on the monitor.

### 6 COMP 1-2

Press this button to select between Component 1 and Component 2 inputs.

### 7 RGB 1-2-3

Press this button to select RGB/PC as the source. The available sources depend on the setting of “BNC INPUT”.

RGB:

COMP:

RGB can also be selected using the INPUT SELECT button on the monitor.

### 8 ASPECT

Press this button to select between aspect ratios.

### 9 MUTE

Mutes the sound.

### 10 VOLUME (+/-)

Adjusts the audio volume.

### 11 AUTO OFF

Use to select AUTO OFF TIMER settings.



## Remote Control *(continued)*

### 12 DISPLAY

Displays the source settings on the screen.

### 13 LIGHT\*

Press this to illuminate the buttons.

\* Not available on all models.

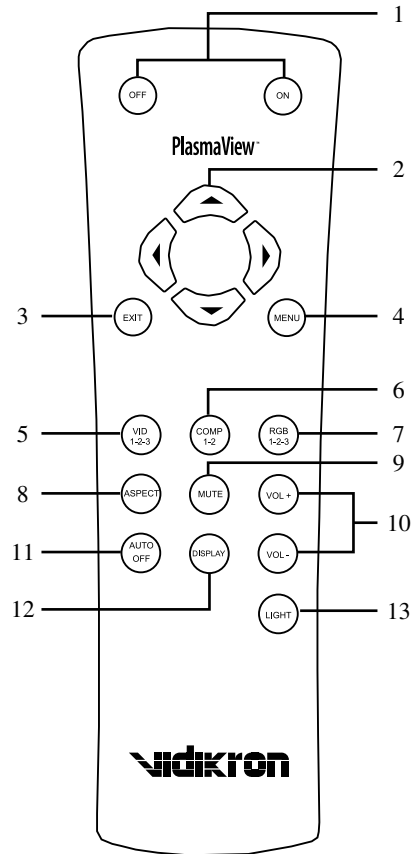

## » Battery Installation and Replacement

Insert the 2 “AAA” batteries, making sure to set them in with the proper polarity.

1. Press and open the cover.

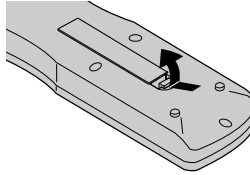

2. Align the batteries according to the (+) and (-) indication inside the case.

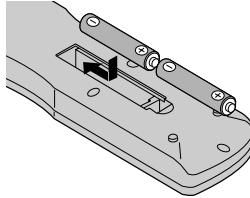

3. Replace the cover.

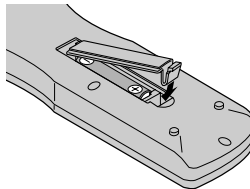

## Part Names and Functions

### » Handling the remote control

- Do not drop or mishandle the remote control.
- Do not get the remote control wet. If the remote control gets wet, wipe it dry immediately.
- Avoid heat and humidity.
- When not using the remote control for a long period, remove the batteries.
- Do not use new and old batteries together, or use different types together.
- Do not take apart the batteries, heat them, or throw them into a fire.

### » Operating Range

- \* Use the remote control within a distance of about 23 ft. (7m) from the front of the monitor's remote control sensor and at horizontal and vertical angles of up to approximately  $30^\circ$ .
- \* The remote control operation may not function if the monitor's remote control sensor is exposed to direct sunlight or strong artificial light, or if there is an obstacle between the sensor and the remote control.

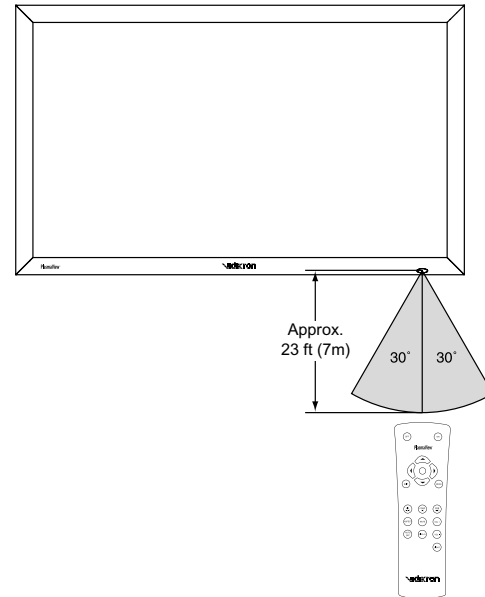

# INSTALLATION

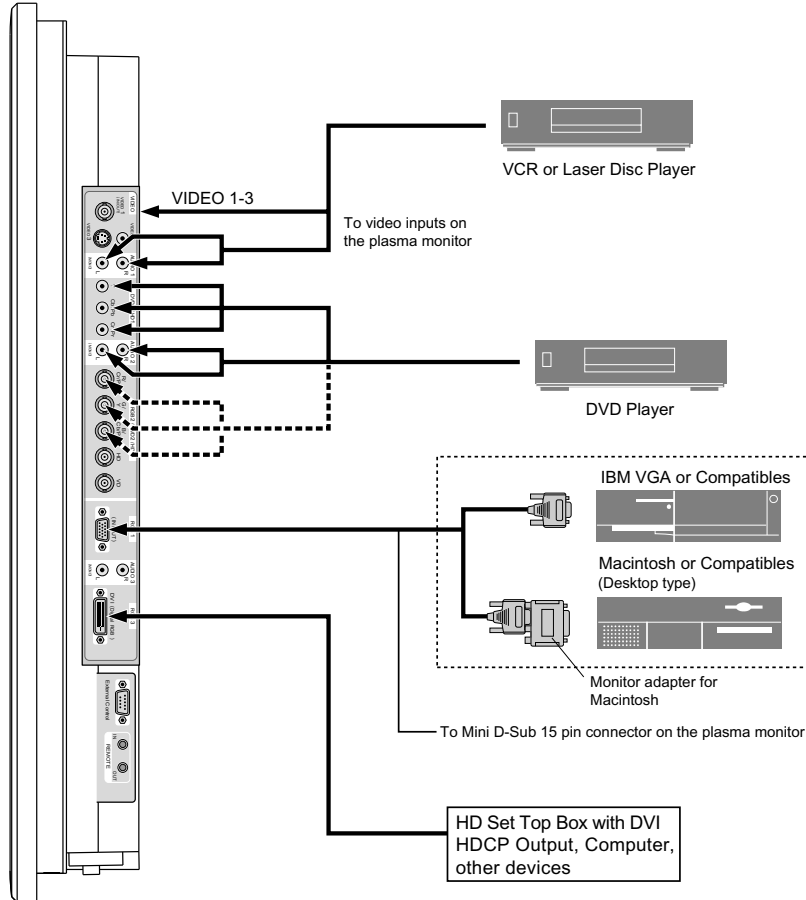

## *Installation*

### » **Connecting Your PC or Macintosh Computer**

Connecting your PC or Macintosh computer to your plasma monitor will enable you to display your computer's screen image for an impressive presentation. The plasma monitor supports the signals described on page 106.

To connect a PC, Macintosh or compatible graphics adapter, simply:

1. Turn off the power to your plasma monitor and computer.
2. If your PC does not support SXGA/XGA/SVGA/VGA you will need to install an SXGA/XGA/SVGA/VGA graphics board. Consult your computer's owner's manual for your SXGA/XGA/SVGA/VGA configuration. If you need to install a new board, see the manual that comes with your new graphics board for installation instructions.
3. This plasma monitor provides signal compatibility up to VESA 1600 x 1200 (UXGA). However, it is not recommended to use this resolution due to image readability on the monitor's native pixel resolution panel.
4. Use the signal cable to connect your PC or Macintosh computer to the plasma monitor. For Macintosh, use the monitor adapter to connect to your computer's video port, if necessary.

5. Turn on the plasma monitor and the computer.

6. If the plasma monitor goes blank after a period of inactivity, it may be caused by a screen saver installed on the computer you've connected to the plasma monitor.

When using a Macintosh with the plasma monitor, the following four display standards are supported using the Macintosh adapter:

- 13" fixed mode
- 16" fixed mode
- 19" fixed mode
- 21" fixed mode

The 13" fixed mode is recommended for your 42" Wide VGA.

» **Connecting Your VCR or Laser Disc Player:**

Use common RCA cables (not provided) to connect your VCR or laser disc player to your plasma monitor. To make these connections, simply:

1. Turn off the power to your plasma monitor and VCR or laser disc player.
2. Connect one end of your RCA cable to the video output connector on the back of your VCR or laser disc player, connect the other end to the Video input on your plasma monitor. Use standard RCA audio patch cords to connect the audio from your VCR or laser disc player to your plasma monitor (if your VCR or laser disc player has this capability). Be careful to keep your right and left channel connections correct for stereo sound.
3. Turn on the plasma monitor and the VCR or laser disc player.

*Note: Refer to your VCR or laser disc player owner's manual for more information about your equipment's video output requirements.*

» **Connecting Your DVD Player:**

You can connect your plasma monitor to a DVD player. To do so, simply:

1. Turn off the power to your plasma monitor and DVD player.
2. Use a component video cable to connect your DVD player to the Y, Cb, and Cr inputs on your plasma monitor. Or use the DVD-player's S-Video output. Use a standard S-Video cable to connect to the S-Video input on the plasma monitor.
3. Turn on the plasma monitor and the DVD player.

## Installation

### » Pin Assignment and Signal Levels for 15 pin RGB (analog)

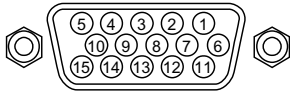

Pin No.	Signal (Analog)
1	Red
2	Green or sync-on-green
3	Blue
4	No connection
5	Ground
6	Red ground
7	Green ground
8	Blue ground
9	No connection
10	Sync signal ground
11	No connection
12	Bi-directional DATA (SDA)
13	Horizontal sync or Composite sync
14	Vertical sync
15	Data clock

### » Pin Configuration and Signal of the RGB 3 Connector (DVI Connector)

The unit is equipped with a type of connector commonly used for digital. (This cannot be used for an analog input.)

## RGB 3

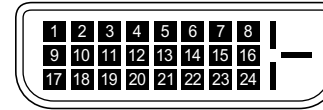

Pin No.	Signal (Digital)	Pin No.	Signal (Digital)
1	T.M.D.S Data 2 -	13	No connection
2	T.M.D.S Data 2 +	14	+5V Power
3	T.M.D.S Data 2 Shield	15	Ground
4	No connection	16	Hot Plug Detect
5	No connection	17	T.M.D.S Data 0 -
6	DDC Clock	18	T.M.D.S Data 0 +
7	DDC Data	19	T.M.D.S Data Shield
8	No connection	20	No connection
9	T.M.D.S Data 1 -	21	No connection
10	T.M.D.S Data 1 +	22	T.M.D.S Clock Shield
11	T.M.D.S Data 1 Shield	23	T.M.D.S Clock +
12	No connection	24	T.M.D.S Clock -

# BASIC OPERATIONS

## » POWER

### To turn the unit ON and OFF:

1. Plug the power cord into an active AC power outlet.
2. Press the POWER ON button (on the remote control or control panel) to turn on the unit.  
The monitor's POWER/STANDBY indicator will light up (green) when the unit is on.
3. Press the POWER OFF button (on the remote control or control panel) to turn off the unit.  
The monitor's POWER/STANDBY indicator turns red and the standby mode is set (only when turning off the unit with the remote control).

## » VOLUME

### To adjust the sound volume:

1. Press and hold the VOLUME (+) button (on the remote control or the unit) to increase to the desired level.
2. Press and hold the VOLUME (-) button (on the remote control or the unit) to decrease to the desired level.

## » MUTE

### To cancel the sound:

Press the MUTE button on the remote control to cancel the sound; press again to restore.

## » DISPLAY

### To check the settings:

1. The screen changes each time the DISPLAY button is pressed.
2. If the button is not pressed for approximately three seconds, the menu turns off.



## Basic Operations

### » **TIMER OFF**

#### **To set the timer off:**

The timer off can be set to turn the power off after 30, 60, 90 or 120 minutes

1. Press the AUTO OFF button to start the timer at 30 minutes.
2. Press the AUTO OFF button to the desired time.
3. The timer starts when the menu turns off.

↳ 30 → 60 → 90 → 120 → 0 ↵

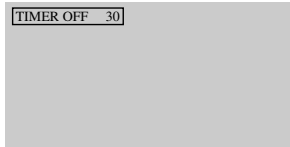

#### **To check the remaining time:**

1. Once the off timer has been set, press the AUTO OFF button once.
2. The remaining time is displayed, then turns off after a few seconds.
3. When five minutes remain the remaining time appears until it reaches zero.

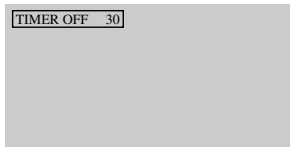

#### **To cancel the off timer:**

1. Press the AUTO OFF button twice in a row.
2. The off timer is canceled.

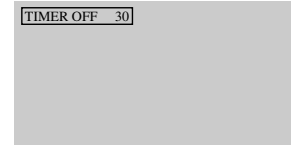

#### **NOTE:**

After the power is turned off with the timer off...

A slight current is still supplied to the monitor. When you are leaving the room or do not plan to use the system for a long period of time, turn off the power of the monitor.

# ASPECT RATIO CONTROLS

## » Aspect Ratio Operations (Manual)

There are four aspect ratios available that can be selected for video signal inputs.

### When viewing videos or DVDs:

1. Press the ASPECT button on the remote control.
2. Within 3 seconds...

Press the ASPECT button again.

The screen size switches as follows:

→ LTR BOX → STD (4:3) → ANAMPHC → INTELLIWIDE →

### LTR BOX mode

The image in the Letterbox mode will be zoomed in, and the top and bottom portion 'blacked off.' This ratio is best suited for LaserDisc movies or non-anamorphic DVD's.

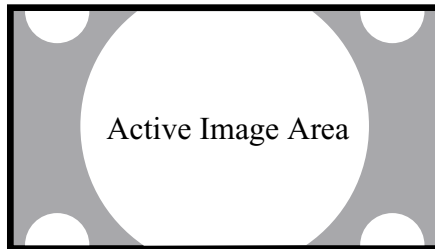

### STD 4:3 mode

The input signal will be scaled to fit in the center of the 16:9 screen.

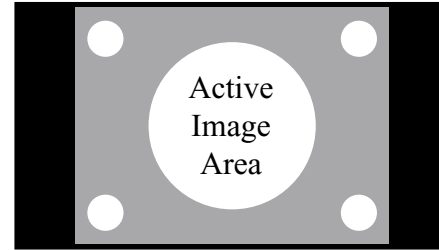

### ANAMPHC mode

The image is compressed vertically, but anamorphic software will appear properly proportioned.

This is best suited for use with 16:9 DVD's.



## *Aspect Ratio Controls*

### **INTELLIWIDE mode**

This aspect ratio is designed to fill the 16:9 screen with a 4:3 image. The center of the picture is not stretched, and it gradually stretches on the sides reaching the most extreme stretch at the far edges of the picture. (non-linear scaling)

In addition, we apply a very slight vertical stretch uniformly (no graduation) which results in a very small amount of cropping of the top and bottom of the image area.

Thus a 4:3 image is transformed into a 16:9 image with minimal distortion.



## » Aspect Ratio Operation with Computer Signals

Switch to the wide screen mode to expand the 4:3 image to fill the entire screen.

1. Press the ASPECT button on the remote control.
2. *Within 3 seconds...*

Press the ASPECT button again.

The screen size switches as follows:

□ → STD (4:3) → ANAMPHC → LTR BOX □

STD 4:3 mode (4:3 or SXGA 5:4)

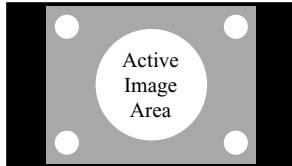

The picture has the same size as the normal computer image.

ANAMPHC mode



The image is expanded in the horizontal direction.

LTR BOX mode



When wide signals are input.

### Information

- Supported resolution

See page 106 for details on the display output of the various VESA signal standards supported by the monitor.

- **When 853 (848) dot x 480 line wide VGA \*signals with a vertical frequency of 60 Hz and horizontal frequency of 31.7 (31.0) kHz are input.**

Select an appropriate setting for RGB SELECT mode referring to the "Table of Signals Supported" on page 106.

\* "IBM PC/AT" and "VGA" are registered trademarks of IBM, Inc. of the United States.

### NOTE:

Do not leave the displayed in 4:3 mode for an extended period. This can cause a phosphor burn-in.

# OSD (On Screen Display) Controls

## » Menu Operations

The OSD window is displayed with respect to the screen as shown on the diagram.

\* Depending on the screen's mode, the OSD may be displayed differently. In the explanation, the OSD section is shown close up.

The following describes how to use the menus and the selected items.

1. Press the MENU button on the remote control to display the MAIN MENU.

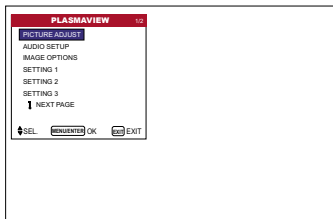

2. Press the MENU button on the remote control to select a submenu or item.

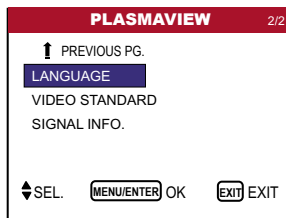
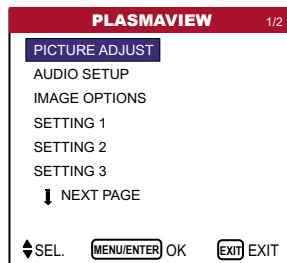

3. Press the cursor buttons ▲ ▼ on the remote control to highlight the menu you wish to enter.

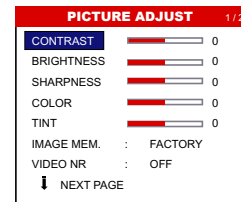

4. Adjust the level or change the setting of the selected item by using the cursor buttons ◀ ▶ on the remote control.

5. Change the adjustments or the settings that are stored in memory. The change is stored until you change it again.

6. Repeat steps 2-5 to adjust an additional item, or press the EXIT button on the remote control to return to the main menu.

### NOTE:

The main menu disappears by pressing the EXIT button.

Main Menu	Sub Menu	Functions	Default	Reset	
PICTURE ADJUST	CONTRAST	Adjusts the contrast.	Center	Yes	
	BRIGHTNESS	Adjusts the brightness.	Center	Yes	
	SHARPNESS	Adjusts the sharpness	Center	Yes	
	COLOR	Adjusts the color.	Center	Yes	
	TINT	Adjusts the tint.	Center	Yes	
	IMAGE MEM.	Sets the image memory according to the VIDEO environment and image S/W.	CONTRAST	Yes	
	VIDEO NR	Reduces noise visible in image.	OFF	Yes	
	WHITE BAL.	Adjusts the color temperature and white balance.	8500K	Yes	
	WHITE BALANCE ADJUST	GAIN RED	Adjusts the red content (signal level).	Center	Yes
		GAIN GREEN	Adjusts the green content (signal level).	Center	Yes
		GAIN BLUE	Adjusts the blue content (signal level).	Center	Yes
		RED OFFSET	Adjusts the red content (black level).	Center	Yes
		GREEN OFFSET	Adjusts the green content (black level).	Center	Yes
		BLUE OFFSET	Adjusts the blue content (black level).	Center	Yes
		RESET	Resets the WHITE BALANCE ADJUST settings to the factory default values.	OFF	Yes
	GAMMA CURVE		Adjusts the brightness of midtone areas.	2.2	Yes
	DITHER		Enables high-quality dark area reproduction.	AUTO	Yes
	COLOR CHART	RED	Adjusts hue and color density of red.	Center	Yes
		GREEN	Adjusts hue and color density of green.	Center	Yes
		BLUE	Adjusts hue and color density of blue.	Center	Yes
YELLOW		Adjusts hue and color density of yellow.	Center	Yes	
MAGENTA		Adjusts hue and color density of magenta.	Center	Yes	
CYAN		Adjusts hue and color density of cyan.	Center	Yes	
RESET		Resets COLOR CHART settings to the factory default values.	OFF	Yes	

## OSD (On Screen Display) Controls

Main Menu	Sub Menu	Functions	Default	Reset
<b>AUDIO SETUP</b>	BASS	Sets the bass.	Center	Yes
	TREBLE	Sets the treble.	Center	Yes
	BALANCE	Sets the left/right balance.	Center	Yes
	AUDIO INPUT 1-3	Sets the allocation of the audio connectors.	*1	Yes

Main Menu	Sub Menu	Functions	Default	Reset
<b>IMAGE OPTIONS</b>	ASPECT RATIO	Selects between the different aspect ratio modes.	--	--
	V SHIFT	Adjusts the vertical position.	Center	Yes
	H SHIFT	Adjusts the horizontal position.	Center	Yes
	V-SIZE	Adjusts the vertical size.	Min	Yes
	H-SIZE	Adjusts the horizontal size.	Min	Yes
	COMPUTER	Turn this on to have the monitor automatically adjust "FINE PICTURE" and "PICTURE ADJ"	OFF *	No
	FINE PICTURE	Adjusts for flickering on the computer image.	Min *2	Yes
PICTURE ADJUST	Adjusts for striped patterns on the computer image.	Center *2	Yes	

Main Menu	Sub Menu	Functions	Defaults	Reset	
<b>SETTING 1</b>	OSD	DISPLAY OSD	When set to OFF, the on-screen menu is not displayed.	ON	Yes
		OSD ADJ.	Sets the position of the menu.	1	Yes
		OSD POSITION	Sets the display format as a horizontal or vertical screen.	H	Yes
		OSD ORBITER	Sets the OSD not to be displayed at the same position.	OFF	Yes
	BNC INPUT	Sets the BNC connectors.	RGB	Yes	
	D-SUB TYPE	Checks the signal being transmitted to RGB1 terminal.	RGB	--	
RGB TYPE	Sets the appropriate mode for the computer image.	AUTO	Yes		

Main Menu	Sub Menu	Functions	Default	Reset
		RGB (VGA signals), VIDEO (Moving picture), WIDE (Wide VGA), DTV.		
	HD TYPE	Sets the digital broadcasting (1080A, 1080B, 1080C) or the High Vision (1035I).	1080B	No
	INPUT SKIP	Skips over signals which are not present.	OFF	Yes
	FACTORY	Resets all the settings (PICTURE ADJUST, AUDIO, IMAGE OPTIONS, SETTING 1-3, etc.) to the factory default values.	--	--

Main Menu	Sub Menu	Functions	Default	Reset	
<b>SETTING 2</b>	AUTO OFF	Sets the monitor for use as an energy-saving display when used with a computer.	OFF	Yes	
	CINEMA MODE	Sets the picture to suit the movie.	ON	Yes	
	PIXL PROTECT	LUM. SETTING	Limits screen brightness to reduce burn-in on the display.	AUTO	Yes
		ORBITER	Moves the picture intermittently.	OFF	Yes
		INVERSE	Displays a negative/positive inverse image or an all-white screen.	OFF	Yes
		IMAGE SWEEP	Sweeps the screen with a white vertical bar.	OFF	Yes
		SOFTEN	Softens the detail in 4 steps (1-4)	OFF	Yes
	SIDEBAR LEV.	In case of 4:3, sets the luminance of both sides.	3	Yes	
S1/S2		Resizes the S-video image to best fit the display.	OFF	Yes	

Main Menu	Sub Menu	Functions	Defaults	Reset	
<b>SETTING 3</b>	TIMER	PRESENT TIME	Sets the day of the week and the time.	--	No
		PROGRAM	Sets the ON/OFF time for switching on the power and the input mode.	OFF	Yes
	INPUT SELECT	Sets the input mode at the time the power is switched on.	LAST	Yes	
	CONTROL LOCK	Disables the function of the front panel buttons.	OFF	Yes	
	IR ENABLE	Disables the transmission of the remote control.	ON	Yes	
	LOOP OUT		When set to ON, the received signal will be looped out.	OFF	Yes



## OSD (On Screen Display) Controls

Main Menu	Sub Menu	Functions	Default	Reset	
		ID NUMBER	Sets ID number for the display.	ALL	Yes
	VIDEO WALL	DIVIDER	Creates a 2x2 or 3x3 video wall.	OFF	Yes
		POSITION	Sets the position.	--	--
		DISP. MODE	Selects the screen mode from between Splitting and Blanking.	SPLIT	Yes
		AUTO ID	Automatically sets the ID number of multiple displays.	OFF	Yes
		IMAGE ADJUST	Adjusts the position of the image, etc.	--	--
		P. ON DELAY	When set to ON, each display turns on after a delay time.	OFF	Yes
		LUM SET LINK	Sets a uniform brightness for each display.	OFF	Yes
		REPTR TIMER	Sets two programmable timers.	OFF	Yes

Main Menu	Sub Menu	Functions	Default	Reset
<b>LANGUAGE</b>		Sets the language of the menus (English, German, French, Italian, Spanish).	English	No
<b>VIDEO STANDARD</b>		Sets the VIDEO format (AUTO, PAL, PAL-M, PAL-N, PAL60, SECAM, 4.43 NTSC or 3.59 NTSC).	AUTO	No
<b>SIGNAL INFO.</b>		Used to check the frequency and synchronizing polarities of the active signal being input.	--	--

\*1 AUDIO INPUT 1: VIDEO 1 AUDIO INPUT 2: HD/DVD1 AUDIO INPUT 3: RGB1

\*2 RGB/PC only

## » Picture Adjust Menu

### Adjusting the picture

The contrast, brightness, sharpness, color and tint can be adjusted as desired.

Example: Adjusting the contrast

Press the **MENU** button on the remote control to display the **MAIN MENU** on the screen, then...

1. Use the ▲ and ▼ buttons to select “**PICTURE ADJUST**”, then press the **MENU** button. The “**PICTURE ADJUST**” screen appears.
2. Use the ▲ and ▼ buttons to select “**CONTRAST**”.

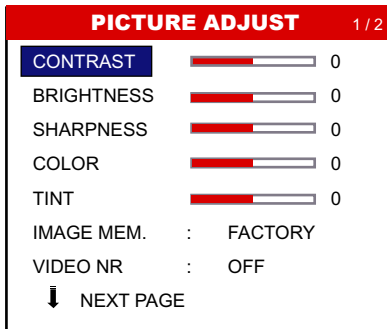

3. Use the ◀ and ▶ buttons to adjust the contrast.



\* If neither ◀ or ▶ buttons is pressed within 5 seconds, the current setting is set and the previous screen reappears.

4. Once the adjustment is completed...

Press the **EXIT** button to return to the main menu.

To delete the main menu, press the **EXIT** button once more.

### NOTE:

If “**CAN NOT ADJUST**” appears...

When trying to enter the **PICTURE** submenu, make sure **IMAGE MEM.** is not set to **FACTORY**.

### Information

#### ■ Picture adjustment screen

**CONTRAST** ..... Changes the picture’s white level.

**BRIGHTNESS** ..... Changes the picture’s black level.

**SHARPNESS** ..... Changes the picture’s sharpness.  
Adjusts picture detail of **VIDEO** display.

**COLOR** ..... Changes the color density.

**TINT** ..... Changes the picture’s tint. Adjust for natural colored skin, background, etc.

#### ■ Adjusting the computer image

Only the contrast and brightness can be adjusted when a computer signal is connected.

#### ■ Restoring the factory default settings

Select “**FACTORY**” under the “**IMAGE MEM.**” settings.

### Setting the picture mode according to the brightness of the room

There are four picture modes that can be used effectively according to the environment in which you are viewing the display.

Example: Setting the “FACTORY” mode

Press the MENU button on the remote control to display the MAIN MENU on the screen, then...

1. Use the ▲ and ▼ buttons to select “PICTURE ADJUST”, then press the MENU button. The “PICTURE ADJUST” screen appears.

2. Use the ▲ and ▼ buttons to select “IMAGE MEM.”

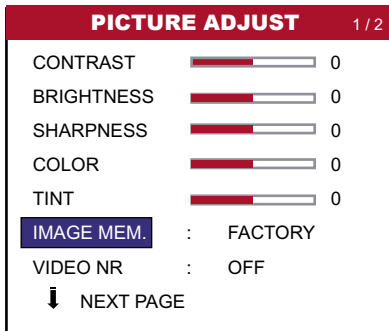

3. To set to “FACTORY” ...

Use the ◀ and ▶ buttons to select “FACTORY”. The mode switches as follows when the ◀ and ▶ buttons are pressed:

→ CONTRAST ↔ LW BLK1 ↔ LW BLK2 ↔ FACTORY ↔ BOOST ←



If neither the ◀ or ▶ button is pressed within 5 seconds, the current selection is set and the previous screen reappears.

4. Once the adjustment is completed...

Press the EXIT button to return to the main menu. To delete the main menu, press the EXIT button once more.

#### Information

##### ■ Types of picture modes

##### LW BLK1, 2

Set this mode when watching video in a dark room. This mode provides darker, finer pictures, like the screen in movie theaters. For a darker image, select LW BLK2.

##### CONTRAST

Set this mode when watching video in a bright room. This mode provides dynamic pictures with distinct differences between light and dark sections.

##### BOOST

Use this setting to boost brightness.

##### FACTORY

Use this to reset the picture to the factory default settings.

## Reducing noise in the picture

Use these settings if the picture has noise due to poor reception or when playing video tapes on which the picture quality is poor.

Example: Setting “VID NR-3”

Press the **MENU** button on the remote control to display the **MAIN MENU** on the screen, then...

1. Use the ▲ and ▼ buttons to select “**PICTURE ADJUST**”, then press the **MENU** button. The “**PICTURE ADJUST**” screen appears.
2. Use the ▲ and ▼ buttons to select “**VIDEO NR**”.

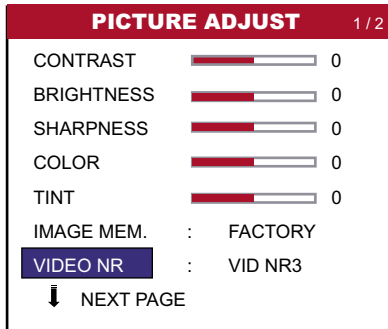

3. Use the ◀ and ▶ buttons to select “**VID NR3**”. The mode switches as follows when the ◀ and ▶ buttons are pressed:

→ OFF ↔ VID NR-1 ↔ VID NR-2 ↔ VID NR-3 ←

VID NR : ◀ VID NR3 ▶

\* If neither the ◀ or ▶ button is pressed within 5 seconds, the current selection is set and the previous screen reappears.

4. *Once the setting is completed...*

Press the **EXIT** button to return to the main menu.

To delete the main menu, press the **EXIT** button once more.

### Information:

#### ■ VIDEO NR

- \* “NR” stands for Noise Reduction.
- \* This function reduces noise in the picture.

#### ■ Types of noise reduction

There are three types of noise reduction. Each has a different level of noise reduction. The effect becomes stronger as the number increases (in the order VID NR1 → VID NR2 → VID NR3).

OFF ..... Turns the noise reduction function off.

## OSD (On Screen Display) Controls

### Setting the White Balance

Use this procedure to set color tone produced by the plasma display.

Example: Setting “6500K”

*Press the MENU button on the remote control to display the MAIN MENU on the screen, then...*

1. Use the ▲ and ▼ buttons to select “PICTURE ADJUST”, then press the MENU button. The “PICTURE ADJUST” screen appears.

2. Use the ▲ and ▼ buttons to select “WHITE BAL”.

3. Use the ◀ and ▶ buttons to select “6500K”.

The mode switches as follows when the ◀ and ▶ buttons are pressed:

→ 5400K ↔ 6500K ↔ 8500K ↔ 9300K ←

\* See below to set “WHITE BALANCE ADJUST”.

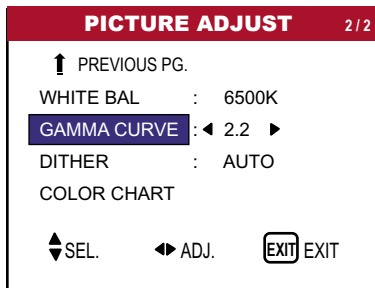

\* If neither the ◀ or ▶ button is pressed within 5 seconds, the current selection is set and the previous screen reappears.

4. *Once the setting is completed...*

Press the EXIT button to return to the main menu. To delete the main menu, press the EXIT button once more.

#### Information

##### ■ Setting the color temperature

5400K	.....	Redder
6500K	.....	Slightly redder
8500K	.....	Standard (slightly bluer)
9300K	.....	Bluer

##### ■ Restoring the factory default settings

Select “FACTORY” under the SETTING 1 menu. Note that this also restores other settings to the factory defaults.

### Adjusting the color to the desired level

Use this procedure to adjust the white balance for each color temperature to achieve the desired color quality.

Example: Adjusting the “GAIN RED” of “9300K” color temperature.

*Perform the following operations.*

*Press the MENU button on the remote control to display the MAIN MENU on the screen, then...*

*Perform Steps 1-3 of WHITE BAL., then...*

4. Press the MENU button. The “WHITE BAL.” screen appears.

5. Use the ▲ and ▼ buttons to select “GAIN RED”.

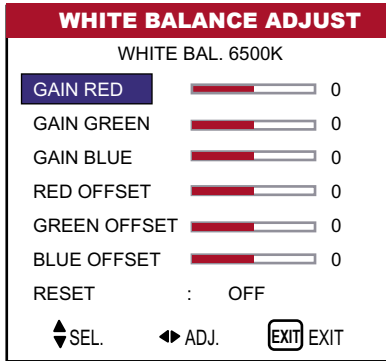

6. Adjust the white balance using the ◀ and ▶ buttons.



\* If neither the ◀ and ▶ buttons is pressed within 5 seconds, the current setting is set and the previous screen reappears.

7. Once the adjustment is completed...

Press the EXIT button to return to the main menu. To delete the main menu, press the EXIT button once more.

**Information**

■ **Adjusting the white balance**

R/G/B GAIN ..... White balance adjustment for signal level

R/G/B OFFSET ..... White balance adjustment for black level

RESET ..... Resets settings to the factory default

values. Use ◀ and ▶ buttons to select “ON”, then press the MENU button.

■ **Restoring the factory default settings**

Select “RESET” under the WHITE BAL. menu.

**Changing the Gamma Curve**

This feature adjusts the brightness of the midtone areas while keeping shadows and highlights unchanged.

Example: Setting “2.8”

Perform the following operations.

Press the MENU button on the remote control to display the MAIN MENU on the screen, then...

1. Use the ▲ and ▼ buttons to select “PICTURE ADJUST”, then press the MENU button. The “PICTURE ADJUST” screen appears.

2. Use the ▲ and ▼ buttons to select “GAMMA CURVE”.

3. Use the ◀ and ▶ buttons to select “2.8”. The mode switches as follows each time the or button is pressed:

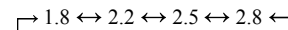

## OSD (On Screen Display) Controls

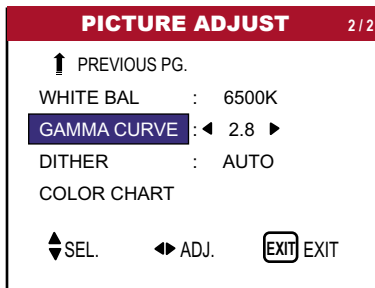

4. Once the setting is completed...

Press the EXIT button to return to the main menu.

To delete the main menu, press the EXIT button once more.

### Information

#### ■ GAMMA CURVE settings

The picture becomes darker as the number increases (in the sequence of 1.8, 2.2, 2.5, 2.8).

#### ■ Restoring the factory default settings

Select "FACTORY" under the SETTING 1 menu. Note that this also restores other settings to the factory defaults.

### Making the Dither adjustments

This feature allows more detailed tone to be reproduced especially in the dark area.

Example: Setting "2.2"

Perform the following operations.

Press the MENU button on the remote control to display the MAIN MENU on the screen, then...

1. Use the ▲ and ▼ buttons to select "PICTURE ADJUST", then press the MENU button. The "PICTURE ADJUST" screen appears.

2. Use the ▲ and ▼ buttons to select "DITHER".

3. Use the ◀ and ▶ buttons to select "AUTO". The mode switches as follows each time the or button is pressed:

→ AUTO ↔ STILL ↔ MOTION ↔ DIFFUSED ←

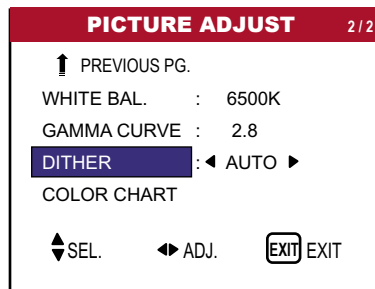

4. Once the setting is completed...

Press the EXIT button to return to the main menu.

To delete the main menu, press the EXIT button once more.

**Information**

■ **DITHER settings**

- AUTO .....Will automatically appraise the picture and make adjustments.
- STILL .....Will apply the dither method suitable for still pictures.
- MOTION.....Will apply the dither method suitable for motion pictures.
- DIFFUSE.....Will apply the error diffusion method.

■ **Restoring the factory default settings**

Select “FACTORY” under the SETTING 1 menu. Note that this also restores other settings to the factory defaults.

**Adjusting the colors**

Use this procedure to adjust hue and color density for red, green, blue, yellow, magenta and cyan. Such adjustments will not affect the other colors. You can accentuate the green color of trees, the blue of the sky, etc.

Example: Adjusting the color tune for blue

*Perform the following operations.*

*Press the MENU button on the remote control to display the MAIN MENU on the screen, then...*

1. Use the ▲ and ▼ buttons to select “PICTURE ADJUST”, then press the MENU button. The “PICTURE ADJUST” screen appears.

2. Use the ▲ and ▼ buttons to select “COLOR CHART”, then press the MENU button. The “COLOR CHART” screen appears.
3. Use the ▲ and ▼ buttons to select “BLUE”.
4. Adjust using the ◀ and ▶ buttons.

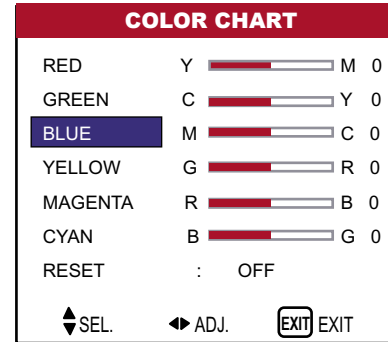

\* If neither the ◀ or ▶ button is pressed within 5 seconds, the current selection is set and the previous screen reappears.

To continue making other adjustments...

Repeat from step 3.

5. *Once the setting is completed...*

Press the EXIT button to return to the main menu.

To delete the main menu, press the EXIT button once more.



**Information**

■ **COLOR CHART settings**

RED ..... Makes red's adjustment  
GREEN ..... Makes green's adjustment  
BLUE ..... Makes blue's adjustment  
YELLOW ..... Makes yellow's adjustment  
MAGENTA ..... Makes magenta's adjustment  
CYAN ..... Makes cyan's adjustment  
RESET ..... Resets settings to the factory default values. Use ◀ and ▶ buttons to select "ON", then press the MENU button.

■ **Restoring the factory default settings**

Select "FACTORY" under the SETTING 1 menu. Note that this also restores other settings to the factory defaults.

» **Audio Setup Menu**

**Adjusting the treble, bass and left/right balance and audio input select**

The treble, bass and left/right balance can be adjusted to suit your tastes.

Example: Adjusting the bass

*Press the MENU button on the remote control to display the MAIN MENU on the screen, then...*

1. Use the ▲ and ▼ buttons to select "AUDIO SETUP", then press the MENU button. The "AUDIO SETUP" screen appears.

2. To adjust the bass... Use the ▲ and ▼ buttons to select "BASS".

3. Adjust the bass using the ◀ and ▶ buttons.

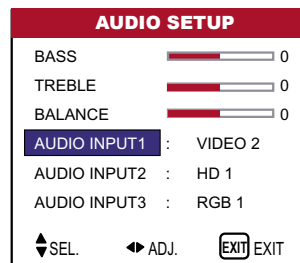

*To continue adjusting the audio ...*

Repeat from step 2.

**Information**

■ **Audio setup menu**

BASS ..... Controls the level of low frequency sound.  
TREBLE ..... Controls the level of high frequency sound.  
BALANCE ..... Controls the balance of the left and right channels.

■ **Restoring the factory default settings**

Select "FACTORY" under the SETTING 1 menu. Note that this also restores other settings to the factory defaults.

**Note:**

If “CAN NOT ADJUST” appears...

Set “AUDIO INPUT” on the AUDIO SETUP menu correctly.

4. Once the adjustment is completed...

Press the EXIT button to return to the main menu.

To delete the main menu, press the EXIT button once again.

**Setting the allocation of the audio connectors**

Setting the AUDIO 1, 2, and 3 connectors to the desired input.

Example: Setting “AUDIO INPUT1” to “VIDEO 2”

Press the MENU button on the remote control to display the MAIN MENU on the screen, then...

1. Use the ▲ and ▼ buttons to select “AUDIO SETUP”, then press the MENU button. The “AUDIO SETUP” screen appears.

2. Use the ▲ and ▼ buttons to select “AUDIO INPUT1”.

3. To set the AUDIO INPUT1 to “VIDEO2”...

Use the ◀ and ▶ buttons to select “VIDEO2”.

The mode switches as follows each time the ◀ and ▶ buttons is pressed:

The available sources depend on the setting of “BNC INPUT”.

RGB: 

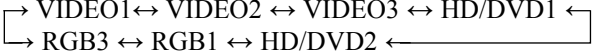
COMP: 

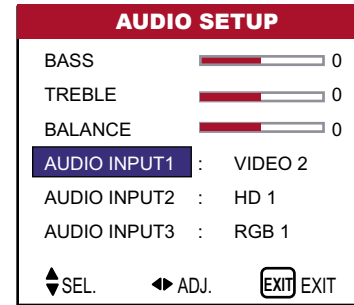

4. Once the adjustment is completed...

Press the EXIT button to return to the main menu.

To delete the main menu, press the EXIT button once more.

**Information****■ AUDIO INPUT**

A single audio input cannot be selected as the audio channel for more than one input terminal.

**■ Restoring the factory default settings**

Select “FACTORY” under the SETTING 1 menu.

Note that this also restores other settings to the factory defaults.

## » Image Options Settings Menu

The position of the image can be adjusted and flickering of the image can be corrected.

Example: Adjusting the vertical position in the normal mode

Press the **MENU** button on the remote control to display the **MAIN MENU** on the screen, then...

1. Use the **▲** and **▼** buttons to select “**IMAGE OPTIONS**”, then press the **MENU** button. The “**IMAGE OPTIONS**” screen appears.

Default settings (when RGB/PC is selected).

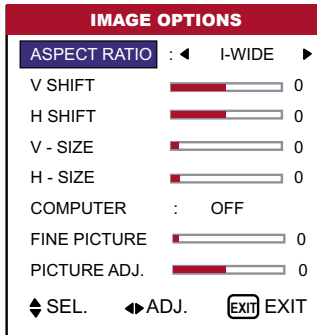

\* The settings on the **IMAGE ADJUST** menu are not preset at the factory.

To select a mode ...

Use the **◀** and **▶** buttons to select a mode. The mode switches as follows when the **◀** and **▶** buttons are pressed:

**STD 4:3 ↔ ANAMPHC ↔ I-WIDE ↔ LTR BOX**

\* The mode can also be switched by pressing the “**ASPECT**” button on the remote control.

2. To adjust the vertical position ...

Use the **▲** and **▼** buttons to select “**V SHIFT**”.

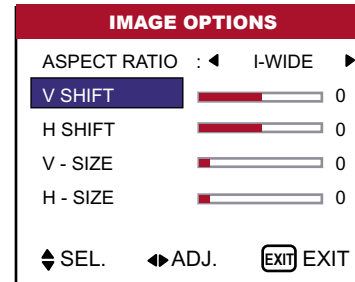

3. Adjust using the **◀** and **▶** buttons.



\* If neither the **◀** or **▶** button is pressed within 5 seconds, the current setting is set and the previous screen reappears.

To continue making other computer image adjustments...

Repeat from step 2.

#### 4. Once all adjustments are completed...

Press the EXIT button to return to the main menu, To delete the main menu, press the EXIT button once more.

#### Information

##### ■ When “COMPUTER” is off

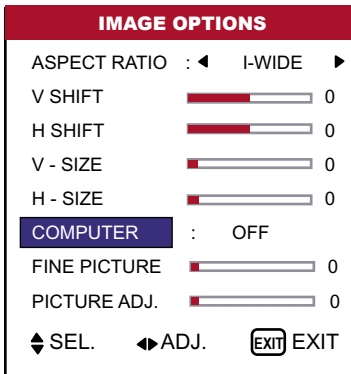

When Auto Picture is off, the Fine Picture and the Picture ADJ. items area displayed so that you can adjust them.

##### ■ Adjusting the COMPUTER

ON ..... The picture ADJ., Fine Picture and Position adjustments are made automatically. Not available for digital ZOOM.

OFF ..... The Picture ADJ., Fine Picture and Position adjustments are made manually.

\* If FINE PICTURE will not adjust, set “Computer” to OFF and adjust manually.

##### ■ Adjusting the position of the image

V SHIFT.....Adjusts the vertical position of the image.

H SHIFT.....Adjusts the horizontal position of the image.

V-SIZE .....Adjusts the vertical size of the image.  
(Except for I-WIDE mode)

H-SIZE.....Adjusts the horizontal size of the image.  
(Except for I-WIDE mode)

FINE PICTURE\* .... Adjusts for flickering.

PICTURE ADJ.\* ..... Adjusts for striped patterns on the image.

\*The Picture ADJ. and Fine Picture features are available only when the “Computer” is off.

\* The COMPUTER, FINE PICTURE and PICTURE ADJ. are available only for RGB signals. But, these features are not available for moving pictures on VIDEO, COMP or RGB.

##### ■ Restoring the factory defaults settings

Select “FACTORY” under the SETTING 1 menu. Note that this also restores other settings to the factory defaults for Auto Picture.

## » SETTING 1 Settings Menu

### Setting the on-screen menu

This sets the position of the menu, the display format (horizontal or vertical) etc.

Example: Turning the DISPLAY OSD off

*Press the MENU button on the remote control to display the MAIN MENU on the screen, then...*

1. Use the ▲ and ▼ buttons to select “SETTING 1”, then press the MENU button. The “SETTING 1” menu appears.

2. Use the ▲ and ▼ buttons to select “OSD”, then press the MENU button. The “OSD” menu appears.

3. Use the ▲ and ▼ buttons to select “DISPLAY OSD”.

4. To set the DISPLAY OSD to “OFF”...

Use the ◀ and ▶ buttons to select “OFF”. The mode switches as follows each time the ◀ or ▶ button is pressed:

ON ↔ OFF

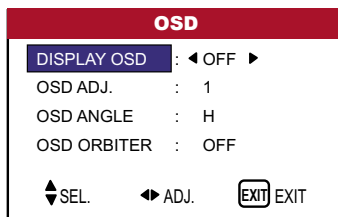

5. Once the setting is completed...

Press the EXIT button to return to the SETTING 1 menu.

To return to the main menu, press the EXIT button once more.

### Information

#### ■ DISPLAY OSD settings

ON..... The on-screen menu appears.

OFF ..... The on-screen menu does not appear.

If you press the DISPLAY button on the remote control for more than 3 seconds the main menu will appear and can be set (although it is not ON).

#### ■ OSD ADJUST settings

Adjusts the position of the menu when it appears on the screen.

The position can be set between 1 to 6.

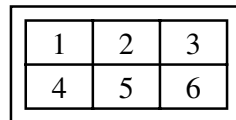

#### ■ OSD ANGLE settings

Sets the display format (landscape “H” or portrait “V”).

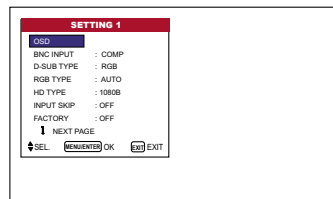

#### ■ OSD ORBITER settings

ON..... The position of the menu will be shifted by eight dots each time OSD is displayed.  
 OFF ..... OSD will be displayed at the same position.

#### ■ Restoring the factory defaults settings

Select “FACTORY” under the SETTING 1 menu. Note that this also restores other settings to the factory defaults for Auto Picture.

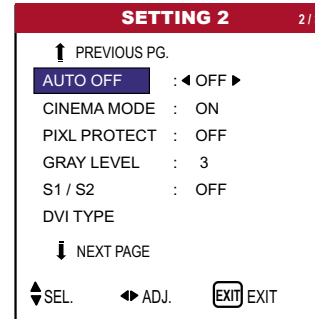

### Setting the BNC connectors

Select whether to set the input of the 5 BNC connectors to RGB and Component.

Example: Set the BNC INPUT mode to “COMP”

*Press the MENU button on the remote control to display the MAIN MENU on the screen, then...*

1. Use the ▲ and ▼ buttons to select “SETTING 1”, then press the MENU button. The “SETTING 1” menu appears.
2. Use the ▲ and ▼ buttons to select “BNC INPUT”.

3. *To set the BNC INPUT mode to “COMP”...*

Use the ◀ and ▶ buttons to select “COMP”. The mode switches as follows each time the ◀ or ▶ button is pressed:

RGB ↔ COMP

4. *Once the setting is completed...*

Press the EXIT button to return to the main menu.

To delete the main menu, press the EXIT button once more.

#### *Information*

#### ■ BNC INPUT settings

RGB ..... Use the 5BNC terminals for RGB input.

COMP ..... Use the 3BNC terminals for Component input.

#### ■ Restoring the factory default settings

Select “FACTORY” under the SETTING 1 menu.

Note that this also restores other settings to the factory defaults.

## OSD (On Screen Display) Controls

### Checking the signal being transmitted to RGB1 terminal

Use this to confirm the signal being transmitted to the RGB1 terminal.

It is set to RGB and can not be adjusted.

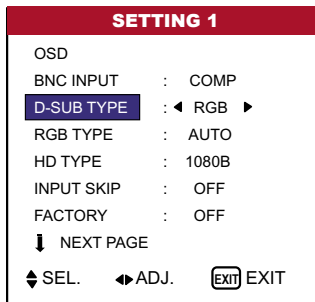

### Setting a computer image to the correct RGB select screen

With the computer image, select the RGB Select mode for a moving image such as (video) mode, wide mode or digital broadcast.

Example: Setting the “RGB TYPE” mode to “AUTO”

Press the MENU button on the remote control to display the MAIN MENU on the screen, then...

1. Use the ▲ and ▼ buttons to select “SETTING 1”, then press the MENU button. The “SETTING 1” menu appears.

2. Use the ▲ and ▼ buttons to select “RGB TYPE”.

3. To set the RGB select mode to “AUTO”...

Use the ◀ and ▶ buttons to select “AUTO”. The mode switches as follows each time the ◀ or ▶ button is pressed:

→ AUTO ↔ STILL ↔ MOTION ↔ RESIZE1 ↔ RESIZE2 ↔ DTV ←

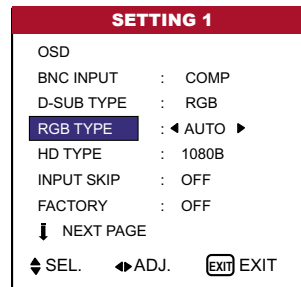

4. Once the setting is completed...

Press the EXIT button to return to the main menu.

To delete the main menu, press the EXIT button once more.

### Information

#### ■ RGB TYPE modes

One of these 6 modes must be selected in order to display the following signals correctly.

**AUTO:** Select the suitable mode for the specifications of input signals as listed in the table “Computer input signals supported by this system” on page 106.

**STILL:** To display VESA standard signals. (Use this mode for a still image from a computer.)

*continued on next page ...*

MOTION:	The video signal (from a scan converter) will be converted to RGB signals to make the picture more easily viewable. (Use this mode for a motion image from a computer.)
RESIZE1:	When an 852 dot 480 line signal with a horizontal frequency of 31.7kHz is input, the image may be compressed horizontally. To prevent this, set RGB TYPE to RESIZE1.
RESIZE2:	When an 848 dot 480 line signal with a horizontal frequency of 31.0 kHz is input, the image may be compressed horizontally. To prevent this, set RGB TYPE to RESIZE2.
DTV:	Set this mode when watching digital broadcasting (480P).

■ **Restoring the factory default settings**

Select “FACTORY” under the SETTING 1 menu.  
Note that this also restores other settings to the factory defaults.

**Setting high definition images to the suitable screen size**

Use this procedure to set whether the number of vertical lines of the input high definition image is 1035 or 1080.

Example Setting the “1080B” mode to “1035I”

*Press the MENU button on the remote control to display the MAIN MENU on the screen, then...*

1. Use the ▲ and ▼ buttons to select “SETTING 1”, then press the MENU button. The “SETTING 1” menu appears.

2. Use the ▲ and ▼ buttons to select “HD TYPE”.

3. *To set the HD TYPE mode to “1080B”...*

Use the ◀ and ▶ buttons to select “1080B”. The mode switches as follows each time the ◀ or ▶ button is pressed:

◀ → 1080B ↔ 1035I ↔ 1080A ◀

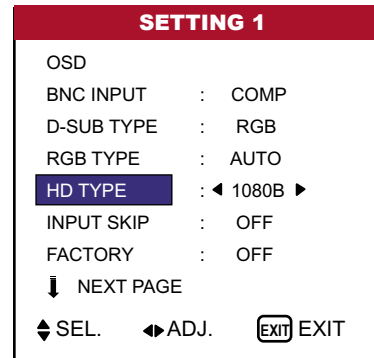

4. *Once the setting is completed...*

Press the EXIT button to return to the main menu.

To delete the main menu, press the EXIT button once more.



**Information**

■ **HD TYPE modes**

These 3 modes are not displayed with correct image signals automatically.

1080B ..... Standard digital broadcasts

1035I ..... Japanese “High Vision” signal format

1080A ..... Special Digital broadcasts (for example: DTC100)

**Setting the Input Skip**

When this is ON, signals which are not present will be skipped over and only pictures whose signals are being transmitted will be displayed. This setting is valid only for the INPUT SELECT button on the unit.

Example: Set to “OFF”

*Press the MENU button on the remote control to display the MAIN MENU on the screen, then...*

1. Use the ▲ and ▼ buttons to select “SETTING 1”, then press the MENU button. The “SETTING 1” menu appears.

2. Use the ▲ and ▼ buttons to select “INPUT SKIP”.

3. *To set the INPUT SKIP mode to “OFF”...*

Use the ◀ and ▶ buttons to select “OFF”. The mode switches as follows each time the ◀ or ▶ button is pressed:

OFF ↔ ON

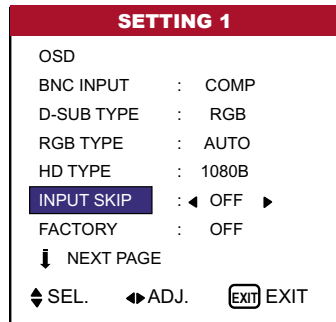

4. *Once the setting is completed...*

Press the EXIT button to return to the main menu.

To delete the main menu, press the EXIT button once more.

**Information**

■ **INPUT SKIP settings**

OFF ..... Regardless of the presence of the signal, scan and display all signals.

ON..... If no input signal is present, skip that signal.

\* “SETTING NOW” will appear during the input search.

■ **Restoring the factory default settings**

Select “FACTORY” under the SETTING 1 menu.

Note that this also restores other settings to the factory defaults.

### Resetting to the default values

Use these operations to restore all the settings (PICTURE ADJUST, AUDIO, IMAGE OPTIONS, SETTING 1~3, etc) to the factory default values.

1. On the MAIN MENU, select “SETTING 1”, then press the MENU button.  
The “SETTING 1” menu appears.

2. Use the ▲ and ▼ buttons to select “FACTORY”, then press the

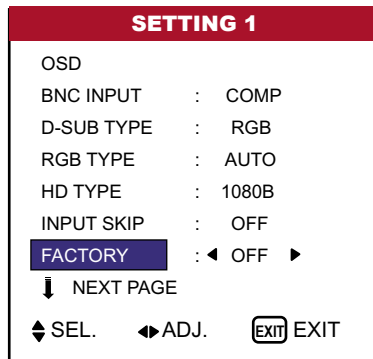

3. Use the ◀ and ▶ buttons to select “ON”, then press the MENU button.

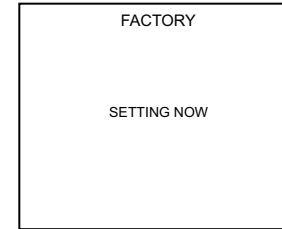
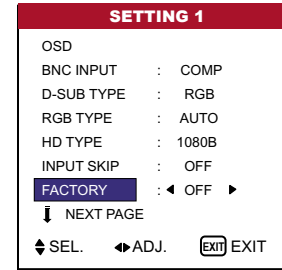

When the “SETTING NOW” screen disappears, then all the settings are restored to the default values.

4. *Once the setting is completed ...*

Press the EXIT button to return to the main menu.

To delete the main menu, press the EXIT button once more.

## » SETTING 2 Menu

### Setting the Auto Off for computer images

This energy-saving (Auto Off) function automatically reduces the monitor's power consumption if no operation is performed for a certain amount of time.

Example: Turning the Auto Off function on

*Perform the following operations.*

*Press the MENU button on the remote control to display the MAIN MENU on the screen, then...*

1. Use the ▲ and ▼ buttons to select “SETTING 2”, then press the MENU button. The “SETTING 2” menu appears.

2. Use the ▲ and ▼ buttons to select “AUTO OFF”.

3. *To turn the Auto Off function on ...*

Use the ◀ and ▶ buttons to select “ON”. The mode switches as follows each time the ◀ or ▶ button is pressed:

ON ↔ OFF

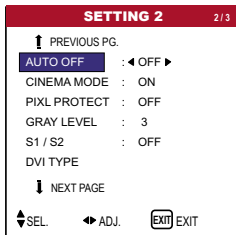

4. *Once the setting is completed...*

Press the EXIT button to return to the main menu.

To delete the main menu, press the EXIT button once more.

### Information

#### ■ AUTO OFF function

\* The auto off function automatically reduces the monitor's power consumption if the computer's keyboard or mouse is not operated for a certain amount of time. This function can be used when using the monitor with a computer.

\* If the computer's power is not turned on or if the computer and selector tuner are not properly connected, the system is set to the off state.

\* For instructions on using the computer's Auto Off function, refer to the computer's operating instructions.

#### ■ AUTO OFF settings

ON ..... In this mode the Auto Off function is turned on. OFF ..... In this mode the Auto Off function is turned off.

#### ■ AUTO OFF function and POWER / STANDBY indicator

The POWER/STANDBY indicator indicates the status of the Auto Off function. See page 51 for indicator status and description.

#### ■ Restoring the factory default settings

Select “FACTORY” under the SETTING 1 menu.

Note that this also restores other settings to the factory defaults.

**POWER / STANDBY indicator**

AUTO OFF mode	POWER / STANDBY indicator	AUTO OFF operating status	Description	Turning the picture back on
On	Green	Not activated.	Horizontal and vertical synchronizing signals are present from the computer.	Picture already on.
Off	Red	Activated.	Horizontal and/or vertical synchronizing signals are not sent from the computer.	Operate the keyboard or mouse. The picture reappears.

**Setting the picture to suit the movie**

The film image is automatically discriminated and projected in an image mode suited to the picture. [NTSC, PAL, PAL60, 480I (60Hz), 525I (60Hz), 576I (50Hz), 625I (50Hz), 1035I (60Hz), 1080I (60Hz) only]

Example: Setting the “CINEMA MODE” to “OFF”

*Perform the following operations.*

*Press the MENU button on the remote control to display the MAIN MENU on the screen, then...*

1. Use the ▲ and ▼ buttons to select “SETTING 2”, then press the MENU button. The “SETTING 2” menu appears.

2. Use the ▲ and ▼ buttons to select “CINEMA MODE”.

3. To set the CINEMA MODE to “OFF”...

Use the ◀ and ▶ buttons to select “OFF”. The mode switches as follows each time the ◀ or ▶ button is pressed:

ON ↔ OFF

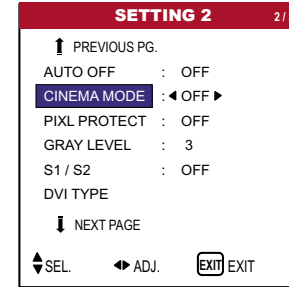
**Information****■ CINEMA MODE**

ON ..... Automatic discrimination of the image and projection in cinema mode.

OFF ..... Cinema mode does not function.

**■ Restoring the factory default settings**

Select “FACTORY” under the SETTING 1 menu.

Note that this also restores other settings to the factory defaults.

4. Once the setting is completed ...

Press the EXIT button to return to the main menu. To delete the main menu, press the EXIT button once more.

## Dynamic Pixel Protection (PIXL PROTECT)

### Reducing burn-in of the screen

The brightness of the screen, the position of the picture, positive/negative mode and image sweep are adjusted to reduce burn-in of the screen.

*Perform the following operations.*

*Press the MENU button on the remote control to display the MAIN MENU on the screen, then...*

1. Use the ▲ and ▼ buttons to select “SETTING 2”, then press the MENU button. The “SETTING 2” menu appears.
2. Use the ▲ and ▼ buttons to select “PIXL PROTECT”, then press the MENU button. The “PIXL PROTECT” screen appears.

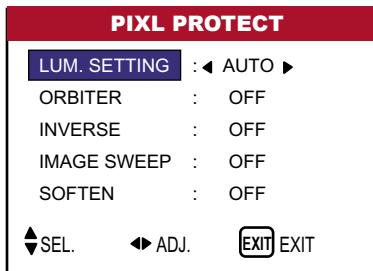

3. Set the PIXL PROTECT mode using ▲ ▼ ◀ and ▶ buttons.  
See page 52 to set LUM. SETTING  
See page 53 to set ORBITER.  
See page 54 to set INVERSE.  
See page 56 to set IMAGE SWEEP.

### Information

#### ■ Restoring the factory default settings

Select “FACTORY” under the SETTING 1 menu.

Note that this also restores other settings to the factory defaults.

4. *Once the setting is completed...*

Press the EXIT button to return to the SETTING 2 screen.

To return to the main menu, press the EXIT button once more.

### LUM. SETTING (Luminance Setting)

Use this to activate the brightness limiter.

Example: Setting “LUM. SETTING” to “SET. 1”

*Perform Steps 1-2 of PIXL PROTECT, then...*

3. Use the ▲ and ▼ buttons to select “LUM SETTING” (relates to above)
4. Use the ◀ and ▶ buttons to select “SET. 1”. The mode switches as follows each time the ◀ or ▶ button is pressed:

→ AUTO ↔ SET. 1 ↔ SET. 2 ↔ SET. 3 ←

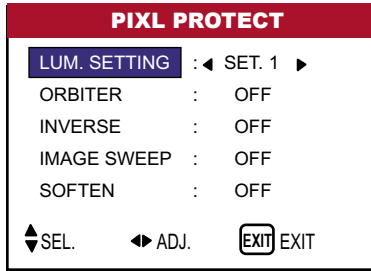

4. Use the ◀ and ▶ buttons to select “AUTO1”. The mode switches as follows each time the ◀ or ▶ button is pressed:

→ OFF ↔ AUTO1 ↔ AUTO2 ↔ MANUAL ←

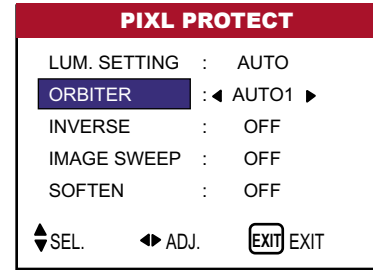

**Information**

■ **LUM. SETTING**

AUTO ..... The brightness of the screen is adjusted automatically to suit the picture quality.  
 SET. 1, 2, 3 .... Sets maximum brightness. The brightness level decreases in the order of SET. 1, 2, 3.  
 SET. 3 provides minimum brightness.

**Information**

■ **ORBITER settings**

OFF ..... Orbiter mode does not function.  
 AUTO1..... The picture moves around the screen intermittently, making the picture smaller.  
 AUTO2 ..... The picture moves around the screen intermittently, making the picture bigger.  
 MANUAL ..... Use can adjust the orbiter function (H-Dot, V-Line and Time) manually. See the following explanation.

**ORBITER**

Use this to set the picture shift.

Example: Setting ”ORBITER” to “AUTO1”

Perform Steps 1-2 of PIXL PROTECT, then...

3. Use the ▲ and ▼ buttons to select “ORBITER” (relates to above).

## OSD (On Screen Display) Controls

### Adjust the ORBITER function manually.

Set the amount of shift and the time between movement.

Example: Setting so that the picture moves 2 dots horizontally and 3 lines vertically every 3 minutes.

*Perform Steps 1-3 of ORBITER, then...*

4. Use the ▲ and ▼ buttons to select “MANUAL”, then press the MENU button. The “ORBITER” screen appears.

5. Adjust the items using the ▲ ▼ ◀ and ▶ buttons. The mode switches as follows each time the ◀ or ▶ button is pressed:

#### • H-DOT

◁ 1 DOT ↔ 2 DOT ↔ ..... ↔ 19 DOT ↔ 20 DOT ▷

#### • V-LINE

◁ 1 LINE ↔ 2 LINE ↔ ..... ↔ 19 LINE ↔ 20 LINE ▷

#### • TIME

◁ 1 M ↔ 2 M ↔ 3 M ↔ 4 M ↔ 5 M ▷

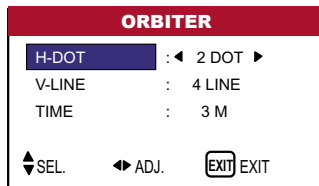

### Information

#### ■ ORBITER FUNCTION settings

H-DOT ..... Moves from 1 to 20 dots in the horizontal direction.

V-LINE..... Moves from 1 to 20 dots in the vertical direction.

TIME ..... Interval of 1~5 minutes.

### INVERSE

Use this to set the inverse mode or to display a white screen.

Example: Setting “INVERSE” to “WHITE”

*Perform Steps 1-2 of PIXL PROTECT, then...*

3. Use the ▲ and ▼ buttons to select “INVERSE”.

4. Use the ◀ and ▶ buttons to select “WHITE”. The mode switches as follows each time the ◀ or ▶ button is pressed:

◁ OFF ↔ ON ↔ WHITE ▷

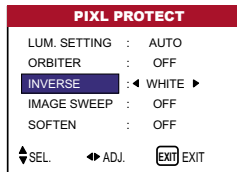

### Setting the time for INVERSE/WHITE

Set a time duration.

Example: Setting to that the INVERSE mode starts in 2 hours and proceeds for one hour and a half.

*Perform Steps 1-3 of INVERSE, then...*

4. Use the ▲ and ▼ buttons to select “ON”, then press the MENU button. The “INVERSE/WHITE” screen appears.

5. Adjust the time using the ▲▼◀ and ▶ buttons. The mode switches as follows each time the ◀ or ▶ button is pressed:

• ACTIVE

☐ ON ↔ 00H03M ↔ 00H06M ↔ ..... ↔ 12H42M ↔ 12H45M ☐

• STANDBY

☐ 00H03M ↔ 00H06M ↔ 00H09M ↔ .... ↔ 12H42M ↔ 12H45M ☐

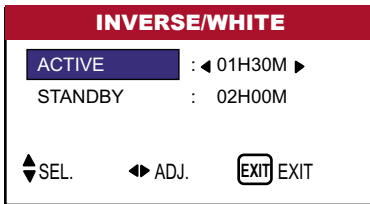

6. *Once the setting is completed...*

Press the EXIT button to return to the PIXL PROTECT screen.

### Information

■ **Setting the time**

ACTIVE ..... Set the time duration for “INVERSE/WHITE”. When the ACTIVE is set to “ON” the mode will stay on.

STANDBY ..... Set the standby time until the “INVERSE/WHITE” mode starts.

- \* The “STANDBY” can not be set when the “ACTIVE” is ON.
- \* The “ACTIVE” and “STANDBY” can be set for up to 12 hours and 45 minutes in units of 3 minutes.
- \* When ending an ACTIVE function, the monitor will be in STAND BY.

[Example]

ACTIVE: 01H30M

STANDBY: 02H00M

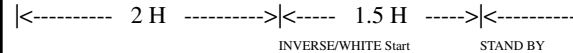

■ **To select “ON” for the “ACTIVE”...**

Set the hours of the active time to 0H and the minutes to 0M. “ON” will be displayed.



## IMAGE SWEEP

When this is set to ON, a white vertical bar moves repeatedly from the left and of the screen to the right end at a constant speed.

Example: Setting “IMAGE SWEEP” to “ON”

*Perform Steps 1-2 of PIXL PROTECT, then...*

3. Use the ▲ and ▼ buttons to select “IMAGE SWEEP”.

4. Use the ◀ and ▶ buttons to select “ON”. The mode switches as follows each time the ◀ or ▶ button is pressed:

OFF ↔ ON

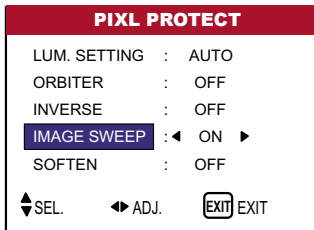

### Information

#### ■ IMAGE SWEEP

ON ..... The white vertical bar appears. You can set the time by pressing the MENU button while “ON” is set.

OFF..... Image sweep mode does not funtion.

## Setting the time for IMAGE SWEEP

Set a time duration and the speed.

Example: Setting to that the IMAGE SWEEP mode starts in 30 minutes and proceeds for one hour and a half.

*Perform Steps 1-3 of IMAGE SWEEP, then...*

4. Use the ▲ and ▼ buttons to select “ON”, then press the MENU button. The “IMAGE SWEEP” screen appears.

5. Adjust the time using the ▲ ▼ ◀ and ▶ buttons. The mode switches as follows each time the ◀ or ▶ button is pressed:

#### • ACTIVE

→ ON ↔ 00H03M ↔ 00H06M ↔ ..... ↔ 12H42M ↔ 12H45M ←

#### • STANDBY

→ 00H03M ↔ 00H06M ↔ 00H09M ↔ ..... ↔ 12H42M ↔ 12H45M ←

#### • SPEED

→ 1 ↔ 2 ↔ 3 ↔ 4 ↔ 5 ←

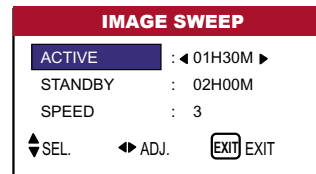

**Information****■ Setting the time**

**ACTIVE** ..... Set the time duration for “IMAGE SWEEP”.  
When the ACTIVE is set to “ON” the mode will stay on.

**STANDBY** .... Set the standby time until the “IMAGE SWEEP” mode starts.

**SPEED** ..... Set the moving speed for the “IMAGE SWEEP”.  
The speed decreases as the number increases.

- \* The “STANDBY” can not be set when the “ACTIVE” is ON.
- \* The “ACTIVE” and “STANDBY” can be set for up to 12 hours and 45 minutes in units of 3 minutes.

6. Once the setting is completed...

Press the EXIT button to return to the IMAGE SWEEP screen.

**SOFTEN**

Reduces edges and softens the image.

Example: Setting “SOFTEN” to “2”

3. Use the ▲ and ▼ buttons to select “SOFTEN”.

4. Use the ◀ and ▶ button to select “2”. The mode switches as follows each time the ◀ or ▶ button is pressed:

□ 1 ↔ 2 ↔ 3 ↔ 4 ↔ 5 ◀

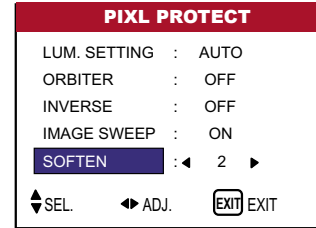
**Information****■ SOFTEN settings**

**OFF** ..... Turns the SOFTEN function off.

**1,2,3,4** ..... Activates the SOFTEN setting. The higher numbers create a softer image.

“SHARPNESS” can not be adjusted on the “PICTURE ADJUST” menu.

**Setting the Sidebar Lev. for the sides of the screen**

Use this procedure to set the Sidebar Lev. for the parts on the screen on which nothing is displayed when the screen is set to 4:3 size.

Example: Adjusting the “SIDEBAR LEV.”

Perform the following operations.

1. On the MAIN MENU, select “SETTING 2”, then press the MENU button. The “SETTING 2” menu appears.

## OSD (On Screen Display) Controls

2. Use the ▲ and ▼ buttons to select “SIDEBAR LEV.”.

3. To adjust the “SIDEBAR LEV.” ...

Use the ◀ and ▶ buttons to adjust the SIDEBAR LEV..

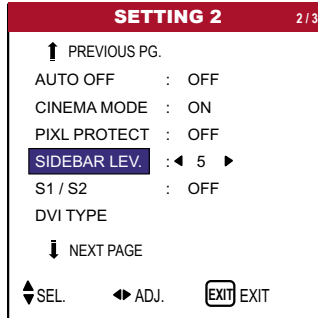

### Information

#### ■ SIDEBAR LEV. settings

This adjusts the brightness of the black (the Sidebar Lev.) for the sides of the screen. The standard is 0 (black). The level can be adjusted from 0 to 15. The factory setting is 3 (dark gray).

#### ■ Restoring the factory default settings

Select “FACTORY” under the SETTING 1 menu.

Note that this also restores other settings to the factory defaults.

## Setting the screen size for S1/S2 video input

If the S-Video signal contains screen size information, the image will be automatically adjusted to fit the screen when this S1/S2 is set to AUTO.

This feature is available only when an S-Video signal is input via the VIDEO3 terminal.

Example: Setting the “S1/S2” to “AUTO”

*Perform the following operations.*

1. On the MAIN MENU, select “SETTING 2”, then press MENU button. The “SETTING 2” screen appears.

2. Use the ▲ and ▼ buttons to select “S1/S2”.

3. Use the ▲ and ▼ buttons to select “AUTO”. The mode switches as follows each time the ◀ and ▶ buttons is pressed: OFF ↔ AUTO

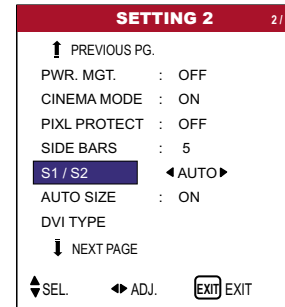

**Information**

■ **S1/S2 Settings**

AUTO..... Adjusts the screen size automatically according to the S1/S2 video signal.  
 OFF..... Turns the S1/S2 function off.

■ **Restoring the factory default settings**

Select “FACTORY” under the SETTING 1 menu. Note that this also restores other settings to the factory defaults.

4. *Once the setting is completed...*

Press the EXIT button to return to the SETTING 3 screen.  
 To return to the main menu, press the EXIT button once more.

**Setting the signal and black level for DVI signal**

Example: Setting the “PLUG/PLAY” mode on “STB/DVD”

*Perform the following operations.*

1. On the MAIN MENU, select “SETTING 2”, then press the MENU button. The “SETTING 2” screen appears.
2. Use the ▲ and ▼ buttons to select “DVI TYPE”, then press the MENU button. The “DVI TYPE” screen appears.

3. *To set PLUG/PLAY mode to “STB/DVD” ...*

Use the ◀ and ▶ buttons to select “STB/DVD”.

The mode switches as follows each time the ◀ and ▶ buttons is pressed:

PLUG/PLAY:                   PC ↔ STB/DVD  
 BLACK LEVEL:               LOW ↔ HIGH

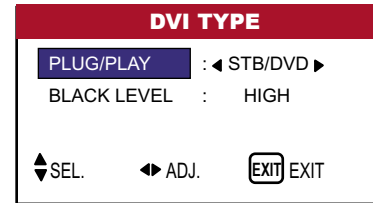

**Information**

■ **PLUG/PLAY Settings**

PC..... When connected to the PC signal.  
           BLACK LEVEL is set to “HIGH” automatically.  
 STB/DVD.... When connected to a satellite receiver, DVD, etc.  
           BLACK LEVEL is set to “HIGH” automatically.

■ **BLACK LEVEL settings**

LOW ..... When connected to the PC signal.  
 HIGH ..... When connected to the satellite receiver, DVD, etc.  
           Change “HIGH” into “OFF” if the black level appears gray.

## » SETTING 3 Menu

### Using the timer

This function sets the monitor to turn ON/OFF automatically at a set time.

*Perform the following operations.*

1. On the MAIN MENU, select “SETTING 3”, then press MENU button. The “SETTING 2” screen appears.

2. Use the ▲ and ▼ buttons to select “TIMER”, then press the MENU button.

The “TIMER” screen appears.

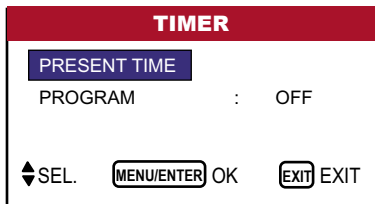

3. Set the TIMER using the ▲ ▼ ◀ and ▶ buttons.

See page 60 to set PRESENT TIME.

See page 62 to set PROGRAM.

### Information

#### ■ Restoring the factory default settings

Select “FACTORY” under the SETTING 1 menu.

Note that this also restores other settings to the factory defaults.

### PRESET TIME

This sets the day of the week and present time.

Example: Setting “WEDNESDAY”, “22:05”

*Perform Steps 1-2 of TIMER, then...*

3. Use the ▲ and ▼ buttons to select “PRESET TIME”, then press the MENU button. The “PRESET TIME” screen appears.



4. Use the ▲ and ▼ buttons to select the item, then adjust using the ◀ and ▶ buttons.

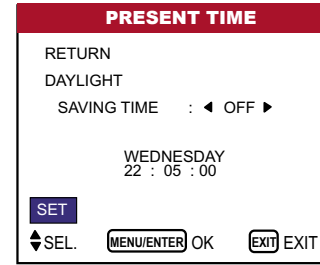
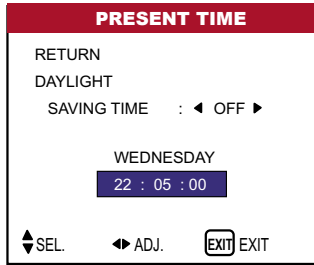

The mode switches as follows each time the ◀ or ▶ buttons is pressed:

- DAYLIGHT SAVING TIME

ON ↔ OFF

- DAY

↔ SUNDAY ↔ MONDAY ↔ ..... ↔ FRIDAY ↔ SATURDAY ↔

- HOUR/MINUTES

↔ 00:00 ↔ 00:01 ↔ 00:02 ↔ ..... ↔ 23:58 ↔ 23:59 ↔

5. *Once the setting is completed...*

Use the ▲ and ▼ buttons to select “SET”, then press the MENU button. The adjustments are stored and return to the TIMER menu.

**Information**

- **PRESET TIME settings**

DAYLIGHT SAVING TIME ....

Use to set DAYLIGHT SAVING TIME.

ON: The present time + 1 hour.

OFF: Cancelled

DAY ..... Set the day of the week (e.g. Sunday).

HOUR ..... Set the hour in the 24-hour format (range 00 to 23).

MINUTES ..... Set the minutes (range 00 to 59)

\* If you press the EXIT button instead of the MENU button in step 5, the settings can not be mode.

## OSD (On Screen Display) Controls

### PROGRAM TIMER

This sets the day and time at which the power will be switched ON/OFF as well as the input mode.

Example: Setting so that the power will be switched on at 8:30 A.M., Monday, displaying RGB2 source, and switched off at 10:30 A.M.

*Perform Steps 1-2 of TIMER, then...*

3. Use the ▲ and ▼ buttons to select “PROGRAM”.

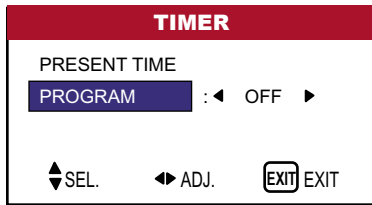

4. Use the ◀ and ▶ buttons to select “ON”, then press the MENU button. The “PROGRAM TIMER” screen appears.

5. Adjust using the ▲ ▼ ◀ and ▶ buttons and ZOOM +/- button.

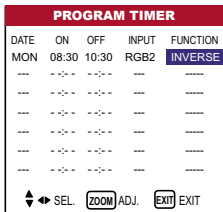

The mode switches as follows each time the ZOOM +/- button is pressed:

- DATE

→ -- ↔ SUN ↔ MON ↔ ... ↔ SAT ↔ \* ↔ SUN ↔ \*MON ↔ ... ↔ \*SAT ←

- ON/OFF Hour

→ 00 ↔ 01 ↔ 02 ↔ ... ↔ 21 ↔ 22 ↔ 23 ←

- MINUTE

→ 00 ↔ 01 ↔ 02 ↔ ... ↔ 57 ↔ 58 ↔ 59 ←

- INPUT

→ -- ↔ LAST ↔ VIDEO1 ↔ VIDEO2 ↔ VIDEO3 ↔ HD/DVD1 ←  
→ RGB3 ↔ RGB2 ↔ RGB1 ↔ HD/DVD2 ←

- FUNCTION

→ -- ↔ ORBITER ↔ INVERSE ↔ WHITE ↔ IMAGE SWEEP ←

6. *Once the setting is completed...*

Press the EXIT button. The programs are stored, and return to the TIMER screen.





## OSD (On Screen Display) Controls

The mode switches as follows each time the ◀ or ▶ buttons is pressed:

The available sources depend on the setting of “BNC INPUT”.

RGB:      LAST ↔ VIDEO1 ↔ VIDEO2 ↔ VIDEO3  
            RGB3 ↔ RGB2 ↔ RGB1 ↔ HD1

COMP:     LAST ↔ VIDEO1 ↔ VIDEO2 ↔ VIDEO3  
            RGB3 ↔ RGB1 ↔ HD2 ↔ HD1

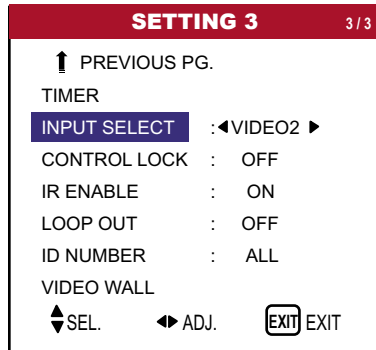

### 4. Once the setting is completed ...

Press the EXIT button to return to the main menu. To delete the main menu, press the EXIT button once more.

### Information

#### ■ INPUT SELECT settings

LAST ..... Last mode (the mode that was last selected at the time the power was switched off).

VIDEO 1, 2, 3 ..... VIDEO input mode.

RGB 1, 2, 3 ..... RGB input mode.

HD 1, 2 ..... HD/DVD input mode.

#### ■ Restoring the factory default settings

Select “FACTORY” under the SETTING 1 menu.

Note that this also restores other settings to the factory defaults.

### Enabling/disabling the front panel controls

This function enables/disables the front panel controls.

Example: Setting “ON”

*Perform the following operations.*

*Press the MENU button on the remote control to display the MAIN MENU on the screen, then...*

1. Use the ▲ and ▼ buttons to select “SETTING 3”, then press the MENU button. The “SETTING 3” screen appears.

2. Use the ▲ and ▼ buttons to select “CONTROL LOCK”.

3. To set the **CONTROL LOCK** to “ON”...

Use the ◀ and ▶ buttons to select “ON”, then press the MENU button.

The mode switches as follows each time the ◀ or ▶ button is pressed: OFF ↔ ON

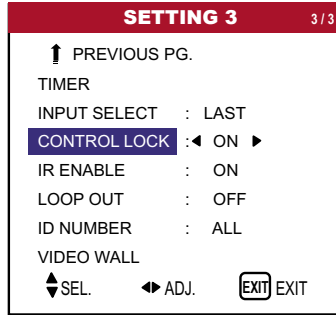

4. Once the setting is completed ...

Press the EXIT button to return to the main menu. To delete the main menu, press the EXIT button once more.

**Information**

■ **CONTROL LOCK settings**

ON ..... Disables the buttons on the front panel.

OFF ..... Enables the buttons on the front panel.

\* Even when the CONTROL LOCK is set, the POWER switch will not be locked.

\* This becomes effective when the on-screen menu goes out.

**Enabling/disabling remote control wireless transmission**

This function enables/disables remote control wireless transmission.

Example: Setting “OFF”

Perform the following operations.

Press the MENU button on the remote control to display the MAIN MENU on the screen, then...

1. Use the ▲ and ▼ buttons to select “SETTING 3”, then press the MENU button. The “SETTING 3” screen appears.

2. Use the ▲ and ▼ buttons to select “IR ENABLE”.

3. To set the **IR ENABLE** to “OFF”...

Use the ◀ and ▶ buttons to select “OFF”, then press the MENU button.

The mode switches as follows each time the ◀ or ▶ button is pressed: OFF ↔ ON

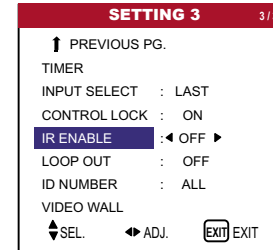

## OSD (On Screen Display) Controls

### 4. Once the setting is completed ...

Press the EXIT button to return to the main menu. To delete the main menu, press the EXIT button once more.

#### Information

##### ■ IR ENABLE settings

ON ..... Enables remote control wireless transmission.

OFF ..... Disables remote control wireless transmission. Set "OFF" to avoid unwanted control from other remote controls.

##### ■ Restoring the factory default settings

Select "FACTORY" under the SETTING 1 menu.

Note that this also restores other settings to the factory defaults.

### Loop Out Setting

When this feature is set to ON, the received signal will be looped out.

Example: Setting "ON"

*Perform the following operations.*

*Press the MENU button on the remote control to display the MAIN MENU on the screen, then...*

1. Use the ▲ and ▼ buttons to select "SETTING 3", then press the MENU button. The "SETTING 3" screen appears.

2. Use the ▲ and ▼ buttons to select "LOOP OUT".

3. To set the LOOP OUT to "ON"...

Use the ◀ and ▶ buttons to select "ON".

The mode switches as follows each time the ◀ or ▶ button is pressed: OFF ↔ ON

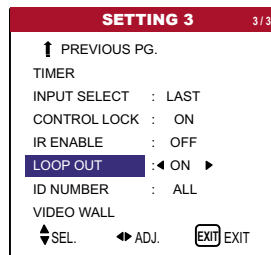

#### Information

##### ■ LOOP OUT settings

ON ..... The received signal will be looped out via PC1 terminal or VIDEO1 terminal.

OFF ..... The received signal will not loop out.

\* Even if LOOP OUT is ON, signals would not be sent out if POWER is being turned off.

##### ■ To connect to another display...

See page 68.

##### ■ If the RGB/PC1 signal is present at the time the power is switched on...

The RGB/PC1 input will be displayed regardless of the setting of LOOP OUT.

##### ■ Restoring the factory default settings

Select "FACTORY" under the SETTING 1 menu. Note that this also restores other settings to the factory defaults.

## ID Number Setting

When using more than one of these displays, this function sets ID numbers so that operation of the remote control does not cause multiple monitors to operate at the same time.

Example: Setting “2”

*Perform the following operations.*

*Press the MENU button on the remote control to display the MAIN MENU on the screen, then...*

1. Use the ▲ and ▼ buttons to select “SETTING 3”, then press the MENU button. The “SETTING 3” screen appears.

2. Use the ▲ and ▼ buttons to select “ID NUMBER”.

3. *To set the ID NUMBER to “02”...*

Use the ◀ and ▶ buttons to select “2”.

The mode switches as follows each time the ◀ and ▶ button is pressed:

◁ ALL ↔ 1 ↔ 2 ↔ ... ↔ 255 ↔ 256 ▷

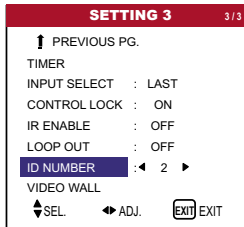

\* To reset back to ALL

Press the CLEAR button.

### Information

#### ■ ID NUMBER settings

ALL ..... ID NUMBER will not be set.

1 to 256 ..... ID NUMBER will be set.

#### ■ When the ID NUMBER has been set

You can also set ID NUMBER for each remote control to operate the plasma display individually. To do so, requires special remote control available only from Vidikron factory Service Department.

#### ■ Restoring the factory default settings

Select “FACTORY” under the SETTING 1 menu.

Note that this also restores other settings to the factory defaults.

To set the ID number for the remote control (requires special remote control available only from Vidikron factory Service Department)

Example: Setting “2”

1. Use the ▲ and ▼ buttons to select “ID NUMBER”.

2. To set the ID NUMBER to “2” ...

Use the ◀ and ▶ buttons to select “2”. The mode switches as follows each time the ◀ and ▶ button is pressed:

◁ ALL ↔ 1 ↔ 2 ↔ ... ↔ 255 ↔ 256 ▷

## OSD (On Screen Display) Controls

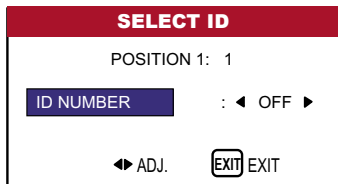

\* To reset back to ALL  
Press the CLEAR button.

4. Once the setting is completed...  
Press the EXIT button to delete the SELECT ID screen.

### Video Wall Setting

Use this feature to configure a 2x2 or 3x3 video wall.

*Perform the following operations.*

*Press the MENU button on the remote control to display the MAIN MENU on the screen, then...*

1. Use the ▲ and ▼ buttons to select “SETTING 3”, then press the MENU button. The “SETTING 3” screen appears.
2. Use the ▲ and ▼ buttons to select “VIDEO WALL”, then press the MENU button. The “VIDEO WALL” screen appears.

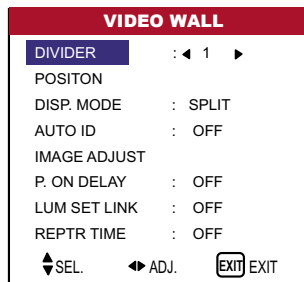

3. Set the VIDEO WALL using ▲ ▼ ◀ and ▶ buttons.  
See page 69 to set DIVIDER.  
See page 69 to set POSITION.  
See page 70 to set DISP. MODE.  
See page 70 to set AUTO ID.  
See page 71 to set IMAGE ADJUST.  
See page 72 to set P. ON DELAY.  
See page 73 to set LUM SET LINK.  
See page 74 to set REPTR TIME.

4. Once the setting is completed...  
Press the EXIT button to return to the SETTING 3 menu.

5. Press the EXIT button to return to the main menu. To delete the main menu, press the EXIT button once more.

### NOTE:

*A contingency method of shutting off the electric power should be used in cases of emergency during video wall setup.*

**Information**

■ **Restoring the factory default settings**

Select "FACTORY" under the SETTING 1 menu.  
Note that this also restores other settings to the factory defaults.

**DIVIDER**

Set the 2x2 or 3x3 video wall.

Example: Setting "4"

*Perform Steps 1-2 of VIDEO WALL, then...*

3. Use the ▲ and ▼ buttons to select "DIVIDER".

4. Use the ◀ and ▶ buttons to select "4".

The mode switches as follows each time the ◀ or ▶ button is pressed:

☐ OFF ↔ 1 ↔ 4 ↔ 9 ☐

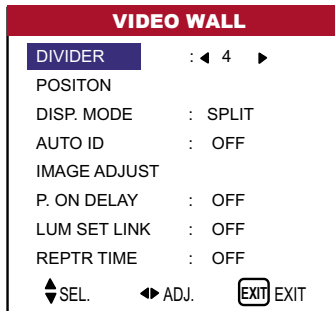

**Information**

■ **DIVIDER settings**

OFF, 1 ..... 1 Screen (Matrix display function does not work)

4 ..... 4 Screens (2x2 video wall)

9 ..... 9 Screens (3x3 video wall)

\* When you select "4" or "9", set the VIDEO WALL POSITION.

**VIDEO WALL POSITION**

Set the position of each display.

Example: Setting "4"

*Perform Steps 1-2 of VIDEO WALL, then...*

3. Use the ▲ and ▼ buttons to select "POSITION", then press the MENU button. The "VIDEO WALL POSITION" screen appears.

4. Use the ◀ and ▶ buttons to select "NO. 4".

The mode switches as follows each time the ◀ or ▶ button is pressed:

• 4 Screens

☐ NO. 1 ↔ NO. 2 ↔ NO. 3 ↔ NO. 4 ☐

• 9 Screens

☐ NO. 7 ↔ NO. 8 ↔ ..... ↔ NO. 14 ↔ NO. 15 ☐

## OSD (On Screen Display) Controls

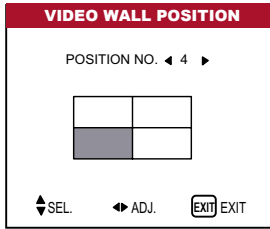

5. Press the EXIT button to return to the VIDEO WALL screen.

### Information

#### ■ VIDEO WALL POSITION settings

1 Screen ..... There is no need to set POSITION.

4 Screens

NO. 1	NO. 2
NO. 4	NO. 3

9 Screens

NO. 7	NO. 8	NO. 9
NO. 10	NO. 11	NO. 12
NO. 13	NO. 14	NO. 15

### DISP. MODE

Select the screen mode from between two options (Splitting, Blanking).

Example: Setting “BLANK”

Perform Steps 1-2 of VIDEO WALL, then...

3. Use the ▲ and ▼ buttons to select “DISP. MODE”.

4. Use the ◀ and ▶ buttons to select “BLANK”.

The mode switches as follows each time the ◀ or ▶ button is pressed: SPLIT ↔ BLANK

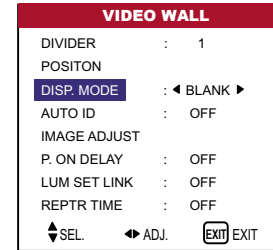

### Information

#### ■ DISP. MODE SETTINGS

SPLIT ..... Combines enlarged screens and creates multiple screens.

BLANK ..... Corrects misalignment of combined screen portions and creates multiple screens.

### AUTO ID

This feature automatically sets the ID numbers of multiple displays connected to each other.

Example: Setting “ON”

Set the ID number for the No. 1 display on ID NUMBER menu.

Perform Steps 1-2 of VIDEO WALL, then...

3. Use the ▲ and ▼ buttons to select “AUTO ID”.

4. Use the ◀ and ▶ buttons to select “ON”, then press the MENU button.

The mode switches as follows each time the ◀ or ▶ button is pressed: OFF ↔ ON

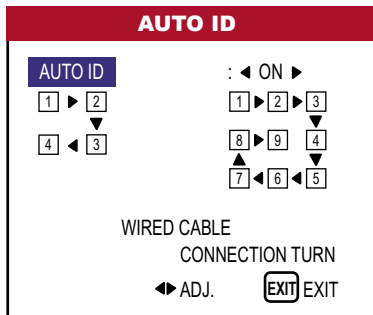

### Information

#### ■ AUTO ID settings

ON ..... Enables Auto ID function. In the case shown below, display 1 will be set as ID 1, display 2 as ID 2, etc.

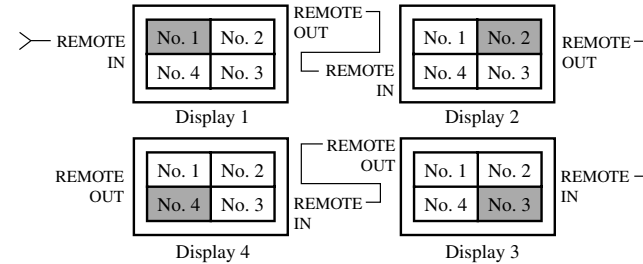

OFF ..... Disables Auto ID function.

### IMAGE ADJUST

The position of the image can be adjusted and flickering of the image can be corrected.

Example: Adjusting the vertical position.

Perform Steps 1-2 of VIDEO WALL, then...

3. Use the ▲ and ▼ buttons to select “IMAGE ADJUST”, then press the MENU button. The “IMAGE ADJUST” screen appears.



## OSD (On Screen Display) Controls

4. Use the ▲ and ▼ buttons to select “V SHIFT”.

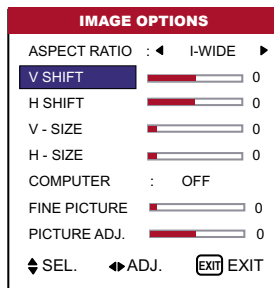

5. Adjust using the ◀ and ▶ buttons.



\* If neither the ◀ and ▶ button is pressed within 5 seconds, the current setting is set and the previous screen reappears.

6. *Once the setting is completed...*

Press the EXIT button to return to the VIDEO WALL screen.

### Information

#### ■ IMAGE ADJUST settings

These are the same functions as the IMAGE ADJUST menu on page xx.

## P. ON DELAY (Power on delay)

Use this function to activate power-on delay.

Turn on the AUTO ID before the following operations.

Example: Setting “ON”

Perform Steps 1-2 of VIDEO WALL, then...

3. Use the ▲ and ▼ buttons to select “P. ON DELAY”.

4. Use the ◀ and ▶ buttons to select “ON”.

The mode switches as follows each time the ◀ or ▶ button is pressed: OFF ↔ ON

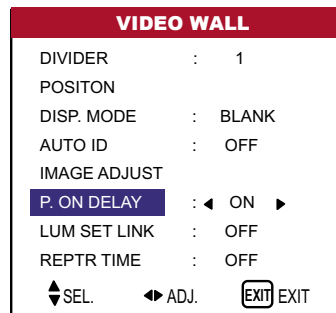

**Information****■ P. ON DELAY settings**

ON ..... Turns on the main power of each display after a delay time.

OFF ..... Turns on the main power of all displays at the same time.

\* Once this function has been set to “ON”, POWER ON/OFF button on the remote control does not function except for the No. 1 monitor. By pressing the POWER ON button on the remote control the No. 1 monitor will turn on and the others will be turned on one by one automatically.

\* From the second monitor onward, neither the POWER button on the unit nor the POWER ON button on the remote control does function. However, by pressing and holding the POWER ON button for more than 3 seconds, the monitor will be turned on.

The mode switches as follows each time the ◀ or ▶ button is pressed: OFF ↔ ON

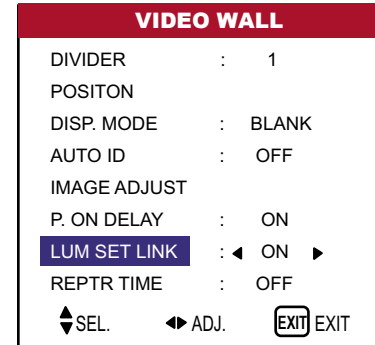
**LUM SET LINK**

Use this function to set a uniform brightness for each display.

Turn on the AUTO ID before the following operations.

Example: Setting “ON”

*Perform Steps 1-2 of VIDEO WALL, then...*

- Use the ▲ and ▼ buttons to select “LUM SET LINK”.
- Use the ◀ and ▶ buttons to select “ON”, then press the MENU button.

**Information**

■ **LUM SET LINK settings**

ON ..... Sets a uniform brightness for each screen in a 2x2 video wall.

OFF .... Sets the individual screen brightness for each screen in a 2x2 video wall.

\* Set “OFF” in a 3x3 video wall.

\* When this function is set “ON”, connect your plasma displays with the remote cable (optional) in the order of the position numbers for the 2x2 video wall. See the drawing below.

\* If there are changes in the DIVIDER or POSITION, the LUM SET LINK will automatically turn OFF.

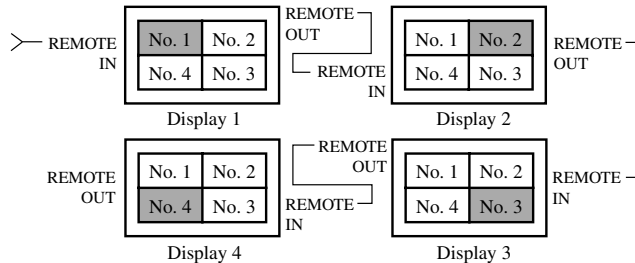

**NOTE:**

The remote control can not be operated unless the IR ENABLE is set to “OFF”.

**REPEAT TIMER (REPTR)**

Use this to set two timers. Each timer can use the DIVIDER, SOURCE and ACTIVE functions.

Turn on the AUTO ID before the following operations.

Example:

TIMER1... VIDEO1 will be displayed for 3 minutes.

TIMER2... RGB1 will be displayed for 6 minutes in a 2x2 video wall.

*Perform Steps 1-2 of VIDEO WALL, then...*

3. Use the ▲ and ▼ buttons to select “REPTR TIME”.

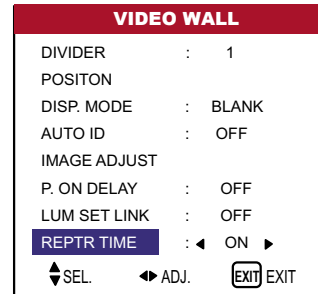

4. Use the ◀ and ▶ buttons to select “ON”, then press the MENU button. The “REPTR TIME” screen appears.

5. Adjust using the ▲▼◀ and ▶ buttons.  
The mode switches as follows each time the ◀ or ▶ button is pressed:

REPTR TIME	
1 DIVIDER	: 1
SOURCE	: VIDEO1
ACTIVE	: 00H03M
2 DIVIDER	: 4
SOURCE	: RGB1
ACTIVE	: ◀ 00H06M ▶
▲SEL.	◀ ADJ.  EXIT

- DIVIDER

→ 1 ↔ 4 ↔ 9 ←

- SOURCE

The available sources depend on the setting of “BNC INPUT”.

RGB: → VIDEO1 ↔ VIDEO2 ↔ VIDEO3 ↔ HD/DVD1 ←  
 ↳ RGB3 ↔ RGB2 ↔ RGB1 ↔ HD/DVD2 ←

- ACTIVE

→ 00H01M ↔ 00H02M ↔ 00H03M ↔ ... ↔ 04H14M ↔ 04H15M ←

6. Once the setting is completed...

Press the EXIT button to return to the VIDEO WALL screen.

### Information

- **REPTR TIME settings**

If you set both timers, Timer 1 and Timer 2 run consecutively.  
In the case of the Video Wall, timer No. 1 can be used to control all the displays simultaneously.

\* This becomes effective when the on-screen menu goes out.

■ **Restoring the factory default settings**

Select “FACTORY” under the SETTING 1 menu.

Note that this also restores other settings to the factory defaults.

» **Language Settings Menu**

**Setting the language for the menus**

The menu display can be set to one of seven languages: English, German, French, Italian, or Spanish.

Example: Setting the menu display to “DEUTSCH”

*Press the MENU button on the remote control to display the MAIN MENU on the screen, then...*

1. Use the ▲ and ▼ buttons to select “LANGUAGE”, then press the MENU button. The “LANGUAGE” screen appears.

2. To select “DEUTSCH”...

Use the ◀ and ▶ buttons to select “DEUTSCH”.

The mode switches as follows each time the ◀ and ▶ buttons are pressed:



3. *Once the setting is completed...*

Press the MENU button to store the setting and return to the main menu. To delete the main menu, press the EXIT button.

**Information**

■ **Language settings**

- English
- German
- French
- Spanish
- Italian

## » Video Standard Menu

### Setting the video signal format

Use these operations to set the video standards of composite video signals or Y/C input signals.

Example: Setting the video standard to “3.58 NTSC”

*Press the MENU button on the remote control to display the MAIN MENU on the screen, then...*

1. Use the ▲ and ▼ buttons to select “VIDEO STANDARD”, then press the MENU button. The “VIDEO STANDARD” screen appears.

2. *To select “3.58NTSC”...*

Use the ◀ and ▶ buttons to select “3.58NTSC”.

The mode switches as follows when the ◀ and ▶ buttons are pressed:

↪ AUTO ↔ 3.58NTSC ↔ 4.43NTSC ←  
↪ SECAM ↔ PAL-M ↔ PAL-N ↔ PAL-60 ↔ PAL ←

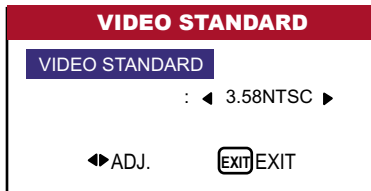

3. *Once the setting is completed...*

Press the EXIT button to return to the main menu. To delete the main menu, press the EXIT button.

**Information**

■ **Video standard formats**

Different countries use different formats for video signals. Set to the video standard used in your current country.

AUTO ..... The video standards are automatically identified and the format is set accordingly.

PAL ..... This is the standard format used mainly in the United Kingdom and Germany.

SECAM ..... This is the standard format used mainly in France and Russia.

4.43 NTSC,

PAL60 ..... This format is used for videos in countries using PAL and SECAM video signals.

3.58 NTSC .... This is the standard format used mainly in the United States and Japan.

PAL-M ..... This is the standard format used mainly in Brazil.

PAL-N ..... This is the standard format used mainly in Argentina.

» **Signal Info. Menu**

**Checking the frequencies, polarities of input signals, and resolution**

Use this function to check the frequencies and polarities of the signals currently being input from a computer, etc.

*Press the MENU button on the remote control to display the MAIN MENU on the screen, then...*

1. Use the ▲ and ▼ buttons to select “SIGNAL INFO.”, then press the MENU button.

2. The “SIGNAL INFO” is displayed.

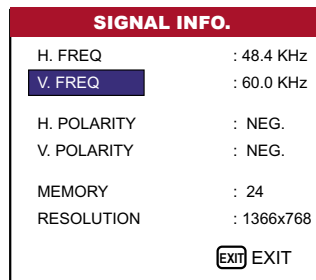

3. *Once you have checked the frequency ...*

Press the EXIT button to return to the main menu. To delete the main menu, press the EXIT button once more.

# EXTERNAL CONTROLS

## Application

These specifications cover the communications control of the plasma monitor by external equipment.

## Connections

Connections are made as described below.

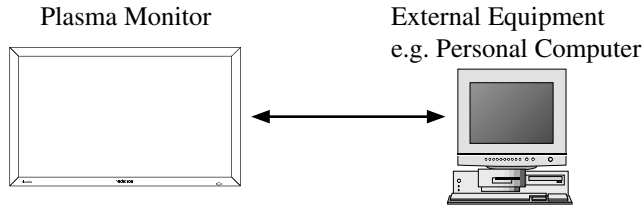

1) Connector on the plasma monitor side: EXTERNAL CONTROL connector.

Type of connector: D-Sub 9-pin male

No.	Pin Name	No.	Pin Name
1	No Connection	8	CTS (Clear to send)
2	RXD (Receive data)	9	No Connection
3	TXD (Transmit data)		
4	DTR (DTE side ready)		
5	GND		
6	DSR (DCE side ready)		
7	RTS (Ready to send)		

The diagram shows a D-Sub 9-pin male connector with pins numbered 1 through 9. Pins 1 and 9 are not connected, while pins 2 through 8 are connected to the external equipment.

2) Connector on the external equipment side: Serial port (RS-232C) connector.

See the specifications of the equipment that is to be connected for the type of connector and the pin assignment.

3) Wiring

**Use a crossed (reverse cable).**

Wire the cable so that each pair of data lines cross between the two devices. These data line pairs are RXD (Receive data) and TXD (Transmit data), DTR (DTE side ready) and DSR (DCE side ready), and RTS (Ready to send) and CTS (Clear to send).

If DTR (4) and DSR (6) are not available, these 2 pins can be ignored. If RTS (7) and CTS (8) are not available, these 2 pins can be tied together.

## Communication Parameters

(1) Communication system	Asynchronous
(2) Interface	RS-232C
(3) Baud rate	9600 bps
(4) Data length	8 bits
(5) Parity	Odd
(6) Stop bit	1 bit
(7) Communication code	Hex



## Communication Format

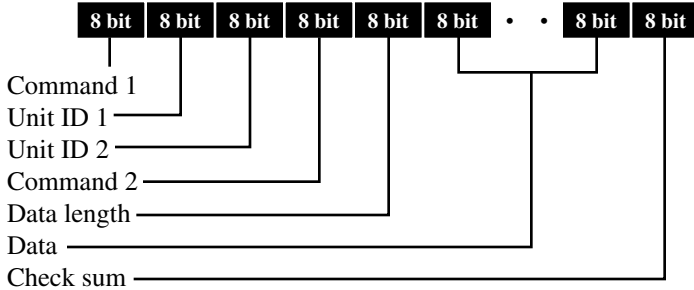

### Command 1

Command 1, along with command 2, is a number used to distinguish each command. In the case of ACK, when the lower order 4 bits is FH (as in 3FH and 7FH), this indicates that the commands and data of the supported equipment have been received. When the lower order 4 bits is BH (as in 3BH and 7BH), this indicates that unsupported commands and data have been received.

### Unit ID 1 and Unit ID 2

Unit ID 1 and unit ID 2 are numbers used to identify the equipment that is to be connected. 60H is used for the plasma monitor and 80H is used for external control equipment such as a personal computer.

- 1) Unit ID 1: Indicates the equipment sending the signal
- 2) Unit ID 2: Indicates the equipment receiving the signal

### Command 2

Command 2, along with command 1, is a number used to distinguish each command.

Check Sum (CKS), Error Processing, and ACK

- 1) The check sum described below and RS-232C odd parity are used together for a check of the received data. The check sum is the lower order 8 bits of one frame of sent or received data comprising the sum total of Command 1, Unit ID 1 and 2, Command 2, Data Length, and Data.

### Check Sum Example

DFH	80H	60H	47H	01H	01H	08H
Com- mand 1	Unit ID 1	Unit ID 2	Com- mand 2	Data Length	Data	Check Sum
<div style="border: 1px solid black; width: 100%; height: 15px; margin-bottom: 5px;"></div> <b>Total 208H</b>						

### 2) Error Processing

- \* When the communication interval is vacant for more than 4 ms, thereafter a received Command 1 will be recognized. If, at this time, meaningful data cannot be recognized, that data will not be recognized (as valid data).
- \* An ACK will not be returned unless the receive data error, the check sum error, and the receive data are all taken in.

## Command Reference List

		CMD1	CMD2	LEN
01	Power ON	9FH	4EH	00H
02	Power OFF	9FH	4FH	00H
03	Input Switch Change	DFH	47H	01H
04	VOLUME Gain Data	DFH	7FH	03H
05	AUDIO Mute On	9FH	3EH	00H
06	AUDIO Mute Off	9FH	3FH	00H
07	CONTRAST Gain Data	DFH	7FH	03H
08	BRIGHT Gain Data	DFH	7FH	03H
09	SHARPNESS Gain Data	DFH	7FH	03H
10	COLOR Gain Data	DFH	7FH	03H
11	TINT Gain Data	DFH	7FH	03H
12	IMAGE MEM. Select	DFH	0AH	01H
13	WHITE BAL. Select	DFH	00H	01H
14	RED Gain Data	DFH	7FH	04H
15	GREEN Gain Data	DFH	7FH	04H
16	BLUE Gain Data	DFH	7FH	04H
17	VID NR Mode Set	DFH	C0H	01H
18	BASS Gain Data	DFH	7FH	03H
19	TREBLE Gain Data	DFH	7FH	03H
20	BALANCE Gain Data	DFH	7FH	03H
21	ASPECT RATIO Select	DFH	51H	01H
22	V SHIFT Gain Data	DFH	7FH	03H
23	H SHIFT Gain Data	DFH	7FH	03H
24	V-SIZE Gain Data	DFH	7FH	03H

25	H-SIZE Gain Data	DFH	7FH	03H
26	PHASE Gain Data	DFH	7FH	03H
27	CLOCK Gain Data	DFH	7FH	03H
28	OSD Select	DFH	58H	01H
29	OSD ADJ. Gain Data	DFH	1AH	02H
30	AUTO OFF Select	DFH	1AH	02H
31	SIDEBAR LEV. Set	DFH	C6H	01H
32	CINEMA MODE Set	DFH	C1H	01H
33	RGB3 ADJ. Select	DFH	1AH	02H
34	PIXL PROTECT Set	DFH	6BH	03H
35	INVERSE Set	DFH	C7H	03H
36	IMAGE SWEEP Set	DFH	C8H	04H
37	FACTORY	1FH	54H	00H
38	AUDIO Set	DFH	70H	02H
39	BNC Select	DFH	8CH	01H
40	RGB Select	DFH	8BH	01H
41	HD Select	DFH	8AH	01H
42	LANGUAGE Select	DFH	5BH	01H
43	VIDEO STANDARD Select	DFH	5CH	01H
44	FREQUENCY Request	1FH	26H	00H
45	INPUT MODE Request	1FH	41H	00H
46	VIDEO ADJ Request	1FH	45H	00H
47	AUDIO Request	1FH	6FH	00H
48	FAILURE MODE Request	1FH	3FH	00H
49	MODEL NAME Request	1FH	17H	00H

## External Controls

### 01 POWER ON

#### Function

The external control equipment switches on the power of the plasma monitor.

#### Transmission Data

9FH	80H	60H	4EH	00H	CKS
-----	-----	-----	-----	-----	-----

#### ACK

The plasma monitor returns the following ACK when the power is switched on.

3FH	60H	80H	4EH	00H	CKS
-----	-----	-----	-----	-----	-----

NOTE: Do not set the Power ON or Power OFF command continuously.

### 02 POWER OFF

#### Function

The external control equipment switches off the power of the plasma monitor.

#### Transmission Data

9FH	80H	60H	4FH	00H	CKS
-----	-----	-----	-----	-----	-----

#### ACK

The plasma monitor returns the following ACK when the power is switched on.

3FH	60H	80H	4FH	00H	CKS
-----	-----	-----	-----	-----	-----

NOTE: Do not set the Power ON or Power OFF command continuously.

### 03 INPUT SWITCH CHANGE

#### Function

The external control equipment switches the input of the plasma monitor.

#### Transmission Data

DFH	80H	60H	47H	01H	DATA00	CKS
-----	-----	-----	-----	-----	--------	-----

DATA00: Input Select

01H: Video1

02H: Video2

03H: Video3

05H: HD (HD1 or DTV or DTV1)

06H: HD2 (DTV2)

07H: RGB1/PC1

08H: RGB2/PC2

0CH: RGB3/PC3

#### ACK

The plasma monitor returns the following ACK when the input is switched.

3FH	60H	80H	47H	00H	CKS
-----	-----	-----	-----	-----	-----

## 04 VOLUME GAIN DATA

### Function

The external control equipment changes the VOLUME gain data of the plasma monitor.

### Transmission Data

DFH	80H	60H	7FH	03H	DATA00	DATA01	DATA02	CKS
-----	-----	-----	-----	-----	--------	--------	--------	-----

DATA00: USER SOUND Gain Flag 05H  
 DATA01: VOLUME Gain Flag 01H  
 DATA02: VOLUME Gain 00H: Step 0  
 |  
 0AH: Step 10 (Default)  
 |  
 2AH: Step 42

### ACK

7FH	60H	80H	7FH	02H	DATA00	DATA01	CKS
-----	-----	-----	-----	-----	--------	--------	-----

DATA00: USER SOUND Gain Flag 05H  
 DATA01: VOLUME Gain Flag 01H

## 05 AUDIO MUTE ON

### Function

The external control equipment switches on AUDIO Mute of the plasma monitor.

### Transmission Data

9FH	80H	60H	3EH	00H	CKS
-----	-----	-----	-----	-----	-----

### ACK

3FH	60H	80H	3EH	00H	CKS
-----	-----	-----	-----	-----	-----

## 06 AUDIO MUTE OFF

### Function

The external control equipment switches off AUDIO Mute of the plasma monitor.

### Transmission Data

9FH	80H	60H	3FH	00H	CKS
-----	-----	-----	-----	-----	-----

### ACK

3FH	60H	80H	3FH	00H	CKS
-----	-----	-----	-----	-----	-----

## 07 CONTRAST GAIN DATA

### Function

The external control equipment changes the CONTRAST gain data of the plasma monitor.

### Transmission Data

DFH	80H	60H	7FH	03H	DATA00	DATA01	DATA02	CKS
-----	-----	-----	-----	-----	--------	--------	--------	-----

DATA00: USER PICTURE Gain Flag 051H  
 DATA01: CONTRAST Gain Flag 07H  
 DATA02: CONTRAST Gain CCH: -52  
 |  
 FFH: -01  
 00H: 0  
 01H: +01  
 |  
 14H: +20

### ACK

7FH	60H	80H	7FH	02H	DATA00	DATA01	CKS
-----	-----	-----	-----	-----	--------	--------	-----

DATA00: USER PICTURE Gain Flag 01H  
 DATA01: CONTRAST Gain Flag 07H

## 08 BRIGHT GAIN DATA

### Function

The external control equipment changes the BRIGHT gain data of the plasma monitor.

### Transmission Data

DFH	80H	60H	7FH	03H	DATA00	DATA01	DATA02	CKS
-----	-----	-----	-----	-----	--------	--------	--------	-----

DATA00: USER PICTURE Gain Flag

01H

DATA01: BRIGHT Gain Flag

08H

DATA02: BRIGHT Gain

E0H: -32

|

FFH: -01

00H: 0

01H: +01

|

20H: +32

### ACK

7FH	60H	80H	7FH	02H	DATA00	DATA01	CKS
-----	-----	-----	-----	-----	--------	--------	-----

DATA00: USER PICTURE Gain Flag

01H

DATA01: BRIGHT Gain Flag

08H

## 09 SHARPNESS GAIN DATA

### Function

The external control equipment changes the SHARPNESS gain data of the plasma monitor.

### Transmission Data

DFH	80H	60H	7FH	03H	DATA00	DATA01	DATA02	CKS
-----	-----	-----	-----	-----	--------	--------	--------	-----

DATA00: USER PICTURE Gain Flag

01H

DATA01: SHARPNESS Gain Flag

06H

DATA02: SHARPNESS Gain

F0H: -16

|

FFH: -01

00H: 0

01H: +01

|

10H: +16

Only when a RGB signal is connected

DATA02 SHARPNESS Gain

01H: 1

02H: 2

03H: 3

04H: 4

### ACK

7FH	60H	80H	7FH	02H	DATA00	DATA01	CKS
-----	-----	-----	-----	-----	--------	--------	-----

DATA00: USER PICTURE Gain Flag

01H

DATA01: SHARPNESS Gain Flag

06H

## 10 COLOR GAIN DATA

### Function

The external control equipment changes the COLOR gain data of the plasma monitor.

### Transmission Data

DFH	80H	60H	7FH	03H	DATA00	DATA01	DATA02	CKS
DATA00:	USER PICTURE Gain Flag					01H		
DATA01:	COLOR Gain Flag					04H		
DATA02:	COLOR Gain					E0H: -32		
*	COLOR Gain is from -22 (EAH) to							
	+22 (16H) only during video					FFH: -01		
						00H: 0		
						01H: +01		
						20H: +32		

### ACK

7FH	60H	80H	7FH	02H	DATA00	DATA01	CKS
DATA00:	USER PICTURE Gain Flag					01H	
DATA01:	COLOR Gain Flag					04H	

## 11 TINT GAIN DATA

### Function

The external control equipment changes the TINT gain data of the plasma monitor.

### Transmission Data

DFH	80H	60H	7FH	03H	DATA00	DATA01	DATA02	CKS
DATA00:	USER PICTURE Gain Flag					01H		
DATA01:	TINT Gain Flag					05H		
DATA02:	TINT Gain					E0H: -32		
						FFH: -01		
						00H: 0		
						01H: +01		
						20H: +32		

### ACK

7FH	60H	80H	7FH	02H	DATA00	DATA01	CKS
DATA00:	USER PICTURE Gain Flag					01H	
DATA01:	TINT Gain Flag					05H	

## 12 IMAGE MEM. SELECT

### Function

The external control equipment sets the picture mode of the plasma monitor.

### Transmission Data

DFH	80H	60H	0AH	01H	DATA00	CKS
-----	-----	-----	-----	-----	--------	-----

DATA00: 01H: MEMORY  
02H: LW BLK1  
03H: CONTRAST  
04H: FACTORY

### ACK

7FH	60H	80H	0AH	01H	DATA00	CKS
-----	-----	-----	-----	-----	--------	-----

DATA00: 01H: MEMORY  
02H: LW BLK1  
03H: NORMAL  
04H: FACTORY

## 13 WHITE BAL. SELECT

### Function

The external control equipment changes the WHITE BAL. of the plasma monitor.

### Transmission Data

DFH	80H	60H	00H	01H	DATA00	CKS
-----	-----	-----	-----	-----	--------	-----

DATA00: 00H: 5400K  
DATA01: 01H: 6500K  
DATA02: 03H: 9300K

### ACK

7FH	60H	80H	00H	01H	DATA00	CKS
-----	-----	-----	-----	-----	--------	-----

DATA00: 00H: 5400K  
01H: 6500K  
02H: 8500K  
03H: 9300K

NOTE: Set so that at the selection of 5400K, 6500K, 8500K of WHITE BAL. change of the following R/G/B GAIN data cannot be accepted.

## 14 RED GAIN DATA

### Function

The external control equipment changes the RED gain data of the plasma monitor.

### Transmission Data

DFH	80H	60H	7FH	04H	DATA00 to DATA03	CKS
DATA00:	USER PICTURE Gain Flag				01H	
DATA01:	RED Gain Flag				01H	
DATA02:	RED Gain 1 (Offset)				D8H: -40	
					FFH: -1	
					00H: 0	
					IEH: +30	
DATA03	RED Gain 2 (Drive)				D8H: -40	
					FFH: -1	
					00H: 0	
					IEH: +30	

### ACK

7FH	60H	80H	7FH	02H	DATA00	DATA01	CKS
DATA00:	USER PICTURE Gain Flag				01H		
DATA01:	RED Gain Flag				01H		

## 15 GREEN GAIN DATA

### Function

The external control equipment changes the GREEN gain data of the plasma monitor.

### Transmission Data

DFH	80H	60H	7FH	04H	DATA00 to DATA03	CKS
DATA00:	USER PICTURE Gain Flag				01H	
DATA01:	GREEN Gain Flag				02H	
DATA02:	GREEN Gain 1 (Offset)				D8H: -40	
					FFH: -1	
					00H: 0	
					IEH: +30	
DATA03	GREEN Gain 2 (Drive)				D8H: -40	
					FFH: -1	
					00H: 0	
					IEH: +30	

### ACK

7FH	60H	80H	7FH	02H	DATA00	DATA01	CKS
DATA00:	USER PICTURE Gain Flag				01H		
DATA01:	GREEN Gain Flag				02H		



## External Controls

### 16 BLUE GAIN DATA

#### Function

The external control equipment changes the BLUE gain data of the plasma monitor.

#### Transmission Data

DFH	80H	60H	7FH	04H	DATA00 to DATA03	CKS
-----	-----	-----	-----	-----	------------------	-----

DATA00:	USER PICTURE Gain Flag	01H
DATA01:	BLUE Gain Flag	03H
DATA02:	BLUE Gain 1 (Offset)	D8H: -40
		FFH: -1
		00H: 0
		IEH: +30
DATA03	BLUE Gain 2 (Drive)	D8H: -40
		FFH: -1
		00H: 0
		IEH: +30

#### ACK

7FH	60H	80H	7FH	02H	DATA00	DATA01	CKS
-----	-----	-----	-----	-----	--------	--------	-----

DATA00:	USER PICTURE Gain Flag	01H
DATA01:	BLUE Gain Flag	03H

### 17 VID NR MODE SET

#### Function

The external control equipment sets the VID NR (Noise Reduction) mode of the plasma monitor.

#### Transmission Data

DFH	80H	60H	C0H	01H	DATA00	CKS
-----	-----	-----	-----	-----	--------	-----

DATA00:	01H: VID NR OFF
	02H: VID NR-1
	03H: VID NR-2
	04H: VID NR-3

#### ACK

7FH	60H	80H	C0H	01H	DATA00	CKS
-----	-----	-----	-----	-----	--------	-----

DATA00:	01H: VID NR OFF
	02H: VID NR-1
	03H: VID NR-2
	04H: VID NR-3

## 18 BASS GAIN DATA

### Function

The external control equipment changes the BASS gain data of the plasma monitor.

### Transmission Data

DFH	80H	60H	7FH	03H	DATA00	DATA01	DATA02	CKS
DATA00:	USER PICTURE Gain Flag				05H			
DATA01:	BASS Gain Flag				03H			
DATA02:	BASS Gain				F3H: -13			
					FFH: -01			
					00H: 0			
					01H: +01			
					ODH: +13			

### ACK

7FH	60H	80H	7FH	02H	DATA00	DATA01	CKS
DATA00:	USER PICTURE Gain Flag				05H		
DATA01:	BASS Gain Flag				03H		

## 19 TREBLE GAIN DATA

### Function

The external control equipment changes the TREBLE gain data of the plasma monitor.

### Transmission Data

DFH	80H	60H	7FH	03H	DATA00	DATA01	DATA02	CKS
DATA00:	USER PICTURE Gain Flag				05H			
DATA01:	TREBLE Gain Flag				04H			
DATA02:	TREBLE Gain				F3H: -13			
					FFH: -01			
					00H: 0			
					01H: +01			
					ODH: +13			

### ACK

7FH	60H	80H	7FH	02H	DATA00	DATA01	CKS
DATA00:	USER PICTURE Gain Flag				05H		
DATA01:	TREBLE Gain Flag				04H		

## External Controls

### 20 BALANCE Gain Data

#### Function

The external control equipment changes the BALANCE gain data of the plasma monitor.

#### Transmission Data

DFH	80H	60H	7FH	03H	DATA00	DATA01	DATA02	CKS
-----	-----	-----	-----	-----	--------	--------	--------	-----

DATA00: USER PICTURE Gain Flag

05H

DATA01: BALANCE Gain Flag

02H

DATA02: BALANCE Gain

EAH: -22

|

FFH: -01

00H: 0

01H: +01

|

16H: +22

#### ACK

7FH	60H	80H	7FH	02H	DATA00	DATA01	CKS
-----	-----	-----	-----	-----	--------	--------	-----

DATA00: USER PICTURE Gain Flag

05H

DATA01: BALANCE Gain Flag

02H

### 21 ASPECT RATIO SELECT

#### Function

The external control equipment switches the screen mode of the plasma monitor.

#### Transmission Data

DFH	80H	60H	51H	01H	DATA00	CKS
-----	-----	-----	-----	-----	--------	-----

DATA00: 02H: I-WIDE

03H: LTR BOX

04H: STD 4:3

05H: ANAMPHC

#### ACK

7FH	60H	80H	51H	01H	DATA00	CKS
-----	-----	-----	-----	-----	--------	-----

DATA00: 02H: I-WIDE

03H: LTR BOX

04H: STD 4:3

05H: ANAMPHC

## 22 V SHIFT GAIN DATA

### Function

The external control equipment changes the V SHIFT gain data of the plasma monitor.

### Transmission Data

DFH	80H	60H	7FH	03H	DATA00	DATA01	DATA02	CKS
DATA00:	USER PICTURE Gain Flag				03H			
DATA01:	V SHIFT Gain Flag				01H			
DATA02:	V SHIFT Gain				COH: -64			
					FFH: -01			
					00H: 0			
					01H: +01			
					40H: +64			

### ACK

7FH	60H	80H	7FH	02H	DATA00	DATA01	CKS
DATA00:	USER PICTURE Gain Flag				03H		
DATA01:	V SHIFT Gain Flag				01H		

## 23 H SHIFT GAIN DATA

### Function

The external control equipment changes the H SHIFT gain data of the plasma monitor.

### Transmission Data

DFH	80H	60H	7FH	03H	DATA00	DATA01	DATA02	CKS
DATA00:	USER PICTURE Gain Flag				03H			
DATA01:	H SHIFT Gain Flag				02H			
DATA02:	H SHIFT Gain				80H: -128			
					FFH: -01			
					00H: 0			
					01H: +01			
					7FH: +127			

### ACK

7FH	60H	80H	7FH	02H	DATA00	DATA01	CKS
DATA00:	USER PICTURE Gain Flag				03H		
DATA01:	H SHIFT Gain Flag				02H		

## External Controls

### 24 V-SIZE GAIN DATA

#### Function

The external control equipment changes the V-SIZE gain data of the plasma monitor.

#### Transmission Data

DFH	80H	60H	7FH	03H	DATA00	DATA01	DATA02	CKS
-----	-----	-----	-----	-----	--------	--------	--------	-----

DATA00: USER PICTURE Gain Flag

03H

DATA01: V-SIZE Gain Flag

07H

DATA02: V-SIZE Gain

00H: 0

|

40H: +64

#### ACK

7FH	60H	80H	7FH	02H	DATA00	DATA01	CKS
-----	-----	-----	-----	-----	--------	--------	-----

DATA00: USER PICTURE Gain Flag

03H

DATA01: V-SIZE Gain Flag

07H

### 25 H-SIZE GAIN DATA

#### Function

The external control equipment changes the H-SIZE gain data of the plasma monitor.

#### Transmission Data

DFH	80H	60H	7FH	03H	DATA00	DATA01	DATA02	CKS
-----	-----	-----	-----	-----	--------	--------	--------	-----

DATA00: USER PICTURE Gain Flag

03H

DATA01: H-SIZE Gain Flag

08H

DATA02: H-SIZE Gain

00H: 0

|

40H: +64

#### ACK

7FH	60H	80H	7FH	02H	DATA00	DATA01	CKS
-----	-----	-----	-----	-----	--------	--------	-----

DATA00: USER PICTURE Gain Flag

03H

DATA01: H-SIZE Gain Flag

08H

## 26 PHASE GAIN DATA

### Function

The external control equipment changes the PHASE gain data (Phase) of the plasma monitor.

### Transmission Data

DFH	80H	60H	7FH	03H	DATA00	DATA01	DATA02	CKS
-----	-----	-----	-----	-----	--------	--------	--------	-----

DATA00:	USER PICTURE Gain Flag	03H
DATA01:	PHASE Gain Flag	03H
DATA02:	PHASE Gain	00H: 0   2CH: +44

### ACK

7FH	60H	80H	7FH	02H	DATA00	DATA01	CKS
-----	-----	-----	-----	-----	--------	--------	-----

DATA00:	USER PICTURE Gain Flag	03H
DATA01:	PHASE Gain Flag	03H

## 27 CLOCK GAIN DATA

### Function

The external control equipment changes the CLOCK gain data of the plasma monitor.

### Transmission Data

DFH	80H	60H	7FH	03H	DATA00	DATA01	DATA02	CKS
-----	-----	-----	-----	-----	--------	--------	--------	-----

DATA00:	USER PICTURE Gain Flag	03H
DATA01:	CLOCK Gain Flag	04H
DATA02:	CLOCK Gain	C0H: -64   FFH: -01 00H: 0 01H: +01   40H: +64

### ACK

7FH	60H	80H	7FH	02H	DATA00	DATA01	CKS
-----	-----	-----	-----	-----	--------	--------	-----

DATA00:	USER PICTURE Gain Flag	03H
DATA01:	CLOCK Gain Flag	04H

## 28 OSD SELECT

### Function

The external control equipment switches on or off the on-screen display (OSD) of the plasma monitor.

### Transmission Data

DFH	80H	60H	58H	01H	DATA00	CKS
-----	-----	-----	-----	-----	--------	-----

DATA00: 01H: On-Screen display On  
02H: On-Screen display Off

### ACK

7FH	60H	80H	58H	01H	DATA00	CKS
-----	-----	-----	-----	-----	--------	-----

DATA00: 01H: On-Screen display On  
02H: On-Screen display Off

On-Screen display On/Off is equivalent to the OSD menu item under the FUNCTION menu.

\*Operation is as described in the table below.

Operation	On-Screen Display (OSD)			
	Display of items and adjustments on the menu		Volume display, input display, and screen display	
	When screen display is ON	When screen display is OFF	When screen display is ON	When screen display is OFF
Remote control operation	Yes	Yes	Yes	No
Personal computer control operation	No	No	Yes	No

## 29 OSD ADJ. GAIN DATA

### Function

The external control equipment sets the position of the OSD menu of the plasma monitor.

### Transmission Data

DFH	80H	60H	1AH	02H	DATA00	DATA01	CKS
-----	-----	-----	-----	-----	--------	--------	-----

DATA00: OSD ADJ. Gain Flag  
DATA01: 01H: 1  
|  
06H: 6

### ACK

7FH	60H	80H	1AH	01H	DATA00	CKS
-----	-----	-----	-----	-----	--------	-----

DATA00: OSD ADJ. Gain Flag  
02H

### 30 AUTO OFF SELECT

#### Function

The external control equipment switches on or off the AUTO OFF of the plasma monitor.

#### Transmission Data

DFH	80H	60H	1AH	02H	DATA00	DATA01	CKS
DATA00:	AUTO OFF Select					03H	
DATA01:	01H: ON						
	02H: OFF						

#### ACK

7FH	60H	80H	1AH	02H	DATA00	DATA01	CKS
DATA00:	AUTO OFF Select					03H	
DATA01:	01H: ON						
	02H: OFF						

### 31 SIDEBAR LEV. SET

#### Function

The external control equipment sets the SIDEBAR LEV. of the plasma monitor.

#### Transmission Data

DFH	80H	60H	C6H	01H	DATA00	CKS
DATA00:	SIDEBAR LEV.					00H: 0
						0FH: 15

#### ACK

7FH	60H	80H	C6H	01H	DATA00	CKS
DATA00:	SIDEBAR LEV.					00H: 0
						0FH: 15

### 32 CINEMA MODE SET

#### Function

The external control equipment switches on or off the CINEMA MODE of the plasma monitor.

#### Transmission Data

DFH	80H	60H	C1H	01H	DATA00	CKS
DATA00:	CINEMA MODE Set					01H: ON
						02H: OFF

#### ACK

7FH	60H	80H	C1H	01H	DATA00	CKS
DATA00:	CINEMA MODE Set					01H: ON
						02H: OFF



### 33 RGB3 ADJ. SELECT

**Function**

The external control equipment sets the RGB3 ADJUST of the plasma monitor.

**Transmission Data**

DFH	80H	60H	1AH	02H	DATA00	DATA01	CKS
-----	-----	-----	-----	-----	--------	--------	-----

DATA00: RGB3 ADJ. Select 06H

DATA01: 01H: 1  
02H: 2  
03H: 3

**ACK**

7FH	60H	80H	1AH	02H	DATA00	DATA01	CKS
-----	-----	-----	-----	-----	--------	--------	-----

DATA00: RGB3 ADJ. Select 06H

DATA01: 01H: 1  
02H: 2  
03H: 3

.  
. .  
. .  
. .  
. .  
. .

### 34 PIXL PROTECT SET

**Function**

The external control equipment sets the LUM. SETTING, ORBITER, and INVERSE (inverse of image brightness) of the plasma monitor.

**Transmission Data**

DFH	80H	60H	6BH	03H	DATA00	DATA01	DATA02	CKS
-----	-----	-----	-----	-----	--------	--------	--------	-----

DATA00: LUM SETTING 01H: AUTO

02H: SET.

DATA01: INVERSE 01H: ON

02H: OFF

03H: WHITE

DATA02: ORBITER (PICTURE SHIFT) 01H: ON

02H: OFF

**ACK**

The plasma monitor returns the following ACK when setting the LUM. SETTING, ORBITER, and INVERSE (inverse of image brightness):

3FH	60H	80H	6BH	00H	CKS
-----	-----	-----	-----	-----	-----

### 35 INVERSE SET

**Function**

The external control equipment sets the INVERSE (inverse of image brightness) and the WHITE of the plasma monitor.

**Transmission Data**

DFH	80H	60H	C7H	03H	DATA00	DATA01	DATA02	CKS
DATA00:	INVERSE/WHITE					00H: No operation 01H: ON (INVERSE) 02H: OFF 03H: WHITE		
DATA01:	ACTIVE					00H: ON 01H: 03M (minutes) 02H: 06M (minutes)   FFH: 12H (hours) and 45M (minutes)		
DATA02:	STANDBY					01H: 03M (minutes) 02H: 06M (minutes)   FFH: 12H (hours) and 45M (minutes)		

**ACK**

3FH	60H	80H	C7H	00H	CKS
-----	-----	-----	-----	-----	-----

Note: The ACTIVE and the STANDBY can be set in units of 3 minutes.

Example: 03H=9 minutes

1EH=1 hour and 30 minutes

### 36 IMAGE SWEEP SET

**Function**

The external control equipment sets the IMAGE SWEEP of the plasma monitor.

**Transmission Data**

DFH	80H	60H	C8H	04H	DATA00 to DATA03	CKS
DATA00:	IMAGE SWEEP					00H: No operation 01H: ON 02H: OFF
DATA01:	ACTIVE					00H: ON 01H: 03M (minutes) 02H: 06M (minutes)   FFH: 12H (hours) and 45M (minutes)
DATA02:	STANDBY					01H: 03M (minutes) 02H: 06M (minutes)   FFH: 12H (hours) and 45M (minutes)
DATA03:	SPEED					01H: 1   05H: 5

**ACK**

3FH	60H	80H	C8H	00H	CKS
-----	-----	-----	-----	-----	-----

Note: The ACTIVE and the STANDBY can be set in units of 3 minutes.

Example: 03H=9 minutes

1EH=1 hour and 30 minutes



## 39 BNC SELECT

### Function

The external control equipment sets the BNC SELECT of the plasma monitor.

### Transmission Data

DFH	80H	60H	8CH	01H	DATA00	CKS
-----	-----	-----	-----	-----	--------	-----

DATA00: BNC SELECT

01H: RGB  
02H: Component  
03H: Video

### ACK

The plasma monitor returns the following ACK when setting the BNC SELECT:

7FH	60H	80H	8CH	01H	DATA00	CKS
-----	-----	-----	-----	-----	--------	-----

DATA00: BNC SELECT

01H: RGB  
02H: Component  
03H: Video

## 41 RGB SELECT

### Function

The external control equipment sets the RGB SELECT of the plasma monitor.

### Transmission Data

DFH	80H	60H	8BH	01H	DATA00	CKS
-----	-----	-----	-----	-----	--------	-----

DATA00: 01H: AUTO  
02H: STILL  
03H: MOTION  
04H: RESIZE1  
05H: RESIZE2  
06H: DTV

### ACK

7FH	60H	80H	8BH	01H	DATA00	CKS
-----	-----	-----	-----	-----	--------	-----

DATA00: 01H: AUTO  
02H: STILL  
03H: MOTION  
04H: RESIZE1  
05H: RESIZE2  
06H: DTV

## External Controls

### 41 HD SELECT

#### Function

The external control equipment sets the HD SELECT of the plasma monitor.

#### Transmission Data

DFH	80H	60H	8AH	01H	DATA00	CKS
-----	-----	-----	-----	-----	--------	-----

DATA00: 01H: 1035I  
02H: 1080A  
03H: 1080B

#### ACK

7FH	60H	80H	8AH	01H	DATA00	CKS
-----	-----	-----	-----	-----	--------	-----

DATA00: 01H: 1035I  
02H: 1080A  
03H: 1080B

### 42 LANGUAGE SELECT

#### Function

The external control equipment sets the LANGUAGE SELECT of the plasma monitor.

#### Transmission Data

DFH	80H	60H	5BH	01H	DATA00	CKS
-----	-----	-----	-----	-----	--------	-----

DATA00: 01H: ENGLISH  
02H: GERMAN  
03H: FRENCH  
04H: SPANISH  
05H: ITALIAN

#### ACK

7FH	60H	80H	5BH	01H	DATA00	CKS
-----	-----	-----	-----	-----	--------	-----

DATA00: 01H: ENGLISH  
02H: GERMAN  
03H: FRENCH  
04H: SPANISH  
05H: ITALIAN

## 43 VIDEO STANDARD SELECT

### Function

The external control equipment sets the VIDEO STANDARD of the plasma monitor.

### Transmission Data

DFH	80H	60H	5CH	01H	DATA00	CKS
-----	-----	-----	-----	-----	--------	-----

DATA00: 01H: 3.58NTSC  
 02H: 4.43NTSC  
 03H: PAL  
 04H: SECAM  
 05H: AUTO1  
 0BH: PAL60  
 0CH: AUTO2  
 0DH: PAL-M  
 0EH: PAL-N

### ACK

7FH	60H	80H	5CH	01H	DATA00	CKS
-----	-----	-----	-----	-----	--------	-----

DATA00: 01H: 3.58NTSC  
 02H: 4.43NTSC  
 03H: PAL  
 04H: SECAM  
 05H: AUTO1  
 0BH: PAL60  
 0CH: AUTO2  
 0DH: PAL-M  
 0EH: PAL-N

## 44 FREQUENCY REQUEST

### Function

The external control equipment inquires the Horizontal frequency, Vertical frequency, Horizontal sync polarity, Vertical sync polarity, Mode, and Resolution of the plasma monitor.

### Transmission Data

1FH	80H	60H	26H	00H	CKS
-----	-----	-----	-----	-----	-----

### ACK

7FH	60H	80H	26H	0BH	DATA00 to DATA10	CKS
-----	-----	-----	-----	-----	------------------	-----

#### Horizontal frequency

DATA00: Integer part  
 00H: 0 (No signal: 00H)  
 |  
 FFH: 256

DATA01: One decimal place  
 00H: 0 (No signal: 00H)  
 |  
 09H: 9

#### Vertical frequency

DATA02: Integer part  
 00H: 0 (No signal: 00H)  
 |  
 FFH: 256

DATA03: One decimal place  
 00H: 0 (No signal: 00H)  
 |  
 09H: 9

#### Horizontal sync polarity

DATA04: 00H: -  
 01H: Positive  
 02H: Negative

## External Controls

### ACK continued ...

7FH	60H	80H	26H	0BH	DATA00 to DATA10	CKS
-----	-----	-----	-----	-----	------------------	-----

#### Vertical sync polarity

DATA05: 00H: -  
 01H: Positive  
 02H: Negative

#### MODE

DATA06: 00H:	NO signal	--
01H to 80H	RGB signal	Identification number of PC mode
81H:	Video signal	3.58NTSC
82H:		4.43NTSC
83H:		PAL
84H:		PAL-M
85H:		PAL-N
86H:		PAL60
87H:		SECAM
88H:		B/W60
89H:		B/W50
A0H:	HD/DVD/DTV signal	480I
A1H:		480P
A2H:		576I
A3H:		576P
A4H:		720P
A5H:		1035I
A6H:		1080I

### ACK continued ...

7FH	60H	80H	26H	0BH	DATA00 to DATA10	CKS
-----	-----	-----	-----	-----	------------------	-----

#### RESOLUTION

DATA07: Dots (Low-order byte)	00H: 0 (No signal: 00H)   FFH: 256
DATA08: Dots (High-order byte)	00H: 257 (No signal: 00H)   FFH
DATA09: Lines (Low-order byte)	00H: 0 (No signal: 00H)   FFH: 256
DATA10: Lines (High-order byte)	00H: 257 (No signal: 00H)   FFH

## 45 INPUT MODE REQUEST

### Function

The display returns the current input information by the external control equipment's request.

### Transmission Data

1FH	80H	60H	41H	00H	CKS
-----	-----	-----	-----	-----	-----

### ACK

7FH	60H	80H	41H	01H	DATA00	CKS
-----	-----	-----	-----	-----	--------	-----

DATA00: Input Select	
01H: Video1	02H: Video2
03H: Video3	04H: HD (HD1 or DTV or DTV1)
05H: RGB1/PC1	06H: RGB2/PC2
0AH: COMP1	0CH: HD2 (DTV2)
0DH: COMP2	0EH: RGB3/PC3





## External Controls

### ACK continued ...

7FH	60H	80H	45H	0CH	DATA00 to DATA11	CKS
DATA07:	BRIGHT Gain				E0H: -32   FFH: -01 00H: 0 01H: +01   20H: +32	
DATA08:	RED Gain (Drive)				D8H: -40   FFH: -1 00H: 0   IEH: +30	
DATA09:	GREEN Gain (Drive)				D8H: -40   FFH: -1 00H: 0   IEH: +30	
DATA10:	BLUE Gain (Drive)				D8H: -40   FFH: -1 00H: 0   IEH: +30	
DATA11:	WHITE BAL.				00H: 5400K 01H: 6500K 02H: 8500K 03H: 9300K	

## 47 AUTO SELECT REQUEST

### Function

The external control equipment inquires the current combinations of audio and video inputs for the plasma monitor.

### Transmission Data

1FH	80H	60H	6FH	00H	CKS
-----	-----	-----	-----	-----	-----

### ACK

7FH	60H	80H	6FH	03H	DATA00	DATA01	DATA02	CKS
-----	-----	-----	-----	-----	--------	--------	--------	-----

DATA00:	AUDIO 1 01H - 0CH: VISUAL INPUT DATA
DATA01:	AUDIO 2 01H - 0CH: VISUAL INPUT DATA
DATA02:	AUDIO 3 01H - 0CH: VISUAL INPUT DATA
	VISUAL INPUT DATA
01H:	Video 1
02H:	Video 2
03H:	Video 3
05H:	HD (HD1 or DTV or DTV1)
06H:	HD2 (DTV2)
07H:	RGB 1 /PC1
08H:	RGB 2 /PC2
0CH:	RGB 3 /PC3

## 48 FAILURE MODE REQUEST

### Function

The external control equipment inquires the detection of failures of the plasma monitor.

### Transmission Data

1FH	80H	60H	3FH	00H	CKS
-----	-----	-----	-----	-----	-----

### ACK

The plasma monitor returns the following ACK:

7FH	60H	80H	3FH	02H	DATA00	DATA01	CKS
-----	-----	-----	-----	-----	--------	--------	-----

DATA00: FAILURE MODE 1  
 Bit 0: PDP MODULE  
     0: Abnormal  
     1: Normal  
 Bit 1: 1: fixed (backup)  
 Bit 2: TEMPERATURE  
     0: Abnormal  
     1: Normal  
 Bit 3: 1: fixed (backup)  
 Bit 4: TEMPERATURE SENSOR  
     0: Abnormal  
     1: Normal  
 Bit 5: 1: fixed (backup)  
 Bit 6: 1: fixed (backup)  
 Bit 7: 1: fixed (backup)  
 DATA01: FAILURE MODE 2  
         1: fixed (backup)

## 49 MODEL NAME REQUEST

### Function

The external control equipment inquires the product code of the plasma monitor.

### Transmission Data

1FH	80H	60H	17H	00H	CKS
-----	-----	-----	-----	-----	-----

### ACK

The plasma monitor returns the following ACK:

7FH	60H	80H	17H	0CH	DATA00 to DATA11	CKS
-----	-----	-----	-----	-----	------------------	-----

DATA00: 1st character of the product code  
 DATA01: 2nd character of the product code  
           |  
 DATA11: 12th character of the product code

#### NOTE:

Received Data (Hex)	Corresponding Character
00H	0
01H	1
08H	8
09H	9
10H	A
11H	B
12H	C
28H	Y
29H	Z
80H	- (Hyphen)
96H	(Blank)

If there are fewer than 12 characters in the product code, product code would be padded right with blanks.

# TABLE OF SIGNALS SUPPORTED

- When the screen mode is STD 4:3, each signal is converted to a 640 dots x 480 lines signal. (Except for \*2, \*4)
- When the screen mode is ANAMPHC, each signal is converted to a 853 dots x 480 lines signal. (Except for \*3)

## Computer input signals supported by this system

Model [ Signal Type ]	Dots x Lines	Vertical Freq. (Hz)	Horizontal Freq. (kHz)	Sync Polarity		Presence		Screen Mode		RGB Select *5	DVI	Memory
				Horizontal	Vertical	Horizontal	Vertical	Normal (4:3)	Full (16:9)			
*IBM PC/AT Compatible Computers	640 x 400	70.1	31.5	NEG	NEG	YES	YES	YES*2*3	YES	--	NO	4
	640 x 480	59.9	31.5	NEG	NEG	YES	YES	YES*3	YES	STILL	YES	5
		72.8	37.9	NEG	NEG	YES	YES	YES*3	YES	--	YES	7
		75.0	37.5	NEG	NEG	YES	YES	YES*3	YES	STILL	YES	8
		85.0	43.3	NEG	NEG	YES	YES	YES*3	YES	--	YES	9
		100.4	51.1	NEG	NEG	YES	YES	YES*3	YES	--	YES	41
		120.4	61.3	NEG	NEG	YES	YES	YES*3	YES	--	YES	42
	848 X 480	60.0	31.0	POS	POS	YES	YES	--	YES*3	WIDE2	YES	19
	852 X 480*1	60.0	31.7	NEG	NEG	YES	YES	--	YES*3	WIDE1	YES	17
	800 X 600	56.3	35.2	POS	POS	YES	YES	YES	YES	STILL	YES	11
		60.3	37.9	POS	POS	YES	YES	YES	YES	STILL	YES	12
		72.2	48.1	POS	POS	YES	YES	YES	YES	--	YES	13
		75.0	46.9	POS	POS	YES	YES	YES	YES	--	YES	14
		85.1	53.7	POS	POS	YES	YES	YES	YES	--	YES	15
		99.8	63.0	POS	POS	YES	YES	YES	YES	--	YES	43
	1024 X 768	120.0	75.7	POS	POS	YES	YES	YES	YES	--	YES	44
		60.0	48.4	NEG	NEG	YES	YES	YES	YES	STILL	YES	24
		70.1	56.5	NEG	NEG	YES	YES	YES	YES	--	YES	25
		75.0	60.0	POS	POS	YES	YES	YES	YES	STILL	YES	26
		85.0	68.7	POS	POS	YES	YES	YES	YES	--	YES	27
	100.6	80.5	NEG	NEG	YES	YES	YES	YES	--	NO	45	

Table of Signals Supported (continued)

Model [ Signal Type ]	Dots x Lines	Vertical Freq. (Hz)	Horizontal Freq. (kHz)	Sync Polarity		Presence		Screen Mode		RGB Select <sup>5</sup>	DVI	Mem- ory	
				Horizontal	Vertical	Horizontal	Vertical	Normal (4:3)	Full (16:9)				
	1152 X 864	75.0	67.5	POS	POS	YES	YES	YES	YES	STILL	YES	51	
	1280 X 768	56.2	45.1	POS	POS	YES	YES	--	YES	WIDE1	NO	52	
		59.8	48.0	POS	NEG	YES	YES	--	YES	WIDE3	YES	80	
	1360 X 765	60.0	47.7	POS	POS	YES	YES	--	YES	WIDE1	NO	22	
	1360 X 768	60.0	47.7	POS	POS	YES	YES	--	YES	WIDE1	YES	22	
	1376 X 768	59.9	48.3	NEG	POS	YES	YES	--	YES	WIDE2	YES	53	
	1280 X 1024	60.0	64.0	POS	POS	YES	YES	YES <sup>4</sup>	YES	STILL	YES	YES	29
		75.0	80.0	POS	POS	YES	YES	YES <sup>4</sup>	YES	--	NO	30	
		85.0	91.1	POS	POS	YES	YES	YES <sup>4</sup>	YES	--	NO	40	
		100.1	108.5	POS	POS	YES	YES	YES <sup>4</sup>	YES	--	NO	47	
	1600 X 1200	60.0	75.0	POS	POS	YES	YES	YES	YES	--	NO	54	
		65.0	81.3	POS	POS	YES	YES	YES	YES	--	NO	55	
		70.0	87.5	POS	POS	YES	YES	YES	YES	--	NO	56	
		75.0	93.8	POS	POS	YES	YES	YES	YES	--	NO	57	
85.0		106.3	POS	POS	YES	YES	YES	YES	--	NO	58		
*Apple Macintosh <sup>6</sup>	640 X 480	66.7	35.0	Sync on G	Sync on G	--	--	YES <sup>3</sup>	YES	--	NO	6	
	832 X 624	74.6	49.7	Sync on G	Sync on G	--	--	YES	YES	--	NO	16	
	1024 X 768	74.9	60.2	Sync on G	Sync on G	--	--	YES	YES	WIDE1	NO	28	
	1152 X 870	75.1	68.7	Sync on G	Sync on G	--	--	YES	YES	WIDE1	NO	39	
Work Station (EWS4800)	1280 X 1024	60.0	64.6	NEG	NEG	YES	YES	YES <sup>4</sup>	YES	--	YES	29	
		71.2	75.1	NEG	NEG	YES	YES	YES <sup>4</sup>	YES	--	NO	48	
Work Station (HP)	1280 X 1024	72.0	78.1	--	--	--	--	YES <sup>4</sup>	YES	--	NO	59	
Work Station (Sun)	1152 X 900	66.0	61.8	C Sync	C Sync	--	--	YES	YES	--	NO	60	
		76.0	71.7	C Sync	C Sync	--	--	YES	YES	--	NO	61	
	1280 X 1024	76.1	81.1	C Sync	C Sync	--	--	YES <sup>4</sup>	YES	--	NO	30	

Table of Signals Supported (continued)

Model [ Signal Type ]	Dots x Lines	Vertical Freq. (Hz)	Horizontal Freq. (kHz)	Sync Polarity		Presence		Screen Mode		RGB Select <sup>5</sup>	DVI	Mem- ory
				Horizontal	Vertical	Horizontal	Vertical	Normal (4:3)	Full (16:9)			
Work Station (Sun)	1024 X 768	60.0	49.7	--	--	--	--	YES	YES	--	YES	62
	1280 X 1024	60.0	63.9	--	--	--	--	YES <sup>4</sup>	YES	--	YES	29
IDC-3000G												
PAL625P	768 X 576	50.0	31.4	NEG	NEG	YES	YES	YES <sup>7</sup>	YES <sup>7</sup>	--	NO	31
NTSC525P	640 X 480	59.9	31.5	NEG	NEG	YES	YES	YES <sup>7</sup>	YES <sup>7</sup>	MOTION	NO	32

\*1 Only when using a graphic accelerator board that is capable of displaying 852 x 480.

\*2 Display only 400 lines with the screen center of the vertical orientation located at the center.

\*3 The picture is displayed in the original resolution. The picture will be compressed for other signals.

\*4 Aspect ratio is 5:4. This signal is converted to the following signal: 600 dots x 480 lines).

\*5 Normally the RGB select mode suite for the input signals is set automatically. If the picture is not displayed properly, set the RGB mode prepared for the input signals listed in the table above.

\*6 To connect the monitor to a Macintosh computer, use the monitor adapter (D-Sub 15-pin) to your computer's video port.

\*7 Other screen modes (LTR BOX and I-WIDE) are available as well.

**NOTE:**

- While the input signals comply with the resolution listed in the table above, you may have to adjust the position and size of the picture or the fine picture because of errors in synchronization of your computer.
- This monitor has a resolution of 853 dots x 480 lines. It is recommended that the input signal be VGA, wide VGA or equivalent.
- With digital input some signals are not accepted.
- The sync may be disturbed when a nonstandard signal other than the aforementioned is input.
- If you are connecting a composite sync signal, use the HD terminal.

\* "IBM PC/AT" and "VGA" are registered trademarks of International Business Machines, Inc. of the United States.

\* "Apple Macintosh" is a registered trademark of Apple Computer, Inc. of the United States.

# TROUBLESHOOTING

If the picture quality is poor or there is some other problems, check the adjustments, operations, etc., before requesting service.

SYMPTOM	CHECKS	REMEDY
Picture is disturbed. Sound is noisy. Remote control operates erroneously.	<ul style="list-style-type: none"> <li>• Is a connected component set directly in front or at the side of the display?</li> </ul>	<ul style="list-style-type: none"> <li>• Leave some space between the display and the connected components.</li> </ul>
The remote control does not work.	<ul style="list-style-type: none"> <li>• Are the remote control's batteries worn out?</li> <li>• Is IR ENABLE set to ON?</li> <li>• Has an ID number been set for the main unit?</li> </ul>	<ul style="list-style-type: none"> <li>• Replace both batteries with new ones.</li> <li>• Set IR ENABLE OFF on SETTING 3 menu.</li> <li>• Set an ID number with the SELECT ID button, or set the ID number to ALL.</li> </ul>
Monitor's power does not turn on when the remote control's power button is pressed.	<ul style="list-style-type: none"> <li>• Is the monitor's power cord plugged into a power outlet?</li> <li>• Are all the monitor's indicators off?</li> <li>• Are the remote control's batteries worn out?</li> <li>• Is IR ENABLE set to ON?</li> <li>• Has an ID number been set for the main unit.</li> </ul>	<ul style="list-style-type: none"> <li>• Plug the monitor's power cord into a power outlet.</li> <li>• Press the power button on the monitor to turn on the power.</li> <li>• Replace both batteries with new ones.</li> <li>• Set IR ENABLE OFF.</li> <li>• Set an ID number with the SELECT ID button, or set the ID number to ALL.</li> </ul>
Monitor does not operate when the remote control's buttons are pressed.	<ul style="list-style-type: none"> <li>• Is the remote control pointed at the monitor, or is there an obstacle between the remote control and the monitor?</li> <li>• Is direct sunlight or strong artificial light shining on the monitor's remote control sensor?</li> <li>• Are the remote control's batteries worn out?</li> </ul>	<ul style="list-style-type: none"> <li>• Point the remote control at the monitor's remote control sensor when pressing buttons, or remove the obstacle.</li> <li>• Eliminate the light by closing curtains, pointing the light in a different direction, etc.</li> <li>• Replace both batteries with new ones.</li> <li>• Unplug the remote cable from the monitor.</li> </ul>
The front panel buttons of the main unit do not function.	<ul style="list-style-type: none"> <li>• The front panel buttons do not function during Control Lock.</li> </ul>	<ul style="list-style-type: none"> <li>• Set the Control Lock to OFF.</li> </ul>
No sound or picture is produced.	<ul style="list-style-type: none"> <li>• Is the monitor's power cord plugged into a power outlet?</li> </ul>	<ul style="list-style-type: none"> <li>• Plug the monitor's power cord into a power outlet.</li> </ul>
Picture appears but no sound is produced.	<ul style="list-style-type: none"> <li>• Is the volume set at the minimum?</li> <li>• Is the mute mode set?</li> <li>• Are the speakers properly connected?</li> <li>• Is AUDIO set correctly?</li> </ul>	<ul style="list-style-type: none"> <li>• Increase the volume.</li> <li>• Press the remote control's MUTE button.</li> <li>• Connect the speakers properly.</li> <li>• Set AUDIO on the AUDIO menu correctly.</li> </ul>
Poor picture with VIDEO signal input.	<ul style="list-style-type: none"> <li>• Improper control setting. Local interference. Cable interconnections. Input impedance is not correct level.</li> </ul>	<ul style="list-style-type: none"> <li>• Adjust picture control as needed. Try another location for the monitor. Be sure all connections are secure.</li> </ul>

*Troubleshooting (continued)*

SYMPTOM	CHECKS	REMEDY
Poor picture with RGB signal input.	<ul style="list-style-type: none"> <li>• Improper control setting. Incorrect 15 PIN connector pin connections.</li> </ul>	<ul style="list-style-type: none"> <li>• Adjust picture controls as needed. Check pin assignments and connections.</li> </ul>
Tint is poor or colors are weak.	<ul style="list-style-type: none"> <li>• Are the tint and colors properly adjusted?</li> </ul>	<ul style="list-style-type: none"> <li>• Adjust the tint and color (under PICTURE).</li> </ul>
Nothing appears on screen.	<ul style="list-style-type: none"> <li>• Is the computer's power turned on?</li> </ul>	<ul style="list-style-type: none"> <li>• Turn on the computer's power.</li> </ul>
	<ul style="list-style-type: none"> <li>• Is a source connected?</li> </ul>	<ul style="list-style-type: none"> <li>• Connect source to the monitor.</li> </ul>
	<ul style="list-style-type: none"> <li>• Is the Auto Off function in the standby or off mode?</li> </ul>	<ul style="list-style-type: none"> <li>• Operate the computer (move the mouse, etc.)</li> </ul>
	<ul style="list-style-type: none"> <li>• Is LOOP OUT set to ON?</li> </ul>	<ul style="list-style-type: none"> <li>• Set LOOP OUT OFF.</li> </ul>
Part of picture is cut off or picture is not centered.	<ul style="list-style-type: none"> <li>• Is the position adjustment appropriate?</li> </ul>	<ul style="list-style-type: none"> <li>• Adjust the IMAGE OPTIONS properly.</li> </ul>
Image is too large or too small.	<ul style="list-style-type: none"> <li>• Is the screen size adjustment appropriate?</li> </ul>	<ul style="list-style-type: none"> <li>• Press the ASPECT button on the remote control and adjust properly.</li> </ul>
Picture is unstable.	<ul style="list-style-type: none"> <li>• Is the computer's resolution setting appropriate?</li> </ul>	<ul style="list-style-type: none"> <li>• Set to the proper resolution.</li> </ul>
POWER/STANDBY indicator is lighted in red.	<ul style="list-style-type: none"> <li>• Horizontal and / or vertical sync signal is not present when the Auto Off control is on.</li> </ul>	<ul style="list-style-type: none"> <li>• Check the input signal.</li> </ul>
POWER/STANDBY indicator is blinking in red.	<ul style="list-style-type: none"> <li>• The temperature inside the main unit has become too high and has activated the monitor.</li> </ul>	<ul style="list-style-type: none"> <li>• Promptly switch off the power of the main unit and wait until the internal temperature drops. See *1.</li> </ul>
POWER/STANDBY indicator is blinking in green and red, or green.	<p>-----</p>	<ul style="list-style-type: none"> <li>• Promptly switch off the power of the main unit. See *2.</li> </ul>

**\*1 Overheat Protector**

If the monitor becomes too hot, the overheat protector will be activated and the monitor will be turned off. If this happens, turn off the power to the monitor and unplug the power cord. If the room where the monitor is installed is particularly hot, move the monitor to a cooler location and wait for the monitor to cool for 60 minutes. If the problem persists, contact your Vidikron Authorized Dealer.

**\*2** In the following case, power off the monitor immediately and contact your Vidikron Authorized Dealer or Vidikron Authorized Service Center. The monitor turns off 5 seconds after powering on and then the POWER/STANDBY indicator blinks. It indicates that the power supply circuit, plasma display panel or temperature sensor have been damaged.

# SPECIFICATIONS

	<b>VP-42</b>	<b>VP-42HD</b>	<b>VP-50</b>	<b>VP-60</b>
<b>Native Resolution:</b>	853 x 480	1024 x 768	1365 x 768	1365 x 768
<b>Screen Aspect Ratio/ Screen Size (Diagonal):</b>	16:9 / 42 in.	16:9 / 42 in.	16:9 / 50 in.	16:9 / 60 in.
<b>Aspect Ratio:</b>	4:3, Letterbox, 16:9 Anamorphic, IntelliWide	4:3, Letterbox, 16:9 Anamorphic, IntelliWide	4:3, Letterbox, 16:9 Anamorphic, IntelliWide	4:3, Letterbox, 16:9 Anamorphic, IntelliWide
<b>Image Area W x H:</b>	36 1/3 in. (920 mm) W 20 3/8 in. (518 mm) H	36 1/3 in. (920 mm) W 20 3/8 in. (518 mm) H	43 1/3 in. (1106 mm) W 24 1/2 in. (622.30 mm) H	53 1/8 in. (1351 mm) W 29 7/8 in. (760 mm) H
<b>DTV Compatibility:</b>	480p, 720p, 1080i	480p, 720p, 1080i	480p, 720p, 1080i	480p, 720p, 1080i
<b>Power Requirements:</b>	120V AC, 50/60 Hz, 350W	120V AC, 50/60 Hz, 360W	120V AC, 50/60 Hz, 480W	120V AC, 50/60 Hz, 540W
<b>Inputs:</b>	(2) Composite Video (1-BNC, 1-RCA), (2) Component Video (1-BNC, 1-RCA), (1) S-Video, (1) RGB (15-pin mini D-Sub), (1) RGB via BNC, (1) DVI w/ HDCP, (1) RS-232, (3) Stereo RCA jacks	(2) Composite Video (1-BNC, 1-RCA), (2) Component Video (1-BNC, 1-RCA), (1) S-Video, (1) RGB (15-pin mini D-Sub), (1) RGB via BNC, (1) DVI w/ HDCP, (1) RS-232, (3) Stereo RCA jacks	(2) Composite Video (1-BNC, 1-RCA), (2) Component Video (1-BNC, 1-RCA), (1) S-Video, (1) RGB (15-pin mini D-Sub), (1) RGB via BNC, (1) DVI w/ HDCP, (1) RS-232, (3) Stereo RCA jacks	(2) Composite Video (1-BNC, 1-RCA), (2) Component Video (1-BNC, 1-RCA), (1) S-Video, (1) RGB (15-pin mini D-Sub), (1) RGB via BNC, (1) DVI w/ HDCP, (1) RS-232, (3) Stereo RCA jacks
<b>Operating Environment:</b>	32°-95°F, (0°-35°C), 20-80% humidity (non-condensing)	32°-95°F, (0°-35°C), 20-80% humidity (non-condensing)	32°-95°F, (0°-35°C), 20-80% humidity (non-condensing)	32°-95°F, (0°-35°C), 20-80% humidity (non-condensing)
<b>Dimensions:</b>	Width: 40 1/3 in. (1023 mm) Depth: 4 9/10 in. (124.43 mm) Height: 24 1/4 in. (615.18 mm) Weight: 72.8 lbs. (33 kg)	Width: 40 1/3 in. (1023 mm) Depth: 4 9/10 in. (124.43 mm) Height: 24 1/4 in. (615.18 mm) Weight: 72.8 lbs. (33 kg)	Width: 48 7/16 in. (1230 mm) Depth: 3 15/16 in. (100 mm) Height: 29 1/4 in. (744 mm) Weight: 98 lbs. (45 kg)	Width: 58 1/8 in. (1476 mm) Depth: 4 7/8 in. (123.3 mm) Height: 34 15/16 in. (886.4 mm) Weight: 147 lbs. (66.8 kg)



*Specifications (continued)*

	<b>VP-42</b>	<b>VP-42HD</b>	<b>VP-50</b>	<b>VP-60</b>
<b>Regulatory Approvals:</b>	FCC, CE, C-Tick	FCC, CE, C-Tick	FCC, CE, C-Tick	FCC, CE, C-Tick
<b>Limited Warranty:</b>	(1) One year parts and labor from the date of delivery to the end user.	(1) One year parts and labor from the date of delivery to the end user.	(1) One year parts and labor from the date of delivery to the end user.	(1) One year parts and labor from the date of delivery to the end user.

All specifications subject to change without notice. Optional wall mount or table stand available.  
© 2004 Vidikron, a Runco International Company. All rights reserved.  
PlasmaView, Intelliwide and Dynamic Pixel Protection are trademarks of Vidikron.

# DIMENSIONS

## VP-42 / VP-42HD

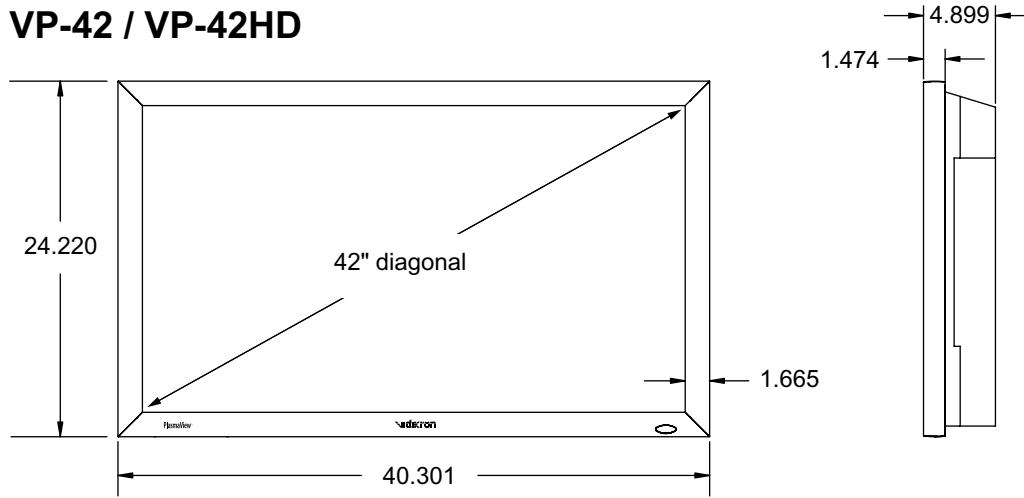

*Dimensions*

**VP-50**

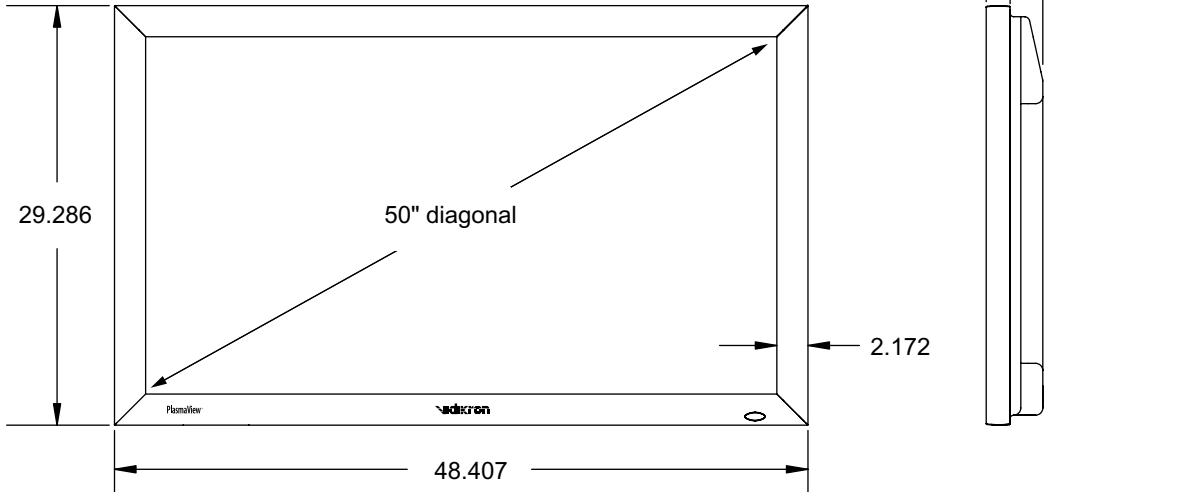

**VP-60**

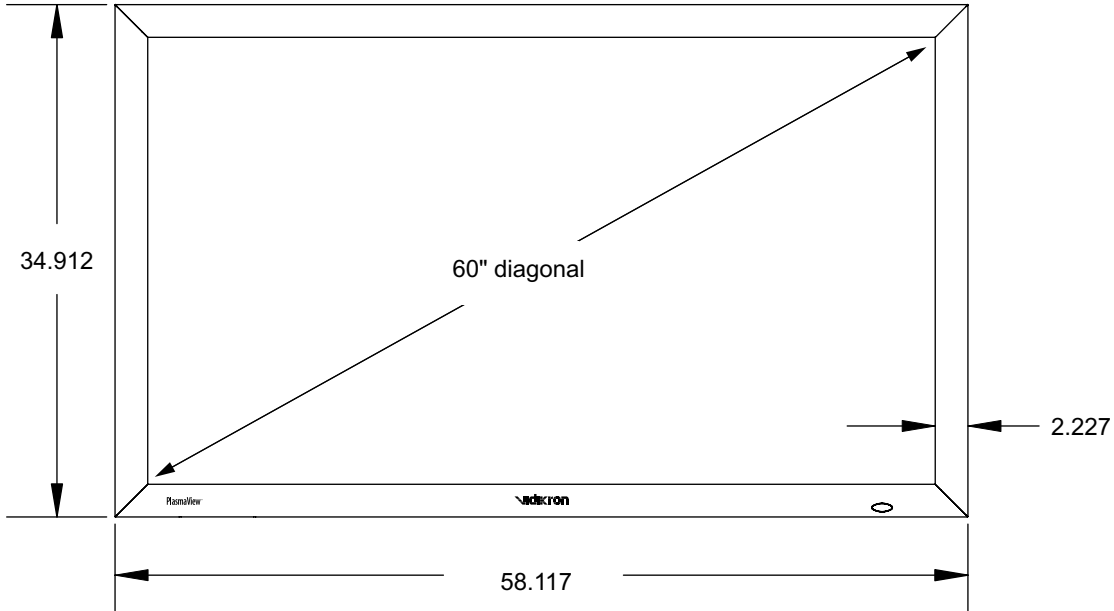

*Dimensions*

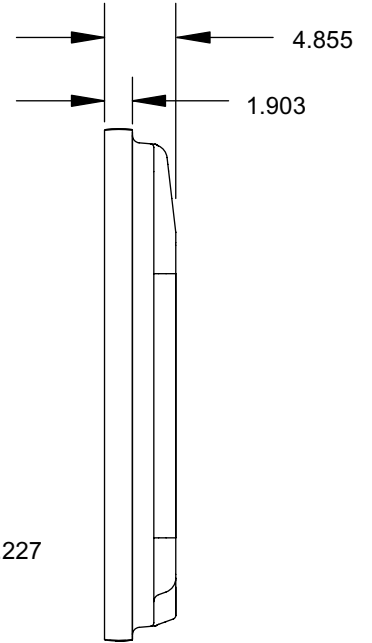



RUMA-010550  
4-04 v2.0

VIDIKRON  
2900 Faber Street  
Union City, CA 94587  
Ph (510) 324-5900 / Fax (510) 324-5905  
1-888-4-VIDIKRON