

HITACHI
Inspire the Next

39|32

ULTRATHIN

LED

LCD HDTV

Models:

LE39S406/LE39H316

39" Class (38.57" Diagonal)

LE32S406/LE32H316

32" Class (31.51" Diagonal)



Owner's Guide

Simulated image.
Image may differ from actual product.

Thank you for purchasing this Hitachi product.
Please read these instructions carefully.

For additional assistance please Call Toll Free
1-800-289-0981 (USA/CANADA), 01-800-703-0885 (MEXICO)
or visit our website at www.hitachi.us/tv.
Keep this owner's guide for future reference.

Record the model name and serial number of your LCD
Television for future reference. This information is located
on the back of the television.

TABLE OF CONTENTS

2-6	IMPORTANT SAFETY INSTRUCTIONS
7	HOW TO ATTACH/REMOVE THE STAND
8-12	FIRST TIME USE
13-21	TV OPERATION
22-24	CONNECTIONS TO OTHER EQUIPMENT
25	RECEPTION DISTURBANCES
26	TROUBLESHOOTING
27	SPECIFICATIONS
28	LIMITED WARRANTY

MODEL NAME. _____ SERIAL NO. _____



	CAUTION RISK OF ELECTRIC SHOCK DO NOT OPEN	
CAUTION: TO REDUCE THE RISK OF ELECTRIC SHOCK, DO NOT REMOVE COVER (OR BACK). NO USER-SERVICEABLE PARTS INSIDE. REFER SERVICING TO QUALIFIED SERVICE PERSONNEL.		



The lightning flash with arrowhead symbol, within an equilateral triangle is intended to alert the user to the presence of uninsulated dangerous voltage within the product's enclosure that may be of sufficient magnitude to constitute a risk of electric shock.



The exclamation point within an equilateral triangle is intended to alert the user to the presence of important operating and maintenance (servicing) instructions in the literature accompanying the appliance.

WARNING: TO PREVENT FIRE OR SHOCK HAZARD, DO NOT EXPOSE THIS APPLIANCE TO RAIN OR MOISTURE. TO PREVENT THE SPREAD OF FIRE, KEEP CANDLES OR OPEN FLAMES AWAY FROM THIS PRODUCT AT ALL TIMES.
CAUTION: TO PREVENT ELECTRIC SHOCK, DO NOT USE THIS POLARIZED PLUG WITH AN EXTENSION CORD, RECEPTACLE OR OTHER OUTLET UNLESS THE BLADES CAN BE FULLY INSERTED TO PREVENT BLADE EXPOSURE.

WARNING: This equipment has been tested and found to comply with the limits for a Class B digital device, pursuant to Part 15 of the FCC Rules. These limits are designed to provide reasonable protection against harmful interference in a residential installation. This equipment generates, uses and can radiate radio frequency energy and, if not installed and used in accordance with the instructions, may cause harmful interference to radio communications. However, there is no guarantee that interference will not occur in a particular installation. If this equipment does cause harmful interference to radio or television reception, which can be determined by turning the equipment off and on, the user is encouraged to try to correct the interference by one or more of the following measures:

- Reorient or relocate the receiving antenna.
- Increase the separation between the equipment and receiver.
- Connect the equipment into an outlet on a circuit different from that to which the receiver is connected.
- Consult the dealer or an experienced radio/TV technician for help.

CAUTION: Changes or modifications not expressly approved by the party responsible for compliance with the FCC Rules could void the user's authority to operate this equipment.

Location of the required Marking

The rating sheet and the safety caution are on the rear of the unit.

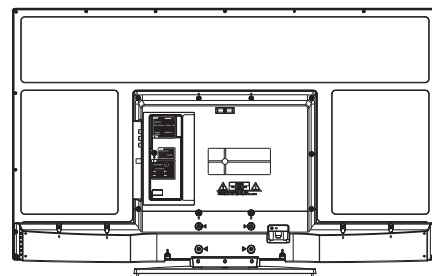

ENERGY STAR®

This television's factory default settings as shipped meet ENERGY STAR requirements.

Please see the Convenience Functions section of this operating guide for more information on factory settings and the energy saving Auto Shut Off feature.

LEAD NOTICE

This product contains lead. Dispose of this product in accordance with applicable environmental laws. For product recycling and disposal information, contact your local government agency or www.eRecycle.org (in California), the Electronic Industries Alliance at www.ecyclingcentral.com (in the U.S.) or the Electronic Product Stewardship Canada at www.epsc.ca (in Canada). **FOR MORE INFORMATION, 1-800-289-0981 (USA/CANADA), 01-800-703-0885 (MEXICO).**

IMPORTANT SAFETY INSTRUCTIONS

- 1) Read these instructions.
- 2) Keep these instructions.
- 3) Heed all warnings.
- 4) Follow all instructions.
- 5) Do not use this apparatus near water.
- 6) Clean only with dry cloth.
- 7) Do not block any ventilation openings. Install in accordance with the manufacturer's instructions.
- 8) Do not install near any heat sources such as radiators, heat registers, stoves, or other apparatus (including amplifiers) that produce heat.
- 9) Do not defeat the safety purpose of the polarized or grounding-type plug. A polarized plug has two blades with one wider than the other. A grounding type plug has two blades and a third grounding prong. The wide blade or the third prong are provided for your safety. If the provided plug does not fit into your outlet, consult an electrician for replacement of the obsolete outlet.
- 10) Protect the power cord from being walked on or pinched particularly at plugs, convenience receptacles, and the point where they exit from the apparatus.
- 11) Only use attachments/accessories specified by the manufacturer.
- 12) Use only with cart, stand, tripod, bracket, or table specified by the manufacturer, or sold with the apparatus. When a cart is used, use caution when moving the cart/apparatus combination to avoid injury from tip-over.
- 13) Unplug this apparatus during lightning storms or when unused for long periods of time.
- 14) Refer all servicing to qualified service personnel. Servicing is required when the apparatus has been damaged in any way, such as power-supply cord or plug is damaged, liquid has been spilled or objects have fallen into the apparatus, the apparatus has been exposed to rain or moisture, does not operate normally, or has been dropped.
- 15) Apparatus should not be exposed to dripping or splashing, and objects filled with liquids, such as vases, should not be placed on the apparatus.
- 16) An outside antenna system should not be located in the vicinity of overhead power lines or other electric light or power circuits, or where it can fall into such power lines or circuits. When installing an outside antenna system, extreme care should be taken to keep from touching such power lines or circuits, as contact with them might be fatal.
- 17) Do not overload wall outlets and extension cords, as this can result in a risk of fire or electric shock.
- 18) Do not push objects through any openings in this unit, as they may touch dangerous voltage points or short out parts that could result in fire or electric shock. Never spill or spray any type of liquid into the unit.
- 19) If an outside antenna or cable system is connected to the unit, be sure the antenna or cable system is grounded to provide some protection against voltage surges and built-up static charges, Section 810 of the National Electrical Code, ANSI/NFPA 70, provides information with respect to proper grounding of the mast and supporting structure, grounding of the lead-in wire to an antenna discharge unit, size of grounding conductors, location of antenna discharge unit, connection to grounding electrodes, and requirements for the grounding electrode.
- 20) When replacement parts are required, be sure the service technician uses replacement parts specified by the manufacturer or those that have the same characteristics as the original part.

Unauthorized substitutions may result in fire, electric shock or other hazards.
- 21) Upon completion of any service or repairs to this unit, ask the service technician to perform safety checks to determine that the unit is in proper operating condition.
- 22) When you connect the product to other equipment, turn off the power and unplug all of the equipment from the wall outlet. Failure to do so may cause an electric shock and serious personal injury. Read the owner's manual of the other equipment carefully and follow the instructions when making any connections.
- 23) Sudden high volume sound may cause hearing or speaker damage. When you use headphones, (if the unit is equipped with a headphone jack) keep the volume at a moderate level. If you use headphones continuously with high volume sound, it may cause hearing damage.



IMPORTANT SAFETY INSTRUCTIONS (continued)

- 24) Do not allow the product to output distorted sound for an extended period of time. It may cause speaker overheating and fire.
- 25) This reminder is provided to call the cable TV system installer's attention to Article 820-40 of the NEC that provides guidelines for proper grounding and, in particular, specifies that the cable ground shall be connected to the grounding system of the building, as close to the point of cable entry as practical.
- 26) The socket-outlet must be installed near the unit and easily accessible.
- 27) The mains plug is used as the disconnect and shall remain readily operable.

CONDENSATION

Moisture will form in the operating section of the unit if the unit is brought from cool surroundings into a warm room or if the temperature of the room rises suddenly. When this happens, unit's performance will be impaired. To prevent this, let the unit stand in its new surroundings for about an hour before switching it on, or make sure that the room temperature rises gradually. Condensation may also form during the summer if the unit is exposed to the breeze from an air conditioner. In such cases, change the location of the unit.

HOW TO HANDLE THE LCD PANEL

- Do not press hard or jolt the LCD panel. It may cause the LCD panel glass to break and injury may occur.
- If the LCD panel is broken, make absolutely sure that you do not touch the liquid in the panel. This may cause skin inflammation. If the liquid gets in your mouth, immediately gargle and consult with your doctor. Also, if the liquid gets in your eyes or touches your skin, consult with your doctor after rinsing for at least 15 minutes or longer in clean water.

Possible Adverse Effects on LCD Panel: If a fixed (non-moving) pattern remains on the LCD Panel for long periods of time, the image can become permanently engrained in the LCD Panel and cause subtle but permanent ghost images. This type of damage is NOT COVERED BY YOUR WARRANTY. Never leave your LCD Panel on for long periods of time while it is displaying the following formats or images:

- Fixed Images, such as stock tickers, video game patterns, TV station logos, and websites.
- Special Formats that do not use the entire screen. For example, viewing letterbox style (16:9) media on a normal (4:3) display (black bars at top and bottom of screen); or viewing normal style (4:3) media on a widescreen (16:9) display (black bars on left and right sides of screen).

The following symptoms are not signs of malfunction but technical limitation. Therefore we disclaim any responsibility for these symptoms.

- LCD Panels are manufactured using an extremely high level of precision technology, however sometimes parts of the screen may be missing picture elements or have luminous spots. This is not a sign of a malfunction.
- Do not install the LCD Panel near electronic equipment that produces electromagnetic waves. Some equipment placed too near this unit may cause interference.
- Effect on infrared devices – There may be interference while using infrared devices such as infrared cordless headphones.

Power source

This television is designed to operate on 120 volts 60 Hz, AC current. Insert the power cord into a 120 volts 60 Hz outlet. To prevent electric shock, do not use the television's (polarized) plug with an extension cord, receptacle, or other outlet unless the blades can be fully inserted to prevent blade exposure. Never connect the television to 50 Hz, direct current, or anything other than the specified voltage.

Warning

To reduce the risk of fire or electric shock, do not expose this apparatus to rain or moisture.

Caution

Never remove the back cover of the television as this can expose you to very high voltages and other hazards. If the television does not operate properly, unplug the television and call your authorized dealer or service center. Adjust only those controls that are covered in the instructions, as improper changes or modifications not expressly approved by Hitachi could void the user's warranty.

"Standard Television Receiving Apparatus - Appareil de réception télévision ordinaire, Canada BETS-7 / NTMR-7"

Declaration of Conformity

This device complies with part 15 of the FCC Rules. Operation is subject to the following two conditions:
(1) This device may not cause harmful interference and (2) This device must accept any interference received, including interference that may cause undesired operation.
For questions regarding this declaration, contact:

Hitachi America, Ltd.
900 Hitachi Way
Chula Vista, CA 91914-3556
ATTN: Customer Relations

CHILD SAFETY NOTICE

CHILD SAFETY:

It Makes A Difference How and Where
You Use Your Flat Panel Display

Congratulations on your purchase!

As you enjoy your new product, please keep these safety tips on mind:



HITACHI CARES!

- The consumer electronics industry is committed to making home entertainment enjoyable and safe.
- Please note the American Academy of Pediatrics discourages television viewing for children younger than two years of age.
- The home theater entertainment experience is a growing trend and larger flat displays are popular purchases. However, flat panel displays are not always supported on the proper stands or installed according to the manufacturer's recommendations.
- Flat Panel displays that are inappropriately situated on dresser, bookcases, shelves, desks, speakers, chest or carts may fall over and cause injury.

TUNE INTO SAFETY

- One size does NOT fit all. Follow the manufacturer's recommendations for the safe installation and use of your flat panel display.
- Carefully read and understand all enclosed instructions for proper use of this product.
- Don't allow children to climb on or play with furniture and television sets.
- Don't place flat panel displays on furniture that can easily be used as steps, such as a chest of drawers.
- Remember that children can become excited while watching a program, especially on a "larger than life" flat panel display. Care should be taken to place or install the display where it cannot be pushed, pulled over, or knocked down.
- Care should be taken to route all cords and cables connected to the flat panel display so that they cannot be pulled or grabbed by curious children.

WALL MOUNTING: IF YOU DECIDE TO WALL MOUNT YOUR FLAT PANEL DISPLAY, ALWAYS:

- Use a mount that has been recommended by the display manufacturer and/or listed by an independent laboratory (such as UL, CSA, ETL).
- Follow all instructions supplied by the display and wall mount manufacturers.
- If you have any doubts about your ability to safely install your flat panel display, contact your retailer about professional installation.
- Make sure that the wall where you are mounting the display is appropriate.
- Some wall mounts are not designed to be mounted to walls with steel studs or old cinder block construction.
- If you are unsure, contact a professional installer.
- A minimum of two people are required for installation. Flat panel displays can be heavy.



 **CEA**
Consumer Electronics Association
www.CE.org/safety

SAFETY PRECAUTIONS

The unit emits heat when in operation. Do not place any covers or blankets on the unit, this may cause overheating. Do not block ventilation holes, or set up near radiators. Do not place in direct sunlight. When placing on a shelf leave 4 inches (10 cm) free space around the entire unit.

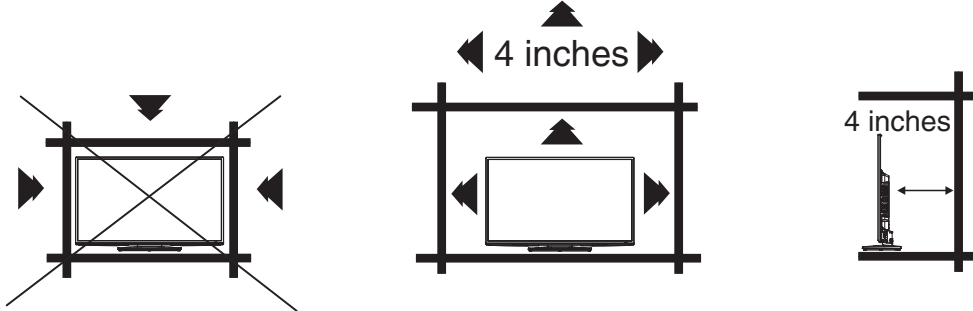

Notes when mounting the TV on a wall

If the unit is to be mounted on the wall, contact the retailer where you purchased the TV for advice, and have the equipment professionally installed. Incomplete or improper installation may cause injury to you, and/or damage to the TV.

The screws ISO M4 (LE32S406/LE32H316)/M6 (LE39S406/LE39H316) thread type should be used. The insertion length must be within 10-12 mm (LE32S406/LE32H316)/13-16 mm (LE39S406/LE39H316).

If the insertion length is less than 10 mm (LE32S406/LE32H316)/13 mm (LE39S406/LE39H316) the weight can not be maintained.

If the insertion length is more than 12 mm (LE32S406/LE32H316)/16 mm (LE39S406/LE39H316) a space is created between the Wall Mount Bracket and the Television.

(Insertion Length) = (Screw Length) - (Washers Thickness) - (Mounting Bracket Thickness)

Securing to a Wall

1. Using metallic wire fasten the set to the hole on the rear of the TV as shown below.
2. Keep the TV 4 inches away from the wall except when mounted using the wall mount bracket and secure to the wall as shown below:

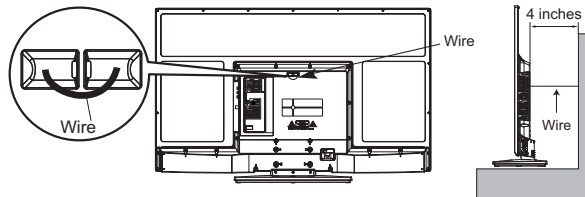

NOTICE FOR TV CABINET

If the unit is to be mounted on a cabinet smaller than length of the unit, it could result in an unstable location and the unit may tumble over, making a risk of personal, possibly fatal injury. Also, this would damage the product seriously. Accordingly, Hitachi accepts no responsibility or liability for any injuries or property damage resulting from the improper installation.

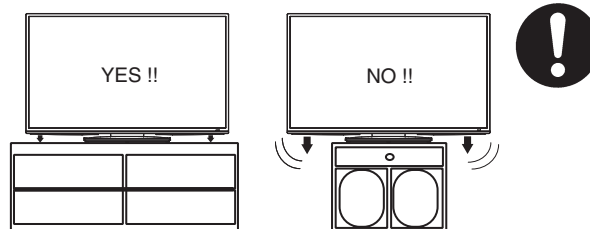

How to attach the stand

NOTE:

- Unplug the AC cord.
- Before beginning this process, assure that TV is laid on a clean, safe, and cushioned space to avoid any damage to the unit.
- Do not touch or press the LCD screen, the glass might break under pressure.

Place the TV on its front onto a table.

Align the stand's bottom-plate (supplied) as seen here.

It will fit in only one direction.

Hold the unit and attach as shown in Figure 1.

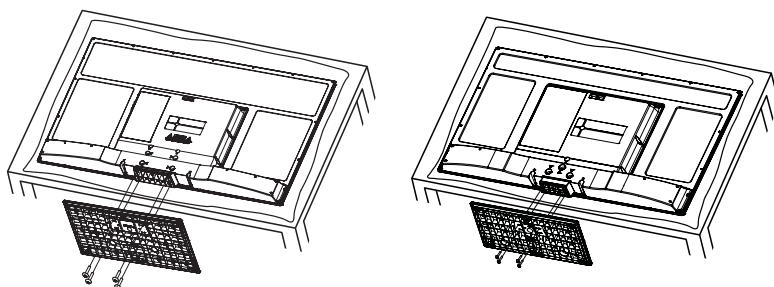
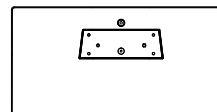

Figure 1

LE39S406/LE39H316

LE32S406/LE32H316

LE39S406/LE39H316



LCD PANEL FRONT

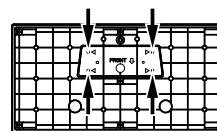

Figure 2

Finally, secure the bottom-plate with 4 screws (supplied) (4x16mm (5/32x5/8 inches)) as indicated by the arrows in Figure 2.

- Be sure to follow the instructions. Insufficient tightening or incorrect installation of the stand will not support your unit correctly, and could result in damage or injury from tip-over.

How to remove the stand

When you transport this product, remove the stand and pack flat against the back of the unit in the carton. To remove the stand, perform the above steps in reverse order.

For wall mounting, the base must be removed. To disconnect the base/stand remove the LE39S406/LE39H316 (x4 screws) and LE32S406/LE32H316 (x3 screws) screws from the back.

NOTE:

- Before wall-mounting, please check carefully the location of the TV's mounting-holes.

LE39S406/LE39H316

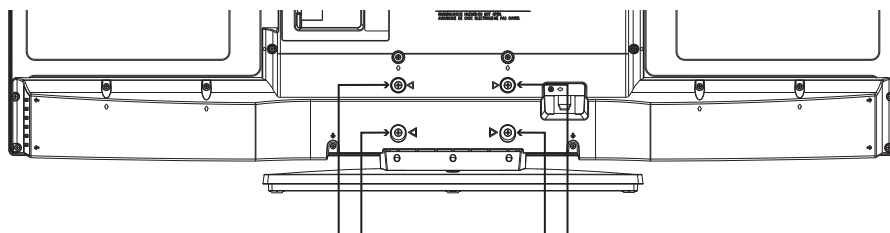

Screws

LE32S406/LE32H316

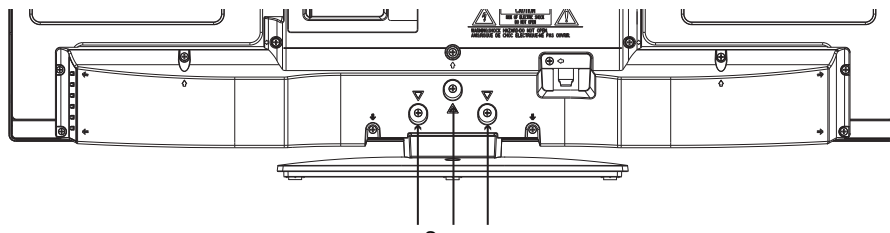



Screws

Features

LED color TV

Unique space saving design combines a 39"/32" class LED color TV.

- **Integrated Digital Tuner** - You can view digital broadcasts without using a Digital TV Set-Top Box.
- **Closed Caption Decoder With Full Text Mode** - Displays text captions or full screen text on the screen for hearing impaired viewers.
- **Picture Adjustments Using The Remote Control** - The On-Screen display allows precise remote control adjustment of BRIGHTNESS, CONTRAST, COLOR, TINT and SHARPNESS.
- **Programmable TV Sleep Timer** - Operable from the remote control, the TV can be programmed for up to 120 minutes to turn off automatically.
- **On-Screen 3 Languages Display** - You can select one of 3 Languages, English, Spanish or French for on-screen programming.
- **Parental Control** - The Parental Control function can read the rating of a TV program or movie content if the program is encoded with this information. Parental Control will allow you to set a restriction level.

This Television receiver will display television closed captioning, ( or ), in accordance with FCC rules.

* The terms HDMI and HDMI High-Definition Multimedia Interface, and the HDMI Logo are trademarks or registered trademarks of HDMI Licensing LLC in the United States and other countries.

* Manufactured under license from Dolby Laboratories. Dolby and the double-D symbol are trademarks of Dolby Laboratories.

* VGA and XGA are trademarks of International Business Machines Corporation.

* VESA is a registered trademark of the Video Electronics Standard Association.

Power source

TO USE AC POWER SOURCE

Use the AC polarized line cord provided for operation on AC. Insert the AC cord plug into a standard 120V 60Hz polarized AC outlet.

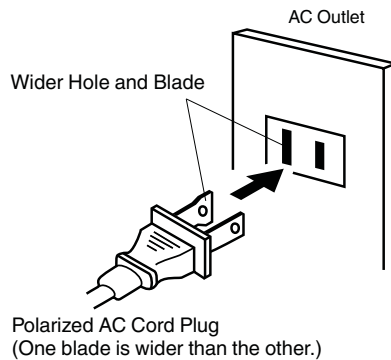

NOTE:

- Never connect the AC line cord plug to other than the specified voltage (120V 60Hz).
Use the attached power cord only.
- If the polarized AC cord does not fit into a non-polarized AC outlet, do not attempt to file or cut the blade.
It is the user's responsibility to have an electrician replace the obsolete outlet.
- If you cause a static discharge when touching the unit and the unit fails to function, simply unplug the unit from the AC outlet and plug it back in. The unit should return to normal operation.

Contents

Before using your unit

IMPORTANT SAFETY INSTRUCTIONS.....	3
CHILD SAFETY NOTICE.....	5
SAFETY PRECAUTIONS.....	6
How to attach the stand.....	7
How to remove the stand.....	7
Features.....	8
Power source.....	8
Contents.....	9
Location of controls.....	10
Remote control.....	11
Antenna connections.....	12
Cable TV connections.....	12

TV operation

Starting setup.....	13
TV operation.....	13
Quick guide for menu operation.....	14
Convenience functions.....	15
Memorizing channels.....	16
Checking the digital signal strength.....	17
Labeling channels.....	17
Labeling video inputs.....	17
Setting the Parental Control.....	17
Closed Caption.....	19
CC advanced.....	20
Aspect Switching.....	20
Time Shift.....	21

Additional information

Connections to other equipment.....	22
Reception disturbances.....	25
Troubleshooting.....	26
Specifications.....	27
LIMITED WARRANTY.....	28

Location of controls

Front

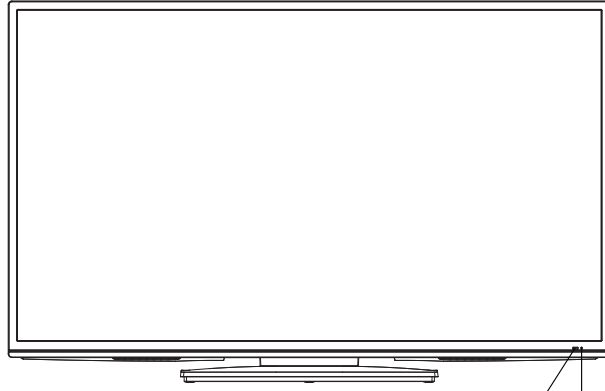

Remote sensor
Power Indicator
Red : Standby
Green : On

Right side

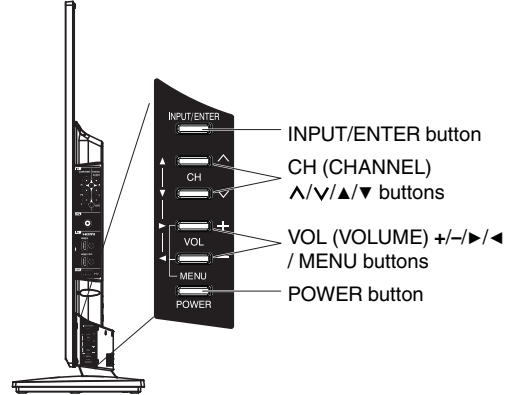

INPUT/ENTER button
CH (CHANNEL) $\wedge/\vee/\blacktriangle/\blacktriangledown$ buttons
VOL (VOLUME) $+/-/\blacktriangleright/\blacktriangleleft$ / MENU buttons
POWER button

To display the menu screen.
Press hold **VOL (VOLUME) +/-** simultaneously about 1 second the menu will be appear.
CH (CHANNEL) \wedge/\vee buttons, VOL (VOLUME) +/- buttons and INPUT/ENTER button can be used to select the desired setting during the menu screen operations.

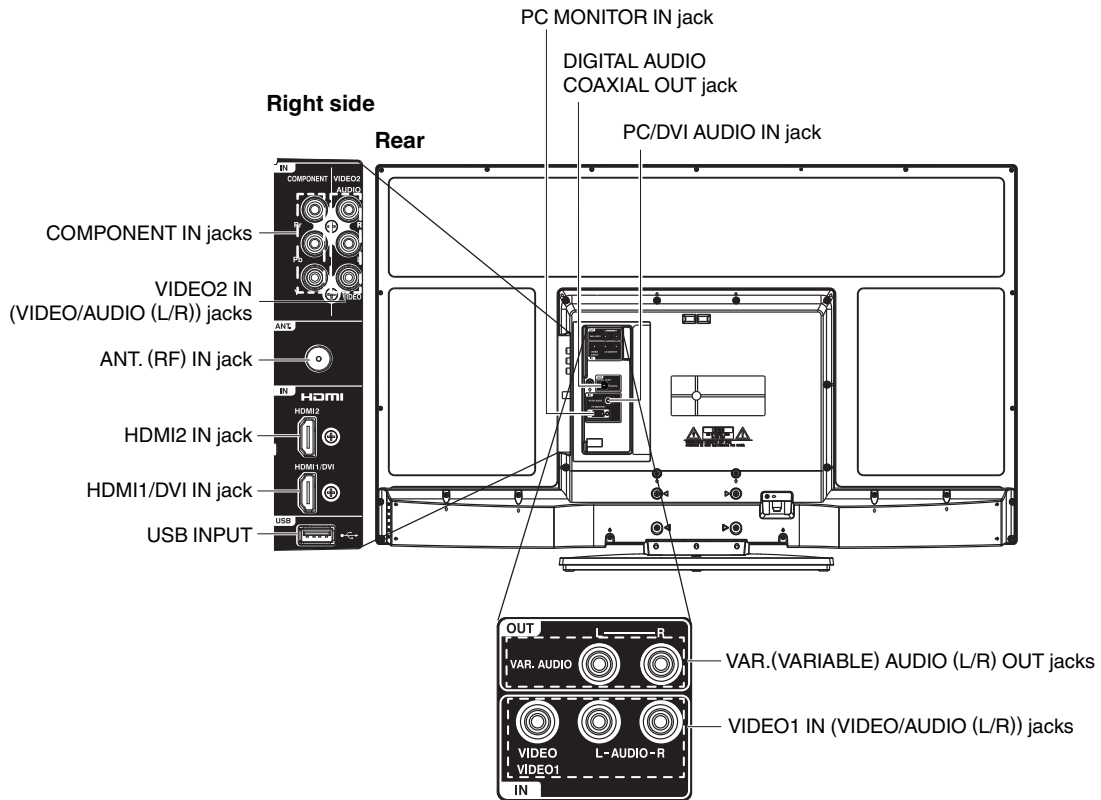

Note: This illustration used here based on model LE39S406/LE39H316.

Remote control

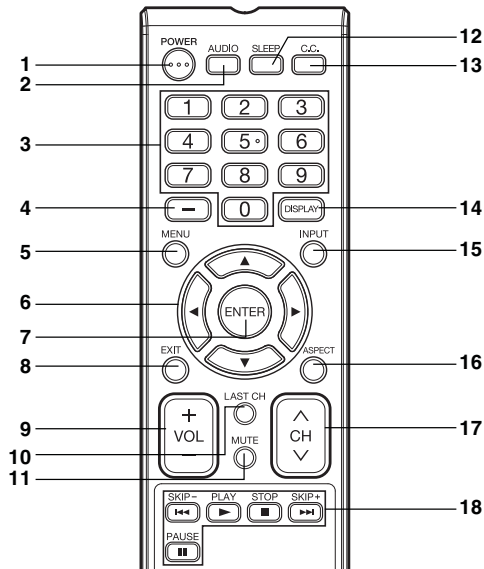

1. **POWER Button** - Press to turn the TV's power on/off.
2. **AUDIO Button** - Press to change the audio language.
3. **Direct Channel Selection Buttons (0-9)** - Allows direct access to any channel of the TV.
4. **- Button** - This button is the "-" button used when selecting digital channels.

Before using the remote control, batteries must first be installed.

HOW TO INSTALL BATTERIES

1. Open the battery compartment cover.



2. Install two "AAA" batteries (supplied).

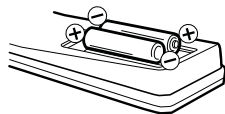

3. Replace the battery compartment cover.

5. **MENU Button** - Use to display the On-Screen menu function.
6. **CURSOR ▲/▼/◀/▶ Buttons** - Use to navigate and select menu functions of the TV.
7. **ENTER Button** - Press to enter or select functions for the On-Screen menu.
8. **EXIT Button** - Press to exit the On-Screen menu.
9. **VOL (VOLUME) + / - Buttons** - Press the + button to increase, or the - button to decrease the sound level.
10. **LAST CH Button** - Pressing this button allow you to go back to the previous channel selected. Press this button again to return to the channel you were watching.
11. **MUTE Button** - To turn off the sound, press this button once. The TV will be silenced and "Mute" will appear on the screen. The muting feature can be released by pressing the **MUTE** button again or by pressing either of the **VOL (VOLUME) +** or **-** buttons.
12. **SLEEP Button** - To set the TV to turn off after a preset amount of time, use the **SLEEP** button on the remote control.
13. **C.C. Button** - Used to display the Closed Captions menu screen.
14. **DISPLAY Button** - When you press this button the current information will be displayed on the screen.
15. **INPUT Button** - Press to change the TV's input.
16. **ASPECT Button** - Press to change the picture size.
17. **CH (CHANNEL) ^ / v Buttons** - Press to change the channel of the TV.
18. **Time Shift control Buttons** - See page 21.

Use two "AAA" size batteries. The batteries may last approximately one year depending on how much the remote control is used. For best performance, it is recommended that batteries should be replaced on a yearly basis, or when the remote operation becomes erratic. Do not mix old and new batteries or different types.

BATTERY PRECAUTIONS

These precautions should be followed when using batteries in this device:

- Use only the size and type of batteries specified.
- Be sure to follow the correct polarity when installing the batteries as indicated in the battery compartment. Reversed batteries may cause damage to the device.
- Do not mix different types of batteries together (e.g. Alkaline, Carbon-zinc or Rechargeable) or old batteries with fresh ones.
- If the device is not to be used for a long period of time, remove the batteries to prevent damage or injury from possible battery leakage.
- Do not try to recharge batteries not intended to be recharged; they can overheat and rupture. (Follow battery manufacturer's directions.)
- Please use caution when inserting batteries to avoid battery damage. If the spring terminal in the remote control remains in contact with a side of a damaged battery it can cause a short circuit. Never use damaged batteries as they can become very hot and are dangerous.

Antenna connections

If you are using an indoor or outdoor antenna, follow the instructions below that correspond to your antenna system. If you are using a Cable TV service, see Cable TV connections.

Combination VHF/UHF Antenna (Single 75 ohm cable)

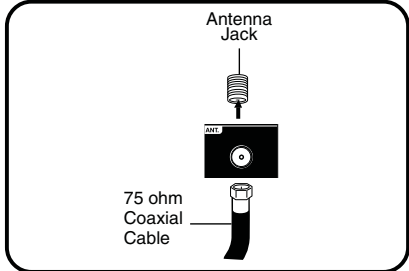

Connect the 75 ohm cable from the combination VHF/UHF antenna to the Antenna Jack.

Cable TV connections

This TV has an extended tuning range and can tune most cable channels without using a Cable TV Converter box. Some cable companies offer "premium pay channels" where the signal is scrambled. Descrambling these signals for normal viewing requires the use of a descrambler device which is generally provided by the Cable TV company.

For subscribers to basic Cable TV service

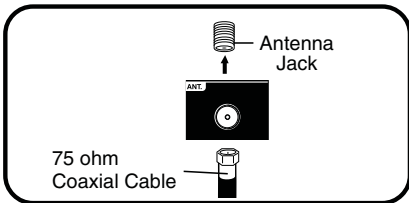

For basic Cable TV service not requiring a Converter/Descrambler box, connect the 75 ohm Coaxial Cable directly to the Antenna Jack on the back of the TV.

For subscribers to scrambled Cable TV service

If you subscribe to a Cable TV service which requires the use of a Converter/Descrambler box, connect the incoming 75 ohm Coaxial Cable to the Converter/Descrambler box. Using another 75 ohm Coaxial Cable, connect the output jack of the Converter/Descrambler box to the Antenna Jack on the TV. Follow the connections shown below. Set the TV to the output channel of the Converter/Descrambler box (usually channel 3 or 4) and use the Converter/Descrambler box to select channels.

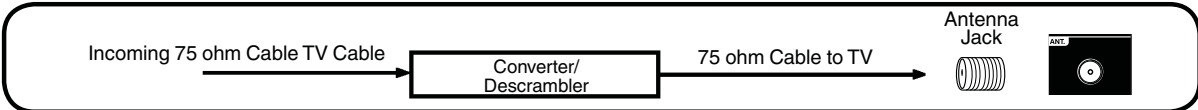

For subscribers to unscrambled Cable TV service with scrambled premium channels

If you subscribe to a Cable TV service in which basic channels are unscrambled and premium channels require the use of a Converter/Descrambler box, you may wish to use a signal Splitter and an A/B Switch box (available from the Cable TV company or an electronics supply store). Follow the connections shown below. With the switch in the "B" position, you can directly tune any unscrambled channels on your TV. With the switch in the "A" position, tune your TV to the output of the Converter/Descrambler box (usually channel 3 or 4) and use the Converter/Descrambler box to tune scrambled channels.

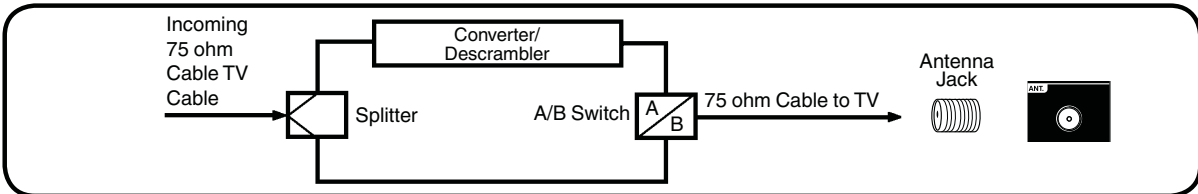

Starting setup

The Auto Setup menu appears the first time you turn on the TV, and assists you to specify the Air/Cable setting, and program your channels automatically.

IMPORTANT: Make sure that the antenna or cable TV system connection is made!

- 1 To turn on the TV, press **POWER** (POWER indicator on the front of the unit changes green. It may take approx. 10 seconds for a picture to appear on screen.) The Auto Setup function begins.

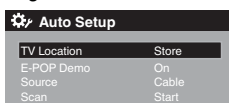

- 2 Press **▲** or **▼** to select "TV Location", then press **◀** or **▶** to select "Home" or "Store". This product qualifies for ENERGY STAR in Home mode default setting.

NOTE:

- This unit has been preset to STORE brightness. This setting does not qualify under ENERGY STAR. To reduce brightness and energy consumption, change setting to 'HOME'. This setting does qualify under ENERGY STAR.
- The device may not conform to the ENERGY STAR standard after Reset is performed or the Backlight is adjusted.

- 3 Press **▲** or **▼** to select "E-POP Demo", then press **◀** or **▶** to select "On" or "Off".
On: A TV feature introduction will be popped up at the bottom of the screen.
Off: Turn off the E-POP Demo feature.

- 4 Press **▲** or **▼** to select "Source", then press **◀** or **▶** to select "Air" or "Cable".

- 5 Press **▲** or **▼** to select "Scan", then press **▶** or **ENTER**.

- 6 "Auto Setup" will begin. After the Auto Setup is completed, the TV channel appears on the screen.
 - Depending on the reception condition, it may take up to 30 minutes to complete memorizing digital cable channels. Please allow the process to complete without interruption.

NOTE:

- If you press **EXIT** in the process of "Auto Setup", the Auto Setup stops and changes to the normal screen.
- When you make a menu selection, your changes occur immediately. You do not have to press **EXIT** to see your changes.
- If E-POP was turned ON in Auto Setup, to turn E-POP OFF, please set the TV to the TV input, then set "E-POP Demo" in the Auto Setup menu to "Off".

TV operation

- 1 To turn on the TV, press **POWER**. (POWER indicator on the front of the unit changes green. It may take approx. 10 seconds for a picture to appear on screen.)
- 2 Adjust the volume level by pressing **VOL +** or **-**. The volume level will be indicated on the screen by green bars. As the volume level increases, so do the number of bars. If the volume decreases, the number of green bars also decreases.
- 3 Set the Source option to the appropriate position (see "Air/Cable selection" on page 16).
- 4 Press the **Direct Channel Selection Buttons (0-9, -)** buttons to select the channel.
(If you press only the channel number, channel selection will be delayed for a few seconds.)

TO SELECT ANALOG CHANNELS

- 1-9: Press 1-9 as needed. Example, to select channel 2, press **2**, then press **ENTER**.
- 10-99: Press the 2 digits in order. Example, to select channel 12, press **1, 2**, then press **ENTER**.
- 100-135: Press the 3 digits in order. Example, to select channel 120, press **1, 2, 0**, then press **ENTER**.

TO SELECT DIGITAL CHANNELS

Press the first 1-3 digits, then press the **-** button followed by the remaining number.

Example, to select channel 15-1, press **1, 5, -, 1**, then press **ENTER**.

- If a channel is selected with only audio content, "Audio only" will be displayed on the screen.
- If a channel is selected with a weak digital signal, "Weak Signal or Channel not available." will be displayed on the screen.
- The same program may be available on either an analog channel or a digital channel. You may choose to watch either format.
- If a channel is selected to which you have not subscribed, "Digital channel is encrypted" will be displayed on the screen.

VHF/UHF/CABLE CHANNELS

Air	Cable
VHF 2-13	VHF 2-13
UHF 14-69	STD/HRC/IRC 14-36 (A) (W) 37-59 (AA) (WW) 60-85 (AAA) (ZZZ) 86-94 (86) (94) 95-99 (A-5) (A-1) 100-135 (100) (135) 01 (4A)

NOTE:

- If a channel with no broadcast is selected, the sound will automatically be muted.
- It may take a few seconds for a digital channel picture to appear on screen after being selected.

To select the video input source

To view a signal from another device connected to your TV, such as a VCR player, press **INPUT**, then press **▲** or **▼** or corresponding **Number buttons (0-6)**, then press **ENTER**.

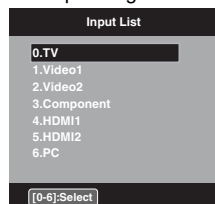

CH **^**/**v**

Press and release **CH **^**/**v****. The channel automatically stops at the next channel set into memory.

For proper operation, before selecting channels, they should be set into the memory. See "Memorizing channels" on page 16.

DISPLAY

Press **DISPLAY** to display the current information on the screen.

When the TV receives a digital signal, the digital information will appear.

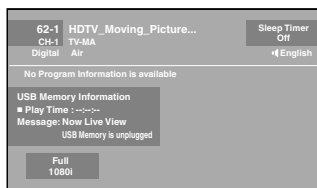

- Channel number
- Channel label (if preset)
- Parental Control
- Sleep timer
- Program guide
- Resolution
- Station name
- Broadcast program name
- Signal type
- Audio language
- Picture size
- Time Shift display

When the TV receives an analog signal, the analog information will appear.

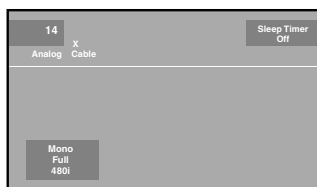

- Channel number
- Parental Control
- Sleep timer
- Audio information (Stereo, SAP or Mono)
- Channel label (if preset)
- Signal type
- Picture size
- Resolution

Press **DISPLAY** again to clear the display.

NOTE:

- After a few seconds the **DISPLAY** screen will return to normal TV operation automatically.

LAST CH

This button allows you to go back to the last channel selected by pressing **LAST CH**. Press **LAST CH** again to return to the last channel you were watching.

MUTE

Press **MUTE** to switch off the sound. The TV's sound will be silenced and "Mute" will appear on the screen. The sound can be switched back on by pressing this button again or by pressing the **VOL +** or **-** buttons.

SLEEP

To set the TV to turn off after a preset amount of time, press **SLEEP** on the remote control. The clock will count up 10 minutes for each press of the **SLEEP** button (Off, 0h 10m, 0h 20m, ..., 2h 0m). After the sleep timer is programmed, the display will appear briefly every ten minutes to remind you that the sleep timer is operating. To confirm the sleep timer setting, press **SLEEP** and the remaining time will be displayed for a few seconds. To cancel the sleep timer, press **SLEEP** repeatedly until the display turns to Off.

Quick guide for menu operation

Example: Select Menu Language.

- 1 Press **INPUT** to select TV mode.
- 2 Press **MENU**. The TV menu screen will appear.

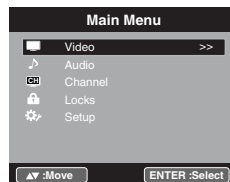

- 3 Press **▲** or **▼** to select "Setup", then press **▶** or **ENTER**.
- 4 Press **▲** or **▼** to select "Menu Language", then press **◀** or **▶** to select the desired language.

On the following pages the menu can be called in the same way as here.

- 5 Press **EXIT** to return to the normal screen.

NOTE:

- If no buttons are pressed for more than 60 seconds, the menu screen will clear and the TV will return to normal viewing automatically.

Convenience functions

You can change the default settings to your preference by pressing the **MENU** button on your remote, selecting one of the icons at the left of the menu, and following the On-Screen prompts.

Icon	Selected Items		Setup hint	
Video	Picture Mode	Dynamic	Bright and dynamic picture (factory-set)	
		Standard	Standard picture quality (factory-set)	
		Movie	Movie-like picture setting (factory-set)	
		Custom	Your personal preferences (set by you; see "Picture Setting")	
	Picture Setting	Brightness / Contrast / Sharpness / Color / Tint		You can adjust the picture quality to your preference.
		Color Temperature		Cool (Bluish) / Standard (Neutral) / Warm (Reddish)
	DBC	On/Eco/Off	Use this feature to change the Black level automatically according to the brightness of an image. The Black level will become dark in a dark scene. If "Eco" is selected, the power consumption is reduced and "Backlight" will be skipped.	
	Backlight* ²		The Backlight feature adjusts the screen brightness for improved picture clarity.	
	Aspect		See page 20.	
	Auto Movie Mode	On/Off	A smoother motion may be obtained by setting the Auto Movie Mode to "On" (480i only).	
	PC Setting	H Position / V Position		Adjust the horizontal / vertical position of the image on the PC monitor screen. Each video standard will require a different value for this setting.
		Clock		Minimize any vertical bars or stripes visible on the screen background.
		Phase		This must be adjusted after the frequency has been set optimize picture quality.
Auto Adjust		Adjust the all PC settings automatically.		
Noise Reduction	On/Off	Noise Reduction can reduce the roughness of the picture.		
Audio	Equalizer Mode	Standard/Music/ Movie/News/ Custom/Flat	You can adjust the Equalizer Mode to your preference.	
	Audio Setting	Bass/Treble	You can adjust the sound quality to your preference. (Flat mode only)	
		Equalizer Setting	100Hz/250Hz/500Hz/1kHz/2kHz/4kHz/10kHz (Not available in Flat mode)	
		Balance	You can adjust the sound quality to your preference.	
	MTS	Stereo / SAP / Mono	The multi-channel TV sound (MTS) feature provides high-fidelity stereo sound. MTS also can transmit a second audio program (SAP) containing a second language or other audio information. When the TV receives a stereo or SAP broadcast, the word "Stereo" or "SAP" displays on-screen when you press DISPLAY .	
	Surround	On/Off	The dynamic presence and sound created offers a thoroughly enjoyable listening experience.	
	Perfect Volume	On/Off	Volume level will be adjusted automatically between signals.	
	Audio Language		When two or more audio languages are included in a digital signal, you can select one of the audio language. (This function is available only for digital broadcast.)	
	HDMI1 Audio	HDMI	Select this setting when you connect a HDMI device to the TV.	
		DVI	Select this setting when you connect a DVI device to the TV with an analog audio connection.	
Speakers	On/Off	Use this feature to turn the TV speakers off when you connect an audio system.		
Channel	Channel Manager		See page 16.	
	Signal Meter		See page 17.	
	Auto Channel Scan		See page 16.	
	Channel Labels		See page 17.	
Locks			See page 17.	
Setup	Closed Captions		See page 19.	
	Menu Language		You can choose from three different languages (English, Français (French) and Español (Spanish)) for the on-screen displays. Select the language you prefer first, then proceed with the other menu options.	
	Video Label		See page 17.	
	On Timer	Off / 0h30m / 1h00m / 1h30m / 2h00m / 3h00m · · · 12h00m	You can set the On Timer to automatically turn on the TV. To cancel the On Timer select "Off".	
	Auto Shut Off* ¹	On/Off	If the Auto Shut Off feature is On, when a station being viewed stops broadcasting and the TV is not operated, the TV will automatically shut itself off after 15 minutes.	
	Auto Setup		See page 13.	
	Power On LED	On/Off	When you turn on the TV, the Power indicator on the front of the TV will light.	
	PC Standby	On/Off	In PC mode, if no signal is received and no operation is performed for 1 minute, the TV will turn to standby mode automatically (LED light will flash red). When an input signal is received or an operation is performed on the PC, the TV will return to the On mode.	
	Reset* ²		The Reset function returns your "Video" and "Audio" settings to the factory settings. "Aspect", "MTS", "Audio Language", "HDMI1 Audio" and "Speakers" will not reset by this function.	

NOTE:

*¹ If there is no input signal in the PC mode after 1 minute, Auto Shut Off will be activated.

*² "PC Standby" setting is precedence when in the PC mode.

*² The device may not conform to the Energy Star standard after Reset is performed or the Backlight is adjusted.

Memorizing channels

This TV is equipped with a channel memory feature which allows channels to skip up or down to the next channel set into memory, skipping over unwanted channels. Before selecting channels, they must be programmed into the TV's memory. To use this TV with an antenna, set the Source option to the Air mode. When shipped from the factory this menu option is in the Cable mode.

Air/Cable selection

- 1 Select "Channel ⇒ Auto Channel Scan ⇒ Source".
- 2 Press ◀ or ▶ to select "Air" or "Cable".

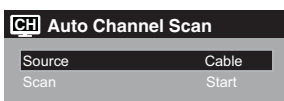
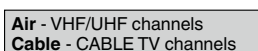

NOTE:

- It may take a few seconds for a digital channel picture to appear on screen after being selected.

Scan

- 1 Select "Channel ⇒ Auto Channel Scan ⇒ Scan", then press ▶ or ENTER.

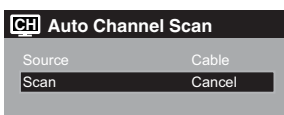

- 2 The TV will begin memorizing all the channels available in your area.
 - It may take from 15 minutes to 25 minutes to complete memorizing digital cable channels.
 - Depending on the reception condition, a bar display may not advance for several minutes, please be patient.

NOTE:

- Memorizing channels is best accomplished during evening "PRIMETIME" hours, as more stations are broadcasting digital signals. Memorizing channels can only be accomplished while a station is broadcasting a digital signal to set that channel into memory.
- If you are unsure of the digital channels available in your area, you may visit www.antennaweb.org to receive a list based on your address or zip code. Should you require further assistance you may call our toll-free customer service line at 1-800-289-0981 (USA/Canada), 01-800-703-0885 (MEXICO).
- New digital channels may be added to your area periodically, it is recommended to perform the "Scan" procedure regularly.

Add Digital Channel

If you find a new unregistered digital channel, you can add the new channel into the channel memory.

- 1 Tune in the new channel.
- 2 Select "Channel ⇒ Channel Manager ⇒ Add Digital Channel", then press ▶ or ENTER.

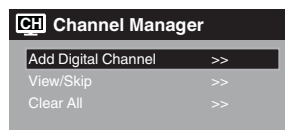

- 3 The new channel will be added into the channel memory.

View/Skip channel

You can select the channel that you want to skip.

- 1 Select "Channel ⇒ Channel Manager ⇒ View/Skip", then press ▶ or ENTER.
- 2 Press ▲ or ▼ to select the channel that you want to skip.

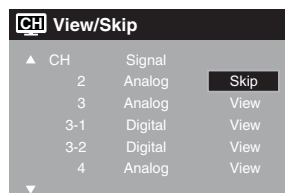

- 3 Press ◀ or ▶ to select "View" or "Skip", whichever function you want to perform.
- 4 Repeat steps 2 - 3 for other channels you want to view or skip.

Clear All

All channels are deleted from the channel memory.

Select "Channel ⇒ Channel Manager ⇒ Clear All", then press ▶ or ENTER.

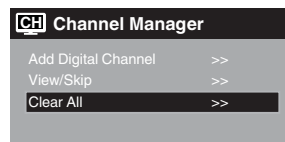

Checking the digital signal strength

This TV will allow you to view the digital signal meter for digital channels.

- 1 Select "Channel ⇒ Signal Meter", then press ► or ENTER.
- 2 The digital signal strength screen will appear.
If necessary, adjust the direction of the antenna to obtain the maximum signal strength.

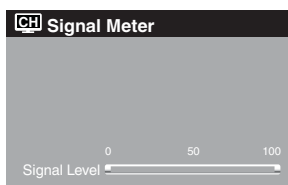

NOTE:

- Signal meter feature is not available for analog channels.
- After 240 seconds the Signal Meter screen will clear and the TV will return to normal viewing automatically.

Labeling channels

Channel label appears with the channel number display each time you turn on the TV, select a channel, or press DISPLAY. You can choose any four characters to identify a channel.

To create channel labels

- 1 Select "Channel ⇒ Channel Labels", then press ► or ENTER.
- 2 Press ◀ or ▶ to select a channel you want to label, then press ▼.

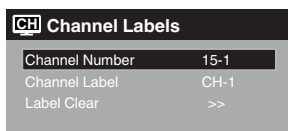

- 3 Press ◀ or ▶ repeatedly until the character you want appears in the first space.

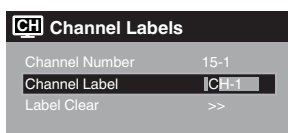

The characters rotation as follows:

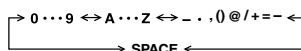

If the character which you desire appears, press ENTER.

Repeat this step to enter the rest of the characters.

If you would like a blank space in the label name, you must choose the empty space from the list of characters.

- 4 Repeat steps 2-3 for other channel. You can assign a label to each channel.
- 5 When you finish inputting the label name, press EXIT to return to the normal screen.

To clear a Channel Label

After step 2 above, press ▲ or ▼ to select "Label Clear", then press ► or ENTER.

NOTE:

- The channel labels will be reset after "Scan" on page 16.

Labeling video inputs

The Video Label feature allows you to label each input source for your TV.

- 1 Select "Setup ⇒ Video Label", then press ► or ENTER.
- 2 Press ▲ or ▼ to select an input which you want to label.
- 3 Press ◀ or ▶ to select the desired label for that input source.

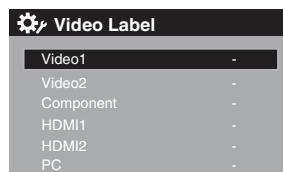

Available video labels: - / VCR / DVD / STB / Cable / Satellite / Receiver / Game / Camcorder / PC / DVI PC / Blu-ray

Setting the Parental Control

An age limitation can be set to restrict children from viewing or hearing violent scenes or pictures that you may choose to exclude. The restriction applies to "TV", "Movie", "CAN ENG Rating" and "CAN FRE Rating" (if this data is transmitted). You may set this restriction separately. To use the Parental Control function, you must register a password.

To register a password

- 1 Select "Locks", then press ► or ENTER.
- 2 Select and enter your password (4 digits) using Number buttons (0-9), then press ENTER.

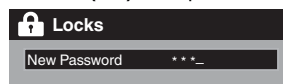

- 3 "⌘" appears instead of the number.
Enter the same password again to confirm, then press ENTER.
The password is now registered.

NOTE:

- If you forget the password, contact Customer Service at 1-800-289-0981 (USA/Canada), 01-800-703-0885 (MEXICO) for assistance.
Your original remote control will be required.
- To avoid forgetting the password, write it down and keep in a safe place.

To set the Parental Control

- 1 Select "Locks", then press ► or **ENTER**.
- 2 Use **Number buttons (0-9)** to enter your password, then press **ENTER**. The Locks menu will appear.
- 3 Press ▲ or ▼ to select "Parental Control", then press ◀ or ▶ to select "On".
- 4 Press ▲ or ▼ to select "Ratings", then press ► or **ENTER**. The Ratings menu appears.
- 5 Press ▲ or ▼ to select which rating will be used, then press ► or **ENTER**. Each rating below will appear.

TV

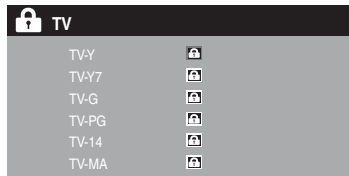

You can set the rating using age level and genre.

Age:

- TV-Y** : All children
- TV-Y7** : 7 years old and above
- TV-G** : General audience
- TV-PG** : Parental guidance
- TV-14** : 14 years old and above
- TV-MA** : 17 years old and above

When you select TV-Y7, TV-PG, TV-14 or TV-MA, press **DISPLAY** to set sub-ratings.

Genre:

- D** : Dialogue
- L** : Language
- S** : Sex
- V** : Violence
- FV** : Fantasy Violence

Movie

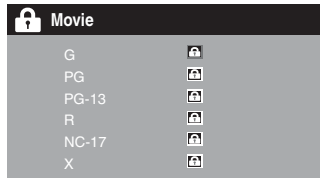

- G** : All ages
- PG** : Parental guidance
- PG-13** : Parental guidance less than 13 years old
- R** : Under 17 years old parental guidance suggested
- NC-17** : 17 years old and above
- X** : Adult only

Canadian English ratings

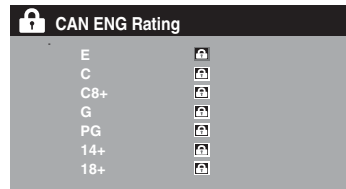

You can set the rating using age level.

- E** : Exempt
- C** : Programming intended for children under age 8
- C8+** : Programming generally considered acceptable for children 8 years and over to watch on their own
- G** : General Audience
- PG** : Parental Guidance
- 14+** : Programming contains themes or content which may not be suitable for viewers under the age of 14
- 18+** : Adult

Canadian French ratings

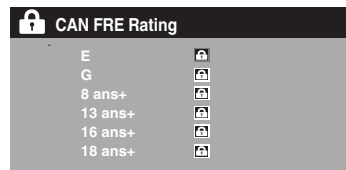

- E** : Exempt
- G** : General
- 8 ans+** : 8 + General
- 13 ans+** : Programming may not be suitable for children under the age of 13
- 16 ans+** : Programming is not suitable for children under the age of 16
- 18 ans+** : Programming restricted to adults

- 6 Press ▲ or ▼ to select the desired rating, then press **ENTER**.
- 7 Press **EXIT** to return to the normal screen. Parental Control function is activated now.

NOTE:

- The Parental Control function is activated only on programs and input sources that include a rating signal.

To change the password

- 1 In the Parental Control menu, press ▲ or ▼ to select "Change Password", then press ► or **ENTER**.
The Change Password screen will appear.
- 2 Enter a new password using **Number buttons (0-9)**, then press **ENTER**.
- 3 Enter the same password again to confirm, then press **ENTER**.
The password is now registered.

Downloading the additional Parental Control rating system

As a supplement to the standard Parental Control rating system, your television will be able to download an additional rating system, if such a system becomes available in the future.

To download the additional Parental Control rating system (when available)

- 1 In the Parental Control menu, press ◀ or ▶ to set "Parental Control" to "On".
- 2 Press ▲ or ▼ to select "Region 5", then press ► or **ENTER**.
- 3 If the TV is not storing the additional rating system, the TV will begin downloading it, which may take some time to be completed.
- 4 Set your preferred content rating limits for the additional rating system.
- 5 You also need "Region 5 Update" procedure to update rating information.

NOTE:

- You can only download the additional Parental Control rating system when your TV is receiving a digital signal.
- When you download the additional rating system, it may take some time for the download to occur.
- The Parental Control rating information and system are not determined or controlled by the TV.
- The standard Parental Control rating system is available whether your TV is receiving a digital signal or not, and will block both analog and digital programs. To set the restriction level using the standard Parental Control rating system, select Ratings in step 2.
- The downloadable Parental Control rating system is an evolving technology, and availability, content, and format may vary.
- You cannot select this feature if the TV is not receiving a digital signal for the current station.

To clear the all Parental Control settings

- 1 In the Parental Control menu, press ▲ or ▼ to select "Reset", then press ► or **ENTER**.
The Reset screen will appear.
- 2 Use **Number buttons (0-9)** to enter your password, then press **ENTER**. All your settings return to the factory settings.

Closed Caption

WHAT IS CLOSED CAPTIONING?

This television has the capability to decode and display Closed Captioned television programs. Closed Captioning will display text on the screen for hearing impaired viewers.

Captions: This Closed Caption Mode will display text on the screen in English or another language if program supports other languages. Generally, Closed Captions in English are transmitted on CC1 and a Closed Caption in other languages is transmitted on CC2.

Text: The Text Closed Caption Mode will usually fill 1/2 of the screen with other text information such as weather if program supports this feature.

- 1 Select "Setup ⇒ Closed Captions", then press ► or **ENTER**.
- 2 Press ◀ or ▶ to set "CC Display" to "On".
On: Captions will be displayed on the screen.
Off: Captions will not be displayed on the screen.
- 3 Press ▲ or ▼ to select "Analog Caption" or "Digital Caption".
When you select "Analog Caption", you can choose from CC1, CC2, CC3, CC4, Text1, Text2, Text3 and Text4.
When you select "Digital Caption", you can choose from Service1, Service2, Service3, Service4, Service5 and Service6.
- 4 Press ◀ or ▶ to select the desired Closed Caption mode for both Digital and Analog Captions.
- 5 Press ▲ or ▼ to select "CC Priority", then press ◀ or ▶ to select "Digital CC" or "Analog CC".

NOTE:

- Depending on the broadcast signal, some Analog Captions will function with a Digital broadcast signal. This step prevents that two kind of captions are overlapping.

NOTES:

- If the program or video you selected is not closed-captioned, no captions will display on-screen.
- If text is not available in your viewing area, a black rectangle may appear on-screen. If this happens, set the CC Display to "Off".
- When selecting Closed Captions, the captioning will be delayed approx. 10 seconds.
- If no caption signal is received, no captions will appear, but the television will remain in the Caption Mode.
- Misspellings or unusual characters may occasionally appear during Closed Captioning. This is normal with Closed Captioning, especially with live programs. During live programs, captions are also entered live and these transmissions do not allow time for editing.
- When Captions are being displayed, on-screen displays, such as volume and mute may be seen but may interfere with Closed Captions.
- Some cable systems and copy protection systems may interfere with the Closed Captioned signal.
- If using an indoor antenna or if TV reception is very poor, the Closed Caption Decoder may not appear or may appear with strange characters or misspelled words. In this case, adjust the antenna for better reception or use an outdoor antenna.
- Closed Captions menu also can be displayed by pressing **C.C.** on the remote control.

CC advanced

When you have selected Custom as the display method, you can adjust the various setting listed below as follows:

This feature is designed to customize Digital Captions only.

- 1 Select "Setup ⇒ Closed Captions", then press ► or ENTER.
- 2 Press ◀ or ▶ to set "CC Display" to "On".
- 3 Press ▲ or ▼ to select "Digital CC Preset", then press ◀ or ▶ to select "Custom".
- 4 Press ▲ or ▼ to select "CC Advanced", then press ► or ENTER.
The CC Advanced menu will appear.
- 5 Press ▲ or ▼ to select the desired item, then press ◀ or ▶ to change the setting.

CC Advanced	
Text Size	Auto
Text Type	Auto
Text Edge	Auto
Text Color	Auto
Text Opacity	Auto
Background Color	Auto
Background Opacity	Auto

You can select from among the following items and parameters.

Text Size:	Auto, Small, Standard, Large
Text Type:	Auto, Style1, Style2, Style3, Style4, Style5, Style6, Style7
Text Edge:	Auto, None, Raised, Depressed, Uniform, Left Shadow, Right Shadow
Text Color:	Auto, Black, White, Red, Green, Blue, Yellow, Magenta, Cyan
Text Opacity:	Auto, Solid, Transparent, Translucent, Flashing
Background Color:	Auto, Black, White, Red, Green, Blue, Yellow, Magenta, Cyan
Background Opacity:	Auto, Solid, Transparent, Translucent, Flashing

NOTE:

- You cannot set both "Text Color" and "Background Color" as a same color.
- You cannot set both "Text Opacity" and "Background Opacity" to "Transparent".

Aspect Switching

You can display the image at its optimum condition by selecting display aspect.

Selecting the picture format aspect ratio

- 1 Select "Video ⇒ Aspect", then press ► or ENTER to display "Aspect" menu.
- 2 Press ▲ or ▼ or corresponding **Number buttons (0-4)** to select the desired picture format aspect ratio, as described below.

Aspect	
0.Natural	
1.Cinema Wide1	
2.Cinema Wide2	
3.Cinema Wide3	
4.Full	

NOTE:

- Selectable picture format aspect ratios may vary depending on the input source or broadcast signal.
- Aspect menu also can be displayed by pressing **ASPECT** on the remote control.

Natural

In some cases, this image will display the size of standard 4:3 with a black side bar.

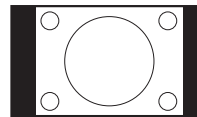

Cinema Wide1 (for 4:3 format programs)

To fill the screen, the right and left edges are extended. However, the center of the picture remains near its former ratio. The top and bottom edges of the picture may be hidden.

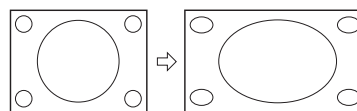

Cinema Wide2 (for letter box programs)

The entire picture is uniformly enlarged-it is stretched the same amount both wider and taller (retains its original proportion). The top and bottom edges of the picture may be hidden.

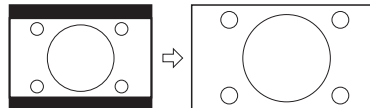

Cinema Wide3 (for letter box programs with subtitles)

To fill the width of the screen, it is extended horizontally. However, it is only slightly extended at the top and the bottom. The top and bottom edges of the picture may be hidden.

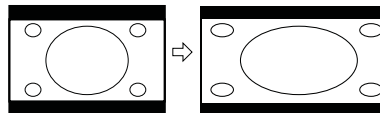

Full (for 16:9 source programs)

Full will display the picture at the maximum size.

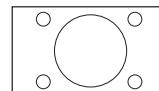

Native (for PC mode only)

Detects the resolution of the signal of the image and it will be shown on the screen with same amount of pixels.

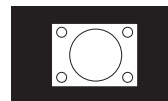

NOTE:

- Some High Definition and/or Digital broadcasts may not allow you to change the picture format aspect ratio.
- In HDMI or COMPONENT mode with a scanning rate of 720p, 1080i or 1080p (only HDMI), only the Cinema Wide2 and Full are available.
- In PC mode, only the Natural, Full and Native are available. In PC mode (WXGA, LE39S406/LE39H316: WXGA, WXGA+, FHD), only the Full and Native are available.
- LE39S406/LE39H316 : When the PC connected to the HDMI terminal and 1920x1080 resolution (FHD) is selected, the top and bottom, right and left edges of the picture may be hidden on all picture sizes.

Time Shift

You can record a digital program by using the USB memory drive. This function is for your convenience, and allows you to pause/record a live program for a period of time based on the size of the USB drive inserted.

Note: The connected USB device must:

- Have a minimum approx. 100 MB of memory (32 GB max.).
- Formatted as FAT16/32.
- Have a write speed higher than 40Mb/sec.
- Contain no other files.
- Do not use USB extension cable.

Preparation:

Plug-in an external storage device into USB port.

- To start recording, press **II (PAUSE)**. The recording will start and the picture will be paused.
- To view a live program press **■ (STOP)**. The paused picture goes back to a live program and recording continues.
- To stop recording, press **■ (STOP)** again during viewing a live program with recording.
- To start playback, press **▶ (PLAY)**. The recorded program starts playback.
If you want to watch the program while recording, press **▶ (PLAY)**.
You can watch the recorded program while recording the current program.
- To pause the playback picture, press **II (PAUSE)**.
- To stop the playback, press **■ (STOP)**.
- To fast forward or fast reverse, press **▶▶ (SKIP+)** or **◀◀ (SKIP-)**.

USB status display

Press **DISPLAY** while watching a DTV channel, or press the Time Shift operation buttons. The status display will appear.

Playback status :

- ▶ (PLAY), ■ (STOP), II (PAUSE),
- ▶▶ (SKIP+), ◀◀ (SKIP-)

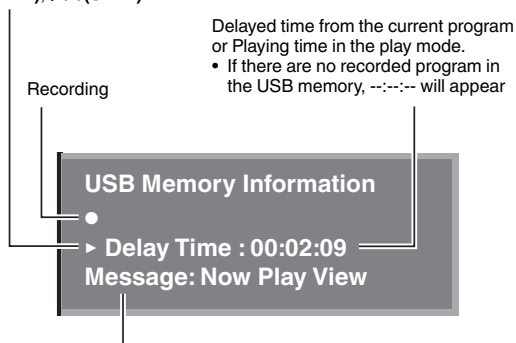

Message display

- Now Live View... Viewing live program
- Now Play View... Viewing recorded program
- Now Pause View... Pausing the program
- Not Available... Inhibited function
- USB Memory is full...Caution of available USB memory less than 100MB (Insufficient USB free space...will show when **II (PAUSE)** is pressed).
- No Data... When you press **▶ (PLAY)** and there are no data recorded in the USB memory
- USB Memory is unplugged... USB memory is not connected

To delete the recorded program

Disconnect the USB memory, record another program, or turn off the TV.

Notes:

- Time shift does not work for ATV or external inputs. If you change the signal while recording a program (Live View) the recording will stop.
- During Play view mode, ATV channel select or input select will not work.
- Time shift recordable time is approximately 10 minutes per 1 GB for HD or 30 minutes for SD (depending on the program).
- You cannot watch the recorded program on PC or other devices.
- All of the USB memory may not be able to be used.
- We will accept no responsibility whatsoever for loss of files on USB devices caused by connection to this unit.

Connections to other equipment

The exact arrangement you use to interconnect various video and audio components to this unit is dependent on the model and features of each component. Check the Owner's Manual provided with each component for the location of video and audio inputs and outputs.

To connect the TV to a VCR

Right and Rear of the unit

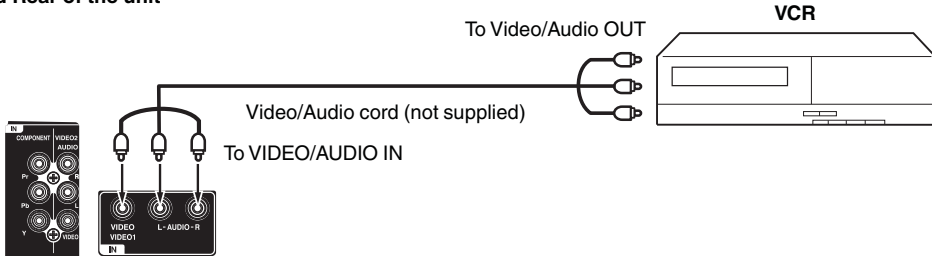

To connect the TV to a DVD player with Component Video Input

You can enjoy a high quality picture by connecting the unit's COMPONENT VIDEO OUT jacks of your DVD player with the component video cables (not supplied).

Right of the unit

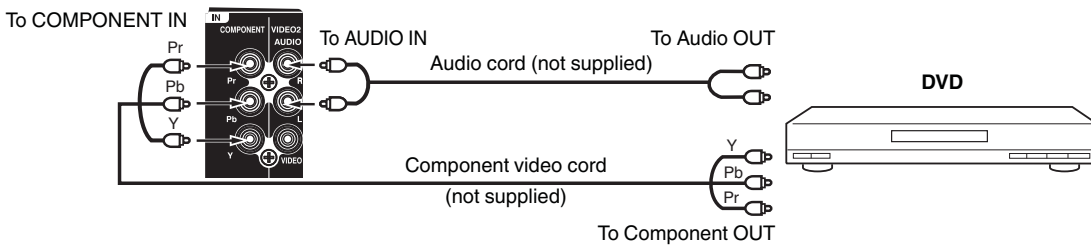

NOTE:

- Component Video input of the unit are for use with a device which output 480i/1080i interlaced signals and 480p/720p progressive signals.

To connect the TV to a camcorder or a game console

To playback from a camcorder, connect the camcorder to the unit as shown.

This unit can also be used as a display device for many video game consoles. However, due to the wide variety of signals generated by these devices and subsequent hook-up variations required, they have not all been included in the suggested connection diagrams. You'll need to consult each component's Owner's Manual for additional information.

Right and Rear of the unit

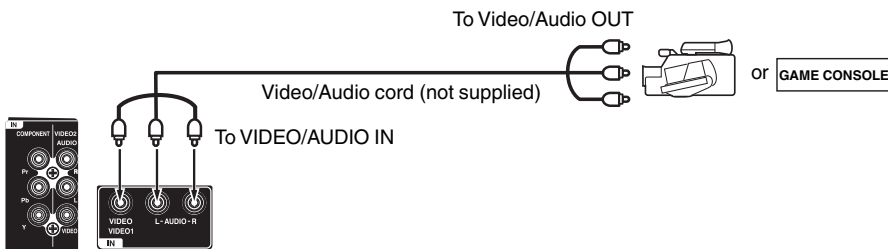

Connections to other equipment

(continued)

To connect the TV to an audio system

This connection allows you to use an audio amplifier with external speakers and adjust the audio level using the TV's remote control. To control the audio, turn on the TV and the stereo amplifier and turn off the TV's built-in speakers (see page 15).

Rear of the unit

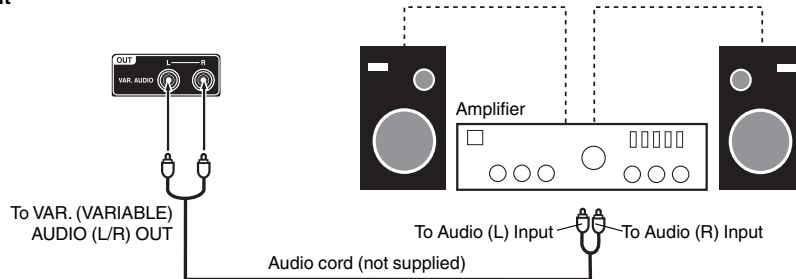

NOTES:

- To hear sound when using an external audio amplifier, the volume of both the TV and the amplifier must be set above 0 (zero).
- For example, if the volume of the TV is set to 0, you will not be able to hear any sound, even if the volume of the amplifier is at its highest level.

Using an AV Amplifier with built-in digital surround

If you are using an AV Amplifier with built-in digital surround sound, you can enjoy various audio systems including Dolby Digital Surround audio that sounds just like the movie.

Connect an AV amplifier with built-in Dolby Digital decoder, etc. as shown below.

Rear of the unit

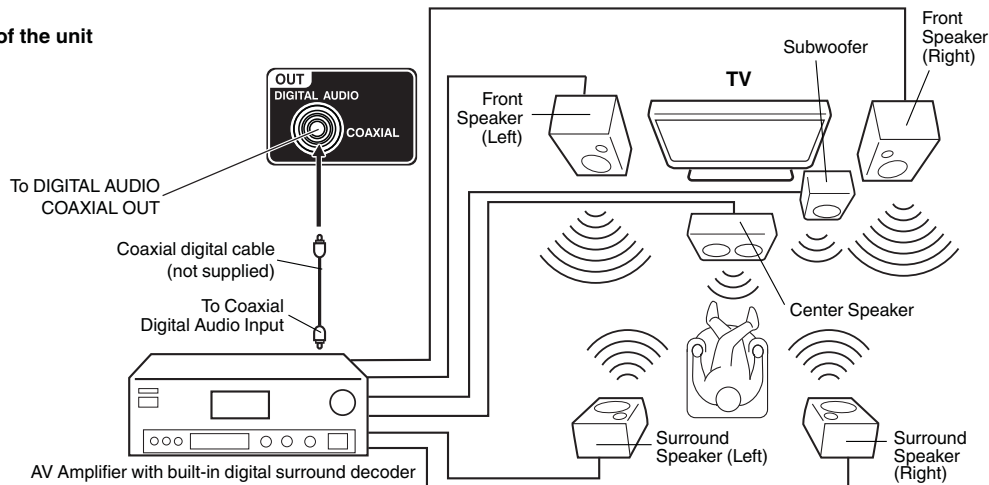

NOTE:

- When you are viewing digital broadcast, this unit will not work in conjunction with DTS audio or MPEG audio. There will be no sound output if connected to an AV amplifier with a built-in DTS decoder or MPEG decoder.

Connections to other equipment

(continued)

To connect the TV to a HDMI or a DVI device to the unit

The HDMI input receives digital audio and uncompressed video from a HDMI device or uncompressed digital video from a DVI device. When you connect to a DVI device with a HDMI-to-DVI adapter cable, it transfers only video signal. Separate analog audio cords are required.

Rear and Right of the unit

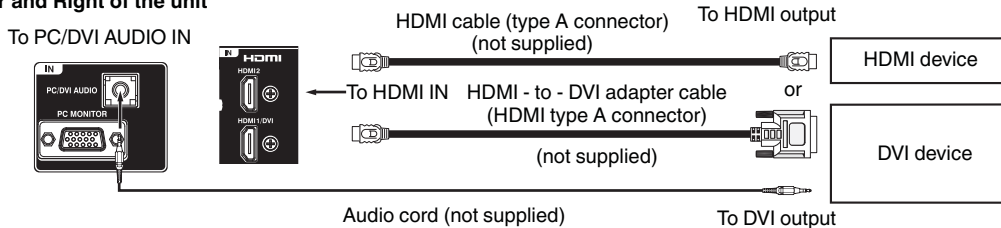

NOTE:

- When using HDMI1/DVI IN to connect your HDMI or DVI devices, you must select the corresponding audio input source (HDMI or DVI) on the menu screen (see page 15). Otherwise you will only see the image with no sound.

To connect the TV to a PC (Personal Computer)

BEFORE YOU CONNECT THIS TV TO YOUR PC, CHANGE THE ADJUSTMENT OF YOUR PC'S RESOLUTION AND REFRESH RATE (60 HZ).

Connect one end of a (male to male) VGA cable to the video cord of the computer and the other end to the VGA connector PC MONITOR IN on the rear of the TV. Attach the connectors firmly with the screws on the plug. In case of a Multimedia computer, connect the audio cord to the audio output of your Multimedia computer and to the AUDIO IN connector of the PC/DVI AUDIO IN jack of the TV. You can also connect the PC with HDMI cable. If you use HDMI cable, you don't have to connect the audio cord. If you use DVI-to-HDMI cable, please connect audio cord as same way as VGA cable.

Press **INPUT** on the remote control to select PC mode.

Switch on the computer. The TV can operate as the computer monitor.

Rear and Right of the unit

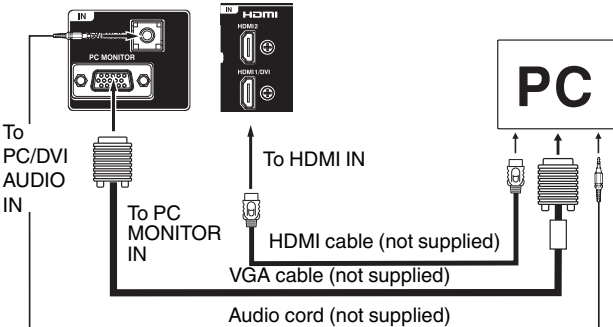

Monitor Display modes

Mode	Resolution	Refresh rate
VGA	640x480	60/ 72/ 75 Hz
VGA	720x400	70Hz
SVGA	800x600	56/ 60/ 72/ 75 Hz
XGA	1024x768	60/ 70/ 75 Hz
WXGA	1280x768	60Hz
WXGA	1280x720	60Hz
*SXGA	1280x1024	60Hz
*WXGA+	1440x900	60Hz
*FHD	1920x1080	60Hz

* LE39S406/LE39H316 only

To return to normal mode

Press **INPUT** again.

NOTE:

- The on-screen displays will have a different appearance in PC mode than in TV mode.
- If there is no video signal from the PC when the unit is in PC mode, "No signal" will appear on the TV-screen.
- LE39S406/LE39H316: When the PC connected to the HDMI terminal and 1920x1080 resolution (FHD) is selected, the top and bottom, right and left edges of the picture may be hidden on all aspect. In this case, use the PC MONITOR IN jack (VGA cable) is recommended to connect.
- LE39S406/LE39H316: When the PC's resolution is set to 1920 x 1080/60 Hz (FHD mode), a signal that differs from the FHD signal, which has been confirmed operational on this TV, may appear depending on the PC used. In this case, "Auto Adjust" or other position adjustment functions may fail to correct the image position. To solve this problem, change the PC settings to select another resolution.

Reception disturbances



IGNITION NOISE:

Black spots or horizontal streaks may appear, picture may flutter or drift. Usually caused by interference from automobile ignition systems, neon lamps, electrical drills, and other electrical appliances.



GHOSTS:

Ghosts are caused by the television signal following two paths. One is the direct path and the other is reflected from tall buildings, hills or some other objects. Changing the direction or position of the antenna may improve reception. Ghosting may also be caused by defects in the antenna system such as unshielded leads or connecting several sets to the same antenna without using multiple antenna couplers.



SNOW:

If your receiver is located in the fringe area of a television station where the signal is weak, your picture may be marred by the appearance of small dots. When the signal is extremely weak, it may be necessary to install a special antenna to improve the picture.

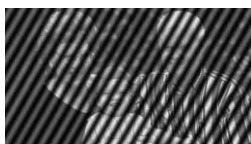

RADIO FREQUENCY INTERFERENCE:

The interference produces moving ripples or diagonal streaks, and in some cases, causes loss of contrast in the picture.

PREVENTION OF AN OBSTACLE TO RADIO RECEIVERS

This television has been designed pursuant to the FCC class B Rules. This is to prevent a problem to Radio receivers. If this television causes a problem to Radio receivers, then take the following steps:

- Keep the television away from Radio.
- Adjust Radio antennas in order for the television not to receive interference.
- The antenna cable of Radio should be kept away from the television.
- Use a coaxial cable for antenna.

You can check if this television influences Radio receivers by turning off all other equipment other than the television. If you find a problem receiving Radio when using the television, check the instructions mentioned above.



BLOCK NOISE or FREEZE (DIGITAL INPUT):

Fuzzy blocks may appear in some area or the whole area of the screen. This is usually caused by interference from automobile ignition systems, neon lamps, electrical drills, ghosting of the image and lost or weak receiving signals.

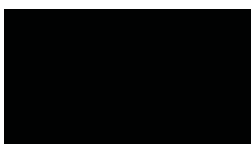

BLACK SCREEN:

When using an antenna, weak signals will display a black screen. It may be necessary to upgrade your antenna.

NOTE:

- The TV set can generate sound distortion in external devices such as a radio. Please separate radio equipment from the TV set to a considerable distance.

Troubleshooting

Use the following checklist for troubleshooting if you have problems with your TV. Consult your local dealer or service outlet if problems persist. Be sure all connections are properly made when using with other units.

SYMPTOMS	POSSIBLE SOLUTIONS
TV does not operate.	<ul style="list-style-type: none"> • Make sure the power cord is plugged in. • Try another AC outlet. • Power is off, check fuse or circuit breaker. • Unplug unit for an hour, then plug it back in.
Poor sound or no sound.	<ul style="list-style-type: none"> • Station or Cable TV experiencing problems, tune to another station. • Check sound adjustments (Volume or Mute). • Check for sources of possible interference.
Poor picture or no picture.	<ul style="list-style-type: none"> • Station or Cable TV experiencing problems, tune to another station. • Make sure channels are set into memory. • Check antenna or Cable TV connections, adjust antenna. • Check for sources of possible interference. • Check picture control adjustments.
Poor reception on some channels.	<ul style="list-style-type: none"> • Station or Cable TV experiencing problems, tune to another station. • Make sure channels are set into memory. • Station is weak, adjust antenna to receive desired station. • Check for sources of possible interference.
Poor color or no color.	<ul style="list-style-type: none"> • Station or Cable TV experiencing problems, tune to another station. • Make sure channels are set into memory. • Check picture control adjustments. • Check antenna or Cable TV connections, adjust antenna. • Check for sources of possible interference.
Picture wobbles or drifts.	<ul style="list-style-type: none"> • Station or Cable TV experiencing problems, tune to another station. • Make sure channels are set into memory. • Cable TV company is scrambling signal. • Adjust antenna.
Digital broadcasting screen problem.	<ul style="list-style-type: none"> • Check digital signal strength.

SYMPTOMS	POSSIBLE SOLUTIONS
No CATV reception.	<ul style="list-style-type: none"> • Check all Cable TV connections. • Set Air/Cable menu option to the Cable mode. • Station or Cable TV system problems, try another station.
Horizontal or diagonal bars on screen.	<ul style="list-style-type: none"> • Check antenna connections, adjust or re-direct antenna. • Check for sources of possible interference.
No reception above channel 13.	<ul style="list-style-type: none"> • Make sure Source option is in the appropriate mode. • If using antenna, check UHF antenna connections.
No Remote operation.	<ul style="list-style-type: none"> • Batteries are weak, dead or inserted incorrectly. • Remote is out of range, move closer to TV (within 15 feet). • Make sure Remote is aimed at sensor. • Confirm there are no obstructions between the Remote and the TV. • Make sure the power cord is plugged in.
TV shuts off.	<ul style="list-style-type: none"> • Sleep Timer is set. • Power interrupted.
Closed Caption is not activated.	<ul style="list-style-type: none"> • TV station experiencing problems or program tuned is not closed captioned. Try another channel. • Check Cable TV connection or VHF/UHF antenna, reposition or rotate antenna. • Set Closed Caption Decoder in the menu.
TV is not shown in your language.	<ul style="list-style-type: none"> • Select proper language in the menu options.
Cannot delete E-POP.	<ul style="list-style-type: none"> • Set the "E-POP Demo" in the Auto Setup menu to "Off". • To access Auto Setup TV must be in the TV input.

FOR CUSTOMER SERVICE, ADDITIONAL SET-UP AND OPERATING ASSISTANCE, OR TO ORDER ACCESSORIES PLEASE CALL:

1-800-289-0981 (USA/CANADA), 01-800-703-0885 (MEXICO)

WHEN CALLING CUSTOMER SERVICE – PLEASE HAVE YOUR MODEL NUMBER READY

OR WRITE TO:
ORION SALES, INC.
 3471 N. UNION DR.
 OLNEY, ILLINOIS 62450

Specifications

	LE39S406/LE39H316	LE32S406/LE32H316
GENERAL		
Power supply	AC 120V, 60Hz	
Power consumption	Operation: 66W Standby: 0.3W	Operation: 56W
Weight	8.9 kg (19.7lbs)	6.0 kg (13.2lbs)
Dimensions	Width: 888 mm (35 inches) Height: 563.7 mm (22-1/4 inches) Depth: 190 mm (7-1/2 inches)	Width: 732.9 mm (28-7/8 inches) Height: 470.9 mm (18-9/16 inches) Depth: 170 mm (6-3/4 inches)
Operating temperature	5°C - 40°C	
Operating humidity	Less than 80% RH	
TELEVISION		
Panel size	39" class/38.57" diagonal (979.7mm)	32" class/31.51" diagonal (800.4mm)
Display method	Transmission TFT color LCD panel	
Number of Pixels	1920(H) x 1080(V)	1366(H) x 768(V)
Broadcasting system	US system M ATSC standard (8VSB), QAM	
Receiving channels	VHF 2-13 UHF 14-69 CATV 14-36 (A)-(W) 37-59 (AA)-(WW) 60-85 (AAA)-(ZZZ) 86-94 (86)-(94) 95-99 (A-5)-(A-1) 100-135 (100)-(135) 01 (4A)	
Tuner type	Frequency synthesized	
Inputs	Video: 1.0 V (p-p), 75 ohms Audio: -8 dBm/50k ohms Component video: (Y) 1.0 V (p-p), 75 ohms (Pb)/(Pr) 0.7 V (p-p), 75 ohms HDMI: HDMI compliant (type A connector) HDCP compliant E-EDID compliant Suggested scan rates: 480i, 480p, 720p, 1080i, 1080p HDMI Audio: 2-channel PCM 32/44.1/48 kHz sampling frequency 16/20/24 bits per sample PC Monitor: Mini-Dsub 15pin Antenna: VHF/UHF In 75 ohms coaxial	
Outputs	Audio: 0-600mV/1k ohm Digital audio: 0.5 V (p-p), 75 ohms terminated	
Speakers	40.6 mm x 121.9 mm (1-5/8 inches x 4-13/16 inches), 8 ohms x 2	
Audio output power	10.0W + 10.0W	5.0W + 5.0W
ACCESSORIES	Remote control Batteries (AAA) x 2 Stand Stand Screws (4x16mm (5/32x5/8 inches) x 4) Owner's Guide Quick Start Guide	

- Designs and specifications are subject to change without notice.
- For information on our other products, please visit our website at www.hitachi.us

HITACHI

LIMITED WARRANTY

39"/32" LED HDTV

ORION AMERICA, INC ("ORION") warrants this product to be free from manufacturing defects in material and workmanship under normal use and conditions for a period of 1 year from date of original purchase in the United States, Canada and Mexico.

Should service be necessary under this warranty for any reason due to a manufacturing defect or malfunction during the first 12 months from date of original purchase, ORION will provide carry-in service by an ORION authorized Independent Service Center at no charge. Also, if an original part fails due to manufacturing defect in material and workmanship within one year from date of original purchase we will replace the defective part, provided the defect or malfunction is verified along with dated proof of purchase.

There are ORION authorized Independent Service Centers located throughout the country. For the one nearest you, DIAL TOLL FREE: 1-800-289-0981 (USA/CANADA), 01-800-703-0885 (MEXICO). ORION will not be liable for damages incurred in shipment of the unit. If there are no ORION authorized Independent Service Centers in your area please call - 1-800-289-0981 (USA/CANADA), 01-800-703-0885 (MEXICO) for assistance.

Note: This warranty is void if the product is:

- (a) Damaged through negligence, misuse, abuse, or accident.
- (b) Used in a commercial application or rentals.
- (c) Modified or repaired by anyone other than an Independent Service Center authorized by ORION to effect warranty repairs to the class of product or by the ORION Factory Service Center.
- (d) Damaged because it is improperly connected to the equipment of other manufacturers.

This warranty does not cover:

- (a) Damage to equipment not properly connected to the product.
- (b) Costs incurred in the shipping of the product to an ORION authorized Independent Service Center or ORION Factory Service Center.
- (c) Damage or improper operation of unit caused by customer abuse, misuse, negligence, or failure to follow operating instructions provided with the product.
- (d) Ordinary adjustments to the product which can be performed by customer as outlined in the owner's manual.
- (e) Signal reception problems caused by external antenna or cable systems.
- (f) Removal and/or reinstallation of the unit to/from any mounting bracket.

THIS WARRANTY IS NON TRANSFERABLE AND APPLIES ONLY TO THE ORIGINAL PURCHASER AND DOES NOT EXTEND TO SUBSEQUENT OWNERS OF THE PRODUCT. ANY APPLICABLE IMPLIED WARRANTIES, INCLUDING THE WARRANTY OF MERCHANTABILITY, ARE LIMITED IN DURATION TO A PERIOD OF THE EXPRESS WARRANTY AS PROVIDED HEREIN BEGINNING WITH THE DATE OF ORIGINAL PURCHASE AT RETAIL AND NO WARRANTIES, WHETHER EXPRESS OR IMPLIED SHALL APPLY TO THIS PRODUCT THEREAFTER. ORION MAKES NO WARRANTY AS TO THE FITNESS OF THE PRODUCT FOR ANY PARTICULAR PURPOSE AND USE.

UNDER NO CIRCUMSTANCES SHALL ORION OR HITACHI AMERICA, LTD. OR ANY OF THEIR RESPECTIVE AFFILIATES, PARENT COMPANIES OR SUBSIDIARIES BE LIABLE FOR ANY LOSS, DIRECT, INDIRECT, INCIDENTAL, SPECIAL, OR CONSEQUENTIAL DAMAGE ARISING OUT OF OR IN CONNECTION WITH THE USE OF THIS PRODUCT.

THIS WARRANTY IS VALID ONLY IN THE UNITED STATES OF AMERICA AND MEXICO. THIS WARRANTY GIVES YOU SPECIFIC LEGAL RIGHTS, HOWEVER, YOU MAY HAVE OTHER RIGHTS WHICH MAY VARY FROM JURISDICTION TO JURISDICTION. SOME JURISDICTIONS DO NOT ALLOW LIMITATIONS ON IMPLIED WARRANTIES OR EXCLUSIONS OF CONSEQUENTIAL DAMAGES, THEREFORE THESE RESTRICTIONS MAY NOT APPLY TO YOU.

ORION AMERICA, INC.
3471 N. UNION DR.
OLNEY, ILLINOIS 62450

