

Table of Contents

Regulatory Information	3
Description of Warning Symbols	4
Safety Notices	5
Important Safety Instructions	6
Preface	9
Warranty and Service	9
1. Getting Started	12
1.1 Package Contents	12
1.2 Introducing the TV	13
1.2.1 Features	13
1.3 Control Panel	14
1.4 Input and Output Jacks	15
1.5 Remote Control	16
1.6 Inserting the Remote Control Batteries	19
2. Setting up your TV	21
2.1 Basic Connections	21
2.1.1 Power Connection	21
2.1.2 Connecting an Antenna or Cable TV	21
2.2 Connecting External Devices	22
2.2.1 Connecting to AV Devices	22
2.2.2 Connecting a VCR/ Set-top box/ DVD Player Using Video Inputs	23
2.2.3 Connecting a PC using VGA	24
2.2.4 Connecting a PC using DVI	24
2.2.5 Connecting HDMI	25
2.2.6 Connecting SPDIF	25
2.2.7 Connecting USB	26
2.3 Using the TV	26
2.3.1 Turning the TV On and Off	26
2.3.2 Switching Source Signals	26
2.3.3 Performing an Automatic Channel Search	26
2.3.4 Selecting Channels	27
2.3.5 Adjusting the Volume	27
2.3.6 Editing Channel Table	27
2.3.7 Viewing Images and Playing Music	27

Table of Contents

3. Adjusting On-Screen Display (OSD) Settings	29
3.1 OSD Setting Menus	30
3.2 Adjusting Video Settings	30
3.3 Adjusting Audio Settings	31
3.4 Adjusting TV Settings	32
3.5 Adjusting Setup Settings	33
3.6 Adjusting Parental Settings	34
4. Troubleshooting	35
5. Specifications	36
6. Appendix: Remote Control Guide	38
6.1 Introduction	38
6.1.2 Setting Program Codes	38
6.1.3 Searching Codes	39
6.1.4 Setting Volume Lock	40
6.1.5 Setting Channel Lock	40
6.1.6 Factory Setting Mode	41
6.1.7 Description	43
6.2 Other Descriptions	43
6.2.1 Double Clicking	43
6.2.2 Buttons Information	43
6.2.3 Power-out Protection Capability	43
6.3 Component Program Codes	44
7. Setting the TV on the Wall	51
8. Using the Cable Organizer	52



Regulatory Information

FCC Compliance Statement¹

This device complies with part 15 of the FCC Rules. Operation is subject to the following two conditions: (1) This device may not cause harmful interference, and (2) this device must accept any interference received, including interference that may cause undesired operation.

Additional Information

This equipment has been tested and found to comply with the limits for a Class B digital device, pursuant to part 15 of the FCC Rules. These limits are designed to provide reasonable protection against harmful interference in a residential installation. This equipment generates, uses and can radiate radio frequency energy and, if not installed and used in accordance with the instructions, may cause harmful interference to radio communications. However, there is no guarantee that interference will not occur in a particular installation. If this equipment does cause harmful interference to radio or television reception, which can be determined by turning the equipment off and on, the user is encouraged to try to correct the interference by one or more of the following measures:

- Reorient or relocate the receiving antenna
- Increase the separation between the equipment and receiver
- Connect the equipment into an outlet on a circuit different from that to which the receiver is connected
- Consult the dealer or an experienced technician for help

Warning: The Federal Communications Commission warns that changes or modifications of the equipment not expressly approved by the party responsible for compliance could void your authority to operate the equipment.

DOC Compliance Notice²

This digital apparatus does not exceed the Class B limits for radio noise emissions from digital apparatus as set out in the Radio Interference Regulations of the Canadian Department of Communications. This device complies with Canada ICES-003 Class B.

-
1. applies only to products purchased in the United States of America
 2. applies only to products purchased in Canada

Description of Warning Symbols

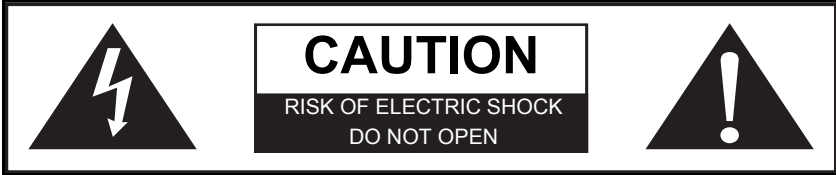

WARNING



This symbol is used to alert users to pay attention to important descriptions regarding usage, maintenance (repair), and additional important information related to this TV.

CAUTION



This symbol is intended to alert the user to the presence of uninsulated "dangerous voltage" within the product's enclosure that may be of sufficient magnitude to constitute a risk of electric shock to persons.

Safety Notices



Installation Safety Notes

Location

Avoid allowing the TV to get prolonged exposure to sunlight or other strong sources of heat. Leave sufficient distance between the TV and the wall to provide enough space for the emission of heat.



WARNING

To reduce the risk of fire or electric shock, do not expose this apparatus to rain or moisture.

Apparatus shall not be exposed to dripping or splashing and no objects filled with liquids, such as vases, shall be placed on the apparatus.

Notes:

- **The LCD TV is for entertainment use only and visual display tasks are excluded.**
- **This device uses a VGA connector to connect to a PC. To reduce the influence of main frequency on the source signal, use a VGA monitor cable with ferrite shield.**

Important Safety Instructions

	<ol style="list-style-type: none"> 1. Read these instructions. 2. Keep these instructions. 3. Heed all warnings. 4. Follow all instructions.
	5. Do not use this apparatus near water.
	6. Clean only with dry cloth.
	7. Do not block any ventilation openings. Install in accordance with manufacturer's instructions.
	8. Do not install near any heat sources such as radiators, heat registers, stoves, or other apparatus (including amplifiers) that produce heat.
	<p>9. Do not defeat the safety purpose of the polarized or grounding-type plug. A polarized plug has two blades with one wider than the other. A grounding-type plug has two blades and a third grounding prong. The wide blade or the third prong are provided for your safety. If the provided plug does not fit into your outlet, consult an electrician for replacement of the obsolete outlet.</p> <p>NOTE: Applies to US only.</p>
	10. Protect the power cord from being walked on or pinched, particularly at plugs, convenience receptacles, and the point where they exit from the apparatus.
	11. Only use attachments/accessories specified by the manufacturer.
	12. Use only with the cart, stand, tripod, bracket, or table specified by the manufacturer, or sold with the apparatus. When a cart is used, use caution when moving the cart/apparatus combination to avoid injury from tip-over.

13.	Unplug this apparatus during lightning storms or when unused for long periods of time.
14.	Refer all servicing to qualified service personnel. Servicing is required when the apparatus has been damaged in any way, such as power-supply cord or plug is damaged, liquid has been spilled or objects have fallen into the apparatus, the apparatus has been exposed to rain or moisture, does not operate normally, or has been dropped.
15.	WARNING: To reduce the risk of fire or electric shock, do not expose this apparatus to rain or moisture.
16.	The mains plug is used as the disconnect device and shall remain readily operable.
17.	The apparatus should be used in moderate climate.
18.	The apparatus shall not be exposed to dripping or splashing and that no objects filled with liquids, such as vases, shall be placed on the apparatus.

Personal safety

1. To avoid overloading the power supply, never plug too many electrical devices into an outlet, power strip, or extension cable.
 2. Dangerous high-voltage electric power components are located inside the TV. To avoid electric shock, do not disassemble the casing.
 3. Do not place or drop metals, small objects, or flammable materials into the vent of the TV.
 4. If the TV is dropped, falls down, or is otherwise damaged, unplug the power cord immediately and contact an authorized service technician.
 5. If any fluid is sprayed or dropped into the TV, contact an authorized service technician.
 6. The screen of the TV is made of glass. Avoid hitting or scraping it. If the screen is broken, do not touch the broken glass.
 7. Do not allow children to use the TV unattended.
 8. Be careful when disconnecting the power plug. Hold the plug. Do not attempt to disconnect the plug by pulling on the power cord.
-

Installation

1. Do not place the TV in locations where there is excessive steam or dust.
 2. Avoid blocking the TV's vents, do not place the TV on a bed, sofa, carpet, or in a sealed cabinet.
 3. Install the outdoor antenna away from power transmission lines to avoid possible danger.
-



Preface

Thank you for purchasing a Hannspree Liquid Crystal Display Television (LCD TV). Your new TV will allow you to enjoy superior audio and video while enriching your lifestyle with advanced technology.

Please carefully read this manual in its entirety before setting up, using or operating your TV. To ensure the safe and correct installation and operations of the TV, it is important that the safety and operation instructions in this manual are followed.

This instruction manual is designed to assist you in setting up and using the TV. The information in this manual has been carefully checked for accuracy; however, no guarantee is given to the correctness of the contents. The information in this manual is subject to change without notice.

To the extent allowed by applicable law, Hannspree, Inc. (“Hannspree”) shall not be liable for direct, indirect, special, exemplary, incidental or consequential damages arising from any defect or omission in this manual, even if advised of the possibility of such damages in advance.



Warranty and Service

For complete warranty service information, please refer to the “Warranty card” enclosed with your TV.

As an ENERGY STAR[®] Partner, Hannspree has determined that this product meets the ENERGY STAR[®] guidelines for energy efficiency.

Recycling Information

We care very much about our environment protection strategy and firmly believe that it helps us have healthier earth via appropriate treatment and recycling of industrial technology devices at the end-of-life.

These devices contain recyclable materials, which can be re-decomposed and re-integrated into brand-new marvels. On the contrary, other material can be classified to hazardous and poisoned substance.

We strongly encourage you to visit our website or call to find out recycling information and services available in your area.

<http://www.hannspree.com/us>

888.808.6789

Copyright

© Copyright 2010 Hannspree, Inc.

All rights reserved. This manual is protected by copyright and distributed under licenses restricting its use, copying and distribution. No part of this manual may be reproduced in any form by any means without the prior written authorization of Hannspree. The TV described in this manual may include copyrighted software of Hannspree (or other third parties). Hannspree (or other third parties) preserves the exclusive rights for copyrighted software, such as the right to distribute or reproduce the copyrighted software. Accordingly, and to the extent allowed by applicable law, any copyrighted software contained in the product described herein shall not be distributed, modified, reverse engineered, or reproduced in any manner without the prior written authorization of Hannspree (or of other third parties).

The Hannspree logos presented herein are trademarks of Hannspree. All other product names, trademarks or logos mentioned herein are used for identification purpose only, and may be the trademarks or registered trademarks of their respective owners.

The purchase of the product described herein shall not be deemed to grant, either directly or by implication, estoppel or otherwise, any license under the copyrights, patents, patent applications or trademarks of Hannspree, except for the normal, non-exclusive use that arises by operation of law in the sale of a product.

Trademark Notice

HDMI Hannspree products incorporate High-Definition Multimedia Interface (HDMI™) technology.

HDMI, the HDMI logo and High-Definition Multimedia Interface are trademarks or registered trademarks of HDMI Licensing LLC.

License Notice and Trademark Acknowledgment



Manufactured under license from Dolby Laboratories. Dolby and the double-D symbol are trademarks of Dolby Laboratories.



Getting Started

1.1 Package Contents

Make sure the following components are included in the box. Please contact Hannspree Customer Service immediately if anything is missing or damaged.

- TV
- Remote control and batteries
- User's Manual
- Quick Start Guide
- Warranty card
- HDMI cable

1.2 Introducing the TV

You can watch NTSC/ATSC broadcast, cable, or digital television channels, and easily connect a VCR, STB (set-top box), or DVD player to the standard AV (CVBS/Composite), Component (YPbPr), and HDMI input ports (location of these ports depends on model). You can also use the TV as a monitor for your PC by connecting it through the VGA or DVI port.

Convenient control buttons located on the TV and a handy remote control let you change channels, adjust the volume, and change display settings through an easy-to-use on-screen display menu system. The built-in stereo speakers provide full rich sound and a convenient audio output port lets you connect to an external audio system or earphones.

1.2.1 Features

- Built-in TV tuner
- Audio/ Video support:
 - PC audio input
 - Component (YPbPr) input
 - AV (Composite) input
 - VGA input
 - HDMI input
 - SPDIF digital audio output (Optical)
 - R/L audio inputs for AV and Component (YPbPr)
- On-Screen Display (OSD) menu system
- Built-in stereo speakers
- Digital Noise reduction
- 3D comb filter
- De-interlace Image
- 3:2/ 2:2 Pull down









Note:

The supporting devices mentioned in this manual may vary on different models.



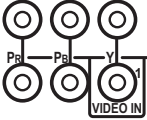
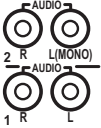

1.3 Control Panel





Description	Button	Function
Power		Press to turn the TV on or off.
Input source	INPUT	Press to open the input source list or mark an item on the OSD menu.
Menu	MENU	Press to open the OSD menu.
Channel select	CH ▲	Press to increase the channel number or move upward to the previous item on the OSD menu.
Channel select	CH ▼	Press to decrease the channel number or move downward to the next item on the OSD menu.
Volume adjust	VOL+	Press to increase the volume or move to the right on the OSD menu.
Volume adjust	VOL-	Press to decrease the volume or move to the left on the OSD menu.
Remote IR sensor		Receive incoming remote control commands.
Power/ Standby indicator		Indicate power or standby status.
Speakers		Deliver high-quality sounds.







1.4 Input and Output Jacks

Description	Connector	Function
Cable/ Antenna	CABLE/ ANTENNA 	Connect to an antenna or cable TV.
Digital Audio Out	 DIGITAL AUDIO OUT (OPTICAL)	Connect to a Sound Bar or a home theater system.
Audio Out	AUDIO OUT (FIX)  R L	Connect to external speakers with built-in amplifiers.
PC (VGA) IN	 PC IN	Connect to a PC's VGA port.
Audio IN (PC/HDMI 1)	AUDIO  PC/HDMI 1 AUDIO IN	Connect to a PC's audio port.
HDMI 1 input	1 	Connect to an external device, such as a DVD player, set-top box, or a PC's DVI/ HDMI port.
HDMI 2 input	2 	Connect to an external device, such as a DVD player, a set-top box, or a PC's DVI/ HDMI port.
Component inputs (video) x 2	 Pb Pr Y VIDEO IN	Connect to an external device, such as a VCR, set-top box, or a DVD player.
Component inputs (audio) x 2	AUDIO  2 R L (MONO) AUDIO 1 R L	Connect to an external device, such as a VCR, set-top box, or a DVD player.
USB	 USB	Support JPEG and MP3 files.

1.5 Remote Control

Description	Icon	Function												
Power		Press to turn the TV on or off.												
Input source	INPUT	Press to open the input source list.												
Keypad	<table border="0" style="text-align: center;"> <tr><td>1</td><td>2</td><td>3</td></tr> <tr><td>4</td><td>5</td><td>6</td></tr> <tr><td>7</td><td>8</td><td>9</td></tr> <tr><td>0</td><td></td><td></td></tr> </table>	1	2	3	4	5	6	7	8	9	0			Use to select a channel directly. Press 0-9 to enter the program numbers (press 1 and 0 for channel 10).
1	2	3												
4	5	6												
7	8	9												
0														
Program entry	—	Press this button for entering DTV minor channel.												
Last	LAST 	Press to return to the last channel selected.												
Information	INFO	Press to display program information.												
Menu	MENU	Press to enter/exit the on-screen display (OSD) menu.												
Arrows		Press up, down, left or right to scroll through the on-screen display menus.												
Select	OK	Press to confirm the TV source selection.												
Guide channel list	GUIDE	Press to view the Electronic Programming Guide screen.												
Return	RETURN	Press to return to the previous menu.												
Select channel	CH ▲ / CH ▼	Press  to increase the channel number. Press  to decrease the channel number.												
Volume adjust	VOL+ / VOL-	Press VOL + to increase audio volume. Press VOL - to decrease audio volume.												

Description	Icon	Function
Sleep timer	SLEEP 	Press repeatedly to set the sleep time (Off, 10, 20, 30, 40, 50, 60, 90, or 120 minutes). A Sleep Info appears on the middle of the screen to show the remaining time. Cancel the timer by pressing the button to sleep off mode.
Mute	MUTE 	Press to mute audio. Press it again or press the volume adjust buttons to restore sound.
Multichannel television sound	MTS 	Press to toggle the audio mode (Mono/ Stereo/ SAP) in ATV or the audio services in DTV.
DVD	DVD	Press to select a programmed DVD player.
AUDIO	AUDIO	Press to select a programmed Audio Receiver/ Amplifier/ Home Theater System.
CABLE	CABLE	Press to select a programmed cable TV or satellite TV set-top box.
TV	TV	Press to enter TV mode.
Favorite channels	FAV.	Press to switch to favorite channels.
Aspect ratio	ASPECT 	Press to adjust the width-to-height ratio of the image with aspect ratio Normal, Letterbox, Panorama, Zoom, and Dot by Dot.
Closed caption	C.C.	Press to open or close the closed caption.
Record		Press to record the program.

Description	Icon	Function
Pause		Press to pause playing.
Play		Press to start playing.
Stop		Press to stop playing.
Previous		Press to skip to the previous section.
Rewind		Press to go backward.
Fast-forward		Press to go forward.
Next		Press to skip to the next section.

Note:

- For best results, use the remote control within a proper distance from the front of the TV. Do not exceed an angle of 30 degrees when pointing at TV.
- The operational distance may be shortened when the signal sensor is directly exposed to strong light.
- Aim the transmitter on the remote control at the signal sensor and ensure that there are no obstacles between them.

1.6 Inserting the Remote Control Batteries

- 1 Open the battery compartment cover at the back of the remote control (A).

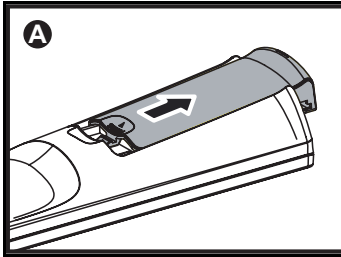

- 2 Insert the batteries paying attention to the polarity markings inside the battery compartment (B).

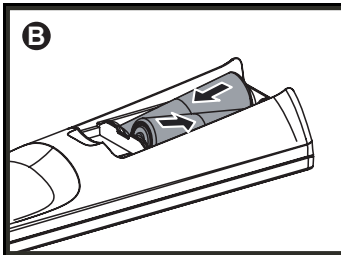

- 3 Close the battery compartment cover (C).

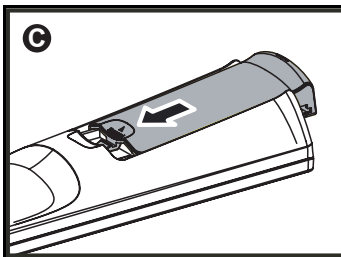



CAUTION

- If the remote control is not used for a long period, remove the batteries and store them properly.
- Handle damaged or leaking batteries carefully, and wash hands with soap if they come in contact with leaked chemical fluids.
- If your remote control has two batteries, do not mix new and old batteries, or the life of the new batteries will be shortened. Chemical fluids may leak from the old batteries.
- Danger of explosion if battery is incorrectly replaced. Replace only with the same or equivalent type recommended by the equipment manufacturer. Discard used batteries according to manufacturer's instructions.
- Refer to your local recycling or waste disposal rules and contact a local waste disposal vendor to dispose of used batteries.
- The remote control cover may have a magnet in it, so do not place magnetic sensitive items such as watches, credit cards, or flash media close to the cover.
- Do not use force when pulling the remote control cover open; you may damage the hinge.

2.1 Basic Connections

2.1.1 Power Connection

- 1 Connect the power cord to the AC IN input jack on the rear of the TV.
- 2 Plug the other end of the power cord into a power outlet.

2.1.2 Connecting an Antenna or Cable TV

Connect one end of the VHF/UHF (Antenna) or CATV cable to VHF/UHF jack on the rear of the TV.

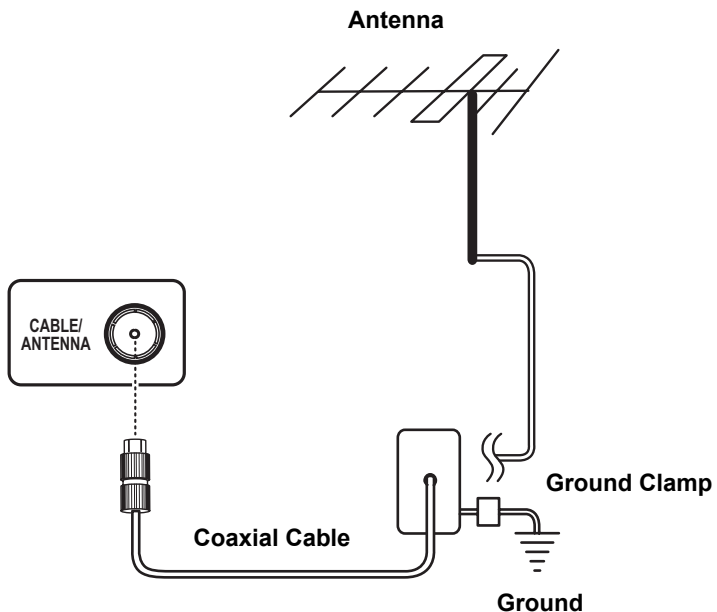
**Note:**

If you cannot receive channels after connecting to an antenna or cable TV line, try scanning for channels.

2.2 Connecting External Devices

Connect external devices such as VCRs, set-top box, DVD players, video game consoles, or a PC to the TV using the appropriate ports on the rear of the TV.

2.2.1 Connecting to AV Devices

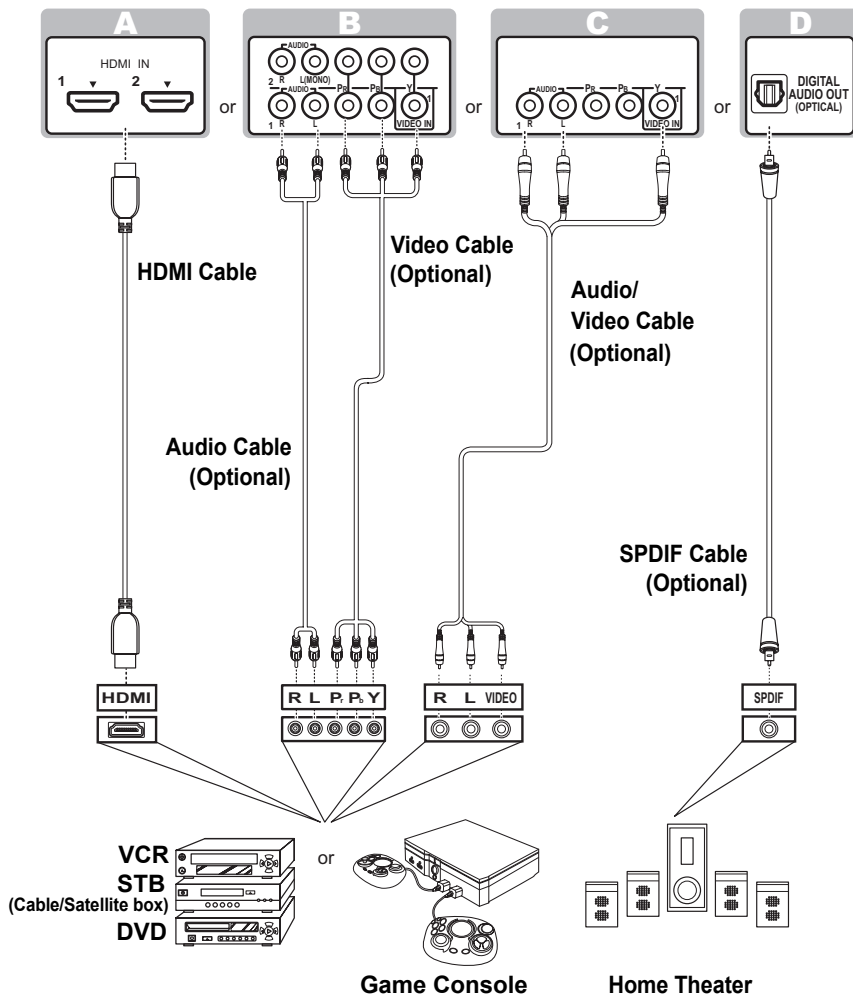

2.2.2 Connecting a VCR/ Set-top box/ DVD Player Using Video Inputs

Connect the TV to a VCR/set-top box/ DVD player using the video inputs.

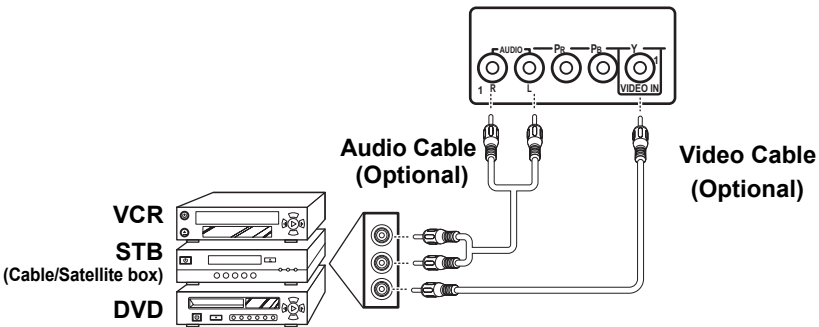
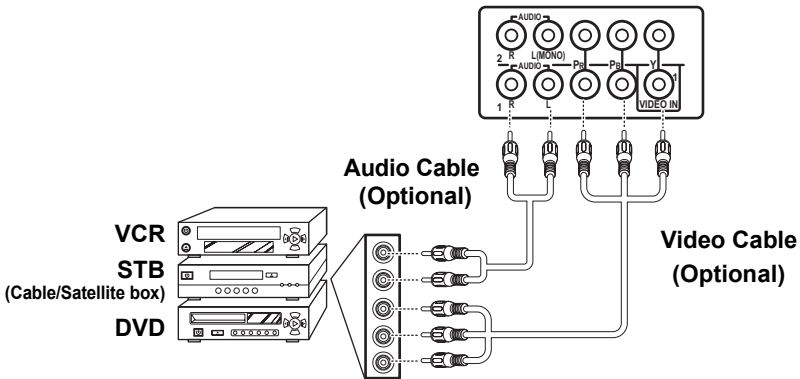

2.2.3 Connecting a PC using VGA

Connect the TV to your PC to use it as the monitor using the VGA port as shown.

- 1 Connect the VGA port of the TV to the VGA output of the PC.
- 2 Connect the PC AUDIO IN port of your TV to the line out port of the PC to listen to audio from the PC.

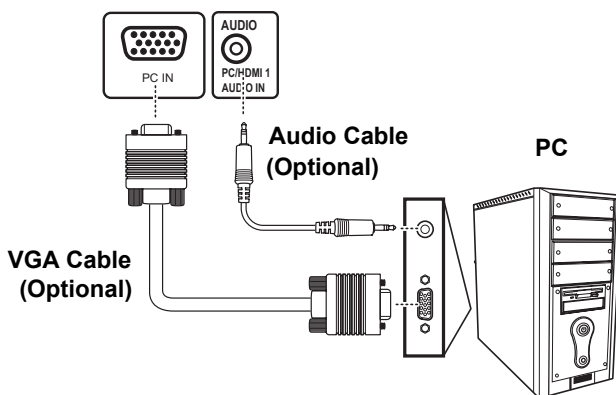

2.2.4 Connecting a PC using DVI

Connect the TV to your PC to use it as the monitor using the DVI port as shown.

- 1 Connect the HDMI 1 or HDMI 2 port of the TV to the DVI output of the PC.
- 2 Connect the PC AUDIO IN port of your TV to the line out port of the PC of your TV to listen to audio from the PC.

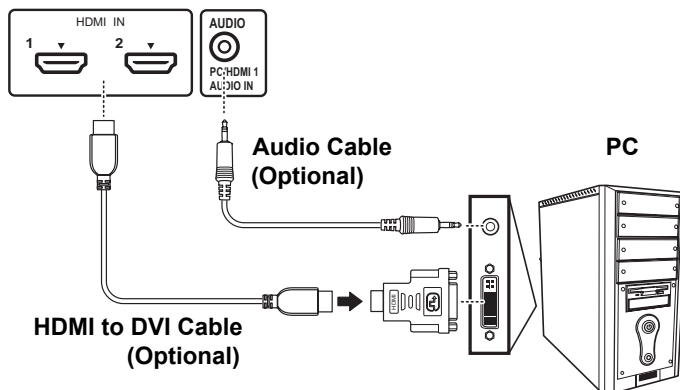

2.2.5 Connecting HDMI

HDMI (High Definition Multimedia Interface) assures that the best video signal is always sent from source to the TV.

Refer to the following illustration to connect an HDMI device to the TV.

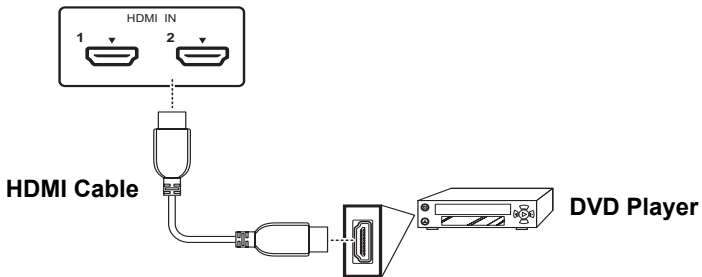

Note:
When the HDMI cable is connected, connecting the audio cable is not necessary. However, it is necessary to do so if an HDMI to DVI cable is connected.

2.2.6 Connecting SPDIF

The SPDIF output can be used to connect the TV to a sound bar or home theater system that supports Dolby Digital or DTS surround sound.

Refer to the following illustration to connect an SPDIF device to the TV.

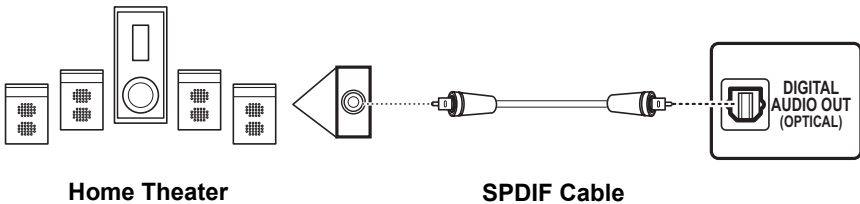

2.2.7 Connecting USB

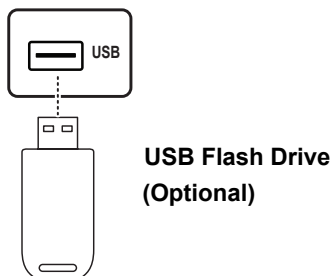

Connect the USB flash drive to the TV using the USB port as shown. The JPEG and MP3 files are supported.

**Note:**

The USB HDD (Hard Disk Drive) is not supported.

2.3 Using the TV

2.3.1 Turning the TV On and Off

- 1 Press  on the control panel or remote control. The power LED indicator on the TV changes from red to green, indicating that the TV is on.
- 2 Press  again. The power LED changes from green to red, indicating that the TV is off.

2.3.2 Switching Source Signals

Press **INPUT** on the control panel or remote control to select the incoming source signal to set TV source for channel search. Press **OK** to confirm.



2.3.3 Performing an Automatic Channel Search

Before using the TV to view programs, you need to activate the channel search first.





- 1 Press **MENU** on the control panel or remote control, then select to enter the TV menu.
- 2 Select **Tuner Mode** to set the signal source to **Antenna** or **Cable**.

- 3 Select **Channel Scan**.
- 4 Press **OK** on the remote control to run the channel search.

2.3.4 Selecting Channels

- Press **CH▲** on the control panel or  on the remote control to increase the channel number.
- Press **CH▼** on the control panel or  on the remote control to decrease the channel number.
- Enter the specific channel number by pressing the number buttons on the remote control.

2.3.5 Adjusting the Volume

- 1 Press **VOL+** on the control panel or  on the remote control to increase the volume.
- 2 Press **VOL-** on the control panel or  on the remote control to decrease the volume.
- 3 Press  to eliminate sounds, and press  again or press the volume buttons to restore the original volume.

2.3.6 Editing Channel Table

- 1 Press **MENU** on the control panel or remote control, then select to enter the TV menu.
- 2 Select **Channel Skip** and press **OK** to enter the Channel List.
- 3 Press **▲ / ▼** to select the desired channel.
- 4 Check/Uncheck the channel with **OK** to hide/show the channel.
- 5 Press **MENU** to exit.

2.3.7 Viewing Images and Playing Music

- 1 Insert the USB flash drive into the USB port.
- 2 Press **MENU** on the remote control, then select to enter the Video menu.
- 3 Select **Multimedia** and press **OK** to enter the Multimedia screen.

- 4 Press **MENU** on the remote control to select **Media Type** and press **OK**.
 - To view images, select **Photo** and press **OK**.
 - To play music, select **Music** and press **OK**.

NOTE: Only files matching the selected media type are displayed.
- 5 Use **^** / **v** / **<** / **>** to select the desired folder (if any) and the desired image/music file.
- 6 Press **OK** to play the selected music file or start off the slideshow with the selected image file.
 - During music playback, press **OK** to pause and press again to resume.
 - During slideshow, press **2** to switch the duration.
 - During slideshow, press **3** to switch the effect.
- 7 Press **RETURN** on the remote control to stop.
- 8 Press **MENU** on the remote control to exit.



3

Adjusting On-Screen Display (OSD) Settings

The On-Screen Display (OSD) menu system provides a quick and simple method to adjust the TV settings. The OSD menu can be accessed through the buttons either on the control panel or the remote control.

MAIN MENU:

Displays a list of menu items. The chosen item is marked by a different color than other menu items.

ADJUSTABLE ITEMS:

Displays the settings/ values of the adjustable items.

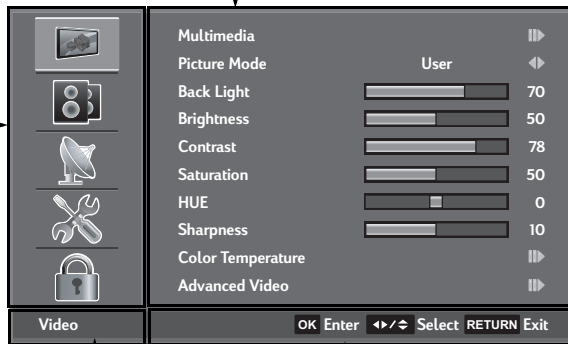

CURRENT MENU:

Displays the title of the currently chosen menu.

INSTRUCTIONS:

Quick instructions for adjusting the settings.

Function	TV Control Panel	Remote Control
OSD Menu	MENU	MENU
Up	CH ▲	Arrow ^
Down	CH ▼	Arrow v
Increase	VOL +	Arrow >
Decrease	VOL -	Arrow <
Select	INPUT/ VOL+	OK
Return	MENU/ VOL-	RETURN/ Arrow <

3.1 OSD Setting Menus

Follow the instructions indicated on the bottom of the OSD Function Menu. Press **CH ▲ / CH ▼** on the control panel or **▲ / ▼** arrow keys on the remote control to scroll through the menus. Press **INPUT** on the control panel or **OK** key on the remote control to select an item and then press **MENU** key to exit the OSD menu.

The following menus can be set by different adjustment methods.

3.2 Adjusting Video Settings

- 1 Press **MENU** to enter the OSD Main Menu screen.
- 2 Press **▲ / ▼** on the remote control to select Video menu.
- 3 Press **> / OK** on the remote control to enter the Video menu.

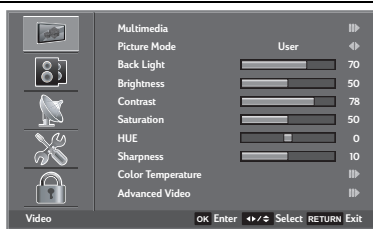

- 4 Press **▲ / ▼** on the remote control to select an item.
- 5 Press **< / >** on the remote control to change the scales or press **OK** on the remote control to enter an item.
- 6 Press **RETURN** to return to the Video menu.
- 7 Press **MENU** to exit the Video menu.

The Video menu can be used to adjust the **Multimedia**, **Picture Mode**, **Back Light**, **Brightness**, **Contrast**, **Saturation**, **HUE**, **Sharpness**, **Color Temperature**, **Advanced Video**, and **VGA** (VGA mode only) settings. **Back Light**, **Brightness**, **Contrast**, **Saturation**, **HUE**, **Sharpness**, and **Color Temperature** are only available for adjustments if you select **User** in Picture Mode. Press **< / >** on the remote control to adjust these settings.

- Multimedia can be used to access image and audio files on a USB flash drive.
- Picture Mode can be set to **Cinema**, **Sport**, **Vivid**, **Game**, or **User**.
- Advanced Video can be used to set **ANR**, **MPEG NR**, **Adaptive Luma Control**, **Flesh Tone**, and **Blue Stretch**.
- VGA can be used to set **Auto Adjust**, **H.Position**, **V.Position**, **Phase**, and **Clock**.

Note:

The items available on the OSD may vary depending on the input signal source.

3.3 Adjusting Audio Settings

- 1 Press **MENU** to enter the OSD Main Menu screen.
- 2 Press **^** / **v** on the remote control to select Audio menu.
- 3 Press **>** / **OK** on the remote control to enter the Audio menu.



- 4 Press **^** / **v** on the remote control to select an item.
- 5 Press **<** / **>** on the remote control to change the scales or select an option.
- 6 Press **RETURN** to return to the Audio menu.
- 7 Press **MENU** to exit the Audio menu.

The Audio menu can be used to adjust the **Balance**, **Bass**, **Treble**, **Sound Surround**, **Equalizer**, **Speaker**, **SPDIF Type**, and **Auto Volume Control** settings.

- Press **<** / **>** on the remote control to adjust the scales in **Balance**, **Bass**, and **Treble**.
- Sound Surround can be set to **On** or **Off**.
- Equalizer can be set to **Rock**, **Pop**, **Live**, **Dance**, **Techno**, **Classic**, or **Off**.
- Speaker can be set to **On** or **Off**.
- SPDIF Type can be set to **Dolby Digital**, **PCM**, or **Off**.
- Auto Volume Control can be set to **On** or **Off**.

Note:

The items available on the OSD may vary depending on the input signal source.

3.4 Adjusting TV Settings

- 1 Press **MENU** to enter the OSD Main Menu screen.
- 2 Press **^** / **v** on the remote control to select Channel menu.
- 3 Press **>** / **OK** on the remote control to enter the TV menu.

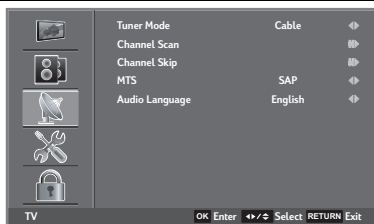

- 4 Press **^** / **v** on the remote control to select an item.
- 5 Press **<** / **>** on the remote control to enter an item or select an option.
- 6 Press **RETURN** to return to the TV menu.
- 7 Press **MENU** to exit the TV menu.

The TV menu can be used to adjust or perform **Tuner Mode**, **Channel Scan**, **Channel Skip**, **MTS**, and **Audio Language** options. Channel Scan can be used to perform the channel search (see “Performing an Automatic Channel Search” on page 26). Channel Skip can be used to edit the channel list (see “Editing Channel Table” on page 27).

- Tuner Mode can be set to **Antenna** or **Cable**.
- MTS can be set to **Mono**, **Stereo**, or **SAP**.
- Audio Language can be set to **English**, **Español**, or **Français**.

Note:

The Channel settings are available when the signal is set to TV source.

3.5 Adjusting Setup Settings

- 1 Press **MENU** to enter the OSD Main Menu screen.
- 2 Press **^** / **v** on the remote control to select Setup menu.
- 3 Press **>** / **OK** on the remote control to enter the Setup menu.
- 4 Press **^** / **v** on the remote control to select an item.
- 5 Press **<** / **>** on the remote control to enter an item or select an option.
- 6 Press **RETURN** to return to the Setup menu.
- 7 Press **MENU** to exit the Setup menu.

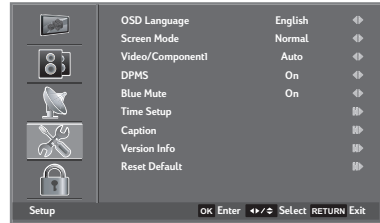

The Setup menu can be used to adjust the **OSD Language**, **Screen Mode**, **Video/Component1**, **DPMS**, **Blue Mute**, **Time Setup**, **Caption**, **Version Info**, and **Reset Default** settings.

- OSD language can be set to **English**, **Español**, or **Français**.
- Screen Mode can be set to **Normal**, **Letterbox**, **Panorama**, **Zoom**, or **Dot by Dot**.
- Video/Component1 can be set to **Auto**, **Video**, or **Component1**.
- DPMS can be set to **On** or **Off**.
- Blue Mute can be set to **On** or **Off**.
- Time Setup can be used to set **Time Zone**, **Time**, **Sleep Timer**, and **Auto Sleep**.
- Caption can be used to set **Analog Closed Caption**, **Digital Closed Caption**, and **Digital Caption Style**.
- Version Info can be used to view **Firmware Version** and **Panel Type**.
- Reset Default can be used to restore the factory defaults.

Note:

The items available on the OSD may vary depending on the input signal source.

3.6 Adjusting Parental Settings

- 1 Press **MENU** to enter the OSD Main Menu screen.
- 2 Press **^** / **v** on the remote control to select Parental menu.
- 3 Press **>** / **OK** on the remote control to enter the Parental menu.

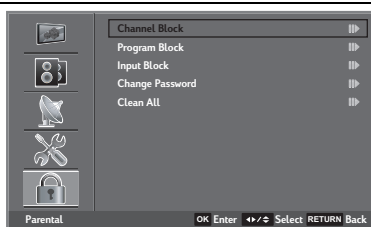

- 4 Enter the password to activate the Parental menu (the default is **1234**).
- 5 Press **^** / **v** on the remote control to select an item.
- 6 Press **>** / **OK** on the remote control to enter the item.
- 7 Press **OK** on the remote control to mark an item or press **^** / **v** on the remote control to select an option.
- 8 Press **RETURN** to return to the Parental menu.
- 9 Press **MENU** to exit the Parental menu.

The Parental menu can be used to adjust **Channel Block**, **Program Block**, **Input Block**, **Change Password**, and **Clean All** settings.

Situation	Solution
No picture and sound.	<ul style="list-style-type: none"> • Connect the power cord properly. • Check if the power LED is on or not. • Press  on the control panel or remote control. • Press INPUT to cycle through connected video sources. • Press channel up or channel down to switch to other TV channels. • Make sure all cables are connected properly.
No picture, or poor picture, sound is OK.	<ul style="list-style-type: none"> • Check the antenna and cable connections. • Adjust the brightness in the OSD menus.
Picture is not in color.	<ul style="list-style-type: none"> • Adjust the saturation in the OSD menus.
Picture is OK, no sound.	<ul style="list-style-type: none"> • Make sure the source device is functioning properly. • Make sure the audio cable is connected securely. • Turn the mute off. • Press volume up on the control panel or remote control.
One of the speakers has no sound.	<ul style="list-style-type: none"> • Adjust the balance in the OSD Audio menu.
Cannot receive some TV channels using cable TV.	<ul style="list-style-type: none"> • Try the Channel Scan function in the OSD TV menu.
Want to reset TV settings.	<ul style="list-style-type: none"> • Use the Reset Default function in the OSD Setup menu.
Cannot operate menus.	<ul style="list-style-type: none"> • If OSD items are colored in gray, the system is in a state such that those settings are not available.
Screen image turns over.	<ul style="list-style-type: none"> • Make sure the video signal cable is connected properly.
Snow appears on the screen.	<ul style="list-style-type: none"> • Adjust the location of the antenna, placing it far from roads or sources of interference. • Check the antenna and the video signal line connections.
Blurred or overlapped images.	<ul style="list-style-type: none"> • Adjust the sharpness setting. • Choose programs with high quality signals. • Adjust the direction of the antenna or change the video signal cable.
Remote control doesn't work.	<ul style="list-style-type: none"> • Make sure the battery is inserted correctly. • Replace the battery with a new one. • Make sure the TV power cord is plugged in securely. • Make sure the path between the remote control and the sensor is clear. • Try operating the remote control at a closer distance to the TV.

LCD Panel Size	32 inch TFT
Screen Format	16:9
Panel Resolution	1366 (H) x 768 (V)
TV System	ATSC/NTSC/Clear QAM
Video System	AV (CVBS) x1
	HDMI: HDMI 1 / HDMI 2
	HDTV (YPbPr) x2
	PC (VGA)
Photo System	USB (JPEG)
Audio System	AV: (RCA x1) R/L in
	HDTV: (RCAx2) R/L in
	HDMI: HDMI 1 / HDMI 2
	SPDIF Output
	PC Audio IN x1
	Audio Out x1
Built-in Stereo Amplifier Output	10 W x 2
Power Consumption	Power on 117W Standby Mode under 1W
Power Supply	AC Input: 120V~60Hz
Dimension W x H x D	31.34 in x 23.03 in x 9.45 in
Weight	24.03 lb (Max.)

PC Mode Support Timing

Mode	Resolution (active dot)	Horizontal Frequency (KHz)	Vertical Frequency (Hz)	Nominal Pixel Clock (MHz)	VGA	DVI to HDMI
VGA	640x480@60Hz	31.469	59.941	25.175	V	V
SVGA	800x600@60Hz	37.879	60.317	40.000	V	V
XGA	1024x768@60Hz	48.363	60.004	65.000	V	V
SXGA	1280x1024@60Hz	63.981	60.020	108.000	V	V
WXGA+	1440x900@60Hz	55.935	59.887	106.500	V	V
WSXGA+	1680x1050@60Hz	65.290	59.954	146.250	V	V
VESA	1920x1080@60Hz	67.500	60.000	148.500	V	V

Video Mode Support Timing

Resolution (active dot)	HDMI	YPbPr
640x480p@60Hz	V	
720x480i@60Hz	V	V
720x480p@60Hz	V	V
1280x720p@60Hz	V	V
1920x1080i@60Hz	V	V
1920x1080p@60Hz	V	V

Appendix: Remote Control Guide

6.1 Introduction

The electronic equipment type switch buttons are used for switching the current electronic equipment type on the remote control.

The remote control includes 4 electronic equipment types: DVD, AUDIO, CABLE and TV.

The remote control keypad matrix includes 4 electronic equipment type switch buttons (DVD, AUDIO, CABLE and TV). If switching the current electronic equipment is desired, just press the button of the electronic equipment type you wish to switch to, e.g., press the TV button for TV; the corresponding indicator light then comes on for 2 seconds then it goes off after, and now the current electronic equipment mode has been switched to TV.

6.1.2 Setting Program Codes

Electronic equipment code setting mode is used for setting electronic equipment codes for various types of electronic equipment. Electronic equipment codes are 4 digits. Electronic equipment codes can be looked up in the electronic equipment code list of the appendix.

Electronic equipment code setting mode has the following operating procedures:

1. Select a 4-digit code from the list (start from the first code if more than one).
2. Select the desired corresponding mode of electronic equipment type; for example, DVD players.
3. Press DVD button. The indicator light will come on for 2 seconds then it goes off; after 3 seconds, the indicator light will come on again, showing that the setting mode has been entered.
4. Hold the electronic equipment button, while pressing digit keys corresponding to the electronic equipment code in sequence. The indicator light will flash once each time when a digit was inputted, and if the indicator light does not come on again after going off, the input code is valid; if the indicator light comes on again after going off for 2 seconds, the code is invalid, and users will be prompted to input other electronic equipment codes.
5. During the setting process, releasing the electronic equipment button exits the setting mode immediately without changing the status prior to setting.

6. During the setting process, only digit keys '0' through '9' are valid inputs, while other buttons are deemed invalid and do not affect the code setting. For example, inputting "02" then pressing RETURN does affect the "02" already input.

6.1.3 Searching Codes

If the desired electronic equipment code for setting can not be found on the list in the appendix, try to use the code-searching function with operating procedures as follows:

1. Press the corresponding electronic equipment button. The indicator light will come on for 2 seconds then it goes off; after 3 seconds, the indicator light will come on again, showing that the setting mode has been entered.
2. Hold the electronic equipment button while pressing POWER, then input mode codes 9-9-9 in sequence. If the indicator light does not come on again after going off, the code setting is valid; otherwise the indicator light comes on again after going off for 6 seconds, prompting user to re-enter mode codes.
3. If setting is successful, the electronic equipment code-searching state is entered upon releasing the electronic equipment button. The POWER signal of all manufacturers' codes under the current electronic equipment mode is then transmitted automatically every 5 seconds.
4. During search, the indicator light will flash when the POWER signal of each electronic equipment is transmitted. When one cycle of code-searching is complete, the indicator light will come on for 6 seconds before going off, exiting search mode automatically.
5. Pressing CH+/CH- during search transmits the next/previous electronic equipment POWER signal without waiting for 5 seconds, and resets the timer to trigger another 5 seconds interval.
6. Pressing POWER during search exits search mode without saving the new electronic equipment code; pressing OK during search saves the most recently searched electronic equipment code and then exits search mode.
7. Buttons other than POWER, OK, and CH+/CH- are not functional during search.

6.1.4 Setting Volume Lock

Operating procedures are as follows:

1. Press the corresponding electronic equipment button. The indicator light will come on for 2 seconds then it goes off; after 3 seconds, the indicator light will come on again, showing that the setting mode has been entered.
2. While holding the electronic equipment button, press VOL+ twice consecutively to assign volume lock to that electronic equipment (meaning the volume buttons will only transmit code values to the assigned electronic equipment even under other electronic equipment modes). The indicator light then goes off and setting mode is exited.
3. While holding the electronic equipment button, press VOL- twice consecutively to cancel volume lock under current mode (for example, if volume lock was set under TV mode and you wish to transmit code values under current DVD mode, just perform this unlock operation, while those electronic equipment modes not operated still have volume locked up). The indicator light then goes off and setting mode is exited.
4. During the setting process, releasing the electronic equipment button exits the setting mode immediately without changing the status prior to setting.
5. Buttons other than VOL+/VOL- are not functional during search. Volume buttons include VOL+, VOL- and MUTE.

6.1.5 Setting Channel Lock

Operating procedures are as follows:

1. Press the corresponding electronic equipment button. The indicator light will come on for 2 seconds then it goes off; after 3 seconds, the indicator light will come on again, showing that the setting mode has been entered.
2. While holding the electronic equipment button, press CH+ twice consecutively to assign channel lock to that electronic equipment (meaning the channel buttons will only transmit code values to the assigned electronic equipment even under other electronic equipment modes). The indicator light then goes off and setting mode is exited.
3. While holding the electronic equipment button, press CH- twice consecutively to cancel channel lock under current mode (for example, if channel lock was set under TV mode and you wish to transmit code values under current CABLE mode, just

perform this unlock operation, while those electronic equipment modes not so operated still have channel locked up). The indicator light then goes off and setting mode is exited.

4. During the setting process, releasing the electronic equipment button exits the setting mode immediately without changing the status prior to setting.

5. Buttons other than CH+/CH- are not functional during search. Channel buttons include CH+ and CH-.

6.1.6 Factory Setting Mode

Factory setting operation procedures are as follows:

1. Press the corresponding electronic equipment button. The indicator light will come on for 2 seconds then it goes off; after 3 seconds, the indicator light will come on again, showing that the setting mode has been entered.

2. While holding the electronic equipment button, first press < (left arrow), then press OK. The indicator then goes off and setting mode is exited, showing factory setting has been restored.

3. During the setting process, releasing the electronic equipment button exits the setting mode immediately without changing the status prior to setting.

4. Pressing any of the electronic equipment buttons to enter factory setting operation mode.

5. The default current electronic equipment is TV upon first power-on.

Electronic equipment	Code	Note
TV	1001	Provided by manufacturer
CABLE	--	Transmit TV code
AUDIO	--	Transmit TV code
DVD	--	Transmit TV code

6. Default volume lock setting:

Electronic equipment	VOL+, VOL- and Mute	Note
TV	Transmit TV code	Provided by manufacturer
CABLE	Transmit CABLE code	Unlocked
AUDIO	Transmit AUDIO code	Unlocked
DVD	Transmit DVD code	Unlocked

7. Default channel lock setting:

Electronic equipment	CH+ and CH-	Note
TV	Transmit TV code	Provided by manufacturer
CABLE	Transmit CABLE code	Unlocked
AUDIO	Transmit AUDIO code	Unlocked
DVD	Transmit DVD code	Unlocked

Note:

Each re-powering restores factory setting, and all electronic equipment modes transmit TV-mode infrared (IR) signal until being set up through code setting. For example, setting the electronic equipment code of CABLE as '0001' stops transmitting TV code, whereas AUDIO and DVD continue to transmit TV code.

6.1.7 Description

There is no multi-function code setting operation under TV mode but a fixed code for the TV manufacturer. Therefore, code setting and code-searching functions are disabled under this mode; other functions such as volume lock, channel lock and code display are operable.

6.2 Other Descriptions

6.2.1 Double Clicking

At any time, only when a single button is pressed, the corresponding code is just output. Two or more buttons simultaneously pressed do not output any code.

6.2.2 Buttons Information

Except TV equipment, all the buttons on remote controls corresponding to other electronic equipments (AUDIO, CABLE, and DVD) are not necessarily functional, but most of those remote controls only include power control, channel control, volume control, etc.

6.2.3 Power-out Protection Capability

During battery replacement, all settings are only maintained by external capacitors. Data therefore may be lost after power-out, and factory setting will be restored.

6.3 Component Program Codes

Setup Code for VCR's	
ABC	2102
Admiral	2012, 2022
Aiko	2025
Aiwa	2005, 2027
Alienware	2102
America Action	2025
American High	2004
Amoisonic	2027
Anam	2020, 2005, 2024, 2025
Anam National	2020
Asha	2024
Audiovox	2005, 2025
Beaumarck	2024
Bell & Howell	2017
Broksonic	2021, 2018, 2022, 2001, 2027
Calix	2005
Cannon	2004
Carver	2016
CCE	2015, 2025
Changhong	2012, 2016
Citizen	2005, 2025
Colt	2015

Setup Code for VCR's	
Craig	2005, 2011, 2024, 2015
Curtis Mathes	2913, 2004, 2020
Cybernex	2024
CyberPower	2102
Daewoo	2010, 2017, 2025
Dell	2102
Denon	2008
Direc TV	2059
Durabrand	2007, 2006
Electrohome	2005
Electroponic	2005
Emerex	2002
Emerson	2004, 2005, 2021, 2024, 2010, 2018, 2009, 2022, 2001, 2025, 2027
Fisher	2011, 2017
Fuji	2004, 2003
Fujitsu	2010
Gateway	2102
GE	2013, 2004, 2024
General	2010
Go Video	2026

Setup Code for VCR's	
GoldStar	2005, 2022, 2006, 2023
HaoJie	2024
Harman/ Kardon	2016, 2006
Harwood	2015
Hewlett Packard	2102
HI-Q	2011
Hitachi	2005, 2008
Howard Computers	2102
HP	2102
Hughes Network Systems	2008, 2059
iBUYPOWER	2102
JVC	2010, 2014
KEC	2005, 2025
Kenwood	2014, 2006
KLH	2015
Kodak	2004, 2005
Kolin	2009
LG	2005, 2010, 2008, 2022, 2006
Logik	2015
LXI	2005
Magnavox	2004, 2007, 2016

Setup Code for VCR's	
Magnin	2024
Marantz	2004, 2016
Marta	2005
Matsushita	2004, 2020
Media Center PC	2102
MEI	2004
Memorex	2004, 2020, 2005, 2012, 2007, 2011, 2024, 2017, 2022, 2027
MGA	2024, 2009
MGN Technology	2024
Microsoft	2102
Mind	2102
Minolta	2008
Mitsubishi	2014, 2009
Motorola	2004, 2012
MTC	2024
Multitech	2015
NEC	2004, 2005, 2012, 2017, 2014, 2006
Newave	2005
Nikko	2005
Noblex	2024
Northgate	2102

Setup Code for VCR's	
Olympus	2004
Optimus	2087, 2020, 2005, 2012, 2017, 2026
Orion	2021, 2022, 2001, 2027
Panasonic	2087, 2004, 2020, 2043, 2023
Penney	2004, 2005, 2024, 2008, 2006
Pentax	2008
Philco	2004, 2027
Philips	2004, 2016, 2059, 2044
Pilot	2005
Pioneer	2008, 2014
Polk Audio	2016
Profitronic	2024
Proscan	2013
Protec	2015
Puslar	2007
Qisheng	2013
Quasar	2004, 2020
Radix	2005
Randex	2005

Setup Code for VCR's	
RCA	2013, 2004, 2024, 2008, 2077
Realistic	2004, 2005, 2012, 2011, 2017
Replay TV	2043
Runco	2007
Sampo	2005, 2012
Samsung	2024, 2010, 2026
Sanky	2012, 2007
Sansui	2014, 2022, 2027
Sanyo	2011, 2024, 2017
Scolt	2021, 2010, 2018, 2009
Sears	2004, 2005, 2011, 2008, 2017
Sharp	2012, 2022
Shintom	2015
Shogun	2024
Singer	2015
Sonic Blue	2043
Sony	2004, 2002, 2003, 2048, 2102
STS	2008
Sylvania	2004, 2016, 2009

Setup Code for VCR's	
Tashiko	2005
Tatung	2010, 2014
Technics	2004, 2020
Teco	2004, 205, 2012, 2006
Teknika	2004, 2005
Tivo	2048, 2044, 2098, 2059
TMK	2024
Toshiba	2010, 2008, 2014, 2009, 2098, 2079, 2102
Totevision	2005, 2024
Touch	2102
Unitech	2024
Vector	2010
Vector Research	2006
Victor	2014
Video Concepts	2010
Videomagic	2005
Vidosonic	2024
Wards	2013, 2004, 2012, 2011, 2016, 2024, 2008, 2015
White Westinghouse	2022, 2015

Setup Code for VCR's	
XR-1000	2004, 2015
Yamaha	2006

Setup Code for DVD's	
Aiwa	2049
Akai	2062
Allegro	2076
Apex Digital	2053, 2058, 2067, 2086, 2066, 2084
Blaupunkt	2058
Blue Parade	2039
Broksonic	2055
Changhong	2046, 2086
CineVision	2076
Coby	2090
Curtis Mathes	2091
CyberHome	2082, 2081, 2094, 2070, 2093
Daewoo	2073, 2097, 2076
Denon	2028
DVD2000	2031
Emerson	2042, 2054
Enterprise	2042
Funai	2054
Gateway	2096, 2088
GE	2032, 2058

Setup Code for DVD's	
Go Video	2060, 2073, 2092, 2063, 2089, 2076, 2100
Greenhill	2058
Harman/Kardon	2041, 2057
Hitachi	2040, 2052
Hiteker	2053
Initial	2058
Integra	2046
JBL	2057
JVC	2038, 2045, 2075
Kenwood	2028, 2035
KLH	2085, 2080, 2095
Koss	2051
Lasonic	2068
LG	2042, 2076, 2069
Lite-ON	2096, 2085
Loewe	2030
Magnavox	2029, 2036, 2054
Marantz	2036
Memorex	2055
Microsoft	2032
Mintek	2058
Mitsubishi	2099, 2031
Nesa	2058

Setup Code for DVD's	
Norcent	2078
Onkyo	2029, 2046, 2064
Oritron	2051
Panasonic	2028, 2101
Philips	2029, 2036, 2050
Pioneer	2033, 2039
Polaroid	2090, 2086
Polk Audio	2036
Portland	2062
Proscan	2032
Qwestar	2051
RCA	2032, 2039, 2058, 2072
Rio	2076
Rotel	2045
Sampo	2061, 2056
Samsung	2028, 2040, 2089, 2071
Sansui	2055
Sanyo	2055
Sharp	2047, 2061
Sharper Image	2093
Sherwood	2062
Shinco	2058
Shinsonic	2034
Sonic Blue	2076, 2092

Setup Code for DVD's	
Sony	2034, 20864, 2083
SVA	2085
Sylvania	2054
Symphonic	2054
Teac	2058
Technics	2028
Theta Digital	2039
Toshiba	2029, 2055
V, Inc.	2019
Urban Concepts	2029
Xbox	2032
Yamaha	2028, 2036, 2037
Zenith	2029, 2042, 2076

Setup Code for Cable	
ABC	0002, 0003, 0006
Americast	0039
Bell & Howell	0006
Bell South	0039
Clearmaster	0038
ClearMax	0038
Coolmax	0038
Daeryung	0059, 0037, 0020, 0003

Setup Code for Cable	
Digi	0024
Diector	0019
Dumont	0024
Gehua	0019
General Instrument	0019, 0033, 0015, 0002, 0006
GoldStar	0010
Hamlin	0004, 0014
Hitachi	0006
Jerrold	0019, 0033, 0015, 0002, 0005, 0006
KNC	0003
LG	0010
Memorex	0001
Motorola	0019, 0033, 0015, 0046, 0050
MultiVision	0005
Pace	0059, 0012
Panasonic	0001, 0003, 0008
Panther	0024
Paragon	0001
Philips	0017, 0049
Pioneer	0059, 0037, 0010, 0022
Pulsar	0001
Quasar	0001
RadioShack	0038

Setup Code for Cable	
Regal	0016, 0014
Runco	0001
Samsung	0001, 0010
Scientific Atlanta	0059, 0037, 0020, 0003
Sony	0041
Starcom	0002, 0006
Supercable	0015
Supermax	0038
Tocom	0005
Torx	0002
Toshiba	0001
Trans PX	0015
Tristar	0038
TS	0002
V2	0038
Viewmaster	0038
Vision	0038
Vortex View	0038
Zenith	0001, 0021, 0039

Setup Code for Satellite	
AlphaStar	0030
Chaparral	0011
Crossdigital	0043

Setup Code for Satellite	
DirecTV	0018, 0023, 0025, 0044, 0013, 0029, 0057, 0028, 0034, 0058, 0060, 0043, 0007, 0051, 0056, 0053, 0052, 0042
Dish Network System	0040, 0031, 0054
Dishpro	0040, 0031, 0054
Echostar	0040, 0031, 0054
Expressvu	0031
GE	0023
General Instrument	0036
GOL	0031
Hisense	0055
Hitachi	0034
HTS	0031
Hughes Network Systems	0044, 0029, 0057, 0053
I-Lo	0055
JVC	0031
LG	0052, 0045
Magnavox	0028, 0027
Memorex	0028
Mitsubishi	0029
Motorola	0036
Next Level	0036

Setup Code for Satellite	
Panasonic	0013, 0026
Paysat	0028
Philips	0044, 0029, 0057, 0028, 0060, 0027, 0007, 0053
Proscan	0018, 0023
Proton	0055
RadioShack	0036
RCA	0018, 0023, 0035, 0009, 0051
Samsung	0047, 0043, 0042
Sony	0025, 0056
Star Choice	0036
Tivo	0044, 0053
Toshiba	0029, 0057, 0032, 0048
Ultimate TV	0056, 0051
Uniden	0028, 0027
US Digital	0055
USDTV	0055
Voom	0036
Zenith	0058

Setup Code for CD	
Aiwa	3019
Burmester	3027
California Audio Labs	3004

Setup Code for CD	
Carver	3019, 3022
Dkk	3001
DMX Electronics	3019
Dynamic Bass	3022
Fisher	3022
Garrard	3027
Genexxa	3005
Harman/ Kardon	3019, 3020
Hitachi	3005
Integra	3013
JVC	3009
Kenwood	3030, 3003, 3007, 3006, 3023
Krell	3019
Linn	3019
Magnavox	3019
Marantz	3030, 3004, 3019
MCS	3004
Miro	3001
Mission	3019
MTC	3027
NSM	3019
Onkyo	3013
Optimus	3001, 3005, 3007, 3027, 3022

Setup Code for CD	
Panasonic	3004
Parasound	3027
Philips	3030, 3019
Pioneer	3038, 3005
Polk Audio	3019
Proton	3019
QED	3019
Quad	3004
RCA	3038, 3005, 3027, 3022, 3008
Realistic	3027, 3022
Rotel	3019, 3027
SAE	3019
Sansui	3019
Sanyo	3022
SAST	3049
Sharp	3007
Silsonic	3006
Sonic Frontiers	3019
Sony	3028, 3001, 3012
TAG Mclaren	3019
Tascam	3027
Teac	3027
Technics	3004
Victor	3009
Wards	3019, 3008

Setup Code for CD	
Yamaha	3006
Zonda	3019

Setup Code for Audio Amp's	
Bose	3033
GE	3011
JVC	3059
NEC	3024
Optimus	3026
Realistic	3026
Shure	3024
Sony	3034
Soundesign	3011
Victor	3059
Wards	3011
Yamaha	3025, 3016

Setup Code for Audio Amp / Tuner's	
ADC	3029
Aiwa	3052, 3015
Anam	3057, 3039
Audiotronic	3042
Bose	3043
Capetronic	3027

Setup Code for Audio Amp / Tuner's	
Carver	3042
Denon	3051, 3040
Fonmix	3051
Harman/ Kardon	3014
Hitachi	3047
Integra	3017
JBL	3014
JVC	3010
Kenwood	3050, 3056
KLH	3053
Magnavox	3042, 3046, 3029
Marantz	3042, 3046
Onkyo	3035, 3017
Optimus	3036, 3018, 3002, 3031, 3029
Proscan	3044
Qisheng	3057
RCA	3036, 3057, 3044, 3029, 3039
Silsonic	3021
Sony	3037, 3054, 3045, 3058
Soundesign	3032
Stereophonics	2025
Sunfire	3050

Setup Code for Audio Amp / Tuner's	
Teac	3049
Technics	3043, 3055
Thorens	3042
Victor	3010
Wards	3002
Yamaha	3021, 3048, 3041

Setting the TV on the Wall

Disassembling the stand base:

- 1 Disconnect all the cables and cords from the TV to prevent breakage.
- 2 Carefully place the TV face down on a soft and flat surface (blanket, foam, cloth, etc) to prevent any damage to the TV.
- 3 Remove the three (3) screws so that the stand base can be removed.
- 4 Gently remove the stand base.

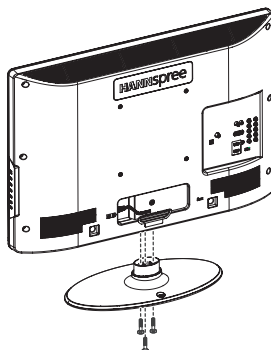

(For reference only)

Wall mounting the TV:

- 1 Purchase a VESA compatible wall bracket: VESA 200 X 200, 4 holes, M6, 12 mm, 20kg.
- 2 Locate your ideal TV position on the wall.
- 3 Fix the wall bracket firmly on the wall.
- 4 Secure the TV to the bracket using the 4 mount holes on the back and center of the TV.

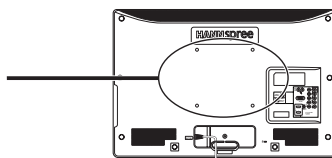

Note:

- Please read the instructions of your specific wall bracket to properly wall mount the TV.
- The pitch of the mounting holes is 200mm horizontally and 200mm vertically.
- The screws type required is metric: M6, 12mm length.
- The 32" TV stand base can be screwed on a table or a hard surface using the hole on the back of the stand base.

**Installing the LCD TV requires special skill that should only be performed by qualified service personnel. Customers should not attempt to do the work themselves. Hannspree bears no responsibility for improper mounting or mounting that results in accident or injury. You can ask a qualified service personnel about using an optional bracket to mount the TV to the wall.*

8

Using the Cable Organizer

- 1 Insert the cable clamp into the square hold on the rear of the TV.
- 2 Route the cables through the cable clamp.

