



Dear VIZIO Customer,

Congratulations on your new VIZIO SV472XVT HDTV purchase. To get the most out of your new VIZIO HDTV, please read these instructions before making any adjustments, and retain them for future reference. We hope you will experience many years of enjoyment from your new VIZIO VIA Connected High Definition Television.

For assistance, please call 877-MYVIZIO (877-698-4946) or e-mail us at www.VIZIO.com.

To purchase or inquire about accessories and installation services for your VIZIO HDTV, please visit our website at www.VIZIO.com or call toll free at (888) 849-4623.

You will register your VIZIO HDTV when you turn on your HDTV for the first time. You can also register on our website www.VIZIO.com. It is important to register your HDTV so you can receive future product updates and support information that will continually maximize the enjoyment of your HDTV.

For peace of mind and to protect your investment beyond the standard warranty, VIZIO offers on-site extended warranty service plans. These plans give additional coverage during the standard warranty period. Visit our website or call us to purchase a plan.

Write down the serial number located on the back of your HDTV for easy reference when obtaining warranty support:

Serial #: _____ Purchase Date _____

VIZIO is a registered trademark of VIZIO, Inc. dba V, Inc.

HDMI logo and "High Definition Multimedia Interface" are registered trademarks of HDMI Licensing LLC.

Manufactured under license from Dolby Laboratories.

Dolby and the double-D symbol are trademarks of Dolby Laboratories.



TruSurround HD and TruVolume are trademarks of SRS Labs, Inc.

TruSurround HD and TruVolume technologies are incorporated under license from SRS Labs, Inc.



This product qualifies for ENERGY STAR in the "factory default (Home Use)" setting and this is the setting in which power savings will be achieved. Changing the factory default picture setting or enabling other features will increase power consumption that could exceed the limits necessary to qualify for Energy Star rating.

THE TRADEMARKS SHOWN HEREIN ARE THE PROPERTY OF THEIR RESPECTIVE OWNERS; IMAGES USED ARE FOR ILLUSTRATION PURPOSES ONLY. BRAVO, VIZIO AND THE V LOGO AND WHERE VISION MEETS VALUE AND OTHER VIZIO TRADEMARKS ARE THE INTELLECTUAL PROPERTY OF VIZIO INC. PRODUCT SPECIFICATIONS ARE SUBJECT TO CHANGE WITHOUT NOTICE OR OBLIGATION. © 2008 VIZIO INC. ALL RIGHTS RESERVED.



Important Safety Instructions

Your HDTV is designed and manufactured to operate within defined design limits, and misuse may result in electric shock or fire. To prevent your HDTV from being damaged, the following instructions should be observed for the installation, use, and maintenance of your HDTV. Read the following safety instructions before operating your HDTV. Keep these instructions in a safe place for future reference.

- To reduce the risk of electric shock or component damage, switch off the power before connecting other components to your HDTV.
- Unplug the power cord before cleaning your HDTV. A damp cloth is sufficient for cleaning your HDTV. Do not use a liquid or a spray cleaner for cleaning your HDTV. Do not use abrasive cleaners.
- Always use the accessories recommended by the manufacturer to insure compatibility.
- When moving your HDTV from an area of low temperature to an area of high temperature, condensation may form in the housing. Wait before turning on your HDTV to avoid causing fire, electric shock, or component damage.
- Use only with the cart, stand, tripod, bracket, or table specified by manufacturer or sold with your HDTV. When a cart is used, use caution when moving the cart/HDTV combination to avoid injury from tip-over. Do not place your HDTV on an unstable cart, stand, or table. If your HDTV falls, it can injure a person and cause serious damage to your HDTV. Use only a cart or stand recommended by the manufacturer or sold with your HDTV.
- A distance of at least 3 feet should be maintained between your HDTV and any heat source, such as a radiator, heater, oven, amplifier etc. Do not install your HDTV close to smoke. Operating your HDTV close to smoke or moisture may cause fire or electric shock.
- Slots and openings in the back and bottom of the cabinet are provided for ventilation. To ensure reliable operation of your HDTV and to protect it from overheating, be sure these openings are not blocked or covered. Do not place your HDTV in a bookcase or cabinet unless proper ventilation is provided.
- Never push any object into the slots and openings on your HDTV cabinet. Do not place any objects on the top of your HDTV. Doing so could short circuit parts causing a fire or electric shock. Never spill liquids on your HDTV.
- Your HDTV should be operated only from the type of power source indicated on the label. If you are not sure of the type of power supplied to your home, consult your dealer or local power company.
- Do not apply pressure or throw objects at your HDTV. This may compromise the integrity of the display. The manufacturer's warranty does not cover user abuse or improper installations.
- The power cord must be replaced when using different voltage than the voltage specified. For more information, contact your dealer.
- Your HDTV is equipped with a **three-pronged grounded plug (a plug with a third grounding pin)**. This plug will fit only into a grounded power outlet. This is a safety feature. If your outlet does not accommodate the three-pronged, have an electrician install the correct outlet, or use an adapter to ground your HDTV safely. **Do not defeat the safety purpose of the grounded plug.**
- When connected to a power outlet, power is always flowing into your HDTV. To totally disconnect power, unplug the power cord.



- The lightning flash with arrowhead symbol within an equilateral triangle is intended to alert the user to the presence of un-isolated, dangerous voltage within the inside of your HDTV that may be of sufficient magnitude to constitute a risk of electric shock to persons.



- The exclamation point within an equilateral triangle is intended to alert the user to the presence of important operating and servicing instructions in the literature accompanying your HDTV.
- Do not overload power strips and extension cords. Overloading can result in fire or electric shock.



- The wall socket should be installed near your HDTV and easily accessible.
- Only power of the marked voltage can be used for your HDTV. Any other voltage than the specified voltage may cause fire or electric shock
- Do not touch the power cord during lightning. To avoid electric shock, avoid handling the power cord during electrical storms.
- Unplug your HDTV during a lightning storm or when it will not be used for long period of time. This will protect your HDTV from damage due to power surges.
- Do not attempt to repair or service your HDTV yourself. Opening or removing the back cover may expose you to high voltages, electric shock, and other hazards. If repair is required, contact your dealer and refer all servicing to qualified service personnel.
- Keep your HDTV away from moisture. Do not expose your HDTV to rain or moisture. If water penetrates into your HDTV, unplug the power cord and contact your dealer. Continuous use in this case may result in fire or electric shock.
- Do not use your HDTV if any abnormality occurs. If any smoke or odor becomes apparent, unplug the power cord and contact your dealer immediately. Do not try to repair your HDTV yourself.
- Avoid using dropped or damaged appliances. If your HDTV is dropped and the housing is damaged, the internal components may function abnormally. Unplug the power cord immediately and contact your dealer for repair. Continued use of your HDTV may cause fire or electric shock.
- Do not install your HDTV in an area with heavy dust or high humidity. Operating your HDTV in environments with heavy dust or high humidity may cause fire or electric shock.
- Follow instructions for moving your HDTV. Ensure that the power cord and any other cables are unplugged before moving your HDTV.
- When unplugging your HDTV, hold the power plug, not the cord. Pulling on the power cord may damage the wires inside the cord and cause fire or electric shock. When your HDTV will not be used for an extended period of time, unplug the power cord.
- To reduce risk of electric shock, do not touch the connector with wet hands.
- Insert batteries in accordance with instructions. Incorrect polarities may cause the batteries to leak which can damage the remote control or injure the operator.
- If any of the following occurs, contact the dealer:
 - The power cord fails or frays.
 - Liquid sprays or any object drops into your HDTV.
 - Your HDTV is exposed to rain or other moisture.
 - Your HDTV is dropped or damaged in any way.
 - The performance of your HDTV changes substantially.



Television Antenna Connection Protection

External Television Antenna Grounding

If an outside antenna/satellite dish or cable system is to be connected to the TV, make sure that the antenna or cable system is electrically grounded to provide some protection against voltage surges and static charges.

Article 810 of the National Electrical Code, ANSI/NFPA 70, provides information with regard to proper grounding of the mast and supporting structure, grounding of the lead-in wire to an antenna discharge unit, size of the grounding conductors, location of antenna discharge unit, connection to grounding electrodes, and requirements of the grounding electrode.

Lightning Protection

For added protection of the TV during a lightning storm or when it is left unattended or unused for long periods of time, unplug the TV from the wall outlet and disconnect the antenna or cable system.

Power Lines

Do not locate the antenna near overhead light or power circuits, or where it could fall into such power lines or circuits.

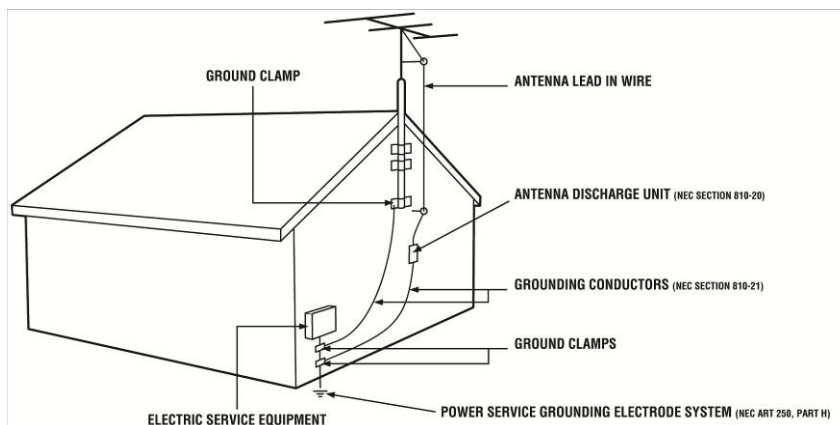

Remember, the screen of the coaxial cable is intended to be connected to earth in the building installation.

Advisory of the DTV Transition

The nationwide switch to digital television broadcasting was completed on June 12, 2009. Your VIZIO HDTV is capable of receiving Digital Broadcasts, and no Digital Converter Box is required.

For additional information, please contact the parties listed below, as appropriate:

FCC (US Federal Communications Commission)

<http://www.fcc.gov/>

Phone: 1-888-CALL-FCC (1-888-225-5322)

TTY: 1-888-TELL-FCC (1-888-835-5322)

Fax: 1-866-418-0232

E-mail: fccinfo@fcc.gov

NTIA (National Telecommunications and Information Administration)

<http://www.ntia.doc.gov/> 1-888-DTV-2009

Listings of US Television Stations: <http://www.high-techproductions.com/usTVstations.htm>



Table of Contents

Important Safety Instructions 2

Television Antenna Connection Protection 4

Advisory of the DTV Transition..... 4

Finding a Location for Your HDTV 9

Wall Mounting your HDTV 10

Attaching the safety strap..... 10

CHAPTER 1 BASIC CONTROLS AND CONNECTIONS..... 11

 Front Panel Controls..... 11

 Left-Side Panel Controls & Connections 11

 Rear Panel Connections..... 12

CHAPTER 2 VIZIO REMOTE CONTROL 13

 Installing the Batteries 13

 Activating Your Bluetooth Remote 13

 Remote Control Buttons 14

 Basic TV Functions 14

 A/V Functions..... 15

 VIA Functions..... 15

 Making it Your Universal Remote..... 16

 Remote Control Range..... 16

 VIZIO Remote Control Precautions..... 16

CHAPTER 3 GETTING STARTED..... 17

CHAPTER 4 USING YOUR HDTV FOR THE FIRST TIME 18

 Connecting to the Internet 18

 Selecting an Input Source 18

 Setting the Time Zone & Daylight Savings..... 18

 Watching a TV Program 19

 Viewing Digital TV Program Information 19

 INFO Button 19

 GUIDE Button 20

 Exploring VIZIO Internet Apps (VIA) 21

CHAPTER 5 CONNECTING EQUIPMENT 22

 Which Video Connection Should I Use? 22

 Connecting Your Cable or Satellite Box 23

 Using HDMI (Best)..... 23

 HDMI Connections for Cable or Satellite Boxes with DVI 23

 Using Component Video (Better)..... 24

 Using S-Video (Better)..... 24

 Using Composite Video (Compatible)..... 25

 Using Coaxial (Antenna) (Compatible) 25

 Connecting Your DVD Player 26

 Using HDMI (Best)..... 26

 HDMI Connections for DVD Players with DVI 26

 Using Component Video (Better)..... 27

 Using S-Video (Bette)..... 27

 Using Composite (AV) Video (Compatible) 28

 Connecting Coaxial (RF) 28

 Using Your Antenna or Digital Cable for Standard or Digital TV 28

 Connecting Your VCR or Video Camera..... 29

 Using S-VIDEO 29

 Using AV 29



Connecting a Home Theater System	30
Using RCA	30
Using Optical (SPDIF).....	31
Connecting a Computer.....	31
RGB (VGA)	31
Using HDMI.....	32
Ethernet Connection.....	32
CHAPTER 6 USING VIA	33
Connecting to the Internet.....	33
Navigating the VIA Dock	33
Using VIZIO Internet Apps (VIA)	34
Navigating Apps.....	34
Adding Apps.....	34
Deleting Apps.....	35
Moving Apps	35
Using Profiles.....	35
Creating a New Profile	35
Switching Profiles	36
Editing your Profile	36
Removing a Profile.....	36
Updating your TV.....	36
CHAPTER 7 ADJUSTING YOUR HDTV SETTINGS	37
Using the HDTV Settings App.....	37
Input Menu.....	37
Wide Menu	Error! Bookmark not defined.
CC Menu	38
Analog Closed Caption	39
Digital Closed Caption	39
Digital CC Style.....	39
Sleep Timer Menu	39
TV Settings Menu.....	40
Input Source.....	40
Picture.....	40
Picture Mode.....	40
Backlight.....	40
Brightness	40
Contrast.....	40
Color.....	40
Tint.....	40
Sharpness	40
Size & Position	41
Color Temperature	41
Advanced Picture	41
Reset Picture Mode.....	42
Audio.....	42
Audio Mode.....	42
Balance	42
Lip Sync	42
TV Speakers	42
Advanced Audio.....	42
Pick Device Type	43
Pick Device Brand.....	43
Confirm Remote Connection.....	43
Equalizer Settings	43
Reset Audio Mode.....	43
Tuner.....	44
Tuner Mode.....	44



Auto Channel Search	44
Partial Channel Search	44
Add Analog Channel	44
Skip Channel	44
Analog MTS	44
Digital MTS	44
Name Input	45
Device Setup	45
Input Source	45
Pick Device Type	45
Pick Device Brand	45
Confirm Remote Connection	46
Parental Controls	46
Rating Enable	46
Channel Locks	46
USA-TV	46
USA-Movie	47
CAN-English	47
CAN-French	47
Block Unrated Shows	47
Change PIN	48
RESET LOCKS	48
Menu Language	48
Time & Local Settings	48
Time Zone	48
Daylight Saving	48
Postal Code	48
PIP Menu	49
PIP Mode	49
PIP Source	49
Position	49
Size	49
Audio	49
Network Menu	50
Wired Connection	50
Manual Setup	50
Change Settings	50
Test Connection	50
Wireless Connection	50
Wireless Access Points	50
More Access Points	51
Manual Setup	51
Enter Access Point Name	51
Bluetooth Menu	51
Unpair Devices	51
Pair Devices	51
Help Menu	52
System Info	52
Reset All Settings/Presets	52
Clear Memory (Factory Default)	52
CHAPTER 8 MAINTENANCE AND TROUBLESHOOTING	53
Cleaning the TV and Remote Control	53
Troubleshooting Guide	53
TV/Display Troubleshooting	53
Audio Troubleshooting	56
Bluetooth Troubleshooting	56
VIZIO Internet Apps Troubleshooting	56
Remote Control Troubleshooting	57



Internet Connection Troubleshooting.....	57
Telephone & Technical Support.....	58
Compliance.....	58
FCC Class B Radio Interference Statement	58
CHAPTER 9 SPECIFICATIONS	59
Resolution through RGB Input	60
Preset PC Resolutions	61
Using a Cable or Satellite Box Remote	61
LIMITED PRODUCT WARRANTY	62
VIZIO RETURN POLICY	63
VIZIO INTERNET APPLICATIONS DISCLAIMER	65
VIZIO INTERNET APPLICATIONS SOFTWARE LICENSE AGREEMENT	65
INDEX	69

Opening the Package

Your HDTV and its accompanying accessories are carefully packed in a cardboard carton that has been designed to protect it from transportation damage. Once you have opened the carton, check that your HDTV is in good condition and that all of the contents are included.

The glass surface can easily be scratched or broken, so handle your HDTV gently and never place your HDTV with the glass facing downwards on a surface without protective padding.

IMPORTANT: Save the carton and packing material for future shipping.

Package Contents

- VIZIO SV472XVT
- VIZIO remote control VUR10, including full keyboard, IR, and Bluetooth
- AA batteries for the remote control (2)
- Power cord
- Safety Strap
- Cleaning Cloth
- This user manual
- Quick Setup Guide



Caution: Do not apply pressure or throw objects at your HDTV. This may compromise the integrity of the display. The manufacturer’s warranty does not cover user abuse or improper installations.



HDTV Accessories and Services

Additional certified accessories for your HDTV are sold separately, including:

- Wall mounts
- High Definition cables
- Extra or replacement remote controls
- Sound Bars
- Blu-ray DVD Players

VIZIO also offers installation services and extended warranty services for your HDTV.

To purchase or inquire about additional accessories and services for your VIZIO HDTV, visit our website at www.VIZIO.com or call us toll free at **877-MYVIZIO** (877-698-4946).

Finding a Location for Your HDTV

Here are some things you should consider when deciding on a proper location for your HDTV:

- The power consumption of your HDTV is about 130W (AVG).
 - Use the included power cord.
 - When an extension cord is required, use one with the correct power rating. The 3-pronged cord must be grounded and the grounding feature (3rd prong) must not be compromised.
- To take full advantage of your TV, you will need an Internet connection. Set up the Internet connection using the initial *Setup App* or the Network Menu in the *HDTV Settings App*. Your HDTV has 802.11n dual-band wireless built-in (which is also compatible with 802.11b and 802.11g wireless networks), so you can connect your TV to the Internet through your wireless home network. Or you can connect to the Internet by plugging in an Ethernet cable from your Internet connection to the Ethernet port on your HDTV. A wired connection may provide a more consistent connection depending on the conditions in your home environment. See *Network Menu* on page 50 for detailed information on setting up your Internet connection.
- Install your HDTV on a flat surface to avoid tipping.
- For proper ventilation, you must allow space between the back of your HDTV and the wall.
- Avoid installing your HDTV in places with high humidity, dust, or smoke so you do not shorten the service life of the electronic components.
- Install your HDTV in a level, landscape orientation, with the VIZIO logo at the bottom to prevent poor ventilation and excessive component damage.
- If you want to mount your HDTV on the wall, see below for additional information.
- Read this user manual carefully before installing your HDTV.

VIZIO offers professional installation services including home networking. Contact VIZIO for more information on these services at **877-MYVIZIO** (877-698-4946) or www.VIZIO.com.



Wall Mounting your HDTV

Your HDTV can be mounted on the wall for viewing. If you choose to mount your HDTV on the wall, follow the instructions below.

1. Write down the serial number located on the back of your HDTV: _____
2. Remove the stand base and neck:
 - a. Disconnect the cables from your HDTV.
 - b. Place your HDTV face down on a soft, flat surface to prevent damage to the screen.
 - c. Remove the eight (8) screws holding the stand neck, and then remove the neck and base. Pull straight down on the base after removing the screws to disconnect it from the TV.
3. Mount your HDTV on the wall:
 - a. Attach your HDTV to a wall mount (sold separately) using the mounting holes in the back panel of your HDTV.
 - b. Read the instructions that came with your specific wall mount to properly hang your HDTV.

Wall Mount Specs:

- Hole Pattern: 400mm x 200mm
- Screw Size: M6 Pitch 1.0mm



Attaching the safety strap

When your HDTV is not mounted on the wall, use the included safety strap to attach your HDTV to the wall to reduce the chance of your HDTV being pulled over. The Safety Strap should be used with common sense practice such as ensuring that children (or adults) do not climb up, grabbing the top of your HDTV and pulling it onto themselves.

1. Attach one end of the strap to the wall:
 - If you have a **drywall finish** attach it to a stud, using a washer underneath the screw head.
 - If you have a **solid wall** you should use a lag bolt, again using a washer under the nut.



2. Attach the other end of the Safety Strap to one of the upper wall mounting holes on the back of your HDTV, using a washer under the screw head.



Chapter 1 Basic Controls and Connections

Front Panel Controls

Power 'VIZIO' Light—When you first connect power or turn your HDTV off, wait for the VIZIO logo to stop flashing before pressing the power button on the TV or the remote control to turn your HDTV on. Once powered on, the VIZIO logo turns white.

Remote Control Sensor—When in IR mode, point the remote control at this sensor in the lower right-hand corner for the best response to the remote signal. Your remote control normally operates with Bluetooth which allows you to point the remote control anywhere to control the TV. You will pair (Activate) your remote during the initial setup procedure.



Left-Side Panel Controls & Connections



Power (⏻)—Turn your HDTV on by pressing the button once. Press the button again to your HDTV off.

VIA / MENU—Press to launch the VIZIO Internet Apps (VIA) Dock on the bottom of the TV, including the *HDTV Settings App*, used to make adjustments to your TV.

CH ▲ / ▼—Use these buttons to step up or down the TV channels. When in a menu, these buttons function as up and down navigation.

VOL + / -—Use these buttons to increase or decrease the speaker volume. When in a menu, these buttons function as left and right navigation.

INPUT—Repeated pressing of this button steps through the input sources in the following sequence: **TV**, **AV** (Composite), **COMP** (Component), **HDMI-1**, **HDMI-2**, **HDMI-3**, **HDMI side**, and **RGB** (VGA). Once you have stepped through the entire sequence, you will return to the beginning. When in a menu, this button functions as the **OK** or select control.

USB 1, 2, 3—These ports are currently for service only. Register your HDTV to receive future product updates including upgrades for these ports.

HDMI SIDE—Connect another digital video device such as a DVD player or set-top box through this all digital connector.



Rear Panel Connections

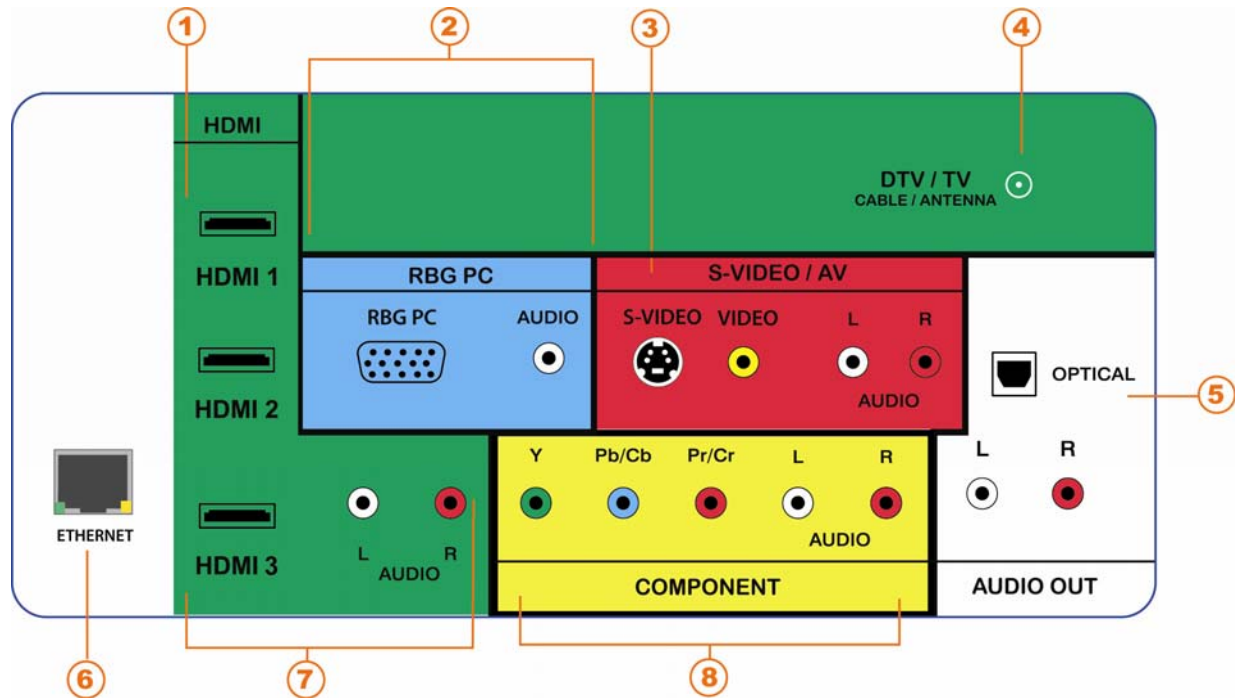

1. **HDMI 1 & 2**—Connect digital video devices such as DVD players or set-top box through these all digital connectors. There is an additional HDMI port on the side of your HDTV.
2. **RGB PC**—Connect the video and audio from a computer here. Connect a 1/8" mini plug stereo connector from the computer to the TV if you want sound to be transmitted.
3. **S-VIDEO/AV**—Connect composite or S-Video video devices, such as a VCR or game console. Use the white and red connectors to connect the external audio from the same source.
4. **DTV/TV**—Connect to an antenna or digital cable source for digital TV. For digital TV stations in your area visit www.antennaweb.org. For cable and satellite set-top boxes, we recommend that you use a HDMI or component cable connection for high definition image quality.
5. **AUDIO OUT**—
 - a. (OPTICAL) When digital TV is selected for viewing, the audio associated with the programming will be available on the SPDIF Optical connector for connection to a VIZIO Sound Bar or your home theater system.
 - b. (ANALOG L/R) Connect the audio from your HDTV to an external device, such as a VIZIO Sound Bar or a home theater system. Non-amplified speakers cannot be connected directly here.
6. **ETHERNET**—Connect an Ethernet cable to access the Internet. Set up the Internet connection using the initial *Setup App* or the Network Menu in the *HDTV Settings App*. Your HDTV also has 802.11n dual-band wireless, so you can connect your TV to the Internet through you wireless home network. See *Network Menu* on page 50 for detailed information on setting up your Internet connection.
7. **HDMI 3**—Connect another digital video device such as a DVD player or set-top box through this all digital connector. For users who want to connect to a DVI enabled device, use a DVI-HDMI cable and connect the analog audio output of the device to the L+R AUDIO here. Your VIZIO Certified HDMI and HDMI-DVI cables are available for purchase from www.VIZIO.com or by calling **877-MYVIZIO** (877-698-4946).
8. **COMPONENT (Y Pb/Cb Pr/Cr)**—Connect component video devices such as a DVD Player or cable/satellite set-top box here.



Chapter 2 VIZIO Remote Control

Your new VIZIO HDTV comes with an IR / Bluetooth-enabled universal remote that lets you interact with Internet content delivered to your HDTV. You can also use it to program other A/V devices connected to your TV, such as DVD or Blu-ray player, cable/satellite set-top box, DVR, home theater, and more.

Installing the Batteries

1. Remove the battery cover.
2. Insert two AA batteries into the remote control. Make sure that you match the (+) and (-) symbols on the batteries with the (+) and (-) symbols inside the battery compartment
3. Replace the battery cover.

Precautionary Tips for Inserting the Batteries:

- Only use quality AA batteries.
- Do not mix new and old batteries. This may result in cracking or leakage that may cause a fire or lead to personal injury.
- Inserting the batteries incorrectly may also result in cracking or leakage that may cause a fire or lead to personal injury.
- Dispose of batteries according to local hazardous waste regulations.
- Keep the batteries away from children and pets.



Activating Your Bluetooth Remote

You will activate your Bluetooth remote control in the *Setup App*. Follow the instructions on the screen to complete the activation.

You can also activate your remote control using your HDTV *Settings App*. See *Bluetooth Menu* on page 51 for detailed information on activating your remote control.



Remote Control Buttons

Basic TV Functions

INPUT—Press to cycle through the various devices connected to your TV (called Inputs). You can name your inputs when you set them up during the *HDTV Settings App*. The inputs cycle in the following sequence: **TV**, **AV** (Composite), **COMP** (Component), **HDMI-1**, **HDMI-2**, **HDMI-3**, **HDMI side**, and **RGB** (VGA). Once you have stepped through the entire sequence, you will return to the beginning.

Device Power (⏻ next to INPUT button)—Press to turn the device connected to the active input (i.e. HDMI, COMP) ON and OFF. The device must first be set up during the *Setup App* or using *Device Setup* in the *HDTV Settings App*.

Power (⏻ top right corner)—Press to turn the TV on from the standby mode. Press it again to return to standby mode.

LIST—Press to display a list of available channels. If a DVR has been programmed to work with this remote, this button will display the list of recorded programs.

INFO—Press to display program information. If a device has been programmed to work with this remote, this button will act as the INFO button for that device.

EXIT—Press to exit from open menus.

MENU—Press to launch the *VIZIO Internet Apps (VIA) Dock* on the bottom of the TV, including the *HDTV Settings App*, used to make adjustments to your TV. This button also opens the menu for the device connected to the active input (i.e. HDMI, COMP).

 Press to navigate open menus, adjust other TV settings such as brightness and contrast, or turn menu options on and off.

OK—Press to select an option in the menu.

BACK—Press to go back to the previous page in open menus.

GUIDE—Press to display detailed information when viewing a digital TV program.

YELLOW—Press to perform the same function as the “A” button on your cable/satellite box.

BLUE—Press to perform the same function as the “B” button on your cable/satellite box.

RED—Press to perform the same function as the “C” button on your cable/satellite box.

GREEN—Press to perform the same function as the “D” button on your cable/satellite box.

VOL ▲/▼—Press to turn the volume up or down.

VIA—Press to launch the *VIZIO Internet Apps (VIA) Dock* on the bottom of the TV, including the *HDTV Settings App*, used to make adjustments to your TV. This button also opens the menu for the device connected to the active input (i.e. HDMI, COMP).

MUTE—Press to turn the sound on and off.

LAST—Press to recall the previously viewed channel. Also, press repeatedly to go back to the previous menu screen or out to your program when you press it repeatedly.

CH ▲/▼—Press to change the channels up or down.

Number Button Pad—Press to select a channel or enter a password.



PIP—Press to activate the picture-in-picture feature. The screen will display the sub-screen in the corner over the main screen. Press it again to display the POP (Picture Outside Picture) option.

—(DASH)—Press to insert a dash between the main and sub-channels. For example, digital channel 28-2 would be selected by the button sequence 2, 8, DASH, 2.

A/V Functions

Use these buttons on your remote control to control your pre-programmed DVR, DVD Player or Cable/Satellite Box.

Fast Reverse (◀◀)—Press to reverse playback.

Pause (||)—Press to pause playback.

Play (▶)—Press to start playback.

Fast Forward (▶▶)—Press to skip to the next chapter.

(●)—Press to begin recording.

Stop (■)—Press to stop playback/recording.



VIA Functions

Use these buttons on your remote control to control the VIZIO Internet Apps (VIA) functions on your HDTV. See *Using VIA* on page 33 for more information about the VIA functions on your HDTV.

Press to switch between different video screen sizes when the Sidebar is open.

Press to exit an App or from the VIA Dock

Press to move or delete an App from the VIA Dock. Or, create a new App and add it to your VIA Dock.

Press to view settings for the active App

Press to launch the VIA Dock. The Apps in the dock let you watch movies, TV shows, listen to music, and much more.

Slide the keyboard open to input letters and characters in various Apps. You must activate your remote control during the initial Setup App that plays when you first turn on your TV in order to use the sliding keyboard.



Making it Your Universal Remote

The Setup App that runs when you first turn on your TV will help you set up your various devices that are connected to your HDTV, so that you can use your VIZIO remote control for all of your devices.

You can also set up your devices by accessing the *HDTV Settings App*. See *Device Setup* on page 45 for more information on setting up your remote.

Remote Control Range

When in IR mode (factory default):

- Point the remote control directly at this sensor for the best response to the remote signal.
- Do not place any obstacles between the remote control and the remote control sensor.
- The effective range of the remote control is approximately 30 feet (10 meters) from the front of the remote control sensor, 30° to the left and right, 20° up and down.



When in Bluetooth mode:

- Your remote control also has Bluetooth and when paired with your HDTV, allows you to point the remote control anywhere to control the TV.
- The effective range of the remote control is approximately 30 feet (10 meters) from the front of the remote control sensor.

VIZIO Remote Control Precautions

- The remote control should be kept dry and away from heat sources. Avoid humidity.
- If the TV responds erratically to the remote control or does not respond at all, check the batteries. If the batteries are low or exhausted, replace them with fresh batteries.
- When not using the remote control for a long period of time, remove the batteries.
- Do not take the batteries apart, heat them, or throw them into a fire.
- Do not subject the remote control to undue physical stress, such as striking or dropping it.
- Do not attempt to clean the remote control with a volatile solvent. Wipe it with a clean, damp cloth.



Chapter 3 Getting Started

Your VIA-enabled HDTV has a built-in *Setup App* that plays when you turn on your TV for the first time. Follow the on-screen directions to easily setup your new HDTV.

1. Insert batteries into the remote control.
2. Connect the power cord to the power cord connector on your HDTV, and then plug the power cord into an AC wall socket.
3. Gather the devices you want to connect to your HDTV. Don't connect them yet. We will help you do that in the *Setup App*.
4. Turn on your TV. The *Setup App* will automatically play and guide you thru the initial setup of your HDTV. Use the arrow and **OK** buttons to navigate through the *Setup App*. During the setup process you will:
 - Activate your new remote control for Bluetooth
 - Connect to the Internet
 - Add your TV channels (unless you have a cable/satellite set-top box)
 - Connect your devices and set up your remote to control them



Chapter 4 Using your HDTV for the first time

Connecting to the Internet

Set up the Internet connection using the initial *Setup App* or the *Network Menu* in the *HDTV Settings App*. Your HDTV has 802.11n dual-band wireless, so you can connect your TV to the Internet through your wireless home network. Or you can also connect to the Internet by plugging in an Ethernet cable from your Internet connection into the Ethernet port on your HDTV. A wired connection may provide a more consistent connection depending on the conditions in your home environment. See *Network Menu* on page 50 for detailed information on setting up your Internet connection.

Selecting an Input Source

Select the input source for your HDTV by pressing **INPUT** on the remote control or side of the TV. Pressing this button will cycle you through the following options: **TV**, **AV** (Composite), **COMP** (Component), **HDMI-1**, **HDMI-2**, **HDMI-3**, **HDMI Side**, and **RGB** (VGA).

Turn on your device and you will see a picture on your HDTV. If there is no picture, make sure you have selected the correct input on your HDTV.

Note: If the selected device is RF connected, your HDTV needs to be in **TV** mode and on either channel 3 or channel 4 matching the channel which has been selected on the back of the VCR, Cable Box, External TV Tuner or Satellite Receiver. Please refer to Owner or User's Manual of such equipment for details.

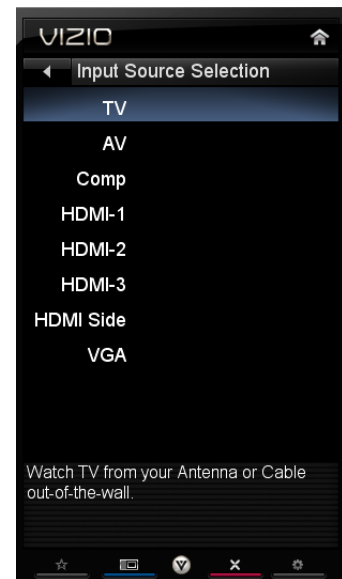

Setting the Time Zone & Daylight Savings

1. Press the **VIA** button.
2. Press **◀** or **▶** on the remote control to select the *HDTV Settings App*, and then press **OK**. The *Main Menu* will be displayed.
3. Press **◀**, **▶**, **▲**, or **▼** on the remote control to highlight *HDTV Settings*, and then press **OK** to select it. The *Input Source* sub-menu will be highlighted.
4. Press **▲** or **▼** on the remote control to highlight *Time & Local Settings*, and then press **▶** to select it. The *Time Zone* sub-menu will be highlighted. Press **◀** or **▶** to select your time zone.
5. Press **▼** to scroll down to *Daylight Savings*, and then press **◀** or **▶** to set to *On* or *Off*.
6. Press **EXIT** to return to your program.

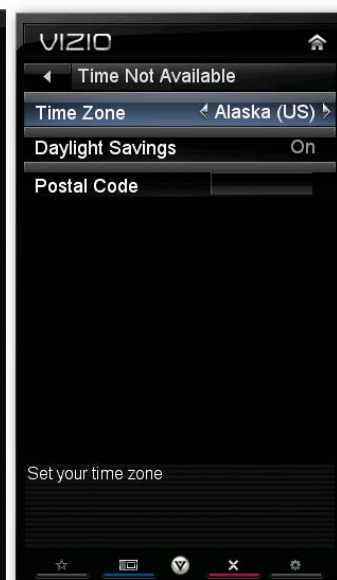

Watching a TV Program

Before you start watching TV, please make sure that any cable, satellite or off-air antenna connections are secure. Also, verify that the power cord is plugged into a correctly grounded electrical outlet or surge protector.

1. Turn on the TV. The VIZIO logo on the front will change from orange to white.
2. Select the input to which your device is connected that provide TV programming (i.e. TV, HDMI, COMP).

Note: You should be able to see a picture. If you do not, make sure that all of your HDTV connections are secure and you have selected the correct video input source. Each press of **INPUT** will cycle through the available inputs. Press **INPUT** until the input associated with the device you want to view is shown.

3. When using the TV input, press the CH ▲ or ▼ buttons to change the channel. The channel buttons will not work if you are watching a program using the HDMI, Component, or AV (S-Video or Composite) inputs.
4. Press **LIST** or **OK** to view the available channels. Press ▲ or ▼ to scroll through the list and press **OK** to select a channel.

Viewing Digital TV Program Information

INFO Button

When the channel is changed or when you press **INFO**, an information header is shown over the picture for a few seconds. Each press of the **INFO** button will display more information about the program:

Ch 50-123	KCAL DTV	CABLE
-----------	----------	-------

Time Warp: Mouse Trap			Ch 50-123	KCAL DTV	CABLE
11:00 AM - 12:00 AM	TV-PG (V)	CC-OFF	ENGLISH	DOLBY 5.1	720p HD

Time Warp: Mouse Trap			Ch 50-123	KCAL DTV	CABLE
11:00 AM - 12:00 AM	TV-PG (V)	CC-OFF	ENGLISH	DOLBY 5.1	720p HD

In this hour-long special, the Time Warp team runs off to join the circus with trap-testing Rev. Tommy Gunn and with high-flying Cirque du Soleil, explore their inner stuntmen, and put everything but wood in a chipper.



GUIDE Button

When you press **GUIDE** on the remote control, the guide is shown on the screen displaying information provided by the broadcaster about the current and upcoming programs,

- Press ◀ or ▶ to go to the previous or next channel in the guide.
- Press ▲ or ▼ to scroll through the list and view information about upcoming programs.
- The guide will close automatically or you can press **EXIT** to close it manually.



Exploring VIZIO Internet Apps (VIA)



VIA Sidebar

Select an App and press **OK** to launch the Sidebar. The Sidebar contents vary by App.

VIA Dock
Press ◀ or ▶ to scroll through all of the Apps in the *VIA Dock*. Press **OK** to open an App.



Widget Gallery

Select this to discover more Apps and download them to the TV. This gallery is constantly being updated so check back often!

HDTV Settings App

Adjust TV functions like brightness, contrast, Parental Controls, and Network settings.

Profile App





Create a unique name, picture and set of Apps in the *VIA Dock*. Set up a profile for each member of your household.



Chapter 5 Connecting Equipment

Which Video Connection Should I Use?

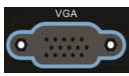
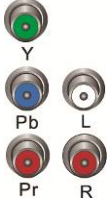
You have six options for connecting your video equipment box to your HDTV from a basic connection to the most advanced for digital displays. Based on your home theater configuration, you can decide which option is the right one for you.

Connection Quality (type)	Connector	Description
Best (digital)	 HDMI	HDMI delivers the best image quality of any of the cable types available and it's all done over one cable. You get a great picture and cut down on your cable clutter. HDMI provides digital quality and amazing sound so if your TV has HDMI, this is the connection type you should be using.
Best (digital) ----- Compatible (analog)		Connect your antenna or coaxial cable to watch TV programming. This cable usually comes from your cable box or right out of the wall.
Best (analog)	 VGA	The RGB (VGA) port allows you to connect your computer so you can use the TV as your monitor.
Better (analog)	 Y Pb L Pr R	Component consists of three cables for transmitting video and two cables for transmitting audio: one red and one white. Component video provides a sharper image than Composite video and should be used instead of composite when possible. However, because it is still an analog connection, it won't provide the high-quality video and audio that HDMI can produce.
Compatible (analog)	 S-VIDEO L R	Using a unique connector, S-Video provides a sharper image than Composite video. However, S-Video is generally not ideal for high-definition video signals. Use HDMI or Component for high-definition signals. Composite consists of one yellow cable for transmitting video and two cables for transmitting audio: one red and one white. It is capable of transmitting stereo sound and standard definition video (480i). While it provides a good image, it has lower image quality than HDMI or Component. So try to use one of those connections first.

Note: To maintain the display quality, use a VIZIO certified HDMI cable. This cable is available in 6, 8, and 12 foot lengths. Visit www.vizio.com or call 1-888-VIZIOCE (1-888-849-4623) for details.



Connecting Your Cable or Satellite Box

Using HDMI (Best)



Cable and Satellite Boxes that have a HDMI digital interface should be connected using HDMI for optimal results. To maintain image quality, use a VIZIO certified HDMI cable. This cable is available in 6, 15, and 30 foot lengths. Visit www.VIZIO.com or call **877-MYVIZIO** (877-698-4946) for details.

1. Turn off your HDTV and cable/satellite box.
2. Connect an HDMI cable to the **HDMI** output of your cable/satellite box and the other end to the **HDMI 1, 2, 3** or **SIDE** jack on your HDTV.
3. Turn on the power to your HDTV and your cable/satellite box.
4. Select **HDMI-1, HDMI-2, HDMI-3**, or **HDMI Side** using the **INPUT** button on the remote control or side of the TV.
5. Program your cable/satellite box to work with your VIZIO remote control. See *Device Setup* on page 45 for more information on setting up your remote.

Note:

- The HDMI input on your HDTV supports High-bandwidth Digital Content Protection (HDCP). HDCP encrypts the transmission between the video source and the digital display for added security and protection.
- Refer to your cable/satellite set-top box user manual for more information about the video output requirements of the product or consult your cable or satellite operator.

HDMI Connections for Cable or Satellite Boxes with DVI



1. Turn off the power to your HDTV and HDTV cable/satellite box.
2. Using a HDMI-DVI cable, connect the DVI end to your cable/satellite box and the HDMI end to the **HDMI 3** jack on your HDTV.
3. Connect the audio cables (white and red) from the DVI audio output jacks on the cable/satellite box to the **HDMI 3 L** and **R AUDIO** jacks on your HDTV.
4. Turn on the power to your HDTV and your cable/satellite box.
5. Select **HDMI-3** using the **INPUT** button on the remote control or side of the TV.
6. Program your cable/satellite box to work with your VIZIO remote control. See *Device Setup* on page 45 for more information on setting up your remote.



Using Component Video (Better)

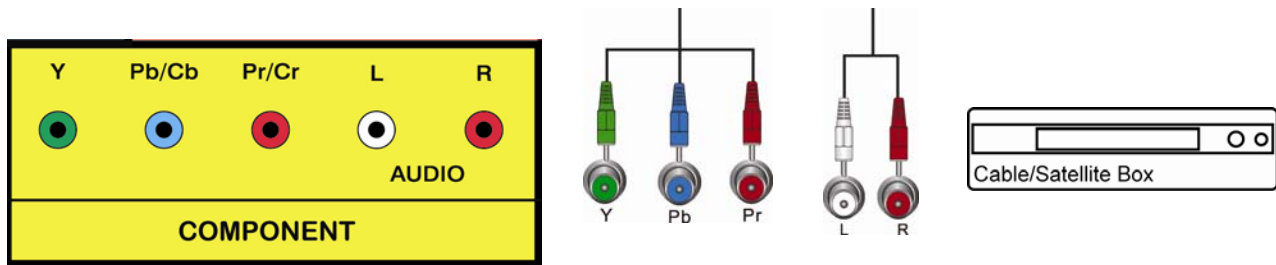

1. Turn off your HDTV and cable/satellite box.
2. Connect the component cables (green, blue, and red) from your cable/satellite box to the **COMPONENT** jacks on your HDTV.
3. Connect the audio cables (white and red) from your set-top box to the **COMPONENT L** and **R AUDIO** jacks on your HDTV.
4. Turn on your HDTV and cable/satellite box.
5. Select **Comp** using the **INPUT** button on the remote control or side of the TV.
6. Program your cable/satellite box to work with your VIZIO remote control. See *Device Setup* on page 45 for more information on setting up your remote.

Using S-Video (Better)



1. Turn off your HDTV and set-top box.
2. Connect the S-VIDEO cable from your set-top box to the **S-VIDEO** jack on your HDTV.
3. Connect the audio cables (white and red) on your set-top box to the **S-VIDEO/AV L** and **R AUDIO** jacks on your HDTV.
4. Turn on your HDTV and set-top box.
5. Select **AV** using the **INPUT** button on the remote control or side of the TV.
6. Program your cable/satellite box to work with your VIZIO remote control. See *Device Setup* on page 45 for more information on setting up your remote.



Using Composite Video (Compatible)

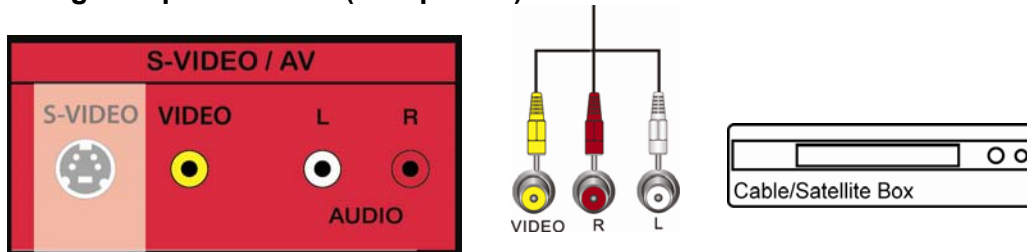

1. Turn off your HDTV and set-top box.
2. Connect the video cable (yellow) from your set-top box to the **AV** jack (yellow) on your HDTV.
3. Connect the audio cables (white and red) on your set-top box to the **S-VIDEO/AV L** and **R AUDIO** jacks on your HDTV.
4. Turn on your HDTV and set-top box.
5. Select **AV** using the **INPUT** button on the remote control or side of the TV.
6. Program your cable/satellite box to work with your VIZIO remote control. See *Device Setup* on page 45 for more information on setting up your remote.

Using Coaxial (Antenna) (Compatible)



1. Turn off the power to your HDTV.
2. Connect the coaxial (RF) connector from your antenna or digital cable to the **DTV/TV CABLE/ANTENNA** connector on your HDTV.
3. Turn on the power to your HDTV.
4. Select **TV** using the **INPUT** button on the remote control or side of the TV.
5. Search for new channels. See *Auto Channel Search* on page 44 for more information on scanning for channels.



Connecting Your DVD Player

Using HDMI (Best)

DVD players that have a HDMI digital interface should be connected using HDMI for optimal results. To maintain image quality, use a VIZIO certified HDMI cable. This cable is available in 6, 15, and 30 foot lengths. Visit www.VIZIO.com or call **877-MYVIZIO** (877-698-4946) for details.

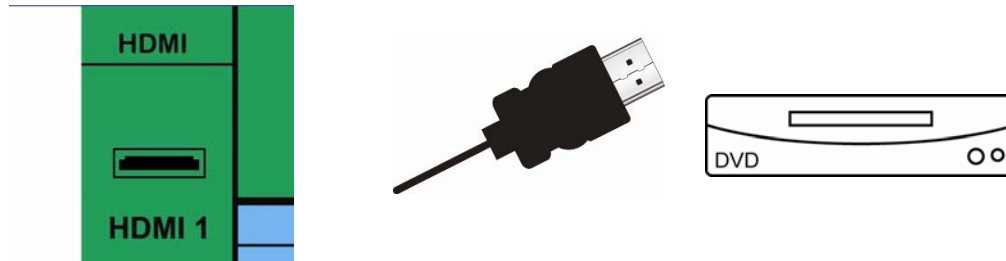

1. Turn off your HDTV and DVD player.
2. Connect a HDMI cable to the HDMI output of your DVD player and the other end to the **HDMI 1, 2, 3** or **SIDE** jack on your HDTV.
3. Turn on the power to your HDTV and your DVD player.
4. Select **HDMI-1, HDMI-2, HDMI-3**, or **HDMI Side** using the **INPUT** button on the remote control or side of the TV.
5. Program your DVD player to work with your VIZIO remote control. See *Device Setup* on page 45 for more information on setting up your remote.

Note:

- The HDMI input on your HDTV supports High-bandwidth Digital Content Protection (HDCP). HDCP encrypts the transmission between the video source and the digital display for added security and protection.
- Refer to your DVD player user manual for more information about the video output requirements.

HDMI Connections for DVD Players with DVI

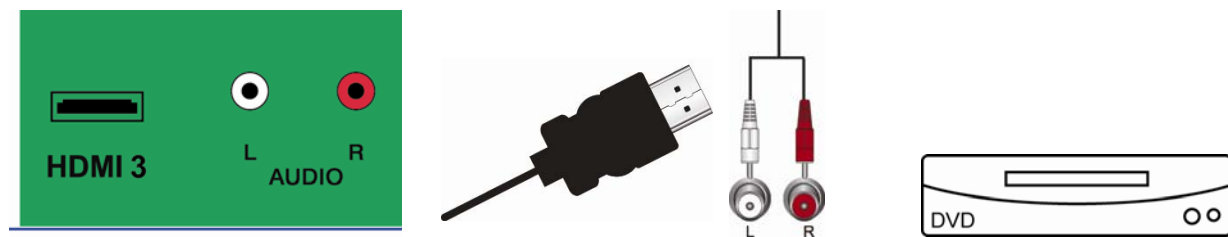

1. Turn off your HDTV and DVD player.
2. Using a HDMI-DVI cable, connect the DVI end to your DVD player and the HDMI end to the **HDMI 3** Jack on your HDTV.
3. Connect the audio cables (white and red) from the DVI audio output jacks on the DVD player to the **HDMI 3 L** and **R AUDIO** jacks on your HDTV.
4. Turn on the power to your HDTV and your DVD player.
5. Select **HDMI-3** using the **INPUT** button on the remote control or side of the TV.
6. Program your DVD player to work with your VIZIO remote control. See *Device Setup* on page 45 for more information on setting up your remote.



Using Component Video (Better)

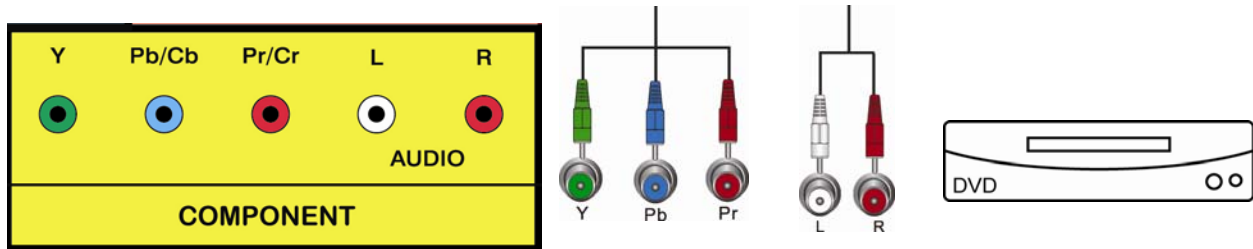

1. Turn off the power to your HDTV and DVD player.
2. Connect the component cable (green, blue, and red) from your DVD player to the **COMPONENT** jacks on your HDTV.
3. Connect the audio cables (white and red) from your DVD player to the **COMPONENT L** and **R AUDIO** jacks on your HDTV.
4. Turn on the power to your HDTV and DVD player.
5. Select **COMP** using the **INPUT** button on the remote control or side of the TV.
6. Program your DVD player to work with your VIZIO remote control. See *Device Setup* on page 45 for more information on setting up your remote.

Using S-Video (Bette)

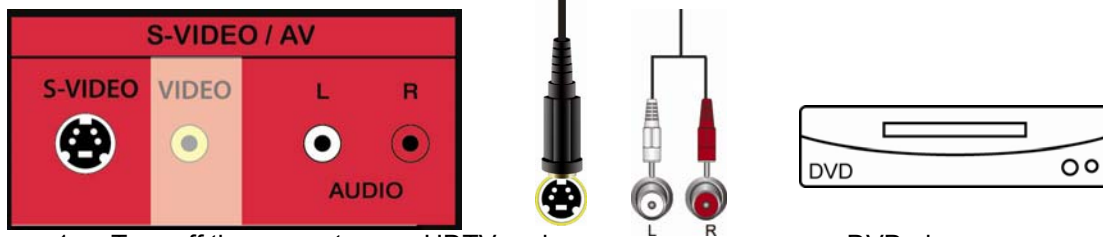

1. Turn off the power to your HDTV and DVD player.
2. Connect the S-VIDEO cable from your DVD player to the **S-VIDEO** jack on your HDTV.
3. Connect the audio cables (white and red) on your DVD player to the **S-VIDEO/AV L** and **R AUDIO** jacks on your HDTV.
4. Turn on the power to your HDTV and DVD player.
5. Select **AV** using the **INPUT** button on the remote control or side of the TV.
6. Program your DVD player to work with your VIZIO remote control. See *Device Setup* on page 45 for more information on setting up your remote.



Using Composite (AV) Video (Compatible)

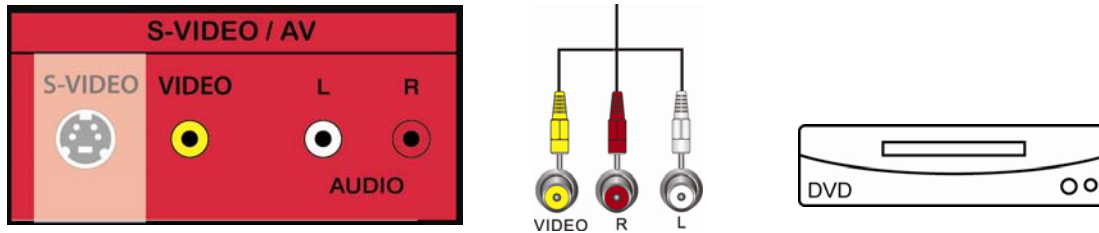

1. Turn off the power to your HDTV and DVD player.
2. Connect the Video cable (yellow) from your DVD player to the **S-VIDEO/AV** jack on your HDTV.
3. Connect the audio cables (white and red) on your DVD player to the **S-VIDEO/AV L** and **R AUDIO** jacks on your HDTV.
4. Turn on the power to your HDTV and DVD Player.
5. Select **AV** using the **INPUT** button on the remote control or side of the TV.
6. Program your DVD player to work with your VIZIO remote control. See *Device Setup* on page 45 for more information on setting up your remote.

Connecting Coaxial (RF)

Using Your Antenna or Digital Cable for Standard or Digital TV

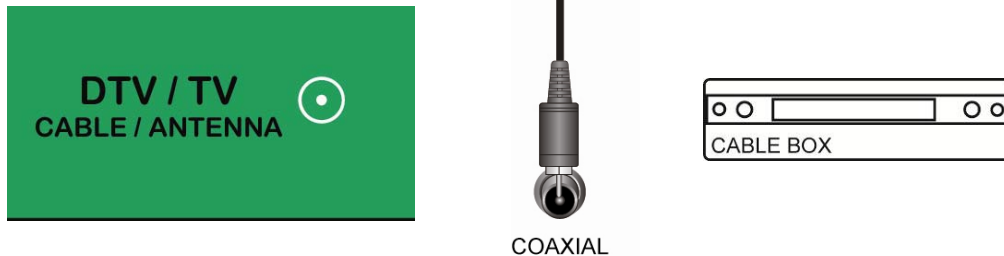

1. Turn off the power to your HDTV.
2. Connect the coaxial (RF) connector from your antenna or cable to the **DTV/TV CABLE/ANTENNA** connector on your HDTV.
3. Turn on the power to your HDTV.
4. Select **TV** using the **INPUT** button on the remote control or side of the TV.
5. Search for new channels. See *Auto Channel Search* on page 44 for more information on scanning for channels.



Connecting Your VCR or Video Camera

Note: Refer to your VCR or Video Camera user manual for more information about the video output requirements of the product.

Using S-VIDEO

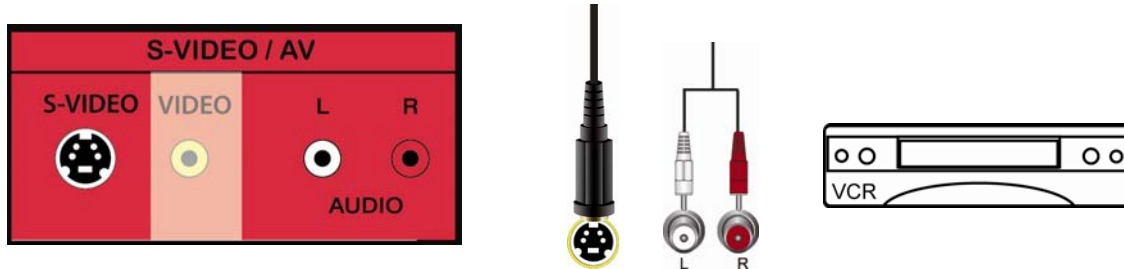

1. Turn off the power to your HDTV and VCR or video camera.
2. Connect the S-VIDEO cable from your VCR or video camera to the **S-VIDEO** jack on your HDTV.
3. Connect the audio cables on your VCR or video camera to the corresponding **L** and **R AUDIO** jacks on your HDTV.
4. Turn on the power to your HDTV and VCR or video camera.
5. Select **AV** using the **INPUT** button on the remote control or side of the TV.
6. Program your VCR to work with your VIZIO remote control. See *Device Setup* on page 45 for more information on setting up your remote.

Using AV

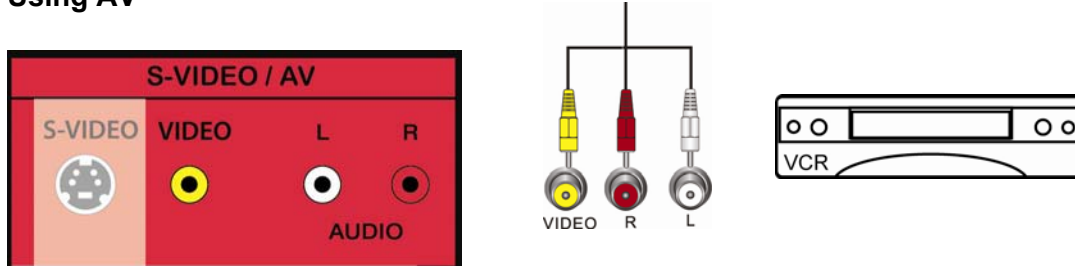

1. Turn off the power to your HDTV and VCR or video camera.
2. Connect the yellow AV cable from your VCR or video camera to the **AV** jack on your HDTV.
3. Connect the audio cables on your VCR or video camera to the corresponding **L** and **R AUDIO** jacks on your HDTV.
4. Turn on the power to your HDTV and VCR or video camera.
5. Select **AV** using the **INPUT** button on the remote control or side of the TV.
6. Program your VCR to work with your VIZIO remote control. See *Device Setup* on page 45 for more information on setting up your remote.



Connecting a Home Theater System

Using RCA

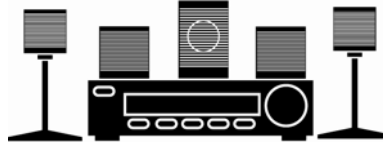
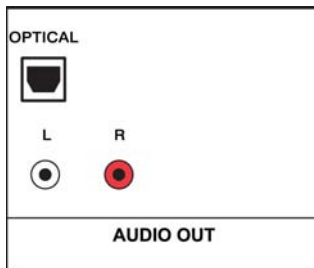

1. Turn off the power to your HDTV and home theater.
2. Connect an audio cable (white and red connectors) to the audio connectors on the home theater and connect the other end to the **L** and **R AUDIO OUT** jacks on your HDTV.
3. Turn on the power to your HDTV and home theater.
4. Press **MENU**. The *HDTV Settings App* opens.
5. Press **◀**, **▶**, **▲**, or **▼** to select **HDTV Settings**, and then press **SELECT**.
6. Press **▼** to select **Audio**, and then press **SELECT**.
7. Press **▼** to select **TV Speakers**, and then press **SELECT**.
8. Press **▶** to select **OFF** so the sound from your HDTV will be routed through your home theater system.
9. Adjust other audio settings in the menu as desired.
10. Press **EXIT** to close the *HDTV Settings App*.
11. Program your home theater to work with your VIZIO remote control. See *Device Setup* on page 45 for more information on setting up your remote.

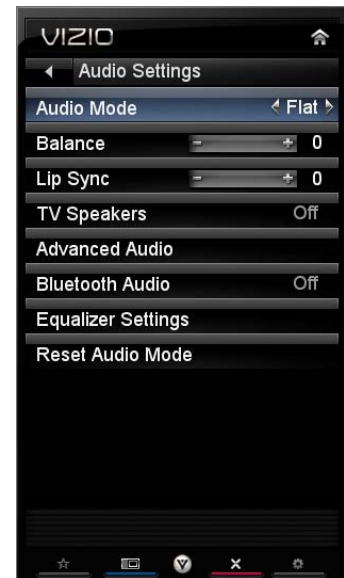

Note:

- Refer to your home theater user manual to select the corresponding audio input.
- The audio output is not amplified and cannot be connected directly to external speakers.



Using Optical (SPDIF)

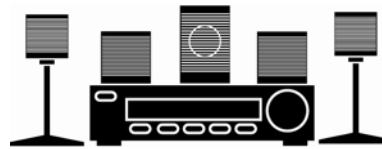
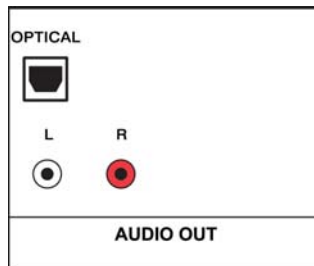

If your sound system has a SPDIF (optical) digital audio input you can connect it from your sound system to the **OPTICAL** digital audio out on your HDTV. This is active when receiving audio with the programs being viewed no matter what input is being used.

1. Connect one end of the optical cable to optical connectors on the home theater and the other end to the **OPTICAL** jack on your HDTV.
2. Turn on the power to your HDTV and home theater.
3. Change the input on your home theater to optical. See your home theater user manual for more information.
4. Program your home theater to work with your VIZIO remote control. See *Device Setup* on page 45 for more information on setting up your remote.

Connecting a Computer

RGB (VGA)

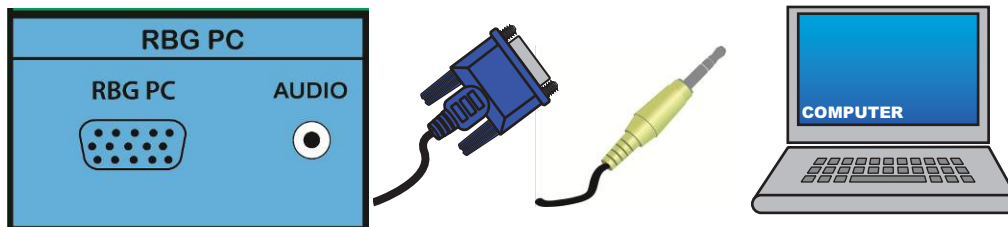

1. Set computer to a resolution supported by your HDTV (see *Preset PC Resolutions* on page 61). If your computer supports it, we recommend 1920x1080.
2. Turn off the power to your HDTV and computer.
3. Connect the RGB (VGA) cable from your computer to the **RGB PC** jack on of your HDTV.
4. Connect the 1/8-inch audio cable from your computer to the **RGB PC Audio** jack on your HDTV. This step is optional and only needed if you want to transmit audio from the computer through the TV.
5. Turn on the power to your HDTV and computer.
6. Select **RGB (VGA)** using the **INPUT** button on the remote control or side of the TV.

Note: Refer to your PC computer user manual for more information about the video output requirements.



Using HDMI

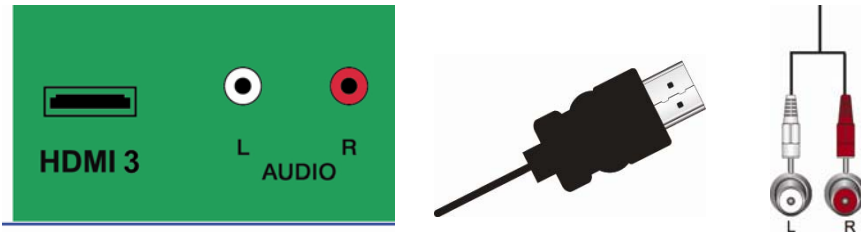

1. Turn off your HDTV and computer.
2. Connect a HDMI cable to the HDMI output of your computer and the other end to the **HDMI 3** jack on your HDTV.
3. Connect the audio cables (white and red) from the audio output jacks on the computer to the **HDMI 3 L** and **R AUDIO** jacks on your HDTV.
4. Turn on the power to your HDTV and your computer.
5. Select **HDMI-3** using the **INPUT** button on the remote control or side of the TV.

Ethernet Connection

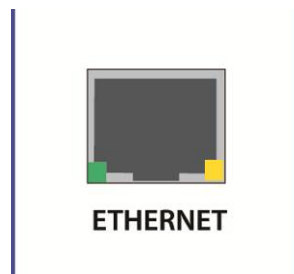

The Ethernet function on your HDTV is used to access the Internet. Your HDTV also has 802.11n dual-band wireless, so you can connect your TV through your wireless home network. A wired connection can sometimes deliver a more consistent connection depending on the conditions in your home environment. See *Network Menu* on page 50 for detailed information on setting up your Internet connection.

1. Connect one end of an Ethernet cable (not supplied) to the Ethernet jack on your TV.
2. Connect the other end of the Ethernet cable to your home network (usually your router). Your home network must have broadband Internet access such as cable or DSL. See *Network Menu* on page 50 for detailed information on setting up your Internet connection. If you need additional help setting up your wireless network, please refer to the user manual for your router or contact the manufacturer of either your router or your Internet service provider if they provided the router for you.



Chapter 6 Using VIA

Connecting to the Internet

VIA delivers popular online content right to your HDTV! When you press the **VIA** button on your remote, the *Apps Dock* appears along the bottom of your screen with a selection of different Apps that let you watch movies, TV shows, listen to music, or get weather and news information all on demand.

A high-speed Internet connection is required to receive product updates and to access your favorite online content. You have the option to connect your TV to the Internet with either wired networking using an Ethernet cable or with wireless networking if you have a wireless Internet connection. See *Network Menu* on page 50 for detailed information on setting up your Internet connection.

Navigating the VIA Dock



VIA Sidebar

Select an App and press **OK** to launch the Sidebar. The Sidebar contents vary by App.

VIA Dock
Press ◀ or ▶
to scroll
through all of
the Apps in the
VIA Dock.
Press **OK** to
open an App.



Widget Gallery

Select this to discover more Apps and download them to the TV. This gallery is constantly being updated so check back often!

HDTV Settings App

Adjust TV functions like brightness, contrast, Parental Controls, and Network settings.

Profile App

Create a unique name, picture and set of Apps in the *VIA Dock*. Set up a profile for each member of your household.



Using VIZIO Internet Apps (VIA)

VIA puts the best of the web right on your TV screen, giving you the convenience of on-demand movies, TV shows, social networking, music, photos, news, weather and more at the push of the VIA button.

Navigating Apps

Use these buttons on your remote control to navigate around the VIZIO Internet Apps (VIA) functions on your HDTV:

- **YELLOW**—Press to move or delete an App from the *VIA Dock*. Also, if this button is available in the App's sidebar, press to bookmark the current screen of the App. The next time you scroll the *VIA dock*, press ▲ or ▼ while the App is highlighted in the dock and you will see your bookmark appear with the latest information from the App.
- **BLUE**—Press to switch to another screen size for the video playing on the TV while the *HDTV Settings App* or any other App is open on the left side of the TV. As you press the blue button you will see the image change.
- **RED**—Press to exit from the active App or from the *VIA Dock*.
- **GREEN**—Press to view settings for the current App running on the screen.



Adding Apps

VIA comes with some Apps pre-loaded but there are many more Apps you can download and add to your TV. Use the *Widget Gallery* to browse and discover new Apps that are available. This gallery is constantly being updated so check back often!



1. Press the **VIA** button.
2. Press ◀ or ▶ to select *Widget Gallery*, and then press **OK**.
3. Press ▲ or ▼ to select to browse one of the categories, and then press **OK** to select.
4. Press ▲ or ▼ to choose an App. Apps with a green checkmark are the Apps currently on your *VIA Dock*.
5. Press **OK** to select the App. A progress bar will appear and your new App will be added to your *VIA Dock* when downloading has finished.



Deleting Apps

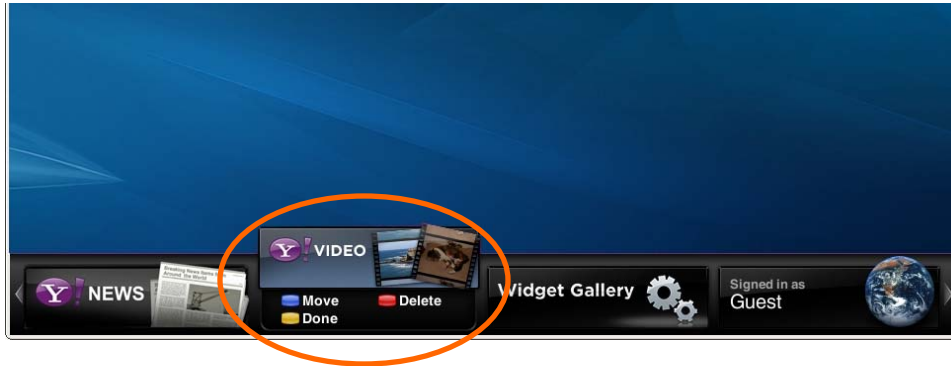

1. Press the **VIA** button.
2. Press ◀ or ▶ to select the App you want or delete, and then press the **Yellow** button.
3. Press the **Red** button to delete the App.
4. A message will appear asking if you want to permanently delete it. Press the **Red** button to delete the App.
5. Once the App has been deleted, press the **Yellow** button to exit.

Note: The *Widget Gallery*, *HDTV Settings App*, and *Profile App* cannot be deleted.

Moving Apps

1. Press the **VIA** button.
2. Press ◀ or ▶ to select the App you wish to move and then press the **Yellow** button.
3. Press the **Blue** button.
4. Press ◀ or ▶ to move the App to the desired location on the *VIA Dock*.
5. Press the **Yellow** button to drop the App in place.

Using Profiles

The *Profile App* allows you to set up a user profile that you can customize to have your own personal set of Apps in the *VIA Dock*. Each profile will have a unique name and avatar/picture so each member of your household can create and have their own profile!

Creating a New Profile

1. Press the **VIA** button.
2. Press ▶ to select the **Profile App**, and then press **OK**.
3. Press ▼ to select **Administrative Controls**, and then press **OK**.
4. Press ▼ to select **Create Profile**, and then press **OK**.
5. Complete the required fields to create a profile. You can:
 - a. Create a name
 - b. Select an avatar (picture)
 - c. Create a PIN (password)
 - d. Set who can access the profile
6. Press ▼ to select **Done**. Your new profile has been created.

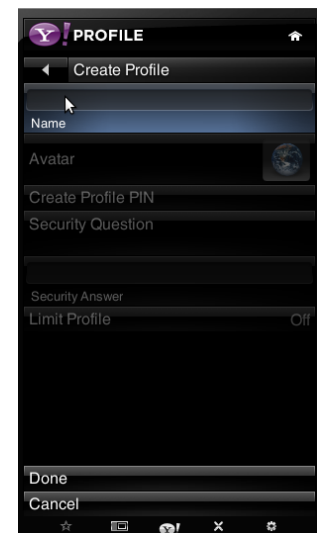

Switching Profiles

1. Press the **VIA** button.
2. Press ◀ or ▶ to select the **Profile App**, and then press **OK**.
3. Press ▼ to select **Switch Profile**, and then press **OK**.
4. Press ▼ to select the profile you want to switch to, then press **OK**. The Profile loads and the *VIA Dock* appears with the set of Apps associated with that Profile.

Editing your Profile

1. Press the **VIA** button.
2. Press ◀ or ▶ to select the **Profile App**, and then press **OK**.
3. Press ▼ to select **Switch Profile**, and then press **OK**.
4. Select the profile you want to edit, and then press **OK**. The Profile loads and the *VIA Dock* appears.
5. Press ◀ or ▶ to select the **Profile App**, and then press **OK**.
6. Press ▼ to select **Profile Settings**, and then press **OK**.
7. Modify the required fields to change the profile using your remote.
8. Press ▼ to select **Done**.

Removing a Profile

1. Press the **VIA** button.
2. Press ◀ or ▶ to select the **Profile App**, and then press **OK**.
3. Press ▼ to select **Administrative Controls**, and then press **OK**.
4. Press ▼ to select **Remove Profile**, and then press **OK**.
5. Press ▼ to select the Profile you wish to remove, and then press **OK**.
6. A message will appear asking if you want to delete the profile. Press ▼ to select **OK**, and then press **OK**. The Profile will be deleted.

Updating your TV

Your HDTV has the ability to download and automatically install product updates. All you need is an Internet connection – wired or wireless. We will perform product updates whenever your TV is turned off.



Chapter 7 Adjusting Your HDTV Settings

Using the HDTV Settings App

The remote control or the buttons on the side of the TV can control all the function settings. The *HDTV Settings App* allows you to adjust contrast, brightness and other settings. The TV will save changes made to the settings, even if the TV is turned off.

The *HDTV Settings App* consists of several menu options. The main menu options may vary depending on your selected input source.

Note: Some of the main menu options may have additional submenus, for example, the TV Rating submenu for Parental Controls.

1. Press the **VIA** button.
2. Press ◀ or ▶ on the remote control to select the **HDTV Settings** App, and then press **OK**. The *Main Menu* will be shown on the screen.
3. Press ◀, ▶, ▲, or ▼ on the remote control to select one of the menu options:
 - Input
 - Wide
 - CC
 - Sleep Timer
 - TV Settings
 - PIP
 - Network
 - Bluetooth
 - Help
4. Press **OK** to select the option or feature you want to adjust.
5. Once the menu option is displayed, press ▲ or ▼ on the remote control to select one of the items to adjust.
6. Press **OK** to select it, and then press ◀, ▶, ▲, or ▼ to adjust the selection.
7. Press **BACK** once to return to the previous screen. To return to your program once adjustments have been completed, you can do one of the following:
 - a. Press the **EXIT** button on the remote control.
 - b. Press the **RED** button on the remote control.
 - c. Highlight and select the **RED X** in any menu.



Input Menu

Select the Input Source for your HDTV. Choose from **TV**, **AV** (Composite), **Comp** (Component), **HDMI-1**, **HDMI-2**, **HDMI-3**, **HDMI Side**, and **RGB** (VGA).



Wide Menu

Select how the picture displays on the screen. As you select an option, you will see the screen adjusting to the different sizes. The options vary depending on the selected input and the TV program:

High Definition TV programs: Normal, Zoom, and Stretch.

Standard definition TV programs: Zoom1, Zoom2, Normal, and Panoramic.

AV: Zoom1, Zoom2, Normal, and Panoramic

Comp (Component): Zoom1, Zoom2, Normal, and Panoramic.

HDMI: Zoom1, Zoom2, Normal, and Stretch.



Normal

The original aspect ratio is preserved. This is recommended for HDMI and RGB (computer) viewing so you can see the whole picture without the image overstretching beyond the viewing area. If you experience "noise" along the border switch to Zoom 1. For 720p, 1080i, 1080p only.

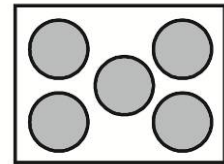

Panoramic

When watching a standard broadcast or full frame movie in this mode, the 4:3 aspect ratio image is stretched horizontally on the left and right sides to fill the TV screen. The center of the image is not stretched.

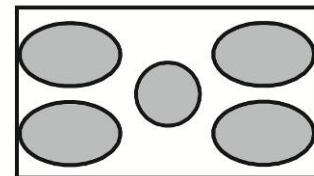

Stretch Mode

When watching a standard broadcast with black bars on the sides, the image will stretch to fill the TV screen. People will appear wider than they really are. If you are watching a widescreen (1.85:1 or 2.35:1 source) program or movie, there will still be black bars at the top and bottom.

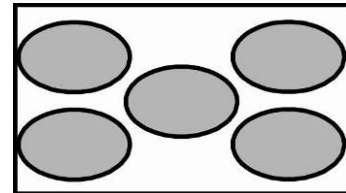

Zoom

Zooms in by 14% to crop the top and bottom bars for 2.35:1 film resolutions for 16:9 broadcast formats.

Zoom 1

When watching a standard broadcast or full-frame movie in this mode, the image is stretched proportionately to fill the TV screen. When watching a widescreen (1.78:1 source) program or movie, the display image fills the TV screen. If you are watching a widescreen (1.85:1 or 2.35:1 source) program or movie, there will still be black bars at the top and bottom.

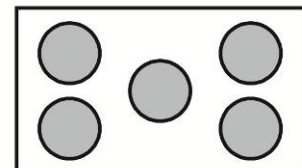

Zoom 2

Zooms in by 14% to crop the top and bottom bars for 2.35:1 film resolutions. For 480i/p, 4:3 only.

Note: When in PIP/POP the screen is fixed in Zoom1 mode.



CC Menu

To select the options in the CC sub-menu, press the **OK** or **►**. A new menu will be displayed showing the following CC settings:

Analog Closed Caption

The CC feature is available when watching regular analog TV. Select from **Off**, **CC1**, **CC2**, **CC3**, and **CC4**. Closed Caption for regular TV is usually **CC1** or **CC2**.

Digital Closed Caption

The CC feature is available when watching digital TV. Select from **Off**, **CC1**, **CC2**, **CC3**, **CC4**, **CS1**, **CS2**, **CS3**, **CS4**, and **CS5**. Closed Caption for regular TV is usually **CC1** or **CC2**.

Digital CC Style

The Digital CC Style feature is available when watching digital TV.

- **Caption Style:** Select either **As Broadcaster** or **Custom**. If Custom is selected you can customize the way Closed Caption is displayed. The options available are:
- **Text Size:** Make CC text larger or smaller.
- **Color:** Choose a text color for CC display
- **Opacity:** Make text more or less transparent.
- **Background Color:** Choose a background color for CC text.
- **BG Opacity:** Make the background for CC text more or less transparent.
- **Frame Color:** Choose a text frame color for CC text.
- **Window Opacity:** Make the text frame for CC text more or less transparent.

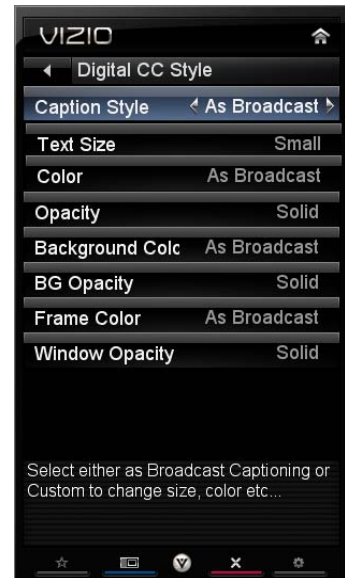

Sleep Timer Menu

Set the timer on to have the TV automatically turn off in 30, 60, 90, 120, or 180 minutes.



TV Settings Menu

1. Press ▲ or ▼ on the remote control to select a TV Settings option.
2. Once the menu option is highlighted, press ► on the remote control to select and adjust the setting.
3. Press **BACK** once to return to the previous screen or repeatedly to return to your program if the task has been completed.

Input Source

Select the Input Source for your HDTV. Choose from **TV**, **AV** (Composite), **Comp** (Component), **HDMI-1**, **HDMI-2**, **HDMI-3**, **HDMI Side**, and **RGB** (VGA).

Picture

Picture Mode

Choose from **Standard**, **Movie**, **Game**, **Vivid**, **Football**, **Golf**, **Basketball**, **Baseball**, and **Custom**. Each input (i.e. HDMI, COMP, etc) remembers the custom setting you created.

Backlight

The backlight level adjusts the lamp current and this affects the overall brilliance of the picture but does not affect the Brightness (black level) or Contrast (white level) of the picture.

Brightness

The brightness adjusts the black levels in the picture. If the brightness is too low you will not be able to see the detail in darker parts of the picture and if the brightness is too high the picture will look washed out.

Contrast

The contrast adjusts the white levels in the picture. If the contrast is too low the picture will look washed out and if the contrast is too high you will not be able to see any detail in the bright parts of a picture.

Color

Color adjusts the amount of color in the picture.

Tint

The tint adjusts the hue of the picture. The easiest way to set tint is to look at flesh tones and adjust for a realistic appearance. In most cases, the default middle position is correct. If people's faces look too orange try reducing the level of color first.

Sharpness

The sharpness adjustment adjusts the sharpness of the edges of elements in the picture. It does not produce detail that otherwise does not exist. This adjustment is helpful when viewing (Standard Definition) sources.

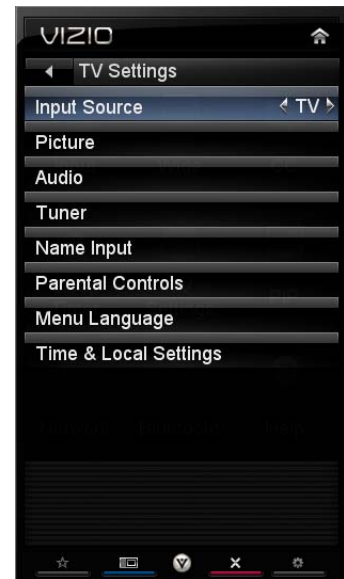

Size & Position

Note: The Size & Position option can only be selected when your HDTV is in **Comp** or **HDMI** mode.

- **Horiz. Position:** Adjust the horizontal position of the picture.
- **Vertical Position:** Adjust the vertical position of the picture.
- **Horizontal Size:** Adjust the horizontal size of the picture.
- **Vertical Size:** Adjust the vertical size of the picture.

Color Temperature

Color Temperature is the “warmness” or “coolness” of the white areas of the picture.

- **Color Temperature** Choose from **Cool**, **Computer**, **Normal**, or **Custom**. **Cool** produces a blue-hued image. **Computer** sets the white point at the established setting for a PC display (9300K). **Normal** is the setting for television broadcasting. **Custom** allows you to set a preset calibrated for a white point to suit individual preferences:
 - Red Gain
 - Green Gain
 - Blue Gain
 - Red Offset
 - Green Offset
 - Blue Offset
- **Reset Color Temperature:** Select to reset color temperature settings to factory default.

Advanced Picture

To select the options in the Advanced Picture sub-menu, press ►. A new menu will be displayed showing the advanced functions available for fine tuning of the picture.

Smooth Motion Effect

The Smooth Motion™ Effect option activates Motion Estimation/Motion Compensation (ME/MC), which suppresses motion judder, or “stuttering” of the image when the camera pans across a scene, or there is horizontal motion in the scene. Choose from **Off**, **Low**, **Middle**, or **High**.

Real Cinema Mode

The Real Cinema Mode option allows selection of the type of compensation used for the Smooth Motion™ Effect option. Choose from **Off**, **Precision** and **Smooth**.

Noise Reduction

This feature diminishes picture artifacts caused by the digitizing of image motion content that may be present in the picture. Choose from **Off**, **Low**, **Medium**, or **High**.

Color Enhancement

This feature increases the picture reproduction performance of the picture by reducing oversaturation of certain colors and improving flesh tones. Choose from **Off**, **Normal**, **Rich Color**, **Green/Flesh**, and **Green/Blue**.

Adaptive Luma

Large areas of brightness in the picture will result in a higher Average Picture Level (APL) and the overall picture will look too light. This feature will lower the APL to counteract this effect. Choose from **Off**, **Low**, **Medium**, **Strong**, or **Extend**.

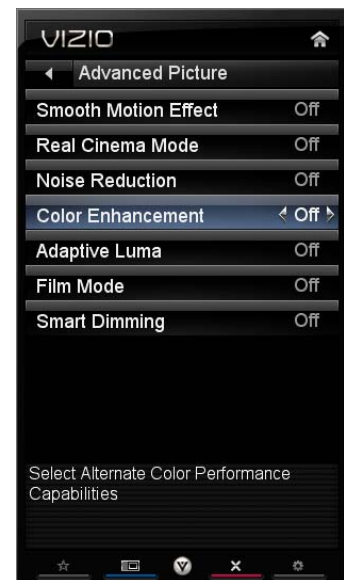

Film Mode

Choose from **Off** or **Auto**. When set to **Off** it will stay at 60 fps. When set to **Auto**, the TV will detect the cadence (for example at 24 frames/second for film, or normal video at 60 fps).

SmartDimming

Improves contrast ratio through intelligent control of the LED backlight.

Reset Picture Mode

Return all picture settings to factory default. A screen will come up to confirm your selection or to cancel it. Press either ◀ or ▶ to make the selection, and then press **OK** to accept it.

Note: Only settings under the Picture menu will be reset.

Audio

Audio Mode

Choose from **Jazz**, **Classical**, **Pop**, **Rock**, or **Flat**.

Balance

Adjust the sound to the left or the right.

Lip Sync

Lip Sync is designed to adjust the audio of the program being viewed so that it matches the movement of the lips of someone talking on the screen.

TV Speakers

Turn the internal speakers **On** or **Off**. You may want to turn the internal speakers off when listening to the audio through your Home Theater System.

Advanced Audio

To select the options in the Advanced Audio sub-menu, press ▶. A new menu will be displayed showing the advanced functions available for fine tuning of the audio.

SRS TruSurround HD

This option sets the SRS True Surround HD surround sound process. Choose from **On** or **Off**.

Note: When SRS TruSurround HD is **On**, Equalizer adjustments are not available.

SRS TruVolume

When the programming switches to a commercial or when changing from channel to channel, volume fluctuations occur. When turned **On**, SRS TruVolume™ provides the listener with a comfortable and consistent volume level. VIZIO recommends turning TruVolume off when listening to music content.

Digital Audio Out

This option allows selection of the type of processing for the SPDIF (Optical connector) when used with a home theater system. Select to choose from **Dolby Digital**, **PCM**, or **Off**.

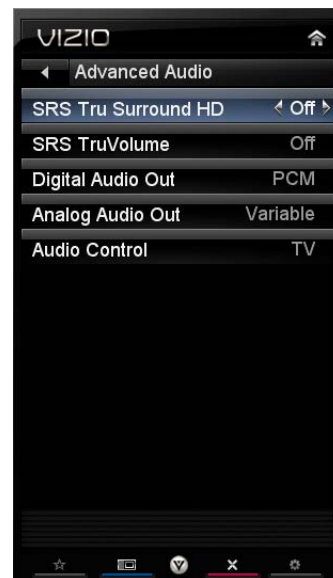
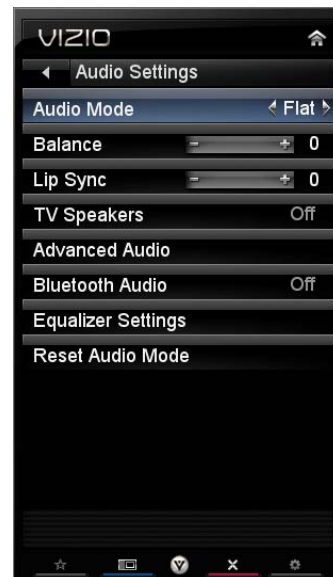

Analog Audio Out

This option sets the volume control properties when using the RCA (white and red) connectors as audio line out to connect a home theater system. Choose from **Fixed** or **Variable**. When set to **Variable**, volume from the external speakers will change when you change the volume setting on the TV. When set to **Fixed**, the volume can only be changed by the settings on the external stereo system.

Audio Control

Select which device the VIZIO remote control adjusts. Choose from **TV** or **External**. When set to **TV**, the VIZIO remote will control the audio of the TV speakers. When set to **External**, the VIZIO remote will control the audio of your selected device.

Device Setup

This feature allows you to add audio devices to your HDTV and control them with your VIZIO remote control. This feature was also available during the initial *Setup App*. The feature is not available in TV mode.

Pick Device Type

Select the type of device that is connected to your HDTV. Choose from **VCR**, **DVD Player**, **Blu-Ray Player**, **Sat Receiver**, **Cable Box**, **DVR**, or **None**.

Pick Device Brand

Select the brand name of the device that is connected to your HDTV. The brand names will vary based on the device type selected above.

Confirm Remote Connection

Automatically program the VIZIO remote control to allow it to control your device.

1. Turn the device On.
2. Point the VIZIO remote directly at the device.
3. Press **OK** to select **Confirm Remote Connection**. The TV will attempt to communicate with the device.
4. Point the VIZIO remote at the device and the press the **Input power** button. The device should turn off. If it does, select **It worked** and press **OK**. If it does not power off, select **Try the Next Code**. Repeat until you find a code that works.

Equalizer Settings

To select the options in the Equalizer sub-menu, press **OK**. A new menu will be displayed showing the volume levels of different frequencies (pitches).

Note: The Equalizer Settings menu will only be available when SRS TruSurround HD is set to **Off**.

Audio Mode

Choose from **Jazz**, **Classical**, **Pop**, **Rock**, or **Flat**.

EQ Mode

Choose from **Basic** or **Advanced**. When set to **Basic**, the equalizer options are Bass and Treble. When set to **Advanced**, more options for fine tuning become available. Starting from lowest to the highest frequencies, these options are 120 Hz, 500 Hz, 1.5 kHz, 5 kHz and 10 kHz. Press **▲** or **▼** to adjust to adjust the selected frequency to your preference. Values above 0 will boost the volume at that frequency and values below 0 will attenuate the volume.

Reset Audio Mode

Return all Audio settings to factory default. A screen will come up to confirm your selection or to cancel it. Press **◀** or **▶** to make the selection, and then press **OK** to accept it.

Note: Only settings under the Audio menu will be reset.



Tuner

When you first turned on your HDTV you scanned for channels using the *Setup App*. If you did not do this or if your setup has changed, you can do this from the Tuner menu.

Note: The tuner option can only be selected when your HDTV is in TV input mode.

Tuner Mode

Select **Cable** or **Antenna** depending upon which equipment you have attached to the DTV / TV Input.

Auto Channel Search

Automatically search for TV channels that are available in your area. Be sure to first select the correct tuner mode above. The TV will search for analog and digital channels. When the search is done, press **EXIT** to begin watching your programs.

Partial Channel Search

If you believe channels are missing from the auto search, you can do a partial channel search to look for channels in a certain channel range again. Select to scan for Analog, Digital, or both Analog/Digital channels, and then select **From Channel**, **To Channel** and then select **Start**. For a listing of digital TV stations in your area, visit www.antennaweb.org.

Add Analog Channel

Manually add missing channels. Enter the channel number, and then select **Add Channel** to add that channel to your list of available channels. For a listing of digital TV stations in your area, visit www.antennaweb.org.

Skip Channel

After the TV has stored all of the available digital channels in memory you will find that some channels are too weak to watch comfortably or they may be channels you do not want to see. Press **OK** to select the channel to be skipped when using **▲** or **▼**. An **X** will appear in channels you have selected to skip. You will still be able to select this channel using the number buttons on the remote control.

Analog MTS

This feature allows you to select the different languages the broadcaster is transmitting the audio with the program you are watching. This signal is usually Spanish. Choose from **Mono**, **Stereo**, or **SAP**.

Digital MTS

This feature allows you to select the different languages the broadcaster is transmitting the audio with the program you are watching. This signal is usually Spanish. Choose from **English**, **French**, or **Spanish**.



Name Input

This feature makes it easier for you to recognize the devices you have connected to your HDTV when you press **INPUT**. For example, if you have a Blu-Ray DVD player connected to the HDMI1 input, you can have the input label read *HDMI-1 BluRay* instead of just *HDMI-1*. You can select from 10 preset labels or you can make your own custom label that is up to 24 characters long and contains letters, numbers, and/or symbols.

To use one of the 10 preset labels:

1. Highlight **Input Source**, and then press **OK** to show the list of inputs.
2. Press **▼** to select the input label you want to change, and then press **OK**.
3. Highlight **Input Labels**, and then press **OK** to show the list of 10 preset labels.
4. Press **▼** to select the new input label name, and then press **OK**.

To make your own custom label:

1. Highlight **Input Source**, and then press **OK** to show the list of inputs.
2. Press **▼** to select the input label you want to change, and then press **OK**.
3. Press **▼** until the cursor is in the blank space under *Input Labels*.
4. Slide the remote control open and begin typing in a new label name. You can also select **Show Keyboard** and use the on-screen keyboard instead of the remote control.
5. Highlight and select **Done** when you have finished changing the names of the input labels.

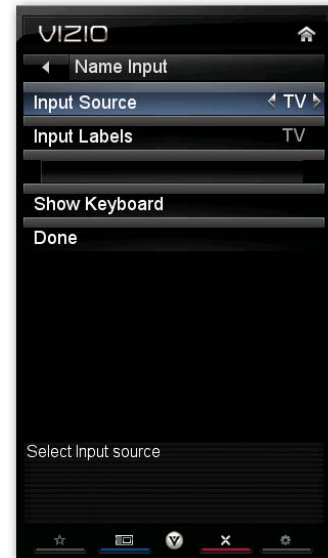

Device Setup

This feature allows you to add devices to your HDTV and control them with your VIZIO remote control. This feature was also available during the initial *Setup App*. Note: The feature is not available in TV mode. Once the input source is changed from TV to the selected device input, the remote will control that device. **Note:** this option is not available when the *Input Source* is set to **TV**.

Input Source

Select the input source your device is connected to on your HDTV. Choose from **TV**, **AV** (Composite), **Comp** (Component), **HDMI-1**, **HDMI-2**, **HDMI-3**, **HDMI Side**, and **RGB** (VGA).

Pick Device Type

Select the type of device that is connected to your HDTV. Choose from **VCR**, **DVD Player**, **Blu-Ray Player**, **Sat Receiver**, **Cable Box**, **DVR**, or **None**.

Pick Device Brand

Select the brand name of the device that is connected to your HDTV. The brand names will vary based on the device type selected above.

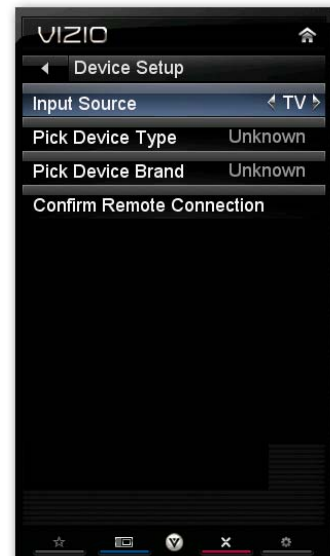

Confirm Remote Connection

Automatically program the VIZIO remote control to allow it to control your device.

1. Turn the device on.
2. Point the VIZIO remote directly at the device.
3. Press **OK** to select **Confirm Remote Connection**. The TV will attempt to communicate with the device.
4. Point the VIZIO remote at the device and the press the **Input power** button. The device should turn off. If it does, select **It worked** and press **OK**. If it does not power off, select **Try the Next Code**. Repeat until you find a code that works.

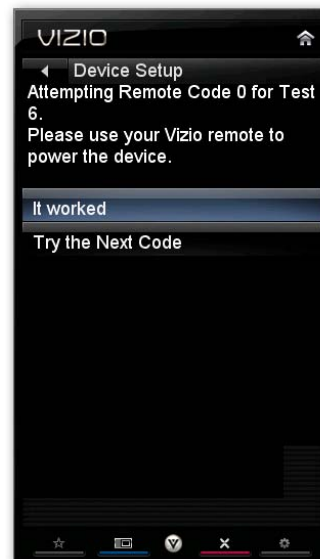

Parental Controls

If you want to restrict certain channel and program viewing, you can do this by turning on the Parental Control. Selected programs, movies and channels can then be made available only after an authorized password has been entered and accepted by the TV.

To select the options in the Parental sub-menu, press **OK** and then enter a password. The default password set in the factory is **0 0 0 0**.

Note: The Parental menu does not appear when the input mode is set to HDMI.

A new menu will be displayed showing the following Parental settings:

Rating Enable

Select from **ON** or **OFF**. If set to **OFF**, you will not be able to set the USA-TV, USA-Movie, CAN-English, or CAN-French Ratings.

Channel Locks

Block individual channels from being displayed.

USA-TV

Note: When Enable Ratings is set to **OFF**, USA-TV adjustments are not available.

Press **OK** to block (locked) or allow (unlocked) channels by the following US TV ratings:

- TV-Y—All children
- TV-Y7—Older children
- TV-G—General audience
- TV-PG—Guidance suggested
- TV-14—Strongly cautioned
- TV-MA—Mature audience

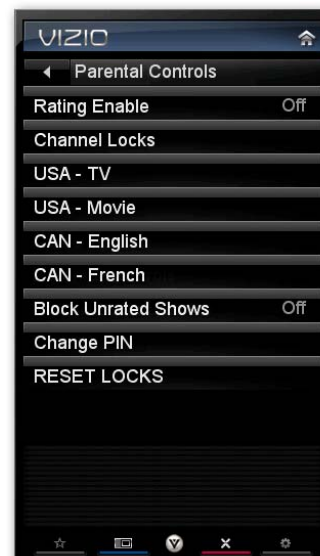

You can also customize the TV ratings for the following content:

- A—All sub-ratings
- D—Sexual dialog
- L—Adult language
- S—Sexual situations
- V—Violence
- FV—Fantasy violence

USA-Movie

Note: When Enable Ratings is set to **OFF**, USA-Movie adjustments are not available.

Press **OK** to block (locked) or allow (unlocked) channels by the following US Movie ratings:

- G—General audience
- PG—Parental guidance suggested
- PG-13—Recommended for children 13 years of age or older
- R—Mature audience
- NC-17—No one under 17 years of age
- X—No one under 17 years of age

CAN-English

Note: When Enable Ratings is set to **OFF**, CAN-English adjustments are not available.

Press **OK** to block (locked) or allow (unlocked) channels by the following Canadian English ratings:

- C—Children
- C8+—Children 8 years or older
- G—General Programming, suitable for all audiences
- PG—Parental guidance
- 14+—Viewers 14 years or older
- 18+—Adult programming

CAN-French

Note: When Enable Ratings is set to **OFF**, CAN-French adjustments are not available.

Press **OK** to block (locked) or allow (unlocked) channels by the following Canadian French ratings:

- G—General audience
- 8 ans+—General – not recommended for young children
- 13 ans+—Not suitable for children under 13 years of age
- 16 ans+—Not suitable for under 16 years of age
- 18 ans+—Adults only

Block Unrated Shows

Block programming that does not have a rating.



Change PIN

Enter a new, 4-digit password using the number buttons on the remote control. Enter it a second time to confirm you entered it correctly.

Note: Make sure you write down and store the new password in a secure place. The Reset Locks feature does NOT reset the password.

RESET LOCKS

Return all Parental Control lock settings to factory default. A screen will come up to confirm your selection or to cancel it. Press ◀ or ▶ to make the selection, and then press **OK** to accept it.

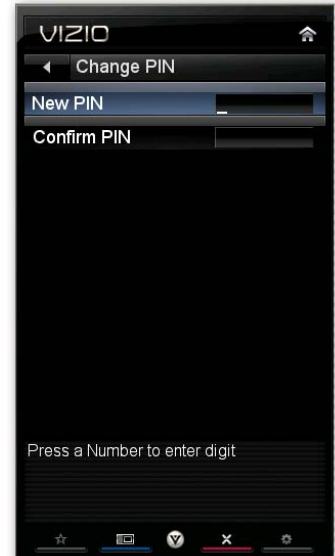
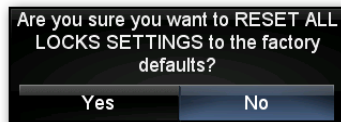

Menu Language

Select to change the language of the menu. The default is **English**. You can also select **French** or **Spanish**.

Time & Local Settings

Time Zone

Setting the correct Time Zone for your area will ensure that the correct program times are shown after pressing **GUIDE**.

Daylight Saving

Setting the daylight saving time for your area will ensure that the correct program times are shown after pressing **GUIDE**.

Postal Code

Enter your 5-digit postal (ZIP) code to receive content personalized for your location.



PIP Menu

Your TV features PIP mode so you can watch two pictures at the same time. One picture is displayed as the full screen (main screen) and the other picture is displayed in a small window (sub screen).

Note: PIP is only available when the *Rating Enable* option in *Parental Controls* is set to **Off**.

PIP Mode

Select from **Off**, **PIP** (Picture-inside-picture) or **POP** (Picture-outside-picture). In **PIP** mode a smaller sub-screen is displayed on top of the main screen. In **POP** mode the main screen and sub-screen are of equal size and are positioned side-by-side.



PIP Source

Select the input source for the sub-screen. The input sources available will vary according to which input is used for the main screen.

MAIN \ SUB	SUB				
	TV	AV (Composite)	Comp (Component)	HDMI-1 HDMI-2 HDMI-3 HDMI Side	RGB (VGA) (Computer)
TV			✓	✓	✓
AV (Composite)			✓	✓	✓
Comp (Component)	✓	✓		✓	
HDMI-1	✓	✓	✓		✓
HDMI-2	✓	✓	✓		✓
HDMI-3	✓	✓	✓		✓
HDMI Side	✓	✓	✓		✓
RGB (VGA) (Computer)	✓	✓		✓	

“✓” – Indicates which inputs are available for PIP and POP modes.

Position

Select where you want the PIP screen positioned over the main screen. Choose from **Top Left**, **Top Right**, **Bottom Left**, and **Bottom Right**.

Size

Set the size of the PIP window. Choose from **Small**, **Medium** or **Large**.

Audio

Select which source will play the audio. Choose from the **Main** screen or the **PIP** (sub) screen.



Network Menu

When you first turned on your HDTV you set up your network connection using the *Setup App*. If you did not do this or if your setup has changed, you can do this from the Network menu.

The Ethernet function on your HDTV is used to access the Internet. Your HDTV also has 802.11n dual-band wireless, so you can connect your TV to the Internet through your wireless home network. A wired connection may deliver a more consistent connection depending on the conditions in your home environment. When you enter the *Network Menu* you will see your current connection method.

Wired Connection

View that your wired connection is set to *Connected*. This is not an option that you can adjust. It is for information only.

Manual Setup

Select to view and/or manually change your network settings.

Change Settings

Select to manually change your network settings such as the **IP Address**, the **Subnet Mask**, the **Default Gateway**, the **Preferred DNS Server**, and the **Alternate DNS Server**.

Warning: unless you are an advanced user and are comfortable with wired and wireless networks, do not adjust these settings.

Test Connection

Select this option to test your network connection.

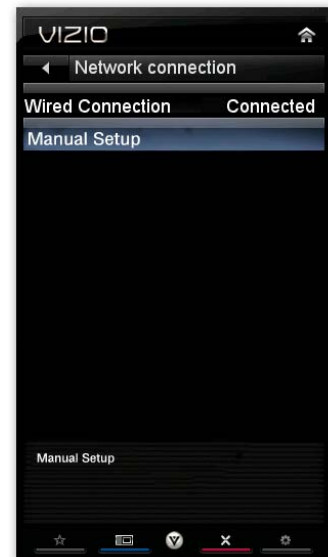

Wireless Connection

Wireless Access Points

If there is no wired connection, the wireless menu will be displayed and you will see a list of available wireless networks. You will also see that your *Wired Connection* is set to *Disconnected*.

1. Press ▼ to select your wireless network, and then press **OK**. If you do not see your wireless network in the list, select **More Access Points** and then press **OK**.
2. If the network is password protected, enter the secure access code you created when setting up your wireless router. Slide the remote control open and begin typing in the code. You can also select **Show Keyboard** and use the on-screen keyboard instead of the remote control. When you are finished entering the code, select **Connect**.

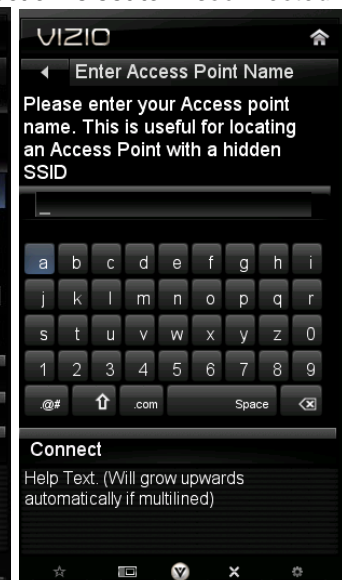

Note: If you have forgotten your secure access code, please refer to the user manual for your wireless router or contract the manufacturer or either your router or your Internet Service Provider if they provided the router for you.



More Access Points

Select this option to show more wireless networks in the list.

Select this option to refresh the list of available wireless networks.

Manual Setup

Warning: unless you are an advanced user and are comfortable with wired and wireless networks, do not adjust these settings.

- **Change Settings:** Use this option to manually enter the advanced settings of your network, such as the **IP Address**, the **Subnet Mask**, the **Default Gateway**, the **Preferred DNS Server**, and the **Alternate DNS Server**.
- **Test Connection:** Select this option to test your network connection.

Enter Access Point Name

Select this option to connect to hidden networks. Slide the remote control open and begin typing in the name of the network (SSID).

Note: If you are not sure of the name of your hidden wireless network, or need additional help seeing up your wireless network, please refer to the user manual for your wireless router or contract the manufacturer or either your router or your Internet Service Provider if they provided the router for you.

Bluetooth Menu

The menu allows you to pair (activate) your VIZIO remote control and other Bluetooth devices to work with your HDTV. Future automatic product updates may add support for other Bluetooth devices. When you enter the menu you will see a list of currently paired devices.

Unpair Devices

Select to unpair Bluetooth devices other than the VIZIO remote control. The VIZIO remote that came with your HDTV cannot be unpaired.

Pair Devices

Select to pair the VIZIO remote or to search for other Bluetooth devices.

1. Turn on your Bluetooth device and set it to pairing mode. See the user manual that came with your device for more information.
2. Select **Start Searching for Devices** with your remote.
3. When the search is complete, the device will appear in the list of currently paired devices.
4. Press **BACK** to return to the previous menu.

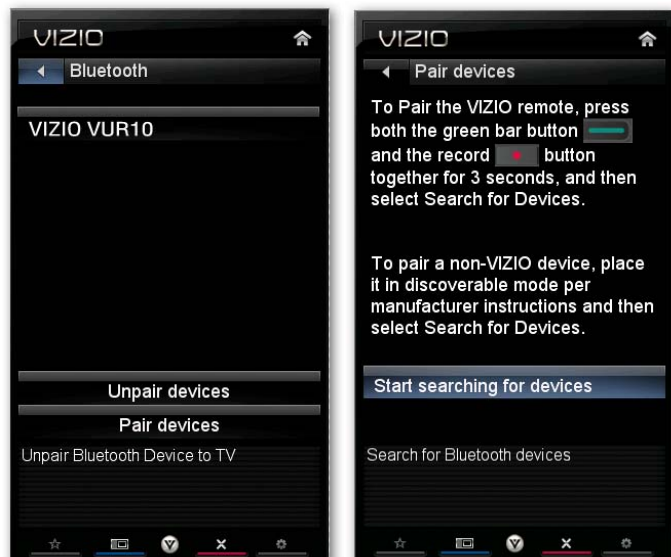

Help Menu

System Info

Display information about your TV, such as the model name and current software version.

Reset All Settings/Presets

Return all Picture and Audio settings to factory default. A screen will come up to confirm your selection or to cancel it. Press ◀ or ▶ to make the selection, and then press **OK** to accept it.

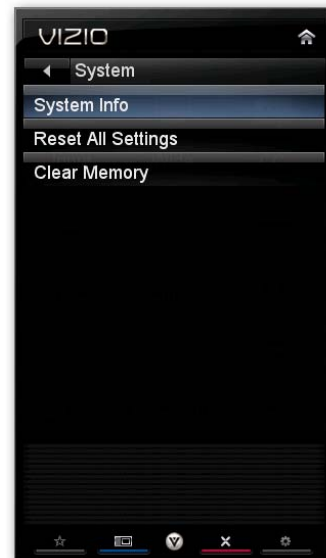
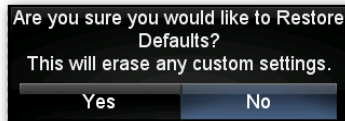

Clear Memory (Factory Default)

Return all settings to factory default, including your App settings, user names, and passwords. VIZIO recommends doing this in the unlikely event that you will need to return your TV.

1. Enter your 4-digit password to access the Parental menu. The default password is **0000**. A screen will come up to confirm your selection or to cancel it.
2. Press ◀ or ▶ to make the selection, and then press **OK** to accept it. Your memory will be cleared and your system will restart.
3. Complete the initial *Setup App* to setup your TV.

PLEASE USE THE CLEAR MEMORY FEATURE TO ERASE ALL PERSONAL SETTINGS BEFORE RETURNING THE TV.



Chapter 8 Maintenance and Troubleshooting

Cleaning the TV and Remote Control

1. Remove the power cable from the wall outlet.
2. Use a soft cloth moistened with diluted neutral cleaner to clean the TV and remote control. VIZIO recommends using an HDTV cleaning solution which can be purchased at any major retailer.
3. Wring water out of the cloth before cleaning to prevent water from penetrating into the housing.
4. Wipe the TV and remote control with a dry cloth after cleaning.

Important:

- Do not use volatile solvent (such as toluene, rosin and alcohol). Such chemicals may damage the housing, screen glass, and remote control, and cause paint to peel.
- The screen glass is very fragile. Do not scrape it with any sharp object.
- Do not press or tap the screen to avoid cracking.

Troubleshooting Guide

If the TV fails or the performance changes dramatically, check the display in accordance with the following instructions. Remember to check the peripherals to pinpoint the source of the failure. If the display still fails to perform as expected, contact the VIZIO for assistance by calling **877-MYVIZIO** (877-698-4946) or e-mail us at techsupport@VIZIO.com.

TV/Display Troubleshooting

Issue	Solution
“No Signal” is shown on display	<ul style="list-style-type: none"> • Press INPUT to select the correct input source for the device you are attempting to use. • Insure that the desired device is powered ON. • Check the connections of external devices that may be connected to your HDTV • Check video/device cable integrity. Try another cable (HDMI, Component, AV/Composite, Coax etc.)
“No RGB Signal. Power will be turned off” is shown on display	<ul style="list-style-type: none"> • When using the RGB Input to connect to a computer, please insure that a supported PC desktop resolution is first selected. • If no computer is connected, press INPUT to select a different input source. • Note: If no computer is connected, and the input is not changed, the television will power off.
No power (VIZIO logo is off)	<ul style="list-style-type: none"> • Make sure your AC power cable is securely connected to the back of the television and wall outlet. • Plug another electrical device into the outlet to insure the outlet is working correctly. • Try another electrical outlet elsewhere in your home. Preferably on a different circuit. • Try another AC power cable. Any standard 3 prong, grounded, UL approved computer power cable can provide power to your television.



Issue	Solution
<p>Power is ON but there is no image on the screen / Black screen</p>	<ul style="list-style-type: none"> • Make sure the power is ON (VIZIO Logo glows white). • Make sure all cables attached to your HDTV are connected to the correct output of your external device. • Insure that the external device is powered ON • Adjust brightness, contrast or backlight. • Press INPUT to select the correct input source. • Note: Your HDTV will display the television station or program selected by the cable box, VCR, external tuner, or satellite receiver. Use the remote control that came with that component to change programs or channels • Perform a power cycle by: Removing the AC power cable from the back of your television for 30 seconds. Reinsert the power cable and power on the television
<p>Wrong or abnormal colors/patterns</p>	<ul style="list-style-type: none"> • Check color and tint settings in the <i>Picture Menu</i>. • Reset Picture settings to default in the <i>Picture Menu</i>. • Check the video settings and compatibility of external devices • Check the video cables of external devices to make sure they are securely connected at both ends. • Try another device on the same input. • If you are using an antenna, the signal strength of the channel may be low. Make sure your antenna is connected securely to the TV and move the antenna to an alternate location in the room or close to a window. • Perform a power cycle by: Removing the AC power cable from the back of your television for 30 seconds. Reinsert the power cable and power on the television.
<p>Side Control buttons do not work</p>	<ul style="list-style-type: none"> • Press only one button at a time. • Perform a power cycle by: Removing the AC power cable from the back of your television for 30 seconds. Reinsert the power cable and power on the television
<p>Poor image quality</p>	<ul style="list-style-type: none"> • Standard Definition images will always be noticeably inferior to HD Quality content. Press INFO to see what the current resolution of the image is. 720p, 1080i, and 1080p are all HD quality resolutions. • Check the video settings of your external device. • If you are using an antenna, the signal strength of the channel may be low. Make sure your antenna is connected securely to the TV and move the antenna to an alternate location in the room or close to a window. • Reset Picture settings to default in the <i>Picture Menu</i>. • Check video/device cable integrity. Try another cable (HDMI, Component, AV/Composite, Coax etc.) • Perform a power cycle by: Removing the AC power cable from the back of your television for 30 seconds. Reinsert the power cable and power on the television.
<p>Distorted image or unusual sound</p>	<ul style="list-style-type: none"> • Check video/device cable integrity. Try another cable (HDMI, Component, AV/Composite, Coax etc.) • Try the external device on another input. • Perform a power cycle by: Removing the AC power cable from the back of your television for 30 seconds. Reinsert the power cable and power on the television. • Interference from electrical appliances, cars, motorcycles, or fluorescent lights may affect television performance. If possible, move your HDTV to an alternate location within your home.



Issue	Solution
<p>Display image does not cover the entire screen/ Black bars on the top or side of the image</p>	<ul style="list-style-type: none"> • Go to the Wide menu in <i>HDTV Settings</i> to view the available aspect modes • Check the video settings of your external device. • If using the RGB input (Computer), a supported PC desktop resolution must be used. • If using the RGB input (Computer), Go to the Picture menu and select Auto Adjust to fit the PC desktop to your HDTV.. • Note: Depending on the resolution of the content being viewed, some modes may not be available.
<p>The TV has pixels (dots) that are always dark or colored</p>	<ul style="list-style-type: none"> • Check video/device cable integrity. Try another cable (HDMI, Component, AV/Composite, Coax etc.) • Check other Inputs and external devices. • Remove all external devices to see if issue remains. • Perform a power cycle by: Removing the AC power cable from the back of your television for 30 minutes to 1 hour. Reinsert the power cable and power on the television
<p>Image “noise/fuzz”</p>	<ul style="list-style-type: none"> • When your HDTV’s capabilities exceed a digital broadcast signal, the signal is up-converted (increased) to match your TV’s display capabilities. Up-converting can cause image “noise” or “fuzz”. • If you are using an antenna, the signal strength of the channel may be low. Make sure your antenna is connected securely to the TV and move the antenna around the room or close to a window. • Check the video settings of your external device. • Check video/device cable integrity. Try another cable (HDMI, Component, AV/Composite, Coax etc.) • Try the device on another input. • Perform a power cycle by: Removing the AC power cable from the back of your television for 30 seconds. Reinsert the power cable and power on the television.
<p>Aspect mode differs on each input</p>	<ul style="list-style-type: none"> • Your HDTV retains the viewing mode from the last time you used a particular input (AV, Component, HDMI and TV).
<p>Tips for High-Definition Users</p>	<ul style="list-style-type: none"> • Your HDTV is an ideal platform for viewing High Definition Content. • Best image quality will be achieved by using an HDMI cable and input. The next best is Component, followed by Composite. Note: Composite (AV and S-Video inputs) cannot carry an HD quality image signal. • Due to variances in broadcast practices, it is possible some image distortions can occur.
<p>Tips for Letterbox Content</p>	<ul style="list-style-type: none"> • Some Letterboxed (or “Widescreen”) versions of DVD movies are formatted for standard 4:3 Televisions. Your HDTV has the ability to expand this content so the entire screen is filled at the expense of image accuracy. To use this function, select Wide from the <i>HDTV Settings App</i>.



Audio Troubleshooting

Issue	Solution
No audio	<ul style="list-style-type: none"> • Press Volume + (Up) on the remote control or side of the TV. • Press MUTE on the remote control to make sure that MUTE is not ON. • Check the MTS Audio settings in the <i>Tuner</i> menu to insure they are set to Stereo/English. (TV input only) • Verify that the TV Speakers are On in the <i>Audio</i> menu. • Check the video/device cable integrity. Try another cable (HDMI, Component, AV/Composite, Coax etc.) • Change audio settings of the external device. • If you are using an antenna, the signal strength of the channel may be low. Make sure your antenna is connected securely to your HDTV and move the antenna to an alternate location in the room or close to a window.
Audio volume differs on each input	<ul style="list-style-type: none"> • Your HDTV will retain the last used volume level for each input.
Low audio volume (TV internal speakers)	<ul style="list-style-type: none"> • Press the Volume up on the remote control. • Increase the volume of the external device using that device's remote.
Distorted/popping audio	<ul style="list-style-type: none"> • Check video/device cable integrity. Try another cable (HDMI, Component, AV/Composite, Coax etc.) • Insure audio cables are tightly inserted into inputs. • Try another device. • Use another device input.

Bluetooth Troubleshooting

Issue	Solution
Unable to pair the VIZIO Universal Remote Control to the TV	<ul style="list-style-type: none"> • Insure that new batteries are inserted correctly into the remote. • Clear any previously saved pairing information in the remote using the following steps: Open your Slider to expose your VUR10's keyboard. Press and hold the Q, P, and SPACE keys for approximately 10 seconds. Release all keys and remove the batteries from the remote. Once removed, wait 3 seconds before reinserting the batteries. Attempt the pairing procedure again.
Unable to pair another Bluetooth device to the TV	<ul style="list-style-type: none"> • At the time of this publication, the pairing of other Bluetooth devices is not supported by your television. Please check www.vizio.com for the latest product updates as this may change.

VIZIO Internet Apps Troubleshooting

Issue	Solution
The installed apps are not working correctly	<ul style="list-style-type: none"> • If you are experiencing an issue with the functionality or features of an App, please contact the App publisher directly. Click the green button while in the Apps Sidebar view to see help information from the publisher. • Note: VIZIO is not responsible for customer service related to content and/or services provided by the third parties who create the Apps. Any questions or requests for service relating to the content or services should be made directly to the specific App service providers



Remote Control Troubleshooting

Issue	Solution
<p>The remote control will not work</p>	<ul style="list-style-type: none"> Point the remote control directly at the remote sensor on your TV (IR mode only). Remove any obstacles between the remote control and the remote sensor (IR mode only). Replace dead batteries with new ones. Your remote's keyboard will not work unless it has been Bluetooth paired to your VIZIO television. Please Bluetooth pair your remote to improve response and performance.
<p>The remote control will not adjust TV Volume.</p>	<ul style="list-style-type: none"> Check the Advanced Audio menu located in the <i>HDTV Settings App</i>. Audio control must be set to TV.
<p>Channel Up and Down buttons will not work.</p>	<ul style="list-style-type: none"> In the <i>HDTV Settings App</i>, select Tuner, then Auto Channel Scan. This must be performed before attempting to change channels.

Internet Connection Troubleshooting

Issue	Solution
<p>I forgot my secure access code.</p>	<ul style="list-style-type: none"> Refer to the user manual for your wireless router or contact the manufacturer of either your router or your Internet Service Provider if they provided the router for you.
<p>Wireless Connection Issues</p>	<ul style="list-style-type: none"> Refer to the user manual for your wireless router or contact the manufacturer of either your router or your Internet Service Provider if they provided the router for you. Make sure the Internet connection is setup correctly. See <i>Network Menu</i> on page 50 for more information. Test the Internet connection to make sure it is working. See <i>Network Menu</i> on page 50 for more information. Disable MAC address filtering in your wireless router. Update your wireless router or device with the latest software available from the manufacturer's website. Use the correct password and or passphrase to connect to a secured network. Check the network connectivity with other devices (such as a laptop or desktop computer). If these devices also cannot connect, please reference your wireless device's User Manual for further configuration assistance. Try a wired (Ethernet) cable directly from your broadband modem's output connection. A wired connection may deliver a more consistent connection depending on the conditions in your home environment.
<p>Ethernet (Wired) Connection Issues</p>	<ul style="list-style-type: none"> Ensure that the Ethernet cable is securely inserted into your access point and the back of the television. Make sure the Internet connection is setup correctly. See <i>Network Menu</i> on page 50 for more information. Test the Internet connection to make sure it is working. See <i>Network Menu</i> on page 50 for more information. Check network connectivity with other devices (such as a laptop or desktop computer). Once an active Ethernet cable is plugged into your HDTV, you will see both green and amber link lights. If you require further assistance, please contact your Internet Service Provider.



Telephone & Technical Support

Products are often returned due to a technical problem rather than a defective product that may result in unnecessary shipping charges billed to you. Our trained support personnel can often resolve the problem over the phone. For more information on warranty service or repair, after the warranty period, please contact our Support Department at the number below.

Customer support and quality service are integral parts of VIZIO's commitment to service excellence.

For technical assistance contact our VIZIO Technical Support Department via email or phone.

Email: techsupport@VIZIO.com

(877) 698-4946 Fax: (949) 585-9563

Hours of operation: Monday - Friday: 6 am to 9 pm

Saturday – Sunday: 8 am to 4 pm

Please have your VIZIO model number, serial number, and date of purchase available before you call.

VIZIO

Address:

39 Tesla

Irvine, CA 92618, USA

Telephone: (888) 849-4623 (949) 428-2525 Fax: (949) 585-9514

Web: www.VIZIO.com

Compliance

Caution: Always use a power cable that is properly grounded. Please use the AC cords listed below for each area.

USA: UL

Canada: CSA

Germany: VDE

UK: BASE/BS

Japan: Electric Appliance Control Act

FCC Class B Radio Interference Statement

NOTE: This equipment has been tested and found to comply with the limits for a Class B digital device, pursuant to Part 15 of the FCC Rules. These limits are designed to provide reasonable protection against harmful interference in a residential installation. This equipment generates, uses and can radiate radio frequency energy, and if not installed and used in accordance with the instructions, may cause harmful interference to radio communications. However, there is no guarantee that interference will not occur in a particular installation. If this equipment does cause harmful interference to radio or television reception, which can be determined by turning the equipment off and on, the user is encouraged to try to correct the interference by one or more of the following measures:

1. Reorient or relocate the receiving antenna.
2. Increase the separation between the equipment and receiver.
3. Connect the equipment into an outlet on a circuit different from that to which the receiver is connected.
4. Consult the dealer or an experienced radio/TV technician for help.

Notice:

1. The changes or modifications not expressly approved by the party responsible for compliance could void the user's authority to operate the equipment.
2. Shielded interface cables and AC power cord, if any, must be used in order to comply with the emission limits.
3. The manufacturer is not responsible for any radio or TV interference caused by unauthorized modification to this equipment. It is the responsibilities of the user to correct such interference.



Chapter 9 Specifications

Specifications		
Panel	46.96" Diagonal, 16:9 Aspect Ratio	
Resolution	1920 x 1080 pixels	
Pixel (Dot) Pitch	0.5415mm(H) x 0.5415mm(V)	
Display Compatibility	FHDTV (1080P)	
Colors	1.06 Billion	
Brightness cd/m² (typical)	500nits	
Dynamic Contrast Ratio	2,000,000:1	
Response Time	5ms (typical)	
Viewing Angle	178° (horizontal/vertical)	
Rear Inputs	3x HDMI w/HDCP 1x Composite Video and stereo audio (stereo audio shared with S-Video) 1x S-Video	1x Component and stereo audio 1x RGB 1x RF (stereo audio shared with S-Video input)
Side Inputs	1x HDMI w/HDCP 3x USB (service only)	
Outputs	1x SPDIF Optical Digital Audio, 1x Stereo Audio	
Features	1080P FHDTV, HDMI v1.3a, 3D comb filter, Zero bright pixel guarantee, Dynamic Contrast Ratio technology, HD game port, Game mode, Noise reduction, 10-bit video processing, MTS stereo decoder, Digital amplifier, Dolby Digital for ATSC/QAM, Channel skip, Signal Compatibility:480i (SDTV), 480P (EDTV), 720P (HDTV), 1080i (HDTV), 1080P (FHDTV), Video/input naming capability, Closed caption, Parental control/V-Chip 2.0, Programmable Timer, PIP/POP, SRS TSHD, SRS TruVolume, Broadband Internet and Services Connectivity	
Special Features	<ul style="list-style-type: none"> • Smooth Motion™ • Smart Dimming • SRS TruVolume, SRS TSHD • Dynamic Contrast Ratio (DCR) • Optimal Power Control (OPC) 	
Wireless	802.11n	
Bluetooth	HID, A2DP, AVRCP	
Speakers	2x Built-in, 15W Speakers	
Panel Life	50,000 hours to half the original brightness	
Power		
Input	IEC Connector for direct power line connection	
Voltage Range	100~240Vac at 50/60Hz	
Power On Consumption	130W (Avg), <1W standby	



Environmental Conditions	
Operating	Temperature: 5°C~35°C, Relative Humidity: 20~80%, Altitude: 0~14,000 ft
Non-Operating	Temperature: -20°C~50°C, Relative Humidity: 10~70%, Altitude: 0~40,000 ft
Dimensions	43.9"W x 29.7" H x 10" D with stand; 43.9" W x 28.1" H x 4.1" D without stand
Net Weight	51.8 lbs without stand, 46.52 lbs with stand
Gross Weight	71.4 lbs
Certifications	CSA, CSA-US, FCC Class B , BQB
Compliances	Energy Star 3.0. ATSC Spec A/65, EIA/CEA-766-A

*Product specifications may change without notice or obligation.

Note: The Federal Communications Commission (FCC), the Consumer Electronics Association (CEA) and the Consumer Electronics Retailers Coalition (CERC) have made a new tip sheet available for digital television (DTV) retailers to reproduce and distribute to consumers on the sales floor. The file may be downloaded online at www.dtv.gov. While you're there, check out the other useful information in the FCC is making available to consumers interested in learning more about the analog to digital transition.

Resolution through RGB Input

If your PC supports VESA Reduce Blanking timing via the RGB (VGA) card drive program (usually offered by the RGB (VGA) Card Manufacturer), your TV set is equipped to have the 1920x1080 resolution display through this connection using the following timing 138.5MHz. The following parameters are often the values required by the software or programs to set up the display:

Parameters	Horizontal Values (Pixels)	Vertical Values (Lines)
Address	1920	1080
Front Porch	48	3
Sync Width	32	5
Back Porch	80	23
Total	2080	1111
Frequency	66.587 kHz	58.934 Hz
Sync Polarity	P	N
Pixel Rate (MHz)	138.5	
Refresh Rate (Hz)	59.934	



Preset PC Resolutions

If connecting to a PC through the RGB PC input, set the TV timing mode to VESA 1920x1080 at 60Hz for better picture quality (refer to the graphic card's user guide for questions on how to set this timing mode). See the table below for the factory preset resolutions.

Mode No.	Resolution	Refresh Rate (Hz)	Horiz. Freq (KHz)	Vert Freq (Hz)	Horiz Sync Polarity (TTL)	Vert Sync Polarity (TTL)	Pixel Rate (MHz)	Remark
1	640 x 480	60	31.469	59.941	N	N	25.175	Windows
2	640 x 480	75	37.500	75.000	N	N	31.500	Windows
3	800 x 600	60	37.879	60.317	P	P	40.000	Windows
4	800 x 600	72	48.077	72.188	P	P	50.000	Windows
5	800 x 600	75	46.875	75.000	P	P	49.500	Windows
6	1024 x 768	60	48.363	60.004	N	N	65.000	Windows
7	1024 x 768	70	56.476	70.069	N	N	75.000	Windows
8	1024 x 768	75	60.023	75.029	P	P	78.750	Windows
9	720 x 400	70	31.469	70.087	N	P	28.322	DOS
10	Ⓢ1920 x 1080	60	66.587	59.934	P	N	138.50	Windows

Note: P: positive, N: negative, Ⓢ: Primary mode

Using a Cable or Satellite Box Remote

Your VIZIO remote uses codes 000, 047, 050, 067, 329, 331 and 339 to work your HDTV. To use a cable or satellite remote to control your HDTV, refer to your cable or satellite remote user guide for more information on how to program the remote.

If your cable or satellite remote uses a 5-digit code (like most Direct TV units), first try 11758 and then, if that does not work, 10178. If your cable or satellite remote uses a 4-digit code, try 1758 and then 0178 as an alternative. If your cable or satellite remote uses a 3-digit code (EchoStar or Dish Network for example), use code 627.

Note: Some buttons may not function as expected on your cable or satellite remote. Typically power, volume and mute will work.



Limited Product Warranty

VIZIO provides a “ONE-YEAR LIMITED WARRANTY” against manufacturing defects in materials and workmanship to the original purchaser of a new VIZIO display purchased from an authorized VIZIO U.S. reseller and used in the fifty (50) United States or Puerto Rico.

VIZIO's Responsibility

VIZIO displays purchased new from an authorized VIZIO U.S. reseller and that are used in the fifty (50) United States or Puerto Rico are warranted to be free from manufacturing defects in materials and workmanship for one (1) year from the date of the original retail purchase. If the display fails to conform to this limited warranty, VIZIO will, at its option and sole discretion, repair or replace the display.

Labor

During the one-year limited warranty period, VIZIO will provide, when needed, service labor to repair a manufacturing defect. Repairs required on displays which are thirty (30) inches and larger generally will be made “on-site” where the display is installed. The determination for performing the on-site repair is dependent upon the manufacturing defect and is at VIZIO's option and sole discretion. Repairs required on displays which are less than thirty (30) inches generally will be performed at a VIZIO service center.

Parts

Repairs may be made with new or recertified parts, or the entire unit may be replaced with a new or recertified unit, at VIZIO's option and sole discretion. Replacement parts or replacement units provided under this limited warranty are warranted for the remaining portion of the original warranty period, or for ninety (90) days from warranty service or replacement, whichever is later.

How to Obtain Warranty Service

To obtain warranty service, contact VIZIO Technical Support via email at TechSupport@VIZIO.com, via phone at 877-MYVIZIO (877-698-4946), or via postal mail at VIZIO Technical Support, 39 Tesla, Irvine, CA 92618. You must provide the model, serial number, and date of purchase. VIZIO Technical Support is available from 6:00AM to 9:00PM Pacific Time, Monday through Friday, and 10:00AM to 2:00PM Pacific Time, Saturday and Sunday. Please note that holiday hours may vary. For up to date information, please visit www.VIZIO.com.

VIZIO reserves the right to assess all warranty claims and to determine if defects or damages are covered by this limited warranty. In case of a claim that is not covered by this warranty, you will be contacted to determine whether VIZIO should repair the damage for a fee or whether the product should be returned to you as received by the service technician or service center.

Parts and service labor that are VIZIO's responsibility under this limited warranty will be provided without charge. All other service is at the customer's expense. VIZIO reserves the right to charge the customer for any service call for anything not covered by this limited warranty. Before you ask for warranty service, please review your User Manual. You may avoid a service call and a service charge.

Please refer to the reverse side of this page for additional information regarding how to obtain warranty service.

PLEASE DO NOT RETURN YOUR UNIT TO VIZIO WITHOUT PRIOR AUTHORIZATION.

Not Covered

This limited warranty does not cover the following: cosmetic defects; damage, malfunctions or failures resulting from shipping or transit, improper or faulty installation, abuse, operation contrary to furnished instructions, operation on incorrect power supplies, products not supplied by VIZIO, modification, alteration, improper servicing or tampering; damage from fire, water, lightning, power surges, abnormal environmental conditions or other acts of nature; normal wear and tear; unsatisfactory visual or audio performance not caused by a manufacturing defect; or displays with a missing or unreadable serial number. Operation of the display for commercial purposes or in applications or uses for which the display is not intended is not covered by this limited warranty. "Image Sticking", caused by static images on the screen for extended periods and or excessive brightness and contrast levels, is not covered by this



limited warranty. Installation, removal, transportation and reinstallation of a display, and routine maintenance and cleaning, are not covered by this limited warranty.

THERE ARE NO EXPRESS WARRANTIES OTHER THAN THOSE LISTED OR DESCRIBED ABOVE. ANY IMPLIED WARRANTIES, INCLUDING ANY IMPLIED WARRANTY OF MERCHANTABILITY AND FITNESS FOR A PARTICULAR PURPOSE, SHALL BE LIMITED IN DURATION TO THE PERIOD OF TIME SET FORTH ABOVE. VIZIO'S TOTAL LIABILITY FOR ANY AND ALL LOSSES AND DAMAGES RESULTING FROM ANY CAUSE WHATSOEVER, INCLUDING VIZIO'S NEGLIGENCE, ALLEGED DAMAGE, OR DEFECTIVE GOODS, WHETHER SUCH DEFECTS ARE DISCOVERABLE OR LATENT, SHALL IN NO EVENT EXCEED THE PURCHASE PRICE OF THE DISPLAY. VIZIO SHALL NOT BE RESPONSIBLE FOR LOSS OF USE, COMMERCIAL LOSS, LOST REVENUE OR LOST PROFITS, OR OTHER INCIDENTAL OR CONSEQUENTIAL DAMAGES. SOME STATES DO NOT ALLOW LIMITATIONS ON HOW LONG AN IMPLIED WARRANTY MENUS OR THE EXCLUSION OR LIMITATION OF INCIDENTAL OR CONSEQUENTIAL DAMAGES, SO THE ABOVE LIMITATIONS OR EXCLUSIONS MAY NOT APPLY TO YOU.

This warranty gives you specific legal rights, and you may also have other rights, which vary from state to state. This is the only warranty applicable; no one is authorized to extend or modify it or to grant any other warranty on VIZIO's behalf.

Owner's Responsibility

To ensure warranty service, keep the dated bill or sales receipt as evidence of the purchase date and location. This limited warranty applies only to original purchaser and is non-transferable.

Note: Warranty service conditions are subject to change. For the latest Warranty Terms and Conditions and additional information regarding VIZIO's Limited Product Warranty, please see complete details online at www.VIZIO.com.

VIZIO Return Policy

PLEASE USE THE CLEAR MEMORY FEATURE TO ERASE ALL PERSONAL SETTINGS BEFORE RETURNING THE PRODUCT.

VIZIO's return policy allows for products purchased directly from VIZIO to be returned by the original purchaser during the initial thirty (30) day period following the date of purchase. A VIZIO return authorization number must first be obtained as provided below. The refund will be the purchase price actually paid by the purchaser less a ten percent (10%) restocking fee per each item returned. Shipping and handling are not refundable.

The return authorization number must first be obtained from VIZIO's Customer Service by emailing CustomerSupport@VIZIO.com or by calling 949-428-2525, 6:00AM to 9:00PM Pacific Time, Monday through Friday, and 10:00AM to 2:00PM Pacific Time, Saturday and Sunday. Please note that holiday hours may vary. For up to date information, please visit www.VIZIO.com.

Products must be returned to the address specified by VIZIO Customer Service and must be shipped in the original packaging, with freight prepaid to VIZIO, and must be received in new and unused condition. The return authorization number must be included in the packaging. VIZIO reserves the right to assess fees for any damaged or missing parts in addition to the ten percent (10%) restocking fee.

Return authorization numbers are valid for only fifteen (15) days from issuance. The customer is responsible for and must prepay all shipping charges and shall assume all risk of loss or damage to the product while in transit to VIZIO. If the product is returned to VIZIO (i) without a VIZIO return authorization number, and/or (ii) beyond the fifteen (15) day period, and/or (iii) without proper packaging, VIZIO retains the right to refuse delivery of such return or may return the unit to the customer at the customer's expense and with no refund issued. This return policy does not apply to defective products. Please read VIZIO's Limited Product Warranty for warranty terms and conditions.



On-Site Warranty Repair Procedure

On-Site Warranty Repair generally is performed on repairable displays which are 30 inches and larger.

If VIZIO Technical Support determines that a problem with a display unit may be within the terms and conditions of the VIZIO Limited Product Warranty and that an on-site repair may be performed, the customer will be provided with an on-site repair authorization number and on-site repair instructions. The determination for performing the on-site repair may be dependent upon the manufacturing defect and is at VIZIO's option and sole discretion. Proof of purchase is required to confirm the product is within the one-year limited warranty period and meets the terms and conditions of the VIZIO Limited Product Warranty.

On-site repair service is requested through VIZIO's third-party service provider. After VIZIO provides the customer with the on-site repair (OSR) authorization number, the third-party service provider will contact the customer and will schedule the repair at the customer's location. The total approximate time for the repair process, which includes the repair diagnosis, dispatching the technician, shipping the replacement part(s), and arranging the appointment with the customer, is completed within approximately 3 to 5 business days, pending availability of these factors.

If it is determined the product can not be repaired on-site, the customer will be required to ship the unit to VIZIO's service center, per the below warranty replacement procedure.

VIZIO is not responsible for the de-installation or re-installation of the product. However, some standard installation may be performed during the on-site repair, at VIZIO's option and sole discretion. Please read VIZIO's Limited Product Warranty for warranty terms and conditions.

Warranty Replacement Procedure

Warranty Replacement generally is performed on displays which are determined to be economically unrepairable.

If VIZIO Technical Support determines that a problem with a display unit may be within the terms and conditions of the VIZIO Limited Product Warranty and that a repair is not economically possible, based on certain manufacturing defects in materials and/or workmanship, and/or at VIZIO's option and sole discretion, the customer will be provided with a return authorization number and replacement instructions. Proof of purchase is required to confirm the product is within the one-year limited warranty period and meets the terms and conditions of the VIZIO Limited Product Warranty.

For displays forty-two inches (42") and larger, VIZIO will generally cover the transportation charges to perform an on-site swap of the original unit with the replacement unit. For displays under forty-two inches (42"), the customer is responsible for the transportation charges to VIZIO's service center. VIZIO will be responsible for the return transportation charges from the service center to the customer. Please read VIZIO's Limited Product Warranty for warranty terms and conditions.

Mail-In Warranty Repair Procedure

Mail-In Warranty Repair generally is performed on displays which are smaller than 30 inches.

If VIZIO Technical Support determines that a problem with a display unit may be within the terms and conditions of the VIZIO Limited Product Warranty and that a mail-in repair may be performed, the customer will be provided with a return authorization number and mail-in repair instructions. Proof of purchase is required to confirm the product is within the one-year limited warranty period and meets the terms and conditions of the VIZIO Limited Product Warranty.

The customer will be provided with instructions for packing and shipping the unit to the VIZIO service center. The original carton box and packing material, or an equivalent as designated by VIZIO, must be utilized. The cost of shipping to VIZIO's service center is at the customer's expense. After the product is repaired and tested, the VIZIO service center will ship the unit back to the customer at VIZIO's expense. VIZIO is not responsible for the de-installation or re-installation of the product. Please read VIZIO's Limited Product Warranty for warranty terms and conditions.

PLEASE DO NOT RETURN YOUR UNIT TO VIZIO WITHOUT PRIOR AUTHORIZATION.



VIZIO Internet Applications Disclaimer

VIZIO Internet Applications ("VIA") affords the opportunity to access third party Internet product offerings or services ("VIA Services") on certain VIZIO TVs. The VIA Services accessible herein are provided as per our agreement with these third parties. These agreements are subject to change, interruption, suspension (including termination) at any time and for various reasons. VIZIO makes no warranties or representations that any particular VIA Service will be accessible, available, function in any particular manner or function at all.

To use these VIA Services, you must obtain access to the Internet, either directly or through devices that access the Internet and pay any service fees associated with such access. In addition, you must provide all equipment necessary to make such connection to the Internet including a modem or other Internet access device.

VIZIO or said third parties providing VIA Services reserve the right to delete data from their servers, or prevent access to their servers or to change data categories, product offerings or service levels for any reason that VIZIO or said third parties deem sufficient in their sole discretion at any time, without notice. Some or all of the data or functionality of VIA Services may require additional payment by you. However, in no event will you be charged for any VIA Services unless those charges are made available to you in advance. VIZIO makes no warranties or representations of any kind as to the accuracy, currency, or completeness of any information contained on the data servers of such third party providers of any VIA Services. Furthermore, we do not review, control, or endorse the content, products or services of VIA Services or their data servers.

Your rights to use the widget links to access VIA Services is governed by the VIZIO Internet Applications Software License Agreement ("VIA Software License Agreement"), the terms of which are available in your Product Guide, all of which are incorporated herein by this reference. In the event of a conflict between this VIZIO Internet Applications Disclaimer and the VIA Software License Agreement, the VIA Software License Agreement shall control.

VIZIO INTERNET APPLICATIONS SOFTWARE LICENSE AGREEMENT

THE FOLLOWING AGREEMENT EXPLAINS HOW YOU MAY USE THE VIZIO INTERNET APPLICATIONS ("VIA") TO ACCESS THIRD PARTY INTERNET PRODUCT OFFERINGS AND SERVICES ("VIA SERVICES") AND THE VIZIO SOFTWARE INSTALLED ON YOUR VIZIO HD TV. BY USING THE VIZIO INTERNET APPLICATIONS, YOU CONSENT AND AGREE TO BE BOUND BY ALL OF THE TERMS AND CONDITIONS BELOW AND YOU MAY, SUBJECT TO THOSE TERMS AND CONDITIONS, USE THE VIZIO SOFTWARE AND ACCESS THE VIA SERVICES.

VIZIO SOFTWARE LICENSE AGREEMENT

The following terms and conditions govern the use of any software on your VIZIO HD TV:

1. General. The software, documentation and any fonts accompanying this License Agreement whether on disk, in read only memory, on any other media or in any other form (collectively the "VIZIO Software") are licensed, not sold, to you by VIZIO, Inc. ("VIZIO") for use only under the terms of this License Agreement, and VIZIO reserves all rights not expressly granted to you. The rights granted herein are limited to VIZIO's and its third party licensors' intellectual property rights in the VIZIO Software and do not include any other patents or intellectual property rights. You own the media on which the VIZIO Software is recorded or resides but VIZIO and/or its licensor(s) retain ownership of the VIZIO Software itself. The terms of this License Agreement will govern any software upgrades provided or made available by or through VIZIO that replace and/or supplement the original VIZIO Software, unless such upgrade is accompanied by a separate license in which case the terms of that license will govern.



2. Permitted Uses and Restrictions. This License Agreement allows you to use the VIZIO Software and, through functions solely found within the VIZIO HD TV, this Agreement also allows you to install upgrades thereto. The VIZIO Software may be used to access VIA Services and view materials so long as such use is limited to materials in which you are authorized or legally permitted to view. You may not make the VIZIO Software or VIA Services available over a network or where it could be used by multiple televisions at the same time. Except as and only to the extent expressly permitted in this License Agreement or by applicable law, you may not copy, decompile, reverse engineer, disassemble, modify, or create derivative works of the VIZIO Software or any part thereof. THE VIZIO SOFTWARE AND VIA SERVICES ARE NOT INTENDED FOR USE IN ANY EQUIPMENT OR ENVIRONMENT IN WHICH THE FAILURE OF THE VIZIO SOFTWARE OR VIA SERVICES COULD LEAD TO DEATH, PERSONAL INJURY, OR SEVERE PHYSICAL OR ENVIRONMENTAL DAMAGE.

3. Transfer. You may not rent, lease, lend, redistribute or sublicense the VIZIO Software or access to the VIA Services. You may, however, make a one-time permanent transfer of all of your license rights to the VIZIO Software to another party, provided that: (a) the transfer must include the VIZIO HD TV, including all its component parts, original media, printed materials and this License Agreement; (b) you do not retain any copies of the VIZIO Software, full or partial, including copies stored on a computer or other storage device; and (c) the party receiving the VIZIO HD TV and VIZIO Software reads and agrees to accept the terms and conditions of this License Agreement.

4. Consent to Use of Collected Data. You agree that VIZIO and its third party providers of VIA Services may collect and use technical, non-technical and related information, including but not limited to information about your use of the VIZIO Software, the VIA Services, content viewed and attached peripherals, products or services purchased, that is gathered periodically to facilitate the provision of software updates, product support and other services to you, including additional or different VIA Services related to the VIZIO Software and to verify compliance with the terms of this License Agreement. VIZIO and its third party providers of VIA Services and/or other providers may use this information, as long as it is in a form that does not personally identify you, to improve our products or to provide services or technologies to you.

5. VIA Services and other Services. The VIZIO software affords the opportunity to access third party Internet product offerings or services ("VIA Services"). The VIA Services accessible herein are provided as per our agreement with certain third parties. These agreements are subject to change, interruption, suspension, removal (including termination) at any time and for various reasons. Moreover, VIZIO or its third party providers of VIA Services reserve the right to delete data from their servers, or prevent access to their servers or to change data categories, product offerings or service levels for any reason that VIZIO or said third parties deem sufficient in their sole discretion at any time, without notice. VIZIO may also impose additional or different limits on the use of or access to certain VIA Services, in any case and without notice or liability. VIZIO makes no warranties or representations that any particular VIA Service will be accessible, available, function in any particular manner or function at all.

Use of the VIA Services may require you to accept additional terms of service or end user license agreements which will be presented to you before you can use such Services. Some or all of the data, functionality of VIA Services may require additional payment by you. However, in no event will you be charged for any VIA Services unless those charges are made available to you in advance.

6. Disclaimer as to Content on VIA Services. Certain VIA Services may include materials from third parties or links to certain third party data servers. You acknowledge and agree that VIZIO is not responsible for examining or evaluating the content or accuracy of any VIA Services, their data servers or related third-party materials. VIZIO does not warrant or endorse and does not assume and will not have any liability or responsibility for any third-party materials or websites, or for any other materials, products, or services of third parties. Links to VIA Services and any associated links to other data servers are provided solely as a convenience to you. To the extent provided, content types or descriptions of VIA Services provided for convenience, and you acknowledge and agree that VIZIO does not guarantee their accuracy. You understand that by using any of the VIA Services, you may encounter content that may be deemed offensive, indecent, or objectionable, which content may or may not be identified as having



explicit language. Nevertheless, you agree to use the VIA Services at your sole risk and that VIZIO shall have no liability to you for content that may be found to be offensive, indecent, or objectionable.

You agree that you will not use any third-party materials in a manner that would infringe or violate the rights of any other party, and that VIZIO is not in any way responsible for any such use by you.

7. Internet Access Required. To use these VIA Services, you must obtain access to the Internet, either directly or through devices that access the Internet and pay any service fees associated with such access. In addition, you must provide all equipment necessary to make such connection to the Internet including a modem or other Internet access device.

8. Upgrades, Support. VIZIO or its third party providers may elect, but shall be under no obligation, to provide you with customer support and/or software upgrades, enhancements, or modifications to the VIZIO Software or VIA Services (collectively, "Support"), in its sole discretion, and may terminate such Support at any time without notice to you. VIZIO and its third party providers reserve the right to charge you for any Support it provides but will make a schedule of those charges available to you prior to your incurring any costs.

9. Termination. This License is effective until terminated. Your rights under this License will terminate automatically without notice from VIZIO if you fail to comply with any term(s) of this License Agreement. Upon the termination of this License Agreement, you shall cease all use of the VIZIO Software and VIA Services.

10. Limited Warranty on VIZIO Media. VIZIO warrants the media on which the VIZIO Software is recorded and delivered by VIZIO to be free from defects in materials and workmanship under normal use for a period of ninety (90) days from the date of original retail purchase. Your exclusive remedy under this Section shall be, at VIZIO's option, a refund of the purchase price of the product containing the VIZIO Software or replacement of the VIZIO Software which is returned to VIZIO or a VIZIO authorized representative with a copy of the receipt. THIS LIMITED WARRANTY AND ANY IMPLIED WARRANTIES ON THE MEDIA INCLUDING, BUT NOT LIMITED TO, THE IMPLIED WARRANTIES OF MERCHANTABILITY, OF SATISFACTORY QUALITY, AND OF FITNESS FOR A PARTICULAR PURPOSE, ARE LIMITED IN DURATION TO NINETY (90) DAYS FROM THE DATE OF ORIGINAL RETAIL PURCHASE. SOME JURISDICTIONS DO NOT ALLOW LIMITATIONS ON HOW LONG AN IMPLIED WARRANTY LASTS, SO THE ABOVE LIMITATION MAY NOT APPLY TO YOU. THE LIMITED WARRANTY SET FORTH HEREIN IS THE ONLY WARRANTY MADE TO YOU AND IS PROVIDED IN LIEU OF ANY OTHER WARRANTIES (IF ANY) CREATED BY ANY DOCUMENTATION OR PACKAGING. THIS LIMITED WARRANTY GIVES YOU SPECIFIC LEGAL RIGHTS, AND YOU MAY ALSO HAVE OTHER RIGHTS WHICH VARY BY JURISDICTION.

11. Disclaimer of Warranties. YOU EXPRESSLY ACKNOWLEDGE AND AGREE THAT USE OF THE VIZIO SOFTWARE AND VIA SERVICES (AS DEFINED ABOVE) IS AT YOUR SOLE RISK AND THAT THE ENTIRE RISK AS TO SATISFACTORY QUALITY, PERFORMANCE, ACCURACY AND EFFORT IS WITH YOU. EXCEPT FOR THE LIMITED WARRANTY ON MEDIA SET FORTH ABOVE AND TO THE MAXIMUM EXTENT PERMITTED BY APPLICABLE LAW, THE VIZIO SOFTWARE AND VIA SERVICES ARE PROVIDED "AS IS", WITH ALL FAULTS AND WITHOUT WARRANTY OF ANY KIND, AND VIZIO AND VIZIO'S THIRD PARTY PROVIDERS OF VIA SERVICES AND THIRD PARTY LICENSORS (COLLECTIVELY REFERRED TO AS "VIZIO" FOR THE PURPOSES OF SECTIONS 10 AND 11) HEREBY DISCLAIM ALL WARRANTIES AND CONDITIONS WITH RESPECT TO THE VIZIO SOFTWARE AND SERVICES, EITHER EXPRESS, IMPLIED OR STATUTORY, INCLUDING, BUT NOT LIMITED TO, THE IMPLIED WARRANTIES AND/OR CONDITIONS OF MERCHANTABILITY, OF SATISFACTORY QUALITY, OF FITNESS FOR A PARTICULAR PURPOSE, OF ACCURACY, OF QUIET ENJOYMENT, AND NON-INFRINGEMENT OF THIRD PARTY RIGHTS. VIZIO DOES NOT WARRANT AGAINST INTERFERENCE WITH YOUR ENJOYMENT OF THE VIZIO SOFTWARE OR VIA SERVICES, THAT THE FUNCTIONS CONTAINED IN THE VIZIO SOFTWARE OR VIA SERVICES WILL MEET YOUR REQUIREMENTS, THAT THE OPERATION OF THE VIZIO SOFTWARE OR VIA



SERVICES WILL BE UNINTERRUPTED OR ERROR-FREE, OR THAT DEFECTS IN THE VIZIO SOFTWARE OR VIA SERVICES WILL BE CORRECTED. NO ORAL OR WRITTEN INFORMATION OR ADVICE GIVEN BY VIZIO OR A VIZIO AUTHORIZED REPRESENTATIVE SHALL CREATE A WARRANTY. SHOULD THE VIA/VIZIO SOFTWARE OR VIA SERVICES PROVE DEFECTIVE, YOU ASSUME THE ENTIRE COST OF ALL NECESSARY SERVICING, REPAIR OR CORRECTION. SOME JURISDICTIONS DO NOT ALLOW THE EXCLUSION OF IMPLIED WARRANTIES OR LIMITATIONS ON APPLICABLE STATUTORY RIGHTS OF A CONSUMER, SO THE ABOVE EXCLUSION AND LIMITATIONS MAY NOT APPLY TO YOU.

12. Limitation of Liability. TO THE EXTENT NOT PROHIBITED BY LAW, IN NO EVENT SHALL VIZIO BE LIABLE FOR PERSONAL INJURY, OR ANY INCIDENTAL, SPECIAL, INDIRECT OR CONSEQUENTIAL DAMAGES WHATSOEVER, INCLUDING, WITHOUT LIMITATION, DAMAGES FOR LOSS OF PROFITS, LOSS OF DATA, BUSINESS INTERRUPTION OR ANY OTHER COMMERCIAL DAMAGES OR LOSSES, ARISING OUT OF OR RELATED TO YOUR USE OR INABILITY TO USE THE VIZIO SOFTWARE OR VIA SERVICES, HOWEVER CAUSED, REGARDLESS OF THE THEORY OF LIABILITY (CONTRACT, TORT OR OTHERWISE) AND EVEN IF VIZIO HAS BEEN ADVISED OF THE POSSIBILITY OF SUCH DAMAGES. SOME JURISDICTIONS DO NOT ALLOW THE LIMITATION OF LIABILITY FOR PERSONAL INJURY, OR OF INCIDENTAL OR CONSEQUENTIAL DAMAGES, SO THIS LIMITATION MAY NOT APPLY TO YOU. In no event shall VIZIO's total liability to you for all damages (other than as may be required by applicable law in cases involving personal injury) exceed the amount of twenty five dollars (\$25.00). The foregoing limitations will apply even if the above stated remedy fails of its essential purpose.

13. Export Control. You may not use or otherwise export or re-export the VIZIO Software except as authorized by United States law and the laws of the jurisdiction in which the VIZIO Software was obtained. In particular, but without limitation, the VIZIO Software may not be exported or re-exported (a) into any U.S. embargoed countries or (b) to anyone on the U.S. Treasury Department's list of Specially Designated Nationals or the U.S. Department of Commerce Denied Person's List or Entity List. By using the VIZIO Software, you represent and warrant that you are not located in any such country or on any such list. You also agree that you will not use these products for any purposes prohibited by United States law, including, without limitation, the development, design, manufacture or production of missiles, or nuclear, chemical or biological weapons.

14. Controlling Law and Severability. This License Agreement will be governed by and construed in accordance with the laws of the State of California, as applied to agreements entered into and to be performed entirely within California between California residents. This License Agreement shall not be governed by the United Nations Convention on Contracts for the International Sale of Goods, the application of which is expressly excluded. If for any reason a court of competent jurisdiction finds any provision, or portion thereof, to be unenforceable, the remainder of this License Agreement shall continue in full force and effect.

15. Complete Agreement; Governing Language. This License Agreement constitutes the entire agreement between the parties with respect to the use of the VIZIO Software licensed hereunder and supersedes all prior or contemporaneous understandings regarding such subject matter, with the exception of any additional terms and conditions you are required to accept if you choose to access VIA Services which will govern your use of such VIA Services. No amendment to or modification of this License Agreement will be binding unless in writing and signed by VIZIO. Any translation of this License Agreement is done for local requirements and in the event of a dispute between the English and any non-English versions, the English version of this License Agreement shall govern.



Index

Accessories.....	9	VGA	31
Adjustments		Connecting Equipment	
Input.....	11	Cable.....	23
Volume.....	11	DVD	26
Advanced Adjustments	37	Home Theater	30
Antenna.....	22	Rear Panel Connections	12
Apps		Satellite Box	23
Adding.....	34	Video Camera	29
Moving.....	35	Contrast	40
Navigating.....	34	Controls	
Using.....	34	Front Panel.....	11
Aspect Ratio.....	38	Left Panel.....	11
Audio Menu		Daylight Savings	18
Adjustments	42	Daylight Savings setting.....	48
Advanced Audio	42	Device Setup.....	16
Analog Audio Out adjustments.....	43	Device Setup.....	45
Audio Control	43	DTV Transition	4
Audio Mode.....	42	DVD Player	
Audio Mode adjustments.....	43	Connecting	26
Balance	42	DVI	
Device Setup.....	43	Cable Box	23
Digital Audio Out	42	DVD Player	26
Equalizer Settings	43	Satellite Box	23
Lip Sync	42	Equalizer	43
Reset Audio Mode.....	43	Ethernet (wired) Settings.....	50
SRS TruVolume	42	Ethernet Connection	32
SRS TSHD (surround sound) adjustments	42	Factory Default.....	52
TV Speakers	42	Firmware Updates.....	36
Blocking Channels	46	Getting Started	17
Bluetooth.....	51	GUIDE Button	19
Bluetooth Remote Control.....	13	HDMI.....	22
Brightness	40	HDTV Location.....	9
Cable Box		Help.....	52
Connecting.....	23	Home Network Connection	32
Cleaning.....	53	Home Theater	
Closed Caption.....	39	Connecting.....	30
Coaxial connection		INFO Button	19, 21, 33
Satellite box.....	28	Input Source	
Coaxial Connection		Choosing.....	18
Cable TV	28	Naming.....	45
Color	40	Input Source.....	40
Component Cables	22	Inputs	
Composite Cable.....	22	Antenna.....	4
Computer		Connectors.....	22
Connecting.....	31	Installation services.....	9
Resolutions	60	Internet	
Connecting		Connecting.....	18, 33
Antenna.....	12	Connecting for VIA.....	18, 33
Audio.....	12	Maintenance	53
AV Cable.....	12	Navigating VIA	15
Bluetooth.....	51	Network.....	50
Component Cable	12	Network Menu	
Composite Cable.....	12	Bluetooth.....	51
Computer	31	Ethernet (wireless)	50
Computer	12	Wireless	50
Ethernet	32	Package	
Ethernet	12	Contents.....	8
HDMI.....	12	Opening	8
RGB	31	Panoramic.....	38
S-VIDEO Cable	12	Parental Controls	46



Block Unrated Programming	47	Connecting	23
Canadian-English Rating	47	Search for channels	44
Canadian-French Rating	47	Sharpness	40
Change PIN	48	Sidebar	21, 33
Channel Block	46	Skip Channel	44
Rating Enable	46	Sleep Timer	39
Resetting the Locks	48	Software Updates	36
USA-Movie Rating	47	Specifications	59
USA-TV Rating	46	Stretch	38
Password		S-Video	22
Change	48	Technical Support	58
Picture Menu	40	Time Zone	18
Adaptive Luma	41	Time Zone setting	48
Advanced Video	41	Tint	40
Backlight	40	Troubleshooting	53
Brightness	40	Tuner Menu	
Color	40	Add Analog Channel	44
Color Enhancement	41	Analog MTS	44
Color Temperature	41	Auto Search	44
Contrast	40	Digital MTS	44
Film Mode	42	Partial Channel Search	44
Noise Reduction	41	Skip Channel	44
Picture Mode	40	Tuner Mode	44
Real Cinema	41	TV Menu	37
Reset Picture Mode	42	TV Settings App	21, 33, 37
Sharpness	40	Closed Caption Menu	39
Size & Position	41	Help Menu	52
Smooth Motion	41	Input Menu	37
Tint	40	Network Menu	50
PIP	49	PIP Menu	49
Audio	49	Sleep Timer Menu	39
Mode	49	TV Settings Menu	40
Position	49	Wide Menu	38
Size	49	TV Settings Menu	
Source	49	Device Setup	45
Postal Code setting	48	Menu Language	48
Profile App	21, 33	Name Input	45
Profiles		Parental Controls	46
Creating	35	Time & Local Settings	48
Editing	36	Tuner Menu	44
Removing	36	Updates	36
Switching	36	VIA	
Using	35	Apps	34
Remote Control		Connecting to the Internet	18, 33
A/V Functions	15	Exploring	21, 33
Batteries	13	Remote Control	34
Bluetooth Activation	13	Sidebar	21, 33
Device Setup	16	Using	33
Front	14	VIA Dock	21, 33
Precautions	16	VIA Dock	21, 33
TV Functions	14	Wall mounting	10
Universal	16	Warranty	62
Using Cable or Satellite Remote	61	Warranty services	9
VIA buttons	34	Watching TV	
VIA Functions	15	Getting your Programs	19
Reset all settings	52	Program Information	19
RGB	22	Wide	38
Resolutions	60	Widget Gallery	34
Safety Instructions	2	Widget Gallery	21, 33
Safety Strap	10	Wireless Settings	50
Satellite Box		Zoom	38

