

# Panasonic®

Model No.  
Número de modelo

**TC-P50VT20**

## Operating Instructions

50" Class 1080p Plasma HDTV  
(49.9 inches measured diagonally)

## Manual de instrucciones

Televisión de alta definición de 1080p y  
clase 50" de Plasma  
(49,9 pulgadas medidas diagonalmente)

For assistance (U.S.A./Puerto Rico), please call:

**1-877-95-VIERA (958-4372)**

or visit us at [www.panasonic.com/contactinfo](http://www.panasonic.com/contactinfo)

For assistance (Canada), please call:

**1-866-330-0014**

or visit us at [www.vieraconcierge.ca](http://www.vieraconcierge.ca)

Para solicitar ayuda (EE.UU./Puerto Rico), llame al:

**1-877-95-VIERA (958-4372)**

ó visítenos en [www.panasonic.com/contactinfo](http://www.panasonic.com/contactinfo)

# VIERA



## Quick Start Guide

► See page 8-17

## Guía de inicio rápido

► vea la página 8-17

AVCHD™

VIERA CAST™

real D) 3D

BBE®  
High Definition Sound

BBE.ViVA  
HD3D Sound

HDMI

HDTV

VIERA Link™

SD  
XC™

VIERA™  
IMAGE VIEWER

**English**

Thank you for purchasing this Panasonic product.  
Please read these instructions before operating your set and retain them for future reference. The images shown in this manual are for illustrative purposes only.

**Español**

Gracias por su decisión de comprar este producto marca Panasonic.  
Lea estas instrucciones antes de utilizar su televisor y guárdelas para consultarlas en el futuro. Las imágenes mostradas en este manual tienen solamente fines ilustrativos.



TQB2AA0577

# Experience an amazing level of multimedia excitement

Enjoy rich multimedia

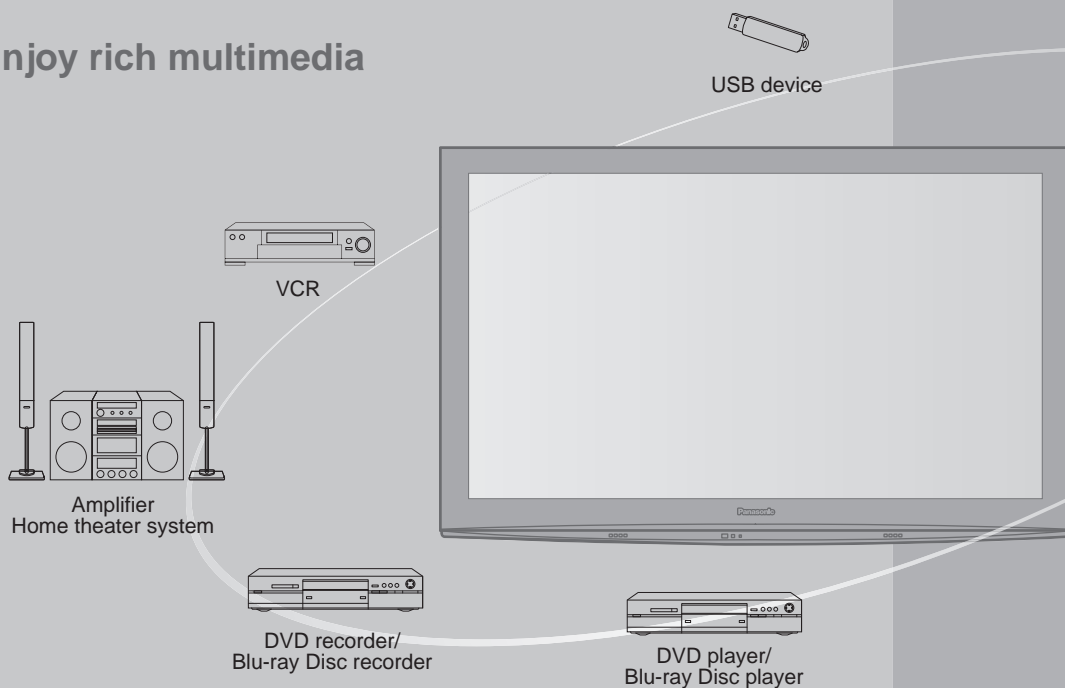

<p>VIERA Link™ is a trademark of Panasonic Corporation.</p>	<p>SDXC Logo is a trademark of SD-3C, LLC.</p>	<p>HDMI, the HDMI logo and High-Definition Multimedia Interface are trademarks or registered trademarks of HDMI Licensing LLC in the United States and other countries.</p>	 <p><b>CEA</b> Consumer Electronics Association <a href="http://www.CE.org/safety">www.CE.org/safety</a></p>
<p>VIERA CAST™ is a trademark of Panasonic Corporation.</p>	<p>HDAVI Control™ is a trademark of Panasonic Corporation.</p>		
<p>Manufactured under license from Dolby Laboratories. Dolby and the double-D symbol are trademarks of Dolby Laboratories.</p>		<p>“AVCHD” and the “AVCHD” logo are trademarks of Panasonic Corporation and Sony Corporation.</p>	
<p>This product is licensed under the AVC patent portfolio license for the personal and non-commercial use of a consumer to (i) encode video in compliance with the AVC Standard (“AVC Video”) and/or (ii) decode AVC Video that was encoded by a consumer engaged in a personal and non-commercial activity and/or was obtained from a video provider licensed to provide AVC Video. No license is granted or shall be implied for any other use. Additional information may be obtained from MPEG LA, LLC. See <a href="http://www.mpegla.com">http://www.mpegla.com</a>.</p>			

# Contents

## Please read before using the unit

- Safety Precautions ..... 4
- Notes ..... 7

## Quick Start Guide

- Accessories/Optional Accessory ..... 8
- Basic Connection ..... 11
- Identifying Controls ..... 13
- First Time Setup ..... 14

Quick Start  
Guide

## Enjoy your TV!

### Basic Features

- Watching TV ..... 18
- Using VIERA TOOLS ..... 21
- Viewing 3D images on TV ..... 22
- Viewing with VIERA IMAGE VIEWER ..... 26
- VIERA CAST™ ..... 30
- Network Camera ..... 32
- Watching Videos and DVDs ..... 34
- Displaying PC Screen on TV ..... 36

Viewing

### Advanced Features

- How to Use Menu Functions  
(picture, sound quality, etc.) ..... 37
- VIERA Link™ “HDMI Control™” ..... 40
- Network Settings ..... 46
- Lock ..... 50
- Editing and Setting Channels ..... 52
- Closed Caption ..... 54
- Input Labels ..... 55
- Using Timer ..... 56
- Recommended AV Connections ..... 57

Advanced

### FAQs, etc.

- Ratings List for Lock ..... 58
- Technical Information ..... 59
- FAQ ..... 64
- Care and Cleaning ..... 66
- Specifications ..... 67
- Limited Warranty  
(for U.S.A. and Puerto Rico) ..... 68
- Customer Services Directory  
(for U.S.A. and Puerto Rico) ..... 69
- Limited Warranty (for Canada) ..... 70

FAQs, etc.

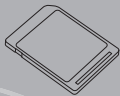

SD memory card



Personal computer

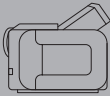

Camcorder



Set Top Box



This product qualifies for ENERGY STAR in the “Home Use” setting and this is the setting in which energy savings will be achieved. Any modifications to the “Home Use” setting or other factory default settings could result in greater energy consumption beyond levels that meet ENERGY STAR qualifications.

“RealD 3D” is a trademark of RealD.  
This product is covered by U.S. Patent No. 5,193,000.



The Skype™ is a trademark of Skype limited.

Manufactured under license from BBE Sound, Inc.

Licensed by BBE Sound, Inc. under one or more of the following US patents: 5510752, 5736897. BBE and BBE symbol are registered trademarks of BBE Sound, Inc.



# Safety Precautions

	<b>CAUTION</b> <b>RISK OF ELECTRIC SHOCK</b> <b>DO NOT OPEN</b>	
<p>WARNING: To reduce the risk of electric shock, do not remove cover or back. No user-serviceable parts inside. Refer servicing to qualified service personnel.</p>		



The lightning flash with arrowhead within a triangle is intended to tell the user that parts inside the product are a risk of electric shock to persons.



The exclamation point within a triangle is intended to tell the user that important operating and servicing instructions are in the papers with the appliance.

<p>WARNING: To reduce the risk of fire or electric shock, do not expose this apparatus to rain or moisture. Do not place liquid containers (flower vase, cups, cosmetics, etc.) above the set (including on shelves above, etc.).</p>
---

## Important Safety Instructions

- 1) Read these instructions.
- 2) Keep these instructions.
- 3) Heed all warnings.
- 4) Follow all instructions.
- 5) Do not use this apparatus near water.
- 6) Clean only with dry cloth.
- 7) Do not block any ventilation openings. Install in accordance with the manufacturer's instructions.
- 8) Do not install near any heat sources such as radiators, heat registers, stoves, or other apparatus (including amplifiers) that produce heat.
- 9) Do not defeat the safety purpose of the polarized or grounding-type plug. A polarized plug has two blades with one wider than the other. A grounding type plug has two blades and a third grounding prong. The wide blade or the third prong are provided for your safety. If the provided plug does not fit into your outlet, consult an electrician for replacement of the obsolete outlet.
- 10) Protect the power cord from being walked on or pinched particularly at plugs, convenience receptacles, and the point where they exit from the apparatus.
- 11) Only use attachments / accessories specified by the manufacturer.
- 12) Use only with the cart, stand, tripod, bracket, or table specified by the manufacturer, or sold with the apparatus. When a cart is used, use caution when moving the cart / apparatus combination to avoid injury from tip-over. 
- 13) Unplug this apparatus during lightning storms or when unused for long periods of time.
- 14) Refer all servicing to qualified service personnel. Servicing is required when the apparatus has been damaged in any way, such as power-supply cord or plug is damaged, liquid has been spilled or objects have fallen into the apparatus, the apparatus has been exposed to rain or moisture, does not operate normally, or has been dropped.
- 15) To prevent electric shock, ensure the grounding pin on the AC cord power plug is securely connected.

## WARNING/CAUTION (TV set)

### WARNING

**Small parts can present choking hazard if accidentally swallowed.**  
**Keep small parts away from young children.**  
**Discard unneeded small parts and other objects, including packaging materials and plastic bags/sheets to prevent them from being played with by young children, creating the potential risk of suffocation.**

#### ■ Set up

This Plasma TV may fall and can cause personal injury or even death if not installed correctly. To prevent personal injury or death, follow these warnings:

- **Install the Plasma TV in accordance with the manufacturer's recommended pedestal or stand, corresponding hardware and installation instructions.** This Plasma TV is for use only with the following optional accessories. Use with any other type of optional accessories may cause instability. The following accessories are manufactured by Panasonic Corporation.
  - Wall-hanging bracket (Angled)  
TY-WK4P1RW

- **Be sure to ask a qualified technician to carry out the installation and set-up.**  
Two or more people are required to install or remove the television.
- **Some wall mounts (wall-hanging brackets) are not designed to be mounted to walls with steel studs or old cinder block constructions.**  
Ask your dealer or licensed contractor to properly secure the wall-hanging bracket.
- **Do not route the TV's power cord inside the wall.**  
The power cord was not designed for in-wall mounting. Doing so can lead to fire hazard.
- **Do not place the Plasma TV or its stand on a sloped or unstable surface.**  
The Plasma TV may fall or tip over.
- **Do not support the Plasma TV on a non-specified pedestal.**
- **Do not place the Plasma TV on furniture that can easily be used as steps, such as a chest of drawers.**
- **Do not climb or allow children to climb on the Plasma TV**
- **Place or install the Plasma TV where it cannot be pushed, pulled over or knocked down.**
- **Route all cords and cables such that they cannot be tripped over or pulled by curious children.**

- **Do not place any objects on top of the Plasma TV.** If water spills onto the Plasma TV or foreign objects get inside it, a short-circuit may occur which could result in fire or electric shock. If any foreign objects get inside the Plasma TV, please consult an Authorized Service Center. In the unlikely event that you receive a shock from this product it is possible that your household outlet may be wired improperly. Have an electrician verify that the TV's outlet is properly wired. If the symptom persists, have the TV serviced by a qualified authorized technician.

## ■ AC Power Supply Cord

To prevent fire or electric shock:

- **The Plasma TV is designed to operate on a 120 V AC, 60 Hz service. Insert the power cord plug as far as it will go into the wall socket.**  
If the plug is not fully inserted, heat may generate, which could cause a fire.
- **The included power cord is for use with this unit only.**
- **Do not use any power cord other than that provided with this TV.**
- **Do not handle the power cord plug with wet hands.**
- **Do not do anything that might damage the power supply cord.**
- **When disconnecting the power supply cord, hold the plug, not the cord.**
- **Do not use the power supply cord if the plug or cord is damaged.**  
Replace the cord or contact your Authorized Service Center.
- **Do not use a 3-prong to 2-prong AC plug adaptors to connect your TV's plug to the wall outlet.**  
Doing so will defeat the TV plug's safety feature, which can lead to a shock hazard. If the wall outlet does not accommodate a 3-prong plug, have a qualified electrician replace your outlet and check the associated wiring.

## ■ Handling the power supply cord

- **Insert the power plug fully into the socket outlet. (If the power plug is loose, it could generate heat and cause fire.)**
- **Ensure that the power plug is easily accessible.**
- **Ensure the earth pin on the power plug is securely connected to prevent electrical shock.**
  - An apparatus with CLASS I construction shall be connected to a power socket outlet with a protective earthing connection.
- **Do not touch the power plug with a wet hand. (This may cause electrical shock.)**
- **Do not use any power cord other than that provided with this TV. (This may cause fire or electrical shock.)**
- **Do not damage the power cord. (A damaged cord may cause fire or electrical shock.)**
  - Do not move the TV with the cord plugged in the socket outlet.
  - Do not place a heavy object on the cord or place the cord near a high-temperature object.
  - Do not twist the cord, bend it excessively, or stretch it.
  - Do not pull on the cord. Hold onto the power plug body when disconnecting cord.
  - Do not use a damaged power plug or socket outlet.
- **If a problem occurs (such as no picture or no sound), or if smoke or an abnormal odor is detected from the Plasma TV, unplug the power supply cord immediately.**  
Continued use of the TV under these conditions might cause a fire or permanent damage to the TV. Have the TV evaluated by an Authorized Service Center. Servicing of the TV by unauthorized personnel is strongly discouraged due to its high voltage.

- **If water or an object gets inside the Plasma TV, if the Plasma TV is dropped, or if the enclosure becomes damaged, unplug the power supply cord immediately.**  
A short-circuit may occur, which could cause a fire. Contact an Authorized Service Center for an evaluation.



- **Do not cover the ventilation holes.**  
Doing so may cause the Plasma TV to overheat, which can cause a fire or damage to the Plasma TV.
- **Leave a space of 3 15/16" (10 cm) or more at the top, left and right, and 2 3/4" (7 cm) or more at the rear.**
- **When using the pedestal, keep the space between the bottom of the TV and the pedestal or stand surface clear from objects that may obstruct ventilation.**

## ■ When Moving the Plasma TV

- **Be sure to disconnect all cables before moving the Plasma TV.**  
Moving the TV with its cables attached might damage the cables which, in turn, can cause fire or electric shock.
- **To prevent an electric shock, disconnect the power plug from the wall outlet as a safety precaution before carrying out any cleaning.**
- **Transport only in upright position.**  
Transporting the unit with its display panel facing upright or downward may cause damage to the internal circuitry.
- **Using a dry cloth, clean any dust from the power supply cord and plug regularly.**  
Build-up of dust on the power cord plug can increase humidity, which might damage the insulation and cause a fire.
- **This Plasma TV radiates infrared rays;**  
therefore, it may affect other infrared communication equipment. Install your infrared sensor in a place away from direct or reflected light from your Plasma TV.
- **The TV will still consume some power as long as the power supply cord is connected to the wall outlet.**

- **Display panel is made of glass. Do not apply strong force or impact to the display panel.**  
This may cause damage resulting in injury.
- **The TV is heavy. TV should be handled by 2 or more people. Support as shown to avoid injury by the TV tipping or falling.**

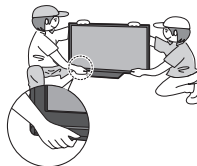

# Safety Precautions (Continued)

## WARNING/CAUTION (3D Eyewear)

### WARNING

#### ■ About Prevention of Accidental Ingestion

- Do not store batteries, the band accessory or nose pads in places where small children can reach.  
There is a danger small children could swallow such parts by mistake.
  - If a child accidentally swallows such parts, seek immediate medical attention.

#### ■ About Prohibition of Disassembly

- Do not disassemble or modify the 3D Eyewear.

#### ■ About lithium battery

- Batteries must not be exposed to excessive heat such as sunshine, fire or the like.

### CAUTION

#### ■ About 3D Eyewear

- Do not drop, exert pressure on, or step on the 3D Eyewear.  
Doing so may damage the glass section, which may result in injury.
  - Always store the 3D Eyewear in the case provided when not in use.
- Be careful of the tips of the frame when putting on the 3D Eyewear.  
Accidentally inserting the tip of the frame into the eye may cause injury.

- Be careful not to trap a finger in the hinge section of the 3D Eyewear.  
Doing so may result in injury.
  - Pay special attention when children are using this product.

#### ■ About Use of 3D Eyewear

- Parents/guardians should monitor children's viewing habits to avoid their prolonged use without rest periods.
- Use only the 3D Eyewear recommended for this TV.
- Only use the 3D Eyewear for the specified purpose.
- Do not move around while wearing the 3D Eyewear.  
The surrounding area appears dark, which may result in falling or other accidents that may cause injury.

#### ■ About Viewing of 3D Images

- In the event that you experience dizziness, nausea, or other discomfort while viewing 3D images, discontinue use and rest your eyes.
- Do not use if the 3D Eyewear is cracked or broken.

#### ■ About lithium battery

- Danger of explosion if battery is incorrectly replaced.  
Replace only with the same or equivalent type.



### WARNING

CEA CHILD SAFETY NOTICES: Flat panel displays are not always supported on the proper stands or installed according to the manufacturer's recommendations. Flat panel displays that are inappropriately situated on dressers, bookcases, shelves, desks, speakers, chests or carts may fall over and may cause personal injury or even death.

The consumer electronics industry (of which Panasonic is a member) is committed to making home entertainment enjoyable and safe. To prevent personal injury or death, be sure to follow the following safety guidelines:

#### TUNE INTO SAFETY:

- One size does NOT fit all. Follow the manufacturer's recommendations for the safe installation and use of your flat panel display.
- Carefully read and understand all enclosed instructions for proper use of this product.
- Don't allow children to climb on or play with furniture and television sets.
- Don't place flat panel displays on furniture that can easily be used as steps, such as a chest of drawers.
- Remember that children can become excited while watching a program, especially on "larger than life" flat panel displays. Care should be taken to install the display where it cannot be pushed, pulled over, or knocked down.
- Care should be taken to route all cords and cables connected to the flat panel display so that they cannot be pulled or grabbed by curious children.

#### WALL MOUNTING: IF YOU DECIDE TO WALL MOUNT YOUR FLAT PANEL DISPLAY, ALWAYS:

- Use a mount that has been recommended by the display manufacturer and/or listed by an independent laboratory (such as UL, CSA, ETL).
- Follow all instructions supplied by the display and wall mount manufacturers.
- If you have any doubts about your ability to safely install your flat panel display, contact your retailer about professional installation.
- Make sure the wall where you are mounting the display is appropriate. Some wall mounts are not designed to be mounted to walls with steel studs or old cinder block construction. If you are unsure, contact a professional installer.
- A minimum of two people are required for installation. Flat panel displays can be heavy.

Panasonic recommends that a qualified installer perform the wall-mount installation. See page 4.

The American Academy of Pediatrics discourages television viewing for children younger than two years of age.

## FCC STATEMENT

This equipment has been tested and found to comply with the limits for a Class B digital device, pursuant to Part 15 of the FCC Rules. These limits are designed to provide reasonable protection against harmful interference in a residential installation. This equipment generates, uses and can radiate radio frequency energy and, if not installed and used in accordance with the instructions, may cause harmful interference to radio communications. However, there is no guarantee that interference will not occur in a particular installation. If this equipment does cause harmful interference to radio or television reception, which can be determined by turning the equipment off and on, the user is encouraged to try to correct the interference by one or more of the following measures:

- Reorient or relocate the receiving antenna.
- Increase the separation between the equipment and receiver.
- Connect the equipment into an outlet on a circuit different from that to which the receiver is connected.
- Consult the dealer or an experienced radio/TV technician for help.

This device complies with Part 15 of the FCC Rules. Operation is subject to the following two conditions: (1) This device may not cause harmful interference, and (2) this device must accept any interference received, including interference that may cause undesired operation.

### FCC Caution:

**To assure continued compliance, follow the attached installation instructions and use only shielded interface cables when connecting to computer or peripheral devices. Any changes or modifications not expressly approved by Panasonic Corp. of North America could void the user's authority to operate this device.**

### FCC Declaration of Conformity

#### Model No. TC-P50VT20

Responsible Party: Panasonic Corporation of North America  
One Panasonic Way, Secaucus, NJ 07094

Contact Source: Panasonic Consumer Electronics Company  
1-877-95-VIERA (958-4372)

email: consumerproducts@panasonic.com

### CANADIAN NOTICE:

For Model TC-P50VT20

This Class B digital apparatus complies with Canadian ICES-003.

# Notes

## ■ Do not display a still picture for a long time

This causes the image to remain on the plasma screen ("Image retention"). This is not considered a malfunction and is not covered by the warranty.



To prevent the "Image retention", the screen saver is automatically activated after a few minutes if no signals are sent or no operations are performed. (p. 65)

### Typical still images

- Channel number and other logos
- Image displayed in 4:3 mode
- SD Card photo
- Video game
- Computer image

### ■ Set up

- Do not place the unit where it's exposed to sunlight or other bright light (including reflections).
- Use of some types of fluorescent lighting may reduce the remote control's transmission range.

# Accessories/Optional Accessory

## Accessories

Check you have all the items shown.

### Accessories

- Remote Control Transmitter
  - N2QAYB000486



- Batteries for the Remote Control Transmitter (2)
  - AA Battery



- AC cord



- Screwdriver (for 3D Eyewear)

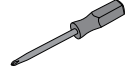

- Operating Instructions
- VIERA Concierge and Quick Start Guide
- Product Registration Card (U.S.A.)
- 3D Eyewear (p. 22)

- Pedestal
  - TBLX0154

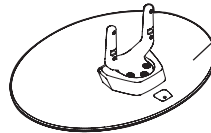

How to assemble (p. 9)

### Optional Accessory

#### Wall-hanging bracket (angle)

- TY-WK4P1RW

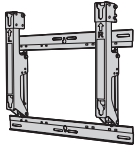

- a: 15.7" (400 mm)
- b: 11.8" (300 mm)

Please contact your nearest Panasonic dealer to purchase the recommended wall-hanging bracket. For additional details, please refer to the wall-hanging bracket installation manual.

Rear of the TV

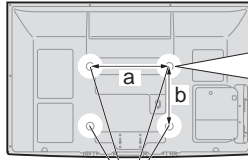

Holes for wall-hanging bracket installation

Screw for fixing the TV onto the wall-hanging bracket (not supplied with the TV)

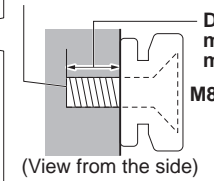

Depth of screw:  
minimum 0.59" (15.0 mm),  
maximum 1.18" (30.0 mm)

M8

#### Warning

- In order to maintain the TV's performance and safety, be absolutely sure to ask your dealer or a licensed contractor to secure the wall-hanging brackets.
- Carefully read the instructions accompanying optional accessories, and be absolutely sure to take steps to prevent the TV from tipping over.
- Handle the TV carefully during installation since subjecting it to impact or other forces may cause product damage.
- Take care when fixing wall brackets to the wall. Always ensure that there are no electrical cables or pipes in the wall before hanging bracket.
- When using the angled-type wall hanging bracket, please ensure that there is sufficient space for the connecting cables not to press against the wall when the TV is tilted forward.
- For safety reasons, remove units no longer being used from their wall-mounted locations.

## Installing the remote's batteries

1

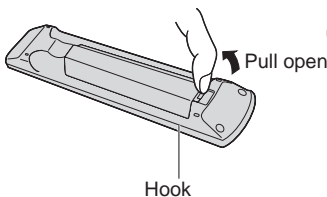

2

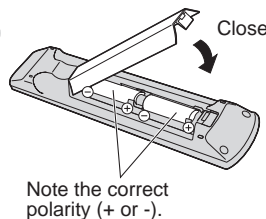

#### Caution

- Incorrect installation may cause battery leakage and corrosion, resulting in damage to the remote control.
- Do not mix old and new batteries.
- Do not mix different battery types (such as alkaline and manganese batteries).
- Do not use rechargeable (Ni-Cd) batteries.
- Do not burn or break batteries.



## Attaching the pedestal to TV

### ■ Assembling the pedestal

- Fix securely with assembly screws (A). (Total 3 screws)
- Tighten screws firmly.

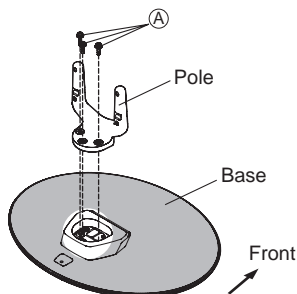

### ■ Set-up

- Carry out work on a horizontal and level surface.
- Tighten screws firmly.

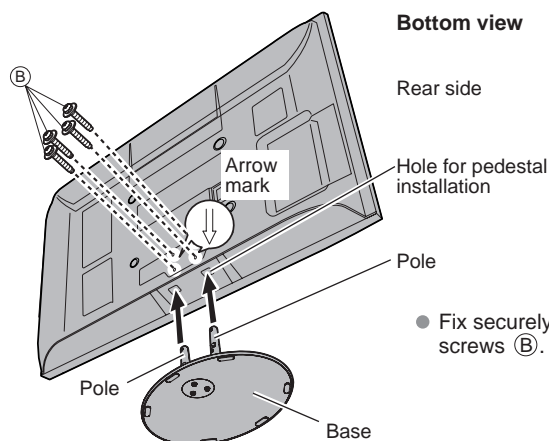

- Fix securely with assembly screws (B). (Total 4 screws)

#### Warning

**Do not disassemble or modify the pedestal.**

- Otherwise the TV may fall over and become damaged, and personal injury may result.

#### Caution

**Do not use any other TV and displays.**

- Otherwise the TV may fall over and become damaged, and personal injury may result.

**Do not use the pedestal if it becomes warped or physically damaged.**

- If you use the pedestal when it is physically damaged, personal injury may result. Contact your nearest Panasonic Dealer immediately.

**During set-up, make sure that all screws are securely tightened.**

- If sufficient care is not taken to ensure screws are properly tightened during assembly, the pedestal will not be strong enough to support the TV, and it might fall over and become damaged, and personal injury may result.

### Accessories

Assembly screws

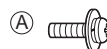

XYN5+F18FN  
M5 x 18 (Silver) (3)



THEL079N  
M5 x 30 (Black) (4)

Pole (1)

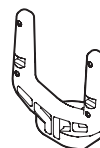

Base (1)



# Accessories/Optional Accessory (Continued)

## Location

Adjust the plasma panel to your desired angle.

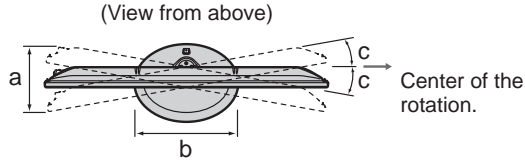

- a: 11.0" (277 mm)
- b: 17.5" (443 mm)
- c: 10°

### Note

- Ensure that the pedestal does not hang over the edge of the base even if the TV swivels to the full rotation range.
- Do not place any objects or hands within the full rotation range.

## AC cord connection

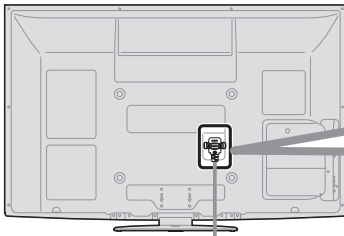

### To attach

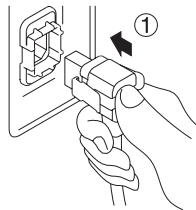

Insert it firmly until the tabs on both sides click into place.

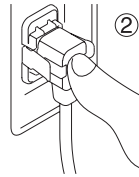

### To remove

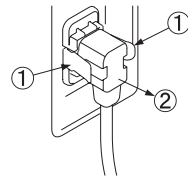

Keep pushing both sides until they snap and pull.

## Reference of connection

### Antenna terminal

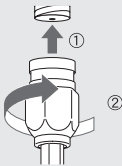

- Firmly tighten by hand.

### Pin terminals

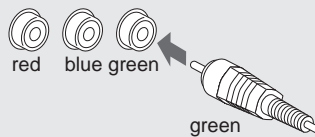

- Match colors of plugs and terminals.
- Insert firmly.

### HDMI terminal

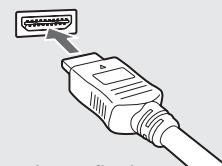

- Insert firmly.

# Basic Connection

## Example Connecting Antenna (To watch TV)

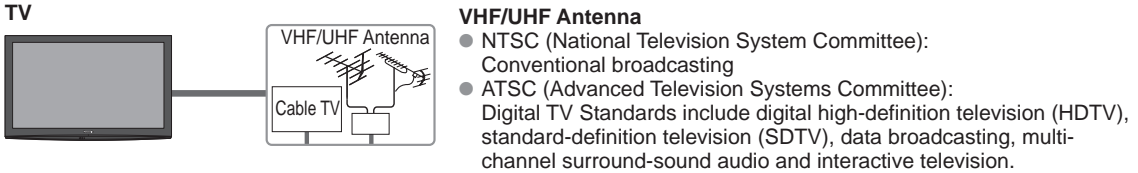

### To connect the antenna terminal

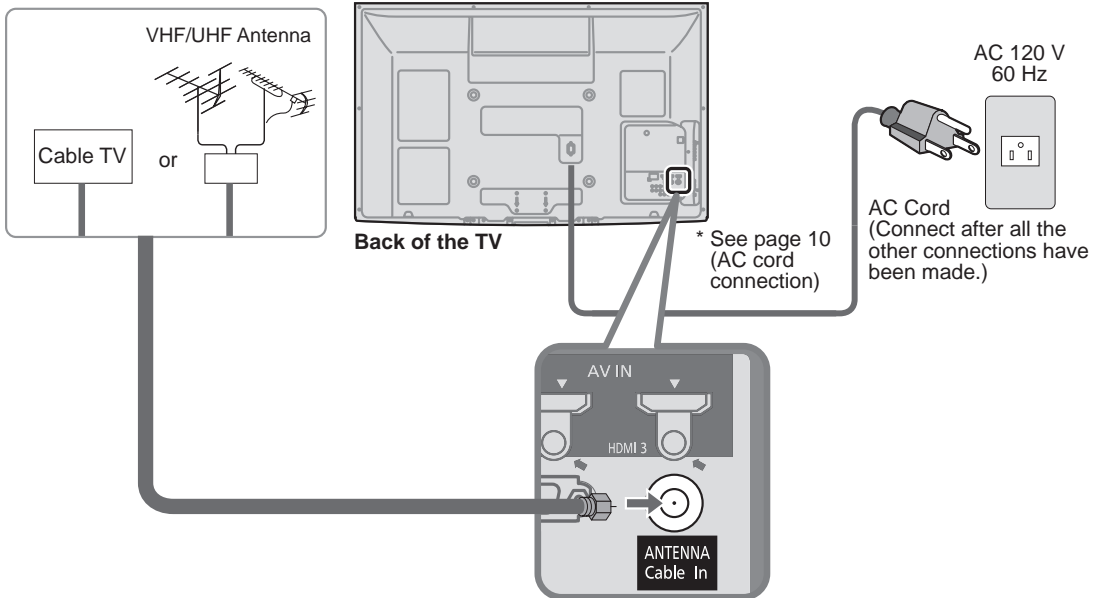

#### Cable

- You need to subscribe to a cable TV service to enjoy viewing their programming.
- You can enjoy high-definition programming by subscribing to a high-definition cable service.  
The connection for high-definition can be done with the use of an HDMI or Component Video cable. (p. 12)
- To view high-definition programming select the correct video input. (p. 34)

#### Note

- Not all cables and external equipment shown in this book are supplied with the TV.
- For more details on the external equipment's connections, please refer to the operating manuals for the equipment.
- When disconnecting the power cord, be absolutely sure to disconnect the power cord plug from the wall outlet first.
- For additional assistance, visit us at: [www.panasonic.com](http://www.panasonic.com)  
[www.panasonic.ca](http://www.panasonic.ca)

# Basic Connection (Continued)

## AV cable connections

High-Definition

### A To use HDMI terminals

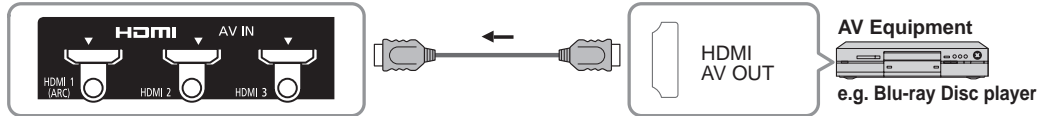

- Connecting to HDMI terminals will enable you to enjoy high-definition digital images and high-quality sound.
- The HDMI connection is required for a 1080p signal.
- For “VIERA Link™ connections”, please refer to p. 41.

### B To use COMPONENT terminals

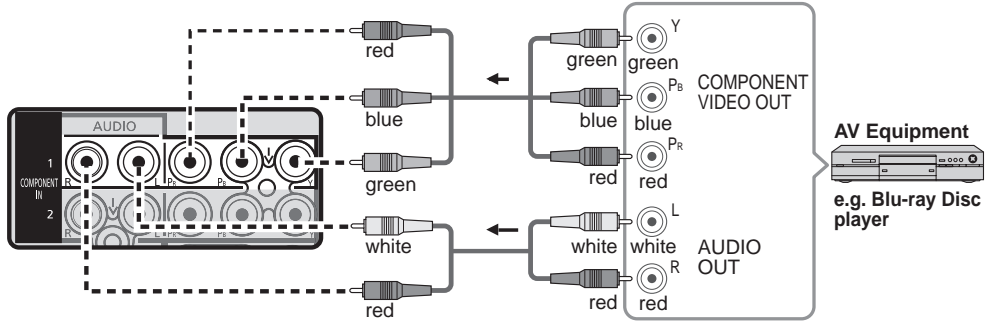

Standard-Definition

### C To use COMPOSITE terminals

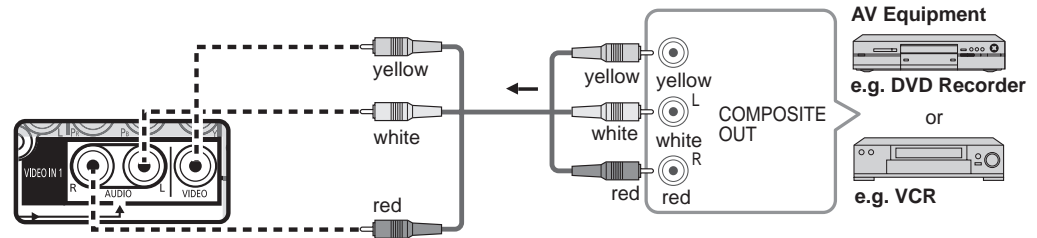

#### Note

- For more details on the external equipment's connections, please refer to the operating manuals for the equipment.

# Identifying Controls

## TV controls/indicators

### Front of the TV

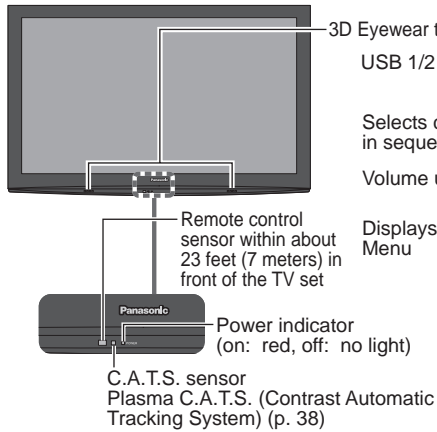

### Back of the TV

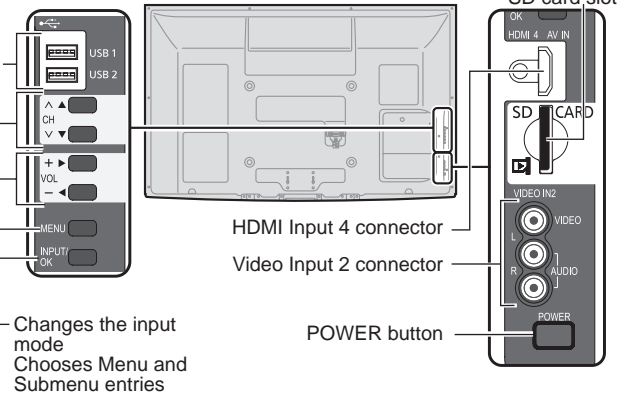

### Note

- The TV consumes a small amount of electric energy even when turned off.
- Do not place any objects between the TV remote control sensor and remote control.

## Remote control

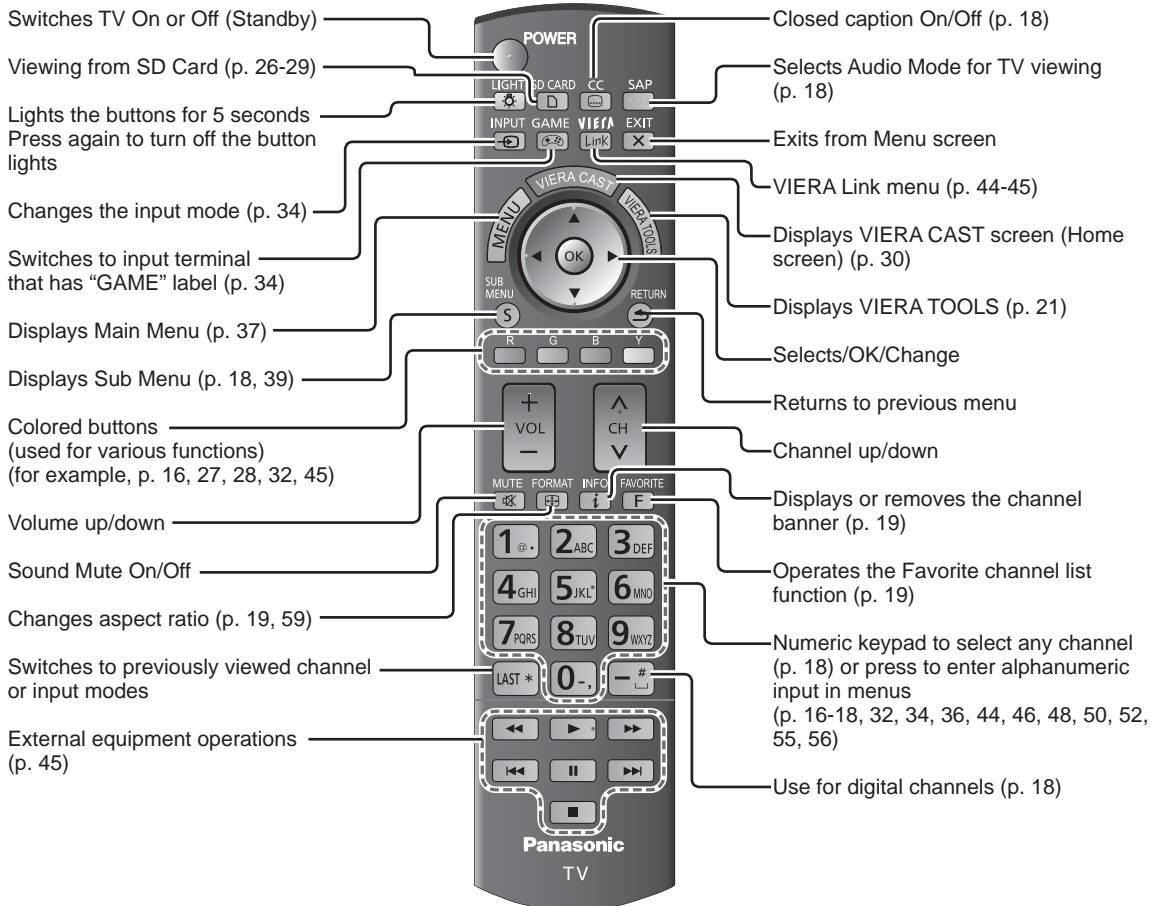

# First Time Setup

First time setup screen is displayed only when the TV is turned on for the first time after the power cord is inserted into a wall outlet and when "Auto power on" (p. 39) is set to "No".

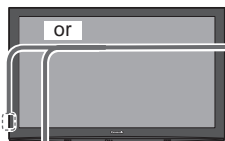

1

## Turn the TV On with the POWER button

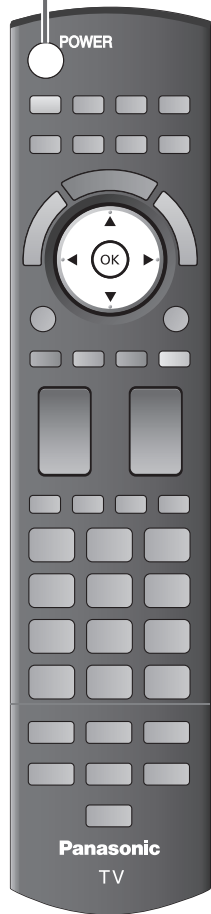
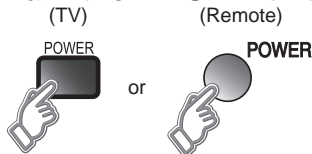

2

## Configure your viewing mode

### ① Select your language

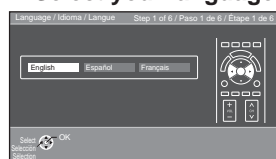

### ② Select your viewing mode (Be sure to select "Home use")

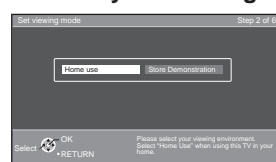

- Please confirm your selection (Home Use) before pressing OK button.

### ■ If you select "Store Demonstration" by mistake in ②, confirmation screen will be displayed.

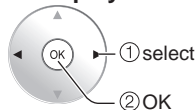
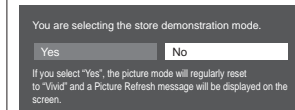

- Select "No" and return to previous screen ②.
- If you select "Yes", Screen enters the store demonstration mode.

To display the "Set viewing mode" screen again as shown above and select "Home Use", do one of the following:

- Press and hold down the side POWER button for at least five seconds.
- Unplug power cord for 30 seconds and plug it again.

### Note

- is not available on ② - ①.
- is not available on ②.
- When you have used ② to turn the TV off, the next time you turn the TV on the "Language" settings will be displayed.
- If you use any other step other than ② to turn the TV off, or if you used the EXIT button to quit before completing the settings, the next time you turn the TV on "First time setup" will not be automatically displayed.
  - The settings up to that point are saved.
  - You can reset the settings using "First time setup". (p. 39)
- To change the setting (Language, ANT/Cable setup, Input labels, Clock) later, go to the Menu screen (p. 39)

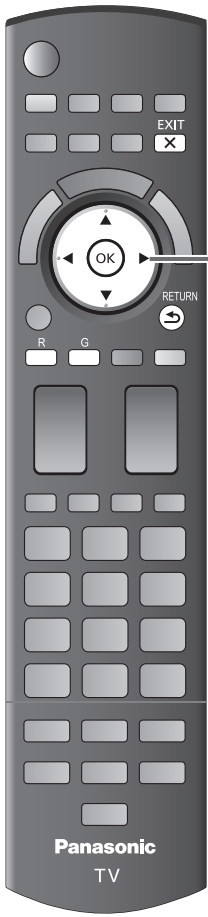

### 3 Auto channel setup (ANT/Cable setup)

① Select the connected Antenna in terminal

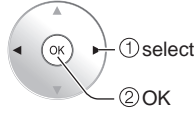
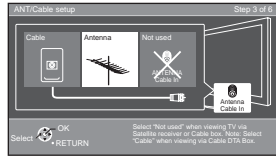

Not used: Go to ④ (Label inputs)

Select "Not used" when no wire is connected to the "Antenna/Cable" terminal.  
 ● Typical when a Cable/Satellite box is connected to a TV input.  
 ● Prevents accidental tuning to an unavailable signal.

② Select "Start"

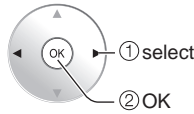

Skip: Go to ④ (Label inputs)

**Start scanning the channels**  
 (Available channels are automatically set.)

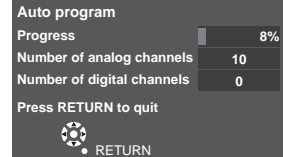

③ Complete the Auto program setup

Completion message is displayed when the Auto program scan is successfully completed.

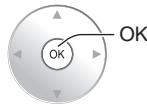
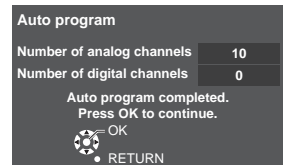

If there is no available channel, return to ③ - ① (ANT/ Cable setup).  
 "Not used" will be selected.

■ Press to return to the previous screen



### 4 Select the Input labels (Label inputs)

Select NEXT then press OK to go to the next step.

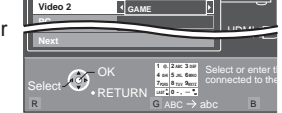
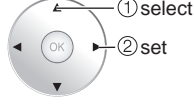
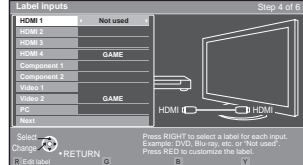

Follow the instructions on screen to complete the following operations.

**Note**

● About broadcasting systems

**Analog (NTSC):**  
 Conventional broadcasting

**Digital (ATSC):**  
 New programming that allows you to view more channels featuring high-quality video and sound

Label: [BLANK] Not used/Blu-ray/DVD/DVD REC/HOME THTR/GAME/COMPUTER/VCR/CABLE/SATELLITE/DVR/CAMERA/MONITOR/AUX/RECEIVER/MEDIA CTR/MEDIA EXT/OTHER

■ Operation of the EXIT button during "First time setup"

Press the button once to display confirmation screen. Press again to close confirmation screen.

[EXIT confirmation screen]

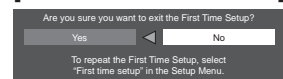

Yes ➔ Exit "First time setup"  
 No ➔ Return to the original screen.

# First Time Setup (Continued)



## 5 Configure Network settings

### ① Select the Network type

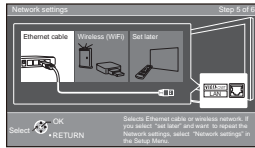

Set later: Go to 6  
 Wireless (WiFi): Start "Wireless network" (p. 17)

### ② Select the setting mode

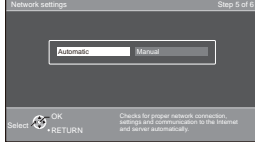

Automatic: Press OK to start setup automatically. Error screen is displayed when Network connection has failed.  
 Manual: Go to Manual setting.

Automatic



### Start connection test

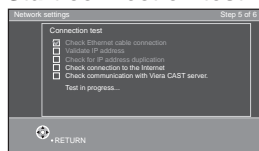

Manual

Connection test

Connection error

### Manual setting

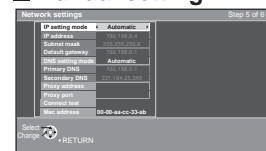

### ③ Complete "Network settings"

Helpful information is displayed when you successfully complete "Network settings".

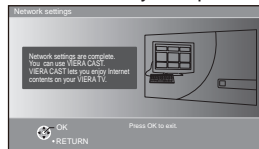

Manual

### Error screen

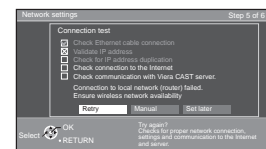

Retry: Go to "Start connection test"  
 Set later: Go to 6

Press to return to the previous screen

RETURN



### About wireless LAN

- Wireless LAN adapter and Access point need to be obtained separately. For the latest information on applicable LAN adapters, check the following website: <http://panasonic.jp/support/global/cs/tv/>
  - Check that the Access point supports WPS\*. (If it does not support WPS, the encryption key of the Access point is required when configuring settings.)
  - Follow the instructions on the Access point setup screen and configure the appropriate security settings. For more details on setting of Access point, please refer to operating manual for the Access point.
  - We recommend using 11n (5 GHz) for the wireless system between the wireless LAN adapter and Access point. Communication is also possible with 11a, 11b, and 11g (2.4 GHz), but the communication speed may be slower.
  - If the wireless system of the Access point is changed, devices that could connect by wireless LAN may no longer be able to connect.
  - When VIERA CAST, Network camera, or other device is using the network, do not disconnect the wireless LAN adapter.
  - Keep the TV away from the following devices as much as possible: Wireless LAN, Microwaves, and other devices that use 2.4 GHz and 5 GHz signals. Otherwise, the TV failures such as malfunction may occur due to the radio wave interference.
- \* WPS: Wi-Fi Protected Setup





6

## Adjust the Clock (Set clock)

Select NEXT then press OK to go to the next step.

### Manual setting

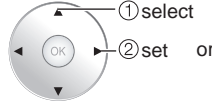
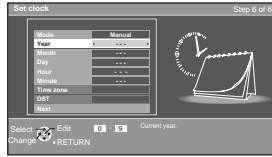

Follow the instructions on screen to complete the following operations.

### Auto setting

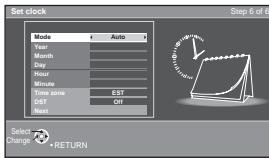

Mode

Manual: Adjust the clock manually (Year/Month/Day/Hour/Minute)  
Auto: The clock is adjusted automatically via Internet service. Only available when the TV is on a network. -->Set "Network settings" first.

Time zone

Select your time zone. (EST/CST/MST/PST/AKST/HST/NST/AST)

DST

Set DST (Daylight Saving Time) setting. (On/Off)

On: Advances the clock one hour from the time it is set according to the time zone.

7

## Complete First time setup

Completion message is displayed when you have successfully completed the First time setup.

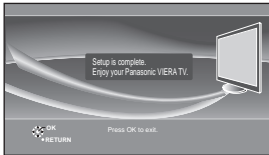

Press to return to the previous screen

RETURN



### Wireless network (First time setup) in 5

① Display "Wireless network"

② Select the connection method

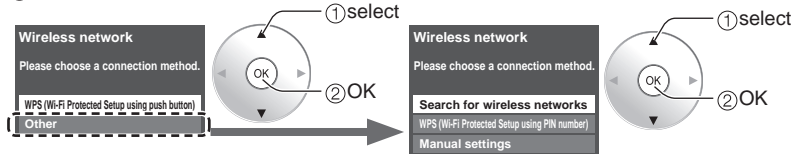

- Follow the directions on screen to complete the setting.
- See page 47 for more information.

# Watching TV

Basic connection (p. 11-12)

## To watch TV and other functions



**1 Turn power on**  
 (Remote) **POWER** (TV) **POWER**  
 or

**Note**  
 ● If the mode is not TV, press and select TV. (p. 34)

**2 Select a channel number**  
 (Remote) up or   
 down

■ **To directly enter the digital channel number**  
 When tuning to a digital channel, press the button to enter the minor number in a compound channel number.  
 example: CH15-1:

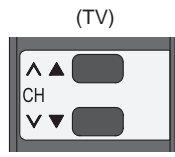

**Note**  
 ● Reselect "Cable" or "Antenna" in "ANT in" of "ANT/Cable setup" to switch the signal reception between cable TV and the antenna. (p. 15, 53)  
 ● The channel number and volume level remain the same even after the TV is turned off.

### Other Useful Functions (Operate after 2)

**Listen with SAP (Secondary Audio Program)**

■ **Select the Audio mode for watching TV**

- **Digital mode**  
Press SAP to select next Audio track (if available) when receiving a digital channel.  

Audio track 1 of 2 (English)
- **Analog mode**  
Press SAP to select the desired Audio mode.  
 ● Each press of SAP will change the Audio mode. (Stereo/SAP/Mono)

---

**Closed caption**

■ **Switches the Closed caption mode On or Off**

Closed caption Off

⇒

Closed caption On

⇒

Closed caption On mute

---

**Display the SUB MENU**

■ **Press SUB MENU to show the Sub Menu screen (p. 39)**  
 This menu consists of shortcuts to convenient functions.

Setup SUB MENU

Channel surf mode

← All →

Set favorite

Edit CH caption

Signal meter

## Information Recall

### ■ Displays or removes the channel banner

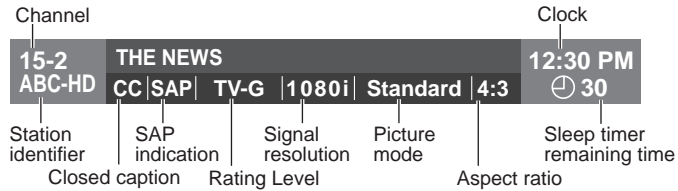

## Change aspect ratio

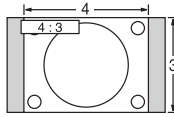

- 480i, 480p: FULL/JUST/4:3/ZOOM
- 1080p, 1080i, 720p: FULL/H-FILL/JUST/4:3/ZOOM

## Call up a favorite channel



### ■ FAVORITE

Channel numbers registered in Favorite are displayed on the favorite tune screen. Select the desired broadcast station with the cursor or use the number buttons. (p. 20)

You can use the remote control keys to enter the alphanumeric characters.

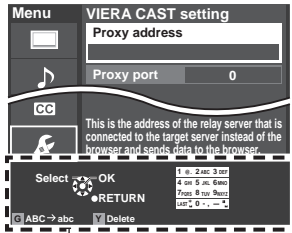

Characters are displayed as shown in the following table.

	ABC/abc												123		
1	@	.	/	:	~	_	1								1
2	a/A	b/B	c/C	2											2
3	d/D	e/E	f/F	3											3
4	g/G	h/H	i/I	4											4
5	j/J	k/K	l/L	5											5
6	m/M	n/N	o/O	6											6
7	p/P	q/Q	r/R	s/S	7										7
8	t/T	u/U	v/V	8											8
9	w/W	x/X	y/Y	z/Z	9										9
0	-	,	;	'	"	?	!	(	)	&	\	0	0		0
LAST	*	#	\$	%	=		{	}	[	]					*
-	Space												#		

## Entering characters

Navigation area

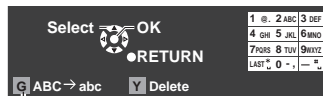

Switches input mode from alphabet to numeric.

- You can also use a USB keyboard (not supplied) to enter the alphanumeric characters.
- Keyboard type (p. 39)

## Operate USB keyboard

You can operate non-character keys as remote control keys.

### ■ Key chart

Keyboard key	Remote key	Keyboard key	Remote key
UP/DOWN/LEFT/RIGHT	Cursor key	F4	Input
Enter	OK	F5	Channel Down(-)
BackSpace	Return (when you do not input character)	F6	Channel up(+)
0-9	0-9	F7	Volume Down(-)
F1	Menu	F8	Volume up(+)
F2	VIERA Tools	F9(Red)/F10(Green)/F11(Blue)/F12(Yellow)	Color key
F3	Submenu		(Red/Blue/Yellow/Green)

- For more details on setting and operation of the USB keyboard, please also read the operating manuals for the USB keyboard.
- Some keyboards do not have these keys.

# Watching TV (Continued)

## Favorite Feature

### ■ Set the Favorite Feature

- 1 Display the SUB MENU.



- 2 Select "Set favorite"

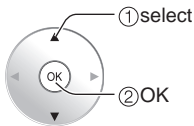
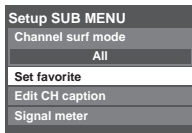

- 3 Set the displayed channel

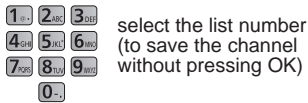
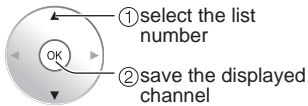
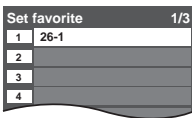

Delete a favorite channel

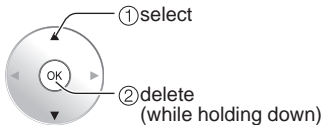
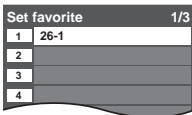

### ■ Use the Favorite Feature

- 1 Display "Favorite channels"



- 2 Select the channel

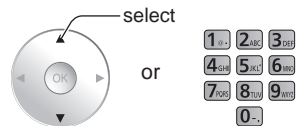
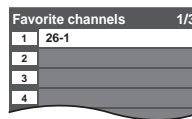

- 3 Set a Favorite channel

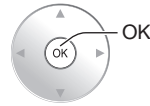
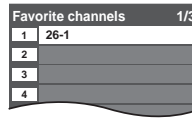

### ■ To change the page



Press repeatedly to change between pages (1/3, 2/3, 3/3 or exit)



Changes the page forward/backward

# Using VIERA TOOLS

VIERA TOOLS is the easy way to access frequently-used menu items. They are displayed as shortcut icons on the TV screen.

Unlike a conventional menu, you can enjoy using, playing or setting a function quickly.

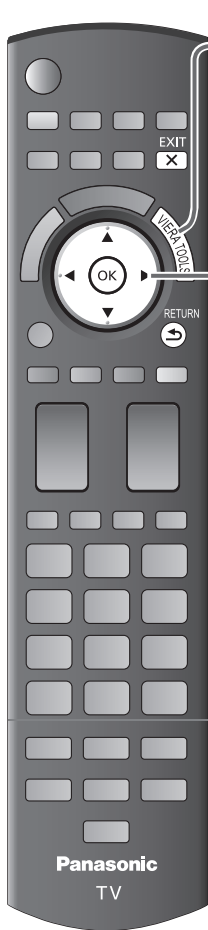





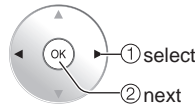

## 1 Display VIERA TOOLS

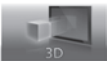

## 2 Select the item



## 3 Set each item

- 3D  
 → 3D settings (p. 24)
- THX  
 → Change to "THX" mode. Picture mode (p. 61)
- VIERA CAST  
 → VIERA CAST (p. 30)
- VIERA Link  
 → VIERA Link control (p. 44-45)
- VIERA IMAGE VIEWER  
 → Viewing with VIERA IMAGE VIEWER (p. 26-29)
- Media player  
 → Media player (p. 26-29)
- Eco  
 → Eco/energy saving (p. 39)

### ■ Press to exit from a menu screen



### ■ Press to return to the previous screen



# Viewing 3D images on TV

You can enjoy 3D images by wearing the 3D Eyewear supplied with this TV and to view 3D broadcasts and 3D image software.

## Basic features of 3D Eyewear

This product cannot be used as sunglasses.  
This product can be worn over vision correction glasses.

Optional Accessory

- TY-EW3D10U (as of April, 2010)  
Visit <http://www.panasonic.com/> for more information.

### Part names and functions

#### Infra-red receiver

Receives infra-red signals from the television.  
The liquid crystal shutter open/close timing is controlled by receiving infra-red signals from the television, which provide 3D expression of the images.

#### Battery case

- Fitting the batteries (p. 23)  
When using for the first time, remove the insulating sheet. (p. 23)

#### Nose pad installation section

3D Eyewear inner section (p. 23)

Specialized band can be attached here. (p. 23)

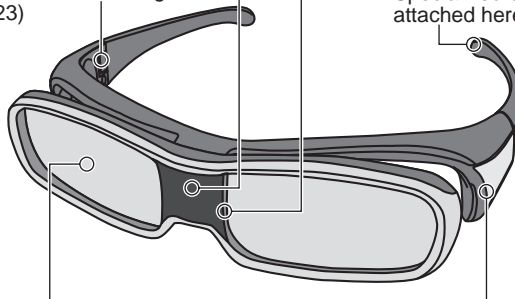

#### Liquid Crystal Shutter

Controls the images for 3D viewing.  
The left and right liquid crystal shutters are alternately opened and closed in time with the left side and right side images that are alternately displayed on the television to achieve the 3D effect.

#### Power button (bottom side of 3D Eyewear)

Switches on the 3D Eyewear power.



Press and hold the power button for approximately 1 second to switch the power on, and the Indicator lamp lights for approximately 2 seconds. To switch the power off, press and hold the power button for approximately 1 second. (The Indicator lamp flashes 3 times, then the power switches off.)

### Accessories

3D Eyewear (1)



3D Eyewear case (1)

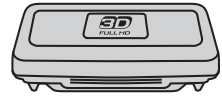

Specialized band (1)

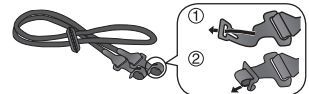

- If the end of the specialized band is loosened, make a loop at the end as shown in the above figure and smooth the twisted rubber before using.

Nose pad (1 of each)



- Use either nose pad A or B for your preference.
- If you put the 3D Eyewear on vision correction glasses, the nose pad is recommended to be removed.

### Specifications

<b>Lens type</b>	Liquid Crystal Shutter type	<b>Dimensions</b>	Width: 6.97" (177 mm)
<b>Batteries (duration)</b>	Coin-shaped lithium battery CR2032 (approx. 75 hours in continuous use)		Height: 1.82" (46 mm)
<b>Usage temperature range</b>	32 °F – 104 °F (0 °C – 40 °C)	<b>Power supply</b>	DC 3 V
		<b>Mass (including batteries)</b>	0.14 lb (63 g)
<b>Viewing range*</b>	Transmitter for 3D Eyewear Within 3.2m from front surface (Within ±35° horizontal, ±20° vertical)	<b>Materials</b>	Main body: resin Lens section: Liquid crystal glass

\* Viewing range: The location of the 3D Eyewear transmitter (p.13)

## Using for the first time

### ■ Remove the insulating sheet

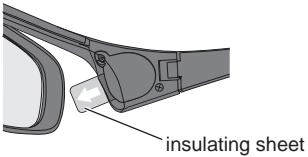

### ■ Attach the specialized band

If the 3D Eyewear slips out of place, use the specialized band included to hold it in place.

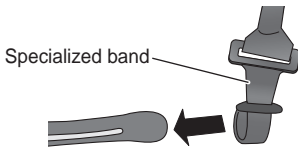

- Attach the band to the left and right tips of the frame, and adjust the length.

### ■ Attach the nose pad

If required, use the included nose pad.

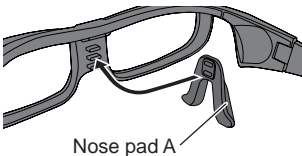

- Nose pad A adjusts the attachment position of the 3D Eyewear between 2 vertical levels. (Slot 2 of the 3 protrusions on the 3D Eyewear deeply into the holes on nose pad A.)
- When using nose pad B, ensure that all 3 protrusions on the 3D Eyewear are inserted deeply into the 3 holes on nose pad B.

## Replacing the batteries

When the remaining battery level is low, the Indicator lamp flashes 5 times upon turning the 3D Eyewear power ON. (Early battery replacement is recommended.)

### ① Loosen the screw from the cover using the screwdriver (included).

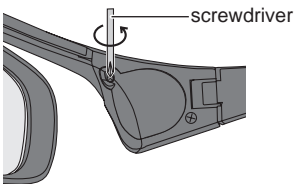

### ② Replace the battery, and then replace the cover.

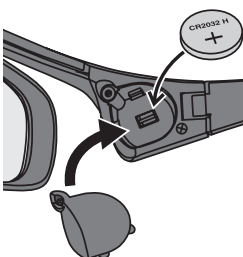

#### Note

- Use the specified type of battery (coin-shaped lithium battery CR2032).
- Do not insert the battery with the polarity (plus ⊕ and minus ⊖) backwards.
- Dispose of the old batteries as non-burnable garbage, or in line with the garbage regulations in your local area.

- Always tighten the screw to hold the battery case cover in place.

# Viewing 3D images on TV (Continued)

## Viewing 3D images

Using the television menu controls, set so that 3D images are shown.

- You can watch 3D images in the following cases: (As of February 2010)
  - When a 3D image supporting Blu-ray Disc is played on a 3D image supporting player/recorder connected using a HDMI cable to a 3D image supporting television.
  - 3D image supported broadcast (program)



■ Press to exit from menu screen



■ Press to return to the previous screen



### 1 Wearing the 3D Eyewear

- ① Press and hold the power button on the 3D Eyewear for approximately 1 second. (The Indicator lamp lights for approximately 2 seconds.)
- ② Put on the 3D Eyewear.  
If the 3D Eyewear slips out of place, hold it in place using the specialized band, and adjust the length of the band. (p. 23)

If the 3D images are not displayed correctly or the images cause discomfort, the images can be adjusted by following this procedure.

\* The perceived three dimensional effects of the 3D Eyewear differ from person to person.

#### ① Display the VIERA TOOLS screen and select "3D"

- Using Setup menu (p. 39)

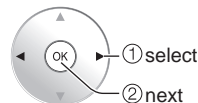

#### ② Select the item and set

- 3D settings (see below)

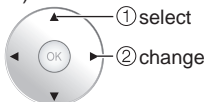
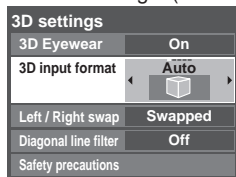

### 2 After Use

- Press and hold the power button on the 3D Eyewear for approximately 1 second. (The Indicator lamp on the 3D Eyewear flashes 3 times, then the power switches off.) After using the 3D Eyewear, store it in the case provided.

## 3D settings

If the images cause discomfort, they can be adjusted with the following settings.

- These settings are reset by switching inputs or selecting channel. (Settings will not be retained.)

#### ■ 3D Eyewear (On/Off)



Off: 3D images can be deactivated by turning "Off" while viewing. (When 3D Eyewear is not worn)

#### ■ 3D input format

(Auto/Side by side/Top and bottom/Native)



**Auto:** (Default) When the HDMI receives information in which 3D mode is detected, 3D images are automatically displayed according to the signal. (Switching may not occur depending on the signal.)

#### Side by side/Top and bottom:

Allows you to set this setting to match the image state.

**Native:** Displays the input signals as is on the screen.

When the HDMI receives information in which Full HD (Frame Sequential Method) is detected, the image is automatically displayed regardless of "3D input format" settings.

#### ■ Left / Right swap (Normal/Swapped)



Change this to On when the phases are reversed (when there is an unusual sense of depth).

#### ■ Diagonal line filter (On/Off)

(Switch "Side by side" and "Top and bottom" types)



On: Resolves discomfort caused by receiving a quincunx matrix signal.

#### ■ Safety precautions

Displays message for viewing 3D images.



## Using Precautions

### ■ Liquid Crystal Shutter

- Do not apply pressure to the liquid crystal shutter. Also, do not drop or bend the 3D Eyewear.
- Do not scratch the surface of the liquid crystal shutter with a pointed instrument etc.  
Doing so may cause damage to the 3D Eyewear, and reduce the quality of the 3D image.

### ■ Infra-red receiver section

- Do not soil the infra-red receiver section or attach stickers etc. to it.
  - Doing so may prevent the receiver from receiving signals from the television, which may prevent the 3D Eyewear from operating normally.
- If the 3D Eyewear is affected by other infra-red data communication equipment, the 3D images may not be displayed correctly.

### ■ Cautions During Viewing

- Do not use devices that emit strong electromagnetic waves (such as cellular phones or personal transceivers) near the 3D Eyewear. Doing so may cause the 3D Eyewear to malfunction.
- The 3D Eyewear cannot operate fully at high or low temperatures.  
Please use within the specified usage temperature range (p. 22).
- If the 3D Eyewear is used in a room in which fluorescent lights (60 Hz) are used, the light within the room may appear to be flickering. In this case, either darken or switch off the fluorescent lights when using the 3D Eyewear.
- Wear the 3D Eyewear correctly. 3D images will not be correctly visible if the 3D Eyewear is worn upside down or back-to-front.
- Liquid crystal displays (such as computer screens, digital clocks, or calculators etc.) may be difficult to see while wearing the 3D Eyewear. (The polarizing axis does not match, causing the displays to appear black.)  
Do not wear the 3D Eyewear when watching anything other than 3D images.
- Individual differences may occur in which the 3D images are difficult to see, or cannot be seen, especially in users that have a different level of eyesight between the left and right eyes. Take the necessary steps (wearing glasses etc.) to correct your eyesight before use.

### ■ For comfortable viewing

- View the screen at a distance at least 3 times further than the effective height of the screen.  
Recommended distance:

For a 50-inch television, 6'2" (1.9m) or more.

Using the 3D Eyewear at a distance closer than the recommended distance may cause eyesight fatigue.

When the top and bottom area of the screen is blackened, such as during some movies, view the screen at a distance 3 times further than the height of the actual image. (That makes the distance closer than above recommended figure.)

## Storage and Cleaning

- Clean using a soft, dry cloth.  
Wiping the 3D Eyewear with a soft cloth that is covered in dust or dirt may scratch the eyewear. Shake off any dust from the cloth before use. Do not use benzene, thinner, or wax on the 3D Eyewear, as doing so may cause the paint to peel off.
- Do not submerge the 3D Eyewear in liquid such as water when cleaning.
- Avoid storing the 3D Eyewear in hot or highly humid locations.

## Troubleshooting/Q&A

Images are not 3D

- Is "3D Eyewear" set to "On"?  
Switch "3D Eyewear" set to "On".
- Is "3D input format" set correctly?  
When the HDMI receives information in which 3D mode is not detected, 3D images are not automatically displayed.  
Adjust "3D input format" according to the 3D images.
- Is there a sticker or other such item blocking the infra-red reception section on the 3D Eyewear?  
The 3D Eyewear operates by receiving signals from the television.  
Check that there are no objects blocking the path between the television and 3D Eyewear.

The power of the 3D Eyewear turns off by itself

- Are there any objects between the eyewear and television?
- Is there a sticker or other such item blocking the infra-red reception section on the 3D Eyewear?  
The 3D Eyewear operates by receiving signals from the television.  
Check that there are no objects blocking the path between the television and 3D Eyewear.
- If the eyewear stops receiving infra-red signals from the television, the power automatically switches off after 5 minutes.

There is something wrong with the 3D images

- Are the left and right sides of the 3D image reversed?  
Switch "Left / Right swap" setting. (p. 24)

Indicator lamp does not light when the 3D Eyewear power button is pressed

- Is the battery level low?  
Battery is run out if the Indicator lamp does not light when the power button is held down more than 1 second. Please replace the battery.

# Viewing with VIERA IMAGE VIEWER (Media player)

The VIERA Image Viewer is a function that lets you easily view still and motion images on a VIERA television by simply inserting an SD card into the VIERA SD card slot.

Media player:

You can also view still and motion images and play music saved on a USB flash memory and an SD card.

## Basic features for Media player

### Available contents and features

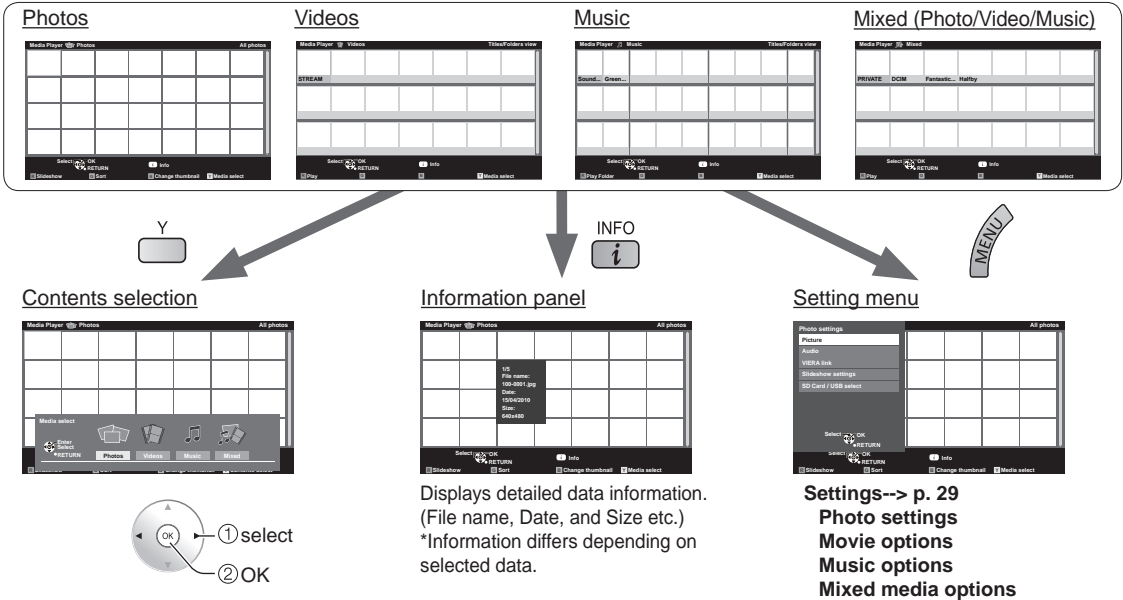

## Media information

### Inserting or removing an SD card/USB flash memory

SD card	USB flash memory
<ul style="list-style-type: none"> <li>● Insert the card Gently insert the SD Card label surface facing front.</li> <li>● Remove the card Press in lightly on SD Card, then release.</li> </ul>	<ul style="list-style-type: none"> <li>● Insert the device Insert straight in</li> <li>● Remove the device Pull straight out</li> </ul>
<ul style="list-style-type: none"> <li>● Compliant card type (maximum capacity): SDXC Card (64 GB), SDHC Card (32 GB), microSDHC Card (16 GB), SD Card (2 GB), miniSD Card (2 GB), microSD Card (2 GB) (requiring microSDHC Card/miniSD Card/microSD Card/ adapter)</li> <li>● If a microSDHC Card, miniSD Card or microSD Card is used, insert / remove it together with the adapter.</li> </ul>	<ul style="list-style-type: none"> <li>● Media player only supports USB Mass storage class devices.</li> </ul>

● For more information and cautions on SD card and USB flash memory (p. 60)



1

# Insert a Media (SD card or USB flash memory)

\* This setting will be skipped next time unless you select "Set later" (SD card only).

## ① Set "Image viewer settings"

## ② Select "Play image viewer now"

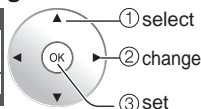
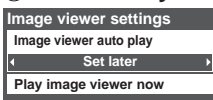

- Slideshow:** A Slideshow will start automatically next time.
- Photos:** The "Photos" will be displayed automatically next time.
- Videos/Music:** The video/music data plays automatically from next time.
- Set later:** "Image viewer settings" menu will be displayed repeatedly.
- Off:** The data can be played manually.

## ② Select the contents ("Set later" only)

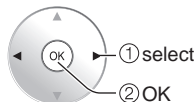

## Manual operation ("Image viewer auto play" is "Off"/For USB flash memory)

### ① Display "Media player" and select contents (SD card only)

SD CARD



● Using VIERA TOOLS (p. 21)



➔ SD card only

● SD card / USB select (p. 29)

2

# Select the data (Photos/Videos/Music/Mixed)

How to view the data differs depending on data storage conditions.

## ① Select Title/Folder

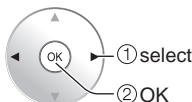

(e.g. Photo-Folders)

## ② Select file

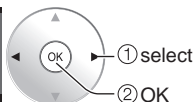

(e.g. Photo-All photos)

● other functions (p. 28-29)

3

# View or Play

## Photo



Navigation area

Photo status



Single



Slide show

● Slideshow (p. 28)

Single photo view

## Movie



Navigation area

Movie banner

Recording format (AVCHD/MPEG2)

Pause

Forward

Play

Stop

Reverse

Elapsed time of current movie

● To display/hide Navigation area and Banner ➔ INFO

● To display/hide Navigation area ➔ SUB MENU

● To display/hide Banner (Photo) ➔ OK

● To display/hide Banner (Movie) ➔ S

## Music

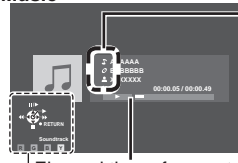

Navigation area

Pause

Forward

Play

Stop

Reverse

Artist name

Album name

Song name

Elapsed time of current song

● To display/hide Navigation area ➔ INFO SUB MENU

● Soundtrack (p. 28) ➔ B



■ Press to exit from a menu screen



■ Press to return to the previous screen



# Viewing with VIERA IMAGE VIEWER

## (Media player) (Continued)

### Photo view

**Switch Thumbnail view**

In ② (p. 27)  
7 x 4 (28 photos)

10 x 6 (60 photos)

B

**Sort**

In ② (p. 27)

① Display "Sort selection" menu  
G

② Select the item

All photos  
Folders  
Sort by date  
Sort by month

① select  
② OK

③ Displays each view (sorted)

(e.g. "Sort by date" view)

Folders (ascending order of numeric/alphabetical)  
Sort by month (ascending order of the month)  
Sort by date (ascending order of the date)

**Slideshow**

In ② (Display All-picture view) (p. 27)

Slideshow

Single view

R

OK

Accessing

Prev. Pause Next Stop

Rotate Play Prev. Next RETURN Stop

### Video view

**Change Current audio status**

In ③ (p. 27)

① Display "Current audio status" SAP

② Each press of SAP will change the Audio mode. (If the movie has multiple audio signals.)

(Current audio status)

● It may take several seconds to change the sound.

### Music view

**Soundtrack**

In ③ (p. 27)  
You can register the music file currently played back or the music files included in the same folder as the current file for Soundtrack.

① Display "Soundtrack" menu  
B

② Select the item

Soundtrack  
This song  
All songs in folder

① select  
② OK

This song: Register current music.  
All songs in folder : Register the music in a folder.

## Photo settings

In ② or ③ (p. 27)

### ① Display "Photo settings"



### ② Select the item

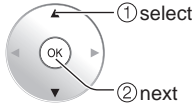
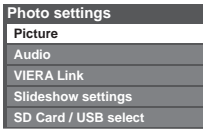

### ③ Set

### ■ Adjust the Picture and Audio

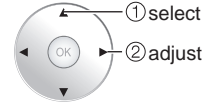
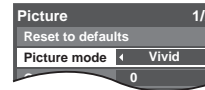

example: Picture menu  
Picture menu/Audio menu (p. 38)

### ■ Use VIERA Link function

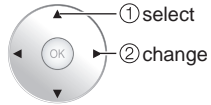

VIERA Link (p. 44)

### ■ SD Card / USB select (SD/USB1/USB2)

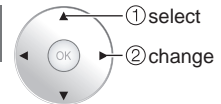

(example)

### ■ Slideshow settings

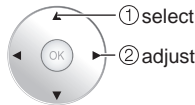
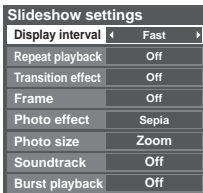

#### Note

- To stop in mid-cycle ➡ Press
- Picture quality may become lower depending on the slideshow settings.
- Picture setting may not work depending on the slideshow settings.

Display interval	You can set "Display interval" each image is displayed in the Slideshow mode. <b>(Short/Fast/Normal/Slow/Very slow)</b>
Repeat playback	Turn the Slideshow Repeat function on or off <b>(Off/On)</b> .
Transition effect	Select the Transition effect <b>(Off /Fade in/Wipe ↓/Wipe ↑/Wipe →/Wipe ←/Slide in ↓/Slide in ↑/Slide in →/Slide in ←/Zoom in/Comb ↑↓/Comb ←→/Dissolve/Checker wipe/Motion/Random)</b>
Frame	Select the Frame <b>(Off/Array/Collage/Drift(with calendar)/Drift/Gallery(with calendar)/Gallery/Cinema)</b>
Photo effect	Select the conversion effect <b>(Off/Sepia/Gray scale)</b>
Photo size	Removes the black borders that are added according to the size of the photo being displayed. <b>(Normal/Zoom)</b>
Soundtrack	Select the music <b>(Off/Music 1/Music 2/Music 3/Music 4/Music 5/User selected/Auto)</b> User selected: Plays the soundtrack registered in the "Soundtrack". (p. 28) Auto: Plays the songs on the root folder(directory) of SD card or USB flash memory.
Burst playback	Continuously plays photos that were shot continuously. <b>(On/Off)</b>

## Movie options/ Music options/ Mixed media options

In ② or ③ (p. 27)

### ① Display "Movie options"/"Music options"/ "Mixed media options"



### ② Select the item

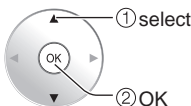
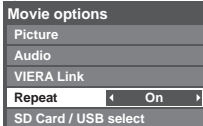

(example: Movie options)

### ③ Set

### ■ Adjust the Picture and Audio

### ■ Use VIERA Link function

### ■ SD Card / USB select

Follow the direction above (Photo settings)

### ■ Set up Repeat playback

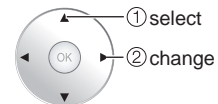
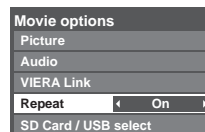

Set play repeat function

Movie: (On/Off)

Music: (Off/One song/Repeat Folder)

# VIERA CAST™

You can access information services (TV content) from the Home screen via the Internet.

- You need broadband environment to use this service.

## Operate VIERA CAST



1

### Preparations

- Internet connections (p. 31)
- Network settings (p. 46-49)

### Display the Home screen



2

### Select the item and press OK



- Press to exit from a menu screen



- Press to return to the Home screen



### Optional Accessory

Communication Camera

- TY-CC10W



- This camera can be used on VIERA CAST.
- For details, read the manual of the Communication Camera.

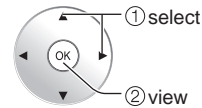

Video communication (e.g. Skype™) requires an exclusive Communication Camera TY-CC10W (above).

This screen is an example. It varies according to the usage conditions.

\* Depending on the usage conditions, it may take a while to read all the data.

- VIERA CAST contents are subject to change without notice.
- Not all VIERA Cast contents are available depending on the country and area.
- 3D images are not displayed on center of the home screen depending on the signal.

### Using USB keyboard

- USB connections (p. 57, 60)
- Keyboard type (p. 39)
- Operate USB keyboard/Entering characters (p.19)

## Other settings

In 2

### 1 Display "Menu"



### 2 Select the item

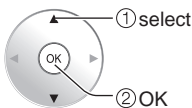
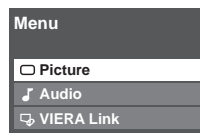

### 3 Set

### Adjust the Picture and Audio

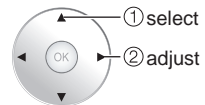
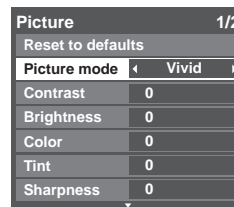

example: Picture menu  
Picture menu/Audio menu  
(p. 38)

### Use VIERA Link function

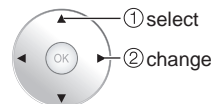

VIERA Link (p. 44)

1

**Contact your Broadband service provider**

NOTICE: If you don't have Internet service by your local provider, please order a high-speed Internet service at no less than the following connection speed. If you already have such service, make sure that the connection speed exceeds the following.

- Required speed (effective): at least 1.5 Mbps for SD and 6Mbps for HD picture quality, respectively.
- Dial-up Internet service cannot be used for VIERA CAST.

2

**Select wired or wireless connection**

If the Cable/DSL modem is close to the TV and you have only one TV set, you may choose a wired connection. If the Cable/DSL modem is far from the TV and/or you have more TVs in the house, you may want to use a wireless network.

3

**Connecting to the internet**

**A Basic connection**

If you are not using the network for connecting anything else but the TV, you could just connect the TV directly to the Cable/DSL Ethernet connection (see schematic below).

**B Advanced wired connection**

If you are using the network for connecting various PCs/Laptops and want to connect the TV, you should use a router to connect the TV to the Internet (see schematic below).

**C Advanced wireless connection 1**

If you are using the network for connecting various PCs/Laptops and want to connect the TV, you could also use a wireless router to connect the TV to the Internet (see schematic below).

**D Advanced wireless connection 2**

If you are using the network for connecting various PCs/Laptops and want to connect the TV, you could also use a wireless LAN adapter and Access point to connect the TV to the Internet (see schematic below).

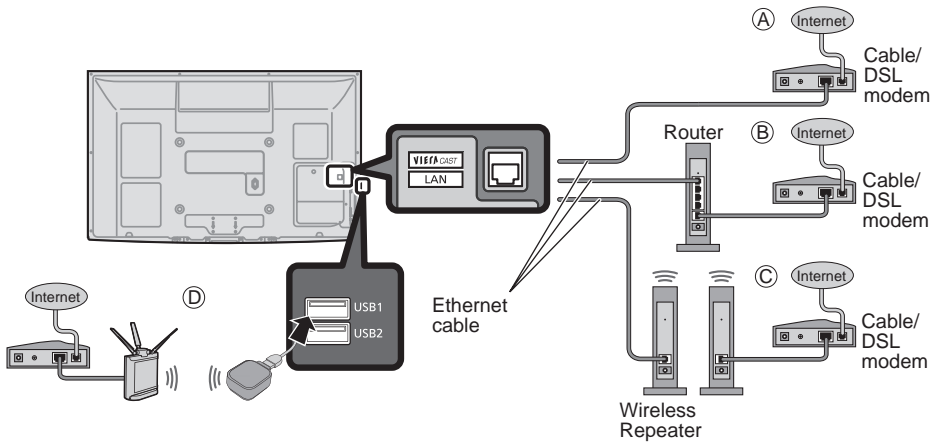

**Example of Network connection**

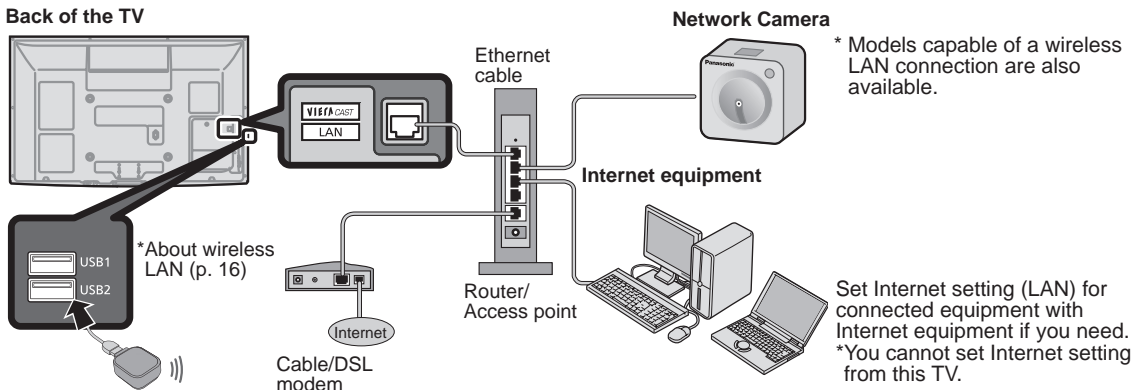

● For more details on the external equipment's connections, please refer to the operating manuals for the equipment

# Network Camera

You can operate the Network camera from the TV remote and also check the images from the Network camera on your TV.

- VIERA Link control only with the TV's remote control (p. 45)

## Basic operation for Network camera



### Preparations

- Internet connections (p. 31)
- Example of Network connection (p. 31)
- Network settings (p. 46-49)
  - Before connecting the Network camera to the TV, please complete "IP setting" and run "Connection test"(p. 46-49)

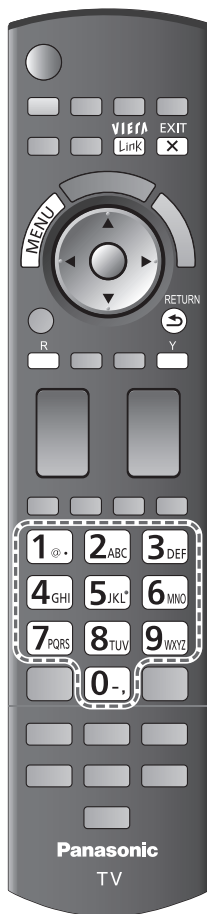

### 1 With all connected equipment turned on Display "VIERA Link" menu



- If there is no registered camera displayed, please set it in Network Camera settings. (p. 33)
- There is also an option to start with sensor detection.

### 2 Select "Network camera"

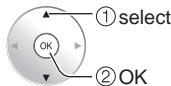
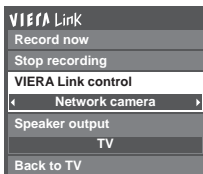

### 3 View 4 split screen

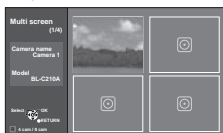

- Default camera setting (p. 33)

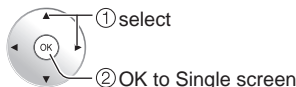

### 9 split screen

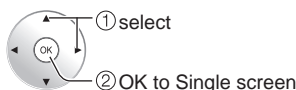

### Single screen



### Navigation area

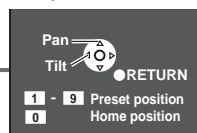

- Press to exit from a menu screen



- Press to return to the previous screen



### Note

- A number of VIERA-compatible network cameras can be found at the following sites:  
<http://www.panasonic.com/>  
<http://panasonic.net/pcc/products/netwkcaml/>
- For more details on setting and operation of the Network camera, please also read the operating manuals for the Network camera.



# Network camera setting

Before using a Network camera, you need to register the camera as shown below. You can also set default camera or disconnect/delete the registered cameras.

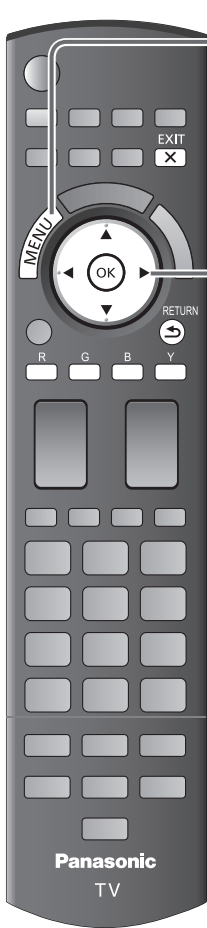

**1** Follow direction ①-③ in “Network settings” (p.46)

**2** Select “Setup” and “Network cameras list”

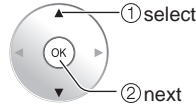
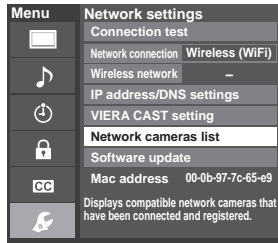

**3** If there is no registered camera  
Select “Yes” to start search

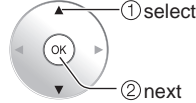
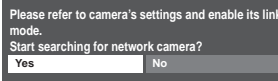

**4** Set Network camera setting

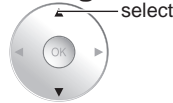
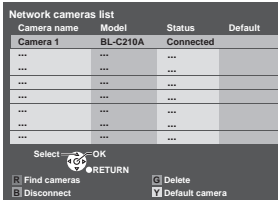

■ Press to exit from a menu screen



■ Press to return to the previous screen



## Network camera setting operation

R	<p>“Please refer to camera's settings and enable its link mode. Start searching for network camera?”</p> <ul style="list-style-type: none"> <li>➡ “Yes” to start camera search.</li> <li>● Before you start to search for a camera, switch the camera to registration mode. (For this operation, please refer to the operating manual for the Network camera.)</li> <li>● Search condition also depends on “Network settings” (p.46-49).</li> </ul>
G	<p>“Remove camera information?”</p> <ul style="list-style-type: none"> <li>➡ “Yes” to delete camera information.</li> </ul>
B	<p>“Disconnect to camera?”</p> <ul style="list-style-type: none"> <li>➡ “Yes” to delete camera connection.</li> <li>“Disconnected” will be displayed in “Status”.</li> </ul>
Y	<p>“Set this camera as default camera?”</p> <ul style="list-style-type: none"> <li>➡ “Yes” to set to the default use.</li> <li>Displayed “(Default)” next to camera name.</li> </ul>
OK	<p>(Available only when reconnecting)</p> <p>“Connect to Camera?”</p> <ul style="list-style-type: none"> <li>➡ “Yes”: “Connect” will be displayed in “Status”.</li> <li>(Attach up to 8 Network cameras simultaneously).</li> </ul>

# Watching Videos and DVDs

If you have applicable equipment connected to the TV, you can watch videos and DVDs on the TV screen.

## Input Select

You can select the external equipment to access.

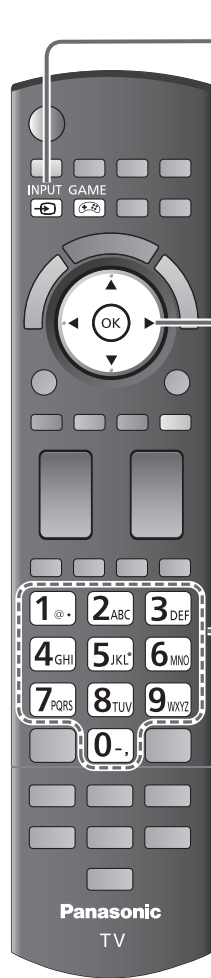

**1** With the connected equipment turned On  
**Display the Input select menu**



**2** **Select the input mode**

Input select		
1	TV	
2	HDMI 1	GAME
3	HDMI 2	
4	HDMI 3	
5	HDMI 4	GAME
6	Component 1	AUX
7	Component 2	
8	Video 1	
9	Video 2	GAME
0	PC	

(example)



or

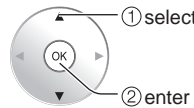

Press the corresponding NUMBER button on the remote control to select the input of your choice.

Select the input of your choice, then press OK.

- During the selection, if no action is taken for several seconds, the "Input select" menu disappears.



(example)

- The terminal and label of the connected equipment are displayed. To label each of the inputs, please refer to p. 55.

### Note

- The Input label will be displayed on the "Input select" screen if the Input label is set on p. 55.
- For side input terminals (HDMI 4/Video 2), "GAME" Input label is set as default. (Picture mode is set to "Game", refer to p. 61.)
- For more details on the Picture mode setting, refer to p. 61. For "Input labels", refer to p. 55.

### ■ Press Game to switch to the game screen

Switches to input terminal that has "GAME" label.



- Cycle through the input terminals if there are multiple input terminals that have "GAME" label. (p. 55)
- If there is no input terminal with "GAME" label, you cannot switch the input terminal to any other input terminal than the one currently selected.

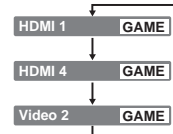

### ■ To return to TV INPUT



**3** **Operate the connected equipment using the remote control supplied with the equipment**

### Note

- For details, see the manual for the connected equipment.

# VIERA Link™ Setting

If you connect equipment that has the “HDAVI Control” function to the TV using an HDMI cable, you will find it easier to use. Please refer to p. 40-45. Before using these functions, you need to set “VIERA Link” setting to “On” as shown below.

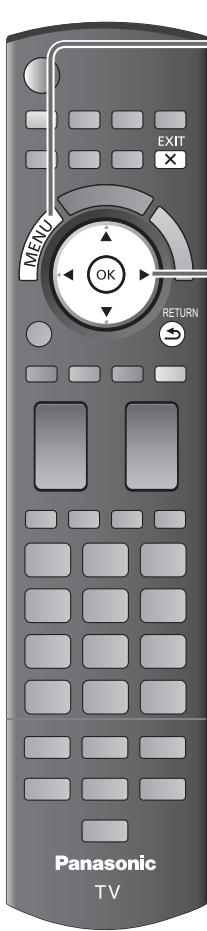

## 1 Display the menu



## 2 Select “Setup”

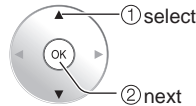
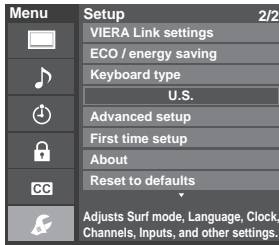

## 3 Select “VIERA Link settings”

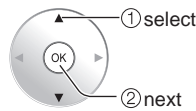
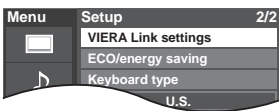

## 4 Select “VIERA Link”

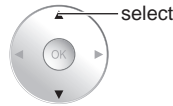
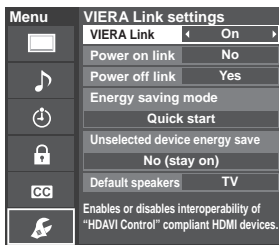

## 5 Select “On” (default is On)



■ Press to exit from a menu screen



■ Press to return to the previous screen



Now you can set each “VIERA Link” function according to your preference (p. 42-45).

### Note

- If no HDMI equipment is connected or standard HDMI equipment (non- “VIERA Link”) is used, set it to “Off”.
- For more details on the external equipment’s connections, please refer to the operating manuals for the equipment.

# Displaying PC Screen on TV

The screen of the PC connected to the unit can be displayed on the TV.  
 You can also listen to PC sound with the audio cable connected. To connect PC. (p. 57)

**1 Display the Input select menu**

Input select		
1	TV	
2	HDMI 1	GAME
3	HDMI 2	
4	HDMI 3	
5	HDMI 4	GAME
6	Component 1	AUX
7	Component 2	
8	Video 1	
9	Video 2	GAME
0	PC	

**2 Select "PC"**

● Corresponding signals (p. 63)

■ To return to TV → /

- **PC menu setting** (change as desired)
- Making settings → "How to Use Menu Functions" ① to ④ (p. 37)

Menu	Item	Adjustments/Configurations (options)
Picture	Reset to defaults	Resets PC adjustments. Confirmation screen is displayed. Select "Yes" and press OK to reset.
	Sync	<ul style="list-style-type: none"> <li>● H &amp; V: The H and V sync signals are input from the HD/VD connector. (p. 63)</li> <li>● On green: Uses a synchronized signal on the Video G signal, which is input from the G connector. (p. 63)</li> </ul>
	Dot clock	Alleviates the problem if a picture appears to be vertically-striped, flickers partially or is blurred.
	H-position	Adjusts the horizontal position.
	V-position	Adjusts the vertical position.
	Clock phase	Alleviates the problem if the whole picture appears to flicker or is blurred. First adjust the Dot Clock to get the best possible picture, then adjust the Clock Phase so that a clear picture appears. <b>Note</b> It may not be possible to display a clear picture due to poor input signals.
	Input resolution	Switches to wide display. <ul style="list-style-type: none"> <li>● Input signal switched from 640×480 to 852×480</li> <li>● Input signal switched from 1024×768 to 1280×768 or 1366×768</li> </ul>
H-frequency V-frequency	Displays the H (Horizontal)/V (Vertical) frequencies. <ul style="list-style-type: none"> <li>● Display range</li> <li>Horizontal: 15 - 110 kHz</li> <li>Vertical: 48 - 120 Hz</li> </ul>	

# How to Use Menu Functions

Various menus allow you to set the picture, sound, and other functions so that you can enjoy watching TV best suited for you.



## 1 Display the menu



- Shows the functions that can be adjusted.
- Some functions will be disabled depending on the type of input signal.

### Menu structure

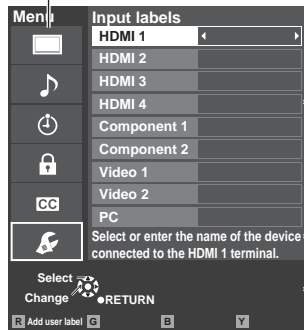

Menu bar  
Press OK to move to the Menu items.

Menu items  
Press OK to proceed to the next screen if available.

Help information

Operation guide

(example: Input labels)

## 2 Select the menu

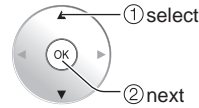
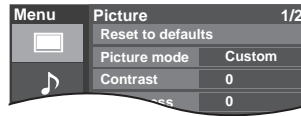

## 3 Select the item

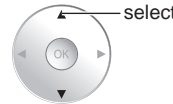
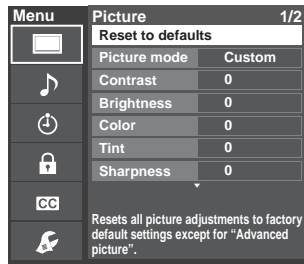

(example: Picture menu)

## 4 Adjust or select

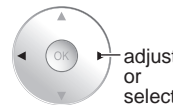
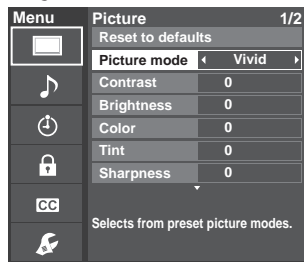

(example: Picture menu)

■ Press to exit from a menu screen



■ Press to return to the previous screen



# How to Use Menu Functions

## ■ Menu list

Menu	Item	Adjustments/Configurations (alternatives)	
Picture	Reset to defaults*	Resets all picture adjustments to factory default settings except for "Advanced picture".	
	Picture mode	Basic picture mode. (p. 61) 2D mode: <b>(Vivid/Standard/THX/Game/Custom)</b> 3D mode: <b>(Vivid/Standard/Cinema/Game/Custom)</b> ● Each setting will be retained independently.	
	Contrast, Brightness, Color, Tint, Sharpness	Adjusts the color, brightness, etc. for each picture mode to suit your taste ● Display range <b>Contrast/Brightness/Color/Sharpness</b> : 0 - 100 <b>Tint</b> -50 - +50	
	Color temp.	Selects a choice of Cool (blue), Normal, or Warm (red) color. <b>(Cool 2/Cool 1/Normal/Warm 1/Warm 2)</b>	
	Color mgmt.	On: Enhances green and blue color reproduction, especially outdoor scenes. <b>(Off/On)</b>	
	x.v.Color	Auto: Provides the appropriate picture when images corresponding to "x.v.Color" are input via the HDMI input of this TV. <b>(Off/Auto)</b>	
	Photo enhancement	Provides appropriate picture when still images are input. <b>(On/Off)</b> * "x.v.color" will not work if "On" is set.	
	C.A.T.S.	Adjusts the brightness and gradation according to the ambient lighting condition. <b>(Off/On)</b>	
	Video NR	Reduces noise, commonly called snow. Leave it off when receiving a strong signal. <b>(Off/Weak/Medium/Strong)</b>	
	Blur reduction	Improves the moving picture resolution. <b>(Off/On)</b>	
	Pro settings	Adjust the "Picture mode" setting in more detail. (p. 62) (This setting can be adjusted only when "Custom" or "Photo" is selected.)	
	Aspect adjustments	Screen format	Changes the format (aspect ratio). <b>(FULL/H-FILL/JUST/4:3/ZOOM)</b> Lets you choose the aspect depending on the format of received signal. (p. 59)
		HD size	Selects between 95 % (Size 1) or 100 % (Size 2) for the scanning area with High-definition signal. <b>(Size 1/Size 2)</b> Select "Size 1" if noise is generated on the edges of the screen. ● Size 1: Selected item for "HD size". Scanning 95 % ● Size 2: Selected item for "HD size". Scanning 100 %
		H size	Adjusts the horizontal display range to reduce noise of both side edges of an image. <b>(Size 1/Size 2)</b> Size 2: Adjusts the image size according to the aspect mode to reduce noise. (p. 62)
		Zoom adjustments	Adjusts vertical alignment and size when aspect setting is "ZOOM"
	PC adjustments	Sets PC display (p. 36)	
	HDMI/DVI RGB range (HDMI 1-4)	Prevents the blown out highlights and blocked up shadows when a wide-range signal is received. Selects between standard RGB range (16-235 bits) or non-compliance (0-255 bits). <b>(Auto/Standard (16-235)/Nonstandard)</b> Auto: Switches the RGB range (Standard (16-235)/Nonstandard) depending on the HDMI signal information.	
	Advanced picture	3D Y/C filter	Minimizes noise and cross-color in the picture. <b>(Off/On)</b>
		Color matrix	Selects image resolution of component-connected devices <b>(SD/HD)</b> ● SD: Standard Definition HD: High Definition ● Only used with 480p video signal.
		Block NR	Reduces noise of specific digital signals of DVD, STB, etc. <b>(Off/On)</b>
Mosquito NR		Reduces HDTV flicker noise in the contoured sections of an image <b>(Off/On)</b>	
Black level		Selects Dark or Light. Valid only for external input signals. <b>(Dark/Light)</b>	
3:2 pulldown		Adjusts the picture recorded in 24 fps for optimum quality. <b>(Off/On/Auto)</b>	
24p Direct in		96Hz/48Hz: Achieves more cinematic playback by reproducing the movie contents at 2 or 4 times the speed of 24 frames per second. If flicker is seen using 48Hz, please use 60Hz or 96Hz. <b>(96Hz/60Hz/48Hz)</b>	
Audio	Reset to defaults*	Resets Bass, Treble, and Balance adjustments to factory default settings.	
	Bass	Increases or decreases the bass response.	
	Treble	Increases or decreases the treble response.	
	Balance	Emphasizes the left / right speaker volume.	
	Advanced audio	A.I. sound	Equalizes overall volume levels across all channels and external inputs. <b>(Off/On)</b>
		BBE ViVA	BBE ViVA HD3D (High-Definition 3D) Sound provides musically accurate natural 3D image with Hi-Fi sound. The clarity of the sound is improved by BBE while the width, depth and height of sound image are expanded by BBE's proprietary 3D sound process. BBE ViVA HD3D Sound is compatible with all TV programs including news, music, dramas, movies, sports and electronic games. <b>(On/Off)</b>
		BBE	BBE High Definition Sound restores clarity and presence for better speech intelligibility and musical realism. <b>(On/Off)</b>
		Surround	Enhances audio response when listening to stereo. <b>(Off/On)</b>
		Volume leveler	Minimizes volume disparity after switching to external inputs.
		TV speakers	Switches to "Off" when using external speakers <b>(Off/On)</b> ● "A.I. sound", "BBE ViVA", "BBE", "Surround" and "Volume leveler" do not work if "Off" is selected.
HDMI 1-4 in	The default setting is "Digital" for the HDMI connection. (Digital input signal) Select audio input terminal when DVI cable is connected. (Analog audio input signal) <b>(Digital/Component 1/Component 2/Video 1/Video 2)</b>		
Timer	Sleep, Timer 1-5	The TV can automatically turn On/Off at the designated date and time. (p. 56)	

■ Menu list

Menu	Item	Adjustments/Configurations (alternatives)	
<b>Lock</b>		Locks the channels and programs. (p. 50)	
<b>Closed caption</b>	<b>Closed caption</b>	Displays subtitles (Closed caption) (p. 54)	
<b>Setup</b>	<b>3D settings</b>	Set the 3D settings (p. 24)	
	<b>Channel surf mode</b>	Sets the mode to select the channel with the Channel up/down button. <b>(All/Favorite/Digital only/Analog only)</b> ● Favorite: Only channels registered as FAVORITE. (p. 20)	
	<b>Language</b>	Selects the screen menu language.	
	<b>Clock</b>	Adjusts the clock. (p. 17)	
	<b>ANT/Cable setup</b>	Sets channels. (p. 53)	
	<b>Input labels</b>	Selects the terminal and label of the external equipment. (p. 55)	
	<b>Anti Image retention</b>	<b>Pixel orbiter</b>	Prevents "Image retention" with Wobbling. <b>(Automatic/Periodic)</b> ● Automatic: Shifts the display image automatically. ● Periodic: Shifts the display image every (1/2/3/4) minutes according to what was set in the "Time (minutes)" menu.
		<b>Time (minutes)</b>	Sets the time for the "Pixel orbiter-Periodic" setting. <b>(1/2/3/4)</b>
		<b>4:3 side bars</b>	Changes the brightness of the side bar <b>(Off/Dark/Mid/Bright)</b> (4:3 mode only) ● The recommended setting is "Bright" to prevent the panel "Image retention". (p. 62)
		<b>Scrolling bar</b>	Press "OK" to start the horizontal "Scrolling" on the screen. (p. 62)
	<b>Network settings</b>	Sets Network settings (p. 46)	
	<b>VIERA Link settings</b>	<b>VIERA Link</b>	Controls the equipment connected to HDMI terminals. <b>(Off/On)</b> (p. 42) ● "Power off link", "Power on link", "Energy saving mode", "Unselected device energy save" and "Default speakers" cannot be selected if "Off" is set.
		<b>Power on link</b>	Sets "Power on link" of the HDMI connected equipment. <b>(No/Yes)</b> (p. 42)
		<b>Power off link</b>	Sets "Power off link" of the HDMI connected equipment. <b>(No/Yes)</b> (p. 42)
		<b>Energy saving mode</b>	Sets "Energy saving mode" of the HDMI connected equipment. <b>(Quick start/Save)</b> (p. 42)
		<b>Unselected device energy save</b>	Sets "Unselected device energy save" of the HDMI connected equipment. (p. 42) <b>(No (stay on)/Yes (with prompt)/Yes (no prompt))</b>
		<b>Default speakers</b>	Selects the default speakers. <b>(TV/Theater)</b> (p. 42)
	<b>ECO/energy saving</b>	<b>No signal for 10 minutes</b>	To conserve energy, the TV automatically turns off when NO SIGNAL and NO OPERATION continue for more than 10 minutes. <b>(Stay on/Power TV off)</b> <b>Note</b> ● Not in use when "Auto power on", "On/Off Timer" or "Lock" is set, or while "SD mode" or "Digital Channel" is selected. ● "No signal for 10 minutes was activated" will be displayed for about 10 seconds when the TV is turned on for the first time after the power was turned off by "No signal for 10 minutes". ● The on-screen display will flash 3, 2 and 1 to indicate the last three (3) remaining minutes prior to the shut-off.
		<b>No activity for 3 hours</b>	To conserve energy, the TV automatically turns off when no operation of remote and side panel key continues for more than 3 hours. <b>(Stay on/Power TV off)</b> <b>Note</b> ● Not in use when "Auto power on" or "On/Off Timer" is set, or while "PC inputs" is selected. ● "No activity for 3 hours was activated" will be displayed for about 10 seconds when the TV is turned on for the first time after the power was turned off by "No activity for 3 hours". ● The on-screen display will flash 3, 2 and 1 to indicate the last three (3) remaining minutes prior to the shut-off.
	<b>Keyboard type</b>	Select keyboard type. Operate USB keyboard (p. 19) <b>(U.S./Canadian French/Canadian Multilingual Standard/Spanish (Latin America)/Spanish (Spain))</b>	
<b>Advanced setup</b>	<b>Auto power on</b>	Turns TV On automatically when the cable box or connected device is turned On <b>(No/Yes)</b> TV AC cord must be plugged into this device. TV turns on every time the power is restored. ● The "Sleep" timer, "On / Off timer", and "First time setup" will not function if "Auto power on" is set. (p. 56)	
	<b>Image viewer LED</b>	Set to "On", if you want to light Image viewer LED while SD card is inserted. <b>(On/Off)</b>	
	<b>Image viewer auto play</b>	Sets the media contents or playback type to play back SD cards automatically. <b>(Slideshow/Photos/Videos/Music/Set later/Off)</b>	
<b>First time setup</b>	Restarts the first time setup from "Language" setting. (p. 14)		
<b>About</b>	Displays TV version and software license.		
<b>Reset to defaults</b>	Performing Reset will clear all settings made with Setup, such as channel settings. (p. 52)		

■ Sub menu list

Menu	Item	Adjustments/Configurations (alternatives)
<b>Setup SUB MENU</b>	<b>Channel surf mode</b>	Sets the mode to select the channel with the Channel up/down button. <b>(All/Favorite/Digital only/Analog only)</b>
	<b>Set favorite</b>	Sets favorite channels. (p. 19)
	<b>Edit CH caption</b>	Changes the station identifier. (p. 53)
	<b>Signal meter</b>	Checks the signal strength if interference or freezing occurs on a digital image. (p. 53)

● In the AV mode, the Audio and Setup menus give fewer options.

\* Confirmation screen is displayed. Select "Yes" and press OK to reset.

# VIERA Link™ “HDAVI Control™”\*

Simultaneously control all Panasonic “HDAVI Control” equipped components using one button on the TV remote.

Enjoy additional HDMI Inter-Operability with Panasonic products which have the “HDAVI Control” function.

This TV supports “HDAVI Control 5” function.

Connections to the equipment (DVD recorder DIGA, HD Camcorder, Home theater system, Amplifier, etc.) with HDMI cables allow you to interface with them automatically.

Equipment with the “HDAVI Control” function enables the following operations:

Version	Operations
HDAVI Control or later	<ul style="list-style-type: none"><li>● Automatic Input Switching (p. 43)</li><li>● Power on link (p. 43)</li><li>● Power off link (p. 43)</li><li>● Default speakers (p. 43)</li><li>● One-touch theater playback (p. 43)</li><li>● Speaker control (p. 45)</li></ul>
HDAVI Control 2 or later	<ul style="list-style-type: none"><li>● VIERA Link control only with the TV’s remote control (p. 45)</li><li>● Unselected device energy save (for available equipment only) (p. 43)</li></ul>
HDAVI Control 3 or later	<ul style="list-style-type: none"><li>● Provides setting information (p. 43)</li><li>● Automatic lip-sync function (p. 43)</li><li>● Direct TV recording (p. 45)</li></ul>
HDAVI Control 4 or later	<ul style="list-style-type: none"><li>● Energy saving mode (with Quick Start mode) (p. 43)</li></ul>
HDAVI Control 5	<ul style="list-style-type: none"><li>● Audio Return Channel Audio Return Channel (ARC) is a function that enables digital sound signals to be sent via an HDMI cable.</li></ul>

■ **For the first time/When adding new equipment, reconnecting equipment or changing the setup after the connection, turn the equipment on and then switch the TV on. Set the input mode to HDMI1, HDMI2, HDMI3 or HDMI4 (p. 34), and make sure that the image is displayed correctly.**

VIERA Link “HDAVI Control”, based on the control functions provided by HDMI which is an industry standard known as HDMI CEC (Consumer Electronics Control), is a unique function that we have developed and added. As such, its operation with other manufacturers’ equipment that supports HDMI CEC cannot be guaranteed.

Please refer to the individual manuals for other manufacturers’ equipment supporting the VIERA Link function.

## ■ HDMI cable

This function needs an HDMI compliant (fully wired) cable. Non-HDMI-compliant cables cannot be utilized.

It is recommended that you use Panasonic’s HDMI cable. Recommended part number:

RP-CDHS15 (4.9 ft/1.5 m), RP-CDHS30 (9.8 ft/3.0 m), RP-CDHS50 (16.4 ft/5.0 m)

\* For more details on the external equipment’s connections, please refer to the operating manuals for the equipment.



## VIERA Link™ Connections

Follow the connection diagrams below for HDAVI control of a single piece of AV equipment such as a DVD recorder (DIGA), Home theater system.

Refer to page 42-45 for Setup Menu settings and additional control information.

- Optional HDMI and/or optical cables are not included.

If connection (or setting) of equipment compatible with HDAVI control is changed, switch the power of this unit Off and On again while the power of all equipment is On (so that the unit can correctly recognize the connected equipment) and check that the DVD recorder (DIGA), Home theater system playback operates.

### Note

- HDMI 1 is recommended.

When connecting to HDMI 2/HDMI 3/HDMI 4 set the input mode to HDMI 2/HDMI 3/HDMI 4 (p. 34) initially before connecting to HDMI 2/HDMI 3/HDMI 4. After connection, confirm the HDMI control functions (p. 42-45).

### ■ Connecting this unit to the DVD recorder (DIGA), Home theater system

- For DVD recorder (DIGA): Connect with HDMI cable
- For Home theater system

Connect with the HDMI and audio cables.

If audio cable is not connected, you cannot listen to the TV program through the theater system.

- \* No optical cable is necessary for the equipment that has "HDAVI control 5" and is connected with an HDMI cable. (HDMI 1 only)

### ■ Connecting this unit to a DVD recorder (DIGA) and AV amp

When using a "VIERA Link" audio-video amplifier and a compatible DVD recorder (DIGA) use a daisy chain connection as shown below.

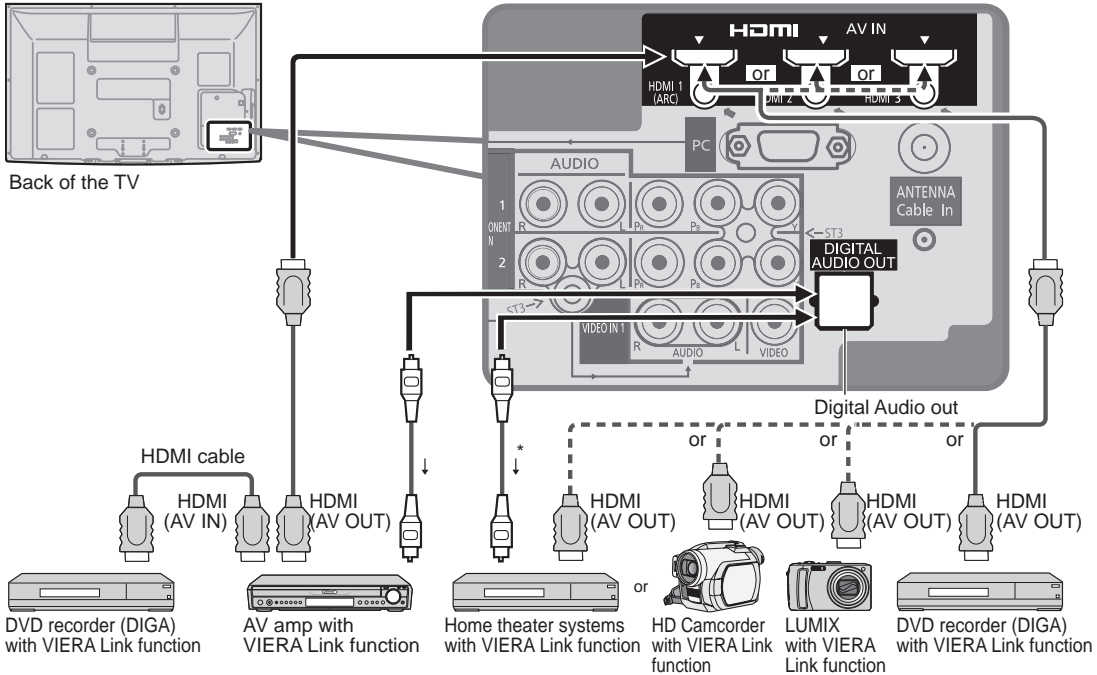

- One AV amp and one DVD recorder (DIGA) can be operated with this unit.
- Be sure to connect the AV amp between this unit and the DVD recorder (DIGA).

### ■ Setting of this unit after connection

After making connections as shown above, set "VIERA Link" (under "VIERA Link settings") to "On" using the Setup menu. (p. 35, 42-45).

### Note

- Individual HDMI equipment may require additional menu settings specific to each model. Please refer to their respective operating instruction manuals.
- When audio from other equipment connected to this unit via HDMI is output using "DIGITAL AUDIO OUT" of this unit, the system switches to 2CH audio. (When connecting to an AV amp via HDMI, you can enjoy higher sound quality.)
- For details about HDMI cables for connecting a Panasonic HD camcorder, read the manual for the equipment.

# VIERA Link™ “HDAVI Control™”\*



**1** Display the menu



**2** Select “Setup”

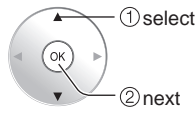
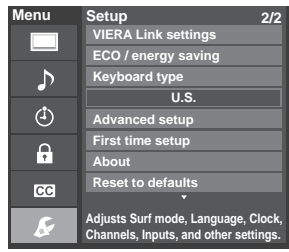

**3** Select “VIERA Link settings”

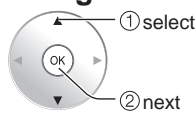
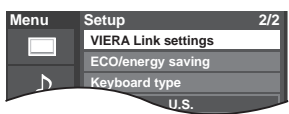

**4** Select “VIERA Link”

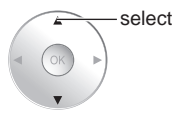
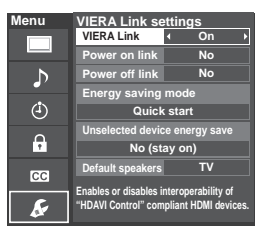

**5** Select “On”  
(default is On)



**6** Select settings

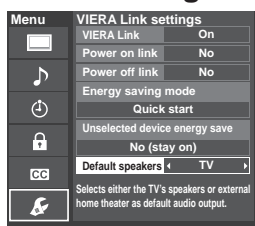

**7** Set

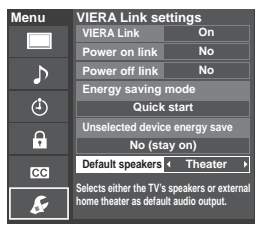

- Automatic Input Switching
- Power on link
- Power off link
- Energy saving mode (for “HDAVI Control 4 or later” (with Quick Start mode))
- Unselected device energy save (for “HDAVI Control 2 or later”)
- Default speakers
- One-touch theater playback
- Provides setting information (for “HDAVI Control 3 or later”)
- Automatic lip-sync function (for “HDAVI Control 3 or later”)

■ Press to exit from a menu screen



■ Press to return to the previous screen



# (Continued)

When using a Blu-ray Disc player, DVD player/recorder or Home theater system, the TV will automatically change to the appropriate input, when playback begins on one of those devices.

- For a Home theater system the speakers automatically switch to the theater system.

When “Yes” is selected (p. 39), the TV is turned on automatically and switches to the appropriate HDMI input whenever VIERA Link compatible equipment is initially turned on and the Play mode is selected.

When “Yes” is selected (p. 39) and the TV is turned off, all connected VIERA Link compatible equipment is also automatically turned off.

- A Panasonic DVD Recorder will not turn off if it is still in Rec mode.

**Caution:** The TV remains on even if the VIERA Link compatible equipment is turned off.

- Condition

Power off link: Yes; Energy saving mode: Quick start

The equipment has “HDAVI Control 4 or later (with Quick Start mode)” connected with an HDMI cable.

When TV is turned off, all connected VIERA Link compatible equipment is moved to ECO Standby mode\* automatically under above conditions.

\* Minimum power consumption of Standby condition for the equipment.

- Condition

Unselected device energy save: Yes

The equipment has “HDAVI Control 2 or later” (for available equipment only) connected with an HDMI cable.

[ Examples of timing for operation ]

- When the input is switched from the HDMI.
- When the “Speaker output” is changed from “Home theater” to “TV”.

The connected VIERA Link compatible equipment will be turned off automatically when not in use.

“TV” is the default setting. To set the Home theater system as Default speakers, change the Default speakers setting from “TV” to “Theater”. Sound will be output from the Home theater whenever the TV is powered on.

If the “ONE TOUCH PLAY” key is pressed on the remote control for a Panasonic Home theater system, the following sequence of operations is performed automatically:

- ① Home theater power switches On, and playback begins.
- ② TV power switches On, and the playback screen is displayed.
- ③ Audio is muted on the TV and switches to the theater system.

The following information about the TV settings can be transmitted to each piece of equipment (Recorder/Home theater/Player) that has “HDAVI Control 3 or later” function connected to a TV with an HDMI cable.

Transmittable data	Recorder	Home theater	Player
① On Screen Display Language setting (English/Español/Français)	○	○	○
② Panel Aspect Ratio (16:9 fixed)	○	○	○
③ Closed caption information (Mode/CC type/Digital setting)	○	---	---
④ Channel information (Input signal/Channel list/Caption information)	○	---	---

### Note

- There is a possibility that all the GUI language information might be set from the equipment, that has an HDMI CEC function connected to the TV with an HDMI cable. Depending on the operating conditions or the specification for each piece of equipment the setting may or may not be applied.
- For more details on the external equipment’s operation, please refer to the operating manuals for the equipment.

### [For Recorder]

- You cannot operate other functions while transmitting the TV’s information above except the Power On/Off key operation. When you turn off this unit, the transmission will be interrupted (only when you are transmitting ④ Channel information).

Minimizes lip-sync delays between the picture and audio when you connect to a Panasonic theater system or Amplifier.

# VIERA Link™ “HDAVI Control™”

You can enjoy more convenient operation with the “HDAVI Control” function in the “VIERA Link” menu.

For more details on the “HDAVI Control” function, refer to p. 40

**1 Display the VIERA Link menu**

or

**2 Select the item**

**3 Select**

■ Press to exit from a menu screen



■ Press to return to the previous screen



**4 Set**

■ **Back to TV**

Returns the input selection of the device selected with the VIERA Link Control to the TV input.

Select “Back to TV”

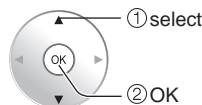

Speaker control

VIERA Link control only with the TV's remote control (for “HDAVI Control 2 or later”)

Direct TV Recording (for “HDAVI Control 3 or later”)

# (Continued)

You can select the Home theater or TV speakers for audio output. Control the theater speakers with the TV remote control. This function is available only when a Panasonic Amplifier or Player theater is connected.

- 1 Select "Speaker output"
- 2 Select "Home theater" or "TV"

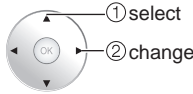
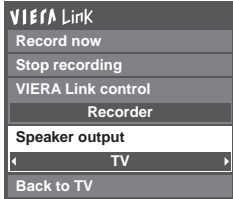

■ **Home theater:** Adjustment for the equipment

Volume up / down →

Mute →

- The sound of the TV is muted.
- When the equipment is turned off, the TV speakers take over.
- Selecting "Home theater" turns the equipment on automatically if it is in Standby mode.

■ **TV:** The TV speakers are on.

In the VIERA Link menu, you can select HDMI connected equipment and access it quickly. Continue using your TV remote control to operate the equipment, pointing it at the TV.

- 1 Select "VIERA Link control"
- 2 Select the equipment you want to access (Recorder/Home theater/Player/Camcorder/LUMIX/Digital camera/Network camera)
  - Using VIERA TOOLS (p. 21)

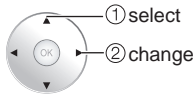

You can select available items only.

- If there is more than one equipment item, a number after the name indicates the number of items. (e.g. Recorder 1/Recorder 2/Recorder 3...)
- The number of equipment items that can be connected is three for recorders, and a total of three for Home theater/Player/Camcorder/LUMIX/Digital camera/Network camera.

**Note**

- There is a limit to the number of HDMI connectors.
- 3 Operate the equipment with the TV remote control, pointing it at the TV
    - To operate the equipment, read the manual of the equipment.

■ **Available TV remote control buttons**

Whether an operation is available differs depending on the connected equipment.

	Move the cursor/Select		Play
	Set/Access		Stop
	Return to previous menu		Reverse/Forward
	Display the functions menu on the equipment		Skip Reverse/Forward
	Available when the purpose of the keys is displayed on screen		Pause
	Exit		Closed caption
	Channel Up/Down		SAP (Select Audio Mode)
	0-9		Select digital subchannel

Records the current program on the recorder immediately.

- 1 Select "Record now"
- 2 Select "Stop recording", when you want to stop recording

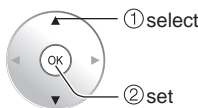
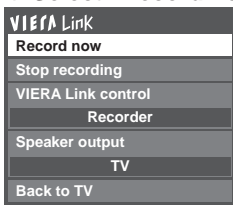

- For optical recording, the settings of the recorder might be required. For details, read the manual of the recorder.

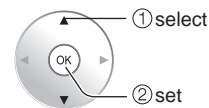
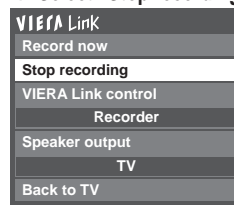

- Recording will not stop automatically when the program is finished.

# Network Settings

This is a setting for connecting to a broadband environment.



## 1 Display the menu



## 2 Select "Setup"

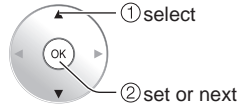
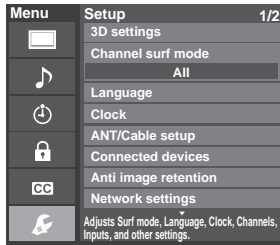

## 3 Select "Network settings"

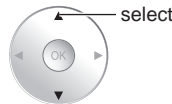
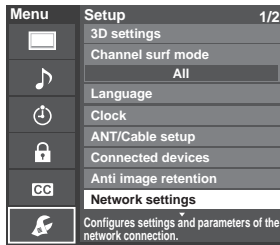

■ Press to exit from a menu screen



■ Press to return to the previous screen



## 4 Select the settings and set

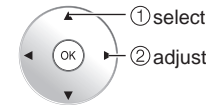
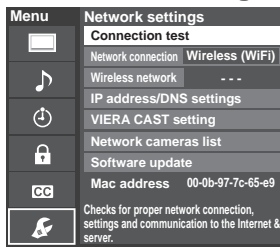

Connection test

Network connection

Wireless network

Check that the Network settings are as shown below, and then start "Connection test".

- ① **Select "Connection test" and press OK**  
(It takes a while to cancel the test.)

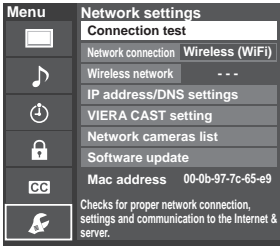

- ② **Displayed Connection test screen**



- ③ **Complete Connection test**

Success->Completion screen is displayed.  
Error->Follow the directions on screen to complete the setting.  
If you perform the Proxy settings, check the Proxy address and the Proxy port number.

Select Network type (**Ethernet cable/Wireless (WiFi)**)

This setting is performed only when "Wireless (WiFi)" is selected in "Network connection" above.

- ① **Press "Wireless network", display screen**  
(only when "---", "No adapter" or "None" is displayed)  
Set the following connection.  
Please select the connection with your wireless LAN adapter and Access point.

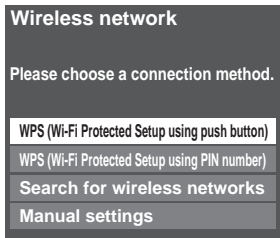

- ② **Follow the directions on screen to complete the setting**

WPS (Wi-Fi Protected Setup using push button):  
Wi-Fi Protected Setup is an easy setting of the Wi-Fi Alliance's certification. You can connect the Access point to press the buttons.  
WPS (Wi-Fi Protected Setup using PIN number):  
Set the PIN code that is displayed on the TV on the Access point.  
(For more details on setting of Access point, please refer to operating manual for the Access point.)  
Search for wireless networks:  
Select an Access point from the ones searched for automatically, and configure the settings as instructed on the screen.  
Manual settings:  
Manually set SSID, Security type, and Encryption type to match the settings of the Access point to which to connect.  
\* When connecting by 11n (5 GHz), select "AES" as the Encryption type for the wireless LAN.

■ **Displayed Connection status with an Access point**



--- : Connect with LAN cable  
No adapter: Wireless LAN adapter is not installed.  
None: There are no settings to connect Access point.  
Connecting...: Currently connected to Access point.  
If "Connected" is not displayed after a while, set the Access point connection settings again.  
Connected: Complete connection.

■ **Displayed "Current settings and status" screen**

(only when "Connected" or "Connecting..." is displayed)

You can confirm the AP connection status.  
(SSID/Wireless type/Security type/Encryption type/Connection status /Signal strength)

- ① **Press "Wireless network"**

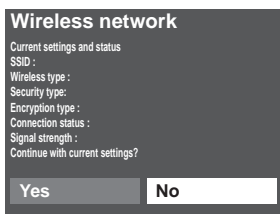

- ② **When you change "Wireless network" -->Press "No"**  
Follow the directions on screen to complete the setting.

You need to be "Connected" to use network devices.  
Please set Access point settings to "Connected".

(example)

# Network Settings

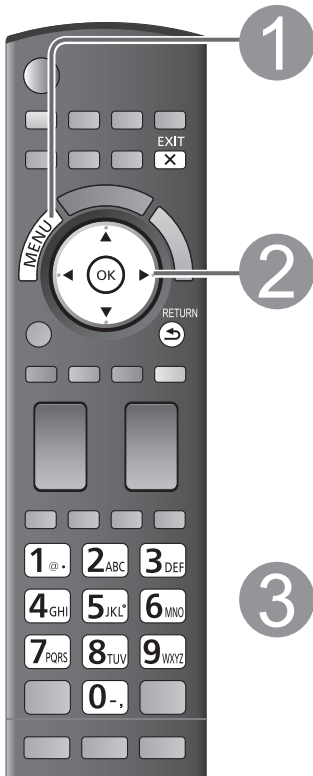

1 Display the menu



2

Select "Setup"

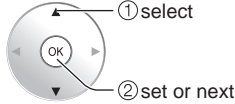
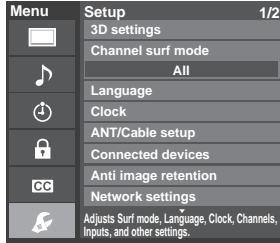

3

Select "Network settings"

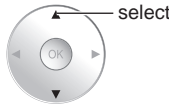
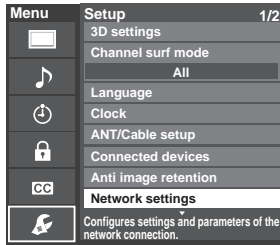

■ Press to exit from a menu screen



■ Press to return to the previous screen



4

Select the item and adjust

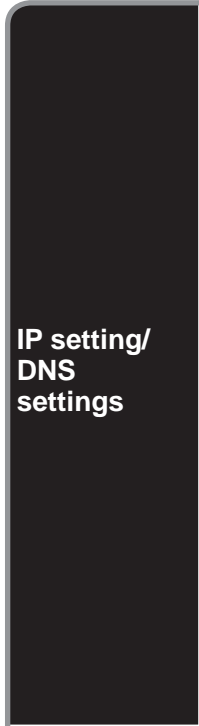
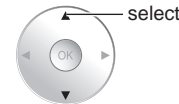
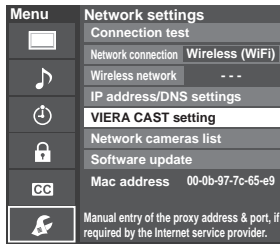



## [IP setting]

### ① Select "IP setting mode" and set to "Automatic"

(When IP automatic acquisition in DHCP can be used)

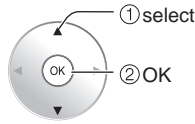
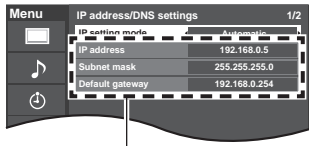

The acquired address is displayed.

### ② Each IP address is acquired automatically

## [DNS settings]

### ① Select "DNS setting mode" and set to "Automatic"

(When DNS automatic acquisition in DHCP can be used)

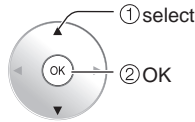
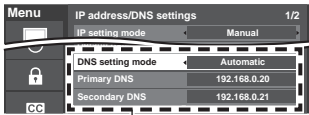

The acquired address is displayed.

### ② Each IP address is acquired automatically

If you are using a broadband router, IP automatic acquisition in DHCP can be used under normal circumstances. If you are not sure, check with the person who installed the equipment, or check the instructions for each device.

Set only if specified by the provider.

It is not required for normal household use.

## ■ Proxy address

This is the address of the relay server that is connected to the target server instead of the browser and sends data to the browser. Setting is only required if specified by the provider.

### ① Select "Proxy address" and press OK

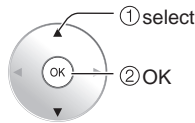
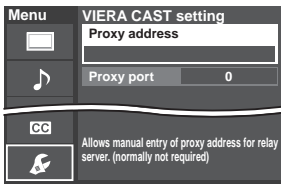

### ② Enter address

(see "Entering characters" on p. 19)



### ③ Select "OK"

## ■ Manual setting

① Select "IP setting mode" and set to "Manual"

② Select the item and press OK

③ Check the specifications of the broadband router and enter each IP address

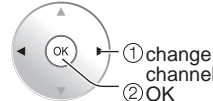

## ■ Manual setting

① Select "DNS setting mode" and set to "Manual"

② Select the item and press OK

③ Enter each IP address as was specified by the provider

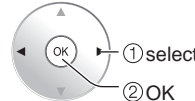

## ■ Proxy port

This number is specified by the provider together with the Proxy address.

① Select "Proxy port" and press OK

② Enter the Port number

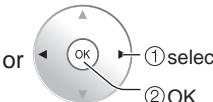

If you perform the Proxy settings, it may make it impossible to view VIERA CAST movie content.

## Network camera setting (p. 33)

### ① Select "Software update"

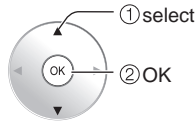
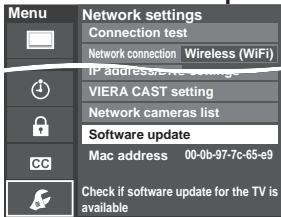

### ② Press OK to start the Software update screen

### ③ Follow directions on the screen

\* Set "Clock" first. (p. 17)

● The Network settings become effective when you close the menu and run "Connection test".

# Lock

You can lock specified channels or shows to prevent children from watching objectionable content.

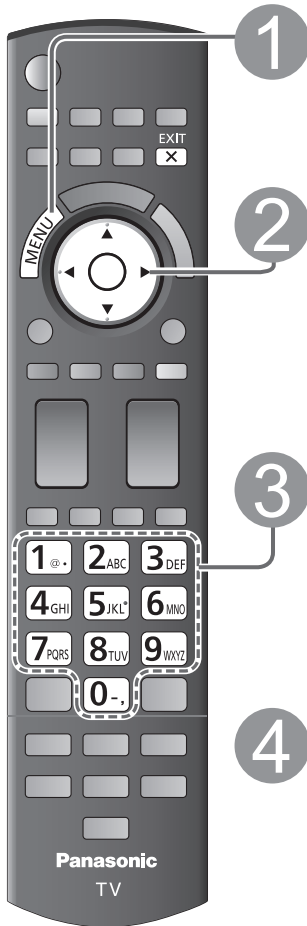

## 1 Display the menu



## 2 Select "Lock"

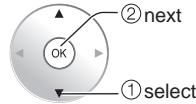
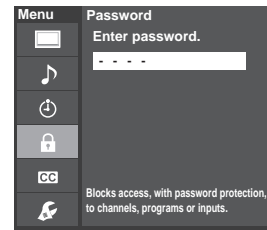

You will be asked to enter your password each time you display the Lock menu.

## 3 Input your 4-digit password

A 4-digit code must be entered to view a blocked program or change rating settings.



- If it is your first time entering the password, enter the password twice in order to register it.

## 4 Select the Lock mode

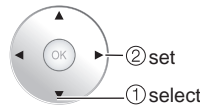
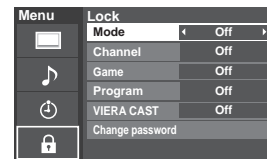

Off: Unlocks all the Lock settings of "Channel", "Game", "Program" and "VIERA CAST".

All: Locks all the inputs regardless of the Lock settings of "Channel", "Game", "Program" and "VIERA CAST".

Custom: Locks specified inputs of "Channel", "Game", "Program" and "VIERA CAST".

### ■ Press to exit from a menu screen



#### Caution

- Make a note of your password in case you forget it. (If you have forgotten your password, consult your local dealer.)

#### Note

- When you select a locked channel, a message will be displayed that allows you to view the channel if you input your password.



## 5 Select the item

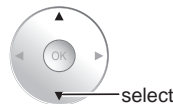
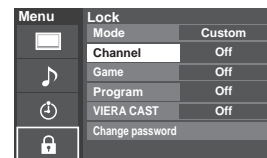

- "Channel", "Game", "Program" and "VIERA CAST" are not accessible unless "Custom" is selected in "Mode".



## 6 Set

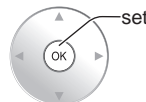

Channel lock

Game lock

Program lock

VIERA CAST lock

Change password

## ■ To select the channel or the rating of the program to lock

Select up to 7 (1-7) channels to block. These channels will be blocked regardless of the program rating.

### ① Select "Mode" and set to "Custom"

### ② Select a channel to lock

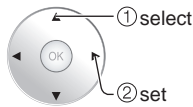
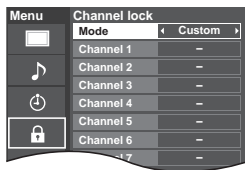

- To lock/unlock all channels:  
Select "Mode" and set to "All" or "Off".

All: Locks all channels  
Off: Unlocks all channels

Locks Channel 3, Channel 4, and external inputs.

### Select "Game" in ⑤ and set to "On"

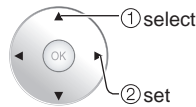

On: Locks  
Off: Unlocks

## ■ To set a rating level

"V-chip" technology enables restricted shows to lock according to TV ratings.

### ① Select "Mode" and set to "On"

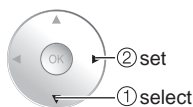
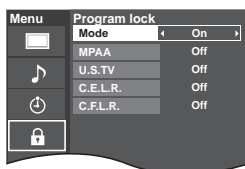

### ③ Select the rating to lock



Example of "MPAA" (U.S. movie ratings)

NR	No rating
G	General Audience: All ages admitted
PG	Parental Guidance Suggested
PG-13	Parents Strongly Cautioned: Inappropriate for children under 13
R	Restricted: Under 17 requires accompanying parent or adult guardian
NC-17	No one 17 and under admitted
X	Adults only

- To get more information (p. 58)

### ② Select the rating category you wish to follow

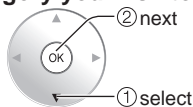
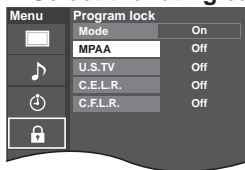

MPAA: U.S. movie ratings  
U.S.TV: U.S. TV program ratings  
C.E.L.R.: Canadian English ratings  
C.F.L.R.: Canadian French ratings

## VIERA CAST lock

Locks VIERA CAST.

Select "VIERA CAST" in ⑤ and set to "On".

When you press VIERA CAST, the "VIERA CAST Lock" screen is displayed.

Type the correct password to enter the Home screen.

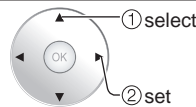

On: Locks  
Off: Unlocks

## ■ To change the password

- ① In ④, select "Change password" and press OK
- ② Input the new 4-digit password twice

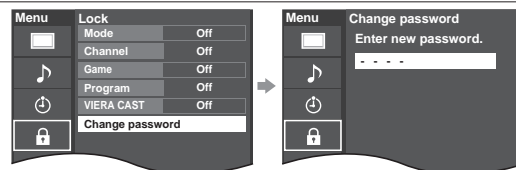

### Note

- This television is designed to support the "Downloadable U.S. Region Rating System" when available. (Available only in U.S.A.)
- The Off rating is independent of other ratings.
- When placing a lock on a specific-age-based-rating level, the Off rating and any other more restrictive ratings will also be blocked.

# Editing and Setting Channels

The current channel settings can be changed according to your needs and reception conditions.



## 1 Display the menu



## 2 Select "Setup"

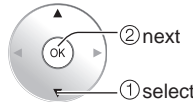
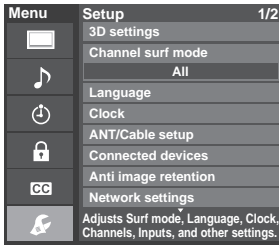

## 3 Select "ANT/Cable setup"

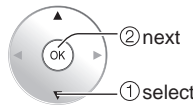
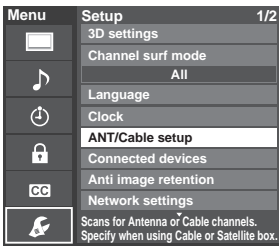

## 4 Select the function

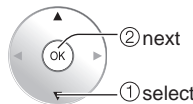
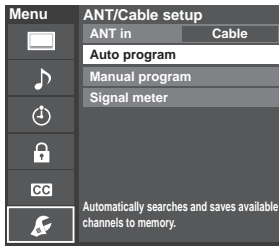

## 5 Set

■ Press to exit from a menu screen



**Auto program**  
Set automatically

**Manual program**  
Set manually

**Signal meter**  
Check signal strength

### ■ To reset the settings of the Setup menu

- ① Select "Reset to defaults" in the Setup menu (⊕) and press OK
- ② Input your 4-digit password with the number buttons
- ③ Select "YES" on the confirmation screen and press OK

Automatically searches and adds available channels to the memory.

- Select "ANT in"**  
 → Select "Cable" or "Antenna"  
 Or select "Not used" (p. 15).

- Select "Auto program"**

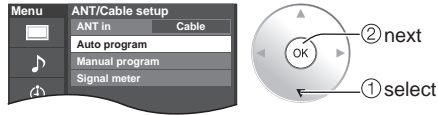

- Select a scanning mode (p. 15)**



Settings are made automatically

- After the scanning is completed, select "Apply". (see below ⑤).
- All previously saved channels are erased.

Use this procedure when changing the channel setup or changing the channel display. Also, use this to add or skip channels from the channel list manually.

You can select a channel tuning mode (Digital only/Analog only) in "Channel surf mode"(p. 39)

- Select "Edit"**



- Select the item to edit**



- Caption: Changes the station identifier
- Favorite: Registers channels to the Favorite List
- Add: Adds or skips channels

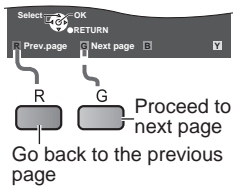

- Edit**

- **Caption**

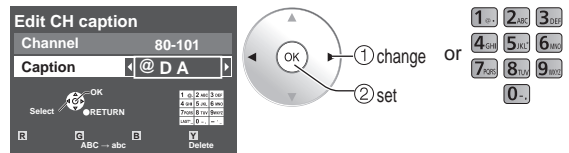

**Caption**  
 Select or edit the station identifier.  
 (maximum 7 characters available)

- **Favorite**

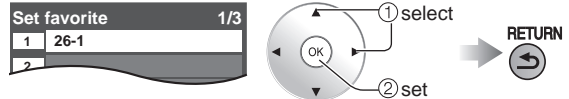

**Set favorite** Select the number

- **Add**  
 Press OK to select "Yes (add)" or "No (skip)"

- Move the cursor to a channel number**

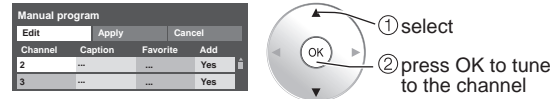

- Select "Apply"**



### To cancel the Edit

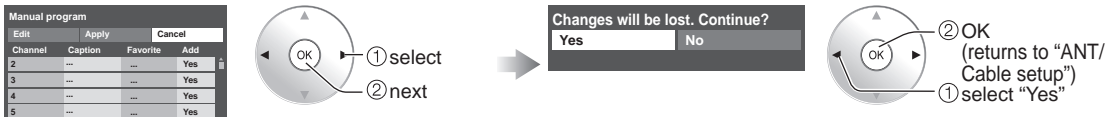

Check the signal strength if interference is found or freezing occurs on a digital image.

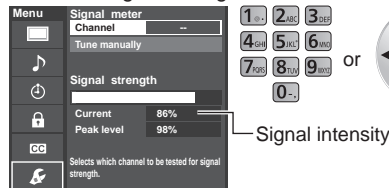

- If the signal is weak, check the antenna.  
 If no problem is found, consult your local dealer.

**Note**

- Not available if "Cable" is selected in "ANT in" (see above).
- Available only for digital antenna channels.

• If "Lock" (p. 50) is activated and "ANT/Cable setup" is selected, "Enter password." will be displayed.

# Closed Caption

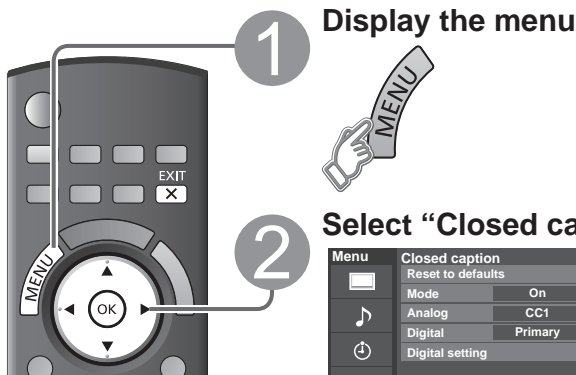

1 Display the menu

2 Select "Closed caption"

■ Press to exit from a menu screen

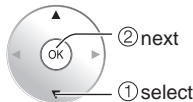
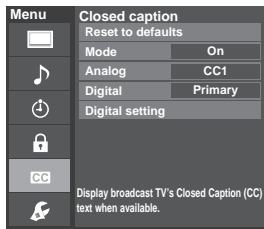

The television includes a built-in decoder that is capable of providing a text display of the audio. The program being viewed must be transmitting the Closed caption (CC) information. (p. 59)

## ■ Select the item and set

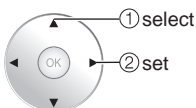
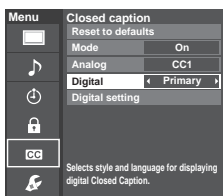

- The settings in "Analog" or "Digital" depend on the broadcaster.

**Mode** On: To display Closed captions.  
CC on mute: To display Closed captions when the audio is muted.  
(When not using, select "Off").

**Analog** (Choose the Closed caption service of Analog broadcasting.)  
CC1-4: Information related to pictures (Appears at the bottom of the screen)  
T1-4: Textual information (Appears over the entire screen)

**Digital** (The Digital Closed caption menu lets you configure the way you choose to view the digital captioning.)  
Select the setting.  
● "Primary", "Second.", "Service 3", "Service 4", "Service 5", "Service 6"

## ■ To make more in-depth display settings in digital programs

- 1 Select "Digital setting" and press OK
- 2 Select the item and set

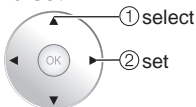
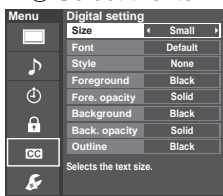

- Size** Text size
- Font** Text font
- Style** Text style (Raised, Depressed, etc.)
- Foreground** Color of text
- Fore. opacity** Opacity of text
- Background** Color of text box
- Back. opacity** Opacity of text box
- Outline** Outline color of text (Identify the setting options on the screen.)

## ■ To reset the settings

- 1 Select "Reset to defaults". Confirmation screen is displayed.
- 2 Select "Yes" and press OK.

**Closed caption**  
Display  
Closed  
caption

# Input Labels

**1 Display the menu**



**2 Select "Setup"**

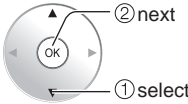

**3 Select "Input labels"**

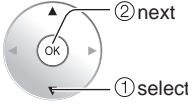

■ Press to exit from a menu screen



Devices connected to external input terminals can be labeled for easier identification during the input selection. (In selecting the input mode from p. 34 ②)

■ Select the terminal and label of the external equipment

Menu	Input labels
	HDMI 1
	HDMI 2
	HDMI 3
	HDMI 4
	Component 1
	Component 2
	Video 1
	Video 2
	PC
	Select or enter the name of the device connected to the HDMI 1 terminal.



① select



② set

or

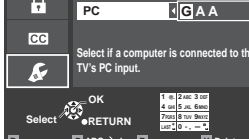

PC G A A

Select if a computer is connected to the TV's PC input.

OK RETURN

Select [F] ABC→abc [E] Delete

Follow the instructions on screen to complete the following operations.

**Input labels**  
Display labels of connected devices

Label	Terminal
Video 1 VCR	

[example]

- Terminals: HDMI 1-4/Component 1-2/Video 1-2/PC
- Label: [BLANK] Not used/Blu-ray/DVD/DVD REC/HOME THTR/ GAME/COMPUTER/VCR/CABLE/SATELLITE/DVR/CAMERA/ MONITOR/AUX/RECEIVER/MEDIA CTR/MEDIA EXT/OTHER
- For the PC terminal, only "Not used" is available.
- If "Not used" is selected, the INPUT button press will skip its input.
- Each selected label will be displayed on the "Input select" screen. (p. 34)

# Using Timer

The TV can automatically turn On/Off at the designated date and time.

- The Clock must be set before On time/Off time settings. (p. 17)
- The “Sleep” timer and “On / Off timer” will not work if the “Auto power on” (p. 39) is set.

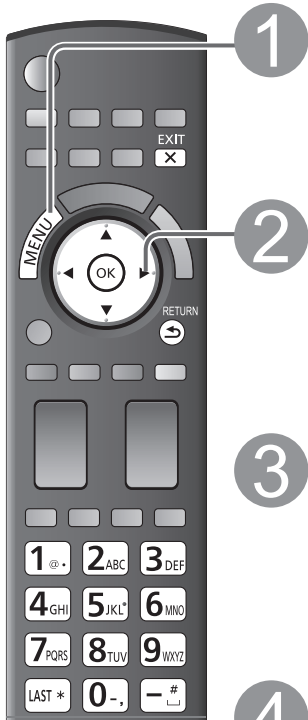

## 1 Display the menu



## 2 Select “Timer”

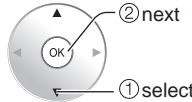
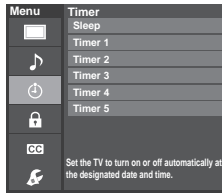

## 3 Select the Timer to set

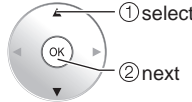
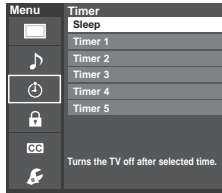

- Sleep** Turns Off automatically
- Timer 1** Turns On/Off automatically (5 timers can be set)
- Timer 5**

## 4 Set the Timer

### Press to exit from a menu screen



### Press to return to the previous screen



### Note

- The TV automatically turns Off after 90 minutes when turned On by the Timer. This operation will be cancelled if the Off time is selected or if a key is pressed.

### To set “Sleep” (Off Timer)

Set to shut the unit off after a pre-selected amount of time.

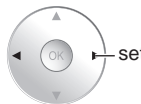
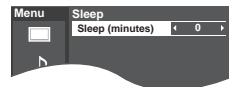

- 0/15/30/60/90 (minutes)

### To set “Timer 1-5” (On/Off Timer)

Select the item and set

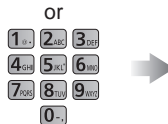
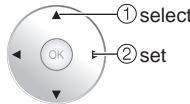

**Timer set** Timer setting (Off/On)

**Inputs** Select the inputs

**Channel** Select the channel

**Day** Select the day

SUN/MON/TUE/WED/THU/FRI/SAT  
(displays the nearest future date)  
MON-FRI/SAT-SUN/DAILY/Every SUN/Every MON/  
Every TUE/Every WED/Every THU/Every FRI/ Every SAT

**On time** The time to turn On

**Off time** The time to turn Off



# Recommended AV Connections

These diagrams show our recommendations of how to connect the TV unit to your various equipment. For other connections, consult the instructions for each piece of equipment and its specifications. For additional assistance, please visit our website at: [www.panasonic.com](http://www.panasonic.com)  
[www.panasonic.ca](http://www.panasonic.ca)

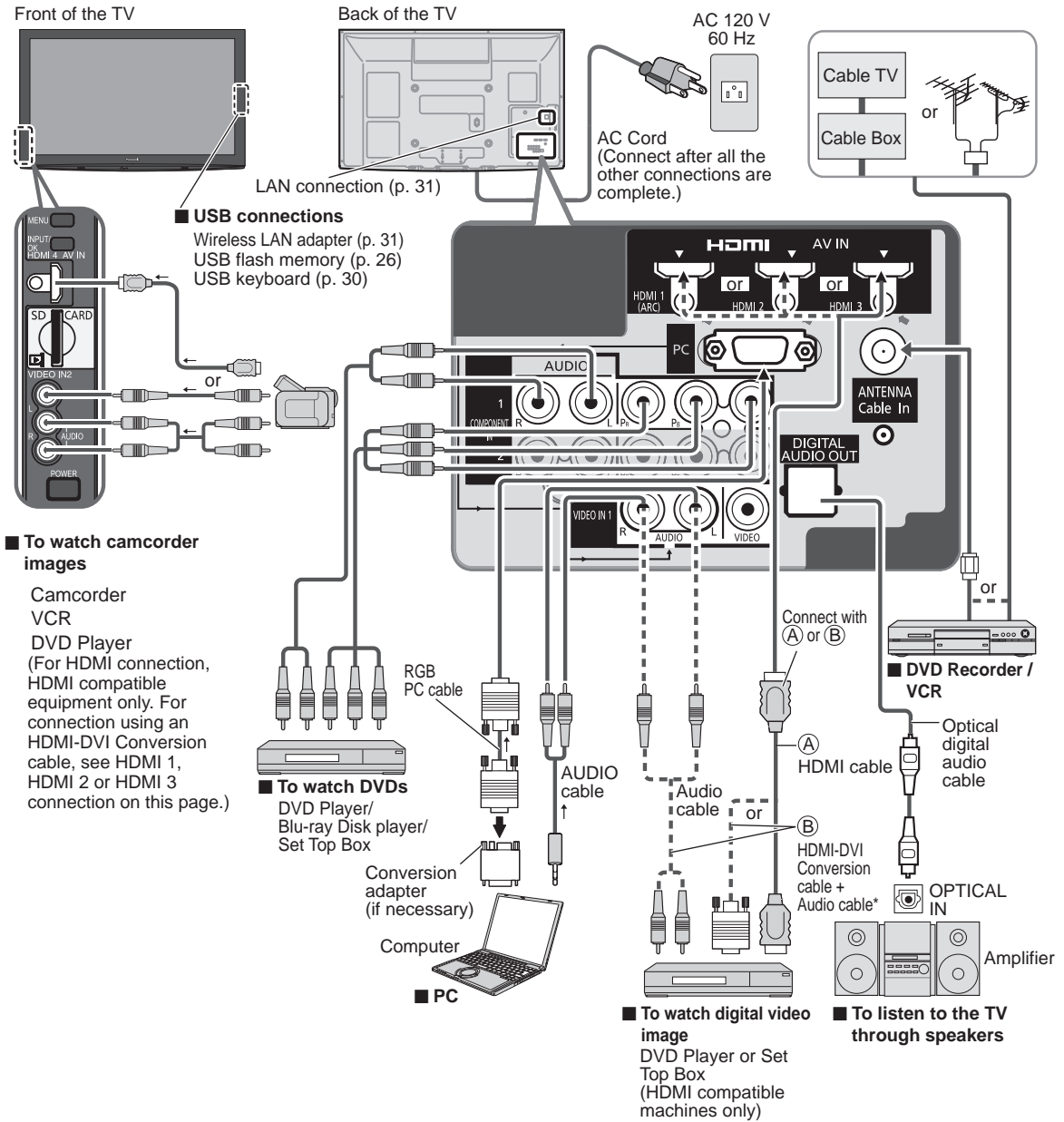

\* Please see p. 38 for the setup when using an external analog audio cable with an HDMI to DVI cable.

# Ratings List for Lock

“V-chip” technology enables you to lock channels or shows according to standard ratings set by the entertainment industry. (p. 51)

## ■ U.S. MOVIE RATINGS (MPAA)

NR	NO RATING (NOT RATED) AND NA (NOT APPLICABLE) PROGRAMS. Movie which has not been rated or where rating does not apply.
G	GENERAL AUDIENCES. All ages admitted.
PG	PARENTAL GUIDANCE SUGGESTED. Some material may not be suitable for children.
PG-13	PARENTS STRONGLY CAUTIONED. Some material may be inappropriate for children under 13.
R	RESTRICTED. Under 17 requires accompanying parent or adult guardian.
NC-17	NO ONE 17 AND UNDER ADMITTED.
X	ADULTS ONLY.

## ■ U.S. TV PROGRAMS RATINGS (U. S. TV)

Age-based Group	Age-based Ratings	Possible Content Selections	Description
NR (Not Rated)	TV-NR	<ul style="list-style-type: none"> <li>● Viewable</li> <li>● Blocked</li> </ul>	Not Rated.
Youth	TV-Y	<ul style="list-style-type: none"> <li>● Viewable</li> <li>● Blocked</li> </ul>	All children. The themes and elements in this program are specifically designed for a very young audience, including children from ages 2-6.
	TV-Y7	<ul style="list-style-type: none"> <li>● FV Blocked</li> <li>● Viewable</li> <li>● Blocked</li> </ul>	Directed to older children. Themes and elements in this program may include mild physical or comedic violence, or may frighten children under the age of 7.
Guidance	TV-G	<ul style="list-style-type: none"> <li>● Viewable</li> <li>● Blocked</li> </ul>	General audience. It contains little or no violence, no strong language, and little or no sexual dialogue or situations.
	TV-PG	<ul style="list-style-type: none"> <li>● D,L,S,V (all selected)</li> <li>● Any combination of D, L, S, V</li> </ul>	Parental guidance suggested. The program may contain infrequent coarse language, limited violence, some suggestive sexual dialogue and situations.
	TV-14	<ul style="list-style-type: none"> <li>● D,L,S,V (all selected)</li> <li>● Any combination of D, L, S, V</li> </ul>	Parents strongly cautioned. This program may contain sophisticated themes, sexual content, strong language and more intense violence.
	TV-MA	<ul style="list-style-type: none"> <li>● L,S,V (all selected)</li> <li>● Any combination of L, S, V</li> </ul>	Mature audiences only. This program may contain mature themes, profane language, graphic violence, and explicit sexual content.

FV: Fantasy/Cartoon Violence. V: Violence S: Sex L: Offensive Language D: Dialogue with sexual content.

## ■ CANADIAN ENGLISH RATINGS (C. E. L. R.)

E	Exempt - Exempt programming includes: news, sports, documentaries and other information programming, talk shows, music videos, and variety programming.
C	Programming intended for children under age 8. No offensive language, nudity or sexual content.
C8+	Programming generally considered acceptable for children 8 years and over. No profanity, nudity or sexual content.
G	General programming, suitable for all audiences.
PG	Parental Guidance suggested. Some material may not be suitable for children.
14+	Programming contains themes or content which may not be suitable for viewers under the age of 14. Parents are strongly cautioned to exercise discretion in permitting viewing by pre-teens and early teens.
18+	18+ years old. Programming restricted to adults. Contains constant violence or scenes of extreme violence.

## ■ CANADIAN FRENCH RATINGS (C. F. L. R.)

E	Exempt - Exempt programming.
G	General - Programming intended for audience of all ages. Contains no violence, or the violence content is minimal or is depicted appropriately.
8 ans+	8+ General - Not recommended for young children. Programming intended for a broad audience but contains light or occasional violence. Adult supervision recommended.
13 ans+	Programming may not be suitable for children under the age of 13. Contains either a few violent scenes or one or more sufficiently violent scenes to affect them. Adult supervision strongly suggested.
16 ans+	Programming may not be suitable for children under the age of 16. Contains frequent scenes of violence or intense violence.
18 ans+	Programming restricted to adults. Contains constant violence or scenes of extreme violence.

### Caution

- The V-Chip system that is used in this set is capable of blocking “NR” programs (non rated, not applicable and none) as per FCC Rules Section 15.120(e)(2). If the option of blocking “NR” programs is chosen “unexpected and possibly confusing results may occur, and you may not receive emergency bulletins or any of the following types of programming:”
  - Emergency Bulletins (Such as EAS messages, weather warnings and others)
  - Locally originated programming • News • Political • Public Service Announcements • Religious • Sports • Weather

# Technical Information

## Closed Caption (CC)

- For viewing the CC of digital broadcasting, set the aspect to FULL (If viewing with H-FILL, JUST, ZOOM or 4:3; characters might be cut off).
- The CC can be displayed on the TV if the receiver (such as a set-top box or satellite receiver) has the CC set On using the Component or HDMI connection to the TV.
- If the CC is set to On on both the receiver and TV when the signal is 480i (except for the HDMI connection), the CC may overlap on the TV.
- If a digital program is being output in analog format, the CC data will also be output in analog format.
- If the recorder or output monitor is connected to the TV, the CC needs to be set up on the recorder or output monitor.

## Aspect Ratio (FORMAT)

Press the FORMAT button to cycle through the aspect modes. This lets you choose the aspect depending on the format of the received signal and your preference. (p. 19)  
(e.g.: in case of 4:3 image)

### ● FULL

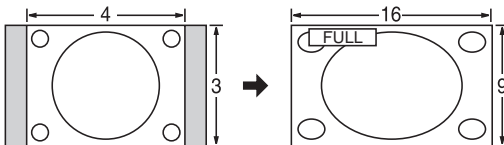

Enlarges the 4:3 image horizontally to the screen's side edges.  
(Recommended for anamorphic picture)

### ● JUST

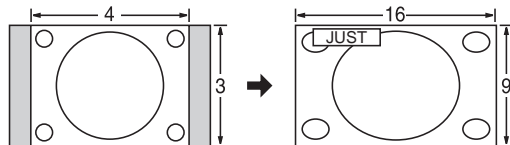

Stretches to justify the 4:3 image to the four corners of the screen.  
(Recommended for normal TV broadcast)

### ● H-FILL

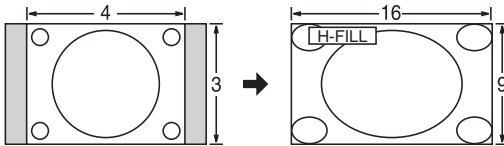

Enlarges the 4:3 image horizontally to the screen's side edges. The side edges of the image are cut off.

### ● 4:3

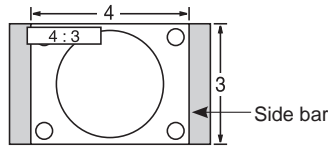

Standard  
(Note that "Image retention" of the side bar may occur from displaying it for a long time.)

### ● ZOOM

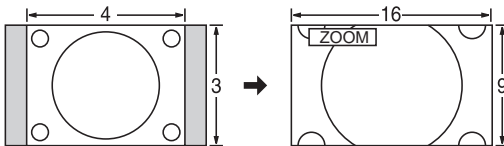

Enlarges the 4:3 image to the entire screen.  
(Recommended for Letter Box)

### Note

- 480i (4:3), 480i (16:9), 480p (4:3), 480p (16:9): FULL, JUST, 4:3 or ZOOM
- 1080p / 1080i / 720p: FULL, H-FILL, JUST, 4:3 or ZOOM

### ● Zoom adjustments

Vertical image position and size can be adjusted in "ZOOM".

- ① Select "Zoom adjustments" on the "Picture" menu. (p. 38)
- ② V-position: Vertical position adjustment



- ③ V-size: Vertical size adjustment

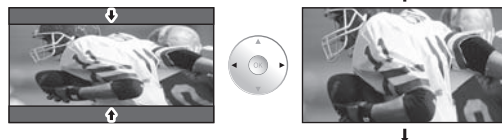

- To reset the aspect ratio →  (OK)

# Technical Information (Continued)

## Data format for SD Card /USB flash memory browsing

**Photo:** Still images recorded with digital still cameras compatible with JPEG files of DCF\* and EXIF\*\* standards  
 Data format-Baseline JPEG (Sub-sampling: 4:4:4, 4:2:2 or 4:2:0)  
 Max. number of files - 9,999 Image resolution - 160 x 120 to 20,000,000

**Movie:** SD-Video Standard Ver. 1.2 [MPEG-2 (PS format)] and AVCHD Standard compatible files with an audio format that is either MPEG-1/Layer-2 format or Dolby Digital format  
 (Modified data with a PC may not be displayed correctly.)

**Music:** MP3 format. (Some files cannot be played.)

\* DCF (Design rule for camera file system): A Japan Electronics and Information Technology Industries Association's standard  
 \*\* EXIF (Exchangeable Image File Format)

### Note

- Format the card with the recording equipment.
- The picture may not appear correctly on this TV depending on the recording equipment used.
- Display may take some time when there are many files and folders.
- The function (VIERA Image Viewer/Media player) cannot display Motion JPEG and still image not DCF formatted (i.e. TIFF, BMP).
- Data modified with a PC may not be displayed.
- Images imported from a PC must be compatible with EXIF 2.0, 2.1 and 2.2.
- Partly degraded files might be displayed at a reduced resolution.
- All ".JPG" extension datas in the card and USB flash memory will be read in Photo viewer Mode.
- The folder and file names may be different depending on the digital camera used.
- Do not use two-byte characters or other special codes.
- The card may become unusable with this TV if file or folder names are changed.
- For the suitable SD Memory Cards, please confirm the latest information on the following website.  
<http://panasonic.jp/support/global/cs> (This site is in English only)

## Cautions in handling SD Card

- Use an SD Card which meets SD standards. If not, it may cause the TV to malfunction.
- Do not remove the card while the unit is accessing data (this can damage card or unit).
- Do not touch the terminals on the back of the card.
- Do not subject the card to high pressure or impact.
- Insert the card in the correct direction (otherwise, card or unit may be damaged).
- Electrical interference, static electricity or erroneous operation may damage the data or card.
- Back up the recorded data at regular intervals in case of deteriorated or damaged data or erratic operation of the unit. (Panasonic is not liable for any deterioration or damage of recorded data.)

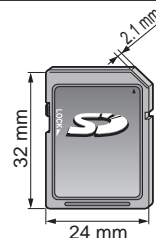

## SD Card/USB flash memory warning messages

### Message

Please insert SD Memory Card into the SD slot at the side of the TV.  
 /Please insert USB storage device into the slot at the side of the TV.

No photos/ No movies/No music files to play/ No playable media

Cannot read file

### Meaning

- The device is not inserted.
- The device has no data or this type of data is not supported.
- The file is broken or unreadable.
- The TV does not support the format.

## Recommended USB device connections

A/B: each USB terminal

Number of USB device	Connections (Recommended)	Memory	Wireless LAN adapter	Keyboard
1	A: Flash memory	A		
	A: Wireless LAN adapter		A	
	A: Keyboard			A
2	A: Flash memory B: Keyboard	A		B
	A: Wireless LAN adapter B: Keyboard		A	B
	A: Flash memory B: Wireless LAN adapter	A	B	

## VIERA Link™ “HDAVI Control™”

HDMI connections to some Panasonic equipment allow you to interface automatically. (p. 40)

- This function may not work normally depending on the equipment condition.
- The equipment can be operated by other remote controls with this function on even if the TV is in Standby mode.
- Image or sound may not be available for the first few seconds when playback starts.
- Image or sound may not be available for the first few seconds when input mode is switched.
- Volume function will be displayed when adjusting the volume of the equipment.
- If you connect equipment that has “HDAVI Control 2 or later” function to the TV with an HDMI cable, the sound from the DIGITAL AUDIO OUT terminal can be output as multi-channel surround.
- “HDAVI Control 5” is the newest standard (current as of December, 2009) for the HDAVI Control compatible equipment. This standard is compatible with the conventional HDAVI equipment.

## HDMI connection

HDMI (high-definition multimedia interface) allows you to enjoy high-definition digital images and high-quality sound by connecting the TV unit and the devices.

HDMI-compatible equipment (\*1) with an HDMI or DVI output terminal, such as a set-top box or a DVD player, can be connected to the HDMI connector using an HDMI compliant (fully wired) cable.

- HDMI is the world's first complete digital consumer AV interface complying with a non-compression standard.
  - If the external equipment has only a DVI output, connect to the HDMI terminal via a DVI to HDMI adapter cable (\*2).
  - When the DVI to HDMI adapter cable is used, connect the audio cable to the audio input terminal.
  - Audio settings can be made on the “HDMI 1 in”, “HDMI 2 in”, “HDMI 3 in” or “HDMI 4 in” menu screen. (p. 38)  
Applicable audio signal sampling frequencies (L.PCM): 48 kHz, 44.1 kHz, 32 kHz
- (\*1): The HDMI logo is displayed on an HDMI-compliant device.  
(\*2): Enquire at your local digital equipment retailer shop.

### Caution

- Use with a PC is not assumed.
- All signals are reformatted before being displayed on the screen.
- If the connected device has an aspect adjustment function, set the aspect ratio to “16:9”.
- These HDMI connectors are “type A”.
- These HDMI connectors are compatible with HDCP (High-Bandwidth Digital Content Protection) copyright protection.
- A device having no digital output terminal may be connected to the input terminal of either “COMPONENT”, or “VIDEO” to receive analog signals.
- The HDMI input terminal can be used with only the following image signals: 480i, 480p, 720p, 1080i and 1080p. Match the output setting of the digital device.
- For details of the applicable HDMI signals, see p. 63.

## DIGITAL AUDIO OUT terminals

You can enjoy your Home theater by connecting a Dolby Digital (5.1 channel) decoder and “Multi Channel” amplifier to the DIGITAL AUDIO OUT terminals.

### Caution

- Depending on your DVD player and DVD-Audio software the copyright protection function may operate and disable optical output.
- When an ATSC channel is selected, the output from the DIGITAL AUDIO OUT jack will be Dolby Digital. When an NTSC channel is selected, the output will be PCM.
- When playing a movie on SD Card Movie player, when the sound has been recorded in Dolby Digital, the output from the DIGITAL AUDIO OUT terminal will be Dolby Digital. When the sound is recorded in other formats, the output will be PCM.

## Picture mode

- Vivid: Provides enhanced picture contrast and sharpness for viewing in a well-lit room.
- Standard: Recommended for normal viewing conditions with subdued room lighting.
- THX (2D mode): Faithfully reproduces the image quality that the movie makers intended in order to provide the ultimate cinematic experience at home.
- Cinema (3D mode): For watching movies in a darkened room. It provides a soft, film-like picture.
- Game: For playing video games. This mode will be set automatically if “GAME” is selected from the Input label setting (p. 55)
- Custom (Photo): Customizes each item according to your taste.  
Photo is displayed in JPEG menu.

### Note

- Picture mode will be automatically set to “Standard” if you change the Input label from “GAME” to other labels.
- Picture mode will be automatically set to “Game” if you change from an Input label other than “GAME” to “GAME” label.

# Technical Information (Continued)

## Pro settings

- **Reset to defaults:** Resets all Pro setting adjustments to factory default settings.
- **W/B high R:** Adjusts the white balance for light red areas.
- **W/B high B:** Adjusts the white balance for light blue areas.
- **W/B low R:** Adjusts the white balance for dark red areas.
- **W/B low B:** Adjusts the white balance for dark blue areas.
- **Black extension:** Adjusts the dark shades of the image in gradation.
- **Gamma adjustment:** Gamma correction. Adjusts the intermediate brightness of the image. (S-curve/1.8/2.0/2.2/2.4/2.6)
- **Panel brightness:** Selects the display panel brightness. (High/Mid/Low)
- **Contour emphasis:** Adjusts the contour emphasis of the image. (0-15)
- **AGC:** Increases the brightness of dark signal automatically. (On/Off)
- **Save as default:** Save all "Picture" (when "Picture mode" is "Custom") and "Pro settings" adjustments.

## H size

- **Aspect Ratio: 4:3**

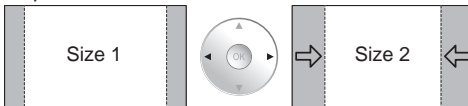

- The width will be decreased on both sides to reduce noise.

- **Aspect Ratio: FULL/JUST(H-FILL/ZOOM)**

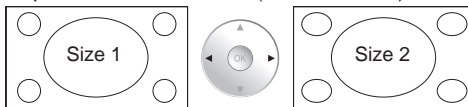

- The width will be increased on both sides to reduce noise.

See page 38 for more information

## 4:3 side bars

Do not display a picture in 4:3 mode for an extended period, as this can cause "Image retention" to remain on either or both sides of the display field.

To reduce the risk of such "Image retention", change the brightness of the side bars.

See page 39 for more information

- The side bar may flash (alternate black/white) depending on the picture.

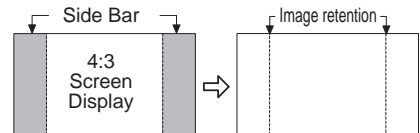

## Scrolling bar

**Scrolling bar:** To prevent "Image retention", scrolls white vertical bar from left to right on a black screen.

- Press any key except the POWER key to return to previous screen.
- You will return to the previous screen if no key operation has been performed for 15 minutes.  
See page 39 for more information

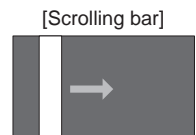

## PC Input Terminals Connection

- Computer signals which can be input are those with a horizontal scanning frequency of 15 to 110 kHz and vertical scanning frequency of 48 to 120 Hz. (However, the image will not be displayed properly if the signals exceed 1,200 lines.)
- Some PC models cannot be connected to the set.
- There is no need to use an adapter for computers with IBM PC/AT compatible D-sub 15P terminal.
- The maximum resolution: 1,280 × 1,024  
If the display resolution exceeds these maximums, it may not be possible to show fine detail with sufficient clarity.
- Signal Names for D-sub 15P Connector

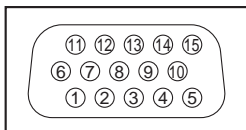

Pin Layout for PC Input Terminal

Pin No.	Signal Name	Pin No.	Signal Name	Pin No.	Signal Name
①	R	⑥	GND (Ground)	⑪	NC (not connected)
②	G	⑦	GND (Ground)	⑫	NC
③	B	⑧	GND (Ground)	⑬	HD/SYNC
④	NC (not connected)	⑨	NC (not connected)	⑭	VD
⑤	GND (Ground)	⑩	GND (Ground)	⑮	NC

## Input signal that can be displayed

\* Mark: Applicable input signal for Component (Y, P<sub>B</sub>, P<sub>R</sub>), HDMI and PC

	horizontal frequency (kHz)	vertical frequency (Hz)	COMPONENT	HDMI	PC
525 (480) / 60i	15.73	59.94	*	*	
525 (480) /60p	31.47	59.94	*	*	
750 (720) /60p	45.00	59.94	*	*	
1,125 (1,080) /60i	33.75	59.94	*	*	
1,125 (1,080)/60p	67.43	59.94		*	
1,125 (1,080)/60p	67.50	60.00		*	
1,125(1,080)/24p	26.97	23.98		*	
1,125(1,080)/24p	27.00	24.00		*	
640 x 400 @70	31.47	70.08			*
640 x 480 @60	31.47	59.94			*
Macintosh13" (640 x 480)	35.00	66.67			*
640 x 480 @75	37.50	75.00			*
852 x 480 @60	31.44	59.89			*
800 x 600 @60	37.88	60.32			*
800 x 600 @75	46.88	75.00			*
800 x 600 @85	53.67	85.08			*
Macintosh16" (832 x 624)	49.73	74.55			*
1,024 x 768 @60	48.36	60.00			*
1,024 x 768 @70	56.48	70.07			*
1,024 x 768 @75	60.02	75.03			*
1,024 x 768 @85	68.68	85.00			*
Macintosh 21" (1,152 x 870)	68.68	75.06			*
1,280 x 768 @60	47.78	59.87			*
1,280 x 1,024 @60	63.98	60.02			*
1,366 x 768 @60	48.39	60.04			*

### Note

- Signals other than above may not be displayed properly.
- The above signals are reformatted for optimal viewing on your display.

# FAQ

Before requesting service or assistance, please follow these simple guides to resolve the problem.  
If the problem still persists, please contact your local Panasonic dealer or Panasonic Service Center for assistance. For details (p. 69, 70)  
For additional assistance, please contact us via the website at:  
[www.panasonic.com/contactinfo](http://www.panasonic.com/contactinfo)  
[www.panasonic.ca](http://www.panasonic.ca)

## White spots or shadow images (noise)

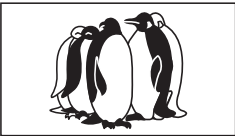

- Check the position, direction, and connection of the antenna.

## Interference or frozen digital channels (intermittent sound)



- Change the direction of antenna for digital channels.
- Check "Signal meter" (p. 53). If the signal is weak, check the antenna and consult your local dealer.

## The remote control does not work

- Are the batteries installed correctly? (p. 8)
- Are the batteries new?

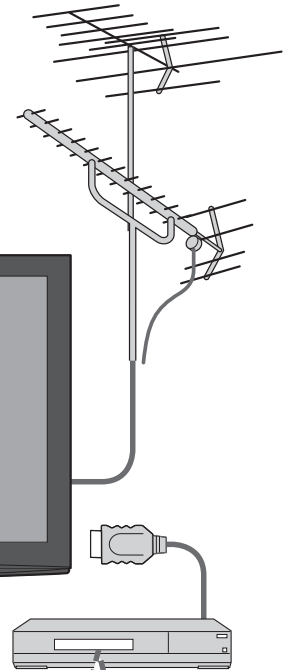
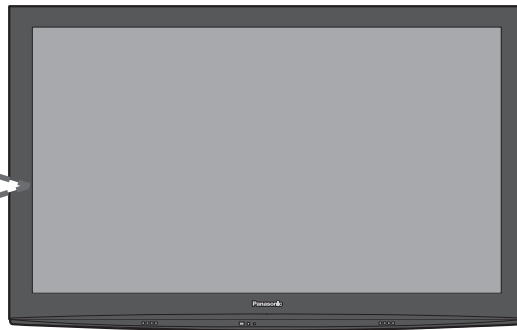

## Pictures from external equipment are distorted when the unit is connected via HDMI

- Is the HDMI cable connected properly? (p. 41, 57)
- Turn Off the TV unit and equipment, then turn them On again.
- Check an input signal from the equipment. (p. 63)
- Use equipment compliant with EIA/CEA-861/861B.

## When the channel is changed on an STB that is connected with HDMI, "HDMI" may be displayed on the top left of the screen

- This is not a malfunction.

## Recording does not start immediately

- Check the settings of the recorder. For details, read the manual of the recorder.



If there is a problem with your TV, please refer to the table below to determine the symptoms, then carry out the suggested check. If this does not solve the problem, please contact your local Panasonic dealer, quoting the model number and serial number (both found on the rear of the TV).

	Problem	Actions
Screen	<b>“VIERA” logo moves on the screen</b>	<ul style="list-style-type: none"> <li>● The function to prevent “Image retention” is activated. (Not a faulty symptom)               <ul style="list-style-type: none"> <li>● The screen saver is activated if the TV unit is not operated for a certain time in SD mode.</li> <li>● “Image retention”. (p. 7)</li> </ul> </li> </ul>
	<b>Some spots remain bright or dark</b>	<ul style="list-style-type: none"> <li>● The Plasma panel is made up of a few million pixels and is produced with advanced technology through an intricate process. Sometimes a few pixels may be bright or dark. These pixels do not indicate a defective panel and will have no impact on the performance of the TV.</li> </ul>
	<b>Chaotic image, noisy</b>	<ul style="list-style-type: none"> <li>● Check nearby electrical products. (car or motorcycle ignition systems, fluorescent lamp, etc.)</li> </ul>
	<b>No image is displayed on screen</b>	<ul style="list-style-type: none"> <li>● Check Picture menu. (p. 38)</li> <li>● Check the cable connections. (p. 11-12)</li> <li>● Check that the correct input has been selected. (p. 34)</li> </ul>
	<b>Only spots are displayed instead of images</b>	<ul style="list-style-type: none"> <li>● Check the channel settings. (p. 52)</li> <li>● Check the antenna cables.</li> </ul>
	<b>Neither image nor sound is produced</b>	<ul style="list-style-type: none"> <li>● Is the AC power cord plugged into the outlet?</li> <li>● Is the TV unit turned On?</li> <li>● Check Picture menu (p. 38) and volume.</li> <li>● Check the AV cable connections. (p. 11-12)</li> <li>● Check that the correct input has been selected. (p. 34)</li> </ul>
Sound	<b>Black Box appears</b>	<ul style="list-style-type: none"> <li>● Change settings of Closed Caption (CC). (p. 54)</li> </ul>
	<b>No sound is produced</b>	<ul style="list-style-type: none"> <li>● Are the speaker cables connected correctly? (p. 57)</li> <li>● Is “Sound Mute” active? (p. 13)</li> <li>● Is the volume set to the minimum?</li> <li>● Is “TV speakers” set to “Off”? (p. 38)</li> <li>● Change “SAP” settings. (p. 18)</li> <li>● Check “HDMI 1 in”, “HDMI 2 in”, “HDMI 3 in” or “HDMI 4 in” settings. (p. 38)</li> </ul>
	<b>Sound is unusual</b>	<ul style="list-style-type: none"> <li>● Set “SAP” setting to “Stereo” or “Mono”.</li> <li>● Check the HDMI device connected to the unit.</li> <li>● Set the Audio setting of the HDMI device to “Linear PCM”.</li> <li>● If digital sound connection has a problem, select analog sound connection.</li> </ul>
	<b>Unknown sound heard</b> 1- Sounds from TV cabinet 2- Whirring sound 3- Tick/Click sound 4- Buzzing sound	<ol style="list-style-type: none"> <li>1- Changes in the temperature and humidity of the room may cause the TV’s cabinet to expand or contract and produce metallic sounds. This is not a sign of faulty operation or a malfunction.</li> <li>2- The TV may have a cooling fan that makes a soft whir. This is not a sign of faulty operation or a malfunction.</li> <li>3- When the TV is powered on, an electrical component in the TV activates producing a tick/click sound. This is not a sign of faulty operation or a malfunction.</li> <li>4- Electrical circuits are active while the TV set is on. This is not a sign of faulty operation or a malfunction.</li> </ol>
	<b>Parts of the TV set become hot</b>	<ul style="list-style-type: none"> <li>● Even when the temperature of parts of the front, top and rear panels has risen, these temperature rises will not pose any problems in terms of performance or quality.</li> </ul>

# Care and Cleaning

**First, unplug the Power cord plug from the wall outlet.**

## Display panel

The front of the display panel has been specially treated. Wipe the panel surface gently using only a cleaning cloth or a soft, lint-free cloth.

- If the surface is particularly dirty, soak a soft, lint-free cloth in diluted mild liquid dish soap (1 part mild liquid dish soap diluted by 100 times the amount of water) and then wring the cloth to remove excess liquid. Use this cloth to wipe the surface of the display panel, then wipe it evenly with a dry cloth of the same type until the surface is dry.
- Do not scratch or hit the surface of the panel with fingernails or other hard objects. Furthermore, avoid contact with volatile substances such as insect sprays, solvents, and thinner; otherwise, the quality of the surface may be adversely affected.

## Cabinet

If the cabinet becomes dirty, wipe it with a soft, dry cloth.

- If the cabinet is particularly dirty, soak the cloth in a weak mild liquid dish soap and then wring the cloth dry. Use this cloth to wipe the cabinet and then wipe it dry with a dry cloth.
- Do not allow any mild liquid dish soap to come into direct contact with the surface of the Plasma TV. If water droplets get inside the unit, operating problems may result.
- Avoid contact with volatile substances such as insect sprays, solvents, and thinner; otherwise, the quality of the cabinet surface may be adversely affected or the coating may peel off. Furthermore, do not leave it for long periods in contact with articles made from rubber or PVC.

## Pedestal

- **Cleaning**  
Wipe the surfaces with a soft, dry cloth. If the unit is particularly dirty, clean it using a cloth soaked with water to which a small amount of mild liquid dish soap has been added and then wipe with a dry cloth.  
Do not use products such as solvents, thinner, or household wax for cleaning, as they can damage the surface coating. (If using a chemically-treated cloth, follow the instructions supplied with the cloth.)
- Do not attach sticky tape or labels, as they can make the surface of the pedestal dirty. Do not allow long-term contact with rubber, vinyl products, or the like. (Doing so will cause deterioration.)

# Specifications

		TC-P50VT20	
<b>Power Source</b>		AC 120 V, 60 Hz	
<b>Power Consumption</b>	<b>Maximum</b>	512 W	
	<b>Standby condition</b>	0.2 W	
<b>Plasma Display panel</b>	<b>Drive method</b>	AC type	
	<b>Aspect Ratio</b>	16:9	
	<b>Visible screen size (W x H x Diagonal)</b>	50" class (49.9 inches measured diagonally) 43.5" x 24.4" x 49.9" (1,105 mm x 622 mm x 1,268 mm)	
	<b>(No. of pixels)</b>	2,073,600 (1,920 (W) x 1,080 (H)) [5,760 x 1,080 dots]	
<b>Sound</b>	<b>Audio Output</b>	30 W [10 W + 10 W + 10 W] (10 % THD)	
<b>PC signals</b>		VGA, SVGA, XGA, WXGA, SXGA Horizontal scanning frequency 31 - 69 kHz Vertical scanning frequency 59 - 86 Hz	
<b>Channel Capability (Digital/Analog)</b>		VHF/ UHF: 2 - 69, CATV: 1 - 135	
<b>Operating Conditions</b>		Temperature: 32 °F – 104 °F (0 °C – 40 °C) Humidity: 20 % – 80 % RH (non-condensing)	
<b>Connection Terminals</b>	<b>VIDEO IN 1-2</b>	VIDEO: RCA PIN Type x 1 1.0 V [p-p] (75 Ω) AUDIO L-R: RCA PIN Type x 2 0.5 V [rms]	
	<b>COMPONENT IN 1-2</b>	Y: 1.0 V [p-p] (including synchronization) P <sub>B</sub> , P <sub>R</sub> : ±0.35 V [p-p] AUDIO L-R: RCA PIN Type x 2 0.5 V [rms]	
	<b>HDMI 1-4</b>	TYPE A Connector x 4 ● This TV supports "HDAVI Control 5" function.	
	<b>USB 1-2</b>	USB 2.0 Type A connector x 2 (DC5V MAX500mA)	
	<b>PC</b>	D-SUB 15PIN: R, G, B / 0.7 V [p-p] (75 Ω) HD, VD / 1.0 - 5.0 V [p-p] (high impedance)	
	<b>LAN (for VIERA CAST IPTV)</b>	RJ45 (10BASE-T/100BASE-TX)	
	<b>Card slot</b>	SD CARD slot x 1	
	<b>DIGITAL AUDIO OUT</b>	PCM / Dolby Digital, Fiber Optic	
	<b>FEATURES</b>		3D Y/C FILTER V-Chip VIERA IMAGE VIEWER CLOSED CAPTION IPTV (VIERA CAST) Media player HDAVI Control 5
	<b>Dimensions (W x H x D)</b>	<b>Including pedestal</b>	48.2" x 31.9" x 13.2" (1,224 mm x 810 mm x 335 mm)
<b>TV Set only</b>		48.2" x 30.4" x 3.6" (1,224 mm x 771 mm x 90 mm)	
<b>Mass</b>	<b>Including pedestal</b>	67.3 lb (30.5 kg)	
	<b>TV Set only</b>	60.7 lb (27.5 kg)	

[TC-P50VT20]

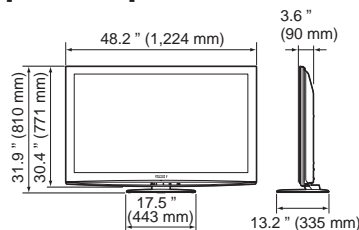

**Note**

- Design and Specifications are subject to change without notice. Mass and Dimensions shown are approximate.

# Limited Warranty (for U.S.A. and Puerto Rico only)

PANASONIC CONSUMER ELECTRONICS COMPANY,  
DIVISION OF  
PANASONIC CORPORATION OF NORTH AMERICA  
One Panasonic Way  
Secaucus, New Jersey 07094

## Panasonic Plasma Television Limited Warranty

### Limited Warranty Coverage

If your product does not work properly because of a defect in materials or workmanship, Panasonic Consumer Electronics Company (referred to as "the warrantor") will, for the length of the period indicated on the chart below, which starts with the date of original purchase ("Limited Warranty period"), at its option either (a) repair your product with new or refurbished parts, (b) replace it with a new or a refurbished equivalent value product, or (c) refund your purchase price. The decision to repair, replace or refund will be made by the warrantor.

PLASMA TV CATEGORIES	PARTS	LABOR	SERVICE
Up to 42" (diagonal)	1 (ONE) YEAR	1 (ONE) YEAR	Carry-In
46" (diagonal) and larger			On-Site
3D Eyewear		Not Applicable	Mail In

During the "Labor" Limited Warranty period there will be no charge for labor. During the "Parts" Limited Warranty period, there will be no charge for parts.

You must carry-in your product or arrange for on-site service during the Limited Warranty period. If non-rechargeable batteries are included, they are not warranted. This Limited Warranty only applies to products purchased and serviced in the United States or Puerto Rico. This Limited Warranty is extended only to the original purchaser of a new product which was not sold "as is". A purchase receipt or other proof of the original purchase date is required for Limited Warranty service.

### On-Site or Carry-In Service

For On-Site or Carry-In Service in the United States and Puerto Rico call 1-877-95-VIERA (1-877-958-4372).

On-site service where applicable requires clear, complete and easy access to the product by the authorized servicer and does not include removal or re-installation of an installed product. It is possible that certain on-site repairs will not be completed on-site, but will require that the product or parts of the product, at the servicer's discretion be removed for shop diagnosis and/or repair and then returned.

### Mail-In Service

For assistance in the U.S.A. and Puerto Rico in obtaining replacement, please ship the product prepaid to:

Panasonic Exchange Center  
4900 George McVay Drive  
Suite B  
McAllen, TX 78503

panacare@us.panasonic.com

When shipping the unit, carefully pack, include all accessories, and send it prepaid, adequately insured and preferably in the original carton. If Lithium Ion batteries are shipped by air the package must be labeled "Contains Lithium Ion Battery (No lithium metal)". Damaged batteries are prohibited from shipment by US Mail. Batteries must be securely packed in a manner to prevent short-circuiting and a package cannot contain more than 3 Lithium Ion batteries. Include a letter detailing the complaint, a return address and provide a daytime phone number where you can be reached. A valid registered receipt is required under the Limited Warranty.

### Limited Warranty Limits And Exclusions

This Limited Warranty ONLY COVERS failures due to defects in materials or workmanship, and DOES NOT COVER normal wear and tear or cosmetic damage, nor does it cover markings or retained images on the glass panel resulting from viewing fixed images (including, among other things, non-expanded standard 4:3 pictures on wide screen TVs, or onscreen data in a stationary and fixed location). The Limited Warranty ALSO DOES NOT COVER damages which occurred in shipment, or failures which are caused by products not supplied by the warrantor, or failures which result from accidents, misuse, abuse, neglect, bug infestation, mishandling, misapplication, alteration, faulty installation, set-up adjustments, misadjustment of consumer controls, improper maintenance, power line surge, lightning damage, modification, or commercial use (such as in a hotel, office, restaurant, or other business), rental use of the product, service by anyone other than a Factory Service Center or other Authorized Servicer, or damage that is attributable to acts of God.

**THERE ARE NO EXPRESS WARRANTIES EXCEPT AS LISTED UNDER "LIMITED WARRANTY COVERAGE". THE WARRANTOR IS NOT LIABLE FOR INCIDENTAL OR CONSEQUENTIAL DAMAGES RESULTING FROM THE USE OF THIS PRODUCT, OR ARISING OUT OF ANY BREACH OF THIS LIMITED WARRANTY.** (As examples, this excludes damages for lost time, cost of having someone remove or re-install an installed unit if applicable, or travel to and from the servicer. The items listed are not exclusive, but are for illustration only.) **ALL EXPRESS AND IMPLIED WARRANTIES, INCLUDING THE LIMITED WARRANTY OF MERCHANTABILITY, ARE LIMITED TO THE PERIOD OF THE LIMITED WARRANTY.**

Some states do not allow the exclusion or limitation of incidental or consequential damages, or limitations on how long an implied Limited Warranty lasts, so the exclusions may not apply to you.

This Limited Warranty gives you specific legal rights and you may also have others rights which vary from state to state. If a problem with this product develops during or after the Limited Warranty period, you may contact your dealer or Service Center. If the problem is not handled to your satisfaction, then write to the warrantor's Consumer Affairs Department at the addresses listed for the warrantor.

**PARTS AND SERVICE (INCLUDING COST OF AN ON-SITE SERVICE CALL, WHERE APPLICABLE) WHICH ARE NOT COVERED BY THIS LIMITED WARRANTY ARE YOUR RESPONSIBILITY.**

# Customer Services Directory (for U.S.A. and Puerto Rico)

## Customer Services Directory (United States and Puerto Rico)

Obtain Product Information and Operating Assistance; locate your nearest Dealer or Service Center; purchase Parts and Accessories; or make Customer Service and Literature requests by visiting our Web Site at:

<http://www.panasonic.com/help>

or, contact us via the web at:

<http://www.panasonic.com/contactinfo>

You may also contact us directly at:

1-877-95-VIERA (958-4372)

Monday-Friday 9 am-9 pm; Saturday-Sunday 10 am-7 pm, EST.

■ For hearing or speech impaired TTY users, TTY: 1-877-833-8855

## Accessory Purchases (United States and Puerto Rico)

Purchase Parts, Accessories and Instruction Books on line for all Panasonic Products by visiting our Web Site at:

<http://www.pstc.panasonic.com>

or, send your request by E-mail to:

[npcparts@us.panasonic.com](mailto:npcparts@us.panasonic.com)

You may also contact us directly at:

1-800-332-5368 (Phone) 1-800-237-9080 (Fax Only) (Monday - Friday 9 am to 9 pm, EST.)

Panasonic Service and Technology Company

20421 84th Avenue South,

Kent, WA 98032

(We Accept Visa, MasterCard, Discover Card, American Express, and Personal Checks)

■ For hearing or speech impaired TTY users, TTY: 1-866-605-1277

# Limited Warranty (for Canada)

**Panasonic Canada Inc.**  
5770 Ambler Drive, Mississauga, Ontario L4W 2T3  
**PANASONIC PRODUCT – LIMITED WARRANTY**

Panasonic Canada Inc. warrants this product to be free from defects in material and workmanship under normal use and for a period as stated below from the date of original purchase agrees to, at its option either (a) repair your product with new or refurbished parts, (b) replace it with a new or a refurbished equivalent value product, or (c) refund your purchase price. The decision to repair, replace or refund will be made by Panasonic Canada Inc.

<b>Viera TV (42" &amp; over)</b>	<b>In-home service</b>	<b>One (1) year, parts (including panel) and labour.</b>
<b>Viera TV (under 42")</b>	<b>Carry-in service</b>	<b>One (1) year, parts (including panel) and labour.</b>

In-home Service will be carried out only to locations accessible by roads and within 50 km of an authorized Panasonic service facility.

In-home service requires clear, complete and easy access to the product by the Authorized Servicer and does not include removal or re-installation of an installed product. If removal is required to service the product, it will be at the discretion of the Servicer and in no event will Panasonic Canada Inc. or the Servicer be liable for any special, indirect or consequential damages.

This warranty is given only to the original purchaser, or the person for whom it was purchased as a gift, of a Panasonic brand product mentioned above sold by an authorized Panasonic dealer in Canada and purchased and used in Canada, which product was not sold "as is", and which product was delivered to you in new condition in the original packaging.

**IN ORDER TO BE ELIGIBLE TO RECEIVE WARRANTY SERVICE HEREUNDER, A PURCHASE RECEIPT OR OTHER PROOF OF DATE OF ORIGINAL PURCHASE, SHOWING AMOUNT PAID AND PLACE OF PURCHASE IS REQUIRED**

## **LIMITATIONS AND EXCLUSIONS**

This warranty ONLY COVERS failures due to defects in materials or workmanship, and DOES NOT COVER normal wear and tear or cosmetic damage. The warranty ALSO DOES NOT COVER damages which occurred in shipment, or failures which are caused by products not supplied by Panasonic Canada Inc., or failures which result from accidents, misuse, abuse, neglect, mishandling, misapplication, alteration, faulty installation, set-up adjustments, misadjustment of consumer controls, improper maintenance, power line surge, lightning damage, modification, introduction of sand, humidity or liquids, commercial use such as hotel, office, restaurant, or other business or rental use of the product, or service by anyone other than a Authorized Servicer, or damage that is attributable to acts of God. Dry cell batteries are also excluded from coverage under this warranty.

THIS EXPRESS, LIMITED WARRANTY IS IN LIEU OF ALL OTHER WARRANTIES, EXPRESS OR IMPLIED, INCLUDING ANY IMPLIED WARRANTIES OF MERCHANTABILITY AND FITNESS FOR A PARTICULAR PURPOSE. IN NO EVENT WILL PANASONIC CANADA INC. BE LIABLE FOR ANY SPECIAL, INDIRECT OR CONSEQUENTIAL DAMAGES RESULTING FROM THE USE OF THIS PRODUCT OR ARISING OUT OF ANY BREACH OF ANY EXPRESS OR IMPLIED WARRANTY. (As examples, this warranty excludes damages for lost time, travel to and from the Authorized Servicer, loss of or damage to media or images, data or other memory or recorded content. This list of items is not exhaustive, but for illustration only.)

In certain instances, some jurisdictions do not allow the exclusion or limitation of incidental or consequential damages, or the exclusion of implied warranties, so the above limitations and exclusions may not be applicable. This warranty gives you specific legal rights and you may have other rights which vary depending on your province or territory.

## **WARRANTY SERVICE**

**For product operation and information assistance**, please contact:

Our Customer Care Centre:      1-800 #:                      1-866-330-0014  
Email link: "Contact us → email" on [www.vieraconcierge.ca](http://www.vieraconcierge.ca)

**For product repairs**, please contact Viera Customer Care Agent using the above contact info.

## **IF YOU SHIP THE PRODUCT TO A SERVICENTRE**

Carefully pack and send prepaid, adequately insured and preferably in the original carton.  
Include details of the defect claimed, and proof of date of original purchase.

A series of horizontal dashed lines for taking notes, spanning the width of the page.

**Customer's Record**

The model number and serial number of this product can be found on its back cover. You should note this serial number in the space provided below and retain this book, plus your purchase receipt, as a permanent record of your purchase to aid in identification in the event of theft or loss, and for Warranty Service purposes.

Model Number \_\_\_\_\_

Serial Number \_\_\_\_\_

**Anotación del cliente**

El modelo y el número de serie de este producto se encuentran en su panel posterior. Deberá anotarlos en el espacio provisto a continuación y guardar este manual, más el recibo de su compra, como prueba permanente de su adquisición, para que le sirva de ayuda al identificarlo en el caso de que le sea sustraído o lo pierda, y también para disponer de los servicios que le ofrece la garantía.

Modelo \_\_\_\_\_

Número de serie \_\_\_\_\_

**Panasonic Consumer Electronics Company,**  
**Division of Panasonic Corporation of North America**  
One Panasonic Way, Secaucus  
New Jersey 07094 U.S.A.

**Panasonic Canada Inc.**  
5770 Ambler Drive  
Mississauga, Ontario  
L4W 2T3 CANADA