

# VIZIO



## USER MANUAL

Models: M601 d-A3, M701 d-A3, & M801 d-A3



This product qualifies for ENERGY STAR in the "factory default" setting and this is the setting in which power savings will be achieved. Changing the factory default picture settings or enabling other features will increase power consumption that could exceed the limits necessary to qualify for ENERGY STAR rating.



For DTS patents, see <http://patents.dts.com>.  
Manufactured under license from DTS Licensing Limited. DTS, the Symbol, & DTS and the Symbol together are registered trademarks, and DTS Studio Sound and DTS TruVolume are trademarks of DTS, Inc. © DTS, Inc. All Rights Reserved.

Manufactured under license from Dolby Laboratories. Dolby and the double-D symbol are trademarks of Dolby Laboratories.

HDMI, the HDMI logo and High-Definition Multimedia Interface are trademarks or registered trademarks of HDMI Licensing LLC.

# Welcome

## THANK YOU FOR CHOOSING VIZIO

And congratulations on your new VIZIO HDTV.

To get the most out of your new VIZIO product, read these instructions before using your product and retain them for future reference. Be sure to inspect the package contents to ensure there are no missing or damaged parts.

## PRODUCT REGISTRATION

To purchase or inquire about accessories and installation services for your VIZIO product, visit our website at [www.VIZIO.com](http://www.VIZIO.com) or call toll free at (877) 878-4946.

We recommend that you either:

- Register your VIZIO product at [www.VIZIO.com](http://www.VIZIO.com)
- Complete and mail the enclosed registration card

## Extended Warranties

For peace of mind, and to protect your investment beyond the standard warranty, VIZIO offers on-site extended warranty service plans. These plans provide additional coverage during the standard warranty period. To purchase an extended warranty service plan, visit [www.VIZIO.com](http://www.VIZIO.com).

## WHEN READING THIS MANUAL



When you see this symbol, please read the accompanying important warning or notice. It is intended to alert you to the presence of important operating instructions.



When you see this symbol, please read the accompanying helpful tip.

## IMPORTANT SAFETY INSTRUCTIONS

Your TV is designed and manufactured to operate within defined design limits. Misuse may result in electric shock or fire. To prevent your TV from being damaged, the following instructions should be observed for the installation, use, and maintenance of your TV. Read the following safety instructions before operating your TV. Keep these instructions in a safe place for future reference.

- To reduce the risk of electric shock or component damage, switch off the power before connecting other components to your TV.
- Read these instructions.
- Keep these instructions.
- Heed all warnings.
- Follow all instructions.
- Do not use this apparatus near water.
- Clean only with a dry cloth.
- Do not block any ventilation openings. Install in accordance with the manufacturer's instructions.
- Do not install near any heat sources such as radiators, heat registers, stoves, or other apparatus (including amplifiers) that produce heat.
- Do not defeat the safety purpose of the polarized or grounding-type plug. A polarized plug has two blades and a third grounding prong. The wide blade or the third prong are provided for your safety. If the provided plug does not fit into your outlet, consult an electrician for replacement of the obsolete outlet.
- Protect the power cord from being walked on or pinched, particularly at plugs, convenience receptacles, and the point where they exit from the apparatus.
- Only use attachments/accessories specified by the manufacturer.

- Use only with the cart, stand, tripod, bracket, or table specified by the manufacturer, or sold with the apparatus. When a cart is used, use caution when moving the cart/apparatus combination to avoid injury from tip-over.
- Unplug this apparatus during lightning storms or when unused for long periods of time.
- Refer all servicing to qualified service personnel. Servicing is required when the apparatus has been damaged in any way, such as when the power-supply cord or plug is damaged, liquid has been spilled or objects have fallen into the apparatus, the apparatus has been exposed to rain or moisture, does not operate normally or has been dropped.
- Unplug the power cord before cleaning your TV.
- When moving your TV from an area of low temperature to an area of high temperature, condensation may form in the housing. Wait before turning on your TV to avoid causing fire, electric shock, or component damage.
- A distance of at least three feet should be maintained between your TV and any heat source, such as a radiator, heater, oven, amplifier etc. Do not install your TV close to smoke. Operating your TV close to smoke or moisture may cause fire or electric shock.
- Slots and openings in the back and bottom of the cabinet are provided for ventilation. To ensure reliable operation of your TV and to protect it from overheating, be sure these openings are not blocked or covered. Do not place your TV in a bookcase or cabinet unless proper ventilation is provided.
- Never push any object into the slots and openings on your TV cabinet. Do not place any objects on the top of your TV. Doing so could short circuit parts causing a fire or electric shock. Never spill liquids on your TV.
- Your TV should be operated only from the type of power source indicated on the label. If you are not sure of the type of power supplied to your home, consult your dealer



- or local power company.
- Do not apply pressure or throw objects at your TV. This may compromise the integrity of the display. The manufacturer's warranty does not cover user abuse or improper installations.
- The power cord must be replaced when using different voltage than the voltage specified. For more information, contact your dealer.
- Your TV is equipped with a three-pronged grounded plug (a plug with a third grounding pin). This plug will fit only into a grounded power outlet. This is a safety feature. If your outlet does not accommodate the three-pronged, have an electrician install the correct outlet, or use an adapter to ground your TV safely. Do not defeat the safety purpose of the grounded plug.
- When connected to a power outlet, power is always flowing into your TV. To totally disconnect power, unplug the power cord.
- The lightning flash with arrowhead symbol within an equilateral triangle is intended to alert the user to the presence of un-isolated, dangerous voltage within the inside of your TV that may be of sufficient magnitude to constitute a risk of electric shock to persons.
- Do not overload power strips and extension cords. Overloading can result in fire or electric shock.
- The wall socket should be installed near your TV and easily accessible.
- Only power of the marked voltage can be used for your TV. Any other voltage than the specified voltage may cause fire or electric shock.
- Do not touch the power cord during lightning. To avoid electric shock, avoid handling the power cord during electrical storms.
- Unplug your TV during a lightning storm or when it will not be used for long period of time. This will protect your TV from damage due to power surges.

- Do not attempt to repair or service your TV yourself. Opening or removing the back cover may expose you to high voltages, electric shock, and other hazards. If repair is required, contact your dealer and refer all servicing to qualified service personnel.
- **WARNING:** Keep your TV away from moisture. Do not expose your TV to rain or moisture. If water penetrates into your TV, unplug the power cord and contact your dealer. Continuous use in this case may result in fire or electric shock.
- Do not use your TV if any abnormality occurs. If any smoke or odor becomes apparent, unplug the power cord and contact your dealer immediately. Do not try to repair your TV yourself.
- Avoid using dropped or damaged appliances. If your TV is dropped and the housing is damaged, the internal components may function abnormally. Unplug the power cord immediately and contact your dealer for repair. Continued use of your TV may cause fire or electric shock.
- Do not install your TV in an area with heavy dust or high humidity. Operating your TV in environments with heavy dust or high humidity may cause fire or electric shock.
- Follow instructions for moving your TV. Ensure that the power cord and any other cables are unplugged before moving your TV.
- When unplugging your TV, hold the AC/DC power adapter, not the cord. Pulling on the power cord may damage the wires inside the cord and cause fire or electric shock. When your TV will not be used for an extended period of time, unplug the power cord.
- To reduce risk of electric shock, do not touch the connector with wet hands.
- Insert batteries in accordance with instructions. Incorrect polarities may cause the batteries to leak which can damage the remote control or injure the operator. Do not expose batteries to excessive heat such as sunshine, fire

or the like.

- If any of the following occurs, contact the dealer:
  - The power cord fails or frays.
  - Liquid sprays or any object drops into your TV.
  - Your TV is exposed to rain or other moisture.
  - Your TV is dropped or damaged in any way.
  - The performance of your TV changes substantially.
- This apparatus shall not be exposed to dripping or splashing and no objects fill with liquids, such as vases, shall be placed on the apparatus.
- The mains plug or appliance coupler is used as the disconnect device, the disconnect device shall remain readily operable.
- **CAUTION** - These servicing instructions are for use by qualified service personnel only. To reduce the risk of electric shock, do not perform any servicing other than that contained in the operating instructions unless you are qualified to do so.



The lightning flash with arrowhead symbol within an equilateral triangle is intended to alert the user to the presence of uninsulated **DANGEROUS VOLTAGE** within the product's enclosure that may be of sufficient magnitude to constitute a risk of electrical shock to persons.

## IMPORTANT SAFETY INFORMATION FOR VIEWING 3D CONTENT



You may experience discomfort while watching 3D content. You may feel symptoms of eye strain, vision fatigue, color or depth distortion, motion sickness, nausea, dizziness, disorientation, or other discomforts. If you experience any of these symptoms, stop watching and take a break for at least thirty minutes before resuming. If the symptoms are severe or continue even after you have stopped watching 3D content, consult a doctor.



Take care to monitor children's watching of 3D content. Children (including teenagers) may be more at risk of experiencing discomfort while watching 3D content and less likely to report symptoms. Monitor children's 3D content viewing and watch for signs of discomfort.



Some viewers may be susceptible to epileptic seizures or strokes when viewing 3D images, even if those conditions have not been previously diagnosed. If you or anyone in your family has a history of seizures or strokes, or if you have any other reason to think you or someone under your supervision may be susceptible to epileptic seizures or strokes, consult a doctor before watching 3D content.



Even if you do not experience any of the above symptoms, take regular breaks from watching 3D content.

## TELEVISION ANTENNA CONNECTION PROTECTION

If an outside antenna/satellite dish or cable system is to be connected to the TV, make sure that the antenna or cable system is electrically grounded to provide some protection against voltage surges and static charges.

Article 810 of the National Electrical Code, ANSI/NFPA 70, provides information with regard to proper grounding of the mast and supporting structure, grounding of the lead-in wire to an antenna discharge unit, size of the grounding conductors, location of antenna discharge unit, connection to grounding electrodes, and requirements of the grounding electrode.

### Lightning Protection

For added protection of the TV during a lightning storm or when it is left unattended or unused for long periods of time, unplug the TV from the wall outlet and disconnect the antenna or cable system.

### Power Lines

Do not locate the antenna near overhead light or power circuits, or where it could fall into such power lines or circuits. Remember, the screen of the coaxial cable is intended to be connected to earth in the building installation.

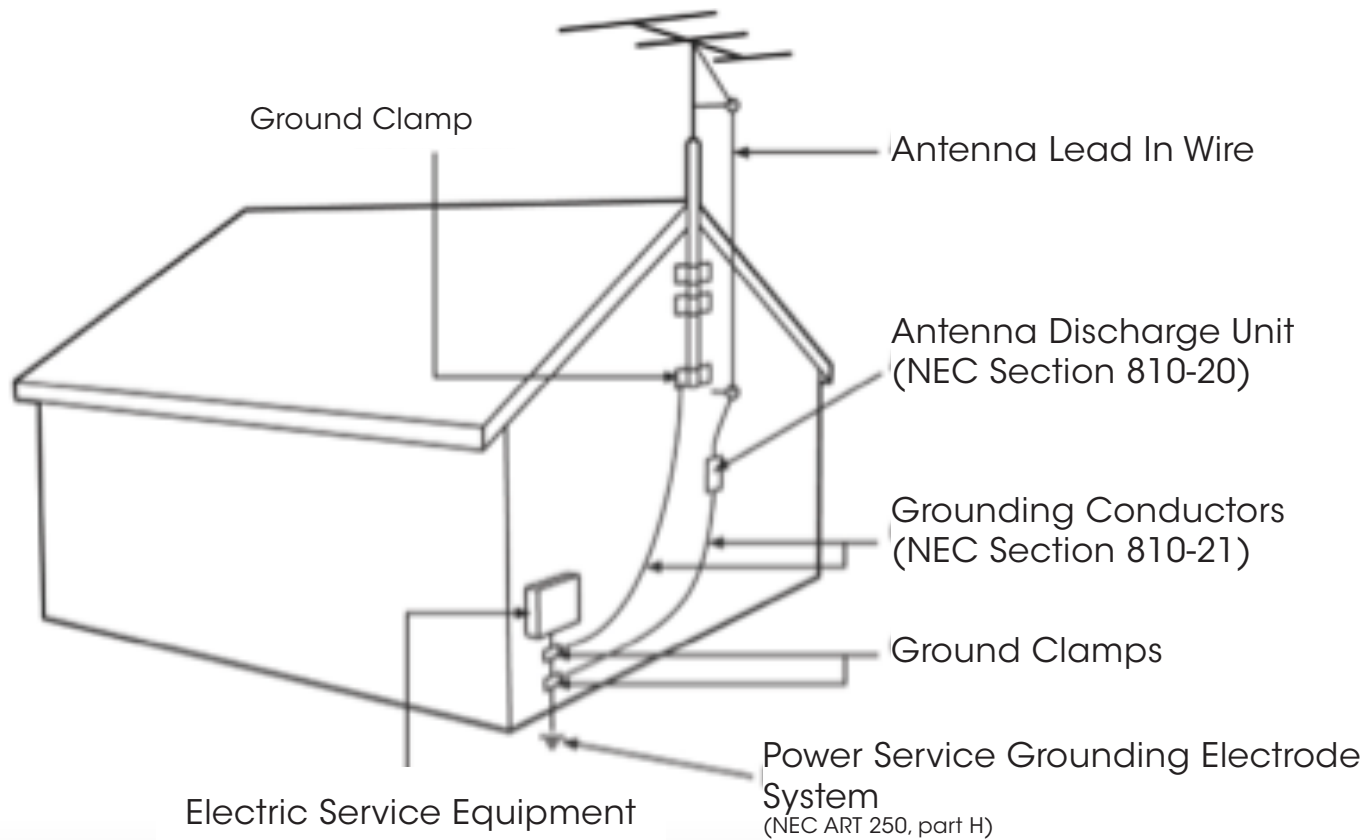

# Table of Contents

Installing the TV .....	3	Adjusting the Picture Size and Position .....	20
Inspecting the Package Contents .....	3	Adjusting the Color Temperature .....	20
Installing the TV.....	3	Adjusting the Advanced Picture Settings.....	21
Installing the TV Stand .....	3	Resetting the Picture Settings .....	21
Installing the TV on a Wall.....	5	Adjusting the Audio Settings.....	22
Controls and Connections .....	6	Resetting the Audio Settings.....	23
Front Panel.....	7	Activating the Sleep Timer.....	23
Remote Control .....	8	Setting the Auto Power Off Feature.....	24
Replacing the Batteries .....	9	Using the Network Connection Menu.....	24
Connecting Your Devices.....	10	Connecting to a Wireless Network .....	24
Connecting A Device .....	10	Changing the Manual Setup Settings.....	25
Connecting a Device - Audio and Video Cable Types.....	11	Connecting to a Hidden Network .....	25
Connecting an Audio Device .....	12	Testing Your Network Connection.....	26
Connecting an Audio Device - Audio Cable Types .....	13	Using the Tuner Menu .....	26
Connecting an Audio Device - ARC.....	14	Selecting a Tuner Input .....	27
Without HDMI ARC.....	14	Scanning for Channels.....	27
With HDMI ARC .....	14	Adding New Channels .....	27
Connecting to your Network.....	15	Skipping Channels.....	28
Connecting to a Wired Network (Best) .....	15	Changing the Audio Language.....	29
Connecting to a Wireless Network .....	15	Setting Up Closed Captioning .....	30
Connecting to a Wireless Network .....	15	Changing the Appearance of Digital Closed Captions ..	30
Completing the First-Time Setup.....	16	Changing the TV Settings.....	31
Using the On-Screen Menu .....	17	Displaying System Information .....	31
Navigating the On-Screen Menu .....	17	Changing the Names of the Inputs .....	32
Changing the 3D Mode .....	17	Using the Parental Controls .....	32
Changing the Input Source .....	18	Accessing the Parental Controls Menu .....	32
Changing the Screen Aspect Ratio .....	18	Enabling or Disabling Program Ratings.....	33
Adjusting the Picture Settings .....	19	Locking and Unlocking Channels .....	33
		Blocking and Unblocking Content by Rating.....	33



Changing the Parental Control Passcode .....	34
Resetting the Content Locks .....	34
Changing the On-Screen Menu Language .....	34
Setting the Time Zone .....	35
Adjusting the CEC Settings.....	35
Turning the Power Indicator On or Off .....	36
Using the Reset & Admin Menu.....	36
Resetting the TV Settings.....	37
Restoring the TV to Factory Default Settings .....	37
Performing a Service Check .....	37
Using the Guided Setup Menu.....	38
Using Guided Setup.....	38
Using the Info Window .....	39
<b>Using the USB Media Player .....</b>	<b>40</b>
Using the USB Media Player.....	40
Connecting a USB Thumb Drive to the TV .....	40
Playing USB Media .....	40
<b>Using VIZIO Internet Apps.....</b>	<b>44</b>
Using the VIA Dock .....	44
Using the Hot Keys.....	44
<b>How to View 3D.....</b>	<b>45</b>
How Theater 3D Works .....	45
What You Need to View 3D Content.....	45
Watching Blu-ray 3D Content .....	45
Getting the Best 3D Picture .....	46
Incorrect 3D Viewing Distance and Angle .....	46
<b>Troubleshooting &amp; Technical Support.....</b>	<b>47</b>

Specifications .....	50
Limited Warranty.....	52
Legal & Compliance .....	53

## INSPECTING THE PACKAGE CONTENTS

Before installing your new TV, take a moment to inspect the package contents. Use the images below to ensure nothing is missing or damaged.



VIZIO LED HDTV with Stand



Remote Control with Batteries



Quick Start Guide



Theater 3D Glasses



Power Cord



5 x 28mm M6  
Phillips Screws  
(M801d)



4 x 23mm M5  
Phillips Screws  
(M601d/M701d)

### PACKAGE CONTENTS

## INSTALLING THE TV

After removing the TV from the box and inspecting the package contents you can begin installing the TV. Your TV can be installed in two ways:

- On a flat surface, using the included stand
- On a wall, using a VESA-standard wall mount (not included)

### Installing the TV Stand

Your TV includes a stand designed to support the weight of the TV and keep it from falling over. However, the TV can still fall over if:

- It is placed on an uneven, unstable, or non-level surface
- It is pushed, pulled, or otherwise improperly moved
- If an earthquake occurs and the TV is not properly secured



### TV ON STAND

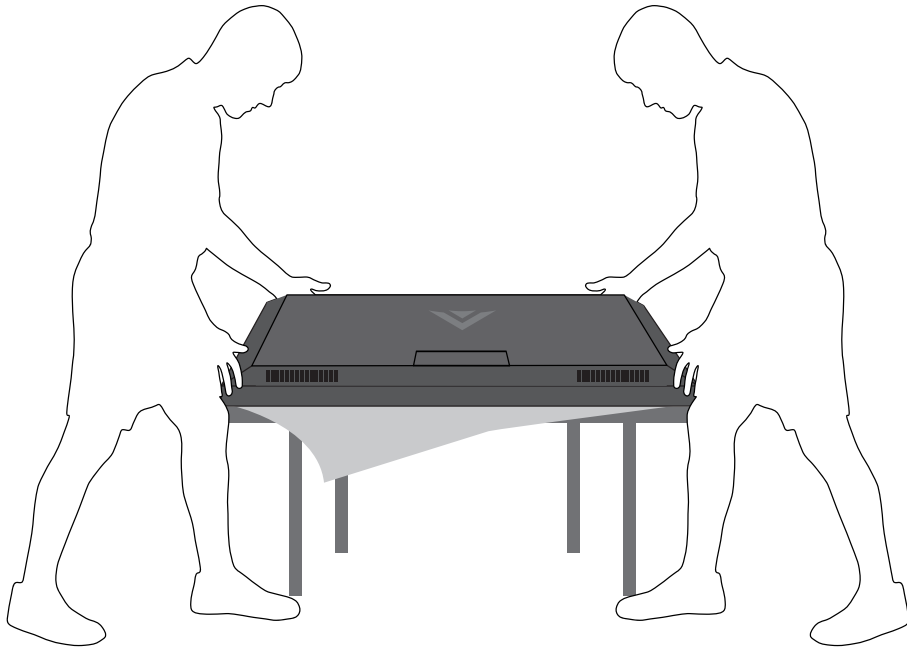

To install the base:

1. It is recommended that two people take part in the base installation.

Remove any plastic wrapping from the TV and stand.

Place the TV screen-down on a clean, flat surface. To prevent scratches or damage to the screen, place the TV on a soft surface, such as carpet, rug, or blanket.

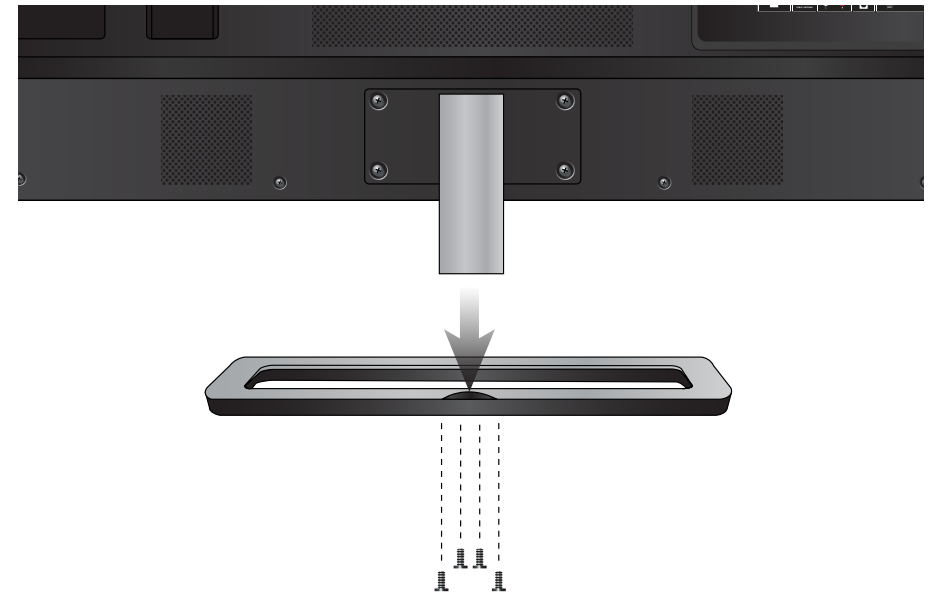

**M601d/M701d-A3**

2. Align and slide the neck into the TV base. Insert and tighten four(4) [M601d/M701d-A3] or five (5) [M801d-A3] Phillips screws into the bottom of the TV as shown.

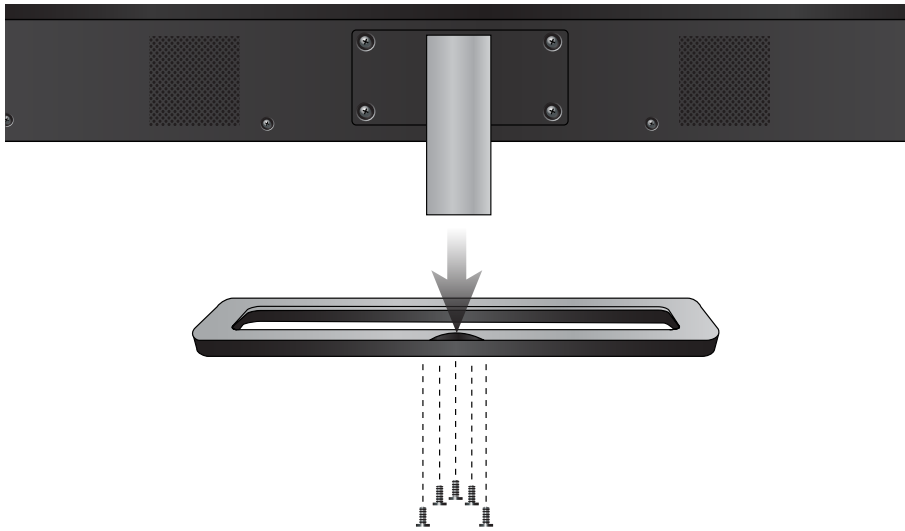

**M801d-A3**

3. When you are finished, place the TV on a stable, level surface

**Installing the TV on a Wall**

To mount your TV on a wall, you will need a wall mount. Consult the information below to find the appropriate mount for your TV model:

 Installing a TV on a wall requires lifting. To prevent injury or damage to the TV, ask someone to help you.

<b>M601d-A3, M701d-A3, &amp; M801d-A3</b>	
Screw Size:	M6
Screw Length:	10mm
Hole Pattern:	400mm (V) x 400mm (H)

Be sure the mount you choose is capable of supporting the weight of the TV. After you have determined that you have the correct mount for your TV, you can begin the installation.

To install your TV on a wall:

1. Disconnect any cables connected to your TV.
2. Place the TV face-down on a clean, flat, stable surface. Be sure the surface is clear of debris that can scratch or damage the TV.
3. Remove the base and the neck by loosening and removing the screws.
4. Attach your TV and wall mount to the wall, carefully following the instructions that came with your mount.

Use only with a UL-listed wall mount bracket rated for the weight/load of this TV. See *Appendix B - Specifications* for the weight of this TV.

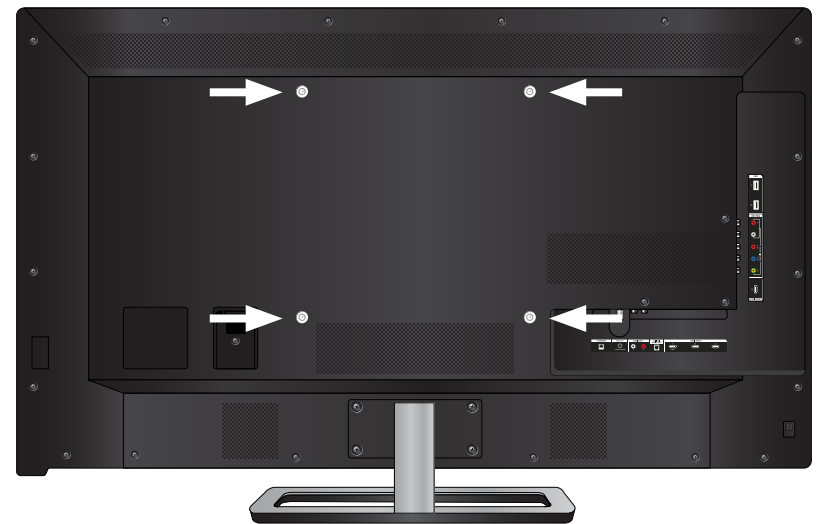

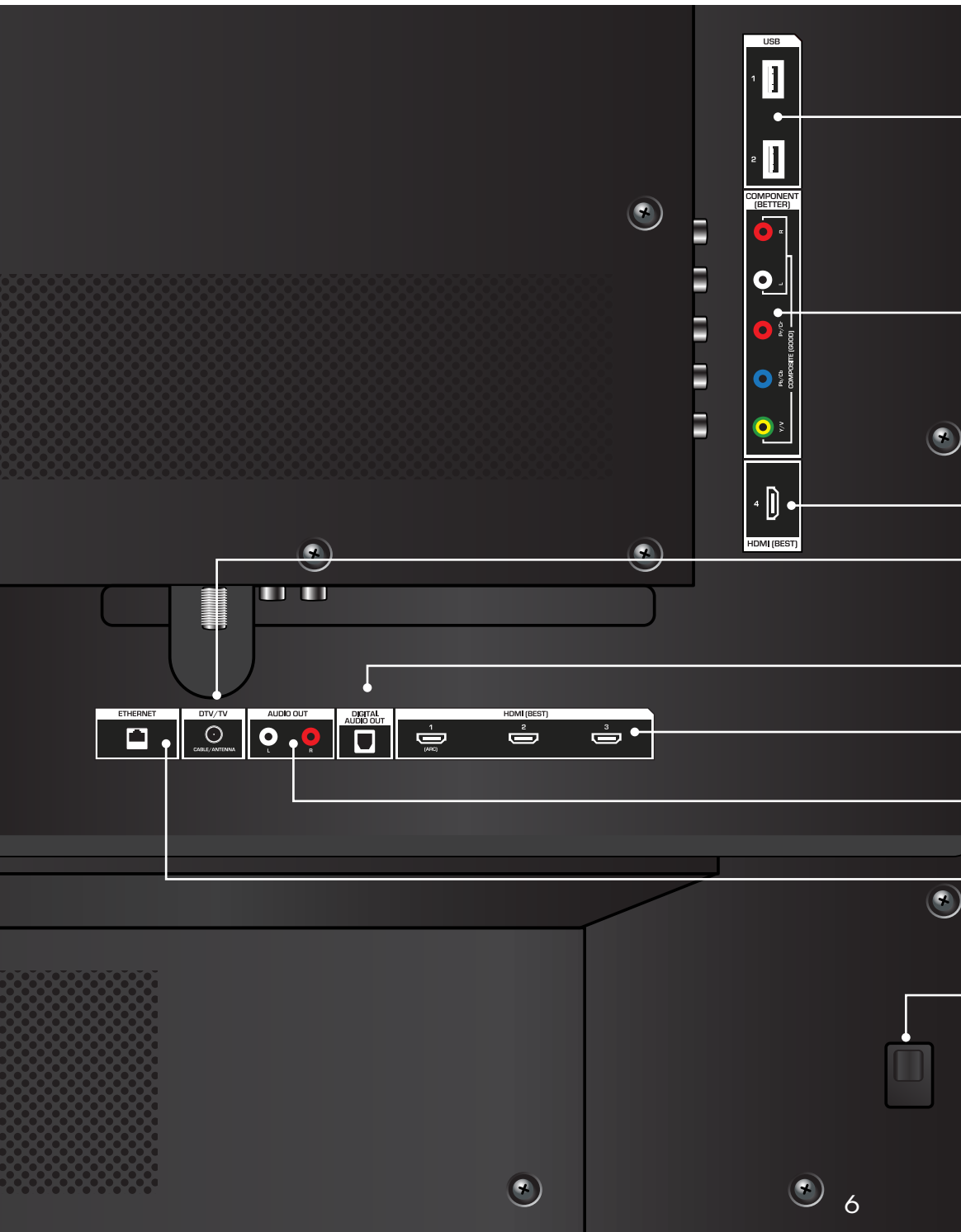

**USB** - Connect USB thumb drive to play photo, music, or video.

**Component/Composite** - Connect component or composite device.

**HDMI** - Connect HDMI device.

**Coaxial** - Connect coaxial cable from cable, satellite, or antenna.

**Optical Audio Out** - Connect optical/SPDIF audio device, such as home audio receiver.

**HDMI** - Connect HDMI device.

**Stereo Audio Out** - Connect RCA audio device, such as sound bar.

**Ethernet** - Connect Ethernet cable from home network.

**Power/Input** - Press once to access the input menu. Press and hold to turn off the TV.

REAR PANEL



**REMOTE SENSOR & POWER INDICATOR**

When using the remote, aim it directly at this sensor.

FRONT PANEL

# REMOTE CONTROL

**APP LAUNCHER**  
Quickly launch the pictured app.

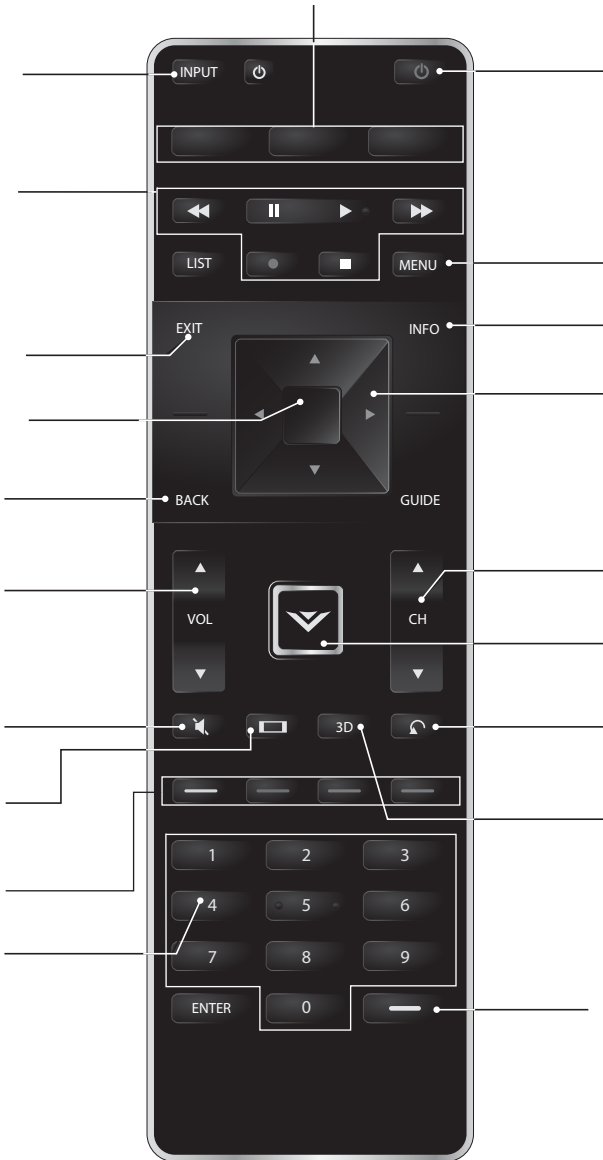

**INPUT**  
Change the currently displayed input.

**A/V CONTROLS**  
Control USB media player.

**EXIT**  
Close the on-screen menu.

**OK**  
Select the highlighted option.

**BACK**  
Go to the previous on-screen menu.

**VOLUME UP/DOWN**  
Increase or decrease loudness of the audio.

**MUTE**  
Turn the audio off or on.

**WIDE**  
Change the display mode. menu or app.

**HOT KEYS**  
Perform functions within an app.

**NUMBER PAD**  
Manually enter a channel.

**POWER**  
Turn TV on or off.

**MENU**  
Display the on-screen menu.

**INFO**  
Display the info window.

**ARROW**  
Navigate the on-screen menu.

**GUIDE**  
Display the info window.

**CHANNEL UP/DOWN**  
Change the channel.

**V BUTTON**  
Open the VIZIO Internet Apps Plus™ (V.I.A. Plus) dock.

**LAST**  
Return to the channel last viewed.

**3D**  
Turn on 3D mode.

**DASH**  
Use with number pad to manually enter a digital sub-channel. (For example, 18-4 or 18-5.)

**REMOTE CONTROL**

## Replacing the Batteries

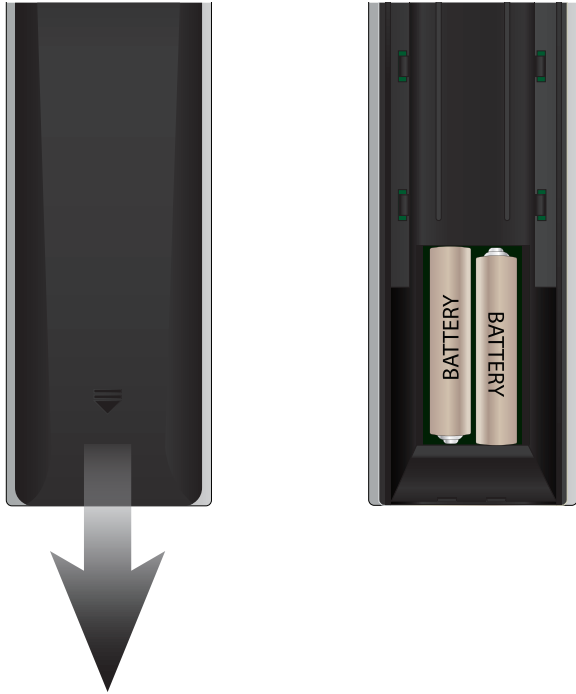

1. Remove the battery cover.
2. Insert two batteries into the remote control. Make sure that the (+) and (-) symbols on the batteries match the (+) and (-) symbols inside the battery compartment.
3. Replace the battery cover.



## CONNECTING A DEVICE

Your TV can be used to display output from most devices.

1. Verify that your device has a video port that matches an available port on the TV (HDMI, Component, etc).
2. Turn the TV and your device off.
3. Connect the appropriate cable (not included) to the TV and the device.
4. Turn the TV and your device on. Set the TV's input to match the connection you used (HDMI-1, HDMI-2, etc).



Cable/Satellite Box



DVD/Blu-ray Player



Game Console

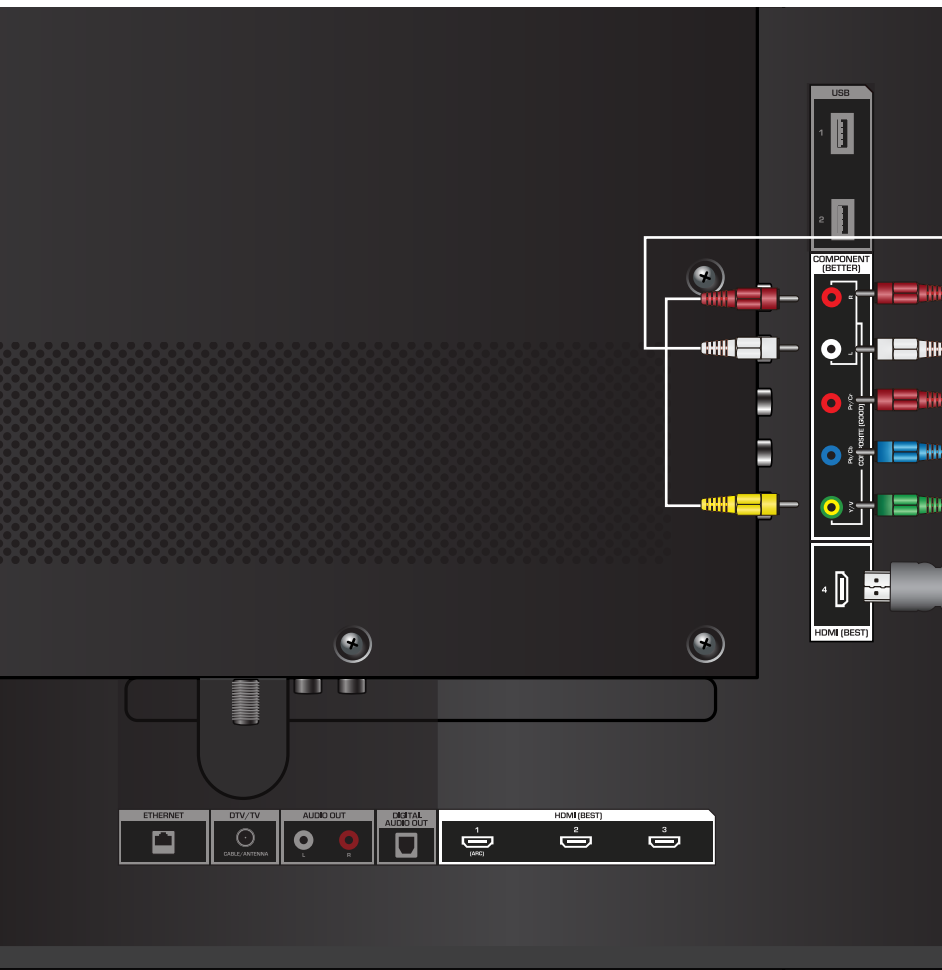

AV CABLE  
**GOOD**

- ANALOG
- VIDEO (480i)\*
- STEREO AUDIO

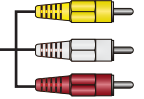

COMPONENT CABLE  
**BETTER**

- ANALOG
- HD VIDEO (1080i)\*
- STEREO AUDIO

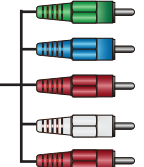

HDMI CABLE  
**BEST**

- DIGITAL
- HD VIDEO (1080p)\*
- HD AUDIO



# CONNECTING A DEVICE - AUDIO AND VIDEO CABLE TYPES

## AV CABLE

AV cables (or Composite cables) are the traditional way of connecting your devices to your TV. Video signals are sent over the yellow connector while audio is sent over the red and white connectors.

- Video Resolutions up to 480i
- Analog Connection
- Audio and Video Signals

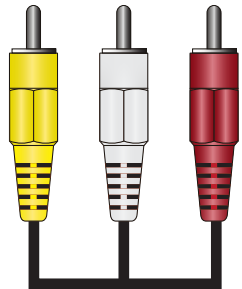

**GOOD**

## COMPONENT CABLE

Component cables are designed to carry high definition video signals along with additional audio connections. Colors are delivered with color information split up three different ways over three connectors for video (separated into Red, Blue and Green signals) and the left and right audio connectors (Red and White).

- HD Video Resolutions up to 1080i
- Analog Connection
- Audio and Video Signals

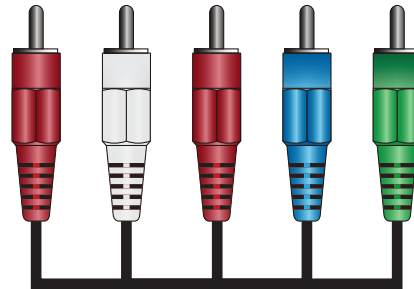

**BETTER**

## HDMI CABLE

HDMI is the intelligent, all-digital interface that delivers both dazzling quality and unmatched ease of use. HDMI technology transmits crystal-clear digital video along with multi-channel surround audio. HDMI-connected devices have the ability to automatically adjust themselves for optimal viewing.

- HD Video Resolutions up to 1080p
- HD Audio
- Digital Connection
- Audio and Video Signals



**BEST**

## CONNECTING AN AUDIO DEVICE

Your TV can output sound to an audio device, such as a receiver or sound bar.

1. Verify that your device has an audio port that matches an available port on the TV (Optical, RCA, etc).
2. Turn the TV and your audio device off.
3. Connect the appropriate cable (not included) to the TV and the device.
4. Turn the TV and your device on.

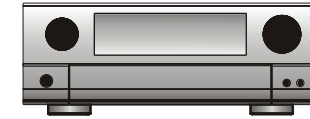

Home Audio Receiver



VIZIO Sound Bar

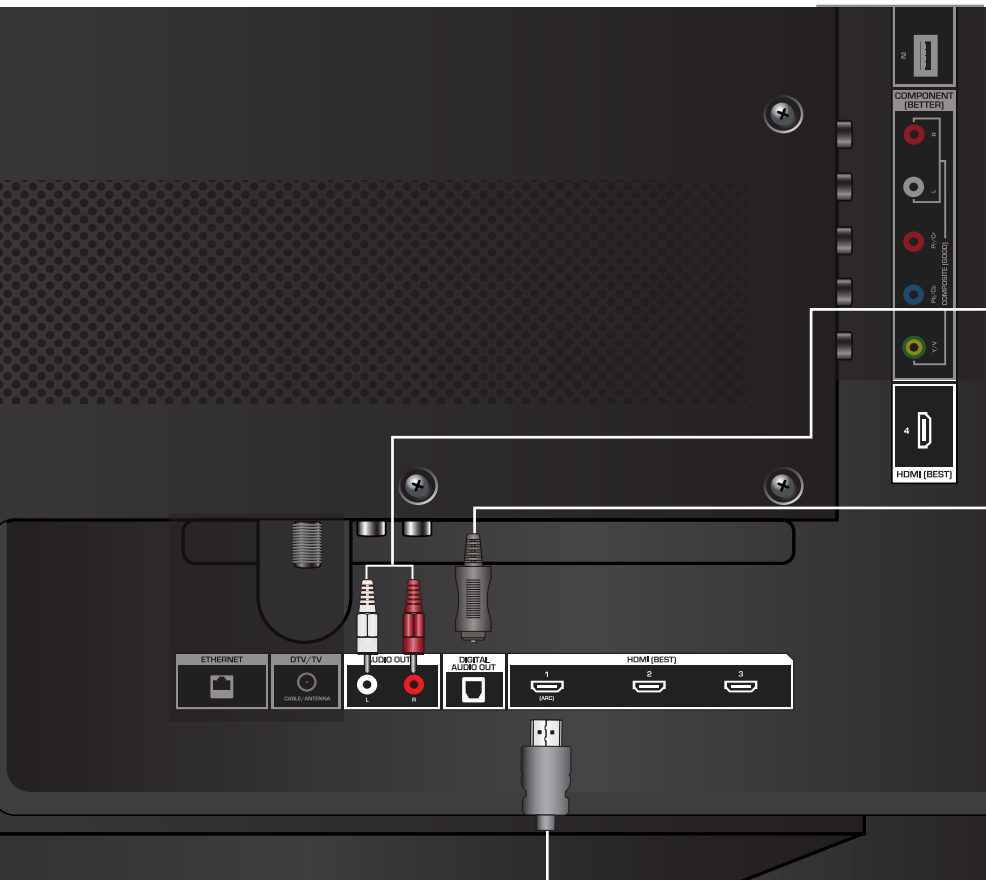

RCA CABLE  
**GOOD**

- ANALOG STEREO CONNECTION
- 2.0 CHANNEL

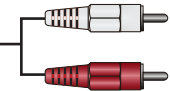

OPTICAL/SPDIF CABLE  
**BETTER**

- PCM STREAM
- DOLBY DIGITAL 5.1 CHANNEL
- DTS 5.1 CHANNEL



HDMI CABLE  
**BEST**

- ARC 2-WAY COMMUNICATION
- 2.0-5.1 DIGITAL AUDIO
- PCM, DTS, DOLBY DIGITAL



# CONNECTING AN AUDIO DEVICE - AUDIO CABLE TYPES

## RCA CABLE

Audio cables are the traditional way of connecting your devices to your audio device. Audio signals are sent over the red and white connectors.

- **Quality Stereo Connection**
- **2.0 Channel**
- **Analog Connection**
- **Audio Signal Only**

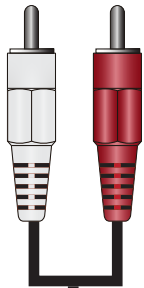

**GOOD**

## OPTICAL/SPDIF CABLE

Optical/SPDIF cables transmit audio signals as pulses of light through a cable made of plastic fibers. Audio signals are digitally transmitted between devices.

- **PCM Stream (Lossless)**
- **Dolby Digital 5.1 Channel**
- **DTS 5.1 Channel**
- **Digital Connection**
- **Audio Signal Only**



Optical/SPDIF



**BETTER**

## HDMI CABLE

HDMI technology transmits crystal-clear digital multi-channel surround audio through a single HDMI cable. Audio Return Channel-enabled (ARC) TVs allow audio to be sent over an already connected HDMI cable, eliminating the need for a separate audio cable. See *Connecting an Audio Device - ARC* on page 15.

- **ARC 2-way Communication (Auto setup)**
- **PCM, DTS, Dolby Digital**
- **2.0 - 5.1 Scalable Lossless Digital Audio Connection**
- **Audio and Video Signals**



HDMI



**BEST**

# CONNECTING AN AUDIO DEVICE - ARC

## Without HDMI ARC

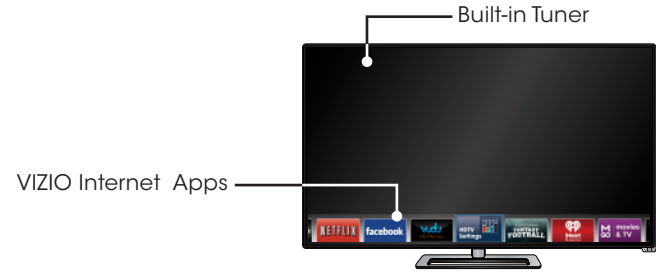

Your TV

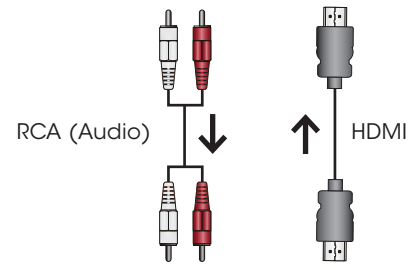

Your Home Audio Receiver

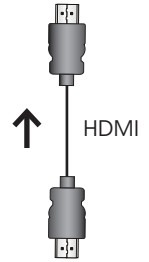

Your Blu-Ray Player

Without an HDMI ARC setup, your TV will transmit audio signal from the built-in tuner and VIA apps to your home audio receiver through a separate audio connection.

## With HDMI ARC

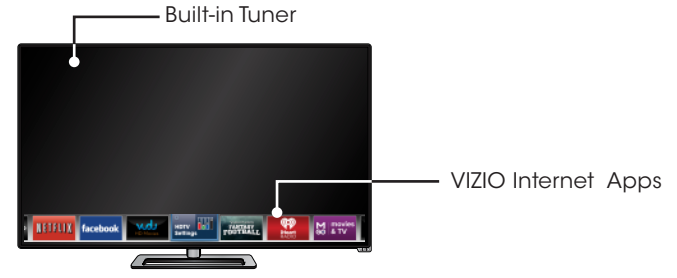

Your TV

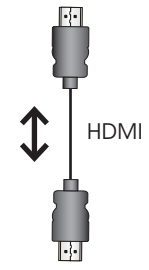

Your Home Audio Receiver

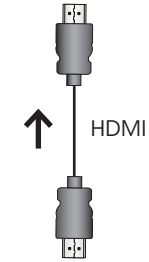

Your Blu-Ray Player

With an HDMI ARC setup, the audio connection between your TV and Home Audio Receiver can be removed. The HDMI cable will transmit audio signal to and from your TV with an all-digital audio/video connection.

## CONNECTING TO YOUR NETWORK

Your TV is internet-ready. It can be connected to your home network with a Wired or Wireless connection.

### Connecting to a Wired Network (Best)

1. Connect an ethernet cable to your router and to the ethernet port on the back of the TV. See below.
2. Use the Guided Network Setup to configure the TV. See *Using the Network Connection Menu* on page 24.

### Connecting to a Wireless Network

1. Ensure you have a router or modem broadcasting as high-speed wireless signal (802.11n recommended).
2. Use the Guided Network Setup to configure the TV. See *Using the Network Connection Menu* on page 24.



The first time you turn on the TV, the Setup App will guide you through each of the steps necessary to get your TV ready for use.

Before you begin the first-time setup:

- Your TV should be installed and the power cord should be connected to an electrical outlet.
- Your devices should be connected.
- If you have a wireless network, have the network key ready.
- If you are connecting to your network with an Ethernet cable, connect it to the Ethernet port on the TV.

To complete the first-time setup:

1. Press the **Power/Standby** button on the remote. The TV powers on and the Setup App starts.
2. Use the **Left/Right Arrow** buttons on the remote to highlight **Home Use** and press **OK**.
3. Use the **Up/Down Arrow** buttons on the remote to highlight a language and press **OK**. Then highlight a country and press **OK**.

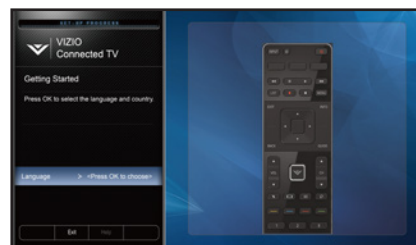
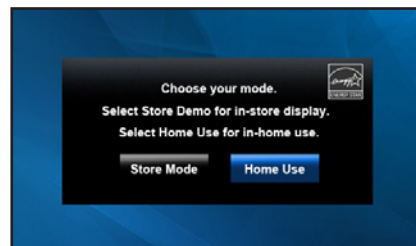

4. Use the **OK** and **Up/Down Arrow** buttons on the remote to read and accept the Terms of Service and Privacy Policy for Yahoo! TV Widgets.

When you are finished, highlight **Next** and press **OK**.



5. Select the name of your wireless network from the list of available networks and press **OK**.

Enter the network key using the on-screen keyboard, then highlight **Connect** and press **OK**.



6. Enter your First Name, Last Name, Phone Number, ZIP Code, and E-mail Address using the on-screen keyboard.

Highlight **Next** and press **OK**.

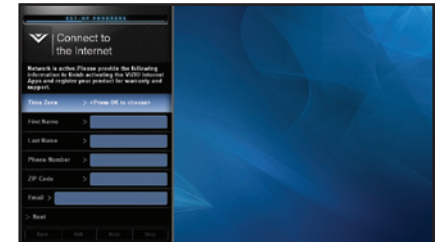

7. Answer the on-screen questions about your TV connection using the **Arrow** and **OK** buttons on the remote.

8. When you have finished the first time setup, highlight **Exit to Live TV** and press **OK**.



The First-Time Setup is complete.

Your TV features an easy-to-use on-screen menu.

To open the on-screen menu, press the **MENU** button on the remote. You can also open the on-screen menu by pressing the **VIA** button and selecting **HDTV Settings** from the VIA Dock, then pressing **OK**.

From this menu, you can:

- Adjust the Picture settings
- Adjust the Audio settings
- Activate the Sleep Timer
- Adjust the Network settings
- Adjust the Tuner settings
- Set up Closed Captioning
- Adjust TV Settings
- Access the Guided Setup
- Access the User Manual



## NAVIGATING THE ON-SCREEN MENU

To open the on-screen menu, press the **MENU** button on the remote.

Use the **Arrow** buttons to highlight a menu option, and press the **OK** button to select that option.

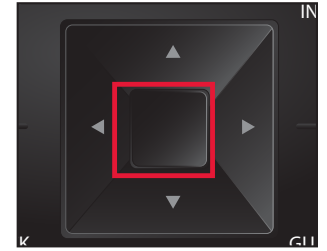

While navigating the on-screen menu, you can press the **BACK** button at any time to return to the previous menu screen. The **EXIT** button will close the on-screen menu.

## CHANGING THE 3D MODE

To correctly view 3D content, you must set the 3D mode to match the 3D format of the content.

To change the 3D mode:

1. Press the **3D** button on the remote. The on-screen menu is displayed.
2. If viewing 2D content, highlight **2D** and press **OK**. The menu closes.  
  
If viewing 3D content, highlight **3D** and press **OK**. Go to step 3.
3. Select the 3D mode to match the content you are watching:
  - **SBS** - Displays side-by-side 3D.
  - **TB** - Displays top/bottom 3D.
  - **Sensio** - Displays Sensio 3D.
4. The TV displays, "3D viewing mode enabled. Please wear 3D glasses." Put on your 3D glasses.

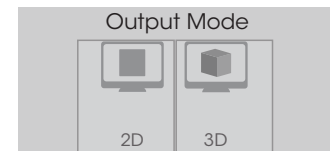



## CHANGING THE INPUT SOURCE

External devices such as DVD players, Blu-Ray Players, and video game consoles can be connected to your TV. To use one of these devices with your TV, you must first change the input source in the on-screen menu.

To change the input device:

1. Press the **INPUT** button on the remote. The input menu is displayed.
2. Use the **Up/Down Arrow** buttons or the **Input** button on the remote to highlight the input you wish to view and press **OK**. The selected input is displayed.

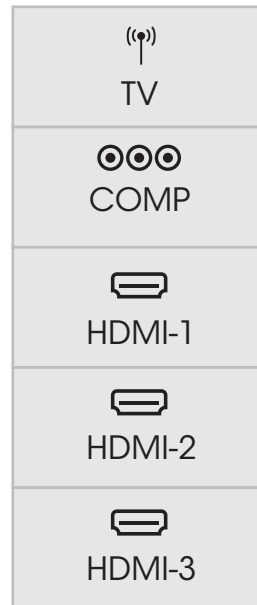

Note: Inputs may vary by TV

## CHANGING THE SCREEN ASPECT RATIO

The TV can display images in four different modes: Normal, Panoramic, Wide, and Zoom. Each mode displays the picture differently.

To change the screen aspect ratio:

1. Press the  button on the remote.
2. Use the **Arrow** buttons to highlight the aspect ratio you wish to view and press **OK**.
  - **Normal** preserves the content's original aspect ratio. Since the 4:3 aspect ratio is not large enough to fill the TV's screen, black bars are added to the left and right of the display image.
  - **Panoramic** expands the display image to fill the screen. Images may appear wider than intended. If you are watching widescreen (1.85:1 or 2.35:1) content, black bars will still appear on the top and bottom of the display image. **This option is only available when the TV is displaying a 480i/480p source.**
  - **Wide** stretches a 4:3 aspect ratio picture to the edges of the screen. Since the picture is being stretched, the display image may appear distorted. If the program is already formatted for widescreen viewing (1.85:1 or 2.35:1), then black bars will appear on the top and bottom of the display image.
  - **Zoom** expands images with black bars to fit the screen.

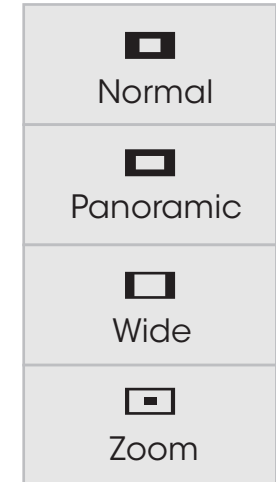

## ADJUSTING THE PICTURE SETTINGS

Your TV display can be adjusted to suit your preferences and viewing conditions.

To adjust the picture settings:

1. Press the **MENU** button on the remote. The on-screen menu is displayed.
2. Use the **Arrow** buttons on the remote to highlight **Picture** and press **OK**. The Picture menu is displayed.
3. Use the **Arrow** buttons on the remote to highlight **Picture Mode**, then use the **Left/Right Arrow** buttons to change the picture mode:

- **Standard mode** sets the various picture settings to values that will produce the best picture in the most cases. This is the recommended setting.
- **Calibrated Day mode** sets the picture settings to values perfect for watching a movie in a brightly-lit room.
- **Calibrated Night mode** sets the picture settings to values perfect for watching a movie in a dark room.
- **Vivid mode** sets the picture settings to values that produce a brighter, more vivid picture.
- **Game mode** optimizes the picture settings for displaying game console output.

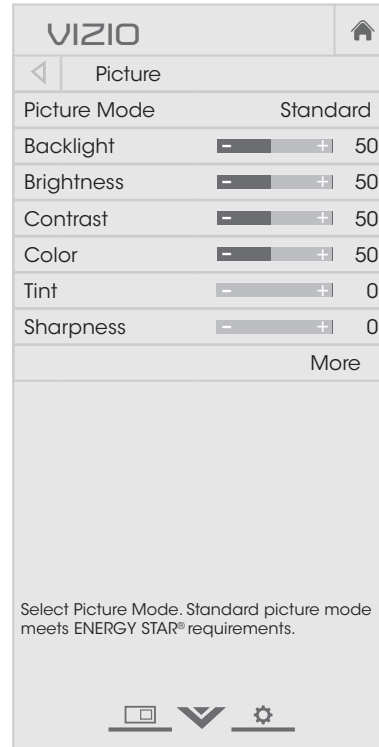

- **Computer mode** optimizes the picture settings for displaying computer output.

Changing the Picture Mode setting to **Custom** allows you to manually change each of the picture settings:

- **Backlight** - Adjusts the LED brightness to affect the overall brilliance of the picture.
- **Brightness** - Adjusts the black level of the picture. When this setting is too low, the picture may be too dark to distinguish details. When this setting is too high, the picture may appear faded or washed out.
- **Contrast** - Adjusts the white level of the picture. When this setting is too low, the picture may appear dark. When this setting is too high, the picture may appear faded or washed out. If the setting is too high or too low, detail may be difficult to distinguish in dark or bright areas of the picture.
- **Color** - Adjusts the intensity of the picture colors.
- **Tint** - Adjusts the hue of the picture. This setting is useful in adjusting the flesh tones in the picture. If flesh appears too orange, reduce the level of color before adjusting tint.
- **Sharpness** - Adjusts the edge sharpness of picture elements. It can be used to sharpen non-HD (high definition) content; however, it will not produce detail that does not otherwise exist.

## Adjusting the Picture Size and Position

When displaying an image, the size and position of the display image can be adjusted. The size and position adjustments depend on signal source.

To adjust the picture size and position:

- From the Picture menu, use the **Arrow** buttons on the remote to highlight **More**, then press **OK**.
- Use the **Arrow** buttons on the remote to highlight **Size & Position**, then press **OK**. The Size & Position menu is displayed.
- Use the **Arrow** buttons to highlight the setting you wish to adjust, then press **Left/Right Arrow** buttons to change the setting:
  - Horiz. Position** - Adjusts the horizontal (left/right) position of the display image.
  - Vertical Position** - Adjusts the vertical (up/down) position of the display image.
  - Horizontal Size** - Adjusts the width of the display image.
  - Vertical Size** - Adjusts the height of the display image.
- When you have finished adjusting the size and position, press the **EXIT** button on the remote.

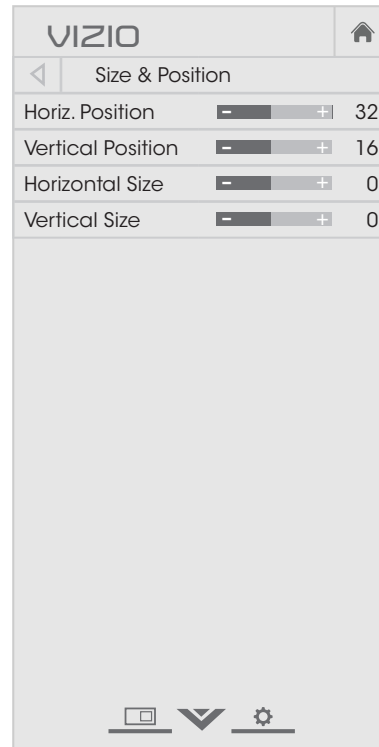

## Adjusting the Color Temperature

Adjusting the color temperature will change the “warmness” or “coolness” of the white areas of the picture.

To adjust the color temperature:

- From the Picture Menu, use the **Arrow** buttons to highlight **More**, then press **OK**.
- Use the **Arrow** buttons on the remote to highlight **Color Temperature**, then press **OK**. The Color Temperature menu is displayed.
- Use the **Arrow** buttons on the remote to highlight **Color Temperature**, then use the **Left/Right Arrow** buttons to change the color temperature preset:
  - Cool** produces a blue-hued picture.
  - Computer** optimizes the picture for use as a PC monitor.
  - Normal** is optimized for television viewing.
  - Custom** allows you to manually change each of the color temperature settings:

**Red/Green/Blue Gain** - Adjusts the amount of each color in the display.

**Red/Green/Blue Offset** - Adjusts the position of each color in the display.

- If you want to reset the color temperatures to the factory default settings, highlight **Reset Color Temperature** and highlight **Yes**, and press **OK**.
- When you have finished adjusting the color temperature, press the **EXIT** button on the remote.

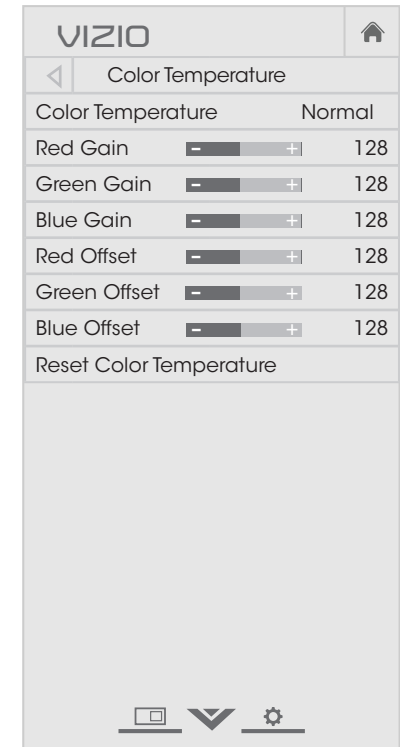

## Adjusting the Advanced Picture Settings

To adjust the advanced picture settings:

1. From the Picture menu, use the **Arrow** buttons on the remote to highlight **More**, then press **OK**.
2. Use the **Arrow** buttons on the remote to highlight **Advanced Picture**, then press **OK**. The Advanced Picture menu is displayed.
3. Use the **Arrow** buttons to highlight the setting you wish to adjust, then press **Left/Right Arrow** buttons to change the setting:

- **Auto Brightness Control** - The ambient light sensor detects the light levels in the room and automatically adjusts the backlight for the best picture. Select Off, Low, Medium, or High.
- **Black Detail** - Adjusts the average brightness of the picture to compensate for large areas of brightness. Select Off, Low, Medium, or High.
- **Smart Dimming** - Improves the contrast ratio of the screen by adjusting the backlight intelligently. Select **On** or **Off**.
- **Smooth Motion Effect** - Smooth Motion Effect activates Motion Estimation/Motion Compensation (ME/MC) to ensure that on-screen motion is crisp and clear. Select **On** or **Off**.

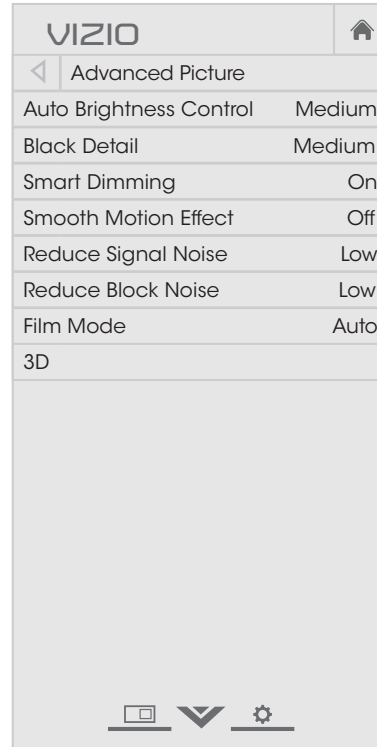

- **Reduce Signal Noise** - Diminishes artifacts in the image caused by the digitizing of image motion content. Select Off, Low, Medium, or High.
  - **Reduce Block Noise** - Reduces pixellation and distortion for .mpeg files. Select Off, Low, Medium, or High.
  - **Film Mode** - Optimizes the picture for watching film. Select Auto or Off.
  - **3D** - Turns 3D mode on or off.
4. When you have finished adjusting the Advanced Picture Settings, press the **EXIT** button on the remote.

## Resetting the Picture Settings

To reset the picture settings to the factory default settings:

1. From the Picture menu, use the **Arrow** buttons to highlight **More**, then press **OK**.
2. Use the **Arrow** buttons on the remote to highlight **Reset Picture Mode**, then press **OK**. The TV displays, "Are you sure you want to RESET Picture Settings to the factory defaults?"
3. Highlight **Yes** and press **OK**.
4. Press the **EXIT** button on the remote.

## ADJUSTING THE AUDIO SETTINGS

To adjust the audio settings:

1. Press the **MENU** button on the remote. The on-screen menu is displayed.
2. Use the **Arrow** buttons on the remote to highlight **Audio** and press **OK**. The Audio menu is displayed.
3. Use the **Arrow** buttons to highlight the setting you wish to adjust, then press **Left/Right Arrow** buttons to change the setting:
  - **Balance** - Adjusts the loudness of the audio output from the left and right speakers.
  - **Lip Sync** - Adjusts the synchronization between the display image and the accompanying audio track.
  - **TV Speakers** - Turns the built-in speakers on or off.
  - **Surround Sound** - DTS Studio Sound™ is a feature-rich surround sound solution which delivers an immersive surround sound experience from the TV's internal speakers. Additionally, Studio Sound completes the entertainment experience by maintaining a steady volume while watching programming and movies, providing deep, rich bass, and delivering crisp details and clear, intelligible dialog. Select On or Off.
  - **Volume Leveling** - DTS TruVolume™ maintains consistent volume levels during transitions between program

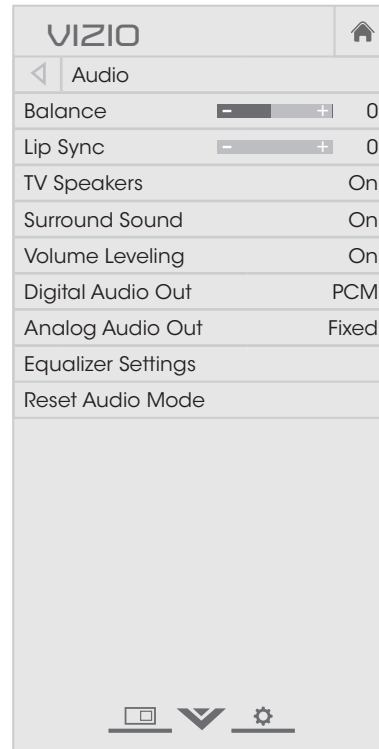

content, AV formats and input sources. Select On or Off.

- **Digital Audio Out** - Changes the type of processing for the Optical and HDMI ARC output when connected to a home theater audio system. Select PCM or Bitstream.
  - **Analog Audio Out** - Sets the volume control properties for the analog RCA (red/white) connectors when connected to a home theater audio system. Select Variable to control the external speakers' volume from the TV's volume controls, or select Fixed to control the external speakers' volume from your home theater system controls.
  - **Equalizer Settings** - Adjusts the boost or attenuation of different frequencies. Change the audio mode by selecting Flat, Dynamic, Center, Bass, Boost, or Bright. To change the equalizer settings yourself, highlight **EQ Mode** to **Advanced**, then adjust each frequency, or set **EQ Mode** to **Basic**, then adjust Bass and Trebel settings.
  - **Reset Audio Mode** - Restores the audio settings to the factory defaults. See *Resetting the Audio Settings on page 23*.
4. When you have finished adjusting the audio settings, press the **EXIT** button on the remote.



When the TV speakers are set to **ON**, DTS signals cannot be passed through digital audio outputs.

## Resetting the Audio Settings

To reset the audio settings to the factory default settings:

1. Press the **MENU** button on the remote. The on-screen menu is displayed.
2. Use the **Arrow** buttons on the remote to highlight **Audio** and press **OK**. The Audio menu is displayed.
3. Use the **Arrow** buttons to highlight **Reset Audio Mode** and press **OK**. The TV displays, "Are you sure you want to RESET Audio Settings to the factory defaults?"
4. Highlight **Yes** and press **OK**.
5. Press the **EXIT** button on the remote.

## ACTIVATING THE SLEEP TIMER

When activated, the TV's sleep timer will turn the TV off after a set period of time.

To use the sleep timer:

1. Press the **MENU** button on the remote. The on-screen menu is displayed.
2. Use the **Arrow** buttons on the remote to highlight **Timers** and press **OK**. The Sleep Timer menu is displayed.
3. Use the **Up/Down Arrow** buttons on the remote to highlight **Sleep Timer** and press **OK**. The Timers menu is displayed.
4. Use the **Up/Down Arrow** buttons on the remote to highlight the period of time after which you want the TV to turn off: **30, 60, 90, 120, or 180 minutes**. If you don't want the sleep timer to activate, change the setting to **Off**.
5. Press **OK**, then press **EXIT**.

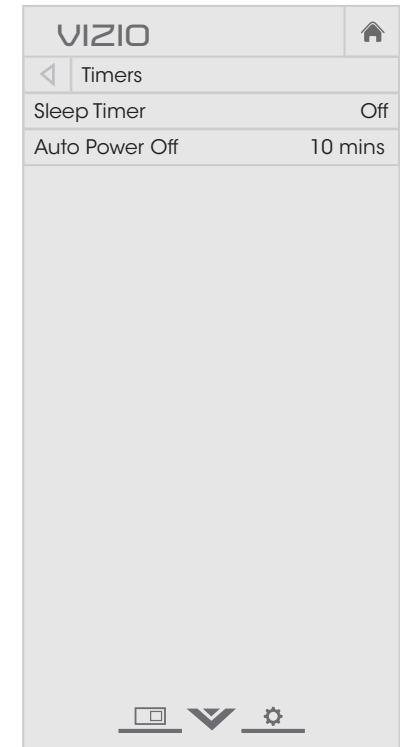

## Setting the Auto Power Off Feature

To help save energy, your TV is set by default to turn off after 10 minutes if no signal is being displayed on the screen. This feature can be deactivated.

To set the Auto Power Off feature:

1. From the Sleep Timer menu, use the **Up/Down Arrow** buttons on the remote to highlight **Auto Power Off** and press **OK**. The Auto Power-Off menu is displayed.
2. Highlight **Off** or **10 min** and press **OK**. Press **EXIT**.

## USING THE NETWORK CONNECTION MENU

Your TV is internet-ready, featuring both an Ethernet port and built-in high-speed Wireless-N.

### Connecting to a Wireless Network

To connect to a wireless network whose network name (SSID) is being broadcast:



If your TV is connected to a network with an Ethernet cable, you will not see the wireless network connection menu. You must disconnect the Ethernet cable to set up a wireless network connection.

1. Press the **MENU** button on the remote. The on-screen menu is displayed.
2. Use the **Arrow** buttons on the remote to highlight **Network** and press **OK**. The Network menu is displayed.
3. If you do not see your wireless network displayed, highlight **More Access Points** and press **OK**. The More Access Points menu, which is a list of available wireless networks, is displayed.
4. Highlight the name of your wireless network (this is the network's SSID) and press **OK**.
5. Using the on-screen keyboard, enter your network's password, then highlight **Connect** and press **OK**.
6. Press the **EXIT** button on the remote.

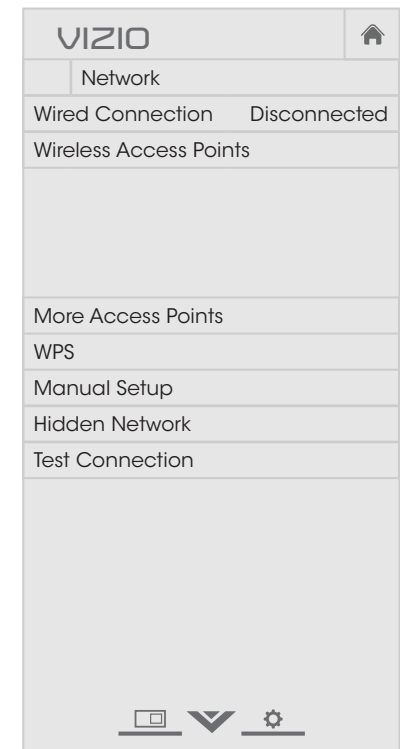

## Changing the Manual Setup Settings

Advanced users can fine-tune the network settings using the Manual Setup feature.

To change advanced network settings:

- From the Network menu, highlight **Manual Setup** and press **OK**. The Manual Setup menu is displayed.
- Use the **Arrow** and **OK** buttons to adjust each setting:
  - DHCP** - (Dynamic Host Configuration Protocol) This setting must be turned Off to change any of the other settings.
  - IP Address** - The IP address assigned to the TV.
  - Subnet Mask** - The subnet mask.
  - Default Gateway** - Your network's default gateway address.
  - Pref. DNS Server** - Your preferred domain name server address.
  - Alt. DNS Server** - Your alternate domain name server address.
- If you need the RJ45 (Ethernet) MAC address or the Wireless MAC address to set up your network, these are displayed at the bottom of the Change Settings menu.
- Press the **EXIT** button on the remote.

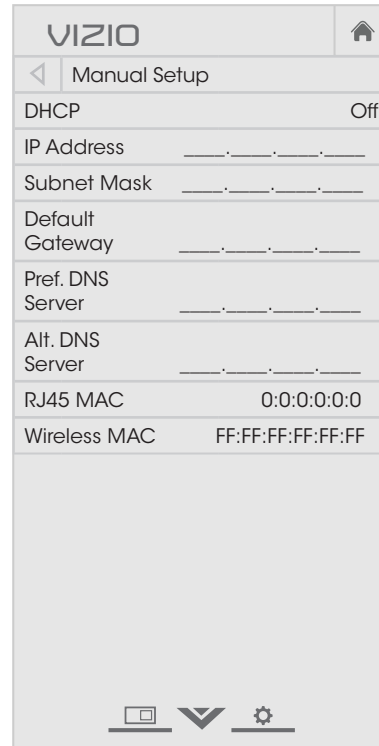

## Connecting to a Hidden Network

To connect to a wireless network whose network name (SSID) is not being broadcast:

- Press the **MENU** button on the remote. The on-screen menu is displayed.
- Use the **Arrow** buttons on the remote to highlight **Network** and press **OK**. The Network menu is displayed.
- Highlight **Hidden Network** and press **OK**.
- Using the on-screen keyboard, enter your network's name (SSID), then highlight **Connect** and press **OK**.
- Using the on-screen keyboard, enter your network's password, then highlight **Connect** and press **OK**.
- Press the **EXIT** button on the remote.

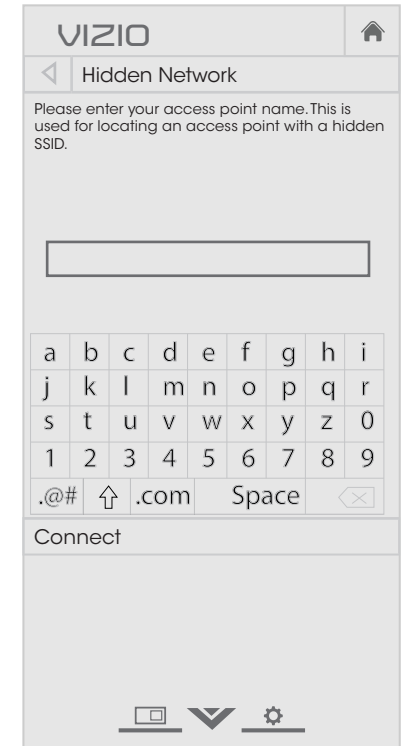



## Testing Your Network Connection

To test your network connection:

1. From the Network menu, highlight **Test Connection** and press **OK**.
2. The Test Connection screen displays the connection method, network name, signal strength, and download speed of your network connection.
3. Press the **EXIT** button on the remote.

## USING THE TUNER MENU

You can use the TV's Tuner menu to:

- Select a Tuner Input
- Perform an Auto Channel Scan
- Perform a Partial Channel Scan
- Manually Add Channels
- Select Channels to skip
- Select Analog MTS modes
- Select Digital Languages



## Selecting a Tuner Input

Select the type of tuner input you will be using. You can select either Antenna (Over-the-air) or Cable (Out-of-the-wall) connections.

1. From the Tuner menu, highlight **Tuner Mode** and press **OK**. The Tuner Mode menu displays.
2. Highlight **Antenna** or **Cable** and press **OK**. Press **EXIT**.

## Scanning for Channels

Before the TV can detect and display channels and their associated information, you must scan for channels. A channel scan may also be necessary when the TV has been moved to an area where different free-to-air broadcast television channels are available.

To perform an Auto Channel Scan:

1. From the Tuner Settings menu, highlight **Auto Channel Scan**, and press **OK**. The auto channel scan begins.
2. Wait until the channel scan is 100% complete. Highlight **Done** and press **OK**.
3. Press the **EXIT** button on the remote.

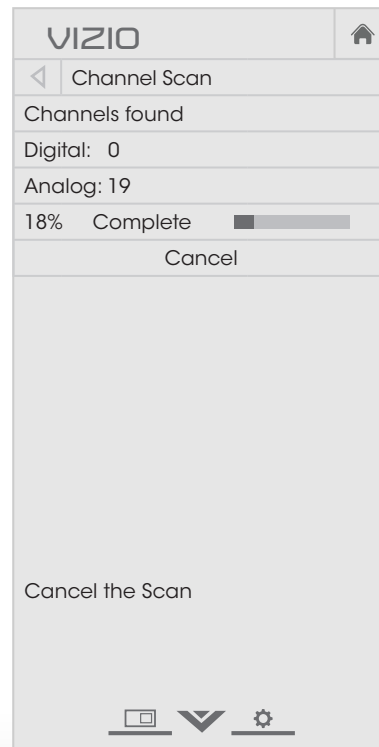

## Adding New Channels

Occasionally, you may need to add a new analog channel or add a new range of channels. You can do this by using the Partial Channel Search and Add Analog Channel options.

To add a range of new channels:

1. From the Tuner menu, highlight **Partial Channel Search**, and press **OK**. The Partial Channel Search menu is displayed.
2. Highlight **Scan Mode** and select the type of channel you are adding: **Analog**, or **Digital**.
3. Highlight **From Channel** and enter the channel from which you want to begin the scan. (Use the **Number Pad** on the remote to enter the channel.)
4. Highlight **To Channel** and enter the channel to which you want to end the scan. (Use the **Number Pad** on the remote to enter the channel.)
5. Highlight **Start** and press **OK**. The partial channel search begins.
6. Wait until the partial channel search is 100% complete. Highlight **Done** and press **OK**.
7. Press the **EXIT** button on the remote.

To add a single new analog channel:

1. From the Tuner menu, highlight **Add Analog Channel** and press **OK**. The Add Analog Channel menu is displayed.
2. Highlight **Enter Channel #** and use the **Number Pad** on the remote to enter the number of the channel you are adding.
3. Highlight **Add Channel** and press **OK**. The TV scans for the channel.
4. When the TV is done scanning for the channel, press the **EXIT** button on the remote.

### Skipping Channels

After a channel scan is completed, you may find that some channels are too weak to watch comfortably. There may also be some channels you do not want to view. You can remove these channels from the TV's memory with the Skip Channel feature.



Channels that have been removed with the Skip Channel feature can still be viewed if the channel is entered using the Number Pad. If you wish to completely block a channel from being viewed, use the parental controls. See *Navigating the On-Screen Menu* on page 17.

To remove a channel:

1. From the Tuner menu, highlight **Skip Channel**, and press **OK**. The Skip Channel menu is displayed.
2. For each channel you wish to remove, use the **Up/Down Arrow** buttons on the remote to highlight the channel and press **OK**. A ✓ appears to the right of each channel you select.
3. When you have selected all of the channels you wish to remove, press the **EXIT** button on the remote.

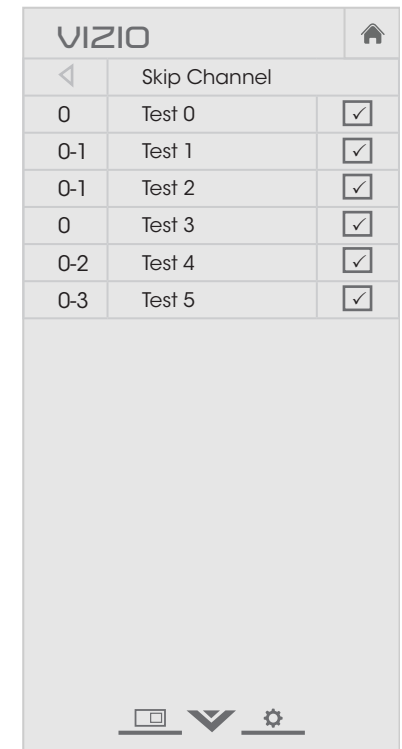

## Changing the Audio Language

Some digital free-to-air and cable channels broadcast programs in more than one language. The TV's Analog Audio feature allows you to listen to audio in your preferred language.



Not all programs are broadcast in multiple languages. The Analog Audio feature only works when the program being viewed is being broadcast in the language you select.

To use the Analog Audio feature:

1. From the Tuner menu, highlight **Analog Audio** and press **OK**. The Analog Audio menu is displayed.
2. Select **Mono**, **Stereo**, or **SAP** (secondary audio programming). Press **OK**.
3. Press the **EXIT** button on the remote.

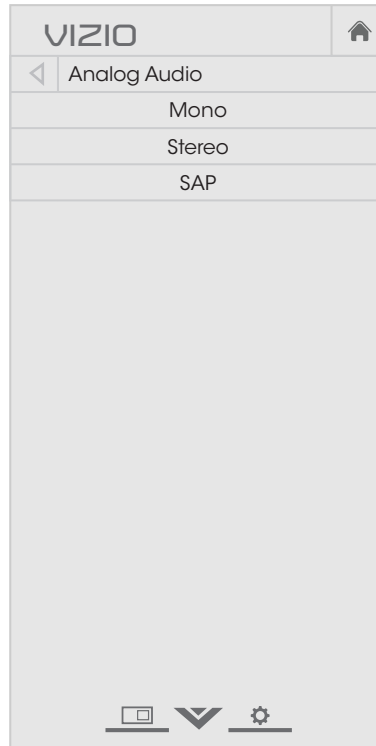

To use the Digital Language feature:

1. From the Tuner menu, highlight **Digital Language** and press **OK**. The Digital Language menu is displayed.
2. Select your preferred language: **English**, **Français** or **Español**. Press **OK**.
3. Press the **EXIT** button on the remote.

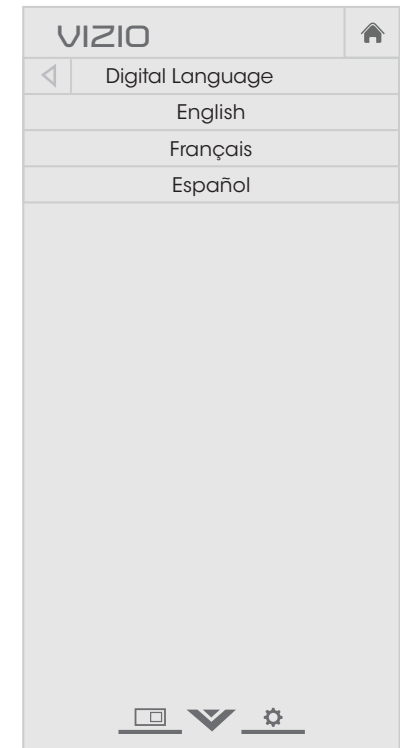

## SETTING UP CLOSED CAPTIONING

Your TV can display closed captions for programs that include them. Closed captions display a transcription of a program's dialogue.



If the program you are viewing is not being broadcast with closed captions, the TV will not display them.

To activate or deactivate closed captions:

1. Press the **MENU** button on the remote. The on-screen menu is displayed.
2. Use the **Arrow** buttons on the remote to highlight **CC** and press **OK**. The Closed Caption menu is displayed.
3. Use the **Arrow** buttons on the remote to highlight the type of closed captions you wish to see:
  - **Analog Closed Caption** for analog (NTSC) TV channels.
  - **Digital Closed Caption** for digital (ATSC) TV channels.
4. After highlighting the type of closed captions you wish to see, use the **Left/Right Arrow** buttons on the remote to select the caption channel you wish to display, then press **EXIT**.

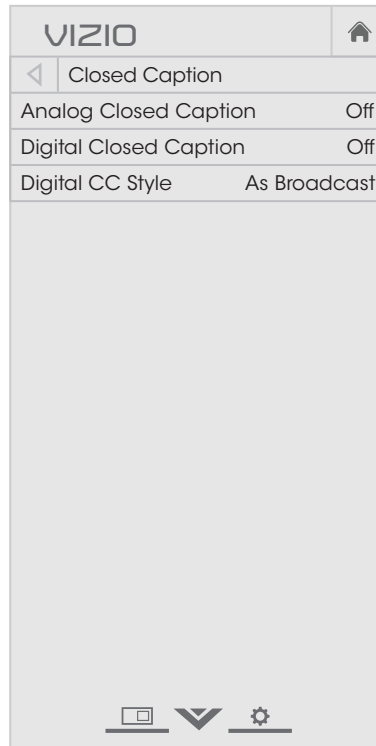

Caption channels usually display different languages. For example, CC1 may display English captions and CC2 may display Spanish captions.

## Changing the Appearance of Digital Closed Captions

Digital closed captions can be displayed according to your preference.

To change the appearance of digital closed captions:

1. From the Closed Caption menu, use the **Arrow** buttons to highlight **Digital CC Style** and press **OK**.
2. Use the **Left/Right Arrow** buttons on the remote to select **Custom**. The Digital CC Style menu appears.
3. Use the **Up/Down Arrow** buttons on the remote to highlight the setting you wish to change, then use the **Left/Right Arrow** buttons to change the setting:
  - **Caption Style** - Choose As Broadcast to keep default settings or Custom to manually change each setting.
  - **Font Style** - Adjust the style of the font.
  - **Text Size** - Adjust the size of the text.
  - **Color** - Change the color of the text.
  - **Opacity** - Change the transparency of the text.
  - **BG Color** - Change the background color.
  - **BG Opacity** - Change the transparency of the background.
  - **Window Color** - Change the edge color.
  - **Window Opacity** - Change the edge type.
4. When you are satisfied with the appearance of the closed captions, press the **EXIT** button on the remote.

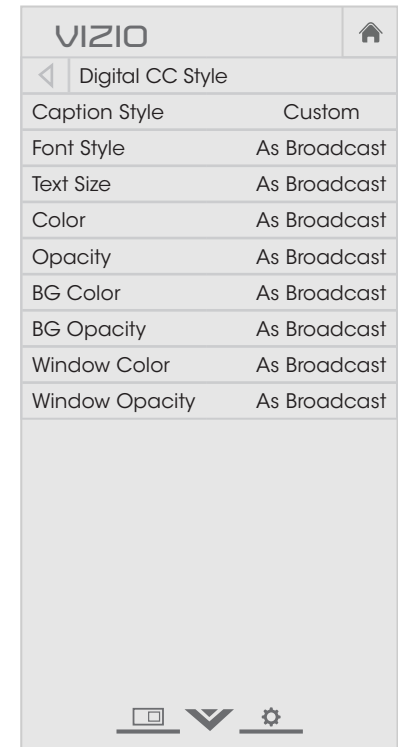

## CHANGING THE TV SETTINGS

Using the settings menu, you can:

- View the System Information
- Name the TV inputs
- Set up Parental Controls
- Change the on-screen menu language
- Set the time
- Adjust the CEC settings
- Adjust the Power Indicator settings
- Reset TV Settings & Admin Controls

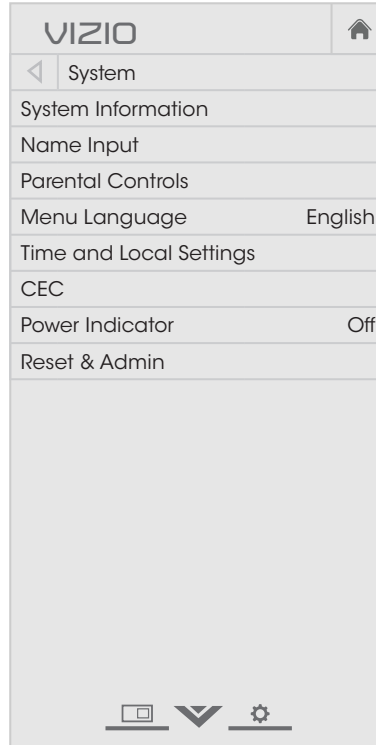

## Displaying System Information

To display a summary of the TV settings:

1. Press the **MENU** button on the remote. The on-screen menu is displayed.
2. Use the **Arrow** buttons on the remote to highlight **System** and press **OK**. The System menu is displayed.
3. Highlight **System Info** and press **OK**.
4. Use the **Up/Down Arrow** buttons to scroll through the system information.
5. When you are finished reviewing the system information, press the **EXIT** button on the remote.

## Changing the Names of the Inputs

To make it easier to recognize the different devices attached to the inputs on your TV, you can rename the inputs. For example, if you have a DVD player connected to the Component input, you can rename that input to display "DVD Player".

To change the name of an input:

1. Press the **MENU** button on the remote. The on-screen menu is displayed.
2. Use the **Arrow** buttons on the remote to highlight **System** and press **OK**. The System menu is displayed.
3. Use the **Arrow** buttons on the remote to highlight **Name Input** and press **OK**. The Name Input menu is displayed.
4. Highlight **Input Source** and press **OK**. Highlight the input you want to rename and press **OK**.
5. If you would like to use a preset input label, highlight **Input Labels** and press **OK**. Highlight the input label you want to use and press **OK**.

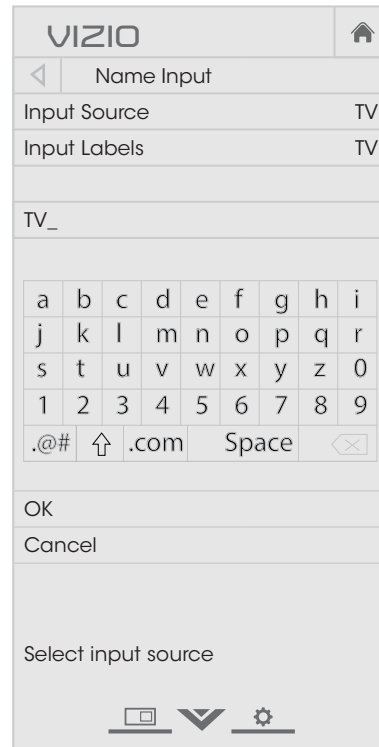

If you would like to name the input yourself, highlight the field below Input Labels and enter your custom label using the on-screen keyboard and press **OK**.

6. When you have finished naming your input, press the **EXIT** button on the remote.

## Using the Parental Controls

The TV's parental controls allow you to prevent the TV from displaying certain channels or programs without a password.

### Accessing the Parental Controls Menu

To access the Parental Controls menu:

1. Press the **MENU** button on the remote. The on-screen menu is displayed.
2. Use the **Arrow** buttons on the remote to highlight **System** and press **OK**. The System menu is displayed.
3. Use the **Arrow** buttons on the remote to highlight **Parental Controls** and press **OK**.
4. Enter your parental passcode. If you have not set a passcode, enter the default, **0000**. The Parental Controls menu is displayed.



To set a custom parental passcode, see *Changing the Parental Control Passcode* on page 34.

## Enabling or Disabling Program Ratings

To manage program content according to its rating, you must enable the Program Rating feature.

To enable or disable the Program Rating feature:

1. From the Parental Controls menu, highlight **Rating Enable** and press **OK**. The Rating Enable menu is displayed.
2. Select **On** or **Off** and press **OK**.

## Locking and Unlocking Channels

When a channel is locked, it will be inaccessible. Locking a channel is a good way to prevent children from viewing inappropriate material.

To lock or unlock a channel:

1. From the Parental Controls menu, highlight **Channel Locks** and press **OK**. The Channel Locks menu is displayed.
2. Highlight the channel you want to lock or unlock and press **OK**.
3. When a channel is **locked**, the **Lock** icon appears **locked**. The channel is not accessible unless the parental passcode is entered.
4. When a channel is **unlocked**, the **Lock** icon appears **unlocked**. The channel is accessible.

## Blocking and Unblocking Content by Rating

A channel may sometimes broadcast programs that are meant for children, and at other times broadcast programs that are meant for mature audiences. You may not want to block the channel completely using a channel lock, but you may wish to block certain programs from being viewed.



For a list of content ratings and their definitions, visit [www.tvguidelines.org](http://www.tvguidelines.org).

To block or unblock content by its rating:

1. From the Parental Controls menu, highlight the content type you want to adjust and press **OK**:

**USA - TV** - USA television program broadcasts.

**USA - Movie** - USA movie broadcasts.

**CAN - English** - Canadian English television program broadcasts.

**CAN - French** - Canadian French television program broadcasts.

2. For each rating type you want to block or unblock, use the **Up/Down** and **Left/Right Arrow** buttons on the remote to highlight the rating type and press **OK**.
3. When the rating type is **blocked**, the **Lock** icon appears **locked**. Content with this rating and all higher ratings cannot be viewed.
4. When the rating type is **unblocked**, the **Lock** icon appears **unlocked**. Content with this rating and all lower ratings can be viewed.

If you want to block all unrated content, highlight **Block Unrated Shows** and use the **Arrow** buttons on the remote to select **On**.

5. When you are finished adjusting the rating level blocks, press the **EXIT** button on the remote.



## Changing the Parental Control Passcode

If you use the parental controls, you should change the passcode to prevent children from accessing inappropriate material.

To change the parental control passcode:

1. From the Parental Controls menu, highlight **Change PIN** and press **OK**. The Change PIN menu is displayed.
2. In the **New PIN** field, use the **Number Pad** on the remote to enter your new 4-digit parental control passcode.
3. In the **Confirm PIN** field, use the **Number Pad** on the remote to re-enter your new 4-digit parental control passcode.
4. Write down your new parental control passcode and save it in a secure location.
5. Press the **EXIT** button on the remote.

## Resetting the Content Locks

To reset the content locks to the factory-default settings:

1. From the Parental Controls menu, highlight **RESET LOCKS** and press **OK**. The TV displays, "Are you sure you want to RESET ALL LOCKS SETTINGS to the factory defaults?"
2. Highlight **Yes** and press **OK**.

## Changing the On-Screen Menu Language

Your TV can display the on-screen menu in different languages.

To change the on-screen menu language:

1. Press the **MENU** button on the remote. The on-screen menu is displayed.
2. Use the **Arrow** buttons on the remote to highlight **System** and press **OK**. The System menu is displayed.
3. Use the **Arrow** buttons on the remote to highlight **Menu Language** and press **OK**. The Menu Language menu is displayed.
4. Highlight your preferred language (**English**, **Français**, or **Español**) and press **OK**.
5. Press the **EXIT** button on the remote.

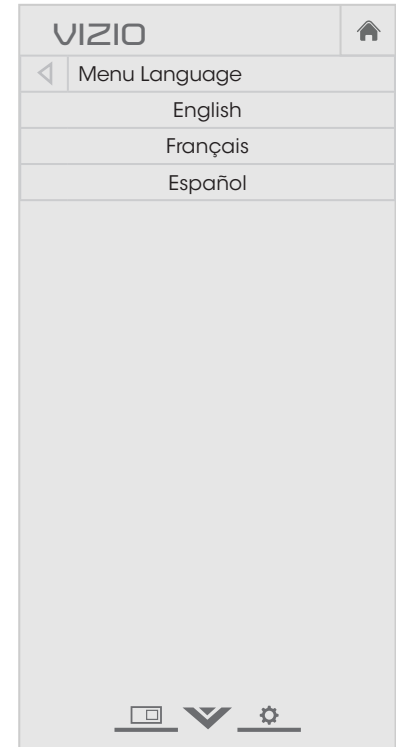

## Setting the Time Zone

To ensure the correct time is displayed when you press the **INFO** button, set the TV's time zone:



To have the TV display the correct time, you must be connected to the internet via an Ethernet cable or a wireless network.

1. Press the **MENU** button on the remote. The on-screen menu is displayed.
2. Use the **Arrow** buttons on the remote to highlight **System** and press **OK**. The System menu is displayed.
3. Use the **Arrow** buttons on the remote to highlight **Time and Local Settings** and press **OK**. The Time & Local Settings menu is displayed.
4. Highlight **Time Zone** and press **OK**. The Time Zone menu is displayed.
5. Highlight your time zone and press **OK**.
6. Highlight **Daylight Savings** and press **OK**. The Daylight Savings menu is displayed. Choose **On** if daylight savings is in effect, or **Off** if it is not.
7. Highlight **Zip Code**. Enter your ZIP code using the keypad on the remote, then press **OK**. The ZIP code information is often used by VIA Apps to give you the most accurate location-based information, such as weather or news.
8. Press the **EXIT** button on the remote.

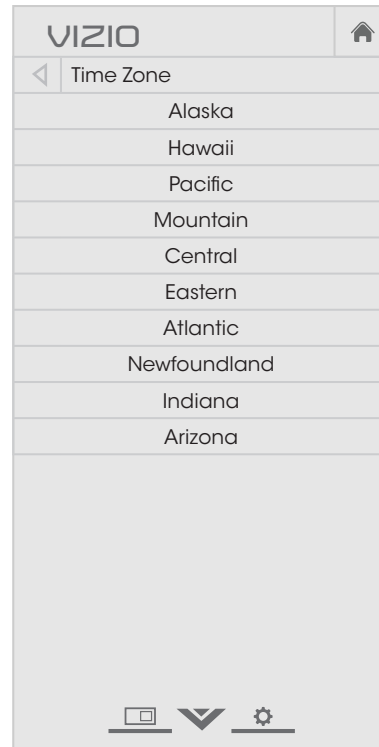

## Adjusting the CEC Settings

The CEC function on your TV enables you to control HDMI-connected devices with the included remote without any additional programming.



Not all HDMI devices support CEC. See your device's user manual for details.

To enable, disable, or adjust CEC settings:

1. Press the **MENU** button on the remote. The on-screen menu is displayed.
2. Use the **Arrow** buttons on the remote to highlight **System** and press **OK**. The System menu is displayed.
3. Use the **Arrow** buttons on the remote to highlight **CEC Settings** and press **OK**. The CEC Settings menu is displayed.
4. Use the **Arrow** and **OK** buttons to adjust each setting:
  - **CEC Function** - To use CEC, you must select **Enable**.
  - **System Audio Control** - When system audio control is on, you can control your device's audio using the TV's remote control.
  - **Device Discovery** - Use this function to determine if your device is connected and supports CEC.
5. Press the **EXIT** button on the remote.

### Turning the Power Indicator On or Off

The Power Indicator on the front of your TV is set to light up when the TV is on. You can change this setting if you prefer the light to be off.

To turn the Power Indicator Light on or off:

1. Press the **MENU** button on the remote. The on-screen menu is displayed.
2. Use the **Arrow** buttons on the remote to highlight **System** and press **OK**. The System menu is displayed.
3. Highlight **Power Indicator** and press **OK**.
4. Use the **Up/Down Arrow** buttons to select **On** or **Off**, then press **OK**.

### USING THE RESET & ADMIN MENU

You can use the TV's Reset & Admin menu to:

- Reset the TV settings
- Restore the TV to its factory default settings
- View the VIZIO Privacy Policy
- Perform a Service Check
- Start the Store Demo

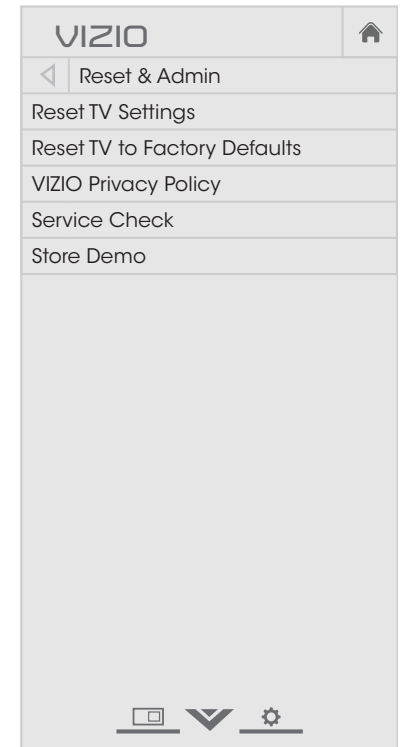

## Resetting the TV Settings

To reset the TV's picture and audio settings:

1. Press the **MENU** button on the remote. The on-screen menu is displayed.
2. Use the **Arrow** buttons on the remote to highlight **System** and press **OK**. The System menu is displayed.
3. Highlight **Reset & Admin** and press **OK**. The Reset & Admin menu is displayed.
4. Highlight **Reset TV Settings** and press **OK**. The TV displays, "Are you sure you would like to Restore Defaults? This will erase any custom settings."
5. Highlight **Yes** and press **OK**.
6. Press the **EXIT** button on the remote.

## Restoring the TV to Factory Default Settings

All of the on-screen menu settings can be reset to the factory defaults.



If you restore the TV to the factory default settings, all changes you have made to the settings will be lost!

To restore the TV to its factory default settings:

1. Press the **MENU** button on the remote. The on-screen menu is displayed.
2. Use the **Arrow** buttons on the remote to highlight **System** and press **OK**. The System menu is displayed.
3. Highlight **Reset & Admin** and press **OK**. The Reset & Admin menu is displayed.
4. Highlight **Reset TV to Factory Defaults** and press **OK**.
5. Enter your parental control passcode. If you have not yet set up a parental passcode, enter the default, **0000**.

The TV displays, "Select Reset to return to default factory settings."

6. Highlight **Reset** and press **OK**.
7. Wait for the TV to turn off. The TV will turn back on shortly afterward and the Setup App will begin.

## Performing a Service Check

When instructed by service personnel, you may need to perform a Service Check. The Service Check is used as a troubleshooting tool.



Only perform a Service Check when instructed by service personnel.

## USING THE GUIDED SETUP MENU

### Using Guided Setup

The TV's Setup App can be used to easily set up the TV tuner or to connect the TV with your network.

To access guided setup:

1. Press the **MENU** button on the remote. The on-screen menu is displayed.
2. Highlight **Guided Setup** and press **OK**.
3. Highlight the guided setup you want to access and press OK:
  - **Tuner Setup** - Set up the TV tuner.
  - **Network Setup** - Connect the TV to your network.
4. Follow the on-screen instructions. When finished, press the **EXIT** button on the remote.

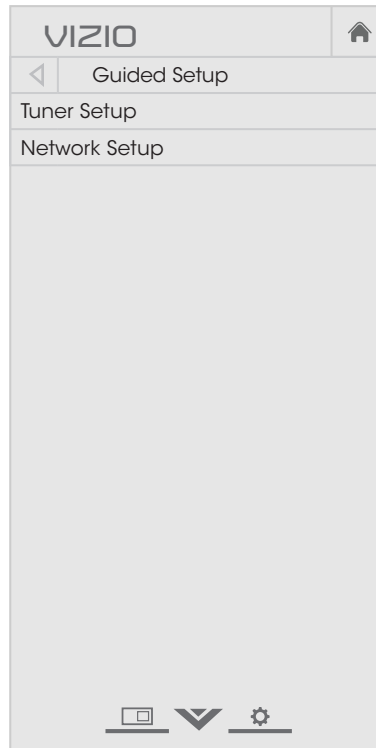

## USING THE INFO WINDOW

The Info Window can be displayed by pressing the **INFO** or **GUIDE** button on the remote:

- Press the **INFO** or **GUIDE** button one time to display channel and input information.
- Press the **INFO** or **GUIDE** button two times to display the program title and closed captioning information.
- Press the **INFO** or **GUIDE** button three times to display the program description.

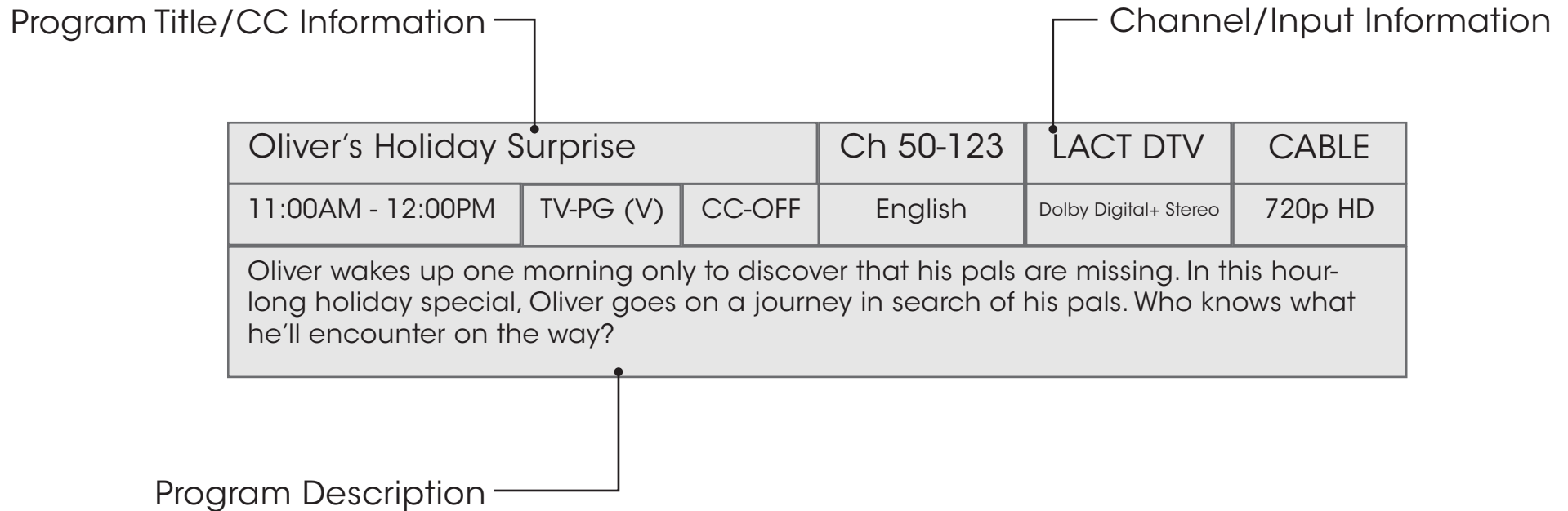

**DIGITAL EPISODE GUIDE & INFO WINDOW**

## USING THE USB MEDIA PLAYER

The USB Media Player allows you to connect a USB thumb drive to your TV and play music or photos.

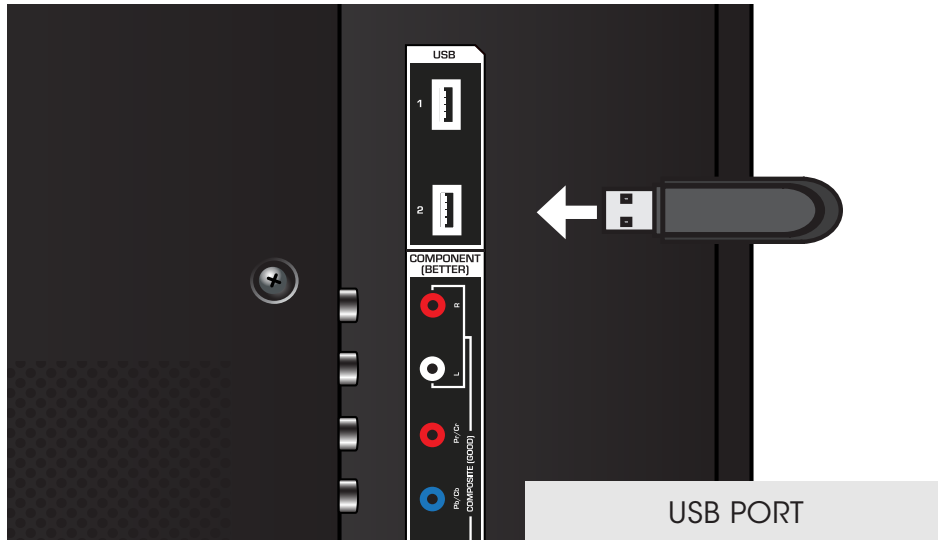

### Connecting a USB Thumb Drive to the TV

1. Turn the TV off. Connect your USB thumb drive to the USB port on the back of the TV.
2. Press the **Power/Standby** button on the remote or touch the **Power** control on the side of the TV to turn it on.



Do not remove the USB thumb drive while the TV is on. Doing so may damage the drive.

### Playing USB Media

To play USB media, you must first save your music or images onto a USB thumb drive.

Remember:

- The USB thumb drive must be formatted as FAT32.
- Files on the USB thumb drive must end in a supported file extension (.mp3, .jpg, etc).
- The player is not designed to play media from external hard drives or mp3 players.

To play your USB media:

1. Connect your USB thumb drive to the USB port on the side of the TV.
2. Highlight the **Multimedia** app by scrolling left and right using the **Left/Right** Arrow buttons on the remote and press **OK**. (The highlighted app is in the center of the dock.)
3. Highlight your USB device in the list and press **OK**.
4. Highlight the type of media you wish to display: **Audio** or **Photo**. Press **OK**.
5. Use the **Arrow** buttons to highlight the file you want to display. Press **OK**. The file plays.



You can display your photos in fullscreen. Select the photo, press OK, then highlight Fullscreen and press OK.

**Connected Sources**  
Displays connected USB devices. To change source, highlight it and press **OK**.

**Back Button**  
Highlight this button and press **OK** if you would like to return to the previous screen.

**Current Folder**  
Displays the folder path.

**Folder Contents**  
This area displays the contents of the currently selected folder. You can browse between files using the **Arrow** and **OK** buttons on the remote.

**Current Folder**  
root

**Start Fullscreen Slideshow**  
Start Slideshow

**Sort by Name**  
Sort: Name A-Z

**View Thumbnails/List**  
View: Thumbnails

**View Folder Settings**  
Settings

**Photo Information**  
Displays name, resolution, and file size for currently selected photo.  
File Name: D 1920x1080  
Resolution: 1920x1080  
Size: 1607270KB

**Page Information**  
If your USB thumb drive has more files than can be displayed on a single screen, you can move between pages by highlighting this area and pressing **Left/Right Arrow**.  
Page 1 of 1

**Photo Viewer**



**Back Button**  
Highlight this button and press **OK** if you would like to return to the previous screen.

**Connected Sources**  
Displays connected USB devices.

**Current Folder**

**Playback Controls**  
Use to control audio playback. Highlight Play/Pause, Previous, or Next and press **OK**.

**Toggle Music/Photos**

**Sort by Album/Artist/Track**

**View All or View Folders**

**Now Playing Information**  
Displays song title, album title, and artist name.

**Progress Bar**  
Displays the duration of the currently-playing song. The blue bar will lengthen as the song progresses.

**Album Art**  
If included on the USB thumb drive and associated with your music, the album art will display here.

**Folder Contents/Playlist**  
This area displays the contents of the currently selected folder. You can browse between files using the **Arrow** and **OK** buttons on the remote.

**Page Information**  
If your USB thumb drive has more files than can be displayed on a single screen, the page information is displayed here.

**VIZIO**  
Music  
USB1: MyFlashDrive

Fab Apple Dream  
On January Mix Comp  
By Oliver

-5:50 8:46

My Music

#	Track	Album	Artist	Duration
1	Seminal Summer	January Mix Comp	JCheesy	2:42
2	Downspin	January Mix Comp	JCheesy	6:20
3	Fab Apple Dream	January Mix Comp	Oliver	8:46
4	Man of the Year	January Mix Comp	The Dash	4:21
5	Maximal Smooth	January Mix Comp	Rio Steve	7:58

Page 1 of 1

**MUSIC PLAYER (E500d-A0)**

**Back Button**

Highlight this button and press **OK** if you would like to return to the previous screen.

**Connected Sources**

Displays connected USB devices.

**Current Folder****Sort by Date****View All or View Folders**

The screenshot shows the VIZIO interface with the following elements:

- Top Bar:** VIZIO logo, a back button, and the current path: Video.
- Left Panel:** Shows 'USB1: MyFlashDrive' and a folder icon labeled 'My Videos'.
- Right Panel:** Shows the path 'MyFlashDrive\Video\root\My Videos' and a table of video files.
- Bottom Left:** 'Sort: Date New-Old' and 'View: Folders' buttons.
- Bottom Right:** 'Page 1 of 1' information.

#	File	Date	Duration
1	Family Vacation - California	-	00:23:43
2	26th Birthday Party	-	00:38:18
3	Summer 2012	-	00:41:08
4	Greatest Trip Ever	-	00:05:32

**Folder Contents/ Playlist**

This area displays the contents of the currently selected folder. You can browse between files using the **Arrow** and **OK** buttons on the remote.

**Page Information**

If your USB thumb drive has more files than can be displayed on a single screen, the page information is displayed here.

VIZIO Internet Apps (VIA) delivers popular online content to your TV. VIA features a selection of Apps that allow you to watch movies and TV shows, listen to music, get weather and news information, and more—all on demand!



A high-speed internet connection is required to receive product updates and to access online content.

See *Using the Network Connection Menu* on page 24 if your TV is not yet connected to your home network.

## USING THE VIA DOCK

The VIA Dock is where all of your VIA Apps are accessed.

To use the VIA Dock and launch an App:

1. Press the **V Button** on the remote.
2. Highlight a VIA App by scrolling left and right using the **Left/Right Arrow** buttons on the remote. (The highlighted App is in the center of the dock.)
3. Launch a VIA App by highlighting it and pressing the **OK** button on the remote.



## Using the Hot Keys

Use the following colored buttons on the remote to perform common VIA tasks:

- **Blue** - Change the size of the main display window when an App is open in the sidebar.
- **Red** - Exit from an open App or to close the App Dock.
- **Green** - View settings for an open App.



## HOW THEATER 3D WORKS

Because our eyes have space between them, when we look around, we see two slightly different pictures. We never notice, because we are able to combine these pictures into one three-dimensional image.

The VIZIO Theater 3D HDTV takes advantage of this phenomenon to create a stunning 3D image. When displaying 3D content, the 3D HDTV actually displays two separate images at the same time—one for each eye.

Because Theater 3D glasses only allow each eye to see its intended image, your brain is able to process the picture in the same way as any other object you see. The final result is a stunning, life-like 3D picture.

## WHAT YOU NEED TO VIEW 3D CONTENT

To view 3D content, you will need:

- VIZIO Theater 3D HDTV
- VIZIO Theater 3D Glasses
- 3D-Ready Player + Media
- 3D-Ready HDMI cable (sold separately)



VIZIO Theater  
3D Glasses



3D-ready Player + Media\*  
(Blu-ray™, Game  
Console, etc.)



3D-ready  
HDMI cable\*

### YOU WILL NEED

## WATCHING BLU-RAY 3D CONTENT

To view Blu-ray 3D content:

1. Ensure you have the following equipment:
  - VIZIO Theater 3D HDTV
  - 3D Blu-ray™ player with a Blu-ray 3D™ disc (sold separately)
  - VIZIO Theater 3D Glasses
  - 3D-Ready HDMI cable (sold separately)
2. Ensure the 3D Blu-ray player and your TV are connected with the 3D-Ready HDMI cable.
3. Turn the 3D Blu-ray player off. Press the **Power/Standby** button on the remote to turn the TV on.
4. Press the **INPUT** button on the remote and select the input to which the Blu-ray player is connected (HDMI-1, HDMI-2, etc).
5. Turn the 3D Blu-ray player on. Insert the Blu-ray 3D disc into the player.
6. When the disc is loaded, select the **Play Movie** option in the disc's main menu.
7. The TV displays, "3D Content detected. Select YES to switch to 3D, NO to display in 2D." Highlight **Yes** and press **OK**.
8. Put on your Theater 3D glasses and enjoy the movie!

## GETTING THE BEST 3D PICTURE

For the best 3D viewing experience, VIZIO recommends that you install the TV with the **viewing distance** and **viewing angle** in mind. When viewing 3D content, it is important that you view the TV **straight-on**, or some of the 3D effect may be lost.

For your TV, VIZIO recommends:

	M601d-A3	M701d-A3	M801d-A3
Viewing Range:	7-10 feet	8-12 feet	9-14 feet
Optimal Distance:	8 feet	9 feet	10 feet



Illustrations in this section are not drawn to scale. They are for instructional purposes only.

### Incorrect 3D Viewing Distance and Angle

In the example below, two of the viewers are sitting too close to the TV for a good 3D effect. In addition, the child on the floor is not seeing the best possible picture because he/she is looking up at the TV.

The viewers in the example below are not seeing the best 3D picture.

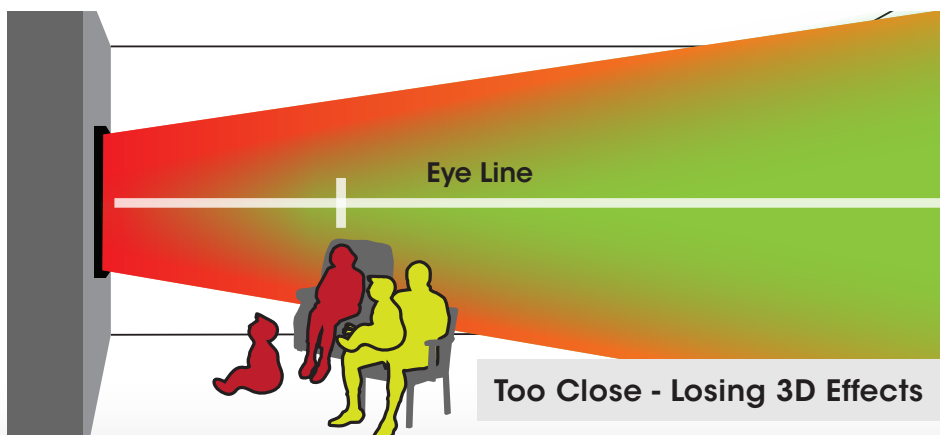

### Correct 3D Viewing Distance and Angle

In the examples below, all of the viewers are experiencing the best possible 3D picture quality.

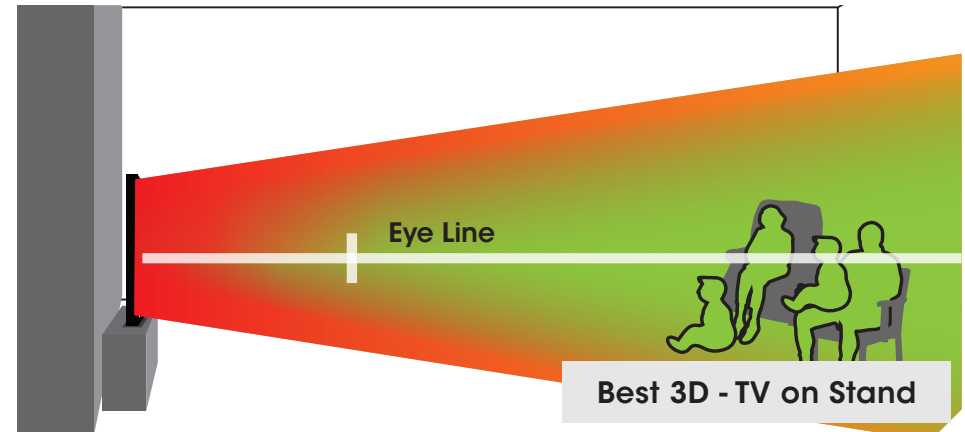

In this example, the viewers are sitting at a good distance. They are viewing the TV straight-on, close to the ideal eye line. They will experience good 3D quality.

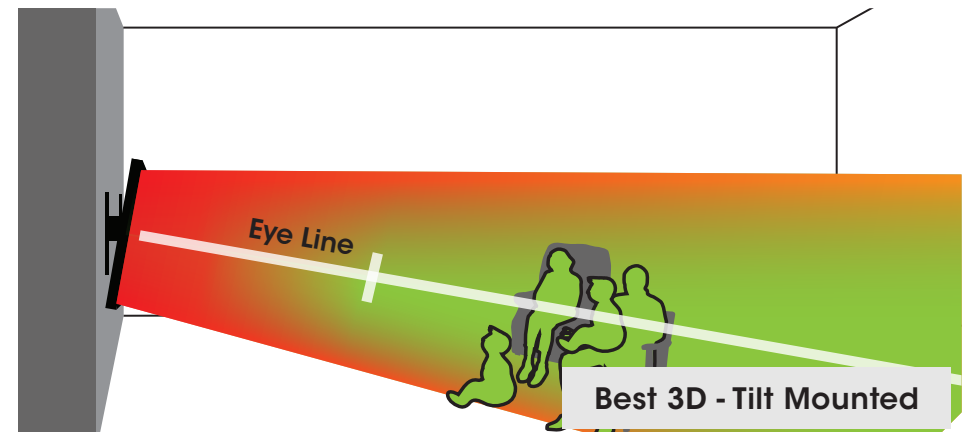

In this example, the viewers have mounted the TV on a **Tilt Mount**. They are at the correct distance and they are viewing the TV straight-on, close to the ideal eye line. They will experience good 3D picture quality.

DO YOU HAVE QUESTIONS?  
**LET US HELP!**

YOUR PRODUCT INCLUDES FREE LIFETIME TECH SUPPORT

The VIZIO support team is highly trained and is based in the United States.

We can help with:

- New Product Setup
- Connecting Your Devices
- Technical Problems
- And More

Phone: (877) 878-4946 (TOLL-FREE)

Email: [techsupport@VIZIO.com](mailto:techsupport@VIZIO.com)

Web: [www.VIZIO.com/support](http://www.VIZIO.com/support)

Hours of operation:

Monday - Friday: 5 AM TO 9 PM (PST)

Saturday - Sunday: 8 AM TO 4 PM (PST)

We speak English • Se habla Español • Nous parlons Français

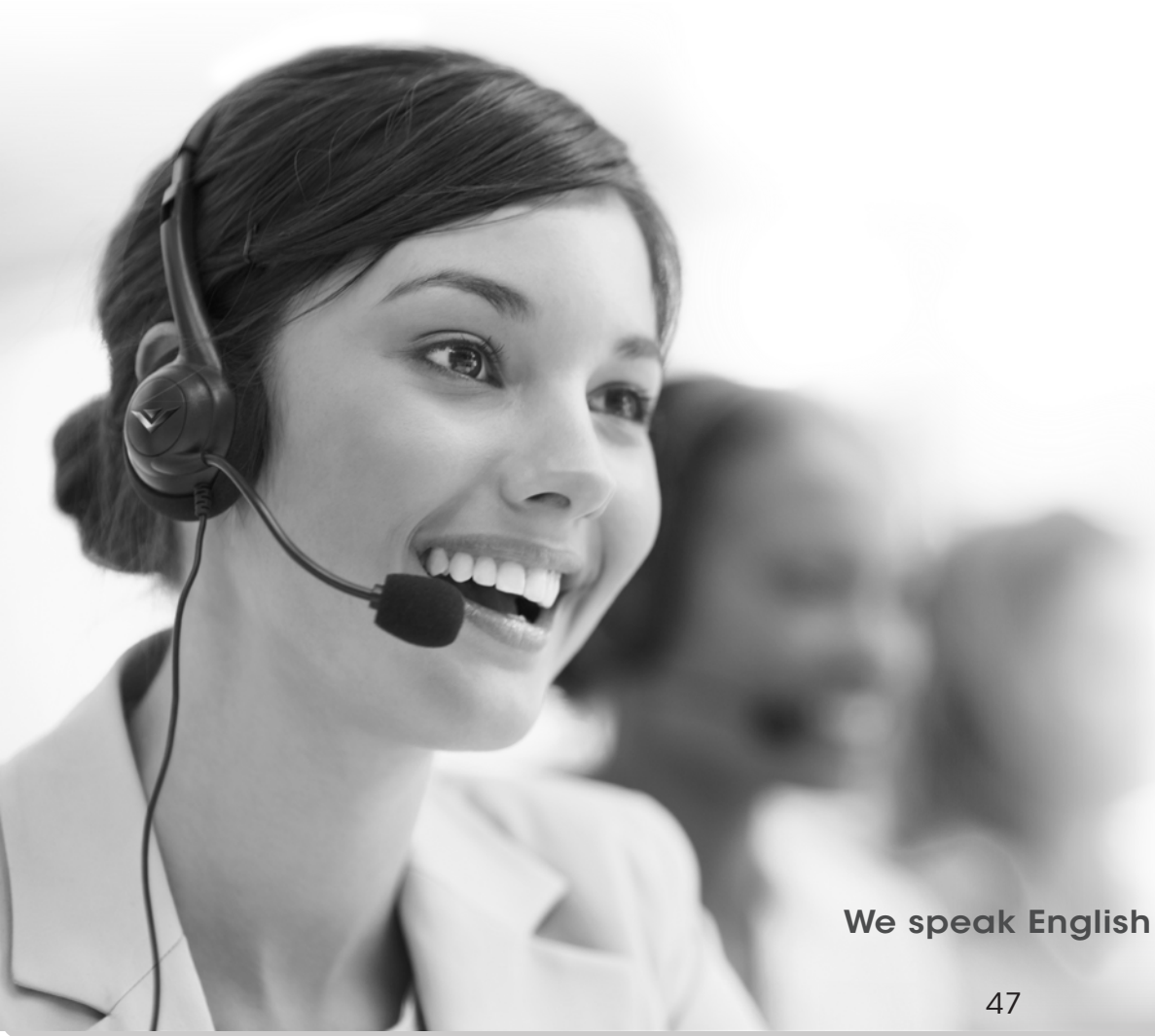

**The TV displays “No Signal.”**

- Press the **INPUT** button on the remote control to select a different input source.
- If you are using cable TV, satellite, or antenna connected directly to the TV, scan for channels. See *Enabling or Disabling Program Ratings on page 33*.

**There is no power.**

- Ensure the TV is plugged into a working electrical outlet.
- Ensure the power cable is securely attached to the TV.
- Press the **Power/Standby** button on the remote or on the side of the TV to turn the TV on.

**The power is on, but there is no image on the screen.**

- Ensure all cables are securely attached to the TV.
- Ensure all devices are connected correctly. Devices differ; see your device’s user manual for details.
- Adjust Brightness, Contrast, or Backlight. See *Adjusting the Picture Settings on page 19*.
- Press the **INPUT** button on the remote to select a different input source.

**There is no sound.**

- Press **Volume Up** on the remote control.
- Press the **MUTE** button on the remote to ensure mute is off.
- Check the audio settings. See *Adjusting the Audio Settings on page 22*.
- Ensure the speakers are set to On.
- Ensure no headphones are connected to the TV.
- Check the audio connections of external devices (Blu-ray player, game console, cable/satellite box) that are connected to the TV.
- If you are using an antenna, the signal strength of the channel may be low. Ensure your antenna is connected securely to the TV and move the antenna around the room or close to a window for the best signal.

**The colors on the TV don’t look right.**

- Adjust the Color and Tint settings in the Picture menu. See *Adjusting the Picture Settings on page 19*.
- Reset the picture settings. See *Resetting the Picture Settings on page 21*.
- Check all cables to ensure they are securely attached.

**The buttons on the remote aren’t working.**

- Ensure you are only pressing one button at a time.
- Point the remote directly at the TV when pressing a button.
- Replace the remote batteries with new ones. See *Replacing the Batteries on page 9*.

**The image quality is not good.**

- For the best image quality, view high-definition programs using digital sources. Connect your devices with HDMI cables.
- If you are using an antenna, the signal strength of the channel may be low. Ensure your antenna is connected securely to the TV and move the antenna around the room or close to a window for the best signal.

**The picture is distorted.**

- Nearby electrical devices may be interfering with the TV. Separate the TV from electrical appliances, cars, or fluorescent lights.
- Ensure all cables are securely attached.

**The display image does not cover the entire screen.**

- If you are using TV, AV1, AV2, or Component with 480i input, press the  button on the remote to change the screen mode.

**The TV has pixels (dots) that are always dark or always lit.**

- Your HDTV is precision-manufactured using an extremely high level of technology. However, sometimes pixels may not display correctly. These types of occurrences are inherent to this type of product and do not constitute a defective product.

**I see “noise” or static on the screen.**

- When your TV’s digital capabilities exceed a digital broadcast signal, the signal is up-converted (improved) to match your TV’s display capabilities. This up-converting can sometimes cause irregularities in the image.
- If you are using an antenna, the signal strength of the channel may be low. Ensure your antenna is connected securely to the TV and move the antenna around the room or close to a window for the best signal.

**When I change input source, the volume changes.**

- The TV remembers the volume level on each input source. If the volume level on the new input source is higher or lower than the level on the source you switch from, the difference may be noticeable.
- Use the **Volume Up/Down** buttons on the remote to adjust the volume.

**When I change input source, the display image changes size.**

- The TV remembers the viewing mode on each input source. If the viewing mode on the new input source differs from the one on the input source you switch from, the difference may be noticeable.
- See *Changing the Input Source* on page 18.



	M601d-A3	M701d-A3	M801d-A3
<b>Screen Size:</b>	60"	70"	80"
<b>Viewable Area:</b>	60.04"	69.51"	80.01"
<b>Dimensions w/ Stand:</b>	53.64" x 33.56" x 10.40"	61.96" x 37.98" x 11.30"	71.21" x 43.43" x 12.80"
<b>w/o Stand:</b>	53.64" x 30.90" x 2.22"	61.96" x 35.69" x 2.32"	71.21" x 41.10" x 2.62"
<b>Weight w/ Stand:</b>	70.55 lbs	97.00 lbs	134.48 lbs
<b>w/o Stand:</b>	63.93 lbs	85.98 lbs	113.98 lbs
<b>TV Type:</b>	LED	LED	LED
<b>Refresh Rate:</b>	240 Hz with Backlight Scanning	240 Hz with Backlight Scanning	240 Hz with Backlight Scanning
<b>Maximum Resolution:</b>	1920 x 1080	1920 x 1080	1920 x 1080
<b>Pixel Pitch:</b>	.692 mm (H) x .692 mm (V)	.802 mm (H) x .802 mm (V)	.923 mm (H) x .923 mm (V)
<b>Response Time:</b>	4 ms	4ms	4ms
<b>Brightness 2D Mode:</b>	350 nits	350 nits	350 nits
<b>Brightness 3D Mode:</b>	130 nits	130 nits	130 nits
<b>Viewing Angle:</b>	178° (H) / 178° (V)	178° (H) / 178° (V)	176° (H) / 176° (V)
<b>HDMI Inputs:</b>	4	4	4
<b>Component Video Inputs:</b>	1	1	1
<b>Composite Inputs:</b>	1 (Shared with Component)	1 (Shared with Component)	1 (Shared with Component)
<b>RF Antenna Input:</b>	1	1	1
<b>USB 2.0 Ports:</b>	2	2	2

	M601d-A3	M701d-A3	M801d-A3
<b>Ethernet:</b>	1	1	1
<b>Audio Outputs:</b>	RCA Analog Stereo Output, Optical Digital	RCA Analog Stereo Output, Optical Digital	RCA Analog Stereo Output, Optical Digital
<b>OSD Language:</b>	English, Spanish, French	English, Spanish, French	English, Spanish, French
<b>Ambient Light Sensor:</b>	Yes	Yes	Yes
<b>Remote Control Model:</b>	XRT510	XRT510	XRT510
<b>Certifications:</b>	UL, CUL, FCC Class B, HDMI 1.4, Dolby Digital Plus	UL, CUL, FCC Class B, HDMI 1.4, Dolby Digital Plus	UL, CUL, FCC Class B, HDMI 1.4, Dolby Digital Plus
<b>Compliance:</b>	Energy Star	Energy Star	Energy Star
<b>Voltage Range:</b>	120V @ 50/60 Hz	120V @ 50/60 Hz	130V @ 50/60 Hz
<b>Power Consumption:</b>	93.2W	102W	106.4W
<b>Standby Power:</b>	<1W	<1W	<1W
<b>Zero Bright Pixel Guarantee:</b>	Yes	Yes	Yes

## ON PARTS AND LABOR

Covers units purchased as new in United States and Puerto Rico Only. VIZIO provides a warranty to the original purchaser of a new Product against defects in materials and workmanship for a period of one (1) year of non-commercial usage and ninety (90) days of commercial use. If a Product covered by this warranty is determined to be defective within the warranty period, VIZIO will either repair or replace the Product at its sole option and discretion.

To obtain warranty service, contact VIZIO Technical Support via e-mail: TechSupport@VIZIO.com or via phone at 877 MY VIZIO (877.698.4946) from 5:00AM to 9:00PM Monday through Friday and 8:00AM to 4:00PM Saturday and Sunday, Pacific Time, or visit [www.VIZIO.com](http://www.VIZIO.com). PRE-AUTHORIZATION MUST BE OBTAINED BEFORE SENDING ANY PRODUCT TO A VIZIO SERVICE CENTER. Proof of purchase in the form of a purchase receipt or copy thereof is required to show that a Product is within the warranty period.

## Parts and Labor

There will be no charge for parts or labor during the warranty period. Replacement parts and Products may be new or recertified at VIZIO's option and sole discretion. Replacement parts and Products are warranted for the remaining portion of the original warranty or for ninety (90) days from warranty service or replacement, whichever is greater.

## Type of Service

Defective Products must be sent to a VIZIO service center to obtain warranty service. VIZIO is not responsible for transportation costs to the service center, but VIZIO will cover return shipping to the customer. PRE-AUTHORIZATION IS REQUIRED BEFORE SENDING ANY PRODUCT TO A VIZIO SERVICE CENTER FOR WARRANTY SERVICE.

Product returns to VIZIO's service centers must utilize either the original carton box and shipping material or packaging that affords an equal degree of protection. VIZIO Technical Support will provide instructions for packing and shipping the covered Product to the VIZIO service center.

## Limitations and Exclusions

VIZIO's one-year limited warranty only covers defects in materials and workmanship. This warranty does not cover, for example: cosmetic damage, normal wear and tear, improper operation, improper voltage supply or power surges, signal issues, damages from shipping, acts of God, any type of customer misuse, modifications or adjustments, as well as installation and set-up issues or any repairs attempted by anyone

other than by a VIZIO authorized service center. Products with unreadable or removed serial numbers, or requiring routine maintenance are not covered. This one year limited warranty does not cover Products sold "AS IS", "FACTORY RECERTIFIED", or by a non-authorized reseller.

THERE ARE NO EXPRESS WARRANTIES OTHER THAN THOSE LISTED OR DESCRIBED ABOVE. ANY IMPLIED WARRANTIES, INCLUDING ANY IMPLIED WARRANTY OF MERCHANTABILITY AND FITNESS FOR A PARTICULAR PURPOSE, SHALL BE LIMITED IN DURATION TO THE PERIOD OF TIME SET FORTH ABOVE. VIZIO'S TOTAL LIABILITY FOR ANY AND ALL LOSSES AND DAMAGES RESULTING FROM ANY CAUSE WHATSOEVER INCLUDING VIZIO'S NEGLIGENCE, ALLEGED DAMAGE, OR DEFECTIVE GOODS, WHETHER SUCH DEFECTS ARE DISCOVERABLE OR LATENT, SHALL IN NO EVENT EXCEED THE PURCHASE PRICE OF THE PRODUCT. VIZIO SHALL NOT BE RESPONSIBLE FOR LOSS OF USE, LOSS OF INFORMATION OR DATA, COMMERCIAL LOSS, LOST REVENUE OR LOST PROFITS, OR OTHER INCIDENTAL OR CONSEQUENTIAL DAMAGES. SOME STATES DO NOT ALLOW LIMITATIONS ON HOW LONG AN IMPLIED WARRANTY LASTS OR THE EXCLUSION OF INCIDENTAL OR CONSEQUENTIAL DAMAGES, SO THE ABOVE LIMITATIONS OR EXCLUSIONS MAY NOT APPLY TO YOU. THIS WARRANTY GIVES YOU SPECIFIC LEGAL RIGHTS, AND YOU MAY ALSO HAVE OTHER RIGHTS, WHICH VARY FROM STATE TO STATE. THIS WARRANTY IS SUBJECT TO CHANGE WITHOUT NOTICE. CHECK [WWW.VIZIO.COM](http://WWW.VIZIO.COM) FOR THE MOST CURRENT VERSION.

## Personal Data

If your VIZIO product is capable of storing personal data and other information, ALL CONTENTS AND INFORMATION WILL BE DELETED IN THE COURSE OF SOME IN-HOME AND ALL SHIP-IN WARRANTY SERVICE. If this occurs, your product will be restored to you configured as originally purchased. You will be responsible for restoring all applicable data and passwords. Recovery and reinstallation of user data is not covered under this Limited Warranty. In order to protect your personal information, VIZIO recommends that you always clear all personal information from the unit before it is serviced, regardless of the servicer.

## Zero Bright Pixel Defect Guarantee

This policy covers "zero bright pixel" defects for the duration of the limited "ONE YEAR WARRANTY" on select new product purchases. To determine if this guarantee applies to your product, refer to the "DETAILS" tab of the model's product information page ([www.VIZIO.com](http://www.VIZIO.com)) or look for the "zero bright pixel" guarantee on the box.

## FCC Class B Radio Interference Statement

NOTE: This equipment has been tested and found to comply with the limits for a Class B digital device, pursuant to Part 15 of the FCC Rules. These limits are designed to provide reasonable protection against harmful interference in a residential installation. This equipment generates, uses and can radiate radio frequency energy, and if not installed and used in accordance with the instructions, may cause harmful interference to radio communications. However, there is no guarantee that interference will not occur in a particular installation. If this equipment does cause harmful interference to radio or television reception, which can be determined by turning the equipment off and on, the user is encouraged to try to correct the interference by one or more of the following measures:

1. Reorient or relocate the receiving antenna.
2. Increase the separation between the equipment and receiver.
3. Connect the equipment into an outlet on a circuit different from that to which the receiver is connected.
4. Consult the dealer or an experienced radio/TV technician for help.

This device complies with Part 15 of the FCC Rules. Operation is subject to the following two conditions: (1) this device may not cause harmful interference, and (2) this device must accept any interference received, including interference that may cause undesired operation.

## Notice

1. The changes or modifications not expressly approved by the party responsible for compliance could void the user's authority to operate the equipment.
2. Shielded interface cables and AC power cord, if any, must be used in order to comply with the emission limits.
3. The manufacturer is not responsible for any radio or TV interference caused by unauthorized modification to this equipment. It is the responsibilities of the user to correct such interference.

## FCC warning

Changes or modifications not expressly approved by the party responsible for compliance with the FCC Rules could void the user's authority to operate this equipment.

## Caution

Always use an AC/DC power adapter that is properly grounded. Use the AC cords listed below for each area.

**USA:** UL

**Canada:** CSA

**Germany:** VDE

**UK:** BASE/BS

**Japan:** Electric Appliance Control Act

## Open Source Software Notice

Your VIA device may contain GPL executables and LGPL libraries that are subject to the PL2.0/LGPL2.1 License Agreements. VIZIO offers to provide source code to you on CD-ROM for a processing fee covering the cost of performing such distribution, such as the cost of media, shipping and handling upon request made to VIZIO at [www.VIZIO.com](http://www.VIZIO.com).

This offer is valid for a period of three (3) years from the date of the distribution of this VIA device by VIZIO.

You can obtain a copy of the GPL, LGPL licenses from:

<http://www.gnu.org/licenses/old-licenses/gpl-2.0.html>

and

<http://www.gnu.org/licenses/oldlicenses/lgpl-2.1.html>

You can also obtain a copy of gSOAP public license from:

<http://www.cs.fsu.edu/~engelen/license.html>

Please visit [www.VIZIO.com](http://www.VIZIO.com) for attribution of copyrights to any open source software on your VIZIO VIA device.

Permission is hereby granted, free of charge, to any person obtaining a copy of any such software and associated documentation files (the "Open Source Software"), to deal in the Open Source Software without restriction, including without limitation the rights to use, copy, modify, merge, publish, distribute, sublicense, and/or sell copies of the Open Source Software, and to permit persons to whom the Open Source Software is furnished to do so, subject to the following conditions:

THE SOFTWARE IS PROVIDED "AS IS", WITHOUT WARRANTY OF ANY KIND, EXPRESS OR IMPLIED, INCLUDING BUT NOT LIMITED TO THE WARRANTIES OF MERCHANTABILITY, FITNESS FOR A PARTICULAR PURPOSE AND NONINFRINGEMENT. IN NO EVENT SHALL THE AUTHORS OR COPYRIGHT HOLDERS BE LIABLE FOR ANY CLAIM, DAMAGES OR OTHER LIABILITY, WHETHER IN AN ACTION OF CONTRACT, TORT OR OTHERWISE, ARISING FROM, OUT OF OR IN CONNECTION WITH THE SOFTWARE OR THE USE OR OTHER DEALINGS IN THE SOFTWARE.

### VIZIO Internet Applications Disclaimer

VIZIO Internet Applications (“VIA”) affords the opportunity to access third party Internet product offerings or services (“VIA Services”) on certain VIZIO TVs. The VIA Services accessible herein are provided as per our agreement with these third parties. These agreements are subject to change, interruption, suspension (including termination) at any time and for various reasons. VIZIO makes no warranties or representations that any particular VIA Service will be accessible, available, function in any particular manner or function at all.

To use these VIA Services, you must obtain access to the Internet, either directly or through devices that access the Internet and pay any service fees associated with such access. In addition, you must provide all equipment necessary to make such connection to the Internet including a modem or other Internet access device.

VIZIO or said third parties providing VIA Services reserve the right to delete data from their servers, or prevent access to their servers or to change data categories, product offerings or service levels for any reason that VIZIO or said third parties deem sufficient in their sole discretion at any time, without notice. Some or all of the data or functionality of VIA Services may require additional payment by you. However, in no event will you be charged for any VIA Services unless those charges are made available to you in advance. VIZIO makes no warranties or representations of any kind as to the accuracy, currency, or completeness of any information contained on the data servers of such third party providers of any VIA Services. Furthermore, we do not review, control, or endorse the content, products or services of VIA Services or their data servers.

Your rights to use the widget links to access VIA Services is governed by the VIZIO Internet Applications Software License Agreement (“VIA Software License Agreement”), the terms of which are available in your Product Guide, all of which are incorporated herein by this reference. In the event of a conflict between this VIZIO Internet Applications Disclaimer and the VIA Software License Agreement, the VIA Software License Agreement shall control.

### VIZIO INTERNET APPLICATIONS SOFTWARE LICENSE AGREEMENT

THE FOLLOWING AGREEMENT EXPLAINS HOW YOU MAY USE THE VIZIO INTERNET APPLICATIONS (“VIA”) TO ACCESS THIRD PARTY INTERNET PRODUCT OFFERINGS AND SERVICES (“VIA SERVICES”) AND THE VIZIO SOFTWARE INSTALLED ON YOUR VIZIO HD TV. BY USING THE VIZIO INTERNET APPLICATIONS, YOU CONSENT AND AGREE TO BE BOUND BY ALL OF THE TERMS AND CONDITIONS BELOW AND YOU MAY, SUBJECT TO THOSE TERMS AND CONDITIONS, USE THE VIZIO SOFTWARE AND ACCESS THE VIA SERVICES.

### VIZIO SOFTWARE LICENSE AGREEMENT

The following terms and conditions govern the use of any software on your VIZIO HD TV:

1. General. The software, documentation and any fonts accompanying this License Agreement whether on disk, in read only memory, on any other media or in any other form (collectively the “VIZIO Software”) are licensed, not sold, to you by VIZIO, Inc. (“VIZIO”) for use only under the terms of this License Agreement, and VIZIO reserves all rights not expressly granted to you. The rights granted herein are limited to VIZIO’s and its third party licensors’ intellectual property rights in the VIZIO Software and do not include any other patents or intellectual property rights. You own the media on which the VIZIO Software is recorded or resides but VIZIO and/or its licensor(s) retain ownership of the VIZIO Software itself. The terms of this License Agreement will govern any software upgrades provided or made available by or through VIZIO that replace and/or supplement the original VIZIO Software, unless such upgrade is accompanied by a separate license in which case the terms of that license will govern.

2. Permitted Uses and Restrictions. This License Agreement allows you to use the VIZIO Software and, through functions solely found within the VIZIO HD TV, this Agreement also allows you to install upgrades thereto. The VIZIO Software may be used to access VIA Services and view materials so long as such use is limited to materials in which you are authorized or legally permitted to view. You may not make the VIZIO Software or VIA Services available over a network or where it could be used by multiple televisions at the same time. Except as and only to the extent expressly permitted in this License Agreement or by applicable law, you may not copy, decompile, reverse engineer, disassemble, modify, or create derivative works of the VIZIO Software or any part thereof. **THE VIZIO SOFTWARE AND VIA SERVICES ARE NOT INTENDED FOR USE IN ANY EQUIPMENT OR ENVIRONMENT IN WHICH THE FAILURE OF THE VIZIO SOFTWARE OR VIA SERVICES COULD LEAD TO DEATH, PERSONAL INJURY, OR SEVERE PHYSICAL OR ENVIRONMENTAL DAMAGE.**

3. Transfer. You may not rent, lease, lend, redistribute or sublicense the VIZIO Software or access to the VIA Services. You may, however, make a one-time permanent transfer of all of your license rights to the VIZIO Software to another party, provided that: (a) the transfer must include the VIZIO HD TV, including all its component parts, original media, printed materials and this License Agreement; (b) you do not retain any copies of the VIZIO Software, full or partial, including copies stored on a computer or other storage device; and (c) the party receiving the VIZIO HD TV and VIZIO Software reads and agrees to accept the terms and conditions of this License Agreement.

4. Consent to Use of Collected Data. You agree that VIZIO and its third party providers of VIA Services may collect and use technical, non-technical and

related information, including but not limited to information about your use of the VIZIO Software, the VIA Services, content viewed and attached peripherals, products or services purchased, that is gathered periodically to facilitate the provision of software updates, product support and other services to you, including additional or different VIA Services related to the VIZIO Software and to verify compliance with the terms of this License Agreement. VIZIO and its third party providers of VIA Services and/or other providers may use this information, as long as it is in a form that does not personally identify you, to improve our products or to provide services or technologies to you.

5. VIA Services and other Services. The VIZIO software affords the opportunity to access third party Internet product offerings or services ("VIA Services"). The VIA Services accessible herein are provided as per our agreement with certain third parties. These agreements are subject to change, interruption, suspension, removal (including termination) at any time and for various reasons. Moreover, VIZIO or its third party providers of VIA Services reserve the right to delete data from their servers, or prevent access to their servers or to change data categories, product offerings or service levels for any reason that VIZIO or said third parties deem sufficient in their sole discretion at any time, without notice. VIZIO may also impose additional or different limits on the use of or access to certain VIA Services, in any case and without notice or liability. VIZIO makes no warranties or representations that any particular VIA Service will be accessible, available, function in any particular manner or function at all.

Use of the VIA Services may require you to accept additional terms of service or end user license agreements which will be presented to you before you can use such Services. Some or all of the data, functionality of VIA Services may require additional payment by you. However, in no event will you be charged for any VIA Services unless those charges are made available to you in advance.

6. Disclaimer as to Content on VIA Services. Certain VIA Services may include materials from third parties or links to certain third party data servers. You acknowledge and agree that VIZIO is not responsible for examining or evaluating the content or accuracy of any VIA Services, their data servers or related third-party materials. VIZIO does not warrant or endorse and does not assume and will not have any liability or responsibility for any third-party materials or websites, or for any other materials, products, or services of third parties. Links to VIA Services and any associated links to other data servers are provided solely as a convenience to you. To the extent provided, content types or descriptions of VIA Services provided for convenience, and you acknowledge and agree that VIZIO does not guarantee their accuracy. You understand that by using any of the VIA Services, you may encounter content that may be deemed offensive,

indecent, or objectionable, which content may or may not be identified as having explicit language. Nevertheless, you agree to use the VIA Services at your sole risk and that VIZIO shall have no liability to you for content that may be found to be offensive, indecent, or objectionable.

You agree that you will not use any third-party materials in a manner that would infringe or violate the rights of any other party, and that VIZIO is not in any way responsible for any such use by you.

7. Internet Access Required. To use these VIA Services, you must obtain access to the Internet, either directly or through devices that access the Internet and pay any service fees associated with such access. In addition, you must provide all equipment necessary to make such connection to the Internet including a modem or other Internet access device.

8. Upgrades, Support. VIZIO or its third party providers may elect, but shall be under no obligation, to provide you with customer support and/or software upgrades, enhancements, or modifications to the VIZIO Software or VIA Services (collectively, "Support"), in its sole discretion, and may terminate such Support at any time without notice to you. VIZIO and its third party providers reserve the right to charge you for any Support it provides but will make a schedule of those charges available to you prior to your incurring any costs.

9. Termination. This License is effective until terminated. Your rights under this License will terminate automatically without notice from VIZIO if you fail to comply with any term(s) of this License Agreement. Upon the termination of this License Agreement, you shall cease all use of the VIZIO Software and VIA Services.

10. Limited Warranty on VIZIO Media. VIZIO warrants the media on which the VIZIO Software is recorded and delivered by VIZIO to be free from defects in materials and workmanship under normal use for a period of ninety (90) days from the date of original retail purchase. Your exclusive remedy under this Section shall be, at VIZIO's option, a refund of the purchase price of the product containing the VIZIO Software or replacement of the VIZIO Software which is returned to VIZIO or a VIZIO authorized representative with a copy of the receipt. THIS LIMITED WARRANTY AND ANY IMPLIED WARRANTIES ON THE MEDIA INCLUDING, BUT NOT LIMITED TO, THE IMPLIED WARRANTIES OF MERCHANTABILITY, OF SATISFACTORY QUALITY, AND OF FITNESS FOR A PARTICULAR PURPOSE, ARE LIMITED IN DURATION TO NINETY (90) DAYS FROM THE DATE OF ORIGINAL RETAIL PURCHASE. SOME JURISDICTIONS DO NOT ALLOW LIMITATIONS ON HOW LONG AN IMPLIED WARRANTY LASTS, SO THE ABOVE LIMITATION MAY NOT APPLY TO YOU. THE LIMITED WARRANTY SET FORTH HEREIN IS THE ONLY WARRANTY MADE TO YOU AND IS PROVIDED IN LIEU OF ANY OTHER WARRANTIES (IF ANY) CREATED BY ANY DOCUMENTATION OR PACKAGING. THIS LIMITED WARRANTY GIVES YOU SPECIFIC LEGAL RIGHTS,

AND YOU MAY ALSO HAVE OTHER RIGHTS WHICH VARY BY JURISDICTION.

11. Disclaimer of Warranties. YOU EXPRESSLY ACKNOWLEDGE AND AGREE THAT USE OF THE VIZIO SOFTWARE AND VIA SERVICES (AS DEFINED ABOVE) IS AT YOUR SOLE RISK AND THAT THE ENTIRE RISK AS TO SATISFACTORY QUALITY, PERFORMANCE, ACCURACY AND EFFORT IS WITH YOU. EXCEPT FOR THE LIMITED WARRANTY ON MEDIA SET FORTH ABOVE AND TO THE MAXIMUM EXTENT PERMITTED BY APPLICABLE LAW, THE VIZIO SOFTWARE AND VIA SERVICES ARE PROVIDED "AS IS", WITH ALL FAULTS AND WITHOUT WARRANTY OF ANY KIND, AND VIZIO AND VIZIO'S THIRD PARTY PROVIDERS OF VIA SERVICES AND THIRD PARTY LICENSORS (COLLECTIVELY REFERRED TO AS "VIZIO" FOR THE PURPOSES OF SECTIONS 10 AND 11) HEREBY DISCLAIM ALL WARRANTIES AND CONDITIONS WITH RESPECT TO THE VIZIO SOFTWARE AND SERVICES, EITHER EXPRESS, IMPLIED OR STATUTORY, INCLUDING, BUT NOT LIMITED TO, THE IMPLIED WARRANTIES AND/OR CONDITIONS OF MERCHANTABILITY, OF SATISFACTORY QUALITY, OF FITNESS FOR A PARTICULAR PURPOSE, OF ACCURACY, OF QUIET ENJOYMENT, AND NON-INFRINGEMENT OF THIRD PARTY RIGHTS. VIZIO DOES NOT WARRANT AGAINST INTERFERENCE WITH YOUR ENJOYMENT OF THE VIZIO SOFTWARE OR VIA SERVICES, THAT THE FUNCTIONS CONTAINED IN THE VIZIO SOFTWARE OR VIA SERVICES WILL MEET YOUR REQUIREMENTS, THAT THE OPERATION OF THE VIZIO SOFTWARE OR VIA SERVICES WILL BE UNINTERRUPTED OR ERROR-FREE, OR THAT DEFECTS IN THE VIZIO SOFTWARE OR VIA SERVICES WILL BE CORRECTED. NO ORAL OR WRITTEN INFORMATION OR ADVICE GIVEN BY VIZIO OR A VIZIO AUTHORIZED REPRESENTATIVE SHALL CREATE A WARRANTY. SHOULD THE VIA SOFTWARE OR VIA SERVICES PROVE DEFECTIVE, YOU ASSUME THE ENTIRE COST OF ALL NECESSARY SERVICING, REPAIR OR CORRECTION. SOME JURISDICTIONS DO NOT ALLOW THE EXCLUSION OF IMPLIED WARRANTIES OR LIMITATIONS ON APPLICABLE STATUTORY RIGHTS OF A CONSUMER, SO THE ABOVE EXCLUSION AND LIMITATIONS MAY NOT APPLY TO YOU.

12. Limitation of Liability. TO THE EXTENT NOT PROHIBITED BY LAW, IN NO EVENT SHALL VIZIO BE LIABLE FOR PERSONAL INJURY, OR ANY INCIDENTAL, SPECIAL, INDIRECT OR CONSEQUENTIAL DAMAGES WHATSOEVER, INCLUDING, WITHOUT LIMITATION, DAMAGES FOR LOSS OF PROFITS, LOSS OF DATA, BUSINESS INTERRUPTION OR ANY OTHER COMMERCIAL DAMAGES OR LOSSES, ARISING OUT OF OR RELATED TO YOUR USE OR INABILITY TO USE THE VIZIO SOFTWARE OR VIA SERVICES, HOWEVER CAUSED, REGARDLESS OF THE THEORY OF LIABILITY (CONTRACT, TORT OR OTHERWISE) AND EVEN IF VIZIO HAS BEEN ADVISED OF THE POSSIBILITY OF SUCH DAMAGES. SOME JURISDICTIONS DO NOT ALLOW THE LIMITATION OF LIABILITY FOR PERSONAL INJURY, OR OF INCIDENTAL OR CONSEQUENTIAL DAMAGES, SO THIS LIMITATION MAY NOT APPLY TO YOU. In no event shall VIZIO's total liability to you for all damages (other than as may be required by applicable law in cases involving personal injury) exceed the amount of twenty five dollars (\$25.00). The foregoing limitations will apply even if the above stated remedy fails of its essential purpose.

13. Export Control. You may not use or otherwise export or re-export the VIZIO Software except as authorized by United States law and the laws of the jurisdiction in which the VIZIO Software was obtained. In particular, but without limitation, the VIZIO Software may not be exported or re-exported (a) into any U.S. embargoed countries or (b) to anyone on the U.S. Treasury Department's list of Specially Designated Nationals or the U.S. Department of Commerce Denied Person's List or Entity List. By using the VIZIO Software, you represent and warrant that you are not located in any such country or on any such list. You also agree that you will not use these products for any purposes prohibited by United States law, including, without limitation, the development, design, manufacture or production of missiles, or nuclear, chemical or biological weapons.

14. Controlling Law and Severability. This License Agreement will be governed by and construed in accordance with the laws of the State of California, as applied to agreements entered into and to be performed entirely within California between California residents. This License Agreement shall not be governed by the United Nations Convention on Contracts for the International Sale of Goods, the application of which is expressly excluded. If for any reason a court of competent jurisdiction finds any provision, or portion thereof, to be unenforceable, the remainder of this License Agreement shall continue in full force and effect.

15. Complete Agreement; Governing Language. This License Agreement constitutes the entire agreement between the parties with respect to the use of the VIZIO Software licensed hereunder and supersedes all prior or contemporaneous understandings regarding such subject matter, with the exception of any additional terms and conditions you are required to accept if you choose to access VIA Services which will govern your use of such VIA Services. No amendment to or modification of this License Agreement will be binding unless in writing and signed by VIZIO. Any translation of this License Agreement is done for local requirements and in the event of a dispute between the English and any non-English versions, the English version of this License Agreement shall govern.

#### Other

Image(s) used under license from Shutterstock.com

