



USER'S MANUAL
MANUEL DE L'UTILISATEUR
MANUAL DEL USUARIO

VR-5525Z

Contents

IMPORTANT SAFETY

INSTRUCTION2

PREFACE4

SAFETY PRECAUTIONS4

Headphone Warning..... 6

Where to install 6

Mount the TV stand7

Unit and Accessories8

Front View 8

Side View 8

Rear View 9

Supplied Accessories 9

Remote Control.....10

Quick Installation Tips..... 12

Using the Remote Control Unit..... 13

Installing Batteries in the Remote Control Unit..... 14

Connections15

Connecting the Antenna or Cable 16

Connecting external devices 18

Initial Setup.....22

Source Menu27

Main Menu27

Main Menu Description.....28

Menu Settings.....30

1. Picture menu 30

Picture Settings.....30

Screen Size.....31

PC Settings.....32

Color Temperature33

Advanced Picture Settings.....33

2. Sound menu 34

Sound Settings.....34

Surround Mode.....35

AVL.....35

Analog Sound35

Digital Sound35

Digital Audio Output.....35

Equalizer Settings.....36

3. Channel menu..... 37

Channel List.....37

Favourite List.....38

Channel Settings38

Signal Type.....39

4. Parental Control menu..... 40

Lock Parental Control.....40

V-CHIP.....40

Change Password.....44

Keypad Lock.....44

Source Lock.....44

5. Setup menu 45

Closed Caption.....45

Digital CC Style.....46

Menu Language.....46

Clock.....47

6. Others menu..... 48

Blue Back48

No Signal Power Off.....48

No Operation Power Off.....48

All Reset48

Simple Troubleshooting.....49

Technical Specifications50

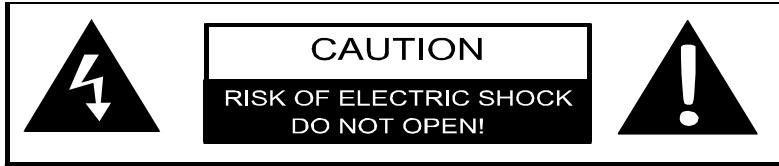

The lightning flash with arrowhead symbol, within an equilateral triangle, is intended to alert the user to the presence of un-insulated dangerous voltage within the products enclosure that may be of sufficient magnitude to constitute a risk of electric to persons.



The exclamation point within an equilateral triangle is intended to alert the user to the presence of important operating and maintenance (servicing) instruction the literature accompanying the appliance.

CAUTION: USE OF ANY CONTROLS, ADJUSTMENTS, OR PROCEDURES OTHER THAN THOSE SPECIFIED HEREIN MAY RESULT IN HAZARDOUS RADIATION EXPOSURE.

CAUTION: These servicing instructions are for use by qualified service personnel only. To reduce the risk of electric shock, do not perform any servicing other than that contained in the operating. Refer to service manual for servicing instructions.

IMPORTANT SAFETY INSTRUCTION

Note:

1. Read these instructions.
2. Keep these instructions.
3. Heed all warnings.
4. Follow all instructions.
5. Do not use near water.
6. Clean only with dry cloth.
7. Do not block any ventilation openings. Install in accordance with the manufacturer's instruction.

8. Do not install near any heat sources such as radiators, heat registers, stoves, or other apparatus (including amplifiers) that produce heat.
9. Do not defeat the safety purpose of the polarized or grounding-type plug. A polarized plug has two blades with one wider than the other. A grounding type plug has two blades and a third grounding prong. The wide blade or the third prong are provided for your safety. If the provided plug does not fit into your outlet, consult an electrician for replacement of the obsolete outlet.
10. Protect the power cord from being walked on or pinched particularly at plugs, convenience receptacles, and the point where they exit from the apparatus.
11. Only use attachments / accessories specified by the manufacturer.
12. Use only with the cart, stand, tripod, bracket, or table specified by the manufacturer, or sold with the apparatus. When a cart is used, use caution when moving the cart / apparatus combination to avoid injury from tip-over.



13. Unplug this apparatus during lightning storms or when unused for long periods of time.
14. Refer all servicing to qualified service personnel. Servicing is required when the apparatus has been damaged in any way, such as power-supply cord or plug is damaged, liquid has been spilled or objects have fallen into the apparatus, the apparatus has been exposed to rain or moisture, does not operate normally, or has been dropped.
15. Apparatus shall not be exposed to dripping or splashing and that no objects filled with liquids, such as vases, shall be placed on the apparatus.
16. **WARNING:** To reduce the risk of fire or electric shock, do not expose this apparatus to rain or moisture.
17. Mains plug or appliance coupler is used as the disconnect device, shall be readily operable.
18. The apparatus shall be connected to MAINS socket outlet with a protective earthing connection.

PREFACE

Thank you for buying this TV! Please read this manual thoroughly before operating the TV. Make sure the TV was not damaged in transit. Should the TV be damaged, do not install it and contact your dealer. Check that you have all the accessories according to the model.

SAFETY PRECAUTIONS



- Put the TV on a stable surface.

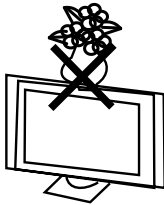

- Do not place any material on the TV.

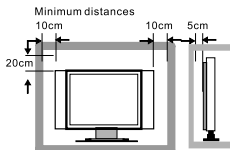

- Do not use the TV with fixtures other than those provided or suggested by the manufacturer.

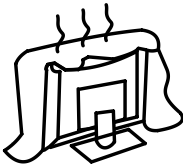

- Do not block or cover the ventilation openings on the TV. If you have a wall mount, check that it is steady.



- Power cord and cables must be properly routed and protected to prevent people from stepping on them and causing the TV to fall.

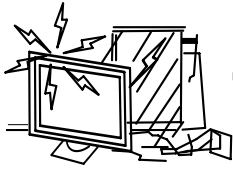

- Keep the TV dry and away from humidity.

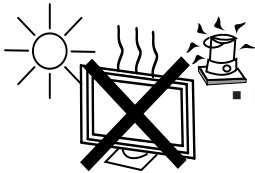

- Keep the TV away from heat sources.

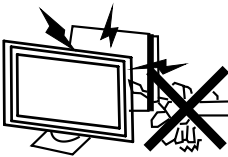

- Unplug the TV before cleaning it. Do not use solvent or liquid to clean the TV.
- Only clean the TV with a soft and dry cloth.

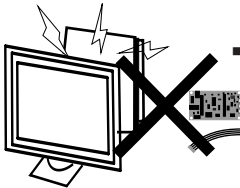

- In case of troubleshooting, do not use spare parts other than those suggested by the manufacturer. Using inadequate spare parts can lead to electric shocks, short-circuits, fire or other incidents.



- Unplug the TV during lightning storms or when unused for long periods of time.

Headphone Warning

Loud music can damage your hearing irreversibly, therefore do not set the volume to a high level when listening through headphones, particularly for lengthy listening periods.

Where to install

Locate the television away from direct sunlight and strong lights, soft indirect lighting is recommended for comfortable viewing. Use curtains or blinds to prevent direct sunlight falling on the screen. Place the TV on a sturdy platform of which the surface should be flat and steady. This will prevent it from falling over.

Make sure the television is located in a position where it cannot be pushed or hit by objects, as pressure will break or damage the screen, and so that small objects cannot be inserted into the ventilation slots or openings in the cabinet.

Mount the TV stand

Before performing work spread cushioning over the base area to lay the TV on, making sure the area is completely flat.

This will prevent it from being damaged.

Before attaching stand, unplug the AC cord from the AC INPUT terminal.

1. Confirm the 6 screws supplied with the TV.



2. Put the TV face down on a safe surface that is covered by a soft and smooth cloth.
3. Insert the stand into the openings on the bottom of the TV.
4. Insert and tighten the 6 screws into the 6 holes on the bottom of the stand.
5. Fasten the screws by using the screwdriver (Not supplied).

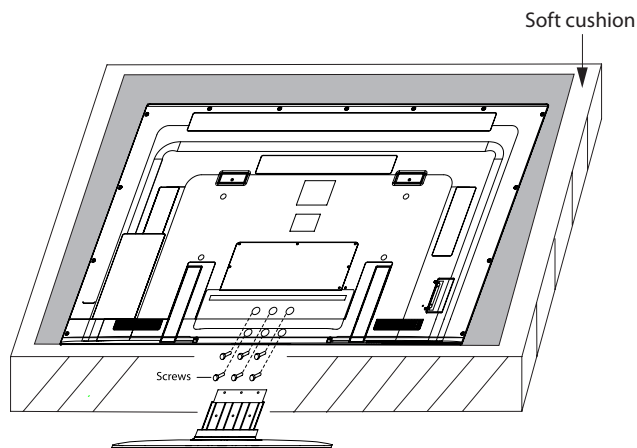

Note:

To detach the TV stand, perform the steps in reverse order.

Unit and Accessories

Front View

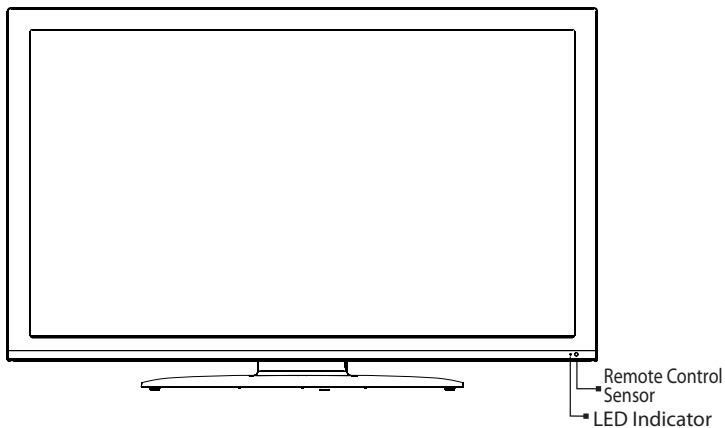

Side View

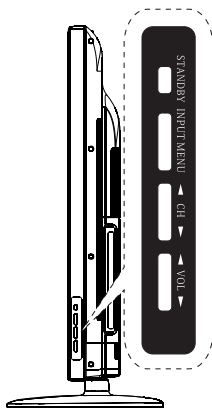

The functions of the TV buttons are described below:

STANDBY: Press to switch on or off the TV.

INPUT: Select a TV input source.

MENU: Press to display the OSD menu, press again to exit the menu.

CH ◀/▶: Press to skip through the channels.

VOL ◀/▶: Press to adjust the volume.

Unit and Accessories (Continued)

Rear View

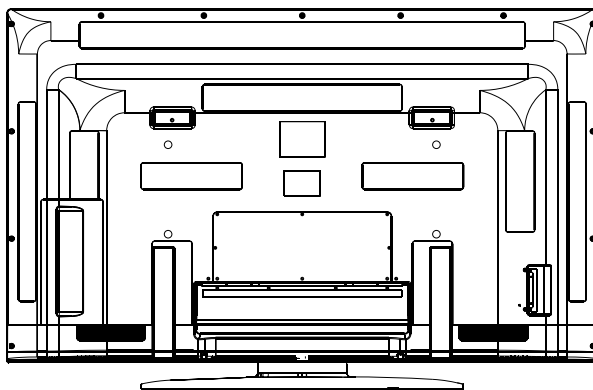

Supplied Accessories

Make sure the following accessories are provided with the product.

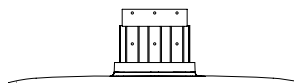
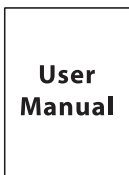
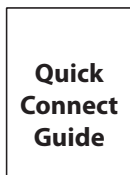
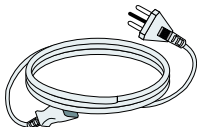



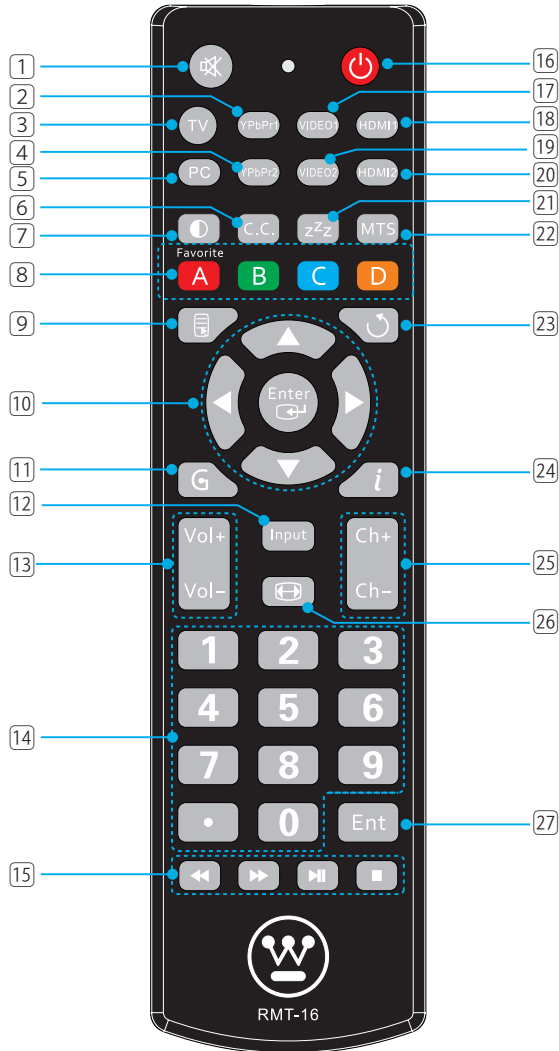

Remote Control

Functions of remote control buttons

Depend on the model of the TV, some keys will have no function.



1. Mute button ()
Mutes or unmutes audio.
2. YPbPr1 button
Quickly switch input to YPbPr 1 source.
3. TV button
Quickly switch input to TV source.
4. YPbPr2 button
Quickly switch input to YPbPr 2 source.
5. PC button
Quickly switch input to PC mode.
6. CC button
Turn on Closed Caption or off.
Available at TV/AV.
7. P Mode button ()
Quickly switch the predetermined picture mode.
Standard/Movie/User/Dynamic.
8. Favorite button
Display favourite channel list.
Colour button
The action they perform is shown on the menu and changes for each menu.
9. Menu button
Press to display the menu.
10. Navigation()
Navigates through the menus.
Enter button
Activates a selection or accesses the menu.
11. Info button (only for DTV)
Press to display the channel information.
12. Input button
Display all source list.
13. Vol+/Vol- button
Adjust speaker volume level.
14. Digit (0~9), Dot buttons
Input the channel number or password. When switch to a digital channel, usually should be followed by Dot button and minor channel number. Enter button to confirm.
15. DVD Control button
Not available for this model.
16. Standby button
Control TV to standby or on.
17. Video1 button
Quickly switch input to Video1 source.
18. HDMI1 button
Quickly switch input to HDMI1 source.
19. Video2 button
Quickly switch input to Video2 source.
20. HDMI2 button
Quickly switch input to HDMI2 source.
21. Sleep button ()
Sets a delay after which the TV switches to standby.
22. MTS button
Switch sound channel. *Mono/Stereo/SAP* when analog channel. *English* and other languages when digital channel.
23. Previous Channel/Return button
Jump to last channel entered by user.
24. Info button
Display information about the TV channel or accessory device.
25. CH +/- button
Switches to the next or previous channel.
26. Aspect button
Press to select Aspect Ratio.
27. Enter button
Confirm a selection.

Quick Installation Tips

1. Attach your antenna to the back of the television.
2. Connect the AC plug for the television into the AC outlet.

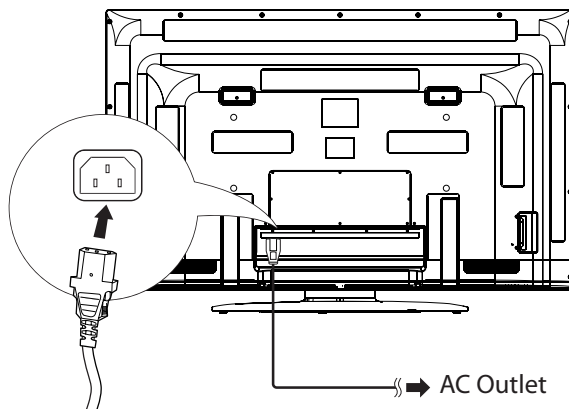

- Place the TV close to the AC outlet, and keep the power plug within reach.
- Connecting it to any other kind of outlet will damage the product and invalidate the warranty.

NOTE:

- **TO PREVENT RISK OF ELECTRIC SHOCK, DO NOT TOUCH UNINSULATED PARTS OF ANY CABLES WITH THE AC CORD CONNECTED.**

3 How to turn on the television for the first time.

A) Press Standby on the television.

B) The power indicator on the front of the television lights up.

Using the Remote Control Unit

Use the remote control unit by pointing it towards the remote control sensor on the TV. Objects between the remote control unit and the remote control sensor may prevent proper operation.

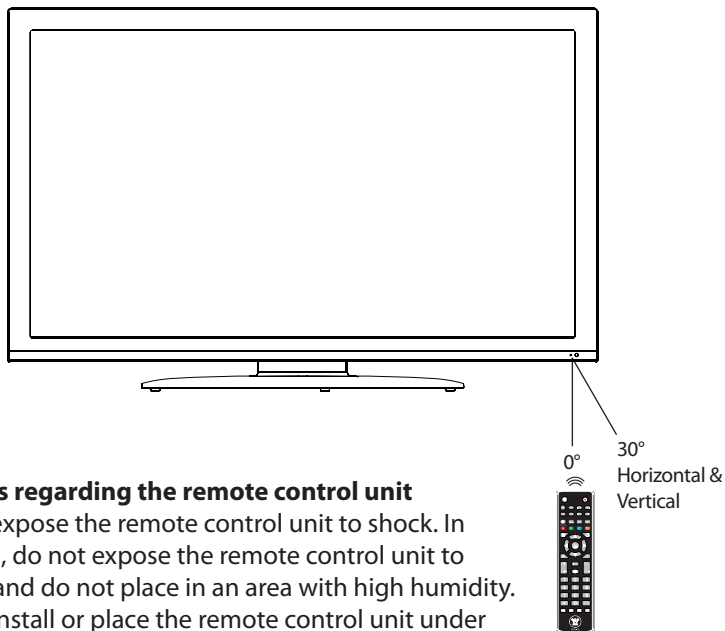

- **Cautions regarding the remote control unit**
- Do not expose the remote control unit to shock. In addition, do not expose the remote control unit to liquids, and do not place in an area with high humidity.
- Do not install or place the remote control unit under direct sunlight. The heat may cause deformation of the remote control unit.
- The remote control unit may not work properly if the remote control sensor on the TV is under direct sunlight or strong lighting. In such cases, change the angle of the lighting or the TV, or operate the remote control unit closer to the remote control sensor.

IMPORTANT:

IF THE UNIT DOES NOT POWER ON - UNPLUG THE TELEVISION FROM THE OUTLET AND REPEAT THE INSTALLATION STEPS.

Installing Batteries in the Remote Control Unit

If the remote control fails to operate TV functions, replace the batteries in the remote control unit.

1. Open the battery cover.
2. Insert two "AA" size batteries (supplied with the product).
 - Place the batteries with their terminals corresponding to the (+) and (-) indications in the battery compartment.
3. Close the battery cover.

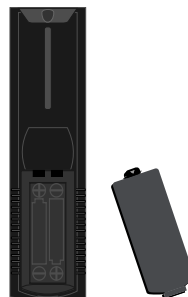

NOTE:

To use the remote control point it at the TV and press the required buttons. You must be within 6 meters and at an angle of less than 30 degrees from the centre of the TV.

CAUTION:

Improper use of batteries can result in chemical leakage or explosion. Be sure to follow the instructions below.

- Do not mix batteries of different types. Different types of batteries have different characteristics.
- Do not mix old and new batteries. Mixing old and new batteries can shorten the life of new batteries or cause chemical leakage in old batteries.
- Remove batteries as soon as they are worn out. Chemicals that leak from batteries come in contact with skin can cause a rash. If you find any chemical leakage, wipe thoroughly with a cloth.
- The batteries supplied with this product may have a shorter life expectancy due to storage conditions.
- If you will not be using the remote control unit for an extended period of time, remove batteries from it.
- The batteries (batteries installed) shall not be exposed to excessive heat such as sunshine, fire or the like.

Connections

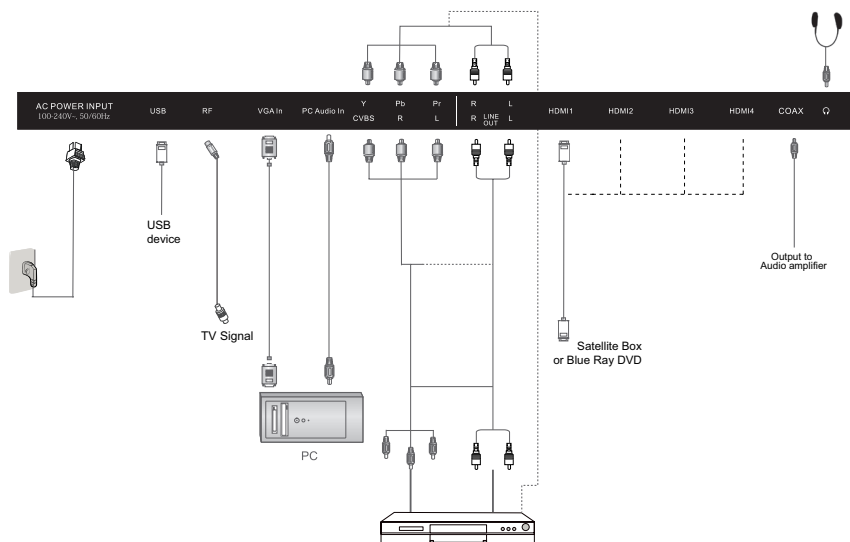
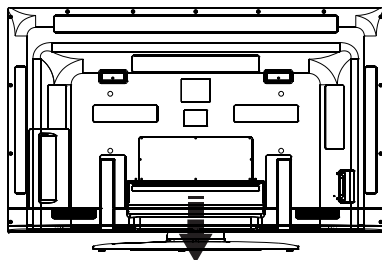

WARNING! ENSURE THE TV AND ALL ANCILLARY EQUIPMENT IS UN-PLUGGED FROM THE MAINS BEFORE MAKING ANY CONNECTIONS!

Connecting the Antenna or Cable

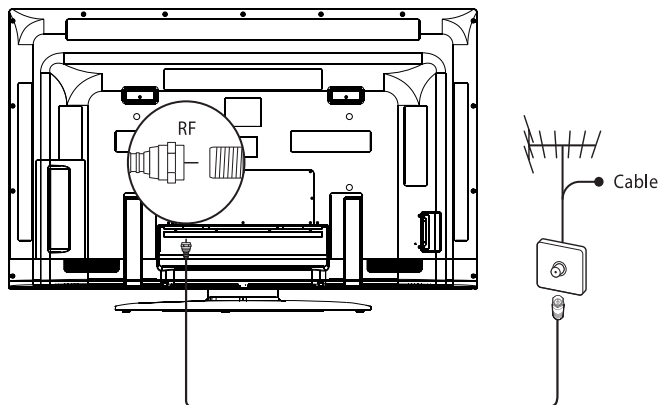

Connect to an antenna

Any DTV programs that are broadcast in your area can be received for free through an antenna connection.

Contact your local content provider or your local electronics retailer if you are unsure about what HDTV programs are available in your area.

Broadcasters are transitioning from analog to digital TV. This means that a given broadcaster can have channels available either in analog or in digital, or both analog and digital at the same time.

The TV produces stereo sound if stereo signal is broadcast.

Connect to a cable

When your TV is connected to the cable socket, you might receive free digital and high definition programs (depending on your cable provider). The channel number for digital and high definition channels includes a dot "." For example, 13.1, 20.30, 121.309. Contact your cable provider for more information.

Connect to a Direct Broadcast Satellite (DBS)

There are two main DBS systems: Direct TV and Dish Network. These systems require a separate, proprietary set-top box to decode signals and send them to the TV. The set-top box contains a digital TV tuner for receiving off-air digital broadcasts.

Contact your local DBS provider for more information about the connections and the TV channels.

Connect to a set-top box

A cable box or satellite set-top box can be connected to the TV through the following connections:

- ANT
- A/V (Composite Video and Audio)
- YPbPr (Component Video Input)
- HDMI

For information about how to connect a set-top box, see the device user manual for details.

Connect to a set-top box through RF IN/OUT

If the TV is connected to a cable box or satellite set-top box via a coaxial connection, set the TV to channel 3 or 4, or to the channel specified by the service provider.

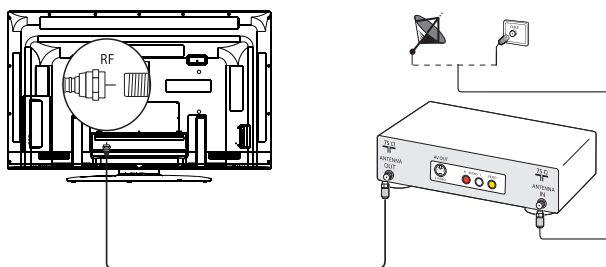

Connect to a set-top box through component video input or HDMI

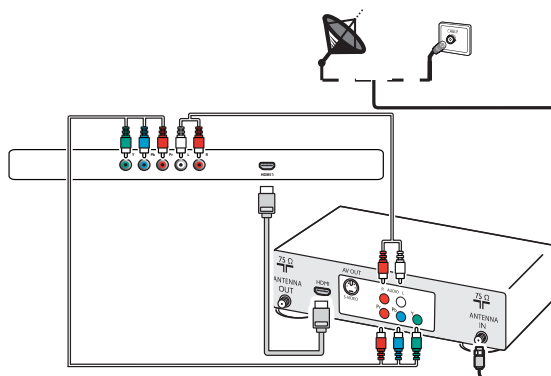

Connecting external devices

This instruction manual shows the simplest and most effective way of connecting your TV to ancillary equipment. Alternate methods are listed below.

HDMI Lead

You can connect this TV to a compatible device using a HDMI lead. This method will give the best picture.

Connect the cable from the HDMI equipment to the TV HDMI socket.

VGA Cable

You can use your TV as a monitor for your personal computer by using a VGA cable. Sound from your personal computer may also be played through the TV.

CONNECTIONS

Name	Function Description
AC POWER IN	Connect to power supply
USB	Connect to USB device for factory use only
RF	Connect to the aerial antenna
VGA	Connect to the PC VGA output to display PC graphics
PC audio in	PC audio input
YPbPr	Connect to the YPbPr output on external devices
(AUDIO)L/R IN	Audio signal input for YPbPr
CVBS	Connect to the video output of external devices
(AUDIO)L/R IN	Audio signal input for AV
LINE OUT	Connect to the sound output of external devices
HDMI 1/2/3/4	Connect to the HDMI socket of your DVD or Satellite Box
COAX	Output to audio amplifier
HEADPHONE	Connect headphone

Caution:

Before connecting external devices:

Make sure to disconnect the appliances from the power supply in order to avoid any potential damage from occurring.

Make sure to establish the required connection.

Make sure that the connectors are properly and correctly attached before connecting the appliances to the power supply.

Connecting external devices (continued)

AV Connection

Connect the VIDEO and AUDIO output jack of the DVD or VCR to the CVBS jacks on the set using the RCA cable. Match the jack colors: Video is yellow, Audio left is white, and the Audio right is red. Select the AV input source using the INPUT button on the remote control.

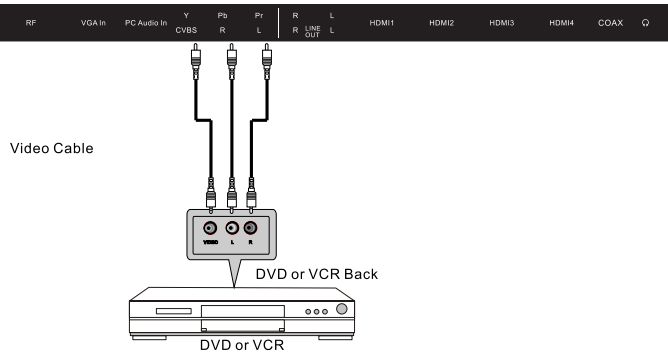

YPbPr (Component) Connection

Connect the YPbPr output of the DVD or VCR to the YPbPr input on the set. The picture quality is improved; compared to connecting a regular VCR to the video input. Connect the Audio output of the DVD or VCR to the Audio input jacks on the set using the RCA cable. Match the jacks colors: Y is green, Pb is blue, Pr is red, Audio left is white and Audio right is red. Select component input source using the INPUT button on the remote control.

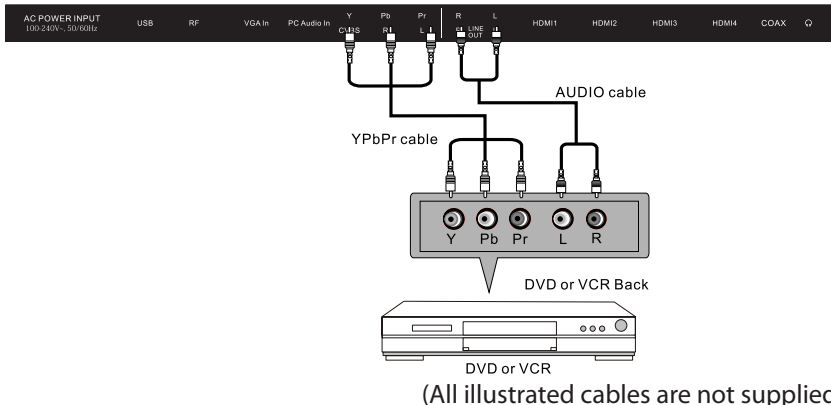

Connecting external devices (continued)

PC(VGA) Connection

Connect the RGB output of the PC to the PC(VGA) jack on the set. Connect the AUDIO output of the PC to the PC AUDIO jack on the set. Select the PC input source with using INPUT button on the remote control.

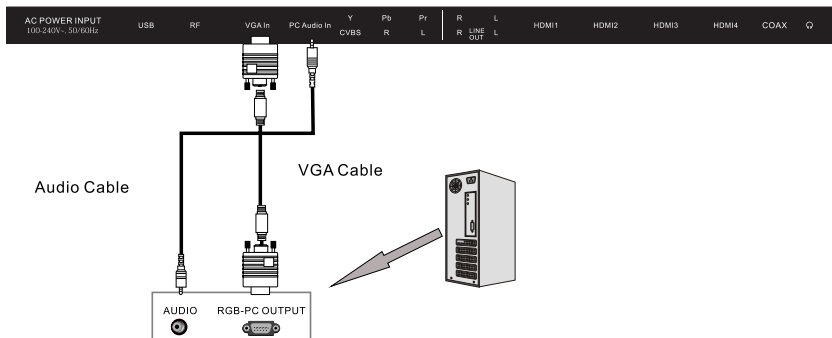

HDMI Connection

HDMI plug which replaces the HDMI connection allows transfer of all audio/video/control signals through one cable only. These signals are transferred in digital.

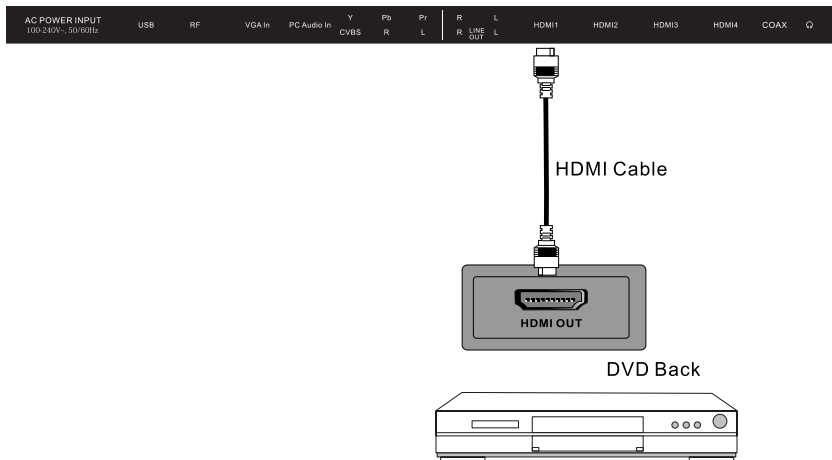

(All illustrated cables are not supplied)

Connecting external devices (continued)

LINE OUT Connection

Connect the LINE OUT (R-AUDIO-L) jacks of the set and your device using the audio cable. You can output TV sound through these jacks.

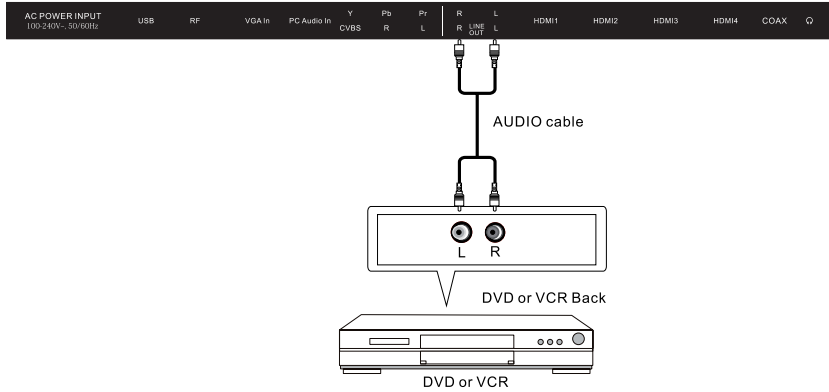

COAX Connection

If your AV amplifier (receiver) has digital decoder and a digital input jack, you can enjoy digital surround effects through this jack.

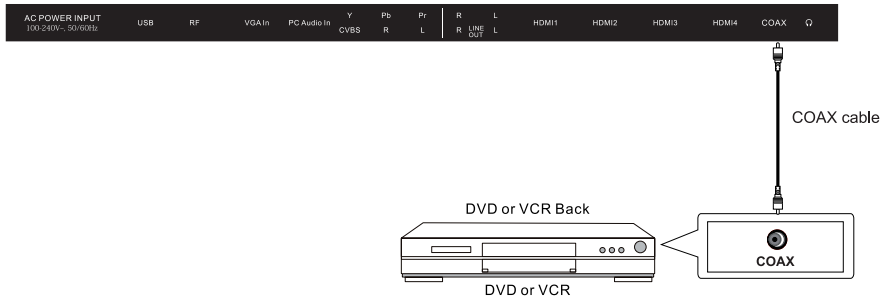

Service Port Function

Service port: (for factory use only.)



(All illustrated cables are not supplied)

Initial Setup

When you turn on the TV for the first time, the Initial Setup will guide you through the setup process. Perform the following steps before you press POWER on the remote control unit.

1. Language setting

The Initial Setup screen display at the first use. Select the OSD menu language from English, French, or Spanish. Press ▲ and ▼ button to select the desired language listed on the screen and then press the ENTER button to the next step.



2. Time Zone setting

Press ▲ and ▼ button to select your current location for time zone, and then press the ENTER button to the next step.

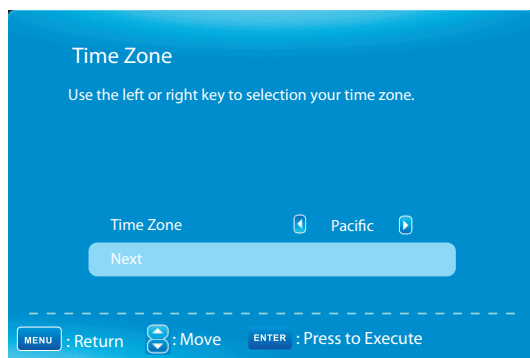

Initial Setup (continued)

3. Location setting

Press ▲ and ▼ button to select “Home” or “Showroom” and press ENTER button to the next step.

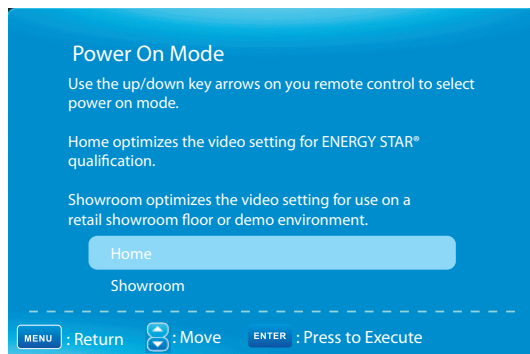

4. Signal select

Press ▲ and ▼ button to select “Cable Box or Satellite Box”, “Game, Blu-Ray DVD or other player” or “Antenna or coaxial cable input” and then press ENTER button to the next step.

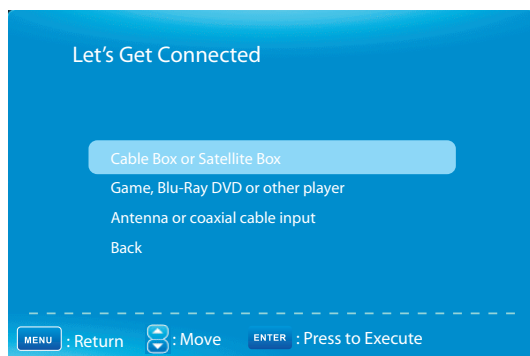

Initial Setup (continued)

5. Cable or Satellite Box Input selection

Make sure what kind of connection is made with your TV when selecting for Source select item.

Press ▲ and ▼ button to select "Next" and then press ENTER button to continue.

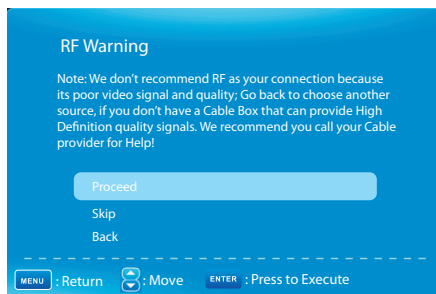
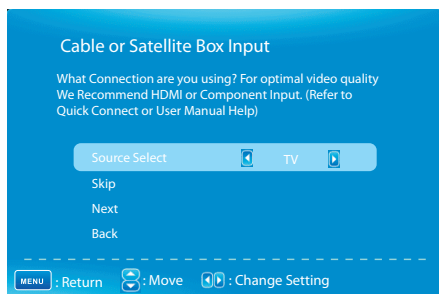

6. Other source select

Press ▲ and ▼ button to select input source and then press ENTER button to the next step.

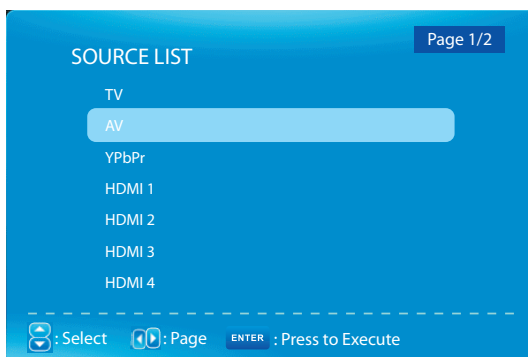

Initial Setup (continued)

7. Channel scan select

Press ▲ and ▼ button to select Antenna [ATSC] or Cable, and then press ENTER button to the next step.

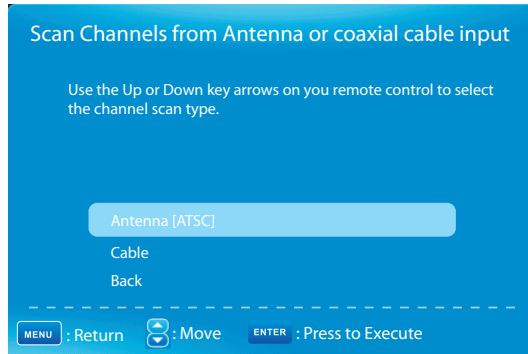

8. ATSC channel access selection

Some of the ATSC channel require the access code.

Press ▲ and ▼ button to select "Next" and then press ENTER button to next step. The 5 digit access code provided by the channel access service.

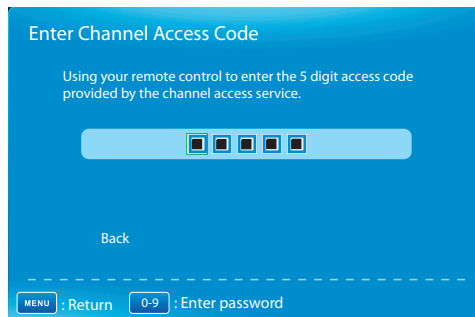
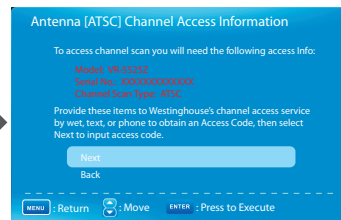
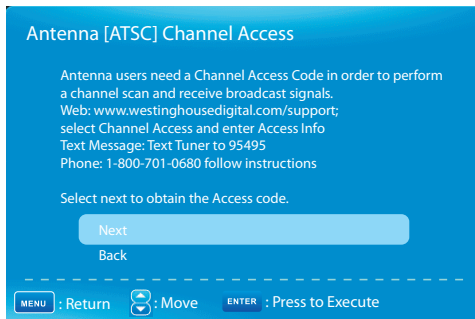

Initial Setup (continued)

9. Auto Channel Search

Highlight and press ENTER button to start the auto searching.

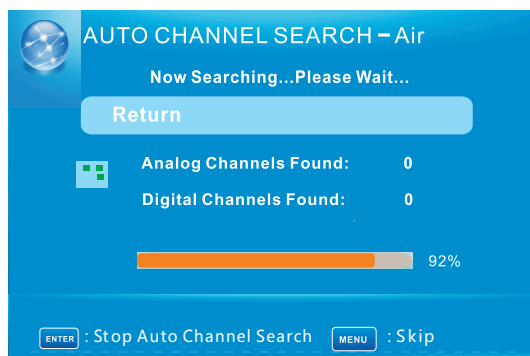

It will search analog channels first, then digital channels.

Before execute auto channel search, please confirm your antenna type is Air or Cable. Wrong setting of Signal Type maybe cause finding no channel. Found numbers do not include encryption programs.

Note:

Auto programming may take about 15 minutes to complete. Please wait until you see the complete message. The TV will then switch automatically to the first channel found.

Source Menu

Press INPUT button to display the input source list.

Press ▲ and ▼ button to select the input source and press ENTER button to confirm.

Source Select
TV
AV
YPbPr
HDMI1
HDMI2
HDMI3
HDMI4
PC

Main Menu



Press MENU button to display the main menu or return to the previous menu or close the main menu. Press ◀ and ▶ button to highlight the desired menu icon, and press ENTER button to select.

If no buttons are pressed, the menu will close automatically after about 10 seconds.

Main Menu Description

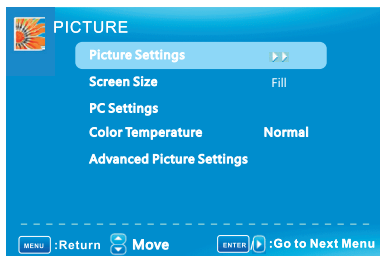

Picture Menu

Adjust your picture settings. The operation are slightly different among different source.

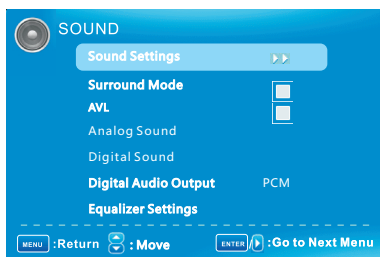

Sound Menu

Adjust the sound settings.

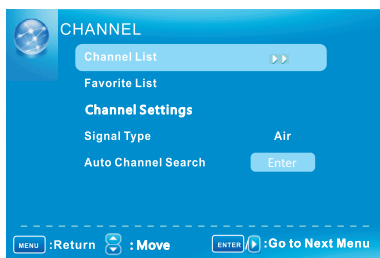

Channel Menu

Customize your channel settings.

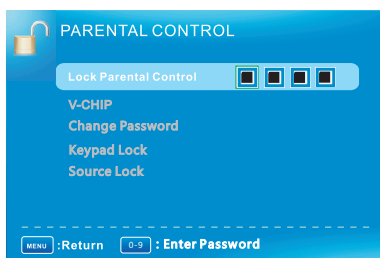

Parental Control Menu

Set program rating control and input source, keypad lock function.

Main Menu Description (Continued)

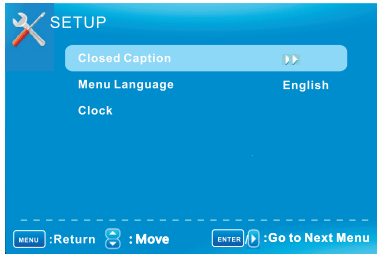

Setup Menu

Select closed caption options, language and time.



Others Menu

Set the OSD blue background, whether auto power off if no signal or no operation, clear all user settings, etc..

Menu Settings

1. Picture menu

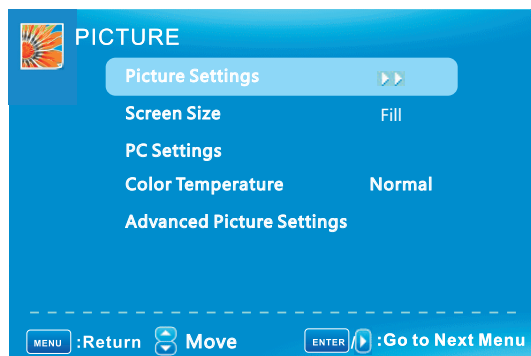

1. Press ▲ and ▼ button to highlight one of the following options, then press ENTER or ► button to enter next sub-menu to adjust it.
2. Press MENU button back to the previous menu.

Picture Settings

Adjust the picture quality including brightness, contrast, color, tint, sharpness.

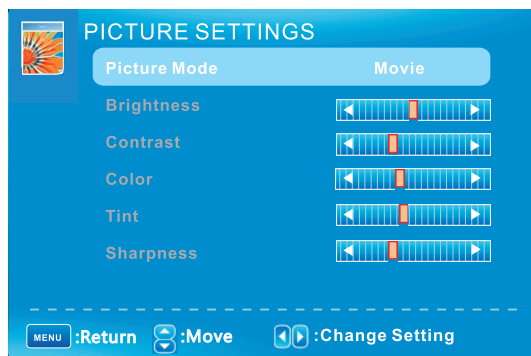

When Picture Mode is set to *User*, the following setting can be manually adjusted.

Press P MODE shortcut button on the remote control to select picture mode directly.

Menu Settings (continued)

Picture Mode

Highlight the item and press ◀ and ▶ button to select "Movie, Dynamic, Standard, or User".

Brightness/Contrast/Color/Tint/Sharpness

Highlight the item and press ▶ button, and a process bar appears, then press ◀ or ▶ button to adjust the value. Tint is available when analog TV or NTSC - system AV. Press MENU button to back the Picture Setting menu.



Screen Size

Press ◀ and ▶ button to select the display aspect ratio till the picture is fit onto the screen. The options are different according to different input source.

PC: *Fill/Standard.*

AV/YPbPr/HDMI/TV: *Fill/Over Scan/Standard.*

Generally each aspect ratio is suitable for one input format.

The item is available only for PC DB15 or PC DVI input mode.

Menu Settings (continued)

PC Settings

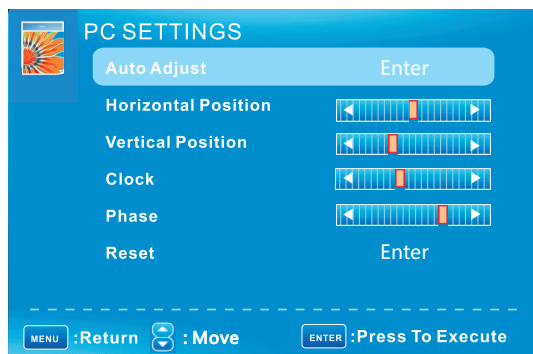

When DVI signal input, only *Horizontal Position* and *Vertical Position* can be adjusted.

Press ▲ and ▼ button to highlight one of the following options, then press ENTER button to select it.

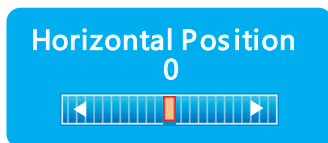

Auto Adjust: Automatically adjust Clock, Phase, H - Position and V - Position settings. In order to get a good result, you should open a “filling the screen” picture before executing *Auto Adjust*.

Horizontal Position: Shift the screen slightly to left or right.

Vertical Position: Shift the screen slightly to up or down.

Clock: Adjust the DB15 picture signal sampling clock rate.

Phase: Adjust the DB15 picture signal sampling phase. It maybe affect the definition. Wrong value maybe result the interference.

Reset: Reset the parameters of current menu to default value.

Menu Settings (continued)

Color Temperature

Press ◀ and ▶ button to select the color temperature that you feel comfortable.

Normal: Basically will be accepted by most people.

Cool: Means a high color temperature that will feel cool.

Warm: Means a low color temperature that will feel warm.

Advanced Picture Settings

The item is some special picture feature.

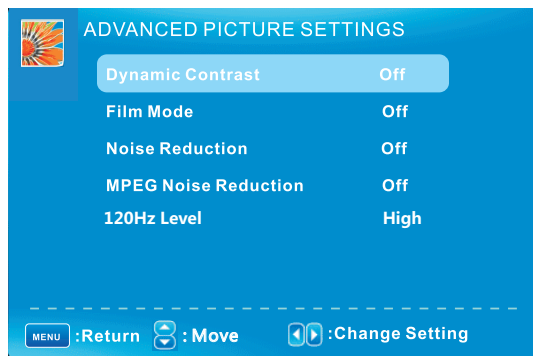

Press ▲ and ▼ button to highlight the item and press ENTER or ▶ button to display the sub-menu as following:

Dynamic Contrast: Off/Low/Medium/High

The system will adjust the luminance curve by analysing the picture content dynamically.

Film Mode: Off/On

For the 2:2 or 3:2 format signal of cinema, enable special pixel process to reduce the flick of moving area.

Noise Reduction: Off/Low/Medium/High

You can clear up analog TV signal by reducing the dot noise. This feature is not available at PC or Media source.

MPEG Noise Reduction: Off/Low/Medium/High

Similar with the Noise Reduction, you can set to reduce the block noise.

120Hz Level: Off/Low/Medium/High

Menu Settings (continued)

2. Sound menu

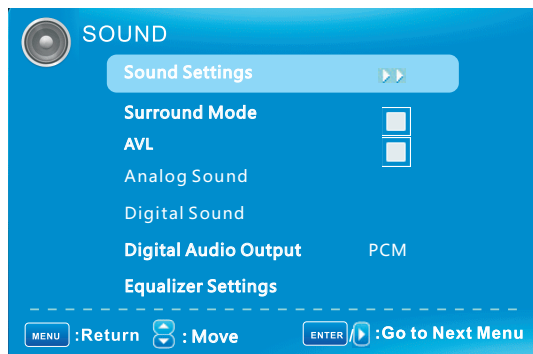

1. Press ▲ and ▼ button to highlight one of the following options, then press ENTER or ► button to enter next sub-menu to adjust it.
2. Press MENU button back to the previous menu.

Sound Settings

Set the sound mode, and Bass/Treble/Balance.

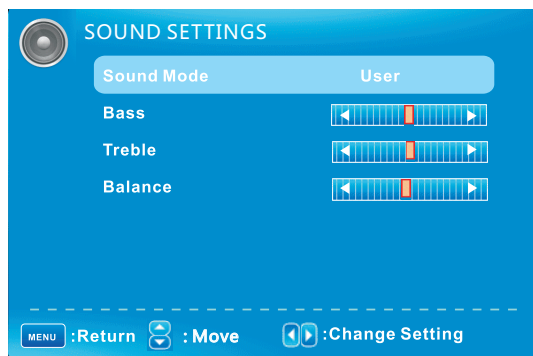

Sound Mode: Standard/Dynamic/Soft/User

Only in User mode, the follow items can be adjusted.

Bass: Adjust the low frequency band response.

Treble: Adjust the high frequency band response.

Balance: Adjust the level of sound coming from the left or right speaker.

Menu Settings (continued)

Adjust the Bass/Treble/Balance

1. Set Sound Mode to User.
2. Highlight the item and press ◀ and ▶ button to display the sub-menu, then press ◀ and ▶ button to adjust the value.

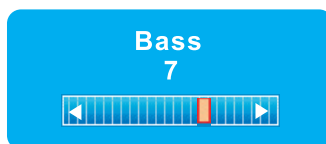

Surround Mode

Set to enjoy the virtual surround sound. Press ENTER button to set or cancel.

AVL

Auto Volume Level. Press ENTER button to set or cancel. When AVL is set on, it will limit the sound being heard when sudden changes in volume occur during commercial breaks or channel changes. Usually be enabled at night.

Analog Sound

Available at analog TV channels. *SAP/Stereo/Mono*

Set the preferred sound track of analog channels. Stereo and SAP exist on some channels. Generally SAP is a second language sound or help the people with hearing impair.

Digital Sound

Available at digital TV channels. *English/French/Spanish*

Set the preferred sound track of digital channels. French and Spanish exist on some channels.

Digital Audio Output

PCM/Raw/Off

Set the audio output type of coax or optical terminal. Raw means output the original format of audio stream. PCM can be matched with most AV amplifiers.

Menu Settings (continued)

Equalizer Settings

Adjust the curve of 7 bands equalizer.

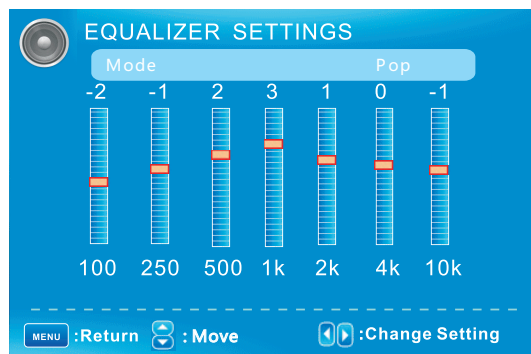

Mode: *Off/Rock/Pop/Jazz/User* (only in User mode, the following can be manually adjusted.)

Adjust Equalizer Settings

Based on your favourites about which frequency band need to be adjusted, make small adjustment with certain frequency band at a time. Suggest NOT making too large changes.

1. Set Mode to User.
2. Press ▼ button to select the first (100Hz) item, then press ◀ and ▶ button to select the band to be turned.
3. Press ▲ and ▼ button to adjust the value.

Menu Settings (continued)

3. Channel menu

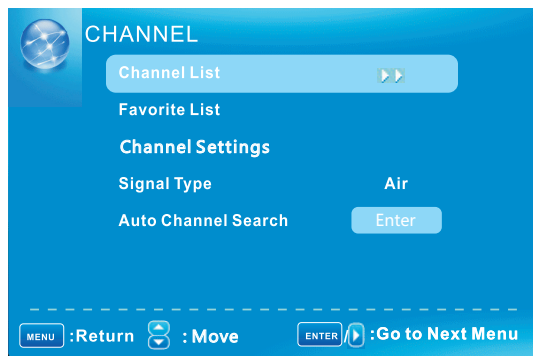

Note: The menu is available only at TV source.

1. Press ▲ and ▼ button to highlight one of the following options, then press ENTER or ► button to enter next sub-menu to adjust it.
2. Press MENU button back to the previous menu.

Channel List

You can view all the channels and choose one quickly.



“ABC”: Label of the Channel.

Press ▲ and ▼ button to highlight a channel and press ENTER to view it.

Menu Settings (continued)

Favourite List

All of your favourite channels are listed in this menu, and you can choose them quickly..



The list shows channels that you set as favourite.
See "Channel Settings" to understand how to set channels be favourite.

Channel Settings

Set the favourite channels, skipped channels, label of channels.

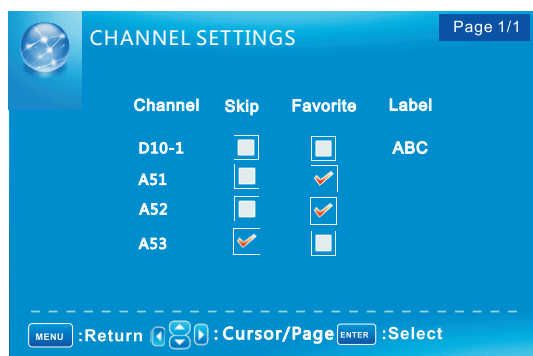

Skip: Set the channel to be skipped when using CH + / CH - to view channels.

Favourite: Set the channel to your favourite list.

Label: Rename label of the channel.

Menu Settings (continued)

Change the settings

Skip & Favourite

1. Press ▲ and ▼ button to select the channel you want to set.
2. Press ◀ and ▶ button to highlight corresponding item, and press ENTER button to set or cancel.

Label

1. Press ▲ and ▼ button to select the channel and ENTER button to enter the edit state.
2. Press ▲ and ▼ button to select the character, press ◀ and ▶ button to move the cursor. Total seven letters.

Signal Type

Set to Air or Cable according to your antenna source. When set to Air, TV can catch 8VSB broadcasting signal. When set to Cable, TV can catch analog and clear 64QAM/256QAM broadcasting signal.

Menu Settings (continued)

4. Parental Control menu



Note: The default user password is “0000”, and if forget what you set, try “1470”.

Lock Parental Control

The following items are only available if the password input is correct.

V-CHIP

Include below settings:



US V-Chip: Rating system used at USA.

For the United States, the rating setting basically include the following options: Movie Rating, TV Rating.

Menu Settings (continued)

Movie Rating

This system defines the rating control which come from MPAA rules.

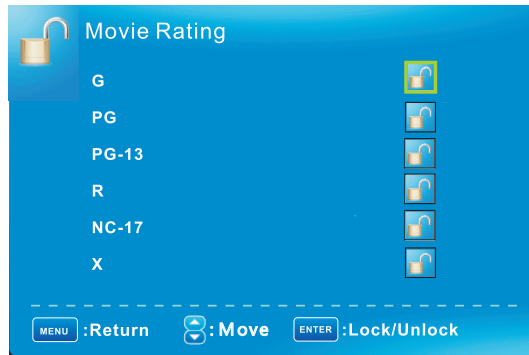

Rating	Define
G	General audience. All ages admitted.
PG	Parental guidance suggested. Some material may not be suitable for children.
PG-13	Parents strongly cautioned. Some material may be inappropriate for children under 13.
R	Restricted. Children under 17 require accompanying parent or adult guardian.
NC-17	No one 17 and under admitted.
X	Adult audience only.

Menu Settings (continued)

TV Rating

The TV rating compose of two aspects: age-based and content-based.

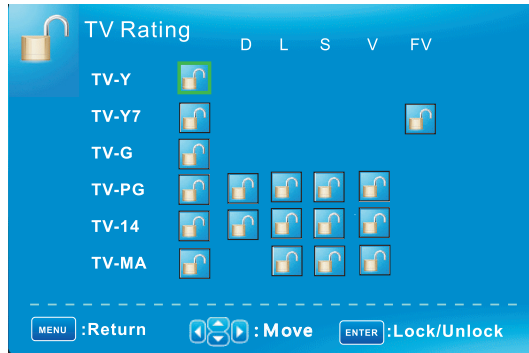

Age	Define	Content	Define
TV-Y	General audience	FV	Fantasy violence
TV-Y7	Parental guidance suggested	D	Suggestive dialogue
TV-G	Parents strongly cautioned	L	Strong language
TV-PG	Restricted	S	Sexual situations
TV-14	No one 17 and under admitted	V	Violence
TV-MA	Adult audience only		

Note: The content ratings will increase depending on the level of the age-based rating. For example, a program with a TV-PG V (violence) rating may contain moderate violence, while a TV-14 V (violence) rating may contain intense violence. So locking a higher level option will automatically cause locking the options that has more sensitive level.

Menu Settings (continued)

Canada V-Chip: Rating system used at Canada.

For Canada, the rating setting include the following options: English Rating, French Rating.

English Rating

These ratings are for programs which are using English rating system.

Rating	Defined as
C	Children
C8+	Children 8 years and older
G	General programming
PG	Parental guidance
14+	Viewers 14 and older
18+	Adult programming



French Rating

The ratings are for programs which are using French rating system.

Rating	Defined as
G	General
8 ans+	Not recommended for younger children
13 ans+	Not recommended for children under age 13
16 ans+	Not recommended for ages under age 16
18 ans+	This program is restricted to adults



Block Unrated Show: Control whether lock the program that have not any valid rating flag.

Downloadable Rating: Control the RRT5 setting which are valid only at some digital cable channels.

Clear Downloadable Data: Select to clear the previous downloadable rating data.

Menu Settings (continued)

Change Password

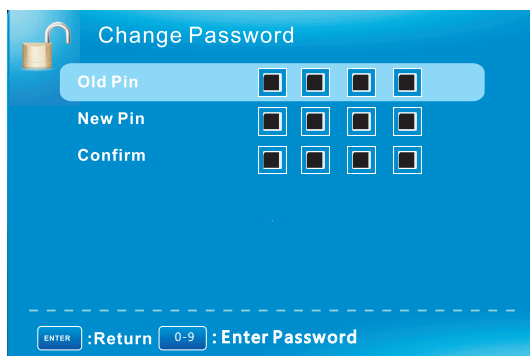

At first you should enter the correct old password then enter new password twice. If you lost your password, try to enter "1470".

Keypad Lock

Press to lock the front panel keypad, press again to release.

Source Lock



Press ▲ and ▼ button to select the source you want to lock, then press ENTER button to set it to lock. If anyone want to use this source, the password is needed.

Menu Settings (continued)

5. Setup menu

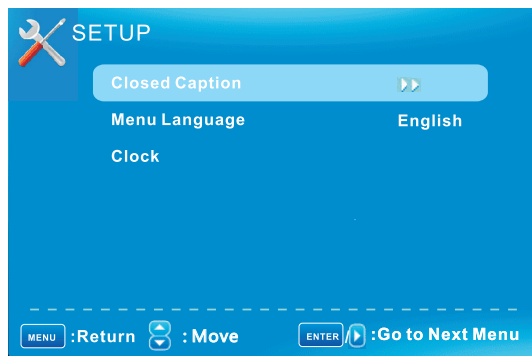

Closed Caption

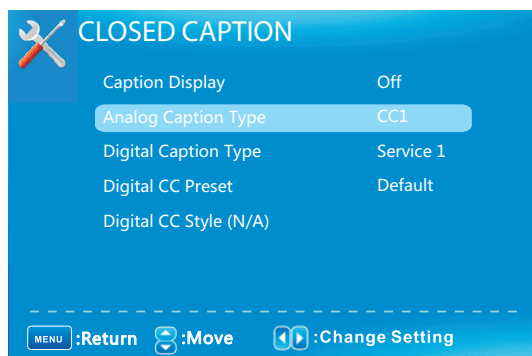

Closed Caption (CC) Include below options:

Caption Display: Display or hide the CC.

Analog Caption Type: Select from below closed-caption modes for analog programs.

CC1,2,3,4: Displays corresponding caption channel of analog program. (Usually be set to CC1 for most programs.)

Text1,2,3,4: Displays corresponding text service channel of a analog program.

Menu Settings (continued)

Digital CC Style

Digital Caption Type: Applies only to digital channels with closed caption.

Service 1,2,3,4,5,6: These are different service data channels.

Digital CC Preset: *Default/Custom*

If set to Custom, Digital CC Style is available.

Digital CC Style

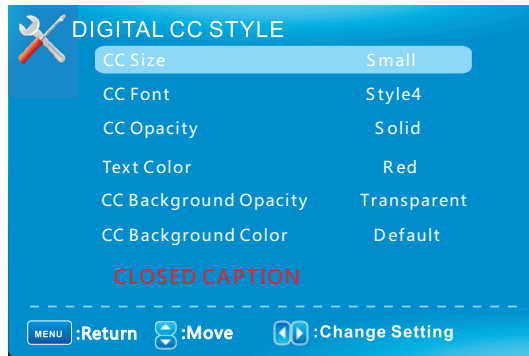

This menu is valid only for digital closed caption of digital channels.

CC Size: Small/Standard/Large/Default

CC Font: Style 0 ~7, Default

CC Opacity: Flashing/Default/Solid/Translucent/Transparent/Default

Text Color: Blue/Yellow/Red/Black/White/Green/Magenta/Cyan/Default

CC Background Opacity: Flashing/Solid/Translucent/Transparent/Default

CC Background Color: Blue/Yellow/Red/White/Green/Magenta/Cyan/Default

Menu Language

Set the menu language. English/French/Spanish.

Menu Settings (continued)

Clock

Set the Time Zone/Auto Clock/Day of time/Daylight Saving.

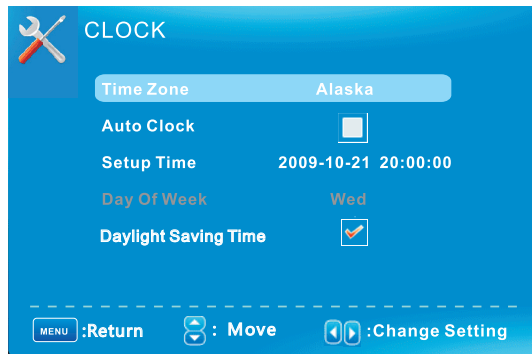

Time Zone: Hawaii/Alaska/Pacific/Central/Mountain/Eastern/Samoa/Newfoundland/Atlantic.

Auto Clock: If set it to ON, the TV will sync the local clock according to the DTV broadcasting time automatically. Otherwise you can set the time manually.

Setup Time: Set Auto Clock to Off, then you can set the time manually.

Note: In the case of loss of power, the clock setting will be lost.

Day of Week: The TV will calculate current day of week according to the time.

Daylight Saving Time: When Auto Clock set to ON, this item is available to enable day-night saving option or not.

Menu Settings (continued)

6. Others menu



Blue Back:

Set the screen background colour blue or not when no valid signal input. When analog TV input and has no signal, snow noise will display if this option is cleared.

No Signal Power Off:

If it is set, TV will automatically enter standby after 10 minutes without signal input.

No Operation Power Off:

If it is set, TV will automatically enter standby after 3 hours without any operation.

All Reset:

When you highlight the item the system will note you that **“Attention! If [All Reset] was executed, TV system is reset”**, and if you are sure to reset, press ENTER to reset.

Simple Troubleshooting

Please check if you can solve problems by troubleshooting yourself.

Troubleshooting	Control
No signal	Please check that all cables are correctly plugged in.
No color shades	Adjust the contrast, the color or the brightness.
Stain on the screen	Maybe the result from a lighting signal from car, motor, neon light and other electrical devices or appliances.
Double or multiple display image	Maybe the result of an electrical wave disturb from other TV, Computer and Game machine or Radio.
Snow on the screen	The cables of the antenna are not correctly plugged in.
The remote control does not work	Please check the batteries order and alignment. Check that the IR of the remote control is not hidden by something.
"Zip" made noise on TV cover	Even if the display image is correct, the noise may come from an unsteady fixation of the panel.
No sound	Make sure that you have not press the MUTE button of the panel or of the remote control.

Technical Specifications

This manual is only for your reference, any changes to the design and specification will not be advised.

Screen Size	55 Inch	
Display Type	TFT LCD	
Resolution(Pixel)	1920 x 1080	
Aspect Ratio	16:9	
Power Supply	AC 100-240V 50/60Hz	
Power Consumption	≤ 300W	
TV System	ATSC/NTSC	
Video Input Format	PAL/NTSC	
Audio Output Power	L/R 2 x 8 W	
Support	ANTENNA	Support
	AV-IN	Support
	YPBPR-IN	Support
	HDMI-IN	Support
	VGA(PC)-IN	Support
	VGA(PC) AUDIO-IN	Support
	HEADPHONE OUT	Support
	S-VIDEO-IN	No Support
	COAXIAL-OUT	Support
	USB	Support
Dimensions	Inc Stand (LxWxH mm)	1320 x 347 x 855
	Exc Stand (LxWxH mm)	1320 x 115 x 790
Weight	Net (Kgs)	33kg
	Gross(Kgs)	39kg



www.westinghousedigital.com



S/N: _____



Westinghouse Digital, LLC
Orange, CA

SE-UM-5502-0101