

Philips Business Solutions

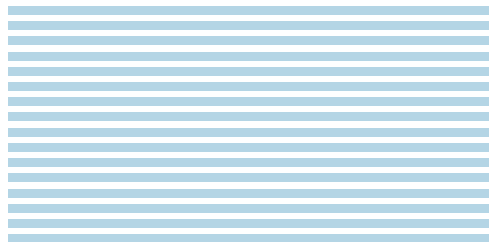

EN User Manual

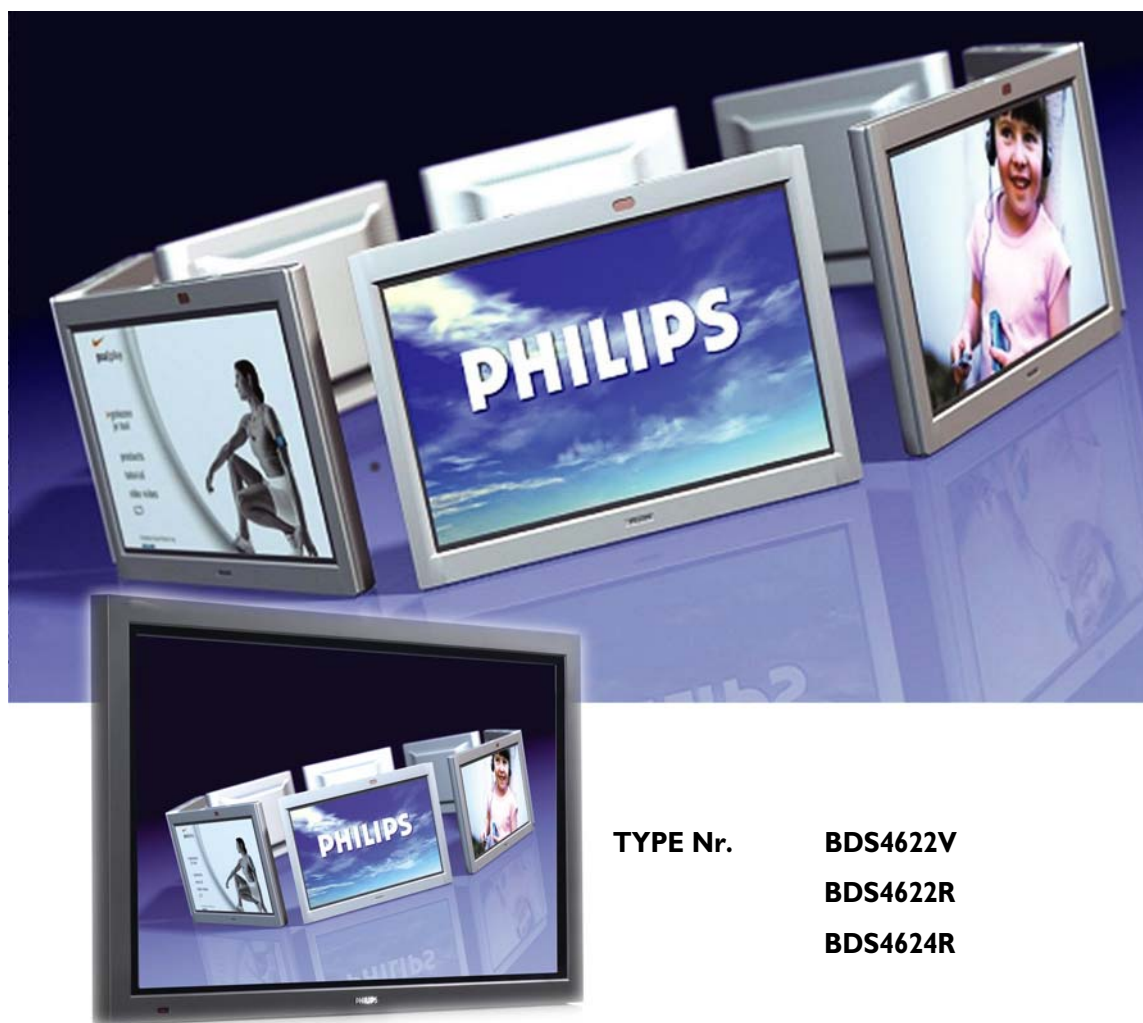

TYPE Nr. **BDS4622V**
 BDS4622R
 BDS4624R

PHILIPS

TABLE OF CONTENTS

1	SAFETY	3
1.1	Safety Instructions	3
1.2	Warnings and Precautions	6
1.2.1	Note to the CATV System Installer	6
1.3	Cleaning & Care	7
1.4	End-of-Life Disposal	7
2	REGULATORY NOTICE (FOR USA AND CANADA ONLY)	9
3	PRODUCT FEATURES	11
4	UNPACKING AND INSTALLATION	13
4.1	Unpacking	13
4.2	Package Contents	14
4.3	Installation Notes	15
5	PARTS & FUNCTIONS	17
5.1	Front View	17
5.2	Rear View (FOR BOTH BDS4622V/R AND BDS4624R)	18
5.3	Remote Control	20
5.4	Battery Installation	22
5.5	Effective range of Remote Control	22
6	CONNECTION TO EXTERNAL EQUIPMENT	23
6.1	PC Module	23
6.2	Video Module	24
6.3	External Speakers (optional)	25
7	BASIC FUNCTIONS	27
7.1	Powering On/Off	27
7.2	Selecting an input mode	28
7.3	On-screen Display menu	29
7.4	Volume Adjustment	30
7.5	Zooming in/out of pictures	31
7.6	Miscellaneous functions	31
8	ADVANCED FUNCTIONS	33
8.1	OSD Menus	33
8.1.1	Picture Menu	33
8.1.2	Display Menu	34
8.1.3	TV Settings Menu (For BDS4622R and BDS4624R only)	35
8.1.4	Audio Menu	36
8.1.5	Miscellaneous	37
8.1.6	Information	38
8.2	TV options (For BDS4622R and BDS4624R only)	39
8.2.1	Tuner function	39
8.2.2	Installation	40
8.2.3	Basic Operation	40
8.2.4	OSD Functions	41
9	OPTIONAL ACCESSORIES	47
10	TECHNICAL SPECIFICATIONS	49
11	CLEANING AND TROUBLESHOOTING	51

- 11.1 Cleaning 51
- 11.2 Troubleshooting 52
- 12 LIMITED WARRANTY (USA).....53**
- 13 LIMITED WARRANTY (EUR).....55**
- 14 APPENDIX1**
 - 14.1 Wall-mount Installation Guide..... 1

1. SAFETY

1.1 SAFETY INSTRUCTIONS

- Read and keep these instructions.
- Heed all warnings.
- Follow all instructions.
- Do not use this apparatus near water.
- Disconnect from the electric outlet before cleaning. Do not use liquid or aerosol cleaners. Clean only with a slightly damp cloth.
- Do not block any of the ventilation openings. Install in accordance with the manufacturers instructions.
- Do not install in direct sunlight, near any heat sources such as radiators, heat registers, stoves, or other apparatus (including amplifiers) that produce heat.
- Do not defeat the safety purpose of the polarized or grounding type plug. A polarized plug has two blades with one wider than the other. A grounding type plug has two blades and a third grounding prong. The wide blade or third prong are provided for your safety. When the provided plug does not fit into your outlet, consult an electrician for replacement of the obsolete outlet.
- Do not remove cover, to prevent electric shock. Refer servicing to qualified service personel only.
- Unauthorized modification of this equipment or usage of an unshielded connecting cable may cause excessive interference.
- Adjust only those controls that are covered by the operating instructions. Improper adjustment of other controls can result in damage which often requires extensive work by a qualified technician to restore the unit to normal operation.
- Use in well-ventilated area and do not block any of the ventilation openings. Install in accordance with the manufacturer's instructions.
- The unit must be operated from the type of power source indicated on the label. If the type of available power is unknown, consult your dealer or local power company.
- Protect the power cord from being walked on or pinched particularly at plugs, convenience receptacles, and the point where they exit from the apparatus power outlet. This is a safety feature. If you are unable to insert the plug into the outlet, contact your electrician. Do not alter the plug; this will defeat the safety feature.
- Do not overload wall outlets and extension cords as this can result in a risk of fire or electric shock.
- If the picture displayed looks abnormal, turn off the unit and disconnect it from the electric outlet. Verify your signal wire connections and reconnect the display to the electric outlet.
- Only use attachments/accessories specified by the manufacturer.



- Use only with a cart, stand, tripod, bracket, or table specified by the manufacturer, or sold with apparatus. When a cart is used, use caution when moving the cart/apparatus combination to avoid injury from tip-over.
- Unplug this apparatus during lightning storms or when unused for long periods of time.
- Refer all servicing to qualified service personnel. Servicing is required when the apparatus has been damaged in any way, such as power-supply cord or plug is damaged, liquid has been spilled or objects have fallen into apparatus, the apparatus has been exposed to rain or moisture, does not operate normally, or has been dropped.
- This product may contain lead and mercury. Disposal of these materials may be regulated due to environmental considerations. For disposal or recycling information, please contact your local authorities or the Electronic Industries Alliance: www.eiae.org
- **Damage Requiring Service:**
The appliance should be serviced by qualified service personnel when:
 - The power supply cord or the plug has been damaged or frayed.
 - Objects have fallen, or liquid has been spilled into the appliance.
 - The appliance has been exposed to rain.
 - The appliance does not appear to operate normally or exhibits a marked change in performance.
 - The appliance has been dropped, or the enclosure damaged.
 - Unit does not operate normally when the operating instructions are followed.
- **Tilt/Stability:**
 - All displays must comply with recommended international global safety standards for tilt and stability properties of its cabinet design.
 - Do not compromise these design standards by applying excessive pull force to the front, or top, of the cabinet which could ultimately overturn the product.
 - Do not endanger yourself, or children, by placing electronic equipment/toys on the top of the set and cause product damage and/or personal injury.
 - Do not place the unit on an unstable cart, stand or table. Or the product may fall, causing serious damage.
- Do not place the unit on a bed, sofa, rug, or similar surfaces.
- **Wall or Ceiling Mounting:**
The appliance should be mounted to a wall or ceiling only as recommended by the manufacturer.
- **Power Lines:**
An outdoor antenna should be located away from power lines.

■ **Outdoor Antenna Grounding:**

- If an outside antenna is connected to the receiver, be sure the antenna system is grounded so as to provide some protection against voltage surges and built up static charges.
- Section 810 of the National Electric Code, ANSI/NFPA No. 70-1984, provides information with respect to proper grounding of the mast and supporting structure, grounding of the lead-in wire to an antenna discharge unit, size of grounding connectors, location of antenna-discharge unit, connection grounding electrodes, and requirements for the grounding electrode.

■ **Object and Liquid Entry:**

Care should be taken so that objects do not fall and liquids are not spilled into the enclosure through openings.

■ **Battery Usage:**

CAUTION: To prevent battery leakage that may result in bodily injury, property damage, or damage to the unit.

- Install all batteries correctly, with + and - aligned as marked on the unit.
- Do not mix batteries (old and new or carbon and alkaline, etc.).
- Remove batteries when the unit is not used for a long time.

1.2 WARNINGS AND PRECAUTIONS

1.2.1 NOTE TO THE CATV SYSTEM INSTALLER

This reminder is provided to call the CATV system installer's attention to Article 820-40 of the NEC that provides guidelines for proper grounding and, in particular, specifies that the cable ground must be connected to the grounding system of the building, as close to the point of cable entry as practical.

KNOW THESE SAFETY SYMBOLS



■ This lightning flash with arrow-head within a triangle indicates uninsulated material within your unit, which can cause an electric shock. For the safety of everyone in your household, do not remove product cover.



■ For the safety of everyone in your household, do not remove product cover. The exclamation point within a triangle calls attention to features for which you must read the enclosed literature closely to prevent operating and maintenance problems.

WARNING

To reduce the risk of fire or electric shock, this appliance must not be exposed to rain or moisture, and objects filled with liquids, such as vases, must not be placed upon this apparatus.

CAUTION

To prevent electric shock, match wide plug blade to wide slot, and fully insert.

ATTENTION

Pour éviter les chocs électriques, introduire la lame la plus large de la fiche dans la bome correspondante de la prise et pousser jusqu'au fond.

1.3 CLEANING & CARE

- To avoid possible shock hazard, please be sure that the television is unplugged from the electrical outlet before cleaning.
- When cleaning the television screen, take care not to scratch or damage the screen surface (avoid wearing jewelry or using anything abrasive).
- Wipe the front of the screen with a clean cloth dampened with water. Use even, easy, vertical strokes when cleaning.
- Gently wipe the cabinet surfaces with a clean cloth or sponge dampened in a solution of cool clear water. Use a clean dry cloth to dry the wiped surfaces.
- Occasionally vacuum the ventilation holes or slots in the cabinet back.
- Never use thinners, insecticide sprays, or other chemicals on or near the cabinet, as they might cause permanent marring of the cabinet finish.
- Do not allow a still image to be displayed for an extended period of time as this can cause a permanent after-image to remain.

1.4 END-OF-LIFE DISPOSAL

- This Philips product and its packaging contain materials that can be recycled and re-used. Specialized companies can recycle your product to increase the amount of reusable materials and minimize the amounts which need to be properly disposed.
- This product might also use batteries, which should not be thrown away when depleted, but should be handed in and disposed of as small chemical waste.
- Please find out about the local regulations regarding the disposal of the television, batteries, and packaging materials whenever you replace existing equipment.

2. REGULATORY NOTICE (FOR USA AND CANADA ONLY)

FCC Statement

The Federal Communications Commission Radio Frequency Interference Statement includes the following warning:

This equipment has been tested and found to comply with the limits for a Class B digital device, pursuant to Part 15 of the FCC Rules. These limits are designed to provide reasonable protection against harmful interference in a residential installation. This equipment generates, uses, and can radiate radio frequency energy and, if not installed and used in accordance with the instructions, may cause harmful interference to radio communications. However, there is no guarantee that interference will not occur in a particular installation.

If this equipment does cause harmful interference to radio or television receptions, which can be determined by turning the equipment off and on, the user is encouraged to try to correct the interference by one or more of the following measures:

- Reorient or relocate the receiving antenna.
- Increase the separation between the equipment and receiver.
- Connect the equipment into an outlet on a circuit different from that to which the receiver is connected.
- Consult the dealer or an experienced radio/TV technician for help.

Warning

User must use shielded signal interface cables to maintain FCC compliance for the product. Provided with this display is a detachable power supply cord with IEC320 style terminations. It may be suitable for connection to any UL Listed personal computer with similar configuration. Before making the connection, make sure the voltage rating of the computer convenience outlet is the same as the monitor and that the ampere rating of the computer convenience outlet is equal to or exceeds the monitor voltage rating. For 120 Volt applications, use only UL Listed detachable power cord with NEMA configuration 5-15P type (parallel blades) plug cap. For 240 Volt applications use only UL Listed Detachable power supply cord with NEMA configuration 6015P type (tandem blades) plug cap.

IC Compliance Notice

This Class B digital apparatus meets all requirements of the Canadian Interference-Causing Equipment Regulations of ICES-003.

Cet appareil Numérique de classe B respecte toutes les exigences du Règlement NMB-03 sur les équipements produisant des interférences au Canada.

Notice de Conformité IC

Cet appareil numérique de classe B respecte toutes les exigences du Règlement ICES-003 sur les équipements produisant des interférences au Canada.

3. PRODUCT FEATURES

This monitor uses a slim design at only 9.8cm thick. Its excellent picture quality is perfect for multimedia applications.

- Multiple inputs modules :
 - PC module: RGB (D-sub 15-pin), DVI, and RS-232 (D-sub 9-pin male) inputs.
 - VIDEO module: Scart(CVBS) x 1, Scart(S-Video) x1, Component (RCA) input x 1, and composite (RCA) inputs x 1; audio (R/L) x 1 outputs.
 - Resolution for PC module: SXGA (1280X1024), 60Hz.
- Power management: Equipped with energy saving function.
- Fan-free design: This monitor has been design to reduce energy consumption, so there is no cooling fan inside. As a result, you will not be disturbed by the noise of cooling fans.
- Miscellaneous:
 - PIP/POP function: It allows you to display pictures from different sources in six different Picture-In-Picture (PIP) or Picture-Of-Picture (POP) mode.
 - A pair of high-definition built-in speakers (5W+5W or 7W+7W). You can purchase a pair of external speakers (15W+15W) to enjoy a better sound effect.
 - Three EQ options allows you to adjust the best sound effect.
 - This product has been licensed to use the SRS technology product by the SRS Labs, Inc.



Is the trademark of SRS Labs, Inc

4. UNPACKING AND INSTALLATION

4.1 UNPACKING

- The monitor is packed in a carton, together with the standard accessories. Any other optional accessories will be packed separately.
- The weight of the monitor is approx 37 kg. Due to the size and weight it is recommended to move it by 2 people.
- The protective glass and the glass substrate are installed on the front of the product. Since both glasses can be broken and scraped easily the product has to be handled with care. Never place the monitor with the glass faced down unless it is protected with pads.
- After opening the carton ensure that the content is in good condition and complete.
- When possible use the handles on the back of the monitor for transport.

4.2 PACKAGE CONTENTS

Please verify that you received the following items with your package content:

- 1 Monitor
- 2 Remote Control
- 3 CD-ROM with User Manual (For BDS 4624R printed version only)
- 4 Power cable
- 5 Batteries
- 6 AV cable
- 7 D-sub cable

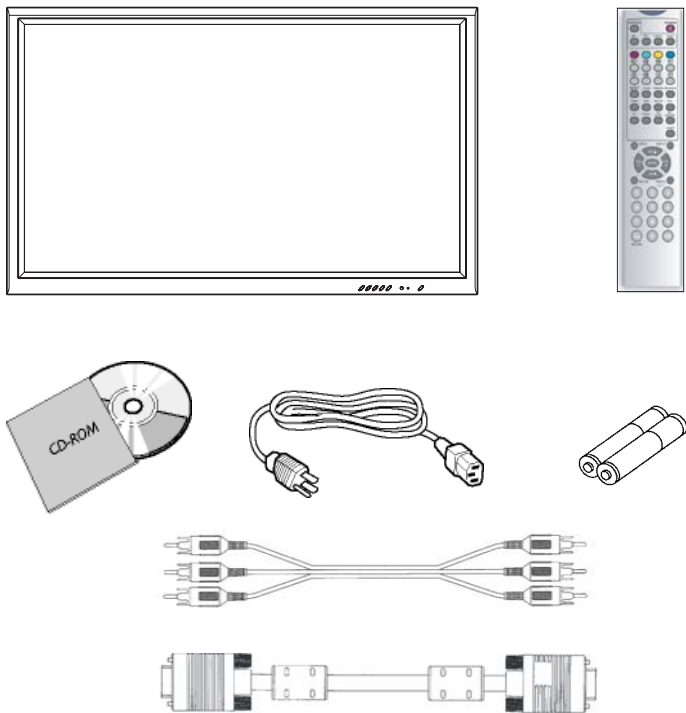

4.3 INSTALLATION NOTES

- Read this manual carefully before you start to install this monitor.
- Due to the high power consumption, always use the plug exclusively designed for this product. If an extended line is required, please consult your service agent.
- Installed on a flat surface to avoid tipping.
Keep a distance of at least 10 cm between the back of the product and the wall or any furniture for a good ventilation.
- Do not install this monitor in the kitchen, bathroom or any other places with high humidity, to avoid shorter service life of the electronic components.
- Please ensure the monitor is installed horizontally.
Any 90 degrees clockwise or counter-clockwise installation may induce poor ventilation and subsequent component damage.
- To protect the screen and avoid screen damage, do not display a still picture for a long time.

5. PARTS & FUNCTIONS

5.1 FRONT VIEW

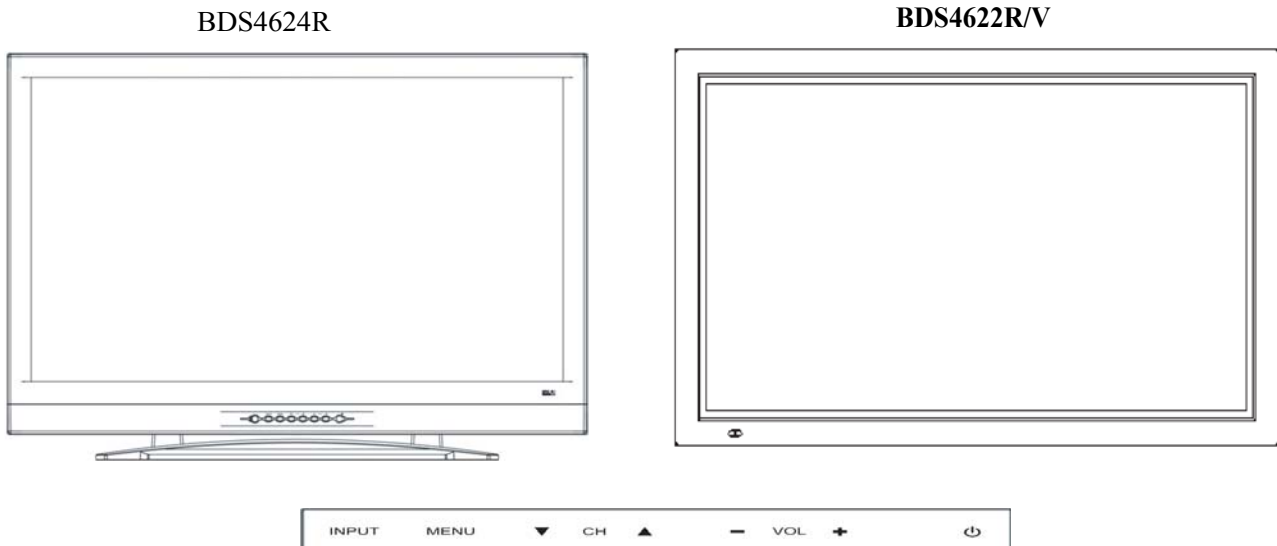

1. Status LED

Indicates the status of the monitor

- **Not Illumated = No AC Power detected**

If the main power switch (rear of panel) is turned off, this LED will not illuminate.

- **Red = Standby (Power OFF) with AC power detected**

The LED will illuminate in red color if the monitor is shut off but the main power cord is plugged into the back of the unit.

- **Green = Power ON**

- **Blinking = Sleep mode**

2. Power (Standby) Button

Turns power on/off from standby mode. There is a wait period between on/off cycles.

3. Volume Adjustment Buttons

Use these buttons to adjust volume up and down. These keys also serve as navigation and adjustment keys when On Screen Display (OSD)-menu is engaged.

4. Select Buttons

Use these buttons to navigate through the On Screen Display (OSD)-menu. If an optional TV tuner is installed, these buttons also function as Channel Up/Down.

5. Menu Button

Use this button to engage the On Screen Display (OSD)-menu.

6. Input Button

Use this button to switch between the available inputs.

5.2 REAR VIEW
(FOR BOTH BDS4622V/R AND BDS4624R)

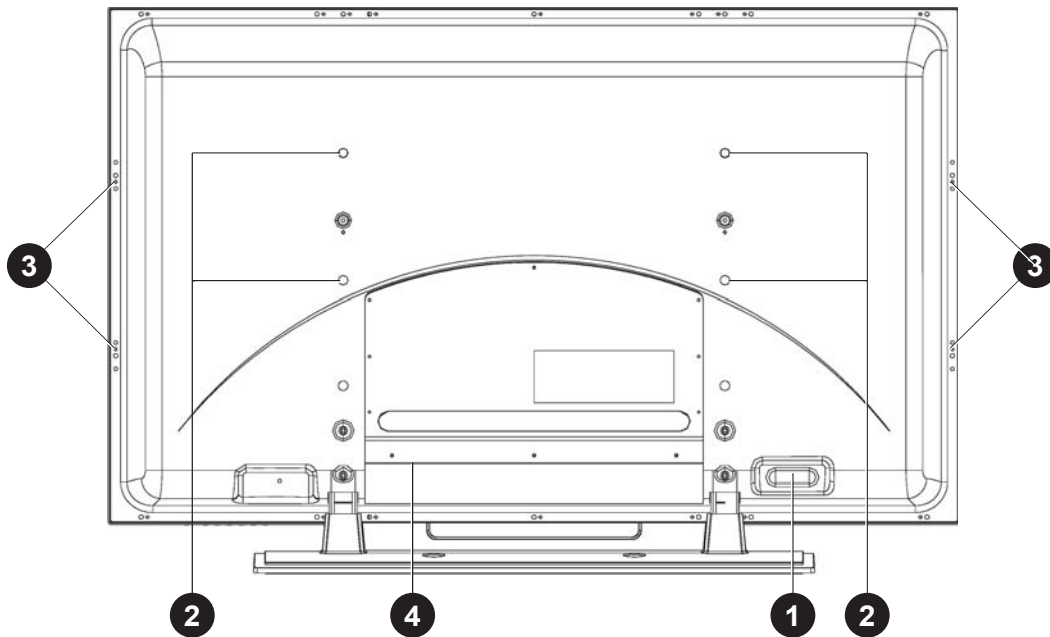

1. **Speaker Terminals**

Can be used to connect external speakers (optional accessories) to the product. Maximum power output 10W + 10W.

2. **Wall Mount fixing holes**

Use the standard screws to fix the wall mount (optional accessory).

3. **Loud speaker fixing holes**

Use the fixings and screws supplied with the (optional) loud speakers to attach them to the product.

4. **Signal input terminals**

PC module

● **RGB Video In:**

Allows to connect to the D-sub 15-pin port (analog output) on the VGA card and use this product as a PC monitor.

● **DVI Video In:**

Allows to connect to the DVI-I port (digital output) on the VGA card and use this product as a PC monitor.

● **RS-232C:**

D-sub 9-pin male port for firmware update.





VIDEO module

- **Scart 2:**
Composite S-Video input terminal (SCART connector) connecting to the Composite S-Video output terminal of the video output device.
- **Scart 1:**
Composite video & RGB input terminal (SCART connector) connecting to the Composite video or RGB output terminal of the video output device.
- **Video In:**
Composite video input terminal (RCA connector) connecting to the video output terminal of the video output device.
- **Audio In:**
Audio input terminals for connecting the audio output of a video system. They shared with audio input of YCbPb/CrPr and Composite.
- **Y/CbPb/CrPr:**
Component input terminals (RCA) for connecting video systems with component outputs.
- **Audio Out:**
Audio output terminals for connecting the audio input of any audio or audiovisual device.
- **PC Audio In:**
Stereo input terminal for connecting output signals of a sound card of the PC (VGA/DVI).

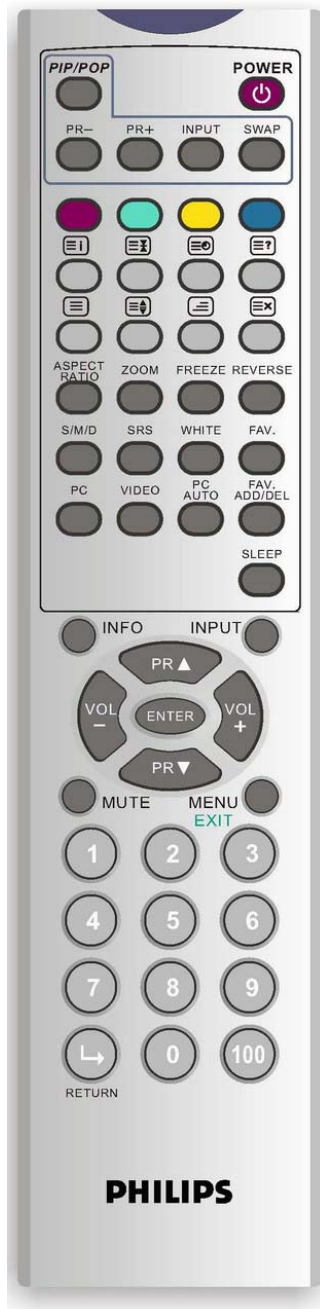

5.3 REMOTE CONTROL

1. Standby Power On/Off

Press this button to turn on the monitor from Standby mode.
Press it again to turn it off to Standby mode.

2. PIP/POP

Swaps the main and sub picture windows under PIP or POP modes.

3. PR+

Press this button to select a higher TV-channel for the sub-frame.
(Only applicable for BDS4622R and BDS4624R).

4. PR-

Press this button to select a lower TV-channel for the sub-frame.
(Only applicable for BDS4622R and BDS4624R).

5. INPUT

Press this button to select an input source for the sub-frame.

6. SWAP

Press this button to swap between the main frame and sub-frame.

7. ASPECT RATIO

Press this button to select the favorite screen size.
Pixel to Pixel, 4:3, Output, Panoramic, Letter Box or Full screen.

8. ZOOM

Press this button to zoom in an image

9. FREEZE

Press this button to freeze the display on the screen (not the input source). Press again to resume display. (It can take some time before display reacts.)

10. REVERSE

Press this button after a static image has been on the screen for a longer period of time. This prevents a burn-in protection of the screen.

11. S/M/D

Press this button to select the audio channel of SAP programs.

Note:

(Only applicable for BDS4622R and BDS4624R).

12. SRS

Surround sound.

13. White

Press this button to set back color of the screen to white.
This to remove the residue image on the screen after displaying a static image for a longer period of time.

14. FAV.

Press this button to call out your favorite channels.
(Only applicable for BDS4622R and BDS4624R).

15. FAV.

Press this button to add or delete a channel of the favorite channel list.
(Only applicable for BDS4622R and BDS4624R).



16. PC AUTO

Press this button to activate auto adjustment (phase, V-sync and H-sync), if there is a display problem in PC mode after timing change.

17. VIDEO

Press this button to select a Video input source.
Scart 1 => Scart 2 => AV => Component (cyclical).
The sequence of the inputs varies for different input modules.

18. PC

Press this button to select an PC-input source.
VGA=>DVI (cyclical)

19. SLEEP

Press this button to set timer off.

20. INPUT

Press this button to select an input source.

21. INFO

Press this button to display the current input source and display mode.

22. ▲ / ▼

Use these buttons to select an OSD item up and down.

23. +/-

Use these buttons to select an OSD item left and right.

24. ENTER

Press the ▲, ▼, + or - button to move the highlight bar to the desired menu and adjust settings.
Press the ENTER button to save the settings.

25. MENU/EXIT

Press the MRENU button activate the OSD menu.
Press the ▲, ▼, + or - button to move the highlight bar to the desired menu and adjust settings.
Press the EXIT button to exit the OSD menu.

26. MUTE

Press this button to switch off the speakers.
Press again to switch on.

27. PR ▲ / ▼

Press this button to select a TV channel.
(Only applicable for BDS4622R and BDS4624R)

28. Input

Change input signal selection.

29. Number Keypad

Use number keypad to select the TV channel you want to watch.
(Only applicable for BDS4622R and BDS4624R).

5.4 BATTERY INSTALLATION

- 1 Slide out the battery cover.
- 2 Insert the two batteries (UM4).

Note:

Ensure that the polarity is as indicated by (+) and (-) inside the battery compartment.

- 3 Install the battery cover back to the remote control.

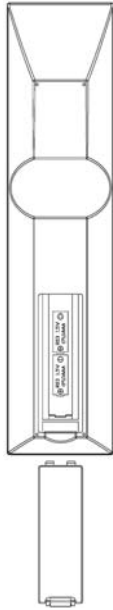

5.5 EFFECTIVE RANGE OF REMOTE CONTROLL

- Point the remote controller at the signal receiver (power indicator) on the front panel of your plasma display.
- Do not block the signal receiver (power indicator) on the front panel of your plasma display.
- The effective range of remote controller is 10M, 30° left and right and 20° up and down, as shown above.

Notes for remote controller maintenance:

- Avoid impact, falling or dropping of remote controller. Keep remote controller dry and out of heat source.
- Do not clean remote controller with volatile solvents (e.g. benzene or thinner).
- Check battery level when remote controller does not work properly.

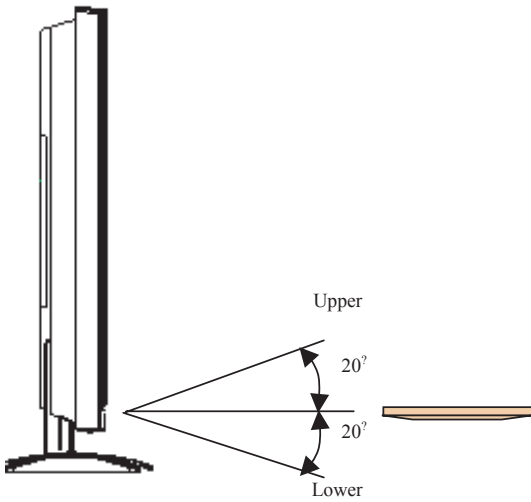

6. CONNECTION TO EXTERNAL EQUIPMENT

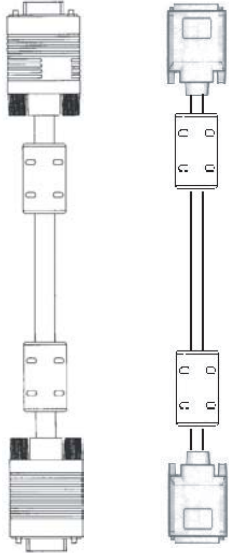
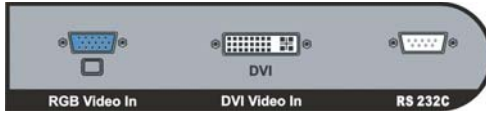

6.1 PC MODULE

The PC module is designed for connecting this monitor to a VGA card on PC to make it a PC monitor.

- D-SUB (15-pin): Connect to the analog RGB output interface on the VGA card. (Select VGA from INPUT)
- DVI: Connect to the DVI-I digital RGB output interface on the VGA card. (Select DVI from INPUT)

Notes:

- The DVI port on your plasma display is for connecting to the DVI-I port on the VGA card. No analog signal is available from this port.
- The RS-232 port on your plasma display is for firmware update by professionals. It should not be used for communication purpose.

6.2 VIDEO MODULE

Functions of the D-SUB, DVI and RS-232 ports are the same as that of the PC module.

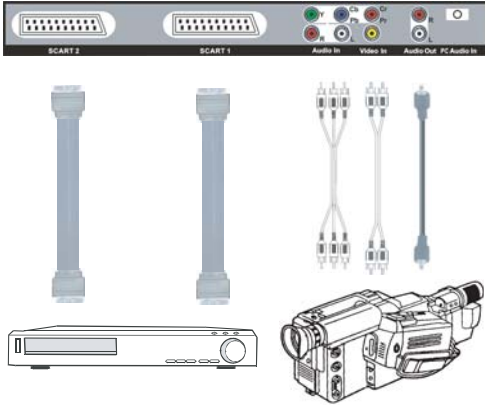

■ Component (Y/PbCb/PrCr) terminals

For connecting video systems with component outputs (e.g. DVD players and HDTV tuners).

Connect the audio out of device to Audio In. (Select Component from INPUT)

■ Video In

For connecting video systems with video outputs (e.g. VCR's, VCD players and DVD players).

Connect the audio out of device to Audio In. (Select AV from INPUT)

■ Scart terminal

For connecting to the composite or RGB output of a video output device (such as a DVD or VHS) with Scart terminal output. (INPUT Option Scart 1 or Scart 2 from INPUT)

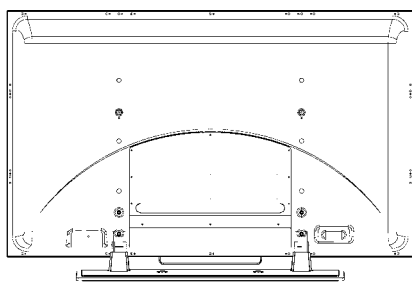

6.3 EXTERNAL SPEAKERS (OPTIONAL)

- 1 Press and hold the clip on the terminal and plug the speaker cable (remove the jacket) into the terminal. Release the clip.
- 2 Pull the cable gently to make sure that it will come out or not.

Notes:

- The connections of both channels (L+R) are the same.
- Set the option Speaker from the OSD menu to External Speaker when a pair of external speakers is connected.

7. BASIC FUNCTIONS



7.1 POWERING ON/OFF

Make sure the monitor is plugged into the wall outlet and the main AC switch located in the rear of the monitor is switched to ON position. If the power is plugged in and the AC switch is on, the STATUS LED will blink for a few seconds in green before it illuminate in red color (STAND BY).

Using Front Panel or Remote Control

- 1 Press the POWER button on the front panel or the remote control. The monitor will now turn on after a brief pause. The STATUS LED will now turn green to indicate power on status.
- 2 Turn off the power by pressing the POWER button on the monitor panel or remote control again.

Status LED:

■ **Not Illumated = No AC Power detected**

If the main power switch (rear of panel) is turned off, this LED will not illuminate.

■ **Red = Standby (Power OFF) with AC power detected**

The LED will illuminate in red color if the monitor is in standby mode.

■ **Solid Green = Power ON**

■ **Blinking = Sleep mode**



7.2 SELECTING AN INPUT MODE

Using Front Panel or Remote Control

- 1 Press the INPUT key on the monitor panel or the INPUT key on the remote control.
- 2 Pressing the INPUT key will cycle the monitor through all available input signal sources.

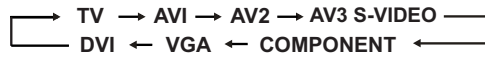

The sequence of input sources (may be different with different input modules):

VGA: D-SUB analog input from the PC module.

DVI: DVI digital input from the PC module.

- 1 PC module: VGA --> DVI
- 2 PC + Video modules:-->Scart 1 - >Scart 2 ->AV ->Component - >VGA ->DVI

Using Direct Input Selection Keys

If you prefer not to cycle through all available inputs, you can use the Direct Input Selection keys on the remote control.

- 1 Simply select the input PC or VIDEO and press the Direct Input Selection key for that input.

7.3 ON-SCREEN DISPLAY MENU

Accessing OSD Menu via Remote Control or Front Panel

The On-Screen Display (OSD) menu allows access to setup various parameters equipped with this display.

You can adjust an OSD item with the following seven buttons:

MENU, EXIT, ▲, ▼, +, - and ENTER.

1. Press the MENU button to call out the OSD menu.
2. Use the + / - buttons to select the following submenus:
Picture->Display->TV Settings->Audio-> Miscellaneous->Information
3. Use the ▲ / ▼ buttons to select an OSD item up and down.
4. Use the + / - buttons to select an OSD item left and right and to adjust the setting of an item.
5. Press the EXIT button to exit OSD menu.

Notes:

- You can adjust the OSD time out from the Miscellaneous menu.
- The OSD menu will turn off automatically if there is no button action before timeout.



7.4 VOLUME ADJUSTMENT

Using Front Panel or Remote Control

- Press and hold the VOL+ button to increase volume.
- Press and hold the VOL- button to reduce volume.

Using MUTE

- Press the MUTE button to mute (turn speakers off).
- Press the MUTE button again to resume speaker output.

Note

- When the monitor's volume is muted, the monitor will display MUTE on the upper right corner of the screen.
- Miscellaneous audio settings (e.g. treble, bass and balance) must be done from the OSD menu or front panel controls.



7.5 ZOOMING IN/OUT OF PICTURES

You can adjust the screen size with the following two buttons: ASPECT RATIO and ZOOM.



■ ASPECT RATIO

Press the ASPECT RATIO button to change the screen size. You can select "Fit to Screen" or "Original Size" (1:1) in PC mode.

You can select Pixel to Pixel, 4:3 Output, Panoramic, Letter Box or Full Screen in Video mode.

■ ZOOM

Press and hold the ZOOM button to zoom in and resume screen.



7.6 MISCELLANEOUS FUNCTIONS

■ PC AUTO

Press the PC AUTO button to activate auto adjustment (phase, V-sync and H-sync) if there is a display problem in PC mode after timing change.

■ FREEZE

Press the FREEZE button to freeze display on the screen (not the input source). Press the FREEZE button again to resume display.

Note:

FREEZE will only freeze the display on the screen, and the playback system will continue playing.

- 1 Press and hold the PIP/POP button to switch from and to:
PIP (Small) -> PIP (Medium) -> PIP (Large) -> POP (full screen) -> POP (16:9) -> Multi PIP -> Off

8. ADVANCED FUNCTIONS

8.1 OSD MENUS

8.1.1 PICTURE MENU

PC Module

In the PC Module you can adjust picture settings for:

- Brightness
- Contrast
- Saturation
- Tint
- Reset
- Picture Mode
- Color Temperature



Video Module

In the Video Module you can adjust picture settings for:

- Brightness
- Contrast
- Saturation
- Tint
- Sharpness
- Reset
- Picture Mode
- Color Temperature

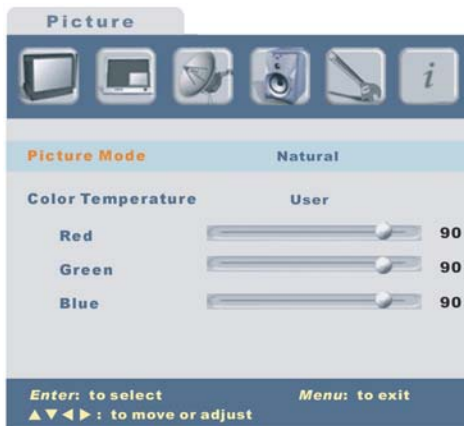

Note:

- You can reset the Brightness, Contrast, Saturation and Tint setting to the factory default.
- If you select the option "User" in the Color Temperature setting, you can adjust the brightness of Red, Green and Blue separately.

8.1.2 DISPLAY MENU

PC Module

In the PC Module you can adjust display settings for:

- Aspect Ratio
- PIP Size
- PIP Position
- Clock
- Phase
- Position

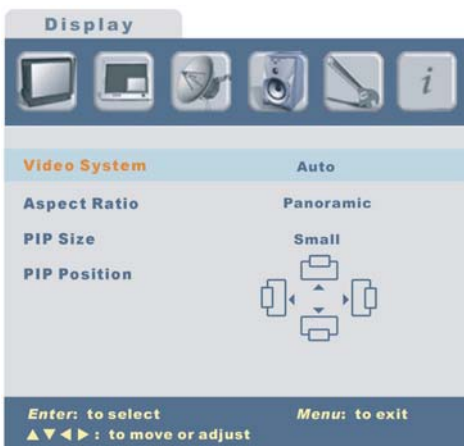
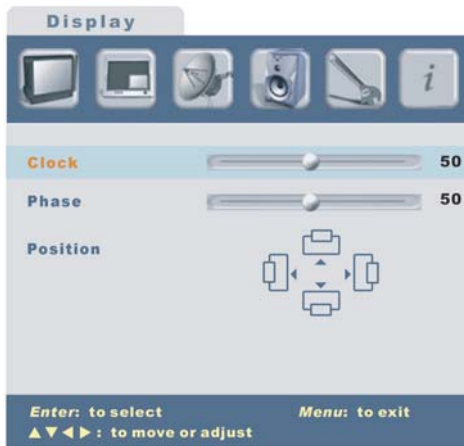
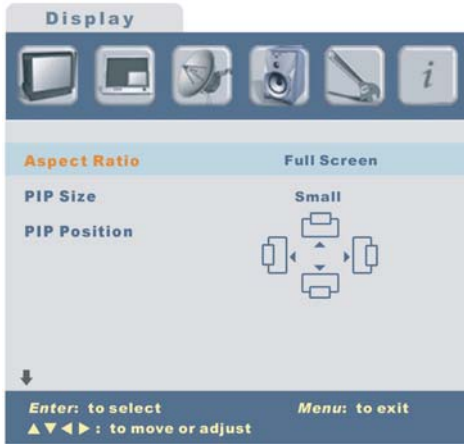

Video Module

In the Video Module you can adjust display settings for:

- Aspect Ratio
- PIP Size
- PIP Position

Display format

To select the best suitable display format:

- 1 Press the ASPECT RATIO button on the remote controller.
- 2 Select one of the options.

8.1.3 TV SETTINGS MENU (FOR BDS4622R AND BDS4624R ONLY)

When a TV module is installed on your monitor you can adjust an set he items:

- Program
- Label
- Auto Install
- Manual Search
- Fine Tune
- Skip
- Audio Format
- Preview
- Auto Sort
- Reset Channel
- Channel Edit



8.1.4 AUDIO MENU

In the Audio Menu you can set and adjust in both the PC module and Video module:



- Treble
- Bass
- Balance
- SRS
- Speakers
- Audio Line Out

8.1.5 MISCELLANEOUS

Language and Screensaver Menu

In both PC module and Video module you can set the options:

- OSD Time Out
- OSD Position
- OSD Language
- OSD Transparency
- DPMS (PC only)
- Image Reverse
- Color Space
- Factory Default
- Scart 2 Source
- Image Move
- Move Time

Notes:

- You can select the OSD language from the option Language.
- Image Reverse is a screen saver to protect the screen from damage, after a still picture is displayed for a long period of time.
- When a static image is being displayed on the screen for a long period of time, use the "Image Reverse" or "Image Move" features to prevent screen burn and protect your screen. The "Move Time" function allows you to adjust the length of time between the stages of the "Image Move" feature.



8.1.6 INFORMATION

PC module

When the PC module is active, you can adjust:

- Resolution
- H-Sync
- V-Sync



Video module

When the Video module is active, the input and video system will be displayed.

Note:

If the PIP function is on, the input and system of sub-frame will be displayed.

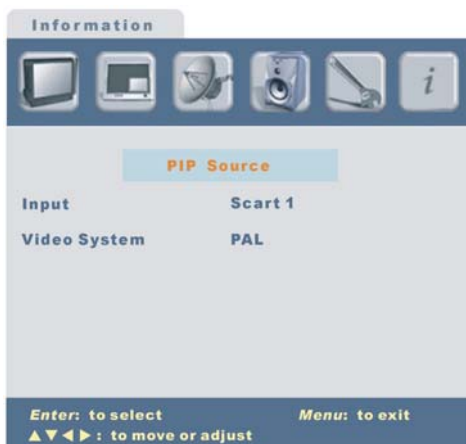

8.2 TV OPTIONS (FOR BDS4622R AND BDS4624R ONLY)

The contents of this manual are to assist you on installation and operation of the tuner function into your PDP Monitor. And enable your PDP Monitor to receive TV signal from antenna or CATV (Cable TV).

8.2.1 TUNER FUNCTION

Features

This tuner shall be used in Europe for receiving TV signal from antenna or CATV.

The features are:

- 1 Apply the general Europe country and not Europe country but the TV system include the SCART and Teletext application area.
- 2 TV System: PAL B/G; PAL D/K; PAL I; PAL L.
- 3 Audio Format: FM Mono; AM Mono; FM BG(A2); NICAM DK; NICAM BG; NICAM I; NICAM L.
- 4 Teletext systems: Support Teletext B systems (Note: not support Teletext A system).
- 5 Program Number: 01 to 99 program.
- 6 The main features of Teletext are as following:
 - World System Teletext (WST) level 1.5 teletext decoding with 200-page memory.
 - Support Latin (Western & Eastern Europe), Cyrillic and Arabic (Farsi) languages.
 - Support Table Of Pages (TOP) and Full Level One Features (FLOF) page navigation.
 - Support Favorite page mode.
- 7 SCART application:
 - Support SCART RGB Input;
 - SCART CVBS Input (Auto detect RGB/CVBS).

8.2.2 INSTALLATION

Connect to antenna

When using 75 Ohm coaxial cable: Connect directly to the VHF/UHF terminal of the tuner.

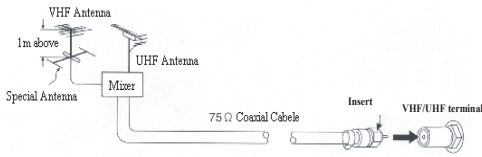

Input and Output Connection

VHF/UHF: Connect antenna or CATV 75 Ohm coaxial cable to receive TV/CATV signal.

8.2.3 BASIC OPERATION

Channel Scan and Memory

When the hardware installation is completed, you must proceed the channels scan first. The operation procedure is as below:

1. Select TV input (2 options)

- Press the INPUT button on the remote controller continuously, and select in sequence. Scart 1--> Scart 2--> AV--> Component--> DVI--> TV.
- Press the VIDEO button on the remote control repeatedly, the system will detect and switch the input signals sequentially by the cycle : Scart 1--> Scart 2--> AV--> Component-->TV.

2. Channel scan and memory

- 1 Press the MENU on the remote control or the front panel of the monitor.
- 2 Select TV Settings.
- 3 Press the PR ▲ or PR ▼ button to select.
- 4 Press the VOL- or VOL+ button to execute.

5 Press the PR ▲ or PR ▼ button to move to the Auto Install icon.

- 6 Press the VOL- or VOL+ button for channel scanning (figure as beside).

The system will automatically scan the whole frequency range (band VHF L; VHF H; UHF) and memorize the valid channels.

Note:

During this procedure, other functions will be inactive.

- 1 Press the EXIT button to stop scanning.
- 2 After scanning use the PR ▲ or PR ▼ button at the font panel, or number keys on the remote control, to select your favorite program.



8.2.4 OSD FUNCTIONS

A)TV Settings

- 1 Press MENU.
- 2 Press the PR ▲ or PR ▼ button to Select.
- 3 Press the VOL- or VOL+ button to Execute, then the TV Settings will come out as the left figure below.



Auto Install

There are 3 systems: Europe; France and All Region.

- 1 Select Auto Install row.
- 2 Press the VOL+ button to enter the select system.
- 3 Press the ENTER button to start the channel scanning.

The OSD menu will change into Channel Search.

Upon completion of the channel scan it will stay on the channel where the auto process started.

The active channels are stored into the channel memory.

- 4 Press the PR ▲ or PR ▼ button to select channel in sequence.
- 5 Press the EXIT button to stop searching.

Manual Search

- 1 Press the VOL+ button to set up TV Channels manually.

Fine Tune

- 1 Fine tune range cover -5 ~ +5 MHz of the currently displayed program channel, 62.5 khz per step.
- 2 Press the VOL- or VOL+ button to adjust the frequency.

Skip

Processing channel adding and erasing from tuner memory.

Select the channel first, then press the VOL- or VOL+ button to select "On" for channel erasing or "Off" for channel adding.

Note:

To erase a channel from the memory you must select a channel with the numeric keys only, not by the PR ▲ or PR ▼ button.



Audio Format

- 1 Press the VOL+ and the Enter button to select "I", "BG", "L", "DK" sound system, depending on your local broadcasting system.

Preview

- 1 Press the VOL+ and the Enter button to preview all memorized channel sequentially, each channel displays for 2 seconds.
- 2 Press the EXIT button to stop preview.

Auto Sort

- 1 Select Auto Sort Selection.
- 2 Press the VOL+ and the Enter button to change the sequence of the preset TV Channel.

Reset Channel

Remove currently selected channels from Memory Channel.

Channel Edit

Input the channel number which is to be swapped by press digits (0~9), also the channel name will be changed simultaneously.

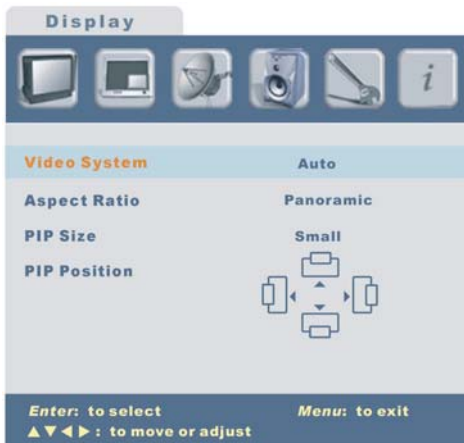

B) PIP / POP Settings

- 1 Press the PIP/POP button of the remote controller to enter the PIP/POP mode.
- 2 Press the PIP/POP button repeatedly to cycle through the following options:

PIP(Small)--> PIP(Medium)--> PIP(Large)--> POP--> POP(16:9) --> Multi POP--> Off

Change source of input signal for PIP screen (Input)

- 1 Press the INPUT button of the PIP/POP area to change the input signal for PIP
- 2 Press this button repeatedly and PIP will cycle according to the signal to be displayed.
- 3 Press the Input button of the PIP/POP area to change the POP input signal directly.

PIP TV Channel Select (PR+ / PR-)

- 1 When the PIP screen is ON, press the PR+ button of the PIP area to adjust PIP to number-up channel.
- 2 Press the PR- button for adjusting to a smaller-number channel.

PIP/POP Exchange (SWAP)

When the PIP/POP screen is ON, press the SWAP button for exchange of PIP/POP screens.

Change PIP size under PIP Mode

When PIP/POP is ON and under PIP Mode, press MENU button to enter the PIP Size Selection on Display page, and select the PIP size such as Large, Medium, Small, or directly press PIP/POP Key on remote controller to change PIP size.

Change PIP position under PIP Mode

When PIP/POP is ON and under PIP Mode, press the MENU button to enter the PIP Position Selection on Display page, press Up, Down, Right, Left to change PIP position, or under status of OSD not actuated.

C) Favorite Channels Setting:

Add/Delete Favorite Programmers

Switch TV channel to personal frequently watching or personal favorite group programmers, at this moment,

Press the FAV. ADD/DEL button on the remote controller, if that channel has not be covered under favorite channels, then System will list it into that corresponding channel sequence to that group according to the number of channel, on the contrary if that channel has been attributed to personal favorite group setting, then press that Key will delete it from Favorite Group.

Call Favorite Channels

When Favorite Channel Group contain personal favorite channel setting, continuously press the FAV button on remote controller and Channel No. will appear according to channel number setting, just like the function of TV PR? Key.

Other

When you want to switch to a favorite channel in the FAV Group, when it is intended to switch to that channel, add "F" before the Channel No., such as Channel 8 to become F 8; during regular operation of the PR ▲ or PR ▼ button, that "F" note will appear on the screen.

D) TELETEXT Application

For Scart2 / AV / TV, not support SCART1 and component.

(1) Teletext application only support Teletext B, not support Teletext A.

(2) TELETEXT Hot Key as following:

■ **Text Switch: On-->Off for AV1/TV**

- Text mode: When start this function, the Menu Right /Left, Quick Menu, Input, PC, Video keys are no action.
Program up/down: Page up/down
Digit keys: Page number
- Sync Loss: Return Normal Mode.
- Auto key: Return Normal Mode.

■ **Reveal**

This function can be used on certain pages to reveal the solution of riddles.

- Press the REVEAL button to reveal a hidden answer.
- Press again to hide it.

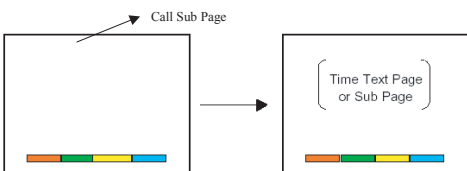
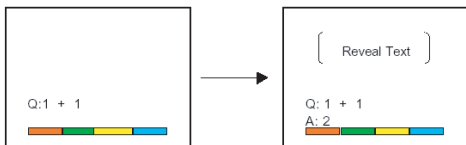

■ **Teletext Timer (Call Sub Pages)**

In TV mode this command display clock at right-top corner.

In TEXT mode this command activates the sub page mode, i.e. any sub-page of the current basic display chapter can be assessed by specifying 4 digits. The sub page mode is terminated if this command is issued again, or if any other page select method (index) is used. Use the red and green buttons to select the next and the previous sub code.

If any basic page is requested in sub-page 'don't care' mode and in sub page 'do care' mode with a special sub code (i.e. by use of a LIST page), this sub page is stored in the chapter with the 'don't care' mode.

When sub page mode command is given, the sub page start value is '0001'. Sub-page digit inputs are valid from 0000 to 3979 (no hex numbers).

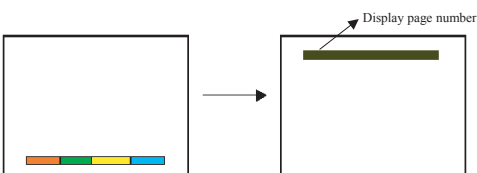

■ **Cancel (Updating)**

This key is used to cancel TEXT display but it will still be in the TEXT Mode.

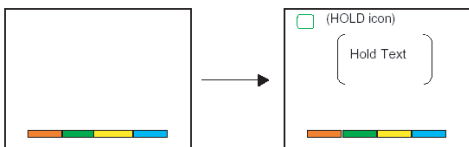
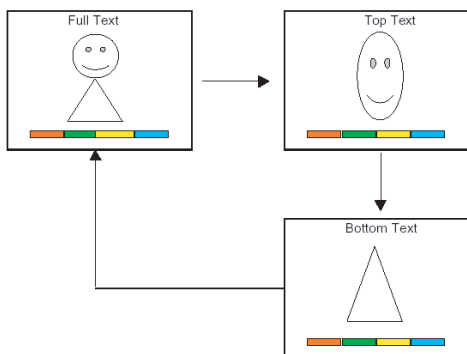

■ Size

This command switches between three possible display size in the following order:

- Normal size: Row 0..24 are displayed on screen with normal height.
- Double size upper half: Row 0 ...11 are displayed on screen with double height.
- Double size lower half: Row 12...23 are displayed on screen with double height.

The function is cancelled if any page selection (digit, page +/-, color keys, index...) related command is received.

■ Hold

In the Hold mode, the update of the current display page is halted so that the content will not be changed. When hold mode is active, the user-request page number display field on the top left hand corner is replaced by Hold mode icon. This command toggles the hold mode on / off and is enabled only in text / mix mode.

The hold mode is automatically cleared when a new page is selected, display cancel mode is activated or if TEXT mode is existed.

■ Index

This command selects the index page as defined by the broadcaster. By default, if the index page number is not defined by the broadcaster, page 100 will be selected. Usually page 100 default index page.

- In FLOF mode there will be a change to the index page of FLOF broadcaster.
- If there is no index page linked the selected page by this command will be page 100 if no packet 8/30 index page is available.
- In TOP or normal mode the index page requested will be page 100 if no packet 8/30 is available.
- If packet 8/30 is available the index page will be the index page of this packet.

■ Mix

Press the MIX button in teletext mode to see the program content also in the back ground.
Press again and the program content will disappear.

■ Red, Green, Yellow, Blue Key

In the TOP / FLOF automatic navigation mode, this key selects and displays the page linked to the yellow color display prompt in row 24.

9. OPTIONAL ACCESSORIES

The following accessories are available and may be purchased from your local sales representative:

- Composite Video Cable (RCA)
- S-Video Cable (Mini-DIN)
- Component Video Cable (RCA to RCA)
- Audio Cable (RCA Cable)
- RGB Cable
- Stand
- Speakers
- Wall Mount Rack 0-20, adjustable

Stand Installation

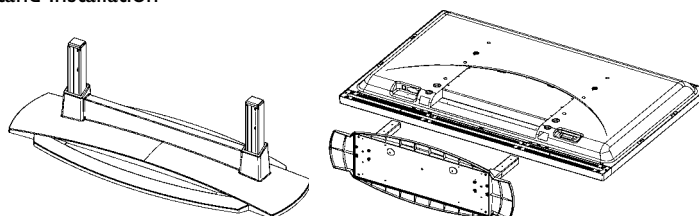

Speakers I



Speakers II

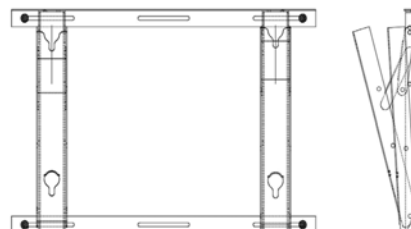

Wall-mount rack
0°-20°, adjustable

10. TECHNICAL SPECIFICATIONS

Display Panel

Screen Size	46"
Display Area	1007 mm (width) x 567 mm (height)
Aspect Ratio	16:9
Resolution	852 (Horizontal) x 480 (Vertical) pixels (Each pixel includes R/G/B dots)
Pixel Pitch	VGA 1182mm (Horizontal) x 1.182 mm(Vertical) XGA 1182mm (Horizontal) x 1.182 mm(Vertical)
Viewable Angle	Over 160°both horizontal and vertical

Operating Conditions

Temperature	0°C to +40°C
Relative Humidity	20% to 80%, no condensation condition
Pressure	800 to 100hPa

Power Source

Input Voltage	100 ~ 120Vac/220~240Vac; 50/60 Hz
Power Consumption	VGA 330Watts (general) XGA 390Watts (general)

Colors

Colors	16,7 Mega (256 grade for each R/G/B)
Gray tone	256 (R/G/B@8bit)

Sound

Sound effect	SRS
Gray tone	256 (R/G/B@8bit)

Connections

PC module	Sub-D 9-pin (for RS-232 signal) Sub-D 15-pin (for analog RGB input) DVI 24-pin (for digital TMDS input)
Video module	SCART ! SCART 2 CVBS IN: RCA Component Y/Pb(Cb)/Pr(Cr): RCA Audio Out: RCA L/R Phone jack 3,5 mm for Audio in

Safety

Safety Standards	CE, FCC, UL, C-UL, TUV and CCC
------------------	--------------------------------

Standard Accessories

Remote controller
2 Batteries UM4
User Manual on CD-Rom
Power cord
AV cable
D-Sub cable

RGB/DVI for VESA Standard

This monitor supports many kind of input signals.

These Factory default signals (RGB mode) are shown in the table below:

N0	Dot x Line	Horizontal Frequency (KHz)	Vertical Frequency (KHz)	Dot Clock Frequency (MHz)	Remark
1	720 x 400	31.47	70.08	28.32	DOS
2	640 x 400	37.90	85.00	31.50	VESA
3	640 x 480	31.50	60.00	25.18	DOS
4	640 x 480	35.00	67.00	30.24	Mac.(SOG)
5	640 x 480	37.50	75.00	31.50	VESA
6	640 x 480	37.86	72.81	31.50	VESA
7	640 x 480	43.30	85.00	36.00	VESA
8	800 x 600	35.16	56.25	36.00	VESA
9	800 x 600	37.90	60.32	40.00	VESA
10	800 x 600	46.90	75.000	49.50	VESA
11	800 x 600	48.08	72.19	50.00	VESA
12	800 x 600	53.70	85.00	56.25	VESA
13	832 x 624	49.00	74.00	57.27	Mac.(H+V)
14	1024 x 768	48.40	60.00	65.00	VESA
15	1024 x 768	56.50	70.00	75.00	VESA
16	1024 x 768	60.00	75.00	78.75	VESA
17	1024 x 768	68.70	85.00	94.50	VESA
18	1280 x 1024	64.00	60.00	108.00	VESA

Notes:

- If the signal source is out of range of the monitor, the message "Signal Out of Range" will be displayed on the screen.
- You can confirm the format of signals from the Information Menu under the OSD menu

11. CLEANING AND TROUBLESHOOTING

11.1 CLEANING

Cautions When Using the Plasma Display

- Do not bring your hands, face or objects close to the ventilation holes of the plasma display. Top of plasma display is usually very hot due to the high temperature of exhaust air being released through the ventilation holes. Burns or personal injuries may occur if any body parts are brought too close. Placing any object near the top of the display could also result in heat related damages to the object as well as the display itself.
- Be sure to disconnect all cables before moving the plasma display. Moving the display with its cables attached may damage the cables and thus case fire or electric shock danger.
- Disconnect the power plug from the wall outlet as a safety precaution before carrying out any type of cleaning or maintenance procedure.

Front Panel Cleaning Instructions

- The front of the display has been specially treated. Wipe the surface gently using only a cleaning cloth or a soft, lint-free cloth.
- If the surface is particular dirty, soak a soft, lint-free cloth in a mild detergent solution. Wring the cloth to remove excess liquid. Wipe the surface of the display to remove dirt. Then use a dry cloth of the same type to dry.
- Do not scratch or hit the surface of the panel with fingers or hard objects of any kind.
- Do not use volatile substances such as insect sprays, solvents and thinners.

Cabinet Cleaning Instructions

- If the cabinet becomes dirty, wipe the cabinet with a soft, dry cloth.
- If the cabinet is extremely dirty, soak a lint-free cloth in a mild detergent solution. Wring the cloth to remove as much moisture possible. Wipe the cabinet. Use another dry cloth to wipe over until the surface is dry.
- Do not allow any water or detergent to come into contact with the surface of the display. If water or moisture gets inside the unit, operating problems, electrical and shock hazards may result.
- Do not scratch or hit the cabinet with fingers or hard objects of any kind.
- Do not use volatile substances such as insect sprays, solvents and thinners on the cabinet.
- Do not place anything made from rubber or PVC near the cabinet for any extended periods of time.

11.2 TROUBLESHOOTING

Symptom	Possible Cause	Remedy
No picture is displayed	<ol style="list-style-type: none"> 1 The power cord is disconnected. 2 The main power switch on the back of the monitor is not switched on. 3 The selected input has no connection. 4 The monitor is in standby mode in RGB mode. 	<ol style="list-style-type: none"> 1 Plug in the power cord. 2 Make sure the power switch is switched on. 3 Connect a signal connection to the monitor. 4 Press any key on your keyboard.
Interference displayed on the monitor or audible noise is heard	Caused by surrounding electrical appliances, cars/ motorcycles or fluorescent lights.	Move the monitor to another location to see if the interference is reduced.
Color is abnormal	The signal cable is not connected properly.	Make sure that the signal cable is attached firmly to the back of the monitor.
Picture is distorted with abnormal patterns	<ol style="list-style-type: none"> 1 The signal cable is not connected properly. 2 The input signal is beyond the capabilities of the monitor. 	<ol style="list-style-type: none"> 1 Make sure that the signal cable is attached firmly. 2 Check the video signal source to see if it is beyond the range of the monitor. Please verify its specifications with this monitor's specification section
Display image doesn't fill up the full size of the screen	<ol style="list-style-type: none"> 1 If under RGB mode, the H-Size and V-Size is incorrectly set. 2 If under AV1, AV2, or Component with 480i input, the 4:3 WIDE mode is switched on. 	<ol style="list-style-type: none"> 1 Use H-Size and V-Size to adjust the size of the video. 2 Use the WIDE key to scroll through various full screen modes.
Can hear sound, but no picture	Improperly connected source signal cable. 1.	Make sure that both video inputs and sound inputs are correctly connected.
Can see picture but no sound is heard	<ol style="list-style-type: none"> 1 Improperly connected source signal cable. 2 Volume is turned all the way down. 3 MUTE is turned on. 	<ol style="list-style-type: none"> 1 Make sure that both video inputs and sound inputs are correctly connected. 2 Use VOLUME +/- to hear sound. 3 Switch MUTE off by using the MUTE button.
Some picture elements do not light up	Some pixels of the plasma display may not turn on	<p>This monitor is manufactured using an extremely high level of precision technology; however, sometimes some pixels of the monitor may not display.</p> <p>This is not a malfunction. Please see the enclosed warranty card for more information.</p>
After-Images can still be seen on the monitor after the monitor is powered off. (Examples of still pictures include logos, video games, computer images, and images displayed in 4:3 normal mode)	A still picture is displayed for an over extended period of time.	Do not allow a still image to be displayed for an extended period of time as this can cause a permanent after-image to remain on the monitor.

12. LIMITED WARRANTY (USA)

Two Year Free Labor

Two Year Free Parts

WHO IS COVERED?

You must have proof of the date purchased to receive warranty service. A sales receipt or other document showing the date that you purchased the product is considered proof of purchase.

WHAT IS COVERED?

Warranty coverage begins the day you buy your product. For two years thereafter, all defective parts will be repaired or replaced and labor is free. After two years from the day of purchase, you pay for the replacement or repair of all parts, and for all labor charges. All parts, including repaired and replaced parts, are covered only for the original warranty period. When the warranty on the product expires, the warranty on all replaced and repaired parts also expires.

WHAT IS EXCLUDED?

Your warranty does not cover:

- labor charges for removal, installation or setup of the product, adjustment of customer controls on the product, and installation or repair of antenna systems outside of the product.
- product repair and/or part replacement because of misuse, accident, unauthorized repair or other cause not within the control of Philips Consumer Electronics North America.
- reception problems caused by signal conditions or cable or antenna systems outside the unit.
- a product that requires modification or adaptation to enable it to operate in any country other than the country for which it was designed, manufactured, approved and/or authorized, or repair of products damaged by these modifications.
- incidental or consequential damages resulting from the product. (Some states do not allow the exclusion of incidental or consequential damages, so the above exclusion may not apply to you. This includes, but is not limited to, prerecorded material, whether copyrighted or not copyrighted.)
- modifications or adaptations to enable the product to operate in any country other than the country for which it was designed, manufactured, approved and/or authorized, or the repair of products damaged by these modifications.
- normal wear and tear (decreased light output of PDP module) over the product's lifetime.
- phosphor burn. Do not display static images for prolonged periods, otherwise phosphor burn might appear on part of the panel.
- limited quantity of cells (fine pixel elements) that do not produce light, or that remain lit after they should have turned off.

WHERE IS SERVICE AVAILABLE?

Warranty service is available in all countries where the product is officially distributed by Philips Consumers Electronics North America. In countries where Philips Consumers Electronics North America does not distribute the product, the local Philips service organization will attempt to provide service (although there may be a delay if the appropriate spare parts and technical manual(s) are not readily available).

MAKE SURE YOU KEEP ...

Please keep your sales receipt or other document showing proof of purchase. Attach it to this owner's manual and keep both nearby. Also keep the original box and packing material in case you need to return your product.

BEFORE REQUESTING SERVICE ...

Please check your owner's manual before requesting service. Adjustments of the controls discussed there may save you a service call.

**TO GET WARRANTY SERVICE U.S.A.,
PUERTO RICO OR US VIRGIN ISLANDS ...**

Please contact Philips at:

1-877-835-1838

or an authorized service center to arrange repair. (In U.S.A., Puerto Rico and U.S. Virgin Islands, all implied warranties, including implied warranties of merchantability and fitness for a particular purpose, are limited in duration to the duration of this express warranty. But, because some states do not allow limitations on how long an implied warranty may last, this limitation may not apply to you.)

TO GET WARRANTY SERVICE IN CANADA ...

Please contact Philips at:

800-661-6162 (French Speaking) (within Canada only)

800-531-0039 (English Speaking)

(In Canada, this warranty is given in lieu of all other warranties. No other warranties are expressed or implied, including any implied warranties of merchantability or fitness for a particular purpose. Philips is not liable under any circumstances for any direct, indirect, special, incidental or consequential damages, howsoever incurred, even if notified of the possibility of such damages.)

REMEMBER ...

Please record the model and serial numbers found on the product below. Also, please fill out and

mail your warranty registration card promptly. It will be easier for us to notify you if necessary.

MODEL # _____

SERIAL # _____wo____

13. LIMITED WARRANTY (EUR)

Two Year Free Labor

Two Year Free Parts

WHO IS COVERED?

You must have proof of the date purchased to receive warranty service. A sales receipt or other document showing the date that you purchased the product is considered proof of purchase.

WHAT IS COVERED?

Warranty coverage begins the day you buy your product. For two years thereafter, all defective parts will be repaired or replaced and labor is free. After two years from the day of purchase, you pay for the replacement or repair of all parts, and for all labor charges. All parts, including repaired and replaced parts, are covered only for the original warranty period. When the warranty on the product expires, the warranty on all replaced and repaired parts also expires.

WHAT IS EXCLUDED?

Your warranty does not cover:

- labor charges for removal, installation or setup of the product, adjustment of customer controls on the product, and installation or repair of antenna systems outside of the product.
- product repair and/or part replacement because of misuse, accident, unauthorized repair or other cause not within the control of Philips Consumer Electronics Europe.
- reception problems caused by signal conditions or cable or antenna systems outside the unit.
- a product that requires modification or adaptation to enable it to operate in any country other than the country for which it was designed, manufactured, approved and/or authorized, or repair of products damaged by these modifications.
- incidental or consequential damages resulting from the product. (Some states do not allow the exclusion of incidental or consequential damages, so the above exclusion may not apply to you. This includes, but is not limited to, prerecorded material, whether copyrighted or not copyrighted.)
- modifications or adaptations to enable the product to operate in any country other than the country for which it was designed, manufactured, approved and/or authorized, or the repair of products damaged by these modifications.
- normal wear and tear (decreased light output of PDP module) over the product's lifetime.
- phosphor burn. Do not display static images for prolonged periods, otherwise phosphor burn might appear on part of the panel.
- limited quantity of cells (fine pixel elements) that do not produce light, or that remain lit after they should have turned off.

WHERE IS SERVICE AVAILABLE?

Warranty service is available in all countries where the product is officially distributed by Philips Consumers Electronics Europe. In countries where Philips Consumers Electronics Europe does not distribute the product, the local Philips service organization will attempt to provide service (although there may be a delay if the appropriate spare parts and technical manual(s) are not readily available).

MAKE SURE YOU KEEP ...

Please keep your sales receipt or other document showing proof of purchase. Attach it to this owner's manual and keep both nearby. Also keep the original box and packing material in case you need to return your product.

BEFORE REQUESTING SERVICE ...

Please check your owner's manual before requesting service. Adjustments of the controls discussed there may save you a service call.

**TO GET WARRANTY SERVICE,
OR IF YOU HAVE QUESTIONS ...**

Please contact Philips at one of the telephone numbers below:

Austria	0820 901115
Belgium	070 253 010
Denmark	3525 8761
Finland	09 2290 1908
France	08 9165 0006
Germany	0180 5 007 532
Greece	0 0800 3122 1223
Ireland	1 601 1161
Italy	199 404 042
Luxembourg	26 84 30 00
Netherlands	0900 0400 063
Norway	2270 8250
Portugal	2 1359 1440
Spain	902 888 785
Sweden	08 632 0016
Switzerland	02 2310 2116
United Kingdom	0906 1010 017

Repair must be performed by an authorized service center or a factory service center. If you do not live near a factory service center, contact your dealer. If your dealer is an authorized service center, he will arrange repair.

REMEMBER ...

Please record the model and serial numbers found on the product below. Also, please fill out and mail your warranty registration card promptly.

It will be easier for us to notify you if necessary.

MODEL # _____

SERIAL # _____wo_____

14. APPENDIX

14.1 WALL-MOUNT INSTALLATION GUIDE

- 1 Empty contents of the package. Make sure the following items are present;
 - Left Wall Angle Module (A)
 - Right WallAngle Module (B)
 - Horizontal Support (C)
 - Horizontal Support (D)
 - Screws for Fix Angle x 8 (E)
 - Screws for Wooden Wall Mounting x 8 (F)
 - Screws for Cement Wall Mounting x 8 (G)
 - Screws and Pegs for monitor x 4 (H)
 - Rubber Covers x 2 (I)
 - Screw x 4 (J)
- 2 Attach Horizontal Supports (C and D) to the Left and Right Wall Angle Module (A and B) using eight screws (E).
- 3 Install the Wall Mount Bracket onto the wall.

Notes:

The screws in this package are for mounting on a wooden or a brick wall. Different kind of wall needs different type of screws.

Please consult with a qualified installer to make sure your wall is capable of supporting this bracket and the monitor.

- 4 Adjust the mounting direction and inclination angle (0, 5, 10, 15 degrees) by adjusting the screws position on the Wall Mounting AngleModule.
- 5 Insert the two Rubber Covers to the holes at the bottom of the monitor after removing the table-top stand from the monitor.

Note:

Actual rear cabinet may vary from the drawing.

- 6 Remove the table-top stand from the monitor. Screw in the four pegs at the rear of the monitor.
- 7 Install the monitor onto the Wall Mount Bracket by placing the four pegs, located on the rear of the monitor, inside the mounting holes of the Wall Angle Modules. Make the four pegs firmly seated in the holes.
- 8 Put the monitor on the Wall Mount, by matching the 4 pegs to the holes on Wall Mount.
Use accessory J and the screws to secure the monitor to the Wall Mount by tightening the screws through the holes from both sides of the Wall Mount.

Notes:

- Wall mount bracket is an optional accessory, please contact your local sales agent for more information.
- This type of equipment is to be installed by qualified installers, please contact with authorized dealer for installation.
- Please make sure that your wall is capable of supporting this wall mount and the monitor which can easily weigh over 60 kg.