

# BeoVision 7

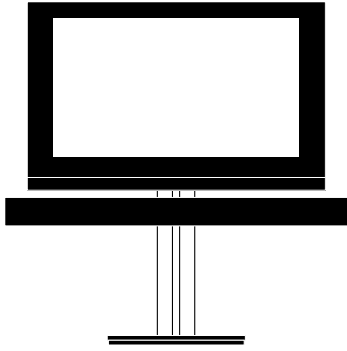

# Contents

## **Menu overview, 3**

See an overview of on-screen menus.

## **Digital tuner menu overview, 4**

See an overview of the digital tuner menu.

## **Blu-ray menu overview, 5**

See an overview of the Blu-ray menu.

## **Navigate in menus, 6**

See how to use the different remote controls for menu operation.

## **First-time setup, 7**

Which menus appear when you switch on the television for the very first time.

## **Set positions for the television to turn to, 9**

How to preset positions for a motorised stand to turn to.

## **Tuner setup, 10**

How to disable the TV tuner or the ATSC tuner.

## **Connections, 11**

Examples of where to connect additional equipment and how to connect a PC or camera.

## **Register additional video equipment, 15**

How to register connected equipment in the CONNECTIONS menu.

## **Scan in TV channels, 18**

How to register the source of your TV signal type and scan in TV channels.

## **Edit scanned TV channels, 20**

How to remove, name and fine tune channels, and how to find new channels.

## **Loudspeaker setup – surround sound, 24**

How to make your television part of a surround sound system.

## **Adaptive Sound Technology, 29**

How to set up loudspeakers and optimise the sound experience with Adaptive Sound Technology.

## **Adjust picture and sound settings, 34**

How to make settings for picture and how to adjust bass, treble, etc. How to use game mode.

## **Set up 3D television, 37**

How to make settings for when you watch 3D television.

## **Daily use of speaker combinations, 39**

How to switch between different speaker combinations.

## **See two sources at the same time, 40**

How to see two sources at the same time.

## **Home cinema, 41**

How to set up your system for Home cinema.

## **Set the television to switch itself on or off, 42**

How to make your television switch off automatically or make it part of a PLAY TIMER. How to make auto standby settings.

## **Wake-up Timer, 45**

How to make your television wake you up in the morning.

## **Set the time and date, 47**

How to set the time and date.

## **Activate parental control, 48**

How to activate parental control to restrict access to selected channels.

## **Apply Closed Captioning, 51**

How to apply Closed Captioning to sources and channels.

## **Settings and preferences for the digital tuner, 52**

How to make channel settings, search for channels and apply Closed Captioning.

## **Settings and preferences for the Blu-ray player, 56**

How to make settings and preferences for the Blu-ray player and its parental lock function.

## **Blu-ray player - media browser, 58**

How to browse your photos and playback your music files on your television .

## **The pincode system, 59**

How to use the pincode system.

## **Set up your remote control, 61**

Tell the television if the navigation button on your remote control is enabled or disabled.

## **Feature activation, 62**

How to enter an activation key and get access to additional features.

## **HDMI MATRIX, 63**

How to enter settings in the HDMI MATRIX menu.

## **Operate other equipment with Beo6 or Beo4, 65**

How to operate connected equipment, such as set-top boxes, DVD players or the like.

## **Connect and operate an audio system, 67**

How to connect an audio system to your television and operate an integrated audio/video system.

## **Distribute sound and picture with BeoLink, 70**

How to make link connections, operate a link system.

## **Your television in a link room, 72**

How to set up and operate your television in a link room.

## **Two televisions in the same room, 74**

Option programming and operation of two televisions in the same room.

# Menu overview

1.

CHANNEL SETUP

3D DISPLAY

SLEEP TIMER

PLAY TIMER

OPTIONS

STAND POSITIONS

2.

EDIT CHANNELS

FINE TUNE

3D

2D

3D SETTINGS

TIMER ON/OFF

PLAY TIMER INDEX

PLAY TIMER PROGRAMMING

WAKE-UP TIMER

CONNECTIONS

TUNER SETUP

SOUND

(When Adaptive Sound Technology is OFF)

SOUND

(When Adaptive Sound Technology is ON)

PICTURE

CLOSED CAPTIONING

PARENTAL CONTROL

CLOCK

AUTO STANDBY

REMOTE CONTROL

FEATURE ACTIVATION

VIDEO

AUDIO

STANDBY

STAND ADJUSTMENT

3.

ACTIVATE 3D

3D SHARPNESS

AV1–AV6

PROJECTOR OUT

HDMI EXPANDER

LINK

TV TUNER

ATSC

ADJUSTMENT

SPEAKER TYPES

SPEAKER ROLES

SPEAKER DISTANCE

SPEAKER LEVEL

SOUND SYSTEM

AST ON/OFF

ADJUSTMENT

SPEAKER SETUP

LISTENING PRESETS

SOUND SYSTEM

AST ON/OFF

TV PARENTAL GUIDELINES

MPAA RATING

ACCESS CODE

NAVIGATION BUTTON

NO NAVIGATION BUTTON

# Digital tuner menu overview

## Digital tuner settings

1.	2.	3.
CHANNEL	AUTO SCAN	AIR CABLE AUTO CABLE STD CABLE HRC CABLE IRC
	FAVOURITE CHANNEL CHANNEL ADD/DELETE SIGNAL STRENGTH	
CAPTION	ON/OFF ANALOGUE MODE DIGITAL MODE DIGITAL FONT OPTIONS	
V-CHIP	CHANGING PIN US RATING SETTING CANADIAN RATING SETTING DOWNLOADABLE RATING SETTING	
SETUP	TIME	DAYLIGHT SAVING TIMEZONE
	SOUND	MULTI-TRACK SOUND DIGITAL OUTPUT
	MENU LANGUAGE	ENGLISH SPANISH FRENCH
	VERSION INFORMATION	

## Digital tuner settings (Korea)

1.	2.	3.
CHANNEL	AUTO SCAN	AIR CABLE
	FAVOURITE CHANNEL CHANNEL ADD/DELETE SIGNAL STRENGTH	
SETUP	MULTI-TRACK SOUND DIGITAL OUTPUT VERSION INFORMATION	

# Blu-ray menu overview

1.

SETUP

2.

PLAYBACK STATUS

AUDIO FORMAT

VIDEO FORMAT

LANGUAGE

ACCESS CONTROL

ADVANCED

3.

STANDARD

EXTENDED

STANDARD

RE-ENCODE

BITSREAM

24 HZ ON

24 HZ OFF

AUDIO

SUBTITLES

DISC MENU

PARENTAL LOCK

RATING

NEW ACCESS CODE

MEMORY MANAGEMENT

NETWORK

MODULE INFORMATION

SOFTWARE UPDATE

# Navigate in menus

## Beo6

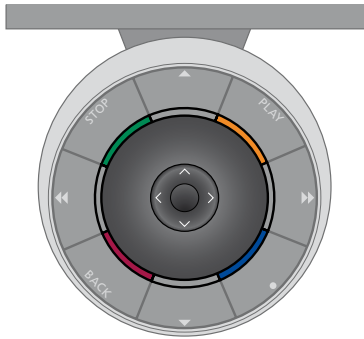

If you operate your television with the Beo6 remote control, you use the centre button with up, down, left and right movement to navigate in menus. Press in the middle of the centre button to confirm selections and settings in menus.

Bring up the TV SETUP menu by pressing **Menu** while the TV is on.

To back up through menus, press **BACK**.  
To exit menus, press and hold **BACK**.

If your Beo6 is set up to be used without navigation button, press **STOP** to back up through menus and **BACK** to exit menus.

Note that a Beo6 should be reconfigured when you add new products to your setup.

You can also operate your television with Beo5 which is operated similarly to Beo6.

---

## Beo4 with navigation button

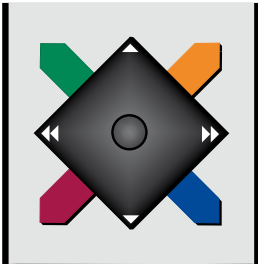

If you have a Beo4 remote control with navigation button and your television is set up for use with it, [see page 61](#), you use the centre button with up, down, left and right movement to navigate in menus. Press in the middle of the centre button to confirm selections and settings in menus.

Bring up the TV SETUP menu by pressing **MENU** while the TV is on. If you have selected a source which has a menu overlay, you must press **MENU** twice to bring up the TV SETUP menu.

To back up through menus, press **BACK**.  
To exit menus, press and hold **BACK**.

If your television is set up for use without navigation button, you must use the 'star' to navigate up, down, left and right in menus and press the centre button to confirm selections and settings in menus. To back up through menus, press **STOP**. To exit menus, press **BACK**.

---

## Beo4 without navigation button



If you have a Beo4 remote control without navigation button, you must use the 'star' to navigate up, down, left and right in menus and press the centre button to confirm choices and settings in menus.

Bring up the TV SETUP menu by pressing **MENU** while the TV is on. If you have selected a source which has a menu

overlay, you must press **MENU** twice to bring up the TV SETUP menu.

To back up through menus, press **STOP**.  
To exit menus, press **EXIT**.

# First-time setup

The setup procedure is activated when the television is connected to the mains and switched on for the first time. You are led through an automatic series of on-screen menus in which you must register the extra equipment you have connected, such as a projector and loudspeakers.

If you change your setup at a later date, you can access the same menus and update your settings. Remember that you need to set the speaker types and the distances in the SOUND SETUP menu.

The contents of the first-time setup sequence varies according to the setting you make in the AST ON/OFF menu.

## The sequence of menus in first-time setup

REMOTE CONTROL ... Enable or disable the navigation button on your remote control. [See page 61](#) for information about setting up your remote control. [See page 6](#) for information about remote controls.\*

TUNER SETUP ... Disable the television tuner or ATSC tuner, if you like, or scan in channels and identify a connected cable box, [see page 10](#).

CONNECTIONS ... Select the type of equipment you have connected to each socket group, the sockets used, the product name, and the source name. For further information about the CONNECTIONS menu, [see page 15](#).

CHECK AERIAL CONNECTION ... This prompt only appears if the television tuner is enabled.

AST ON/OFF ... In this menu, you can choose between a speaker setup menu with or without Adaptive Sound Technology. The default setting is OFF. For further information about Adaptive Sound Technology, [see page 29](#).

*\*If you have a Beo4 without a navigation button or if your Beo4 is not set to the correct mode, you cannot enable the navigation button. See the Beo4 guide or contact your Bang & Olufsen retailer for further information. However, do not change mode during first-time setup, as this will interrupt the sequence.*

**Adaptive Sound Technology disabled:**

SPEAKER TYPES ... In this menu, you select which speakers are connected to the television, if any. [See page 24](#) for further information.

TV SPEAKER ROLES ... In this menu, you select the function for each connected speaker in your setup, such as front, back or surround. As you highlight each speaker, a sound is produced by the speaker. Check that the speaker type highlighted in the menu matches the speaker type making the sound. [See page 25](#) for further information.

SPEAKER DISTANCE ... In this menu, you select the distance in metres to each of the speakers in your setup. [See page 26](#) for further information.

SPEAKER LEVEL ... In this menu, you can adjust the volume level of each speaker in your setup. [See page 27](#) for further information.

SOUND ADJUSTMENT ... In this menu, you can adjust bass, volume, treble and loudness. In addition, you can preset two default speaker combinations; one for video sources and one for audio sources connected to your television. [See page 36](#) for further information.

## >> *First-time setup*

### **Adaptive Sound Technology enabled:**

**SPEAKER SETUP ...** In this menu, you register the speaker type in the menu. Enter the straight-line distances from two points, Points A and B to each speaker, to the left and right sides of the television screen and a projector screen, to a viewing position and the distance between the two points. [See page 31](#) for further information.

**TV ...** Select the speakers to be active when you watch television and determine the distance from your listening position to three of the activated speakers. You can enable Adaptive Sound Technology or set the speaker roles and levels. [See page 32](#) for further information.

**CINEMA ...** Select the speakers to be active for a connected projector and determine the distance from your listening position to three of the activated speakers. You can enable Adaptive Sound Technology or set the speaker roles and levels. This menu is only available if you have connected a projector. [See page 32](#) for further information.

**SOUND ADJUSTMENT ...** In this menu you adjust volume, bass, treble, and loudness. In addition, you can select two default speaker combinations; one for video sources and one for audio sources connected to your television. You can also select which LISTENING PRESET should be activated when you switch on an audio source. If you select the option MANUAL, the preset used when switching on the audio source continues to be active and if all your sources are switched off, the preset used before switching on the audio source is automatically activated. If you select one of your LISTENING PRESETS, this preset is activated every time you switch on an audio source. [See page 36](#) for further information.

**SOUND SETUP ...** Enter the LISTENING PRESETS menu and select a PRESET field. Then select the speakers to be active for different listening positions, such as at the dining table or in a favourite armchair, and determine the distance from your listening position to three of the activated speakers. You can enable or disable the Adaptive Sound Technology and either rotate the selected speaker setup or set the speaker roles and level. [See page 32](#) for further information.

### **Continue first-time setup:**

**STAND ADJUSTMENT ...** Set the maximum angle for turn and tilt of the television. Use ▲, ▼, ◀ and ▶ to tilt and turn the television and limit the movement of the stand. [See page 9](#) for further information.\*

**STAND POSITIONS ...** Set your preferred preset positions for the television. For further information about the STAND POSITIONS menu, [see page 9](#).

**AUTO STANDBY ...** The television can be set to switch itself to standby after some time with no operation. [See page 44](#) for further information.

*\*If you have a Beo4 remote control without navigation button, or if the navigation button on your remote control is disabled, use the **green** button to tilt the television up and the **red** button to tilt it down.*

*For information about where and how to connect extra equipment, see the chapter about connection panels in Getting Started.*



## Set positions for the television to turn to

If your television is equipped with the optional motorised stand, you can tilt and turn it using the remote control.

Furthermore, you can program the television to tilt and turn automatically to face your favourite viewing position when you switch on the television. It can tilt and turn to a different position when you listen to, for example, a connected radio, and tilt or turn away to a standby position when you switch it off.

You can also turn your television by hand.

**NOTE!** For information about first-time installation of the motorised stand, see *Getting Started*.

Choose one position for when you switch the television on, one for audio mode, and one for when you switch it off.

- > Bring up the TV SETUP menu and highlight STAND POSITIONS.
- > Press the **centre** button to bring up the STAND POSITIONS menu.
- > Press the **centre** button to determine the VIDEO position.
- > Use **▲**, **▼**, **◀** and **▶** to tilt and turn the television and place it according to your viewing position.
- > Press the **centre** button to store the position.

*To store a stand position for when an audio source is switched on from the television ...*

- > Highlight AUDIO.
- > Press the **centre** button to determine the AUDIO position.
- > Use **▲**, **▼**, **◀** and **▶** to tilt and turn the television and place it as you wish.
- > Press the **centre** button to store the position.

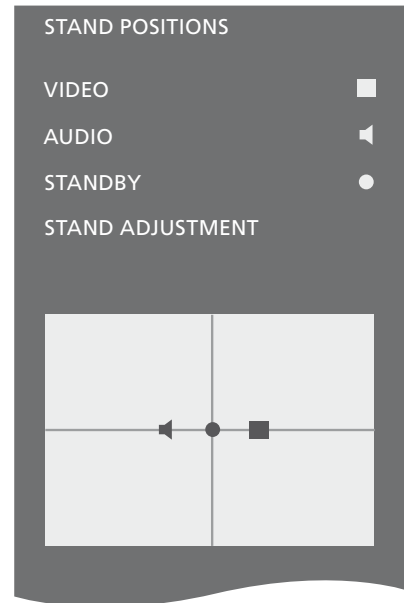

*To store a stand position for when the television is switched off and in standby ...*

- > Highlight STANDBY.
- > Press the **centre** button to determine the STANDBY position.
- > Use **▲**, **▼**, **◀** and **▶** to tilt and turn the television and place it as you wish.
- > Press the **centre** button to store the position.
- > During first-time setup, press the **green** button to continue first time-setup, or ...
- > ... press and hold **BACK** to leave all menus.

*If you have a Beo4 remote control without navigation button, or if the navigation button on your remote control is disabled, use the **green** button to tilt the television up and the **red** button to tilt it down.*

## Tuner setup

If you disable the TV tuner or ATSC tuner, you can activate a connected peripheral unit with the TV or DTV button.

In this menu you can also scan in channels or identify a cable box you may have connected to the television.

### *To disable the internal tuner ...*

- > Bring up the TV SETUP menu and highlight OPTIONS.
- > Press the **centre** button to bring up the OPTIONS menu, and highlight TUNER SETUP.
- > Press the **centre** button to bring up the TUNER SETUP menu and highlight TV TUNER.
- > Use the navigation button left or right to switch between the setting OFF, ANTENNA, CABLE or CABLE BOX.
- > Highlight ATSC.
- > Use the navigation button left or right to switch between the setting ON or OFF.
- > Press the **centre** button to store the settings, or ...
- > ... press and hold **BACK** to leave the menus without storing.

*If you select CABLE BOX, follow the on-screen information to specify which cable box you have connected to the television. If you select ANTENNA or CABLE, a scanning process begins when you store the setting.*

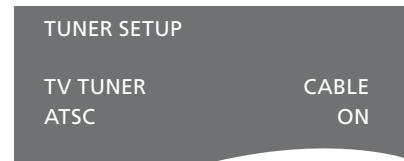

*You can register the source of your TV video signals in the TV TUNER field at any time, it is not required during the first-time setup procedure.*

*For further information about the TUNER SETUP menu and about scanning TV channels, [see page 18](#).*

# Connections

The connection panel on your television allows you to connect signal input cables as well as a variety of extra equipment, such as a video recorder or a linked Bang & Olufsen music system.

Any equipment you connect to these sockets must be registered in the CONNECTIONS menu. For further information, [see page 15](#).

Before you connect any equipment to your television, remember to disconnect the television from the mains.

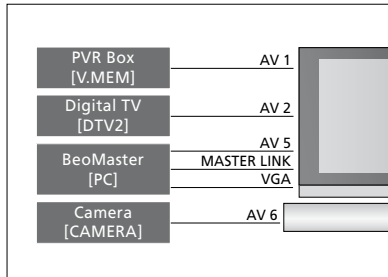
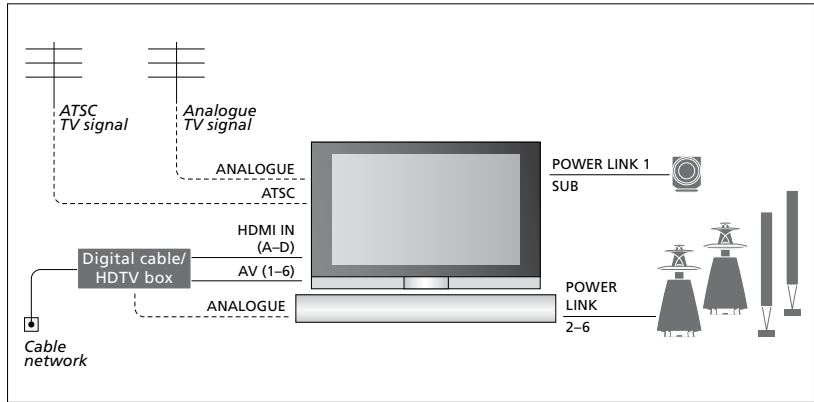

There are some restrictions as to the types of equipment that can be connected to the sockets.

Equipment with VGA output can only be connected and registered to the AV5 and AV6 sockets.

## Loudspeakers

Use Bang & Olufsen Power Link speakers. Use the cables enclosed with the speakers. Cables are available from your Bang & Olufsen retailer.

## Equipment with HDMI™ output

Equipment with HDMI output such as a set-top box can be connected to any available HDMI socket in the TV, regardless of the particular AV socket group to which you have connected the equipment. To distribute the source to another room you must also connect a CVBS video signal from the connected equipment to an AV socket on the connection panel. For further information on how to set up connected equipment for use, [see page 15](#).

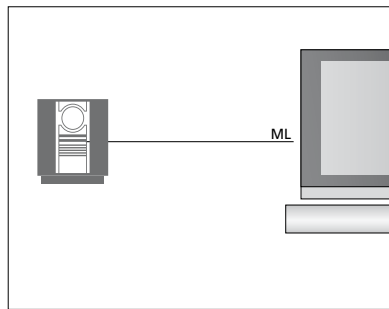
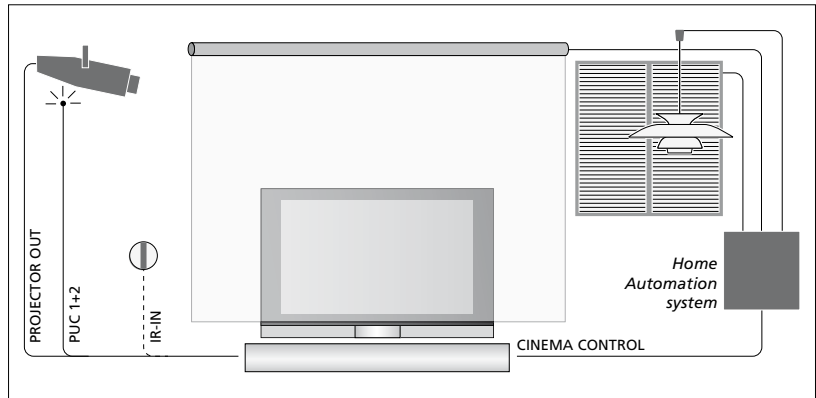

### Home cinema setup with a projector and a home automation system

Use a projector or connect a home automation system to the TV so you can control room lights and curtains.

If the built-in receiver for the remote control signals (IR-receiver) is hidden behind the lowered projection screen, you must set up an external IR-receiver, as well. The IR-receiver is available as an optional accessory from your Bang & Olufsen retailer.

### Audio system

If you have a Bang & Olufsen audio system with a Master Link socket, you can connect it to your television. Use a Master Link cable, and connect it to the Master Link socket on the main connection panel. See Getting Started for further information.

For further information about Home cinema, [see page 41](#).

## Control

In the AV menus you can select how a PUC controlled product is connected. You can choose between PLUG (cable) and IR (IR Blaster). If you select PLUG, you must choose between MODULATION ON and MODULATION OFF. For information about type of cable and modulation settings, contact your retailer.

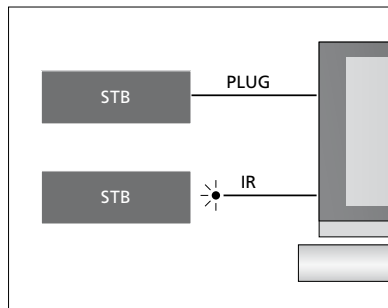

**IR-transmitters:** To operate non-Bang & Olufsen products with a Bang & Olufsen remote control, attach a Bang & Olufsen IR-transmitter to each of the products. Connect each transmitter to the corresponding socket marked PUC on the main connection panel.

## >> Connections

### **Connect and use a PC**

**IMPORTANT!** Before connecting a PC to the television, disconnect the television, the computer, and all equipment connected to the computer from the mains.

#### **To connect a computer to the television ...**

- > Using the appropriate type of cable, connect one end to the DVI, VGA or HDMI output socket on your computer, and the other end to the VGA or HDMI socket on the television.
- > To hear sound from the computer in the speakers connected to the television, use the appropriate cable and connect the sound output on the computer to the L-R or SPDIF sockets on the television when appropriate.
- > Reconnect the television, the computer, and all equipment connected to the computer to the mains. Remember, the computer must be connected to a grounded wall outlet as specified in its setting-up instructions.

*If you have connected your PC to the VGA socket on the television, you must register the PC to the AV5 or AV6 socket in the CONNECTIONS menu. A PC connected to the HDMI socket can be registered to any of the AV socket groups.*

### **Bring up the computer image on the screen**

To see the computer picture on the screen, you must bring it up with your remote control.

#### **To bring up the computer picture ...**

- > Press **PC** to bring up the picture. You can then operate the computer as you normally would. (Beo4: Press **LIST** and use the navigation button up or down to bring up **PC** in the Beo4 display and press the **centre** button to bring up the picture).

### **Watch digital pictures on your screen**

To watch your camera pictures, connect the camera to the AV6 socket(s) and switch the television on. The television automatically registers the signal and you can see the pictures on the screen.

#### **If the signal from the camera is switched off ...**

- > Press **CAMERA** on Beo6. (Beo4: Press **LIST** and use the navigation button up or down to bring up **CAMERA** in the Beo4 display and press the **centre** button to bring up the picture).

# Register additional video equipment

If you connect additional video equipment to your television, you must register the equipment in the CONNECTIONS menu.

When the television is first set up, some of the equipment connected at that particular moment is detected by the television. The CONNECTIONS menu appears automatically on the screen during first-time setup for you to register connected equipment, if it is not detected automatically by the television. If you connect equipment at a later date, you must register this equipment in the CONNECTIONS menu.

## What is connected?

Registering the equipment connected to the television enables you to operate it with your remote control.

- > Bring up the TV SETUP menu and highlight OPTIONS.
- > Press the **centre** button to bring up the OPTIONS menu. CONNECTIONS is highlighted already.
- > Press the **centre** button to bring up the CONNECTIONS menu.
- > Use the navigation button up or down to step between the different socket groups: AV1, AV2, AV3, AV5, AV6, PROJECTOR OUT, HDMI EXPANDER and LINK.
- > Press the **centre** button to be able to register a connected product type to the highlighted socket group.
- > Use the navigation button up and down to move between the sockets in the group.
- > Use the navigation button left or right to register what you have connected to the highlighted socket.
- > Press the **centre** button while SOURCE is highlighted to be able to select the product from an on-screen list.
- > Use the navigation button left or right to see lists for other types of products.
- > Use the navigation button up or down or a number button to highlight the name of the product and press the **centre** button to register it.
- > Press the **green** button to be able to name the source. The naming menu is now activated.
- > Use the navigation button up and down to find the individual characters in the name.
- > Press the **centre** button to accept the name.

## CONNECTIONS

AV1	NONE
AV2	NONE
AV3	NONE
AV4	NONE
AV5	NONE
AV6	NONE
PROJECTOR OUT	NONE
HDMI EXPANDER	NO
LINK	

*The available sockets may vary according to your setup.*

- > Names are shown in the television on-screen display when the source is selected.
- > Press the **centre** button to bring up the STANDBY OPTIONS menu.
- > Use the navigation button up or down to highlight a standby option for when the connected equipment should switch to standby. [See page 17.](#)
- > Press the **centre** button to select the highlighted standby option.
- > When you have completed your settings for a single socket group, press the **centre** button to return to the CONNECTIONS menu.
- > Repeat the procedure for each socket group.

*At first-time setup only, when you have registered all connected equipment, press the **green** button to store the setup.*

**What's on the AV1 – AV6 menus ...**

**SOURCE** ... Select the source you have connected. The option you select indicates which remote control button switches on the source. For example, a source registered as V.MEM is switched on when you press the **V.MEM** button. A source registered as DTV2 is switched on when you press **DTV2**. (Beo4: Press **LIST** and then the navigation button up or down to display **DTV2** and press the **centre** button). Options are:  
**NONE** ... if nothing is connected.  
**V.MEM** ... for a connected video recorder or hard disk recorder.  
**DVD** ... for the optional Blu-ray player.  
**DVD2** ... for a connected DVD player or recorder.  
**DTV** ... occupied by the ATSC digital tuner, unless you disable the ATSC digital tuner in the **TUNER SETUP** menu.  
**DTV2** ... for other equipment, such as a set-top box.  
**V.AUX2** ... for other equipment, such as a video game console.  
**TV** ... occupied by the TV tuner, unless you disable the tuner in the **TUNER SETUP** menu.  
**PC** ... for a connected PC.  
**CENTRE** ... for connection of a source centre, which may contain up to six built-in sources, such as a DVD player and a set-top box. This option is only available in the AV1 and the AV2 menus.  
**NAME** ... Allows you to name the source you are registering, the name you enter appears in the on-screen display when you activate the source.  
**AUTO SELECTION** ... Allows connected sources to be selected automatically as soon as the television detects a signal, provided the television is on at the time. Options are YES and NO.  
**(TIMER RECORDER)** ... Activate the Timer recording signal for a connected recorder. Options are YES and NO. Only available in the AV1 and AV2 menus, and can only be activated in one of these menus at any time.  
**HDMI** ... Indicates whether or not the equipment is connected to the television via one of the HDMI sockets. Select the appropriate socket.

**(SOUND INPUT)** ... Indicates the sound signal used. This option is only available when the equipment is registered to an HDMI socket. Options are HDMI and S/P-DIF.  
**(YPbPr)** ... Indicates whether or not the equipment is connected to the television via the YPbPr sockets. Options are YES and NO. Can only be registered in one of the AV menus (AV2 or AV3) at any time.  
**(AV3 -> AV1)** ... Select whether the TV should route signals from AV3 to AV1, even when the TV is switched off. You can use this feature when you have connected an external TV tuner to AV3 and a video recorder to AV1. Options are: NO and AUTO. This option is only available in the AV3 menu.  
**(VGA)** ... Indicates whether or not the equipment is connected to the television via the VGA socket. Options are YES and NO. Can only be registered in one of the AV menus (AV5 or AV6) at any time.

While it is possible to register equipment under any of the available source types, the type you select affects how you can use your source.

**What's on the PROJECTOR OUT menu ...**

Select the projector type.

**What's on the HDMI EXPANDER menu ...**

An HDMI Expander must always be connected to HDMI C, when present. When connecting an HDMI Expander, additional HDMI sockets become available; C1, C2, C3 and C4.

**What's on the LINK menu ...**

Set a link channel and enable the system modulator.

AV2	
SOURCE NAME	NONE
AUTO SELECTION	NO
TIMER RECORDER	NO
HDMI	NO
SOUND INPUT Y/Pb/Pr	NO

**Regarding High Definition (HD) sources ...**

Standard Definition (SD) signals can be recorded, as well as distributed to a link room television, but HD signals cannot.

If you watch a DVD or Blu-ray disc in your main room and you select the same source in your link room, the signal will change to standard definition on both televisions.

Connect both the HD and the SD signals to the television. The best signal is always used. If no HD signal is available, the SD signal is shown.



**Standby options ...**

When you register a non-Bang & Olufsen product in the CONNECTIONS menu, you can also select different STANDBY OPTIONS for your product. This means that you can select if the connected product should switch to standby automatically.

**The options are:**

OFF AT SOURCE CHANGE ... The product switches to standby immediately when you select another source.

OFF AT TV STANDBY ... The product switches to standby when you switch the television to standby.

ALWAYS ON ... The television does not switch the product to standby, but the product may switch to standby due to its own settings.

MANUAL CONTROL ... The product can only be switched on and off by means of the remote control. For further information [see page 65](#).

# Scan in TV channels

Register the source of your TV signal and scan in your TV channels.

If you have a connected cable box to your television, you must identify the cable box and select an output channel.

## Select video signal type

If you have selected TV TUNER in the TUNER SETUP menu, you can enter the source of your TV video signals.

### To scan in TV channels...

- > Bring up the TV SETUP menu and highlight OPTIONS.
- > Press the centre button to bring up the OPTIONS menu and highlight TUNER SETUP.
- > Press the centre button to bring up the TUNER SETUP menu. TV TUNER is already highlighted.
- > Use the navigation button left and right to select CABLE, CABLE BOX, ANTENNA or OFF.
- > Press the **centre** button to store the setting. If you have selected CABLE or ANTENNA, scanning begins immediately. If you have selected CABLE BOX, you can then register your cable box in a menu, as described [on page 19](#).

*Note that if you select OFF, you must register a source in the CONNECTIONS menu as TV if you wish to switch on the television using the TV button on the remote control. For further information about the CONNECTIONS menu, [see page 15](#).*

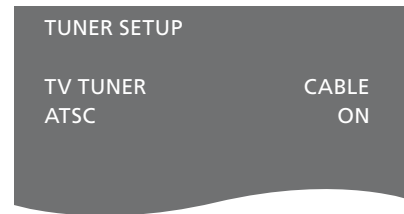

The TUNER SETUP menu.

## Identify the cable box

If you have connected a cable box to the television, you must register the connection in the CABLE BOX SETUP menu.

- > Use the navigation button up or down to highlight the name of your cable box.
- > Press the centre button to store the setting. You can then enter the output channel for the cable box.

*When you connect an RF cable box, remember to leave it switched on at all times.*

## Source for RF input

When you have registered the specific cable box, enter the output channel for the type of cable box and test whether you can change channels on the box.

*When the menu for your cable box appears ...*

- > Use the navigation button left or right to select the channel number that corresponds to the output channel set on your cable box. Select CH2, CH3, CH4, CH5 or CH6.
- > Highlight CH TEST and use the navigation button left or right to test whether you can change channels on the box.
- > If you cannot change channels on the cable box, repeat the first two steps. Otherwise ...
- > ... press the centre button to store your settings.

CABLE BOX SETUP	
GE CABLE BUDDY	1
NOKIA 98005	2
NOKIA D.BOX II	3
PACE DTR739-IM	4
PHILIPS DTX627x	5
PACE DSR600	6
SKY DIGITAL	7
CANALdig DK/S/N	8
CANALdigital I	9
. . . .	

*Select your cable box from the CABLE BOX SETUP list. Above you see an example of a CABLE BOX SETUP list. For installation of external equipment, contact your retailer.*

GE CABLE BUDDY	
OUTPUT CH	4
CH TEST	. .

*Select the output channel for your particular cable box*

# Edit scanned TV channels

You can 'remove' channels you do not use from the channel list.

Channels you 'remove' are skipped over when you step through channels using the arrow buttons on the remote control. You can still select them in the channel list by pressing the channel number.

In addition, you can give channels names of your own choice, re-scan to find new channels or fine-tune existing channels.

## Remove TV channels

At any time, you can remove channels you do not use. If you wish, you can restore channels that you have removed.

- > Bring up the TV SETUP menu and highlight CHANNEL SETUP.
- > Press the **centre** button to bring up the CHANNEL SETUP menu. EDIT CHANNELS is already highlighted.
- > Press the **centre** button to bring up the EDIT CHANNELS menu.
- > Use the navigation button up and down to select the channel you wish to remove.
- > Press the **yellow** button once to remove the channel.
- > Press the **yellow** button to add the channel again.
- > When you have removed the relevant channels, press and hold **BACK** to exit all menus.

*If you select CABLE BOX or OFF for TV TUNER in the TUNER SETUP menu, the EDIT CHANNELS and FINE TUNE menus are inaccessible.*



EDIT TV CHANNELS	
CNN	1
DISCOVERY	2
.....	3
CWNBC	4
BBCWORLD	5
SUPER CH	6
..	..
..	..
CINEMA	17
RTL	18

## Name channels

Give scanned TV channels names of their own to make them easy to locate in the TV channel list.

- > Bring up the TV SETUP menu and highlight CHANNEL SETUP.
- > Press the **centre** button to bring up the CHANNEL SETUP menu. EDIT CHANNELS is already highlighted.
- > Press the **centre** button to bring up the EDIT CHANNELS menu.
- > Use the navigation button up or down to select the channel you wish to name.
- > Press the **green** button to be able to name the channel. The naming menu is now activated.
- > Use the navigation button up and down to find the individual characters in the name.
- > Move between character places with the navigation button left or right.
- > Press the **centre** button to store the name.
- > If necessary, repeat the procedure and name other channel numbers.
- > When you have named the relevant channels, press the **centre** button to accept your edited list, or press and hold **BACK** to exit all menus.



EDIT TV CHANNELS	
CNN	1
DISCOVERY	2
A . . . .	3
CWNBC	4
BBCWORLD	5
SUPER CH	6
. .	. .
. .	. .
CINEMA	17
RTL	18

## Fine-tune channels

You can fine-tune your TV channels if, for example, you wish to adjust the frequency.

- > Bring up the TV SETUP menu and highlight CHANNEL SETUP.
- > Press the **centre** button to bring up the CHANNEL SETUP menu and highlight FINE TUNE.
- > Press the **centre** button to bring up the FINE TUNE menu. CHANNEL is highlighted.
- > Use the navigation button left and right to select a channel to fine-tune.
- > Highlight FINE and use the navigation button left or right to fine-tune the channel.
- > Highlight SOUND and use the navigation button left or right to select a sound type – STEREO, MONO or SAP – for the channel.
- > Press the **centre** button to store the settings.

*If you select CABLE BOX or OFF for TV TUNER in the TUNER SETUP menu, the EDIT CHANNELS and FINE TUNE menus are inaccessible.*



### What's on the FINE TUNE menu ...

- CHANNEL ... Select a channel to fine-tune.
- FINE ... Fine tune the frequency of a channel. You can fine tune within the range of -8 – +8.
- SOUND (mono, stereo or language) ... Several types of sound may be available for different programmes, mono, stereo or different languages. On the relevant channel or frequency select the options MONO, STEREO or SAP.

*Even though you store a type of sound/ language, you can switch between the various types while watching a TV programme. For further information, see Getting Started.*

## Re-scan TV channels

You can add new channels or update scanned channels which, for example, have been moved by the broadcaster.

*Note: If you re-scan all your TV channels, all channel settings you have made disappear!*

- > Bring up the TV SETUP menu and highlight OPTIONS.
- > Press the **centre** button to bring up the OPTIONS menu and highlight TUNER SETUP.
- > Press the **centre** button to bring up the TUNER SETUP menu. TV TUNER is already highlighted.
- > Use the navigation button right to select the source of your TV video signals – CABLE, CABLE BOX, ANTENNA or OFF – and press the **centre** button to store it.
- > If you select CABLE or ANTENNA, scanning begins automatically. New channels are added automatically as they are found.

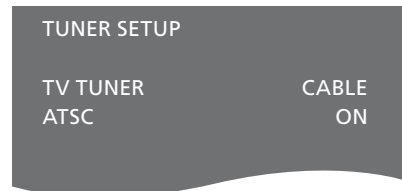

*If you only wish to check for a new signal on a scanned channel that has been empty, do not re-scan all TV channels. Instead, select the channel in the channel list using the number buttons on the remote control. For further information about the channel list, see Getting Started.*

*If you select CABLE BOX or OFF for TV TUNER in the TUNER SETUP menu, the EDIT CHANNELS and FINE TUNE menus are inaccessible.*

# Loudspeaker setup – surround sound

Add Power Link speakers and a BeoLab subwoofer to your television and you have a surround sound system.

A surround sound setup fits easily into your living room. Let the picture determine your ideal viewing and listening position. You get the best sound experience in the area created by the speakers.

If you have several speakers and a Beo6 remote control, you can enjoy the advantages of Adaptive Sound Technology instead of the setup described in this chapter. [See page 29.](#)

## Select your speaker types

Switch on the television in TV or Home cinema mode before you adjust speaker settings.

### To register the speaker types ...

- > Bring up the TV SETUP menu and highlight OPTIONS.
- > Press the **centre** button to bring up the OPTIONS menu and highlight SOUND.
- > Press the **centre** button to bring up the SOUND SETUP menu and highlight SPEAKER TYPE.
- > Press the **centre** button to bring up the SPEAKER TYPE menu and use the navigation button left or right to reveal your centre speaker type.
- > Highlight CONFIG. This allows you to select a CENTRE configuration as a single speaker or a pair. Depending on which centre speaker or speakers you select, CONFIG may be greyed out and inaccessible.
- > Press the navigation button down to move to the next speaker and press use the navigation button left or right to reveal your speaker type.
- > Press the **centre** button to store or press **BACK** to leave the menu without storing.

### SPEAKER TYPE

CENTRE 1	BEOLAB 7-4
CONFIG	
SPEAKERS:	
	BEOLAB 4000
	BEOLAB 4000
	BEOLAB 4000
	BEOLAB 5
	BEOLAB 5
	BEOLAB 4000
	NONE
	BEOLAB 5
	NONE
	NONE



## Assign roles to speakers

The speakers you connect to the television can have more than one role. If, for example, you only use one set of front speakers when you watch TV on your television screen, you can turn your chair ninety degrees towards a projector screen and use those same speakers as right front and rear speakers in a surround sound system for Home cinema.

### To assign roles to speakers ...

- > Bring up the TV SETUP menu and highlight OPTIONS.
- > Press the **centre** button to bring up the OPTIONS menu and highlight SOUND.
- > Press the **centre** button to bring up the SOUND SETUP menu and highlight SPEAKER ROLES.
- > Press the **centre** button to bring up the SPEAKER ROLES menu.
- > Highlight a speaker role. When you highlight a speaker role, a sound is produced by a speaker.
- > Use the navigation button left or right to select a role for the speaker producing the sound.
- > Repeat the procedure for each speaker.
- > Press the **centre** button to store or press and hold **BACK** to leave the menu without storing.

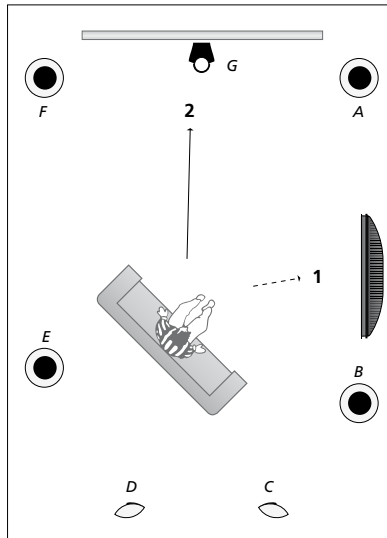

Assigning roles to the connected loudspeakers allows you to specify the speakers' function in a surround sound system and the number of speakers to be used. Assign different roles for watching TV (1) and Home cinema (2), as shown in the illustration:

### TV viewing (1) ...

Speaker A:	Left front
Speaker B:	Right front
Speaker C:	Off
Speaker D:	Off
Speaker E:	Right surround
Speaker F:	Left surround
Speaker G:	Off

### Home cinema viewing (2) ...

Speaker A:	Right front
Speaker B:	Right surround
Speaker C:	Right back
Speaker D:	Left back
Speaker E:	Left surround
Speaker F:	Left front
Speaker G:	Centre

## TV SPEAKER ROLES

### SPEAKERS:

	NONE
	NONE
	NONE
RIGHT SURROUND	
RIGHT FRONT	
	NONE
	NONE
LEFT SURROUND	
LEFT FRONT	
	NONE
	NONE
	NONE

### What's on the TV SPEAKER ROLES menu ...

Options are NONE, LEFT FRONT, RIGHT FRONT, LEFT SURROUND, RIGHT SURROUND, LEFT BACK, RIGHT BACK, CENTRE BACK.

### What's on the CINEMA SPEAKER ROLES menu ...

Options are NONE, LEFT FRONT, RIGHT FRONT, LEFT SURROUND, RIGHT SURROUND, LEFT BACK, RIGHT BACK, CENTRE BACK, CENTRE, LEFT CENTRE, RIGHT CENTRE.

You must select the surround speakers before you can select the back speakers.

## Set speaker distance

Switch on the television from your favourite viewing position. Enter the straight-line distances in metres between your position and the individual speakers.

### To set the speaker distances ...

- > Bring up the TV SETUP menu and highlight OPTIONS.
- > Press the **centre** button to bring up the OPTIONS menu and highlight SOUND.
- > Press the **centre** button to bring up the SOUND SETUP menu and highlight SPEAKER DISTANCE.
- > Press the **centre** button to bring up the SPEAKER DISTANCE menu.
- > Move the cursor from speaker to speaker and use the navigation button left or right to select the approximate straight-line distance in metres between your viewing position and each of the speakers.
- > When you have entered the appropriate speaker distances, press the **centre** button to store or press **BACK** to leave the menu without storing.

### SPEAKER DISTANCE

CENTRE	1.0 M
LEFT FRONT	1.0 M
RIGHT FRONT	1.0 M
LEFT SURROUND	1.0 M
RIGHT SURROUND	1.0 M
LEFT BACK	1.0 M
RIGHT BACK	1.0 M

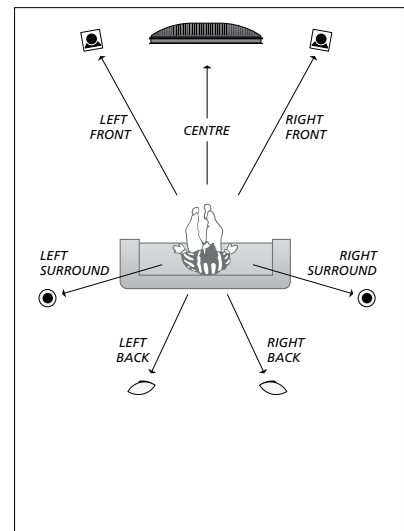

## Calibrate the sound level

When you have connected speakers in a surround sound setup to the television, you must perform a speaker calibration.

A calibration sound is produced alternately in each of the speakers you have connected in your surround sound setup. Your task is to adjust the sound level from all the connected speakers to match the sound level from the centre speaker. You can choose whether you want the sound sequence to occur automatically or manually.

Once you have performed your speaker calibration, you will only need to re-calibrate the speaker sound if you make changes to the setup, for example, if you move one or more of the speakers.

### To calibrate the sound level ...

- > Bring up the TV SETUP menu and highlight OPTIONS.
- > Press the **centre** button to bring up the OPTIONS menu and highlight SOUND.
- > Press the **centre** button to bring up the SOUND SETUP menu and highlight SPEAKER LEVEL.
- > Press the **centre** button to bring up the SPEAKER LEVEL menu. SEQUENCE is highlighted.
- > Use the navigation button left or right to choose between AUTOMATIC and MANUAL.
- > Use the navigation button left or right to adjust the speaker sound and use the navigation button up or down to move to another speaker.
- > When you have adjusted the sound for all the speakers in your surround sound setup, press the **centre** button to store or press **BACK** to leave the menu without storing.

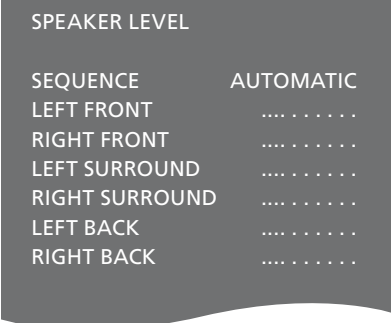

SPEAKER LEVEL	
SEQUENCE	AUTOMATIC
LEFT FRONT	.....
RIGHT FRONT	.....
LEFT SURROUND	.....
RIGHT SURROUND	.....
LEFT BACK	.....
RIGHT BACK	.....

## See the name of the active sound system

You can see the name of the active sound system for a source or programme on the screen. However, it is not possible to adjust or preset a sound system.

### *To see the active sound system ...*

- > Bring up the TV SETUP menu and highlight OPTIONS.
- > Press the **centre** button to bring up the OPTIONS menu and highlight SOUND.
- > Press the **centre** button to bring up the SOUND SETUP menu and highlight SOUND SYSTEM.
- > Press the **centre** button to bring up the SOUND SYSTEM menu. The active sound system is shown.
- > Press and hold **BACK** to exit all menus.

SOUND SYSTEM

INPUT FORMAT:  
MONO/STEREO

OUTPUT FORMAT:  
STEREO  
SPEAKER 1

ADAPTIVE SOUND  
TECHNOLOGY:  
DISABLED

LISTENING PRESET:

*An example of a sound system that can appear in the menu.*

*Your speaker combination does not need to match the number of available channels for the sound system to be in effect.*

# Adaptive Sound Technology

Your system is equipped with Adaptive Sound Technology which allows you to enjoy an optimal sound experience with a multiple speaker setup even though your speakers are not placed correctly for your listening position. The Adaptive Sound Technology feature in the television uses all connected speakers to create the ultimate sound experience of perfectly placed speakers.

To enjoy the advantages of this setup, several speakers and a Beo6 remote control are necessary. If you have only a few speakers or a Beo4 remote control, this setup is not recommended and you should choose the setup without Adaptive Sound Technology described in the chapters about first-time setup and loudspeaker setup [on pages 7 and 24](#).

In this part of the setup you set up speakers for your television and an optional projector.

For information about daily use of Adaptive Sound Technology, see Getting Started.

## Enable Adaptive Sound Technology

If you choose to switch on the Adaptive Sound Technology function, you can still disable it in one or more of the listening presets you make.

- > Bring up the TV SETUP menu and highlight OPTIONS.
- > Press the **centre** button to bring up the OPTIONS menu and highlight SOUND.
- > Press the **centre** button to bring up the SOUND SETUP menu and highlight AST ON/OFF.
- > Press the **centre** button to bring up the AST ON/OFF menu.
- > Use the navigation button left or right to enable or disable the technology.
- > Press the **centre** button to store or press and hold **BACK** to leave the menu without storing.

*In the SOUND SYSTEM menu you can see whether the Adaptive Sound Technology is enabled or not and which listening preset is currently activated. [See page 28](#).*



## Points A and B

For Adaptive Sound Technology to figure out the exact position of each speaker, you will need to decide on two fixed points, Point A and Point B, before you can enter the settings of the speaker setup menu. These points could, for example, be on a wall.

### Guidelines for fixing Point A and Point B:

- 1 Fix the points in the edge of a room, so all speakers are placed on the same side of an imaginary line between Point A and Point B.
- 2 Fix the points far apart from each other, at least two metres.
- 3 From both Point A and Point B you should be able to see all speakers in the setup. However, it is acceptable if a piece of furniture is in the way.

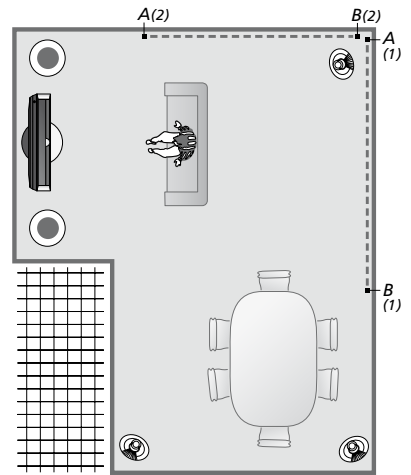

*Examples of two possibilities for points A and B with the imaginary line from one point to the other. You can preset speaker combinations for several listening positions such as at the sofa when you watch television, at the dining table or when you sit in an armchair reading.*

## Set up the speakers

Set the speaker types and the distances from Points A and B to each speaker, to the left and right side of the television screen and a projector screen, to a viewing position and the distance between the two points.

### Set speaker type and distance ...

- > Bring up the TV SETUP menu and highlight OPTIONS.
- > Press the **centre** button to bring up the OPTIONS menu and highlight SOUND.
- > Press the **centre** button to bring up the SOUND SETUP menu and highlight SPEAKER SETUP.
- > Press the **centre** button to bring up the SPEAKER SETUP menu.
- > Use the navigation button left or right to select the speaker types.
- > Press the **centre** button to store the settings and bring up the DISTANCE TO POINT A menu.
- > Enter the required horizontal distances in metres. The distance to a stereo speaker should be measured to the left and right edges of the speaker.
- > Press the **centre** button to store the settings and bring up the DISTANCE TO POINT B menu.
- > Enter the horizontal distances.
- > Press the **centre** button to store the setting. The television can now calculate your speaker setup.

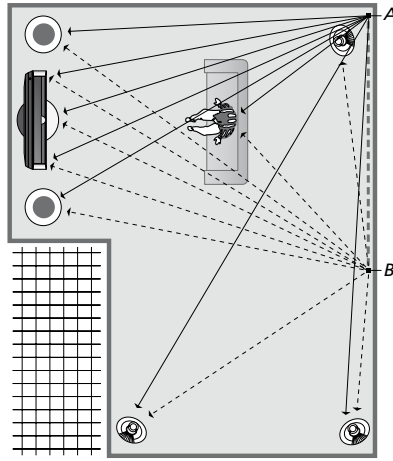

Select the viewing position from where you watch television.

When you set the speaker type, the speaker name highlighted in the menu should match the speaker producing a sound. In the menu that follows, you are asked to enter the horizontal distance in metres from Point A to each of your speakers, to the left and right edge of your television screen and a connected projector screen, to a viewing position and to Point B.

### SPEAKER TYPE

CENTRE 1	BEOLAB 7-2
CONFIG	
SPEAKERS:	
	BEOLAB 5
	BEOLAB 5
	BEOLAB 9
	BEOLAB 9
	BEOLAB 4000
	BEOLAB 4000
	BEOLAB 4000
	BEOLAB 4000
	BEOLAB 4000
	NONE
	NONE
	NONE
	NONE

### DISTANCE TO POINT A

BEOLAB 7-2 LEFT	1.0 M
BEOLAB 7-2 RIGHT	1.0 M
BEOLAB 5	1.0 M
BEOLAB 5	1.0 M
BEOLAB 9	1.0 M
BEOLAB 9	1.0 M
BEOLAB 4000	1.0 M
BEOLAB 4000	1.0 M
BEOLAB 4000	1.0 M
BEOLAB 4000	1.0 M
BEOLAB 4000	1.0 M
TV LEFT	1.0 M
TV RIGHT	1.0 M
VIEW POSITION	1.0 M
CINEMA LEFT	1.0 M
CINEMA RIGHT	1.0 M
POINT B	1.0 M

## Listening presets

Select the speakers to be activated in TV mode and, if you have connected a projector, in Cinema mode. You can also make up to five customised listening presets, such as at the dining table or in a favourite armchair. Select three to seven\* speakers and up to two subwoofers to be activated for a preset and determine the distance from your listening position to three of the activated speakers.

For each customised listening preset it is also possible to rotate the perceived sound 360 degrees around the listening position. The default rotation is 0 degrees which is the direction from your listening position to the television.

If your speakers are placed correctly for your listening positions, it is recommended that you disable Adaptive Sound Technology and set the speaker roles, distances and levels. If you activate fewer than three speakers, it is not possible to enable the Adaptive Sound Technology and you must set the speaker roles, distances and levels. For further information about speaker roles, distances and levels, [see page 25–27](#).

*\*A stereo speaker such as a BeoLab 7–1 or 7–2 counts as two speakers if fewer than six speakers are activated.*

*The distance from your listening position to any speaker in a listening preset should not exceed 10 metres.*

### To set speaker presets ...

- > Bring up the TV SETUP menu and highlight OPTIONS.
- > Press the **centre** button to bring up the OPTIONS menu and highlight SOUND.
- > Press the **centre** button to bring up the SOUND SETUP menu and highlight LISTENING PRESETS.
- > Press the **centre** button to bring up the LISTENING PRESET menu and highlight TV, CINEMA or a custom preset field.
- > Press the **centre** button to bring up the highlighted menu.
- > Use the navigation button left or right to enable or disable the Adaptive Sound Technology.
- > Use the navigation button left or right to activate the preferred speakers. Three to seven speakers as well as up to two subwoofers can be activated.
- > Check that the Adaptive Sound Technology is enabled or disabled as you desire.
- > Press the **centre** button to store and bring up the next menu. If you have selected OFF to disable the Adaptive Sound Technology, [see pages 25–27](#) about how to assign roles to speakers, set the speaker distances and calibrate the sound level.
- > Enter the horizontal distance in metres between your listening position and each speaker making a sound.
- > If you are setting a customised preset and ADAPTIVE SOUND TECHNOLOGY is enabled, highlight ROTATION and select how much the sound stage should be rotated. A sound will be produced from the setup if a source is playing and you rotate until the sound is experienced from the desired direction.
- > Press the **centre** button to store and return to the LISTENING PRESETS menu. During first-time setup, press the **green** button to continue the first-time setup procedure when you have created the desired presets.

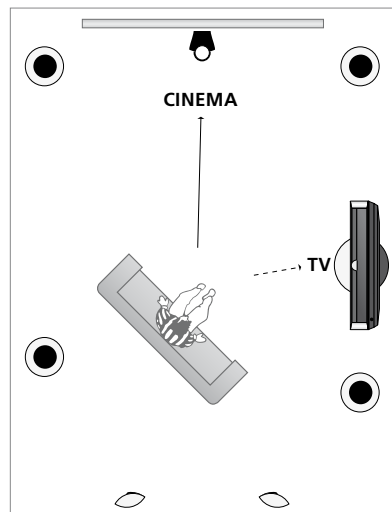

*Example of a listening position for watching television and Home cinema. You select which speakers should be active for each situation.*





*If you have changed the rotation of a preset during daily use, you can easily create a new preset with these settings. Enter the LISTENING PRESETS menu, select an empty PRESET field and press the centre button for each menu, as the current settings will automatically be applied to each of these menus.*

*You can make the television switch to a customised listening preset automatically when an audio source is selected.*

*[See page 36](#) about sound adjustment.*

### Name a customised preset

You can name your customised listening presets in the television menu yourself. Your retailer can help you name the customised listening presets in the Beo6 display.

#### *To name a customised preset ...*

- > Bring up the TV SETUP menu and highlight OPTIONS.
- > Press the **centre** button to bring up the OPTIONS menu and highlight SOUND.
- > Press the **centre** button to bring up the SOUND SETUP menu and highlight LISTENING PRESETS.
- > Press the **centre** button to bring up the LISTENING PRESET menu.
- > Highlight a desired customised listening preset and press the **green** button to be able to name the preset.
- > Enter a preferred name and store it by pressing the **centre** button on your remote control.

### Delete a customised preset

You can delete any customised listening preset you do not want.

#### *To delete a customised preset ...*

- > Bring up the TV SETUP menu and highlight OPTIONS.
- > Press the **centre** button to bring up the OPTIONS menu and highlight SOUND.
- > Press the **centre** button to bring up the SOUND SETUP menu and highlight LISTENING PRESETS.
- > Press the **centre** button to bring up the LISTENING PRESET menu.
- > Highlight a desired customised listening preset and press the **yellow** button to be able to delete the preset – the preset is then dimmed.
- > Press the **yellow** button again to finally delete the preset.

# Adjust picture and sound settings

Picture and sound settings are preset from the factory to neutral values which suit most viewing and listening situations. However, if you wish, you can adjust these settings to your liking.

Adjust picture brightness, contrast or colour. Sound settings include volume, bass and treble.

Store your picture and sound settings temporarily – until your television is switched off – or store them permanently.

Activate GAME MODE if you connect a game console to your television.

For information about how to change the picture format, see Getting Started.

## Adjust brightness, colour or contrast

Adjust the picture settings via the PICTURE menu. Temporary settings are cancelled when you switch off the television.

- > Bring up the TV SETUP menu and highlight OPTIONS.
- > Press the **centre** button to bring up the OPTIONS menu and highlight PICTURE.
- > Press the **centre** button to bring up the PICTURE menu.
- > Use the navigation button up or down to move through menu items.
- > Use the navigation button left or right to adjust the values.
- > Press **BACK** to store your settings until you switch off the television, or
- > ... press the **centre** button to store your settings permanently.

For video sources using the VGA signal, the following options appear as well:

- HOR. SIZE ... Adjusts the picture size along the horizontal axis.
- VERT. SIZE ... Adjusts the picture size along the vertical axis.
- HOR. POSITION ... Adjusts the picture position along the horizontal axis.
- VERT. POSITION ... Adjusts the picture position along the vertical axis.

Note that these four settings only apply for the screen resolution in effect at the time you adjust the settings.

*To temporarily remove the picture from the screen, press  $\triangle$  to bring up the Scene display on Beo6, press **Picture**, then press **P.Mute**. To restore the picture, press **P.Mute** again. (Beo4: press **LIST** and use the navigation button up or down to bring up **P.MUTE** in the Beo4 display and press the **centre** button. To restore the picture, press a source button.)*

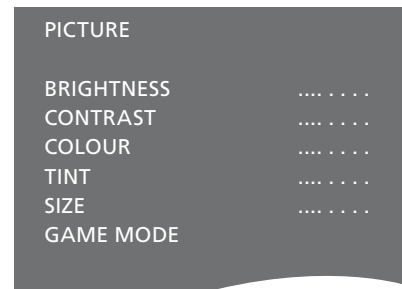

*When signals are sent in format 1080p or 1080i, the menu item SIZE is available in the PICTURE menu.*

*For video sources using the NTSC signal, the menu item TINT is available.*

*You cannot adjust brightness or contrast when using a projector connected to the television, or when using the television in Home cinema mode.*

## **Game mode**

If you connect a game console or play a PC game using the television as a monitor, you can activate 'Game mode'. Game mode minimises the delay caused by signal processing. The television remembers if Game mode was activated the last time each source was selected.

### *To activate GAME MODE with Beo6 directly ...*

> Press **Game** to activate Game mode, press again to deactivate Game mode.

### *To activate GAME MODE with Beo4 directly\*<sup>1</sup> ...*

> Press **LIST** and use the navigation button up or down to bring up **GAME** in the Beo4 display.  
> Press the **centre** button repeatedly to switch between ON and OFF.

<sup>1</sup>\* *If you have a Beo4 without navigation button, GAME may not be available.*

### *To activate GAME MODE via the TV SETUP menu ...*

> Bring up the TV SETUP menu and highlight **OPTIONS**.  
> Press the **centre** button to bring up the **OPTIONS** menu and highlight **PICTURE**.  
> Press the **centre** button to bring up the **PICTURE** menu.  
> Use the navigation button up or down to move to **GAME MODE**.  
> Press the **centre** button repeatedly to switch between ON and OFF.

## Adjust volume, bass or treble

Sound settings are preset at the factory to neutral values which suit most listening situations. However, if you wish, you can adjust these settings to your liking.

You can preset levels for sound volume, bass, treble and up to two connected BeoLab subwoofers.

You can switch the loudness feature on or off. The loudness feature compensates for the human ear's lack of sensitivity to high and low frequencies. These frequencies are boosted at low volume levels so that low music becomes more dynamic.

In addition, you can select two default speaker combinations; one to be used each time you switch on a video source in your television, and one to be used each time you switch on an audio source connected to your television. You can still select a different speaker combination any time you wish.

When Adaptive Sound Technology is enabled and a customised listening preset is created, you can select an audio preset to be activated automatically when you switch to an audio source. The default audio setting determines which speakers in the selected audio preset should be activated.

For further information about speaker combinations, [see page 39](#).

### *To adjust sound ...*

- > Bring up the TV SETUP menu and highlight OPTIONS.
- > Press the **centre** button to bring up the OPTIONS menu and highlight SOUND.
- > Press the **centre** button to bring up the SOUND SETUP menu, and highlight ADJUSTMENT.
- > Press the **centre** button to bring up the SOUND ADJUSTMENT menu.
- > Use the navigation button up or down to select an item to adjust.
- > Use the navigation button left or right to adjust the values or choose a setting.
- > Press **BACK** to store your settings until you switch off your television, or ...
- > ... press the **centre** button to store your settings permanently.

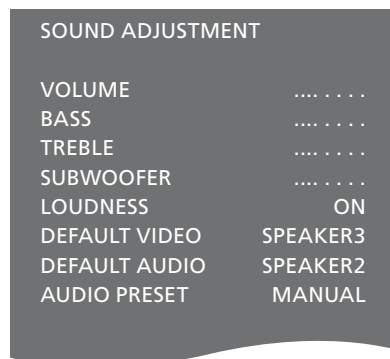

*The content of the SOUND menu varies according to what you have connected to the television.*

*AUDIO PRESET is only available if Adaptive Sound Technology is enabled in the SOUND SETUP menu and you have created one or more customised listening presets. [See pages 29 and 32](#).*

# Set up 3D television

You can set up preferences for watching 3D television, such as selecting if the television should automatically switch to 3D mode, when automatic 3D signalling is available.

In addition, you can adjust the sharpness of the picture.

If your TV is equipped with the optional Blu-ray player, you can also use it to play 3D Blu-ray discs.

## Activate 3D and adjust settings

You can select if the television should activate 3D mode automatically, manually or by prompt, when it detects automatic 3D signalling the first time after source or channel change. The default setting is **AUTO**.

### To activate 3D ...

- > Bring up the TV SETUP menu and highlight 3D DISPLAY.
- > Press the **centre** button to bring up the 3D DISPLAY menu and highlight 3D SETTINGS.
- > Press the **centre** button to bring up the 3D SETTINGS menu, and highlight ACTIVATE 3D.
- > Use the navigation button left or right to select **AUTO**, **PROMPT** or **MANUAL**.
- > Press the **centre** button to store, or ...
- > ... press and hold **BACK** to leave the menu without storing.

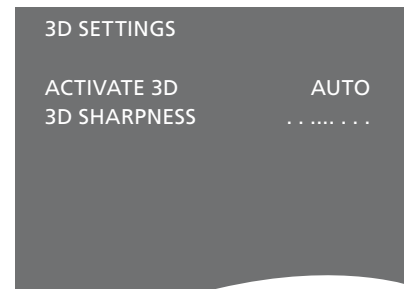

*When automatic 3D signalling is available, the television switches to 3D mode automatically if **ACTIVATE 3D** is set to **AUTO**. If it is set to **PROMPT**, you must select between **VIEW IN 3D** and **VIEW IN 2D**. If it is set to **MANUAL**, you must enter the menu and switch to 3D mode manually.*

>> *Set up 3D television*

You can fine tune the 3D experience and remove shadows to make the picture perfectly sharp. This menu is greyed out if you are not in one of the 3D modes or if you are in CINEMA mode.

*To adjust 3D sharpness ...*

- > Bring up the TV SETUP menu and highlight 3D DISPLAY.
- > Press the **centre** button to bring up the 3D DISPLAY menu and highlight 3D SETTINGS.
- > Press the **centre** button to bring up the 3D SETTINGS menu, and highlight 3D SHARPNESS.
- > Use the navigation button left and right to adjust the sharpness.
- > Press the **centre** button to store, or ...
- > ... press and hold **BACK** to leave the menu without storing.

# Daily use of speaker combinations

You can extend your television into a surround sound system by adding Bang & Olufsen loudspeakers and up to two BeoLab subwoofers.

When you switch on one of the sources, the television automatically selects the appropriate speakers, depending on what kind of sound suits the source you are using.

The speaker combination is optimised if you press the **Optimise** button on Beo6. **NOTE!** If you have added only two front speakers to the TV, you will only be able to choose Mode 1–3.

## Select speakers for movie sound

You can select the speaker combination that suits the source you are using, provided that the various speaker modes are available in your television.

- > Press **⏮** to bring up the Scene display on Beo6, then press **Speaker** to bring up the Speaker display. (Beo4: Press **LIST** and use the navigation button up or down to bring up **SPEAKER** in the Beo4 display).
- > Press **Optimise** if you want to optimise the sound, or press **Mode 1 – 5** to select the speaker combination you want. (Beo4: Press the **centre** button or 1 – 5). The selected speakers cut in automatically.
- > Press **⏮** to remove the Speaker display and return to the source you were using. (Beo4: Press and hold **BACK** to remove the **SPEAKER** from the Beo4 display).

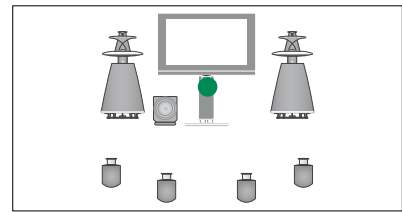

Mode 1

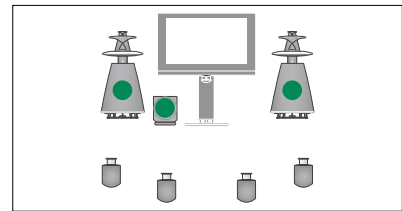

Mode 2

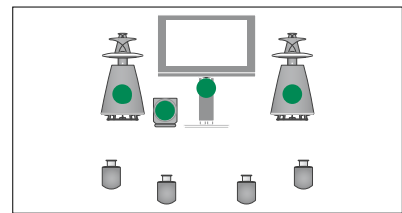

Mode 3

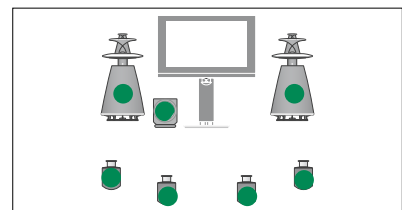

Mode 4

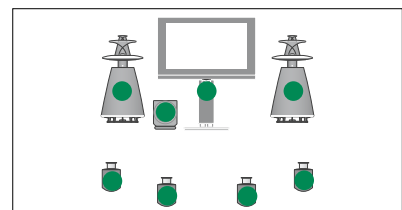

Mode 5

## See two sources at the same time

Your remote control gives you access to a dual-screen function for viewing two video sources at the same time. You can also bring up a video source and an audio source at the same time. For example, you can view a video playback and a TV programme at the same time, provided that the selected sources are available in your system.

While watching a programme or recording, you can divide the screen between the current programme or recording and a new programme or recording. You can also swap the two pictures at any time.

*You cannot watch two recordings at the same time.*

*If you watch 3D and switch on the dual-screen function, the television will switch to 2D.*

*If you have a Beo4, press **LIST** and use the navigation button up or down until **P-V.AUX** is shown in the Beo4 display, to view a source registered in the **CONNECTIONS** menu as **V.AUX**, such as a set-top box.*

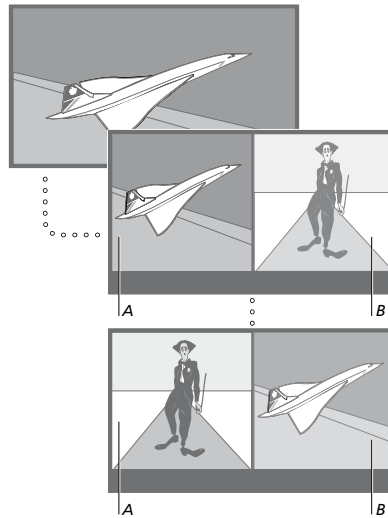

*Volume adjustment always affects picture A, while other operations, such as selecting channels, affect picture B. Choosing a new source cancels dual-screen viewing.*

*You can view two HDMI (High Definition Multimedia Interface) sources at the same time, but only if one of the sources is connected to either the HDMI A or HDMI B socket, and the other source is connected to either the HDMI C or HDMI D socket. For further information about the HDMI sockets, see the chapter about connection panels in Getting Started.*

### *While watching, for example, TV ...*

- > Press **P-and-P** to bring up the P-and-P display on Beo6. (Beo4: Press **LIST** and use the navigation button up or down to bring up **P-AND-P**).
- > Press, for example, **DVD** to select the source to view on the right side of the screen (**B**).
- > Press **Swap** to swap the left picture and right picture. (Beo4: Press **0**).

### *To leave the dual-screen function ...*

- > Press **BACK** to leave the function and return to normal viewing of the source on the left side of the screen (**A**) or simply select a source.

*To bring up **V.TUNER** on the right hand side of the screen, you must press **P-and-P**, then **TV**. (Beo4: Press **LIST** and use the navigation button up or down to bring up **P-AND-P**, then press **TV**). To bring up hard disk recordings on the right hand side of the screen, you must press **P-and-P**, then **V.MEM**. (Beo4: Press **LIST** and use the navigation button up or down to bring up **P-AND-P**, then press **V.MEM**).*



# Home cinema

If you connect a projector, you can turn your television into a Home cinema. When you switch to the Home cinema setup, the television switches the picture from its own screen to the projector screen and activates the appropriate speakers.

## Switch to Home cinema

If a projector is connected, you can use your remote control and move the picture from the television screen onto a projector screen for a special occasion or movie.

- > Press **△** to bring up the Scene display on Beo6, then press **Cinema** to bring up the Cinema display on Beo6. (Beo4: Press **LIST** and use the navigation button up or down to bring up **FORMAT**).
- > Press **Cinema** to switch between Home cinema mode and ordinary TV mode. (Beo4: Press **0**).
- > Press **△** to leave the function. (Beo4: Press **BACK**).

# Set the television to switch itself on or off

Your television has a built in Sleep Timer which means that you can make it switch off after a designated number of minutes.

You can also make your television switch itself on and off automatically via the timed play and timed standby functions, for example, if there is a programme you do not want to miss.

Enter as many as six Timer settings, and bring up an on-screen list of the Timer settings you have entered. From this list, you can edit or delete your Timer settings.

If your television is integrated with a Bang & Olufsen audio or video system with a Master Link cable, these systems can perform the timed play or timed standby functions as well.

For your timed settings to be executed correctly, ensure that the built-in clock is set to the correct time. For further information, [see page 47](#).

**NOTE!** For safety reasons, the stand will not turn if the television is switched on by a Play Timer.

## Sleep Timer

You can make the television switch off automatically after a number of minutes.

### *To activate the Sleep Timer with Beo6 ...*

- > Press **Sleep** repeatedly to select the number of minutes or **Off**.

### *To activate the Sleep Timer with Beo4\*<sup>1</sup> ...*

- > Press **LIST** and use the navigation button up or down to bring up **SLEEP** in the Beo4 display.
- > Press the **centre** button repeatedly to select the number of minutes.

### *To deactivate the Sleep Timer ...*

- > Press **LIST** and use the navigation button up or down to bring up **SLEEP** in the Beo4 display.
- > Press the **centre** button repeatedly until **OFF** is shown in the television display.

### *To set the Sleep Timer via the menu ...*

- > Bring up the TV SETUP menu and highlight **SLEEP TIMER**.
- > Press the **centre** button to bring up the **SLEEP TIMER** menu.
- > Press the **centre** button repeatedly to switch between the number of minutes and **OFF**.

<sup>1</sup>\* *If you have a Beo4 without navigation button, **SLEEP** may not be available.*

## Play Timer

If you connect a Bang & Olufsen audio or video product to your television with a Master Link cable, you can exclude or include it in timed functions via the **PLAY TIMER** menu. For example, set the television Play Timer to **ON** and an audio system's Play Timer to **OFF** if you wish timed functions to apply only to the television.

### *To switch on the Play Timer ...*

- > Bring up the TV SETUP menu and highlight **PLAY TIMER**.
- > Press the **centre** button to bring up the **PLAY TIMER** menu, and highlight **TIMER ON/OFF**.
- > Press the **centre** button to bring up the **TIMER ON/OFF** menu.
- > Use the navigation button left or right to reveal **ON**.
- > Press the **centre** button to store the setting.

*For further information about how to program Timers and switch the Play Timer on or off for a connected Bang & Olufsen audio or video product, see the guide enclosed with the product.*

## Timed play and timed standby

You can preset your television to start and stop automatically at the same time and day every week.

### To enter settings for timed play or timed standby ...

- > Bring up the TV SETUP menu and highlight PLAY TIMER.
- > Press the **centre** button to bring up the PLAY TIMER menu and highlight PLAY TIMER PROGRAMMING.
- > Press the **centre** button to bring up the PLAY TIMER PROGRAMMING menu.
- > Use the navigation button up or down to move through the menu items.
- > Enter information or use the navigation button left or right to view your choices for each item. When DAYS is highlighted, use the navigation button right once to be able to move through the days, and use the navigation button up or down to remove a day you do not want. Use the navigation button right to move to the next day, and use the navigation button left to move back to a previous day. When the weekday(s) you want are displayed, press the **centre** button to accept the day(s).
- > When you have filled in the required information, press the **centre** button to store your Timer settings.
- > Press **BACK** to back up through previous menus or press and hold **BACK** to exit all menus.

*If the television is set up in a link room, Timer programming must be carried out on your main room television.*

## View, edit or delete a Timer

Bring up an on-screen list of the settings you have entered. From this list, you can edit or delete your Timer settings.

### To view, edit or delete your Timer settings ...

- > Bring up the TV SETUP menu and highlight PLAY TIMER.
- > Press the **centre** button to bring up the PLAY TIMER menu and highlight PLAY TIMER INDEX.
- > Press the **centre** button to bring up your list of Timer settings. The first Timer setting in the list is already highlighted.
- > Use the navigation button up or down to move the cursor to a Timer setting you wish to edit.
- > To edit a setting, press the **centre** button and follow the procedure described under 'Timed play and timed standby'.
- > To be able to delete a selected setting, press the **yellow** button.
- > If you change your mind, use the navigation button left to move the setting back into the list. You can also press and hold **BACK** to exit all menus.
- > Press the **yellow** button a second time to delete the setting.

### TIMER PROGRAMMING

SOURCE	TV
CHANNEL	18 BBC
SUB CHANNEL	
START TIME	15:40
STOP TIME	16:40
DAYS	M . . T F . S

### PLAY TIMER PROGRAMMING menu

#### Abbreviations for days of the week:

M ...	Monday
T ...	Tuesday
W ...	Wednesday
T ...	Thursday
F ...	Friday
S ...	Saturday
S ...	Sunday

*If a Wake-up Timer has been programmed, the television cannot be part of an ordinary Play Timer or Standby Timer until the Wake-up Timer has been carried out or disabled.*

>> Set the television to switch itself on or off

## Standby settings

The television can be set to switch itself to standby after some time with no operation. The factory setting is 4 hours. This function only applies in video mode not in audio mode.

### To make standby settings ...

- > Bring up the TV SETUP menu and highlight OPTIONS.
- > Press the **centre** button to bring up the OPTIONS menu and highlight AUTO STANDBY.
- > Press the **centre** button to bring up the AUTO STANDBY menu and use the navigation button up or down to select the setting you want.
- > Press the **centre** button to store the setting.
- > Press **BACK** to back up through previous menus or press and hold **BACK** to exit all menus.

*When AUTO STANDBY is activated, a message appears on your television screen if the television has not been operated during the time set in the menu. The television then switches to standby, if you do not operate it.*

AUTO STANDBY

AFTER 1 HOUR  
AFTER 2 HOURS  
AFTER 4 HOURS  
OFF

*AUTO STANDBY menu.*

*When no signal has been detected for 15 minutes, the television is switched to standby.*

# Wake-up Timer

You can make the television wake you up in the morning.

The Wake-up Timer is a once-only Timer, it lasts for one hour. Like an alarm clock it is disabled once it has been executed. It applies only to the television it has been programmed on.

Once you have made one Wake-up Timer, the television automatically suggests the time you entered for the latest Wake-up Timer when you enter a new one.

Wake-up Timers can of course also be disabled again.

When you have programmed a Wake-up Timer, the television cannot be part of an ordinary Play Timer until the Wake-up Timer has been carried out or disabled.

## Enter a Wake-up Timer

You must choose the source and channel number of your Wake-up Timer as well as the start time.

### *To enter settings for a Wake-up Timer ...*

- > Bring up the TV SETUP menu and highlight PLAY TIMER.
- > Press the **centre** button to bring up the PLAY TIMER menu and highlight WAKE UP TIMER.
- > Press the **centre** button to bring up the WAKE UP TIMER menu.
- > Use the navigation button up or down to move through the menu items.
- > Enter information or use the navigation button left or right to view your choices for each item.
- > When you have filled in the required information, press the **centre** button to store your Wake-up Timer.
- > Press **BACK** to back up through previous menus or press and hold **BACK** to exit all menus.

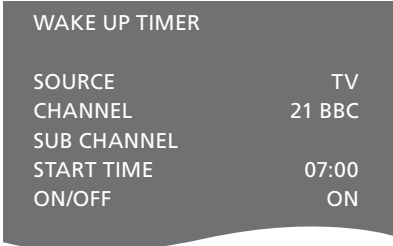

WAKE UP TIMER	
SOURCE	TV
CHANNEL	21 BBC
SUB CHANNEL	
START TIME	07:00
ON/OFF	ON

*WAKE UP TIMER menu.*

## Check or delete a Wake-up Timer

You can bring up the settings for the Wake-up Timer to check the time or to disable the Wake-up Timer by setting it to OFF.

### *To change settings for a Wake-up Timer or delete it ...*

- > Bring up the TV SETUP menu and highlight PLAY TIMER.
- > Press the **centre** button to bring up the PLAY TIMER menu and highlight WAKE UP TIMER.
- > Press the **centre** button to bring up the WAKE UP TIMER menu.
- > Use the navigation button up or down to move through the menu items.
- > Use the navigation button left or right to change settings, or enter a new time. Change the ON/OFF setting to OFF if you wish to delete the Wake-up Timer.
- > When you have made your changes, press the **centre** button to store them.
- > Press **BACK** to back up through previous menus or press and hold **BACK** to exit all menus.

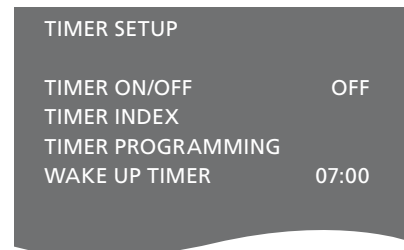

*TIMER SETUP menu.*

## Set the time and date

When you preset your television to switch itself on or off at a particular time, the clock ensures that this feature is switched on and off at the right time.

To bring up the clock on the display, press **Clock** on Beo6. The clock display disappears again after ten seconds. (Beo4: Press **LIST** and use the navigation button up or down to bring up **CLOCK** in the Beo4 display and press the **centre** button to bring up the clock).

- > Bring up the TV SETUP menu and highlight **OPTIONS**.
- > Press the **centre** button to bring up the **OPTIONS** menu and highlight **CLOCK**.
- > Press the **centre** button to bring up the **CLOCK** menu.
- > Use the navigation button up or down to move through menu items.
- > Use the navigation button left or right to see your choices for each item.
- > Press the **centre** button to store your clock and calendar options, or ...
- > ... press and hold **BACK** to exit all menus without storing.

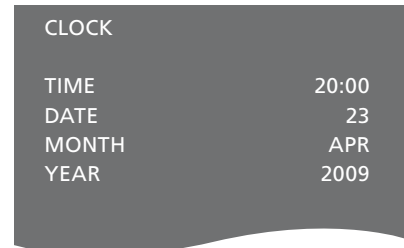

### Abbreviations for months

Jan ...	January
Feb ...	February
Mar ...	March
Apr ...	April
May ...	May
Jun ...	June
Jul ...	July
Aug ...	August
Sep ...	September
Oct ...	October
Nov ...	November
Dec ...	December

# Activate parental control

If parental control is available in your area, you can switch it on or off. You can apply TV parental guidelines and the MPAA rating system.

If you assign an access code and switch parental control on, you will be required to enter this access code whenever you want to watch a programme or channel that has been blocked.

Whenever a blocked programme or channel is selected, your screen goes blank, the sound is shut off and an on-screen menu prompts you to enter your access code.

If you wish to change or override your settings, the access code is also required.

## Assign an access code

To make full use of the parental control system, begin by assigning an access code. This restricts access to the programmes and channels with broadcasted restrictions, and prevents the settings from being changed by others. Choose a code that is easy to remember. The default setting is 0000.

- > Bring up the TV SETUP menu and highlight OPTIONS.
  - > Press the **centre** button to bring up the OPTIONS menu and highlight PARENTAL CONTROL.
  - > Press the **centre** button to bring up the PARENTAL CONTROL menu and highlight ACCESS CODE.
  - > Press the **centre** button to bring up the ACCESS CODE menu.
  - > Press **+** and use the number buttons to enter the default code (0000). (Beo4: Use the number buttons).
  - > Highlight NEW CODE and enter a new code.
  - > Enter the new code once more to confirm it.
  - > Press the **centre** button to store the code.
  - > Press and hold **BACK** or press a source button, for example **TV** or **DTV** to exit all menus.
- Assign an access code.*



*To change your code at any time, follow the procedure described above. If, for some reason, you have forgotten your code, then you can key in 9999 three times when OLD CODE is highlighted. This allows you to enter a new code.*



## Preset TV Parental guidelines

If you choose to apply the system of TV parental guidelines, you can select one common restriction level for all categories or preset the restriction level for the individual categories.

- > Bring up the TV SETUP menu and highlight OPTIONS.
- > Press the **centre** button to bring up the OPTIONS menu and highlight PARENTAL CONTROL.
- > Press the **centre** button to bring up the PARENTAL CONTROL menu. TV PARENTAL GUIDELINES is already highlighted.
- > Press the **centre** button to bring up the TV PARENTAL GUIDELINES menu.
- > Press **+** and use the number buttons to enter the access code. If you have not yet preset your own code, enter the default code (0000). (Beo4: Use the number buttons).
- > Use the navigation button left or right to adjust the setting OVERALL. This automatically adjusts the different categories to one common restriction setting. Options are: TV-Y, TV-Y7, TV-G, TV-PG, TV-14, TV-MA, and N/A.

## Preset the MPAA rating

You can choose to apply the MPAA rating system as parental control. Select and store the restriction level that you want to impose.

- > Bring up the TV SETUP menu and highlight OPTIONS.
- > Press the **centre** button to bring up the OPTIONS menu and highlight PARENTAL CONTROL.
- > Press the **centre** button to bring up the PARENTAL CONTROL menu and highlight MPAA RATING.
- > Press the **centre** button to bring up the MPAA RATING menu.
- > Press **+** and use the number buttons to enter the access code. If you have not yet entered your own code, enter the default code 0000. (Beo4: Use the number buttons).
- > Use the navigation button left or right to adjust the setting RATING. This automatically adjusts the restriction setting. Options are: G, PG, PG-13, R, NC-17, X, NOT RATED, N/A, and OFF.
- > Press the **centre** button to store the setting.
- > Press and hold **BACK** or press a source button, such as **TV**, to exit all menus.

### TV PARENTAL GUIDELINES

ACCESS CODE	....
OVERALL	OFF
FANTASY VIOLENCE	TV-Y7
VIOLENCE	TV-PG
SEXUAL SITUATIONS	TV-14
LANGUAGE	TV-PG
DIALOGUE	TV-14

*Preset TV Parental guidelines.*

### MPAA RATING

ACCESS CODE	....
RATING	PC-13

*Preset the MPAA rating.*

### **When parental control is active ...**

When a blocked programme or channel is selected, the screen goes blank, the sound is shut off, and the access code must be entered. All the programmes and channels then become available, and parental control is switched off until you switch the television to standby.

- > Select a blocked channel.
- > Press **+** and use the number buttons to enter your access code. (Beo4: Use the number buttons).
- > The selected channel is now available, as are all other blocked channels.
- > If you do not know the code or you wish to view another channel, use the navigation button up or down to change channels.

*If an incorrect access code is entered three times, the television automatically switches to standby.*

# Apply Closed Captioning

You can apply subtitles, or Closed Captioning, to all your sources and channels, provided that the broadcaster supports Closed Captioning.

Select a type of Closed Captioning via the CLOSED CAPTIONING menu.

You can, however, choose to turn Closed Captioning on or off at any time – for example, while watching a specific programme – even if you have preset the television to display Closed Captioning at all times.

## Closed Captioning options

Choose the type of Closed Captioning you wish to view and whether or not you want Closed Captioning to be displayed automatically.

- > Bring up the TV SETUP menu and highlight OPTIONS.
- > Press the **centre** button to bring up the OPTIONS menu and highlight CLOSED CAPTIONING.
- > Press the **centre** button to bring up the CLOSED CAPTIONING menu.
- > Use the navigation button left or right to adjust the setting for DISPLAY. Choose ON or OFF.
- > Highlight TYPE and use the navigation button left or right to select a type of Closed Captioning. Options are: CC1, CC2, CC3, CC4, TEXT1, TEXT2, TEXT3, or TEXT4.
- > Press the **centre** button to store.
- > Press and hold **BACK** or press a source button, such as **TV** or **DTV**, to exit all menus.

### *To turn Closed Captioning on or off while watching a programme ...*

- > Press **CC** to see the status of closed captioning – CC ON appears on the screen. (Beo4: Press **TEXT**).
- > Press **CC** again to turn Closed Captioning off. (Beo4: Press **TEXT**).
- > Press **CC** a third time to restore Closed Captioning. (Beo4: Press **TEXT**).

*Closed Captioning is not available in Korea.*



# Settings and preferences for the digital tuner

In the digital tuner menus you can make your own settings, enter information on your current terrestrial or cable setup and make channel searches.

The V-CHIP menu allows you to restrict access to particular channels or rated contents.

## About channels ...

Once you have scanned in the channels, you can make a Channel List of your favourite channels. This means that you reduce the time you spend looking for specific channels.

## Contents of the CHANNEL menu ...

**AUTO SCAN ...** Scan in all channels automatically. Select which channels to scan for. Options are: AIR, CABLE AUTO, CABLE STD, CABLE HRC and CABLE IRC. When you have selected the channels to scan, you must confirm or cancel the channel search. Default settings are AIR and CONFIRM. When you scan in channels, the current channel list and favourite list will be lost. If you wish to know which signal type to use, contact your cable provider.\*

**FAVOURITE CHANNEL ...** Make a list of your favourite channels. If you have not made a favourite list, the main list will appear when you press **List**. (Beo4: Press and hold the **centre** button).

**CHANNEL ADD/DELETE ...** Add or delete channels. The on-screen display gives a status of whether a channel is added to or deleted from the main list. A channel can be added or deleted by pressing the **centre** button. When a channel is deleted, it is removed from the channel sequence, but it can still be reached if you enter the channel digits.

**SIGNAL STRENGTH ...** See the strength of the received signal.

*\*In Korea options are AIR and CABLE. Default settings are AIR and CONFIRM.*

## About the CAPTION menu ... \*

You can apply subtitles, or Closed Captioning, to all your channels.

Choose the type of Closed Captioning you wish to view and whether or not you want Closed Captioning to be displayed automatically.

You can choose to switch Closed Captioning on or off at any time – for example, while watching a specific programme – even if you have preset the television to display Closed Captioning at all times.

### Contents of the CAPTION menu ...

ON/OFF ... Choose to display Closed Captioning or not. The default setting is OFF.

ANALOGUE MODE ... Select the mode to use for Closed Captioning in your analogue television receiver, and if the Closed Captioning function should be set to ON. Options are: CC1, CC2, CC3, CC4, TEXT1, TEXT2, TEXT3 and TEXT4. The default setting is CC1.

DIGITAL MODE ... Select the mode to use for Closed Captioning in your digital television receiver, and if the Closed Captioning function should be set to ON. Options are: SERVICE1, SERVICE2, SERVICE3, SERVICE4, SERVICE5 and SERVICE6. The default setting is SERVICE1.

*If you press CC repeatedly you change the mode or switch Closed Captioning on or off, even if you have preset the Closed Captioning function to ON. (Beo4: Press TEXT repeatedly).*

DIGITAL FONT OPTIONS ... Set your preferences for the digital font, if you have set the Closed Captioning function to ON:  
SIZE ... Select the size of the digital font. Options are: DEFAULT, SMALL, STANDARD and LARGE. The default setting is DEFAULT.  
STYLE ... Select a style for the digital font. You can choose between eight different styles. The default setting is DEFAULT.  
COLOUR ... Select a colour for the background, the foreground and the edge of the digital font. You can choose between DEFAULT and eight different colours and the default setting is DEFAULT.  
OPACITY ... Select the opacity for the background and foreground of the digital font. Options are: DEFAULT, SOLID, TRANSLUCENT, TRANSPARENT and FLASHING. The default setting is DEFAULT.  
EDGE STYLE ... Select an edge style for the digital font. You can choose between seven different styles. The default setting is DEFAULT.

*The DEFAULT option in the DIGITAL FONT OPTIONS menu is the presentation as it is set by the programme provider.*

*\*The CAPTION menu is not available in Korea.*

## **About the V-CHIP menu ... \***

The V-CHIP menu allows you to lock specific television contents.

When you enter the V-CHIP menu, you can lock (and later unlock) specific contents to avoid others from watching the contents. Select the contents you wish to lock. Whenever you try to access locked contents, you are asked to key in your V-Chip pincode.

If one content lock is released by the correct V-Chip pincode all contents are open and content lock will not be active again before the television enters standby.

The V-Chip pincode system of the built-in ATSC tuner is not the same as the pincode system for your television, but it may be easier for you, if you choose to use the same code for both systems.

### **Contents of the V-CHIP menu ...**

*Before you can change the setting in the V-CHIP menu, you must enter the V-Chip pincode. The default setting of the V-Chip pincode is 0000.*

#### **CHANGING PIN**

You can change your V-Chip pincode at any time. Press **+** and use the number buttons to enter a new four-digit V-Chip pincode. Enter the new V-Chip pincode again to confirm. (Beo4: Use the number buttons).

#### **US RATING SETTING**

In the US RATING SETTING menu you can apply the MPAA rating system or the TV-PG system as parental control. Depending on which system you choose options are:

- ALLOW ALL
- BLOCK ALL
- TV-Y, TV-Y7, TV-G, TV-PG, TV14, TV-MA
- FV, D, L, S, V
- P, PG, PG13, R, NC17, X

The default setting is ALLOW ALL.

#### **CANADIAN RATING SETTING**

In the CANADIAN RATING SETTING menu you can apply the English classification system or the French classification system as parental control. Depending on which system you choose, options are:

- ALLOW ALL
  - BLOCK ALL
  - E, C, C8+, G, PG, 14+, 18+
  - E, G, 8+, 13+, 16+, 18+
- The default setting is ALLOW ALL.

#### **Should you forget your code ...**

If you forget your V-Chip pincode, enter the V-CHIP menu and key in '9999'. You must now enter a new personal code.

*\*The V-CHIP menu is not available in Korea.*

## **About the SETUP menu ...**

In the SETUP menu, you set up your personal preferences. You can select a menu language to be used in the menus. When you select a preferred language for audio, this language will be used when available from the programme provider.

### **Contents of the SETUP menu ...**

**TIME ...** The clock is automatically set by the programme provider, but it can fail if the information is sent wrong.

**DAYLIGHT SAVING ...** Select whether to use daylight saving for the clock or not.

Options are YES and NO. The default setting is YES. Note that DAYLIGHT SAVING will only work if the programme provider's daylight saving flag is set to ON and you have set the DAYLIGHT SAVING to YES. Otherwise, real daylight saving is set to OFF.

**TIMEZONE ...** Set the local information for the clock. Options are EASTERN, CENTRAL, MOUNTAIN, PACIFIC, ALASKA, HAWAII, ATLANTIC and NEWFOUNDLAND. The default setting is EASTERN.

### **SOUND ...**

**MULTI-TRACK SOUND ...** Select the preferred audio language to be used, if available from the programme provider.

Options are ENGLISH, SPANISH and FRENCH. The default setting is ENGLISH.

**DIGITAL OUTPUT ...** Select the preferred sound output. Options are DOLBY DIGITAL and PCM. The default setting is DOLBY DIGITAL.

**MENU LANGUAGE ...** Select the language to be used in the menus. Options are ENGLISH, SPANISH and FRENCH. The default setting is ENGLISH.

**VERSION INFORMATION ...** Use this menu to see the current ATSC tuner version, model and release date.

*In Korea only MULTI-TRACK SOUND, DIGITAL OUTPUT and VERSION INFORMATION are available. Options for MULTI-TRACK SOUND are KOREAN, ENGLISH and JAPANESE. Default setting is KOREAN.*

# Settings and preferences for the Blu-ray player

The Blu-ray menus offer options for settings and adjustments. Here you find detailed information about the individual menus.

For an overview of the Blu-ray menu structure, [see page 5](#).

The Blu-ray player only supports playback of 12 cm discs.

If you play back a 3D Blu-ray disc, it is automatically shown in 3D.

## **Bring up the SETUP menu**

> Press **DVD Setup** to bring up the DVD SETUP menu. (Beo4: Press **LIST** and use the navigation button up or down to bring up **SHIFT** then press **8**).

## **What's on the PLAYBACK STATUS menu ...**

**STANDARD** ... Playback status and stop status will be displayed.

**EXTENDED** ... Playback status, stop status and automatic status, such as **BONUSVIEW** and angle, will be displayed, if available on the disc.

## **What's on the AUDIO FORMAT menu ...**

**STANDARD** ... Decode all audio formats to PCM for up to 7.1 (seven sound channels and one channel for low-frequency sound). **STANDARD** audio format is recommended to be able to play all sound tracks.

**RE-ENCODE** ... Decode all audio formats to DTS for up to 5.1 (five sound channels and one channel for low-frequency sound).

**BITSTREAM** ... All audio formats are sent in its original format for up to 7.1 (seven sound channels and one channel for low-frequency sound). If this option is selected, sound for Picture in Picture and effect sound for Blu-ray disc menus are not available.

## **What's on the VIDEO FORMAT menu ...**

**24 HZ ON** ... The signals are sent in format 1080p and 24 HZ. This is recommended.

**24 HZ OFF** ... The signals are sent in native format.

## **What's on the LANGUAGE menu ...**

**AUDIO** ... Enter the menu and select the preferred audio language to be used.

**SUBTITLE** ... Enter the menu and select the preferred subtitle language to be used\*.

**DISC MENU** ... Enter the menu and select the language to be used in disc menus.

## **What's on the ACCESS CONTROL menu ...**

When you enter the **ACCESS CONTROL** menu, you are asked to enter and confirm your access code. The first time you enter the menu, you are asked to select a new access code.

**PARENTAL LOCK** ... Enable or disable the Parental Lock function.

**RATING** ... Some discs feature a Parental Lock level. If you specify a level lower than the one contained on the disc, the disc will not play unless your access code is entered.

**NEW ACCESS CODE** ... Enter and confirm a new access code at any time.

## **What's on the ADVANCED menu ...**

**MEMORY MANAGEMENT** ... You can reset the BD-Live memory.

**NETWORK** ... If you choose the **CONFIGURATION** field to be **MANUAL** the fields **IP ADDRESS**, **SUBNET MASK**, **GATEWAY** and **DNS** become available. The **MAC ADDRESS** field informs you of the Mac address.

**MODULE INFORMATION** ... See information about software version and regions.

**SOFTWARE UPDATE** ... If your television is connected to the Internet, you can update the Blu-ray player, provided that new software is available. For further information contact your retailer.

*\*Some discs will require you to choose a subtitle language from a disc menu, even if you have previously selected a default subtitle language from the LANGUAGE menu.*



**To disable the Parental Lock ...**

IMPORTANT! You can disable the Parental Lock completely if, for example, you have forgotten your access code. You must remove the disc from the Blu-ray player and make sure the loader is closed before you disable the Parental Lock.

- > Press **DVD** to activate the Blu-ray player.
- > Press **Menu** twice to bring up the TV SETUP menu. (Beo4: Press **MENU** twice).
- > Use the navigation button down to move the cursor down to the OPTIONS menu.
- > Press **Menu** to reveal the item PARENTAL LOCK. (Beo4: Press **MENU**).
- > Press the centre button to bring up the PARENTAL LOCK menu.
- > Press the centre button to disable the Parental Lock, or ...
- > ... press and hold **BACK** to exit all menus without storing.

*NOTE! When you disable the Parental Lock, the Blu-ray player restarts automatically. All settings you have made for the Blu-ray player, such as language selection, are reset and you must make your settings again.*

# Blu-ray player – media browser

You can play music and browse your photos stored on a USB device or data disc on your television. You get access to the MEDIA BROWSER menu, when you insert a data disc or USB device in your television.

If you have music and photos stored on the same data disc or USB device, you can start the music and return to the main menu to start a slide show of your photos. Then you can play music and see your photos at the same time.

**The Blu-ray player only supports playback of music files in MP3 format and photo files in JPEG format.**

**Only remove a USB device when the Blu-ray player is switched off.**

**To play content from the USB device, playback of a loaded disc must be stopped.**

## Use the media browser

During playback of your music, you can see the NOW PLAYING menu with cover, and information about artist, title and track, if available. When you browse your photos you can bring up the INFO menu and get access to additional functions.

### *Listen to your music ...*

- > Press **DVD** to activate the Blu-ray player.
- > Insert a data disc or USB device with your music.
- > Use the navigation button up or down to select DATA DISC or USB and press the **centre** button.
- > Use the navigation button up or down to select the MUSIC menu and press the **centre** button.
- > Use the navigation button up or down to browse your files and folders and press the **centre** button to open the folder or start playback of the file.
- > Use **◀** and **▶** to cue during playback.
- > Use **▲** and **▼** to step in tracks during playback.
- > Press **STOP** to pause.
- > Press **Repeat** to repeat playback (Beo4: press the **yellow** button then press 6).
- > Press **PLAY** to resume playback.
- > Press **BACK** to back up through previous menus or press and hold **BACK** to return to the main menu.

MEDIA BROWSER

PHOTO  
MUSIC

*MEDIA BROWSER menu.*

### *Browse your photos...*

- > Press **DVD** to activate the Blu-ray player.
- > Insert a data disc or USB device with your photos.
- > Use the navigation button up or down to select DATA DISC or USB and press the **centre** button.
- > Use the navigation button up or down to select the PHOTO menu and press the **centre** button.
- > Use the navigation button up or down to browse your files and folders and press the **centre** button to open the folder.
- > Press the **centre** button to open your photo in full screen view. The slideshow starts automatically.
- > Press **STOP** to pause.
- > Press **PLAY** to resume playback.
- > Press **BACK** to back up through previous menus or press and hold **BACK** to return to the main menu.

# The pincode system

The pincode system is intended to make normal use of your television impossible for someone who does not know the pincode. You choose whether or not to activate the pincode system.

When the pincode system is activated and the television has been disconnected from the mains for 15–30 minutes, the pincode system goes into effect.

When reconnected and switched on, the television automatically switches itself off after four minutes. Entering the pincode returns the television to normal.

*Note: If you change your pincode more than five times within a three-hour period, the PINCODE menu becomes inaccessible for three hours, assuming that the television is not disconnected from the mains. Disconnecting the television resets the three-hour period.*

## Activate the pincode system

If you wish to deactivate the pincode system, you can do so by deleting your pincode.

### To activate the pincode system ...

- > Bring up the TV SETUP menu.
- > Press **◀** twice, followed by **STOP**. The PINCODE menu appears on the screen.
- > Enter the four digits of your code.
- > Press the **centre** button after the last digit is found.
- > Re-enter your code to confirm it and press the **centre** button again. If the two codes are not identical, the input fields are cleared and you must enter the code again.

### To change or delete your pincode ...

- > Bring up the TV SETUP menu.
- > Press **◀** twice, followed by **STOP**. The PINCODE menu appears on the screen.
- > Enter the correct pincode and press the **centre** button. DELETE PINCODE is highlighted.
- > To delete your code, press the **centre** button.
- > To change your code, use the navigation button down to highlight NEW PINCODE and press the **centre** button. Enter the new code and press the **centre** button. Re-enter the new code to confirm it.

*If you inadvertently press a wrong button while entering a code, press **BACK**. The entry is cancelled and the input fields are cleared.*

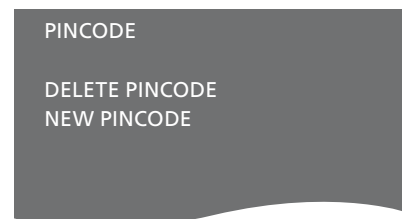
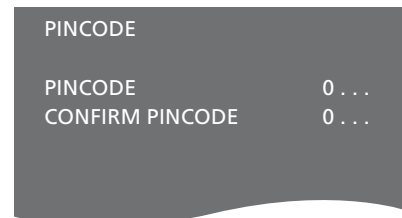

## Enter the pincode

If your television has been disconnected from the mains for 15–30 minutes, the television prompts you for the pincode when you switch it on. You may not be able to switch the television on immediately – wait approximately 30 seconds and try again.

**IMPORTANT!** *If you are prompted for a pincode the first time you switch on your television, contact your Bang & Olufsen retailer.*

*Should you lose or forget your code, contact your Bang & Olufsen retailer. Your retailer can provide you with a mastercode, which disables your pincode.*

### *To enter your pincode ...*

- > Enter the code digits.
- > Press the **centre** button when the last digit is entered.
- > Your television starts up again.

*Five incorrect entries will cause the television to shut down for three hours, during which operation is not possible.*

### *If you have forgotten your pincode ...*

- > Contact a Bang & Olufsen retailer to receive a five-digit mastercode.
- > When the television prompts you for your pincode, press and hold ◀◀ to bring up the MASTERCODE menu.
- > Enter the code digits and press the **centre** button to deactivate your pincode and reactivate your television.

### *To use the pincode system again ...*

- > Follow the procedure for activating the pincode system.

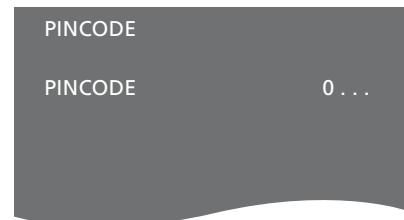

# Set up your remote control

You must set up your television to be operated with a remote control with or without a navigation button.

Even though your remote control has a navigation button, you can choose to set your television up for operation without navigation button. This can be useful if you have a BeoLink system also comprising a television without the REMOTE CONTROL menu.

If you set up your television for operation without a navigation button and your Beo4 has a navigation button, you must also change the MODE setting of your Beo4. See the Beo4 Guide or contact your retailer for further information.

## Remote control settings

In the REMOTE CONTROL menu you set up whether the Beo4 remote control you are using has a navigation button or not.

### *To make remote control settings ...*

- > Bring up the TV SETUP menu and highlight OPTIONS.
- > Press the **centre** button to bring up the OPTIONS menu, and highlight REMOTE CONTROL.
- > Press the **centre** button to bring up the REMOTE CONTROL menu.
- > Use the navigation button up and down to highlight the setting you want.
- > Press the **centre** button to store the setting.
- > Press **BACK** to back up through previous menus or press and hold **BACK** to exit all menus.

REMOTE CONTROL

NAVIGATION BUTTON

NO NAVIGATION BUTTON

*For information about menu operation with the different types of remote controls, [see page 6](#).*

# Feature activation

Additional features in your television can be made accessible via the FEATURE ACTIVATION menu. For information about additional features, contact your Bang & Olufsen retailer.

## Feature activation key

In order for additional features to become available, a feature activation key must be entered. The feature key can be purchased from your Bang & Olufsen retailer. The key cannot be deactivated again.

### *To enter an activation key ...*

- > Bring up the TV SETUP menu and highlight OPTIONS.
- > Press the **centre** button to bring up the OPTIONS menu and highlight FEATURE ACTIVATION.
- > Press the **centre** button to bring up the FEATURE ACTIVATION menu.
- > Select the feature, you wish to activate and press the **centre** button.
- > Enter the 12 digit key. An incorrect number can be deleted by pressing the navigation button left, all numbers can be deleted by pressing **BACK**.
- > When the numbers are entered, press the **centre** button to accept.



# HDMI MATRIX

The HDMI MATRIX feature is an additional feature which can be purchased separately. When the purchased feature activation key is entered, additional software becomes available in your television. The HDMI Matrix itself is a physical product that can be connected allowing you to connect several external sources to your television and access them via the Beo6 remote control. For information about additional features, contact your Bang & Olufsen retailer.

## Important information

The HDMI MATRIX must be connected and set up by your Bang & Olufsen retailer.

- Your Beo6 remote control must be reconfigured before you can use the HDMI Matrix.
- You cannot operate the HDMI Matrix with a Beo4 remote control.
- You cannot connect more than one HDMI Matrix in a setup.
- The HDMI Matrix cannot be configured on an HDMI Expander.
- You cannot configure both the HDMI Matrix and a source centre.

### Settings in the HDMI MATRIX menu ...

In the HDMI MATRIX menu, you can select settings for your HDMI Matrix.

### In the CONNECTIONS menu ...

- > Select the socket group to which you have connected a HDMI Matrix.
- > Select the HDMI MATRIX field and set it to YES.
- > The field INPUTS appears and you can specify the number of sources you want to connect. Set the field to a higher number of sources than you have connected.
- > Select an HDMI socket. You cannot select NONE.
- > Press the **centre** button to store the settings and bring up the HDMI MATRIX menu.
- > Select the connected HDMI Matrix type.
- > Press the **centre** button to store the settings and bring up the CONTROL menu.
- > Select an IR type to indicate how the TV control is connected to the HDMI Matrix.
- > Press the **centre** button to store the settings.

When you have stored the settings for the HDMI Matrix, an input list menu appears for you to configure the sources connected to the matrix, [see page 64](#).

AV1

SOURCE	V.AUX2
HDMI MATRIX	YES
INPUTS	8
AUTO SELECTION	NO
TIMER RECORDER	NO
HDMI	A
SOUND INPUT	HDMI

*If you at a later time disable a stored HDMI Matrix configuration by setting the HDMI MATRIX field to NO, your settings are still saved. This means that if you set the field to YES later, all your settings reappear.*

*When a HDMI Matrix is activated, it is automatically registered as V.AUX2, also if another source may already be registered as V.AUX2. This source must then be registered to another source name.*

**Add sources to your setup ...**

The sources connected to the HDMI Matrix must be registered in the television.

**Configuration of inputs ...**

- > Configure each input one by one.
- > Name each input by following on-screen instructions. If you do not name an input, the name from the selected PUC list is used.
- > Select a PUC source for the specific input. The sources are divided into four categories: SET-TOP BOX, DVD PLAYER/RECORDER, VIDEO RECORDER and OTHER.
- > When you store the input settings, you can configure the next input. Continue the procedure until all connected inputs are configured.
- > Press the **green** button to return to the CONNECTIONS menu.

HDMI MATRIX	
INPUT 1	NONE
INPUT 2	NONE
INPUT 3	NONE
INPUT 4	NONE
INPUT 5	NONE
INPUT 6	NONE
INPUT 7	NONE
INPUT 8	NONE



# Operate other equipment with Beo6 or Beo4

The built-in Peripheral Unit Controller acts as an interpreter between connected video equipment, such as a set-top box, video recorder or DVD player, and your Bang & Olufsen remote control.

Use the Bang & Olufsen remote control to gain access to the functions offered by your non-Bang & Olufsen equipment.

When you switch on the equipment, the functions are available via the Beo6 display, or via a menu-overlay on the television screen, if you use a Beo4 remote control.

For instruction in the various functions offered by your equipment, see the product's own guide.

Some features and functions of the television may not be available when non-Bang & Olufsen equipment is connected. Not all connected video equipment are supported by Bang & Olufsen. For further information about supported equipment, contact your Bang & Olufsen retailer.

## Use the Beo6 remote control

The main functions of your equipment can be operated with the Beo6 remote control. Not all functions may be supported by Beo6. The available services and functions are shown in the Beo6 display when you activate the equipment.

- > Press a source button, for example **DTV**, to switch on connected equipment.
- > Press the button on the Beo6 display that activates the function you want.

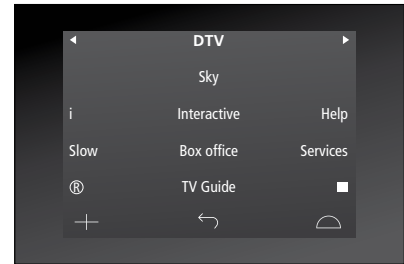

Example of a Beo6 display used to operate a set-top box.

## Use equipment menus

Once you have activated connected equipment, you can operate its own menus with your remote control.

### *While equipment menus are shown ...*

- > Use the navigation button up, down, left and right to move in menus.
- > Press the **centre** button to select and activate a function.
- > Press **BACK** to exit menus, or return to a previous menu.
- > Press **+** and use the number buttons to enter information in menus or services when relevant. (Beo4: Use the number buttons).
- > Use the coloured buttons as indicated in the menus of your connected equipment.
- > Press **BACK** to back up through previous menus or press and hold **BACK** to exit all menus.

*When you have selected connected equipment as a source, press **Menu** twice to bring up the television's main menu.*

## Use the Beo4 remote control

If you have a Beo4 remote control, some functions are available directly via Beo4 when you switch on the equipment. Additional functions are available through a menu-overlay that you bring up on the screen. In this menu you can see which Beo4 buttons activate specific services or functions.

Your Bang & Olufsen retailer can provide you with a 'show mapping' survey which explains operation of the connected equipment with Beo4 in more detail.

- > Press a source button, for example, **V.MEM**, to switch on connected equipment.
- > Press **MENU** to bring up the menu-overlay.
- > Press the number button that activates the function you want, or press one of the coloured buttons to activate a function.

*The menu-overlay for equipment connected to a main room television cannot be displayed on the television screen in the link room. However, you can still access the different features if you press **LIST** and use the navigation button up or down to bring up **SHIFT** and then select a number or colour.*

### Direct Beo4 operation

If you know which Beo4 button activates the function you want, you can activate the function without bringing up the menu-overlay first.

#### *While your equipment is on ...*

- > Press one of the coloured buttons to activate a function.
- > Press and hold the **centre** button to bring up the Program Guide or the 'Now/Next' banner on the screen if you are using equipment that supports these functions.
- > Press **MENU** and use the number buttons to activate the function you want.
- > Use **▲** and **▼** to step between channels\*.
- > Use **◀** and **▶** to rewind and wind in, for example, recordings\*.

*\*This operation does not apply to Beo4 without navigation button.*

*On some connected equipment you have to press **LIST** and use the navigation button up or down to bring up **SHIFT** and press **9** to switch the equipment on and off, and on some you have to press **PLAY** then **0**.*

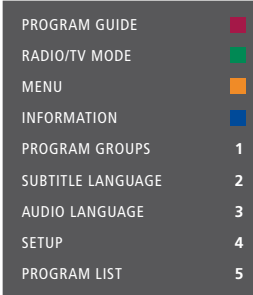

PROGRAM GUIDE	■
RADIO/TV MODE	■
MENU	■
INFORMATION	■
PROGRAM GROUPS	1
SUBTITLE LANGUAGE	2
AUDIO LANGUAGE	3
SETUP	4
PROGRAM LIST	5

*Example of a menu-overlay. The Beo4 buttons are shown to the right on the menu, and the functions they control are shown to the left. The menu may also list buttons on the remote control included with your connected equipment.*

# Connect and operate an audio system

If you connect a compatible Bang & Olufsen audio system to the television using a Master Link cable, you obtain the benefits of an integrated audio/video system.

Play a CD on your audio system using speakers connected to the television, or switch on a TV programme and send the sound to your audio system speakers.

Your AV system can be placed together in one room or in two rooms with the television placed in one room and the audio system with a set of speakers placed in another.

**Not all Bang & Olufsen audio systems support integration with the television.**

## Connect your audio system to the television

*Using a BeoLink cable, connect the sockets marked MASTER LINK on the television and the audio system.*

### Program the AV setup with Beo6

If your television has been set up in an AV system, you may need to set it to the correct Option with Beo6. Switch the entire system to standby first.

#### *Option setting for the television ...*

- > Place yourself in front of the television.
- > While holding the • button, press the **centre** button to bring up the SETUP menu on Beo6.
- > Let go of both buttons.
- > Press **Option Pgm** to bring up the Option Programming display on Beo6.
- > Press the button that matches the zone in which the television is placed, for example, **Tv Area**.

#### *Option setting for the audio system ...*

- > Place yourself in front of the audio system.
- > While holding the • button, press the **centre** button to bring up the SETUP menu on Beo6.
- > Let go of both buttons.
- > Press **Option Pgm** to bring up the Option Programming display on Beo6.
- > Press the button that matches the zone in which the audio system is placed, for example, **Audio Area**.

*If you move your link room products to other rooms, remember to have your Beo6 remote control reconfigured by your Bang & Olufsen retailer.*

### Program the AV setup with Beo4

You can set your television, placed in an AV-system, to the correct Option using Beo4. Switch the entire system to standby first.

#### *Option setting for the television ...*

- > While holding the • button on Beo4, press **LIST**.
- > Let go of both buttons.
- > Use the navigation button up or down to bring up **OPTION?** in the Beo4 display and press the **centre** button.
- > Use the navigation button up or down to bring up **V.OPT** in the Beo4 display and then enter the appropriate number (**1, 2, 4, 5** or **6**).

#### *Option setting for the audio system ...*

- > While holding the • button on Beo4, press **LIST**.
- > Let go of both buttons.
- > Use the navigation button up or down to bring up **OPTION?** in the Beo4 display and press the **centre** button.
- > Use the navigation button up or down to bring up **A.OPT** in the Beo4 display and enter the appropriate number (**0, 1, 2, 4, 5** or **6**).

>> Connect and operate an audio system

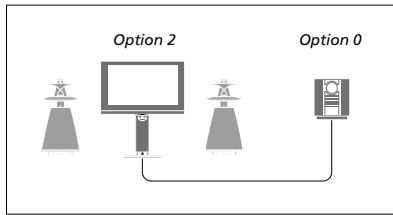

If the television and an audio system is set up in one room with all speakers connected to the television, set the television to Option 2 and the audio system to Option 0.

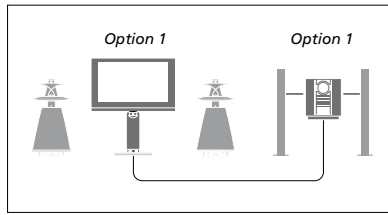

If the television (with or without additional speakers) and the audio system (with a connected set of speakers) is set up in the same room, set the television to Option 1 and the audio system to Option 1.

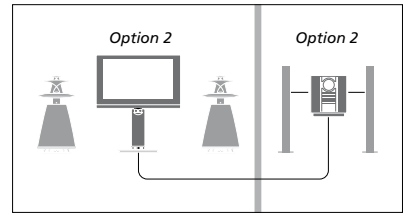

If the audio system is set up in one room, and the television (with or without additional speakers) in another, set the television to Option 2 and the audio system to Option 2.

For information about Option 4, 5 and 6, see [pages 72 and 74](#). For further information, contact your retailer.

## Use an audio/video system

If you integrate your audio system and your television, you can choose a speaker combination appropriate to the current video or audio programme, and also record video sound on the audio system.

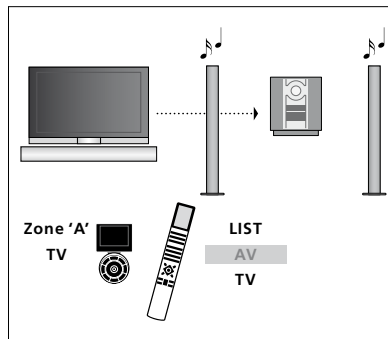

To listen to sound from a television source on your audio system speakers without switching on the screen, select the zone for your audio system speakers on Beo6, and then press a source button, such as **TV**. (Beo4: Press **LIST** and use the navigation button up or down to bring up **AV** in the Beo4 display, then press **TV**). Beo6 instruction is shown to the left and Beo4 instruction to the right.

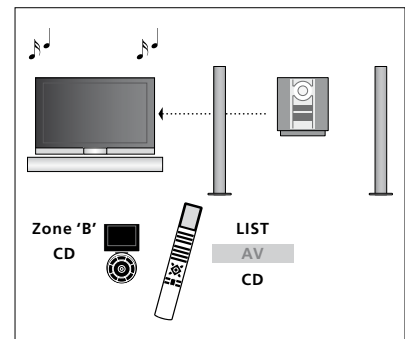

To listen to audio sound on the speakers connected to the television, select the zone for speakers connected to the television on Beo6, and then press an audio source button, such as **CD**. (Beo4: Press **LIST** and use the navigation button up or down to bring up **AV** in the Beo4 display, then press **CD**). Beo6 instruction is shown to the left and Beo4 instruction to the right.

# Distribute sound and picture with BeoLink

The BeoLink system makes it possible to distribute picture and/or sound to other rooms throughout the house.

For example, you can connect your television in the living room to another video system or set of speakers in another room, thereby making it possible to 'move' the picture or sound to other rooms.

If you have a BeoLink distribution system installed, you can either use your television in the main room, such as a living room, or in a link room, such as a study or bedroom.

Under certain circumstances, it may be necessary to enter modulator settings.

## Link connections

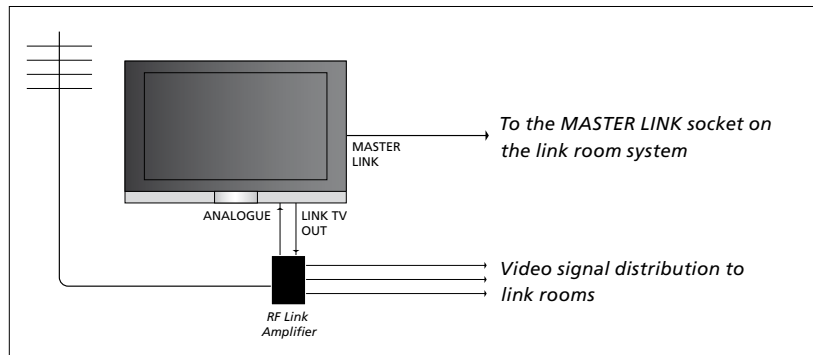

**The main room television must be connected to the link room system with a Master Link cable:**

- > Connect the Master Link cable to the socket marked MASTER LINK on the television.
- > If you want to distribute video signals as well, connect an ordinary aerial cable to the socket marked LINK TV on the television. Then run the aerial cable to the RF Link Amplifier and the Master Link cable to the link room. Follow the instructions enclosed with the link room equipment.

*If an audio system is already connected to the Master Link socket and you wish to connect more equipment, the Master Link cable must be split in two and joined with the cable from the link room using a special junction box. Contact your Bang & Olufsen retailer for assistance.*

*HDMI, VGA and Y – Pb – Pr signals cannot be distributed from a main room television to the link room system.*

## System modulator

If you have an audio setup, such as a BeoLink Active/Passive, and you choose to set up a non-linkable television in the same room, you must set the system modulator to ON. The factory setting is AUTO, which must be used if you are using a linkable Bang & Olufsen television.

### *To switch on the system modulator ...*

- > Bring up the TV SETUP menu and highlight OPTIONS.
- > Press the **centre** button to bring up the OPTIONS menu and highlight CONNECTIONS.
- > Press the **centre** button to bring up the CONNECTIONS menu, and highlight LINK.
- > Press the **centre** button to bring up the LINK menu and highlight MODULATOR.
- > Use the navigation button left or right to reveal ON.
- > Press the **centre** button to store the setting, or ...
- > ... press and hold **BACK** to exit all menus without storing.

## Link channel

If, for example, a TV channel in your area is broadcasted on the same channel as the factory setting for the BeoLink system; channel 66, you must tune the system modulator to an unoccupied channel. When you change the link channel in the main room television, make sure that the link channel in the link room television corresponds to it.

### *To change the link channel ...*

- > Bring up the TV SETUP menu and highlight OPTIONS.
- > Press the **centre** button to bring up the OPTIONS menu and highlight CONNECTIONS.
- > Press the **centre** button to bring up the CONNECTIONS menu, and highlight LINK.
- > Press the **centre** button to bring up the LINK menu and highlight CHANNEL.
- > Use the navigation button left or right to find an unused **channel**.
- > Press the **centre** button to store the setting, or ...
- > ... press and hold **BACK** to exit all menus without storing.

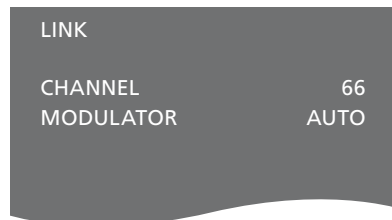

*The LINK menu.*

*When tuning in the link channel in the link room, a test image is shown. FINE TUNE is only available in link room/Option 4 setups.*

# Your television in a link room

If you have BeoLink installed in your home and you choose to place your television in a link room, you can operate all connected systems through the television.

You must follow the procedure described below when you connect your television for use in a link room:

- 1 **Connect the link room television to the mains**
- 2 **Using your remote control, program the link room television to the correct Option**
- 3 **Disconnect the link room television from the mains**
- 4 **Make the necessary connections**
- 5 **Reconnect the link room television to the mains.**

## Option setting

For your entire system to function properly, it is essential that the television in the link room is set to the correct Option before you connect it to the television in the main room!

### With Beo6 ...

- > Place yourself in front of the link room television.
- > While holding the **•** button, press the **centre** button to bring up the SETUP menu on Beo6.
- > Let go of both buttons.
- > Press **Option Pgm** to bring up the Option Programming display on Beo6.
- > Press the button that matches the zone in which the television is placed.

### With Beo4 ...

- > While holding the **•** button, press **LIST** on Beo4.
- > Let go of both buttons.
- > Use the navigation button up or down to bring up **OPTION?** in the Beo4 display and press the **centre** button.
- > Use the navigation button up or down to bring up **V.OPT** in the Beo4 display and press **6\***.

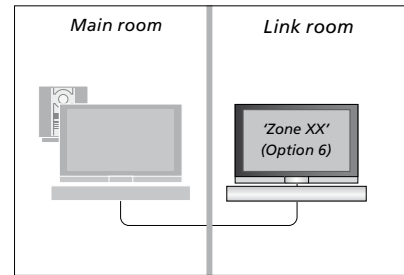

*\*If you connect the television for use in a link room where other link systems are already connected, such as speakers, you must set the television to Option 5 instead.*



## Link room operation

When you are in the link room, you can operate all connected systems with the remote control.

*Use sources present only in one of the rooms ...*

- > Press the button for the source you wish to use, for example **RADIO**.
- > Operate the selected source as usual.

*Use a main room source – source type present in both rooms ...*

- > Press **Link** to bring up a source display. (Beo4: Press **LIST** and use the navigation button up or down to bring up **LINK** in the Beo4 display).
- > Press the button for the source you wish to use, for example **TV**.
- > Operate the source as usual.

*Use a link room source – source type present in both rooms ...*

- > Press the button for the source you wish to use, for example **TV**.
- > Operate the source as usual.

*Listen to stereo sound in your link room ...*

*Usually sound distributed from a main room video source, such as a set-top box, to the link room is transmitted in mono. However, you can select stereo sound:*

- > Press **TV** to switch on the television.
- > Press **AV** to bring up a source display. (Beo4: Press **LIST** and use the navigation button up or down to bring up **AV** in the Beo4 display).
- > Press, for example **DTV**, to activate a source connected to the main room television, such as a set-top box.

While using this function, distribution of other main room sources to other link room systems is not possible.

*Sound in the main room and the link room is sometimes not synchronised. In some cases, you can synchronise the sound by selecting a source, then pressing **AV** and selecting the source again. (Beo4: Select a source, then press **LIST** and use the navigation button up or down to bring up **AV** in the Beo4 display and then select the source again).*

*If you switch to a different source in the main room, the sound volume may change.*

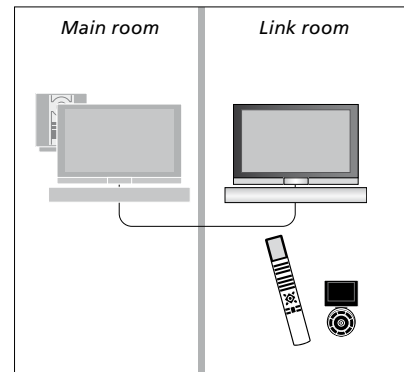

## Two televisions in the same room

If you have placed your television in a room where you already have a Bang & Olufsen television, and commands from your remote control can be received by both televisions, you must change the Option setting of the television. This prevents simultaneous activation of both televisions.

When you Option program the television, disconnect the television you do not want to program from the mains. This ensures that only the television, you want to program, receives the Option programming.

### One remote control for both televisions

For your television to function properly, it is essential that the television is set to the correct Option, [see page 72](#) for information on Option programming. If you have a Beo4, you must set your television to Option 4, and if you have a Beo6, you must set the television to the correct zone\*.

#### Beo4 – Operate your television in Option 4 ...

Normally, you can activate a source, such as TV, simply by pressing the relevant source button on your remote control. However, when you set your television to Option 4, you must do the following, if you have a Beo4:

- > Press **LIST** and use the navigation button up or down to bring up **LINK** in the Beo4 display.
- > Press a source button, such as **TV**.

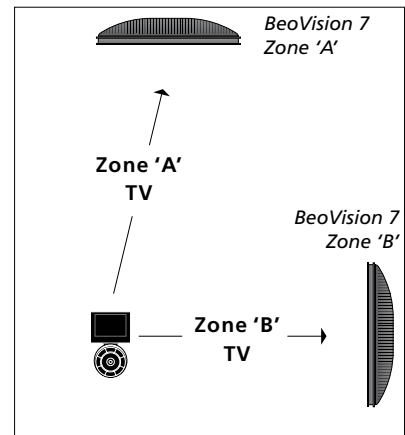

Beo6 operation.

\*NOTE! For information about choice of zone, contact your Bang & Olufsen retailer.

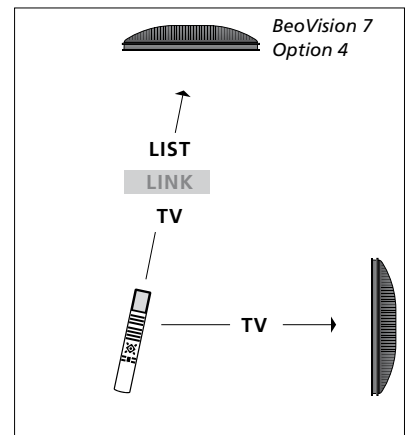

Beo4 operation.