

**32" LCD Television with NTSC/ATSC Tuner**  
**FLM-323B**



# Federal Communications Commission Statement



This equipment has been tested and found to comply with the limits of a class B digital device, pursuant to Part 15 of the FCC Rules. These limits are designed to provide reasonable protection against harmful interference in a residential installation. This equipment generates, uses and can radiate radio frequency energy and, if not installed and used in accordance with the instructions, may cause harmful interference to radio communications. However, there is no guarantee that interference will not occur in a particular installation. If this equipment does cause harmful interference to radio or television reception, which can be determined by turning the equipment off and on, the user is encouraged to try to correct the interference by one or more of the following measures:

1. Reorient/Relocate the receiving antenna.
2. Increase the separation between the equipment and receiver.
3. Connect the equipment into an outlet on a circuit which is different from what the receiver is connected to.
4. Consult the dealer or an experienced radio/TV technician for help.



**Changes or modifications not expressly approved by the manufacturer responsible for compliance could void the user authority to operate the equipment.**

# Warnings and Precautions

To prevent any injuries, the following safety precautions should be observed in the installation, use, servicing and maintenance of this equipment.

Before operating this equipment, please read this manual completely, and keep it nearby for future reference.



This symbol is intended to alert the user to avoid the risk of electric shock. This equipment must not be disassembled by anyone except qualified service personnel.



This symbol is intended to alert the user to the presence of important operating and maintenance instructions in the literature accompanying the appliance.



To reduce the risk of fire or electric shock, do not expose this equipment to rain or moisture.

- TO REDUCE THE RISK OF ELECTRIC SHOCK, DO NOT REMOVE COVER (OR BACK).
- NO USER-SERVICEABLE PARTS INSIDE.
- REFER SERVICING TO QUALIFIED SERVICE PERSONNEL.



Use of controls, adjustments or performance of procedures other than those specified herein may result in hazardous radiation exposure.

## Important Safety Instructions



This symbol indicates caution points.



This symbol indicates actions that should not be done.



This symbol indicates actions that must be performed.



Do not place the equipment on any uneven or unstable carts, stands, tables, shelves etc. The equipment may fall, causing serious injury to children or adults and serious damage to the equipment itself.

Use only a cart or stand recommended by the manufacturer. This equipment and recommended cart or stand should be handled with care. Quick stops, excessive force, and uneven surfaces may cause the equipment and cart/stand to overturn.



Do not disable the 3-wire grounding type plug. The grounding pin on the 3-prong plug is an important feature. Removing the grounding pin will increase the risk of damaging the equipment.

If you can not fit the plug into the electrical outlet, contact an electrician to install a grounding outlet.

Always operate this equipment from the type of power source indicated on the rear of the serial/model plate.



- Never overload wall outlets and extensions.
- Use and handle the power cord with care. Do not place any heavy objects on the AC power cord.
- Do not pull the AC power cord. Do not handle the AC power cord with a wet hand.
- Do not touch the power cord and antenna cable during lightning.
- Remove the plug from the wall outlet, if the equipment will not be used for a long period of time.
- Do not place, use or handle this equipment near water.
- Never expose the equipment to liquid, rain, or moisture.  
Seek for service if any of the above is spilled into the equipment.
- Do not expose the equipment to extreme temperature or to direct sunlight, as the equipment may heat up and suffer damage.
- Do not install the equipment near any heat sources such as radiators, heat registers, stoves, or any other apparatus that might produce heat.
- Do not attempt to service the equipment yourself.
- Opening and removing the covers may expose you to dangerous voltage or other hazards and may void your warranty. Refer service to qualified personnel.
- Do not place or drop any other objects on top.
- Do not insert anything into the ventilation holes of your equipment.  
Inserting any metal or flammable objects may result to fire or electric shock.



- Do not place the equipment on uneven or unstable carts, stands, tables, shelves etc. The equipment may fall, causing serious injury to children or adults and serious damage to the equipment itself.  
Always place the equipment on the floor or on a surface that is sturdy, level, stable and strong enough to support the weight of the equipment.
- Do not block any ventilating openings. Leave an open space around the equipment.  
Never place the equipment :  
on a bed, sofa, rug, or any other similar surfaces; too close to drapes/curtains/walls, in a bookcase, built-in cabinet, or any other similar places that may cause poor ventilation.



- Always remove the power cord from the outlet before cleaning the equipment.
- Never use liquid or aerosol cleaners on the equipment.  
Clean only with a soft dry cloth.

### Antenna Safety Instructions

If an outdoor antenna is connected, follow the precautions below:



- An outdoor antenna should not be located in any area where it could come in contact with overhead power lines, or any other electric light or power circuits.
- When installing an outdoor antenna system, extreme caution should be taken to prevent contact with power lines. Direct contact with power lines may be fatal and should be avoided at all costs.

Section 810 of National Electrical Code (NEC) provides information with respect to proper grounding of the mast and supporting structure, grounding of the lead-in wire to an antenna discharge unit, size of grounding conductors, location of antenna discharge unit, connection to grounding electrodes, and requirements for the grounding electrode.

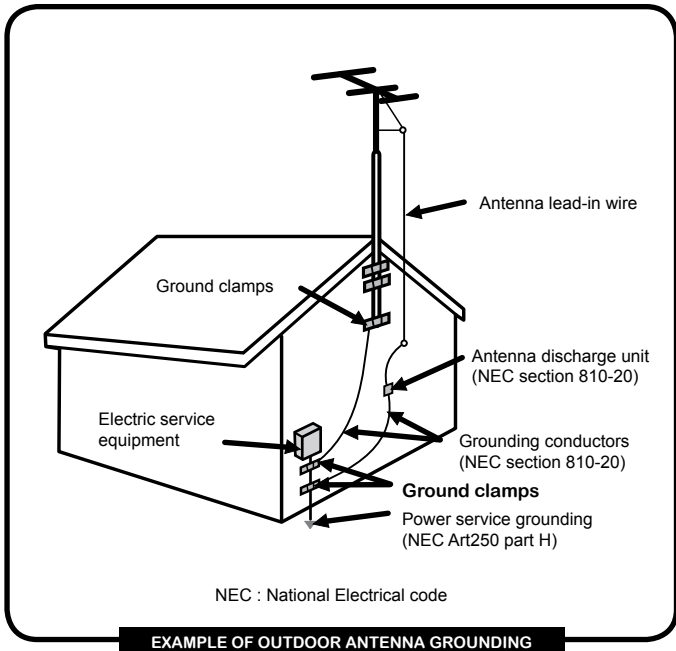

# TABLE OF CONTENTS

■ <b>Federal Communications Commission Statement</b> .....	1
■ <b>Warnings and Precautions</b>	
Important Safety Instructions .....	2
Antenna Safety Instructions .....	4
■ <b>Chapter 1 Introducing the LCD TV</b>	
Key Features .....	6
Package Contents .....	7
Setting Up Your LCD TV .....	8
Your LCD TV .....	10
Your Remote Control .....	12
■ <b>Chapter 2 Installing the LCD TV</b>	
Connecting a TV Cable or an Antenna .....	14
Connecting a VCR .....	18
Connecting a Video Camera or Play Station .....	19
Connecting a DVD Player .....	20
Connecting a Digital TV Cable Box or Digital Satellite Receiver .....	22
Connecting an AV Equipment with HDMI Connector .....	23
Connecting an AV Equipment with DVI Connector .....	24
Connecting a PC .....	25
Connecting an Audio Receiver or a Dolby Digital 5.1 Sound System .....	26
■ <b>Chapter 3 USING THE FEATURES</b>	
Using Picture-In-Picture .....	27
Wide Screen Viewing .....	29
Operating the Menu .....	30
Setting up the HDTV Function .....	32
Customizing the VIDEO Settings .....	35
Customizing the AUDIO Settings .....	36
Customizing the SETUP Settings .....	37
Using the V-CHIP Settings .....	39
Using the Parental Settings .....	41
Customizing the TV Settings .....	42
■ <b>Specifications</b> .....	43
■ <b>Chapter 4 Programming your Remote Control</b>	
Introduction .....	A
Programming a Device .....	A
Troubleshooting .....	B
Manufacturer's Codes .....	C

# Chapter 1

## Introducing the LCD TV

### Key Features

---

#### Various Audio/Video terminals for external equipment connection

- 2 set of composite A/V input terminals
- 1 set of S-VIDEO terminals
- 2 set of component Video input terminals
- 1 VGA/ Audio input terminal
- 1 HDMI/Auido input terminal
- 1 sets of Audio(L/R) output terminals
- 2 SPDIF output terminal (Optical x 1 /Coaxial x 1)
- 1 Headphone terminal

#### The built-in TV tuner to receive HD ATSC

- This function allows the reception of HD broadcasting without the addition of a set top box.

#### High Definition Multimedia Interface (HDMI)

- High Definition Multimedia Interface (HDMI) is a small, user-friendly interconnect that can carry up to 5 Gbps of combined video and audio in a single cable. This system eliminates the cost, complexity and confusion of multiple cables used to connect current A/V systems.

#### HDTV Component Video Inputs

- Offers the best video quality for DVD(480p) and digital set-top-box (HD1080i, 720p) connections.

#### 3D Digital Noise Reduction

- This function can digitally reduce image noise to provide better picture quality.

#### Film-Mode Detection (3:2 Reverse Pull Down)

- This function can automatically detect content derived from film and adjust the interlacer's frame matching to provide a more natural-looking, clearer image of the moving picture.

#### PIP Function

- Provides viewing of two programs simultaneously, in either picture-in-picture mode or picture-on-picture (side by side) mode.

## Package Contents

Make sure all of the following contents are included.

- LCD TV



- Bottom Stand /  
Screw Driver and 6 Screws

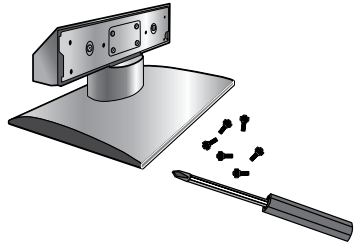

- Remote Control/  
AA Batteries x 2



- VIDEO Cable



- Component Cable

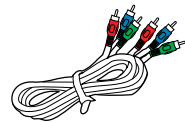

- Power Cord



- AUDIO Cable

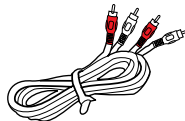

- Warranty Card



- User's Manual



- Quick Start Guide



These items are all you need to set up and operate the LCD TV in its basic configuration.



Make sure all of the above contents are included in the package. If you are missing any items, please contact the Polaroid customer service department.



## Setting Up Your LCD TV

### Attach the Stand

If you prefer to mount your new Polaroid TV on a wall instead of attaching it to the stand, please reference the instructions included in the wall mounting kit (not included).

**IMPORTANT: Attach the Stand to the TV with the bottom foam packaging material still attached.**

Read all instructions before continuing with the stand installation.

- a) Lift foam packaging material from the top of the TV out of the box.
- b) Lift TV out of box, with the bottom foam packaging material still attached, and place onto a stable surface.

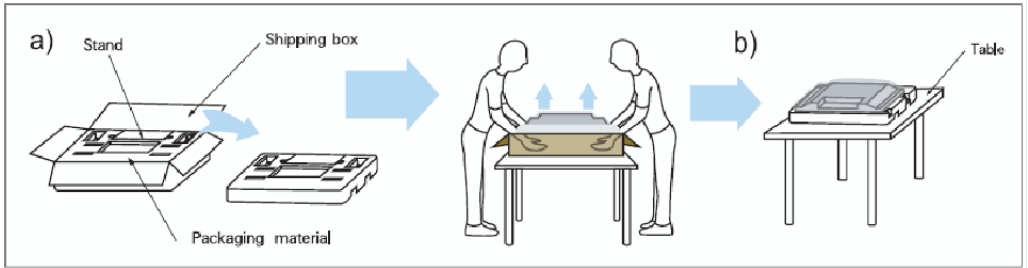

- c) Remove the protective bag from the LCD unit, but DO NOT remove the bottom foam packaging material.
- d) Locate the place on the back of the TV to attach the stand. Secure the stand to the LCD with all six screws.

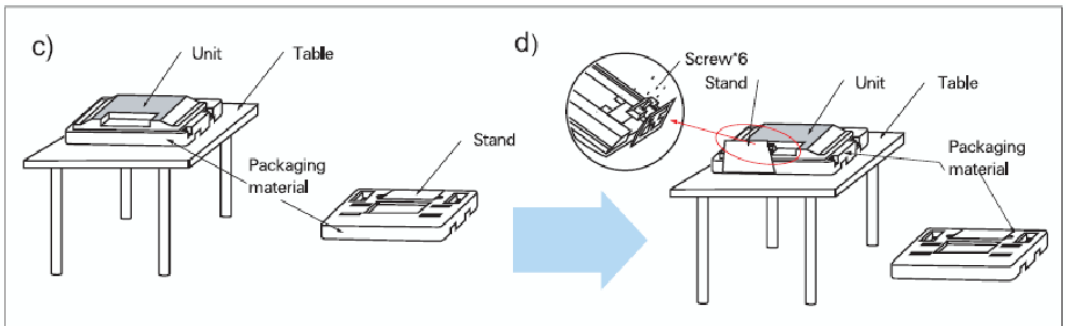

- 1 Use a supplied antenna cable to connect the VHF/UHF signal to the LCD TV's ANT. terminal (refer to page17).
- 2 Connect the AC power cord at the back of the TV and connect the power cord to wall outlet.
- 3 Insert the 2 batteries supplied in remote control.

**Step1** Slide the back cover up to open the battery compartment of the remote control.

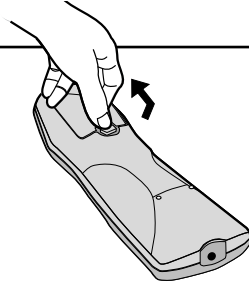

**Step2** Insert two AA size batteries. Make sure to match the (+) and (-) ends of the batteries with the (+) and (-) ends indicated in the battery compartment. Slide the cover back into place.

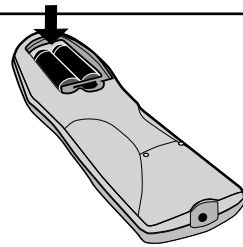

Do not use caustic cleaners (porcelain, stainless steel, toilet, or oven cleaner etc.) on the remote, as it may suffer damage.

- 4 Connect other an external A/V device (refer to page14-26).

## Your LCD TV

### Front/Right Side View and Controls

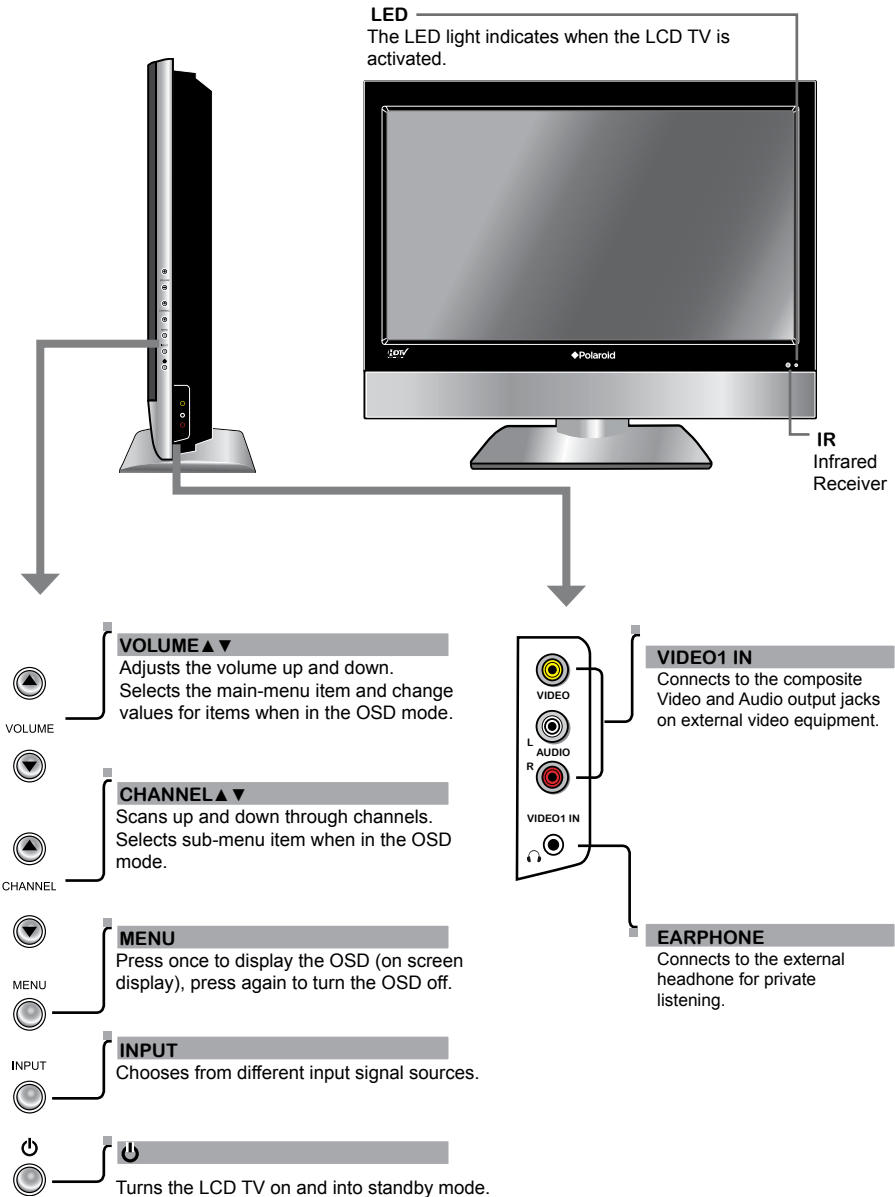

Rear View and Jacks

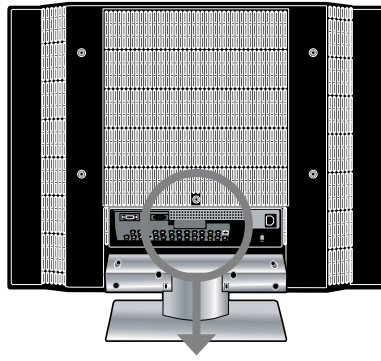

**VIDEO2 IN**

Connects to the composite VIDEO and AUDIO(L/R) output jacks on external video equipment.

**HDMI IN**

Connects the all digital AV equipment with HDMI connector. HDMI supports enhanced, high-definition video and two-channel digital audio. The AUDIO(L/R) of HDMI IN is for DVI connection.

**S-VIDEO IN**

Connects to the S-VIDEO and AUDIO(L/R) output jacks on external video equipment.

**VGA IN**

Connects the PC, or other AV equipment with VGA and AUDIO(L/R) output jacks.

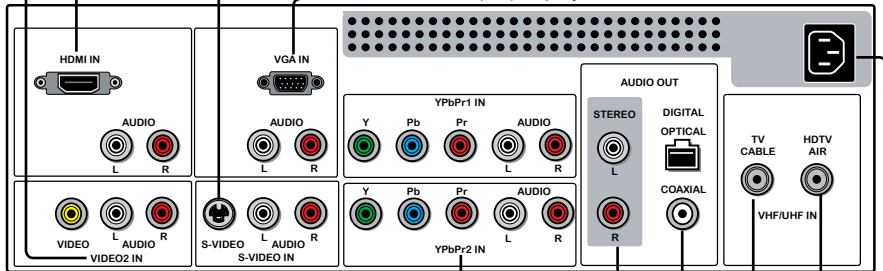

**YPbPr1 IN/YPbPr2 IN**

Connects to the DVD player, Digital Set-Top-Box, or other AV equipment with component(YPbPr) video and audio output jacks.

**AUDIO OUT-STEREO**

Connects to the AUDIO(L/R) input jacks on AV equipment.

**AUDIO OUT-DIGITAL-OPTICAL/COAXIAL**

Connects to the OPTICAL AUDIO jack on the digital/standard 5.1 audio system.

**VHF/UHF IN-TV-CABLE**

Connects RF input from VHF/UHF antenna or cable.

**VHF/UHF IN-HDTV-AIR**

Connects RF input from VHF/UHF antenna or cable to receive high/standard definition television.

**AC IN**

Connects to the AC power cord.

## Your Remote Control

This package includes a Polaroid remote that enables control of up to four devices.

To select a device, simply select one of the following device mode controls: TV, CBL/SAT, DVD/VCR, or AUDIO.

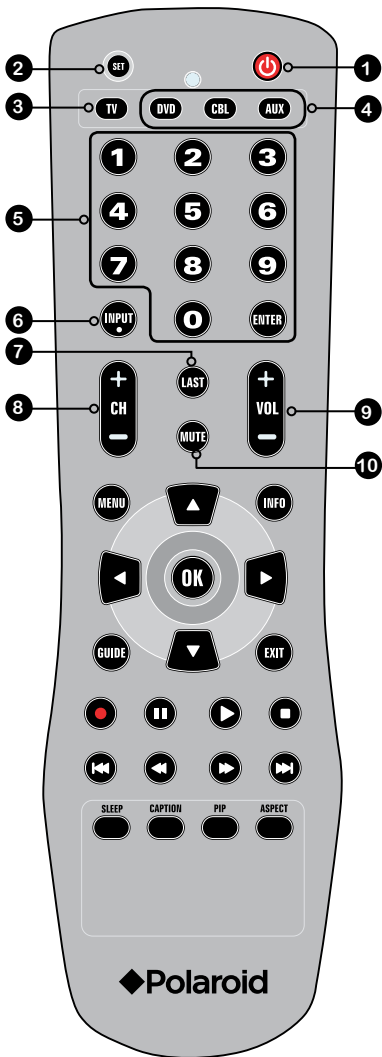

- 1** Turns the LCD TV on and off.

---

- 2** **SET** Remote control universa code setup. For more information on setting up your remote control, please see the "Programming Your Remote Control" section.

---

- 3** **TV** Controls this LCD TV.

---

- 4** **DVD** Controls DVD player or Video player.

---

- CBL** Controls Cable Converter or Satellite Receiver.

---

- AUX** Controls Audio Amplifier

---

- 5** **0-9/ENTER** Pressing a number selects a channel. Following selection, pressing ENTER activates the channel, or channel activates automatically in 3 seconds.

---

- 6** **INPUT** Pressing INPUT to display a source list, use **▲▼** buttons to select the video equipment connected to the video inputs of your LCD TV: TV/HDTV/VIDEO1/VIDEO2/VIDEO3/VIDEO4/VIDEO5/VIDEO6/COMPUTER.  
  
 In HDTV mode, use with 0-9 and ENTER buttons to select a digital channels.

---

- 7** **LAST** Returns to previously selected channel.

---

- 8** **CH+/-** Change channel up and down.

---

- 9** **VOL+/-** Increases and decreases volume.

---

- 10** **MUTE** Pressing once mutes audio. Pressing again restores audio.

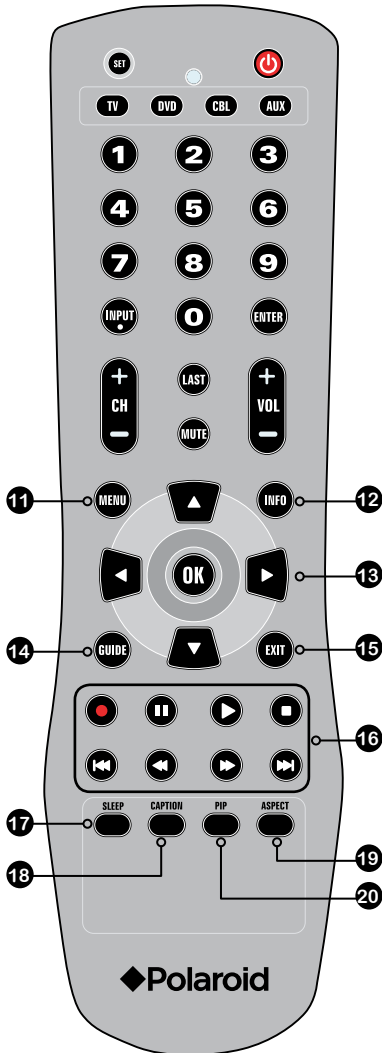

- 11 MENU** Displays the OSD menu on the screen.
- 12 INFO** Pressing once displays a variety of information such as the current channel and the input source.
- 13 ▲▼▶◀,OK** Cycles through OSD options and selects individual menu items. OK confirms option settings.
- OK** In HDTV mode, pressing OK to display a digital channel list.
- 14 GUIDE** In HDTV mode, pressing GUIDE displays the Program Guide on the screen.
- 15 EXIT** Exits the OSD menu.
- 16 ● || ▶ ■** Other device function keys  
◀◀ ◀ ▶▶ ▶▶
- 17 SLEEP** Cycles through the LCD TV sleep time: OFF/30/60/90/120 mins.
- 18 CAPTION** Cycles through the Closed Caption: OFF/CC1/CC2/CC3/CC4/TT1/TT2/TT3/TT4.
- 19 ASPECT** Cycles through Wide mode settings: NORMAL/FULL/WIDE/ZOOM.
- 20 PIP** Turns PIP/POP on and off.

**Effective range:**

The remote can control the LCD TV from up to 5m away, if pointed directly at the receiver.

# Chapter 2

## Installing the LCD TV

Refer to the owner's manual of any external equipment to be connected. When connecting any external equipment, do not connect any AC power cords to wall outlets until all other connections are completed.

### Connecting a TV Cable or an Antenna

#### Antenna Connection

The antenna requirements for good color TV reception are more important than those for a black & white TV reception. For this reason, a good quality outdoor antenna is strongly recommended. The following is a brief explanation of the type of connection that is provided with the various antenna systems.

- A 75-ohm system is generally a round cable (not included) with F-type connector that can easily be attached to a terminal without tools.

F-type connector



75-ohm coaxial cable (round)

- A 300-ohm system is a flat twin-lead cable (not included) that can be attached to a 75-ohm terminal through a 300-75-ohm adapter (not included).



300-ohm twin-lead cable (flat)

Use one of the following two diagrams when connecting an outdoor antenna.

A: Shows how to use a VHF/UHF combination outdoor antenna.

B: Shows how to use a separate VHF and/or UHF outdoor antenna.

### A. Combination VHF/UHF antenna

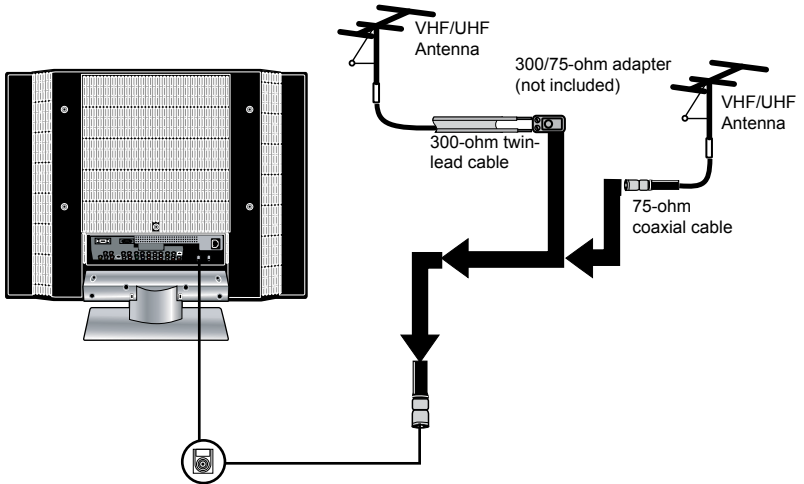

### B. Separate VHF and/or UHF antennas

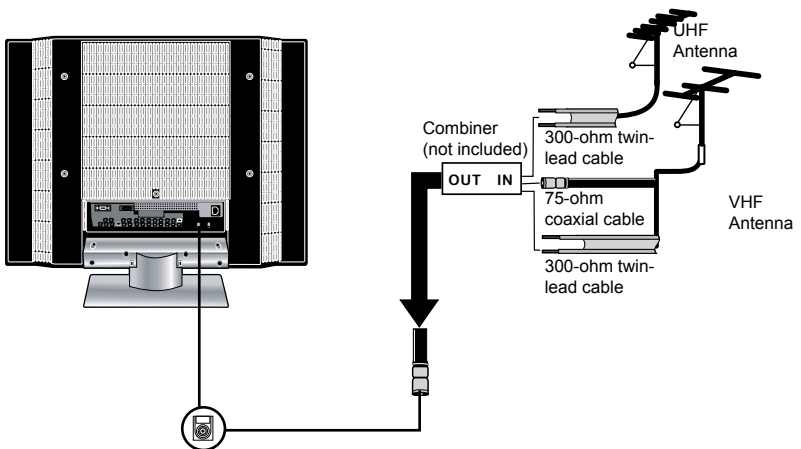



## Cable TV (CATV) Connection

This reminder is provided to call the CATV system installer's attention to Article 820-40 of the National Electrical Code (NEC) that provides guidelines for proper grounding and, in particular, specifies that the cable ground shall be connected to the grounding system of the building accurately, or as close to the point of cable entry as possible. Use of this TV for other than private viewing of programs broadcasted on UHF, VHF or transmitted by cable companies for the use of the general public may require authorization from the broadcast/cable company, and/or program owner.

- **A 75-ohm coaxial cable connector is built into the set for easy hookup. When connecting the 75-ohm coaxial cable to the set, connect the 75-ohm cable into the ANT. terminal.**
- **Some cable TV companies offer premium pay channels. Since the signals of these premium pay channels are scrambled, a cable TV converter/descrambler is generally provided to the subscriber by the cable TV company.**

This converter/descrambler is necessary for normal viewing of scrambled channels. (Set your TV to channel 3 or 4, typically one of these channels is used. If this is unknown, consult your cable TV company.)

For more specific instructions on installing cable TV, consult your cable TV company. One possible method of connecting the coverter/descrambler provided by your cable TV company is shown in the diagram below.

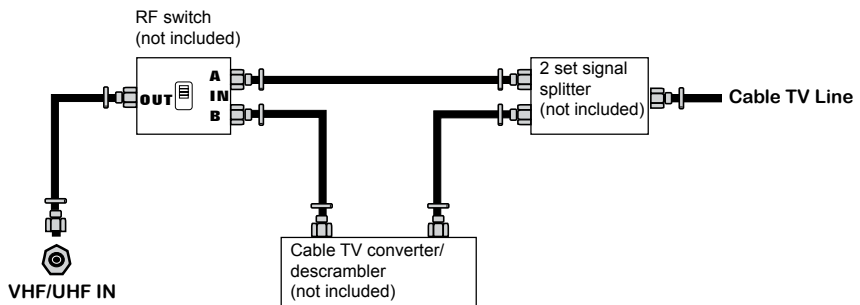

- **The RF switch (not included) is required to provide two inputs (A and B). Setting the RF switch to position A allows viewing of all unscrambled channels by using the TV channel keys.**
- **Setting the RF switch to position B allows viewing of all scrambled channels via the converter/descrambler by using the converter channel keys.**

1

**METHOD A:**

Use a supplied antenna cable to connect the NTSC signal to the LCD TV's TV CABLE terminal.

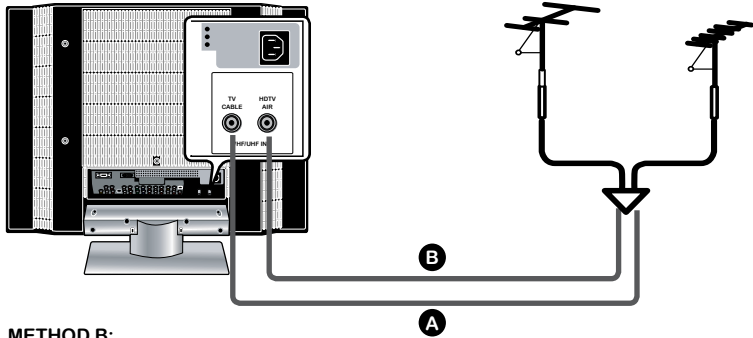
**METHOD B:**

Use a supplied antenna cable to connect the ATSC signal to the LCD TV's HDTV AIR terminal.

2

Connect the AC power cord at the back of the TV and connect the power cord to wall outlet.

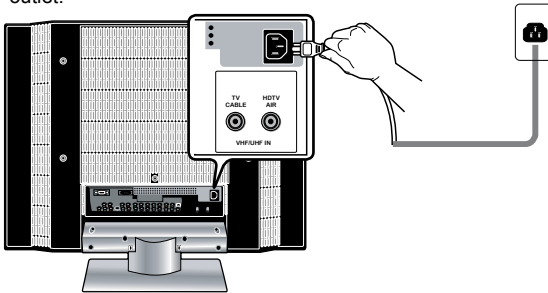



3

Press the  button on the remote to turn on the LCD TV.



Always disconnect the LCD TV from the main voltage when the LCD TV will not be used for a long period of time. The **POWER** button on the front panel is only used for switching the LCD TV into standby, it does not disconnect the device from the main voltage. To completely disconnect the main voltage, please remove the power plug from the socket.

4

Press the **Input** button on the remote to display the Input List. Use the   buttons to select **TV** (METHOD A), or **HDTV** (METHOD B), and press the **OK** button.

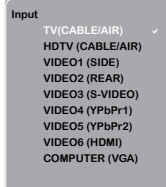

## Connecting a VCR

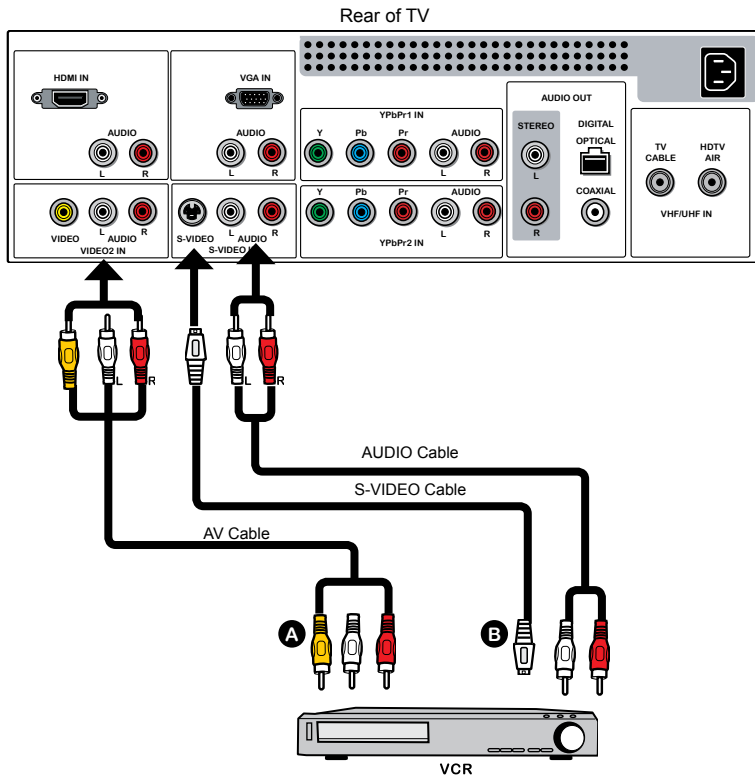

**1**

**METHOD A:**

Use a composite cable to connect the VCR's composite video/audio jacks to the LCD TV's VIDEO2 IN jacks.

**METHOD B:**

Use an audio cable to connect the VCR's audio output jacks to the LCD TV's audio inputs. Use a S-Video cable to connect the VCR's s-video output jack to the LCD TV's S-VIDEO IN input jack.

**2**

Connect all AC power sources, before turning on the power switch of the LCD TV or other connected equipment.

**3**

Press the button on the remote to turn on the LCD TV.

**4**

To watch a videotape, press the **Input** button on the remote to select **VIDEO2**( METHOD A), or **VIDEO3** (METHOD B).

## Connecting a Video Camera or Play Station

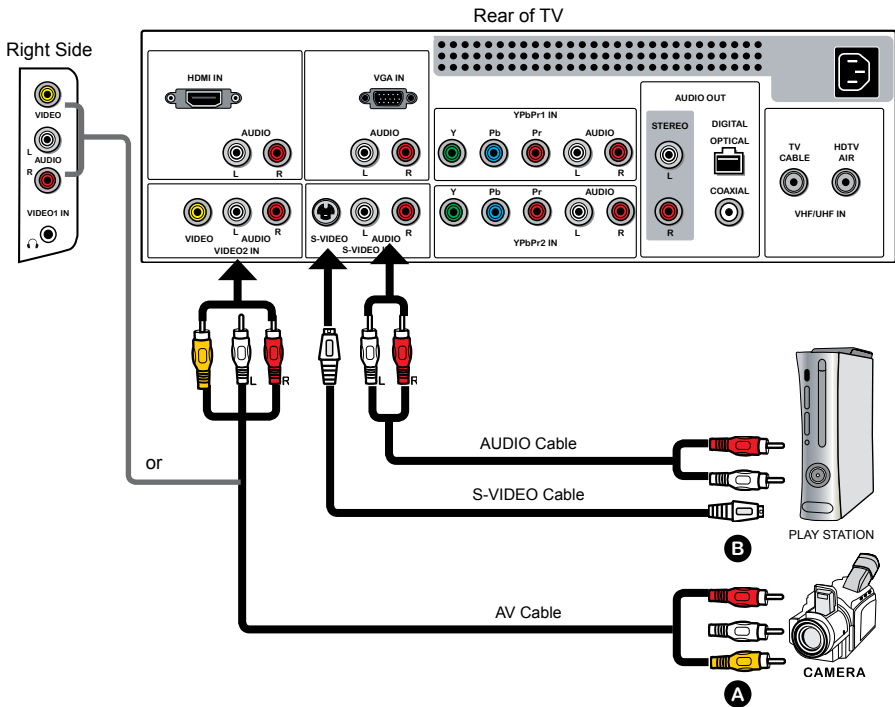

**1**

### METHOD A:

Use a composite cable to connect the video camera's or play station's composite video/ audio jacks to the LCD TV's VIDEO2 IN jacks or VIDEO1 IN jacks.

### METHOD B:

Use an audio cable to connect the video camera's or play station's audio output jacks to the LCD TV's audio inputs. Use a S-Video cable to connect the video camera's or play station's s-video output jack to the LCD TV's S-VIDEO IN input jack.

**2**

Connect all AC power sources, before turning on the power switch of the LCD TV or other connected equipment.

**3**

Press the  button on the remote to turn on the LCD TV.

**4**

To watch a video vis camera or play station, press the **Input** button on the remote to select **VIDEO2/VIDEO1**( METHOD A), or **VIDEO3** (METHOD B).



**Not all cameras have the ability to connect to a TV. Please check your video camera user guide for compatibility.**

## Connecting a DVD Player

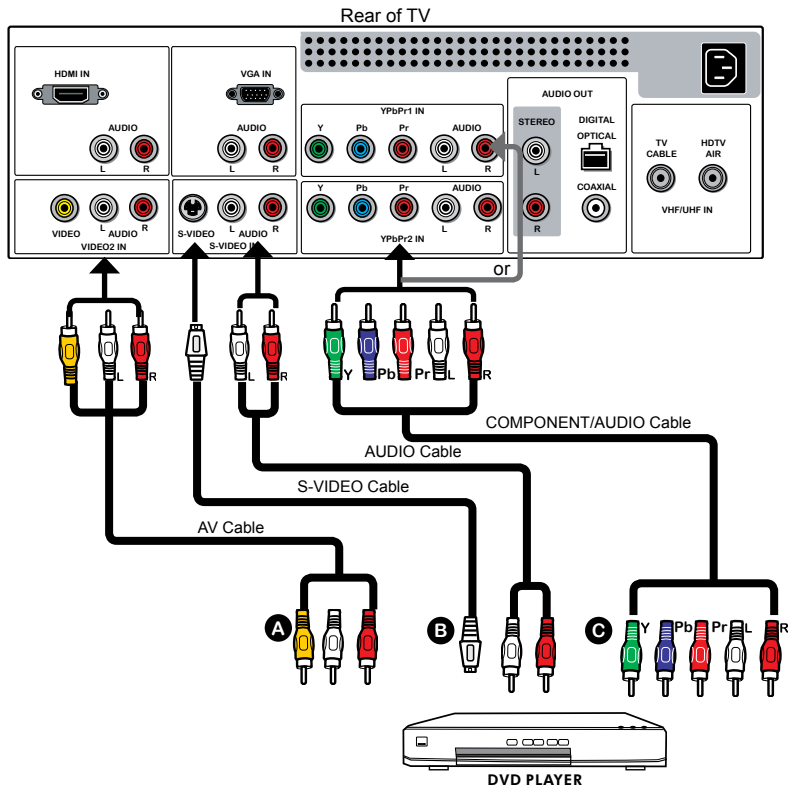

### 1

#### METHOD A:

Use a composite cable to connect the DVD player's composite video/audio jacks to the LCD TV's VIDEO2 IN jacks.

#### METHOD B:

Use an audio cable to connect the DVD player's audio output jacks to the LCD TV's audio inputs. Use a S-Video cable to connect the DVD player's s-video output jack to the LCD TV's S-VIDEO IN input jack.

#### METHOD C:

Use a component cable to connect the DVD player's component output jacks to the LCD TV's YPbPr1 IN or YPbPr2 IN input jacks. Use an audio cable to connect the DVD player's component audio jacks to the LCD TV's audio input jacks.



The component video jacks on your DVD player are sometimes labeled YPbPr, or YCbCr. For an explanation of component video, see your DVD player's user guide.

- 2 Connect all AC power sources, before turning on the power switch of the LCD TV or other connected equipment.
- 3 Press the  button on the remote to turn on the LCD TV.
- 4 To watch a DVD, press the **Input** button on the remote to select **VIDEO2** (METHOD A), or **VIDEO3** (METHOD B), or **VIDEO4/VIDEO5** (METHOD C).



For best picture quality, if your equipment has component video output, use a component cable instead of a composite video or S-video cable.

## Connecting a Digital TV Cable Box or Digital Satellite Receiver

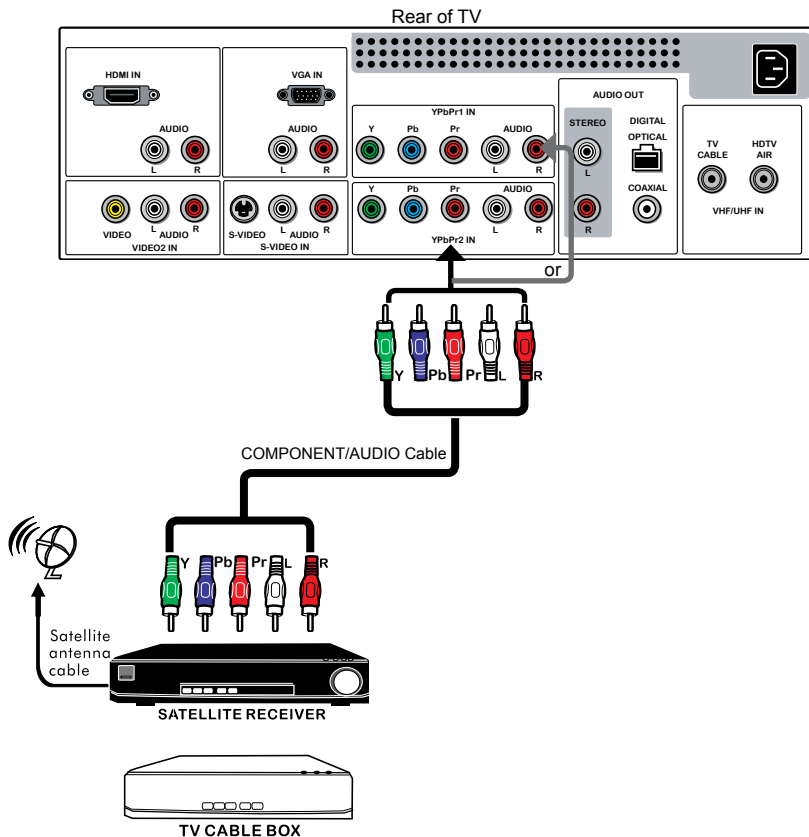

- 1** Use a component cable to connect the satellite receiver's/TV Cable Box's component (YPbPr1) output jacks to the LCD TV's component input jacks. Use an audio cable to connect the satellite receiver's/TV Cable Box's component audio jacks to the LCD TV's audio input jacks.
- 2** Connect all AC power sources, before turning on the power switch of the LCD TV or other connected equipment.
- 3** Press the  button on the remote to turn on the LCD TV.
- 4** To watch programs via satellite receiver or TV Cable Box, press the **Input** button on the remote to select **VIDEO4/VIDEO5**.

## Connecting an AV Equipment with HDMI Connector

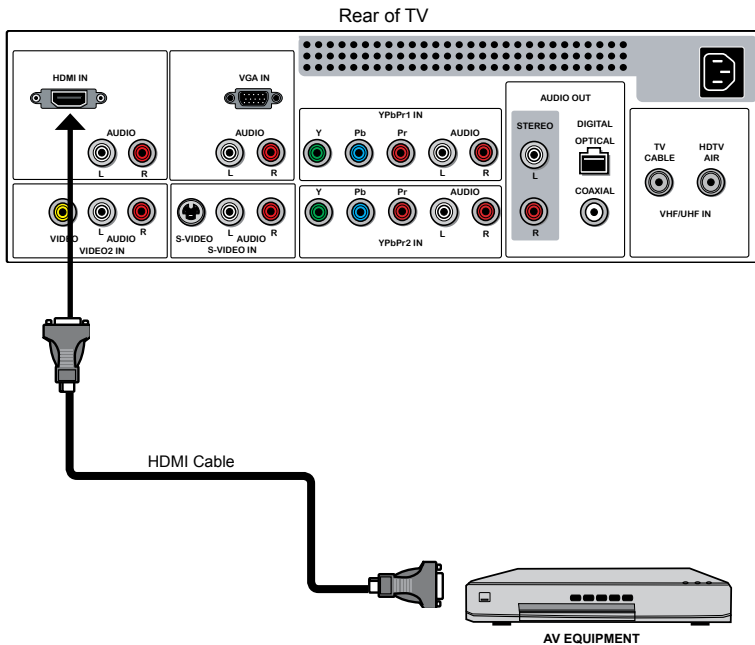

- 1 Use a HDMI cable to connect the AV equipment's HDMI output jack to the LCD TV's HDMI IN jacks.
- 2 Connect all AC power sources, before turning on the power switch of the LCD TV or other connected equipment.
- 3 Press the  button on the remote to turn on the LCD TV.
- 4 Press the **Input** button on the remote to select **VIDEO6**.



The HDMI connector provides both video and audio signals, it's not necessary to connect the audio cable.



## Connecting an AV Equipment with DVI Connector

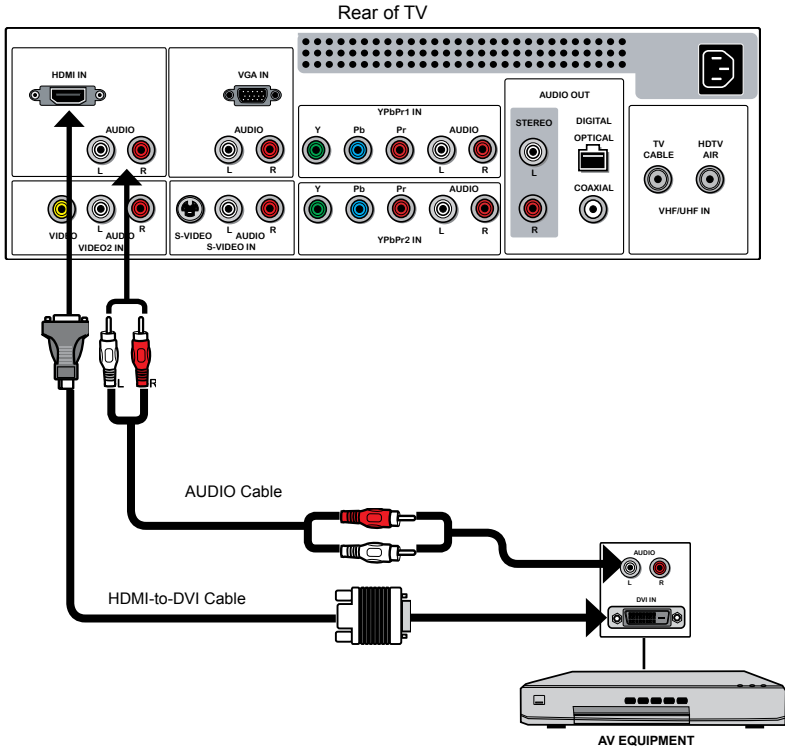



- 1** Use a HDMI-to-DVI cable to connect the AV equipment's DVI output jack to the LCD TV's HDMI IN jacks.  
Use an audio cable to connect the AV equipment's audio output jacks to LCD TV's HDMI AUDIO jacks.
- 2** Connect all AC power sources, before turning on the power switch of the LCD TV or other connected equipment.
- 3** Press the  button on the remote to turn on the LCD TV.
- 4** Press the **Input** button on the remote to select **VIDEO6**.

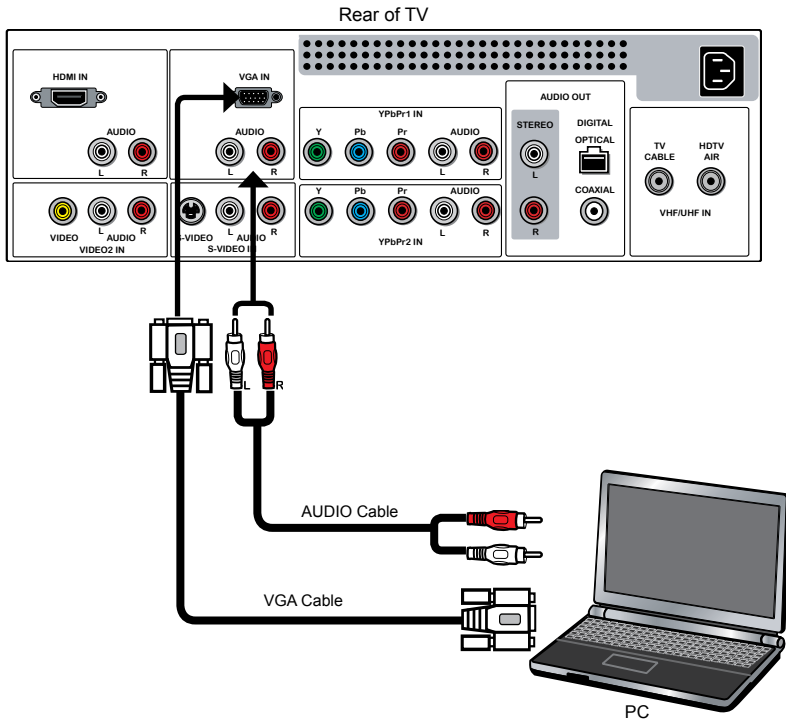

If the LCD TV is connected to AV equipment's DVI connector, you will need an HDMI-to-DVI cable or an HDMI adapter(not supplied).

## Connecting a PC



- 1 Use a D-SUB cable to connect the PC's D-SUB output jack to the LCD TV's VGA input jack. Use an audio cable to connect the PC's audio output jacks to LCD TV's.
- 2 Connect all AC power sources, before turning on the power switch of the LCD TV or other connected equipment.
- 3 Press the  button on the remote to turn on the LCD TV.
- 4 Press the **Input** button on the remote to select **COMPUTER**.

## Connecting an Audio Receiver or a Dolby Digital 5.1 Sound System

For better sound quality, you may want to play the LCD TV audio through your stereo system.

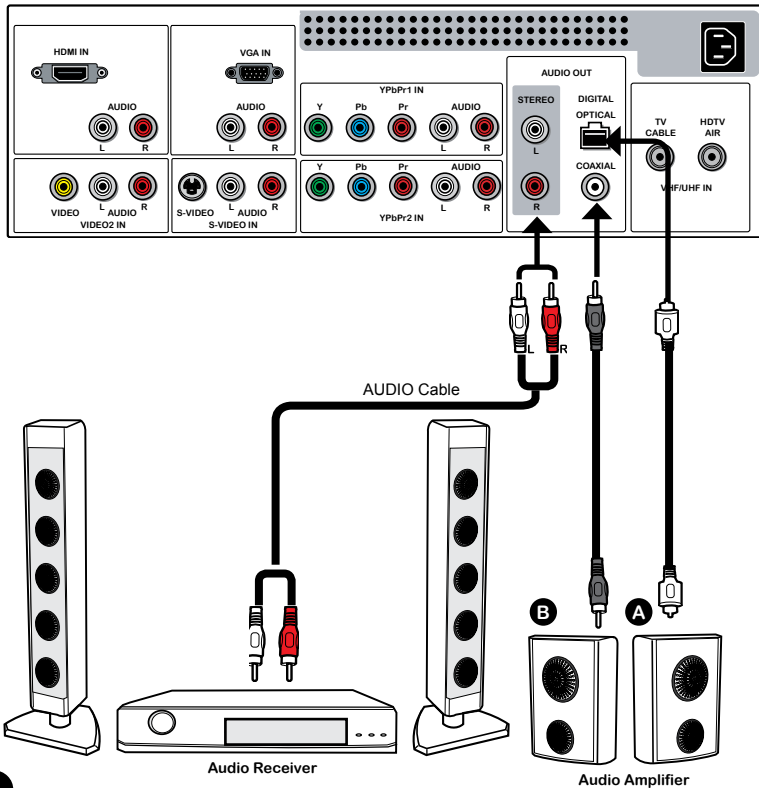

**1**

### Connecting to Audio Receiver:

Use an audio cable to connect the audio receiver's audio LINE IN jacks to LCD TV's AUDIO OUT jacks.

**2**

### Connecting to Digital 5.1 Sound System:

#### METHOD A:

Use an optical cable to connect the audio amplifier's OPTICAL IN jacks to LCD TV's OPTICAL OUT jacks.

#### METHOD B:

Use a coaxial cable to connect the audio amplifier's COAXIAL IN jacks to LCD TV's COAXIAL OUT jacks.

Note: Above mentioned function is only available under HDTV (cable/air) mode.

**3**

Connect all AC power sources, before turning on the power switch of the LCD TV or other connected equipment.

**4**

Press the  button on the remote to turn on the LCD TV.

# Chapter 3

## USING THE FEATURES

### Using Picture-In-Picture

The PIP/POP feature allows simultaneous viewing of video from two sources (TV, VCR, DVD etc). Only one source's audio is played at a time; the user may select which source's audio is heard.

- 1 Press the **PIP** button once to enter picture in picture mode.

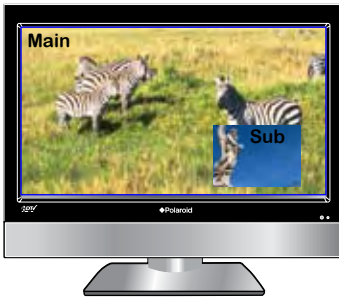

- Press ◀ ▶ to toggle the audio source between the main window and the sub window.
- Press the **OK** button to change the position of the second window.

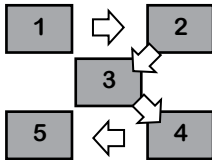

- Press ◀ ▶ to activate either the main or sub window, then press the **Input** button to display the Input List:

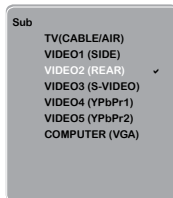

- Press ▲ ▼ to change input source and press the **OK** button.

- 2** Press the **PIP** button again to view images side by side.

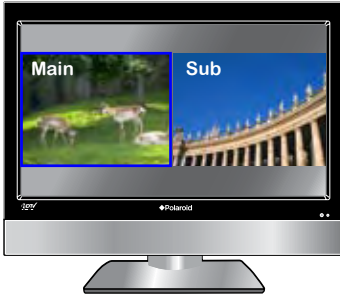

- Press ◀ ▶ to toggle the audio source between the main window and the sub window.
- Press the **OK** button to swap the pictures between the main and sub windows.



- Press ◀ ▶ to activate either the main or sub window, then press the **Input** button to display the Input List:

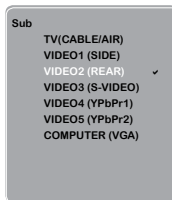

Press ▲ ▼ to change input source and press the **OK** button.

- 3** Press the **PIP** button again to exit.

## Wide Screen Viewing

Wide Screen function allows viewing of 4:3/16:9 images in wide screen mode, cycling through the following wide screen settings. Press the **ASPECT** button repeatedly to select the screen format you want.

**1****NORMAL**

Displays at 4:3 aspect ratio.

**2****FULL**

Stretches the image vertically and horizontally to keep the image size consistent in the center of the screen and stretches the sides

**3****WIDE**

Stretches the image vertically and horizontally to fill the screen at 1:1.85 aspect ratio.



**4****ZOOM**

Stretches the image vertically and horizontally to fill the screen at 1:2.35 aspect ratio.



## Operating the Menu

**1** Press the  button to turn the LCD TV on.

**2** Press the **MENU** button on the remote control, the on-screen menu will appear on the screen. Use the   buttons to select your main menu option.

### VIDEO MENU:

Allows you to make adjustments to your picture settings.

- If the signal source is VGA, the VIDEO MENU appears as:
- If the signal source is TV/HDTV/VIDOE/SVIDEO/YPbPr/HDMI, the VIDEO MENU appears as:

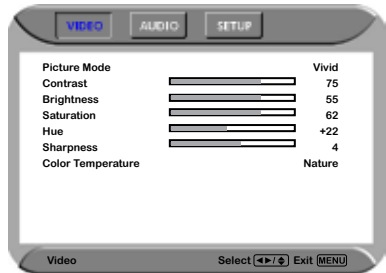
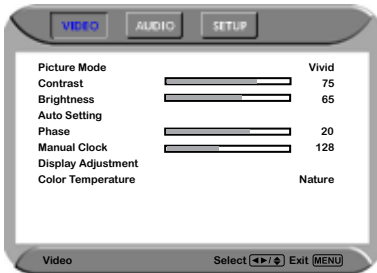

### AUDIO MENU:

Allows you to customize the audio options and effects.

- If the signal source is VIDEO/SVIDEO/YPbPr/HDMI/VGA, the AUDIO MENU appears as:
- If the signal source is TV, the AUDIO MENU appears as:

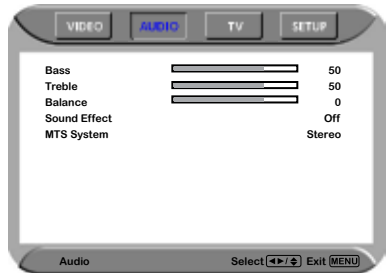
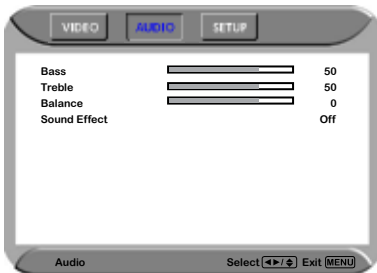

- If the signal source is HDTV, the AUDIO MENU appears as:

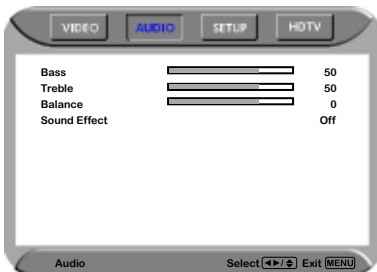

**SETUP MENU:**

Allows you to set up a variety of features: Language, Closed Caption, factory reset, V-Chip, Parental Control sleep timer.

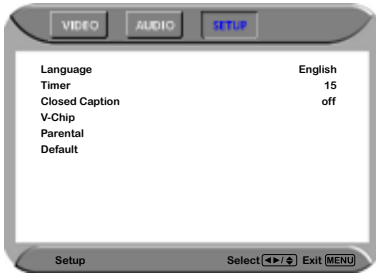
**TV MENU:**

Allows you to edit and label channels.

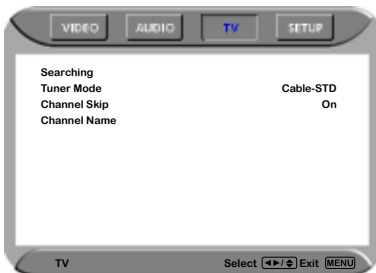
**HDTV MENU:**

Allows you to set up the HDTV program function.



- 3** Use the ▲ ▼ buttons to select an option of the sub-menu, and press the OK button. While in adjustment mode, and use the ◀ ▶ buttons to change the value of the item.
- 4** Press the MENU button to exit the menu.



## Setting up the HDTV Function

Automatically scans and stores all the TV channels

- 1 With the LCD TV connected to a television programming source, press the **TV** button on the remote control.
- 2 Press the **MENU** button on the remote control to display the Main menu, and use the **◀▶** buttons to select the **HDTV**.



- 3 Press the **▼** button to select **Auto Scan**, and press the **OK** button. The **Auto Scan** automatically creates a list of receivable channels. Press the **MENU** button at any time to interrupt the memorization process. (the list cannot be created if interrupted)

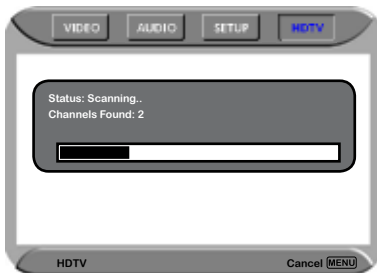

- 4 Press the **OK** button to display the received channel list, then press **▲▼** the buttons to select a channel. Or, use the **\*** (**Input** button) with **0-9** buttons to select digital channel( for example 9.1)

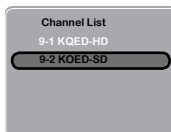

The digital main channel might include many subchannels (for example 9-1, 9-2..) that are showing program at the same time.

## 5

The **HDTV** menu includes the following options:

<b>Audio Language</b>	Allows to select the audio language: English/Spanish/French.
<b>Time Zone</b>	Allows selection of regional TV systems of USA: Eastern Time/Indiana/Central time/Mountain Time/Arizona/Pacific Time/Alaska/Hawaii
<b>SPDIF Type</b>	Allows to selection of the digital sound format: PCM/OFF/Dolby Digital
<b>Auto Scan</b>	Automatically sets up channel list on TV for all receivable channels.
<b>Manual Scan</b>	Allows to set up TV channel manually.
<b>Channel Skip</b>	Allows addition/removal of digital channels.
<b>Channel Block</b>	Allows to block digital channels. Use the <b>Channel Block</b> function, must enter a four-digit password. The factory password is 0000.

**Caption** Allows to set closed caption:

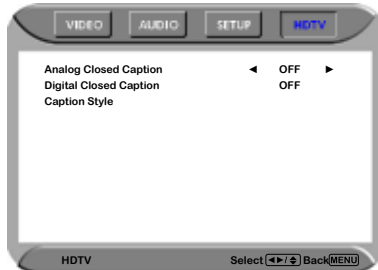

- **Analog Closed Caption:**  
Allows to set basic analog closed caption options: OFF/CC1/CC2/CC3/CC4
- **Digital Closed Caption:**  
Allows to set digital closed caption options: Service1/Service2/Service3/Service4/Service5/Service6/OFF
- **Caption Style:**  
Allows to customize the settings for digital closed caption option:



Using the Program Guide

The Program Guide feature brings all sorts of information provided by the cable TV company to your screen, such as program title, program duration, time remaining, rating information, closed caption, availability, etc.

**1** With the LCD TV connected to a television programming source, press the **TV** button on the remote control.

**2** Press the **GUIDE** button on the remote control, the Program Guide will appear on the screen:

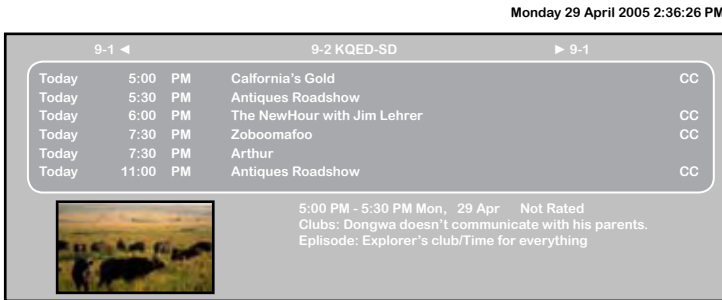

9 - 2 KOED-SD

**3** Press the **▲▼** button to select the program from a list, the Program Guide provides introduction about the current program being shown on each channel.

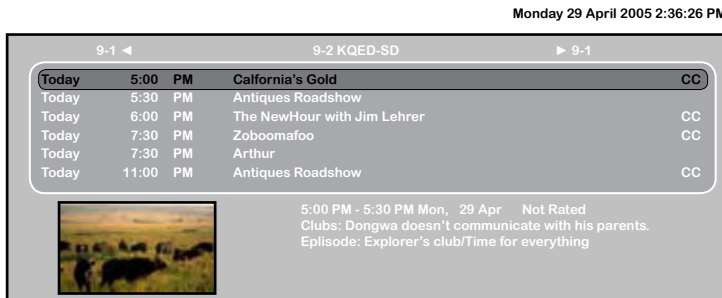

9 - 2 KOED-SD

**4** Press the **GUIDE** button again on the remote control to exit the Program Guide

## Customizing the VIDEO Settings

- 1 Press the **⏻** button to turn the LCD TV on.
- 2 Press the **MENU** button on the remote control to display the Main menu, and use the **◀▶** buttons to select the **VIDEO**.
- 3 Use the **▲▼** buttons to highlight an individual VIDEO option, use the **◀▶** buttons to change the setting, and press the **MENU** to exit the menu

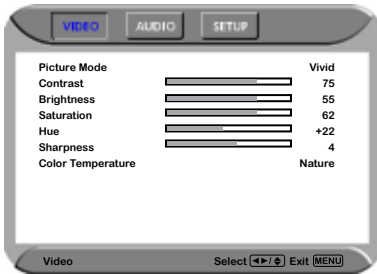

- 4 The **VIDEO** menu includes the following options:

<b>Picture Mode</b>	Cycles among display types: Vivid/Hi-Bright/Cinema/Sport/User
<b>Contrast</b>	Controls the difference between the brightest and darkest regions of the picture.
<b>Brightness</b>	Controls the overall brightness of the picture.
<b>Saturation</b>	Controls the color intensity.
<b>Hue</b>	Controls the difference between the green and red regions of the picture.
<b>Sharpness</b>	Increase this setting to see crisp edges in the picture; decrease it for soft edges.
<b>Color temperature</b>	Adjusts color components independently to achieve a warm or cool effect: Cool/Middle/Warm/User <ul style="list-style-type: none"> <li>▪ <b>Warm:</b> Increases red tint</li> <li>▪ <b>Nature:</b> Increases natural tint</li> <li>▪ <b>Cool:</b> Increases blue tint</li> <li>▪ <b>User:</b> Allows the user to adjust red, green and blue color component levels independently.</li> </ul>

## Customizing the AUDIO Settings

- 1 Press the **⏻** button to turn the LCD TV on.
- 2 Press the **MENU** button on the remote control to display the Main menu, and use the **◀▶** buttons to select the **AUDIO**.
- 3 Use the **▲▼** buttons to highlight an individual AUDIO option, use the **◀▶** buttons to change the setting, and press the **MENU** to exit the menu

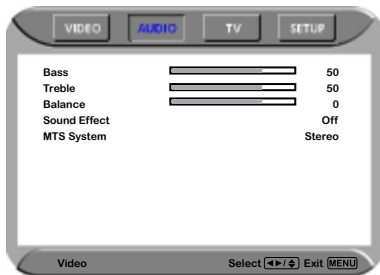

- 4 The **AUDIO** menu includes the following options:

<b>Bass</b>	Controls the relative intensity of lower-pitched sounds.
.....	
<b>Treble</b>	Controls the relative intensity of higher pitched sounds.
.....	
<b>Balance</b>	Adjusts the relative volume of the speakers in a multiple speaker system.
.....	
<b>Sound Effect</b>	Allows selection of an audio-enhancement technique from among the following options: Surround/Live/Dance/Techno/Classic/Soft/Rock/POP/Off.
.....	
<b>MTS System</b>	Allows you to listen to high-fidelity stereo sound while watching TV. <ul style="list-style-type: none"> <li>▪ <b>Stereo:</b> Use separate audio tracks for left and right speakers, if available.</li> <li>▪ <b>SAP:</b> You can enjoy a second audio program from the speakers while watching a scene in the original program.</li> <li>▪ <b>Mono:</b> Allows mono output (useful when stereo is noisy or inconsistent).</li> </ul>
.....	

## Customizing the SETUP Settings

- 1 Press the **⏻** button to turn the LCD TV on.
- 2 Press the **MENU** button on the remote control to display the Main menu, and use the **◀▶** buttons to select the **SETUP**.
- 3 Use the **▲▼** buttons to highlight an individual SETUP option, use the **◀▶** buttons to change the setting, and press the **MENU** to exit the menu.

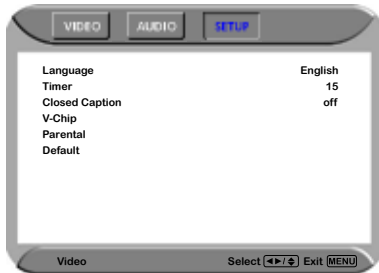

- 4 The **SETUP** menu includes the following options:

### Language

Selects to display all on-screen menus in your language of choice: English/Tradition Chinese/Simplified Chinese/French/Spanish.

### Timer

Allows to set up clock and to program the TV to turn on and off and tune to a specific channel.

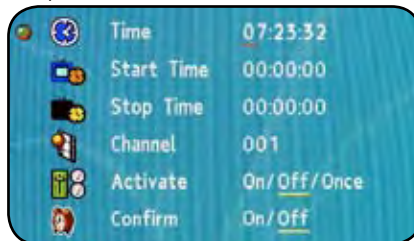

- **Time:**  
Selects to set the current time by hour, minute, second.
- **Start Time:**  
Selects to set the time that you want the TV to turn on.
- **Stop Time:**  
Selects to set the time that you want the TV to turn off.
- **Channel:**  
Selects to set the specific channel that you want the TV to tune.
- **Activate:**  
Selects to turn on/off/once the timer.
- **Confirm:**  
Selects to confirm.

**Closed Caption**

Allows to select from 4 closed caption modes:

- **CC1 /CC2 /CC3 /CC4:**  
Display a printed version of the dialog and sound effects of the program being viewed.
- **T1/T2:**  
Display station information presented using either half or the whole screen.
- **T3/T4:**  
Extended Data Services. For example: Network name, program name, program length, etc.

---

**V-Chip**

Allows to setup the TV and MPA Rating Lock options(refer to “Using the V-CHIP Setting”).

---

**Parental**

Allows to setup the Parental Lock options.

---

**Default**

Restores factory settings.

---

## Using the V-CHIP Settings

The US has 2 rating system for viewing content: Movie blocking(MPAA) and TV Blocking. The TV Blocking conjuncts with the V-CHIP to help parents block inappropriate programs from their children.

The Movie blocking(MPAA) is used for original movies rated by the Motion Picture Association of America(MPAA) as broadcasted on cable TV and not edited for television.

The V-CHIP can also be set to block MPAA-rated movies.

- 1 Use the **▼** button to select the **V-Chip**, and press the **OK** to display the V-Chip menu.

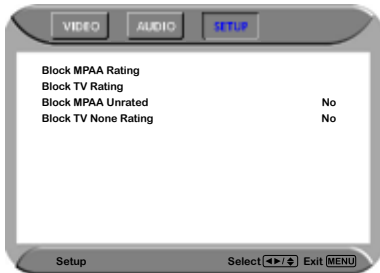

- 2 Use the **V-CHIP** function, must enter a four-digit password. The factory password is 0000.



- 3 The **MPAA** includes the following options:

RATING	DESCRIPTION
G	General Audiences. Movie is appropriate for all ages.
PG	Parental Guidance Suggested. May contain material not suited for younger viewers
PG-13	Contains content that may not be appropriate for viewers under the age of 13.
R	Restricted. Contains adult content, no one under 17 admitted without parent.
NC-17	No one 17 and under admitted.
X	No one 17 and under admitted.

Use the **▲▼** buttons to select the rating you want and press the **OK** button repeatedly to select **BLOCK(✓)** or **UNBLOCK(✗)**.



**4**

The **TV GUIDELINE** has 2 rating methods: Content-Based Rating and Age-Based Rating. The **TV GUIDELINE** includes the following options:

AGE-BASED		CONTENT-BASED	
RATING	DESCRIPTION	RATING	DESCRIPTION
TV-Y	All children	FV	Fantasy violence
TV-Y7	Directed to children age 7 and older	D	Suggestive dialogue
TV-G	General Audience	L	Strong language
TV-PG	Parental Guidance suggested	S	Sexual situations
TV-14	Parents strongly cautioned	V	Violence
TV-MA	Mature Audience only		

		CONTENT-BASED				
		FV	D	L	S	V
AGE-BASED	TV-Y					
	TV-Y7	✓				
	TV-G					
	TV-PG		✓	✓	✓	✓
	TV-14		✓	✓	✓	✓
	TV-MA			✓	✓	✓

✓ : To block programs by both content and age.

Use the ▲▼ buttons to select the rating you want and press the **OK** button repeatedly to select **BLOCK(✓)** or **UNBLOCK(x)**.

**5**

The **V-CHIP** menu includes the following options:

**Block MPAA Rating** Selects to activate the MPAA Rating programs

**Block TV Rating** Selects to activate the TV Rating programs.

**Block MPAA Unrated**

- YES: Block all movies that are broadcast without a MPAA rating.
- NO: Allows all movies that are broadcast without a MPAA rating

**Block TV None Rating**

- YES: Block all movies that are broadcast without a TV rating.
- NO: Allows all movies that are broadcast without a TV rating.

## Using the Parental Settings

The Parental blocking can be set up to the TV to block a Channel or a Video Source.

- 1 Use the **▼** button to select the **Parental**, and press the **OK** to display the Parental menu.



- 2 Use the **V-CHIP** function, must enter a four-digit password. The factory password is 0000.



**!** You need your password for any future access into the V-Chip and Parental Setting,

- 3 The **Parental** menu includes the following options:

---

**Channel Lock**      Selects to block a TV channel.

---

**Video Lock**      Selects to block a Input source signal.

---

**Change Password**      Selects to change your password.

---

## Customizing the TV Settings

- 1 Press the **⏻** button to turn the LCD TV on.
- 2 Press the **MENU** button on the remote control to display the Main menu, and use the **◀▶** buttons to select the **TV**.
- 3 Use the **▲▼** buttons to highlight an individual TV option, use the **◀▶** buttons changes the setting, and press the **MENU** exits the menu.

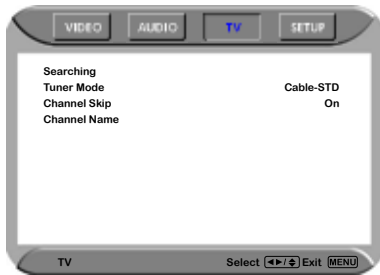

- 4 The **TV** menu includes the following options:

<b>Searching</b>	Automatically sets up channel list on TV for all receivable channels.
<b>Tuner Mode</b>	Allows selection between CATV cable and antenna signal sources: <ul style="list-style-type: none"> <li>▪ <b>ANTENNA</b> Choose this setting if you are receiving TV channels with an antenna cable.</li> <li>▪ <b>CABLE STD/CABLE IRC/CABLE HRC</b> Choose this setting if you are receiving TV channels with a CATV cable.</li> </ul>
<b>Channel Skip</b>	Allows addition/removal of channels on the channel list.
<b>Channel Name</b>	Allows channel labels to be edited.

# SPECIFICATIONS

MODEL		FLM-2632/FLM-263B	FLM-3232/FLM-323B
LCD Panel	Panel Size	26" TFT LCD	32" TFT LCD
	Brightness	550	500
	Contrast Ratio	1000:1	800:1
Max. Resolution		1366x768	1366x768
Input Connector	VIDEO/AUDIO(L/R)	2	2
	S-VIDEO/AUDIO(L/R)	1	1
	YPbPr/AUDIO(L/R)	2	2
	VGA/AUDIO(L/R)	1	1
	HDMI/AUDIO(L/R)	1	1
	AUDIO OUT(L/R)	1	1
	OPTICAL/COAXIAL	1	1
	HEADPHONE	1	1
Power Source		AC100~240V, 50/60HZ, 2.2A	AC100~240V, 50/60HZ, 2.2A
Power Consumption		180 W, standby < 5 W	180 W, standby < 5 W
Dimension		26.7 w x 22.1 h x 7.9 d inch	31.7 w x 25.0 h x 8.4 d inch
WEIGHT		31.97 LB	39.5 LB

MODEL		FLM-3732/FLM-373B
LCD Panel	Panel Size	37" TFT LCD
	Brightness	500
	Contrast Ratio	1000:1
Max. Resolution		1366x768
Input Connector	VIDEO/AUDIO(L/R)	2
	S-VIDEO/AUDIO(L/R)	1
	YPbPr/AUDIO(L/R)	2
	VGA/AUDIO(L/R)	1
	HDMI/AUDIO(L/R)	1
	AUDIO OUT(L/R)	1
	OPTICAL/COAXIAL	1
	HEADPHONE	1
Power Source		AC100~240V, 50/60HZ, 3.0A
Power Consumption		275 W, standby < 8 W
Dimension		36.6 w x 28.2 h x 9.4 d inch
WEIGHT		54 LB

# Chapter 4

## Programming your Remote Control

### Introduction

Your remote lets you control four devices with one easy-to-use, compact unit. After installing batteries, you can program the remote to control your Universal TV, VCR or DVD, Cable or Satellite Receivers, Amplifier or Tuner, and Auxiliary devices. To do so, follow the instructions in "Programming a Device". For best results, please read and follow all the remaining instructions. Keep this guide for future reference.

### A Quick Look at Programming a Device

To control VCR or DVD, Cable or Satellite Receivers, Amplifier or Tuner, and Auxiliary devices, follow these steps. Before proceeding, find the codes for the devices you want to program in "Manufacturer's Codes" on the right side of this page and write them down or highlight them.

**NOTE:** To program a DVD Player, TV/DVD Combo, TV/VCR/DVD Combo, portable DVD player, or mobile DVD player, use the **DVD** key.

1. Turn on the device (for example, DVD player) and, if needed, load media (for example, a DVD).
2. Press a device key (**VCR/DVD**, **CBL/ SAT**, or **AUX**).
3. Press and hold **SET** until the red LED blinks twice; then release.
4. Enter the first five-digit code for your device. The LED blinks once as each digit is entered. If the code is correct, the LED blinks twice.
  - **NOTE:** If the LED does not blink twice, repeat steps 2 to 4 and try entering the code again.
5. Aim the remote at the device and press **Power**. The device should turn off. If it does not, repeat steps 3–5, trying each code for your brand until you find one that works. If you cannot find a code that works, see "Searching for Your Code".
6. Repeat steps 1–5 for the other devices you want to control. For future reference, write down each working device code below:
  - AUX** Code:
  - CBL** Code:
  - CD** Code:
  - DVD** Code:
  - SAT** Code:
  - TNR** Code:
  - VCR** Code:
7. Press set to save and exit

### Searching for your Code

If your device does not respond to the remote after trying all codes listed for your brand, or if your brand is not listed, try searching for your code:

1. Press a device key once.
2. Press and hold **SET** until the red LED blinks twice; then release.
3. Enter **9-9-1**, then the device group number (0= Cable, 1= TV, 2= VCR, 3= Audio). The LED blinks twice.
4. Aim the remote at the device and press **Power**. The remote sends IR codes from its library to the selected device, starting with the most popular code first. If the device responds, go to step 7.
5. If the device does not respond, press **CH+**. The remote will try the next code. Continue until the device responds.
  - **Note:** Press **CH-** to try the previous code.
6. To search for other device codes, repeat steps 1 to 5.
7. Press **SET** to save and exit.

### Checking the Codes

If you have set up the remote using the procedure in "Searching for Your Code", you may need to find out which four-digit code is operating your equipment.

For example, to find out which code is assigned to your TV:

1. Press **TV** once.

2. Press and hold **SET** until the red LED blinks twice; then release.
3. Enter **9-9-0**. The LED blinks twice.
4. To view the code for the first digit, press **1**. Count the LED blinks (for example, three blinks = 3), and write down the number in the appropriate code listing in step 8 under "Programming a Device".
  - **NOTE:** If a code digit is **0**, the LED does not blink.
5. Repeat step 4 for the four remaining digits, using **2** for the second digit, **3** for the third digit, **4** for the fourth digit, and **5** for the fifth digit.
6. To check for other device codes, repeat steps 1—5, substituting the device key for **TV**.

## Changing Volume Lock

The remote comes preset to allow independent volume control of each selected device (Global Volume Unlock). However, you may change the Volume Lock setting to Global Volume Lock so that one device's volume will control volume in all other modes. After that, you can perform Individual Volume Unlock on a selected device to set its volume control for independent operation or Global Volume Unlock to remove all volume locking.

### Locking Volume Control to One Mode (Global Volume Lock)

1. Press and hold **SET** until the red LED blinks twice; then release.
2. Enter **9-9-3** and then press the mode key for the device you want to control volume (for example, **TV**). The LED blinks twice. Now when you press **VOL+**, **VOL-**, or **Mute**, the selected device (for example, **TV**) will control the volume regardless of the current mode.

### Unlocking All Volume Control (Restoring Global Unlock)

1. Press and hold **SET** until the red LED blinks twice; then release.
2. Enter **9-9-3** and then press **VOL+**. The LED blinks four times.

Volume is now independently controlled for all programmed devices.

### Unlocking a Single Device's Volume Control

1. Press a device key (**TV**, **VCR/DVD**, **CBL/ SAT**, or **AUX**).
2. Press and hold **SET** until the red LED blinks twice; then release.
3. Enter **9-9-3** and then press **VOL-**. The LED blinks four times.

Volume is now independently controlled for the selected devices.

## Troubleshooting

**PROBLEM:** LED does not blink when you press a key.

**SOLUTION:** Replace battery with one new 3.3 V 2032 Lithium battery.

**PROBLEM:** LED blinks when you press a key, but device does not respond.

**SOLUTION:** Make sure the remote is aimed at your device and is not more than 15 feet away.

**PROBLEM:** LED blinks one long blink.

**SOLUTION:** An entry error has occurred (for example, wrong key). Try entry sequence again.

**PROBLEM:** Remote does not control devices or commands are not working properly.

**SOLUTION:** Try all listed codes for the device. Make sure the device operates with an infrared remote control.

**PROBLEM:** **CH+**, **CH-**, and **LAST** do not work for your RCA TV.

**SOLUTION:** Due to RCA design from 1983 to 1987, only the original remote control will operate these functions.

**PROBLEM:** No volume on a device.

**SOLUTION:** See "Changing Volume Lock".

**PROBLEM:** Channels do not change properly.

**SOLUTION:** If the original remote control required you to press **Enter** to change channels, press **Enter** on this remote after entering the channel number.

## MANUFACTURER'S CODES

### Set Codes for Audio Amplifiers

Bose	30674
GE	30078
JVC	30331
Marantz	30321
Nakamichi	30321
NEC	30264
Optimus	30395
Realistic	30395
Sansui	30321
Shure	30264
Sony	30689
Soundesign	30078
Victor	30331
Wards	30078
Yamaha	30354, 30133

### Set Codes for Audio Amp/Tuners

ADC	30531
Aiwa	31405, 31243, 30121
Anam	31609, 31074
Audiotronic	31189
Bose	31229
Capetronic	30531
Carver	31189
Coby	31263
Denon	31360, 31142, 30904
Fonmix	31360
Glory Horse	31263
Harman/Kardon	30110
Hitachi	31273
Inkel	30027
Integra	30135
JBL	30110
JVC	30074, 31263
Kenwood	31313, 31570, 30027
KLH	31428
Magnavox	31189, 31269, 30531
Marantz	31189, 31269, 30039
MCS	30039
Onkyo	30842, 30135
Optimus	31023, 30670, 30531, 31074
Panasonic	31518, 30039
Philips	31189, 31269
Pioneer	31023, 30150, 30014, 30630, 30531
Proscan	31254
Qisheng	31609
Quasar	30039
RadioShack	31263
RCA	31023, 31609, 31254, 30531, 31074
Sharper Image	31263
Silsonic	30176
Sony	31258, 31759
Soundesign	30670
Stereophonics	31023
Sunfire	31313
Teac	31074, 31267
Technics	31308, 31518, 30039
Thorens	31189
Victor	30074
Wards	30014
Yamaha	30176, 31276, 31176



**Set Codes for Cable Converters**

ABC	00003, 00008, 00014
Americast	00899
Bell & Howell	00014
Bell South	00899
Clearmaster	00883
ClearMax	00883
Coolmax	00883
Daeryung	01877, 00877, 00477, 00008
Digi	00637
Director	00476
Dumont	00637
Gehua	00476
General Instrument	00476, 00810, 00276, 00003, 00014
GoldStar	00144
Hamlin	00009, 00273
Hitachi	00014
Jerrold	00476, 00810, 00276, 00003, 00012, 00014
KNC	00008
LG	00144
Memorex	00000
Motorola	00476, 00810, 00276, 01254, 01376
MultiVision	00012
Pace	01877, 00237
Panasonic	00000, 00008, 00107
Panther	00637
Paragon	00000
Philips	00317, 01305
Pioneer	01877, 00877, 00144, 00533
Pulsar	00000
Quasar	00000
RadioShack	00883
Regal	00279, 00273
Runco	00000
Samsung	00000, 00144
Scientific Atlanta	01877, 00877, 00477, 00008
Sony	01006
Starcom	00003, 00014
Supercable	00276
Supermax	00883
Tocom	00012
Torx	00003
Toshiba	00000
Trans PX	00276
Tristar	00883
TS	00003
V2	00883
Viewmaster	00883
Vision	00883
Vortex View	00883
Zenith	00000, 00525, 00899

**Set Codes for CD Players**

Aiwa	30157
Burmester	30420
California Audio Labs	30029
Carver	30157, 30179
Denon	30873
DKK	30000
DMX Electronics	30157
Dynamic Bass	30179
Fisher	30179
Garrard	30420
Genexxa	30032

Harman/Kardon	30157, 30173
Hitachi	30032
Integra	30101
JVC	30072
Kenwood	30826, 30626, 30028, 30037, 30036, 30190
Krell	30157
Linn	30157
Magnavox	30157
Marantz	30626, 30029, 30157
MCS	30029
Miro	30000
Mission	30157
MTC	30420
NSM	30157
Onkyo	30868, 30101
Optimus	31063, 30000, 30032, 30037, 30420, 30179, 31075, 30145
Panasonic	30029
Parasound	30420
Philips	30626, 30157
Pioneer	31063, 31062, 30032
Polk Audio	30157
Proton	30157
QED	30157
Quad	30157
Quasar	30029
RadioShack	31075
RCA	31062, 30032, 30420, 30179, 30053
Realistic	30420, 30179
Rotel	30157, 30420
SAE	30157
Sansui	30157
Sanyo	30179
SAST	30157
Sharp	30861, 30037
Silsonic	30888, 30036
Sonic Frontiers	30157
Sony	30490, 30000, 30100
Soundesign	30145
TAG McLaren	30157
Tascam	30420
Teac	30420
Technics	30029
Victor	30072
Wards	30157, 30053
Yamaha	30888, 30036
Zonda	30157

### Set Codes for DVD Players

Aiwa	20641, 21912
Akai	20770
Allegro	20869
Apex Digital	20672, 20717, 20797, 21061, 20796, 21056, 21937, 20794, 21020, 21915
Blaupunkt	20717
Blue Parade	20571
Broksonic	20695
Changhong	20627, 21061
CineVision	20869
Coby	21086
Curtis Mathes	21087
CyberHome	21024, 21023, 21129, 20816, 21117
Daewoo	20833, 21172, 20869
Denon	20490
DVD2000	20521

Emerson	20591, 20675
Enterprise	20591
Fisher	21919
Funai	20675
Gateway	21158, 21073
GE	20522, 20717
Go Video	20744, 20833, 21099, 20783, 21075, 20869, 21730
Greenhill	20717
Harman/Kardon	20582, 20702
Hitachi	20573, 20664, 21919
Hiteker	20672
Initial	20717
Integra	20627, 21924
JBL	20702
JVC	20558, 20623, 20867
Kenwood	20490, 20534
KLH	20717, 21020, 21149
Koss	20651, 21980
Lasonic	20798
LG	20591, 20869, 20801
Liquid Video	21980
Lite-On	21158, 21058
Loewe	20511
Magnavox	20503, 20539, 21976, 21914, 20675
Marantz	20539
Memorex	20695
Microsoft	20522
Mintek	20717
Mitsubishi	21521, 20521
Nesa	20717
Norcent	21003
Onkyo	20503, 20627, 21924, 20792
Oritron	20651, 21980
Panasonic	20490, 21762, 21990
Philips	20503, 20539, 20646, 21914
Pioneer	20525, 20571
Polaroid	21086, 21061
Polk Audio	20539
Portland	20770
Proscan	20522
Qwestar	20651
RCA	20522, 20571, 20717, 20822
Rio	20869
Rotel	20623
Sampo	20752, 20698
Samsung	20490, 20573, 21932, 21075, 20820
Sansui	20695
Sanyo	20695
Sharp	20630, 20752
Sharper Image	21117
Sherwood	20770
Shinco	20717
Shinsonic	20533
Sonic Blue	20869, 21099
Sony	20533, 20864, 21033, 21904, 21903
SVA	20717
Sylvania	20675
Symphonic	20675
Teac	20717, 21984, 20809
Technics	20490
Theta Digital	20571
Toshiba	20503, 20695
Urban Concepts	20503
Xbox	20522
Yamaha	20490, 20539, 20545
Zenith	20503, 20591, 20869

### Set Codes for Satellite Receivers

AlphaStar	00772
Chaparral	00216
Crossdigital	01109
DirecTV	00392, 00566, 00639, 01142, 00247, 00749, 01749, 00724, 00819, 01856, 01076, 01109, 00099, 01392,
	01640, 01442, 01414, 01108
Dish Network System	01005, 00775, 01505
Dishpro	01005, 00775, 01505
Echostar	01005, 00775, 01505
Expressvu	00775
GE	00566
General Instrument	00869
GOI	00775
Goodmans	01246
Hisense	01535
Hitachi	00819, 00222, 01250
HTS	00775
Hughes Network Systems	01142, 00749, 01749, 01442
I-Lo	01535
JVC	00775
LG	01414, 01226
Magnavox	00724, 00722
Memorex	00724
Mitsubishi	00749
Motorola	00869
NEC	01270
Next Level	00869
Panasonic	00247, 00701
Paysat	00724
Philips	01142, 00749, 01749, 00724, 01076, 00722, 00099, 01442
Proscan	00392, 00566
Proton	01535
RadioShack	00869
RCA	00392, 00566, 00855, 00143, 01392
Samsung	01276, 01109, 01108
Sanyo	01219
SKY	00856
Sony	00639, 01640
Star Choice	00869
Tivo	01142, 01442
Toshiba	00749, 01749, 00790, 01285
UltimateTV	01640, 01392
Uniden	00724, 00722
US Digital	01535
USDTV	01535
Voom	00869
Zenith	00856, 01856

### Set Codes for TVs

Addison	10092
Admiral	10093, 10463
Advent	10761, 10842
Aiko	10092
Aiwa	11914
Akai	10812, 10702, 10030, 10672, 11903
Albatron	10700, 10843
America Action	10180
Anam	10250, 10180, 10700
Anam National	10250, 10650
Anhua	10051
AOC	10451, 10093, 10180, 10060, 10030, 10178, 10092
Apex Digital	10748, 10765, 10879, 10767, 11943

Audiovox	10451, 10180, 10875, 10092, 10623
Baile	10661
Beijing	10812, 10661
Bell & Howell	10154
BenQ	11032
Bradford	10180
Broksonic	10236, 10463, 11911, 11938, 11905, 11935, 11929
Cailing	10748
Candle	10030
Carnivale	10030
Carver	10054
Celebrity	10000
Celera	10765
Changcheng	10051, 10661
Changhong	10156, 10765, 11156, 10767
Ching Tai	10092
Chun Yun	10000, 10180, 10700, 10092, 10843
Chung Hsin	10180, 10053
Cinema	10672
Citizen	10180
Commercial Solutions	11447, 10047
Conrowa	10156, 10145, 11156
Contec	10180
Craig	10180
Crosley	10054
Crown	10180
Curtis Mathes	10047, 10054, 10154, 10451, 10093, 10060, 10702, 10030, 10145, 10166
CXC	10180
Daewoo	10154, 10451, 10180, 10030, 10178, 10672, 11928, 10092, 10661, 11909, 10623, 10700
Dayu	10661
Dell	11080
Denon	10145
Dumont	10017
Durabrand	10463, 10180, 10178, 10171, 11034
Electroband	10000
Emerson	10154, 10236, 10463, 10180, 10178, 10171, 11944, 11909, 11929, 11905, 11928, 10623, 11911
Envision	10030
Ether	10030
Firststar	10236
Fisher	10154
Fortress	10093
Fujitsu	10809, 10853
Funai	10180, 10171, 11904
Furi	10145
Futuretech	10180
Gateway	11756, 11755
GE	11447, 10047, 11454, 10051, 10451, 10180, 10030, 10178, 11917, 10092, 11907, 11922
Gibraltar	10017, 10030
GoldStar	10154, 10030, 10178, 11926
Grunpy	10180
Haier	11034
Hallmark	10178
Hankook	10180, 10030, 10178
Harley Davidson	11904
Harman/Kardon	10054
Harvard	10180
Havermy	10093
Helios	10865
Hello Kitty	10451
Hisense	10156, 10748, 10145, 11156
Hitachi	10156, 10030, 10178, 11145, 10145, 10092, 11904, 11156
Hongmei	10093
Huafa	10145
Huari	10145
Huodateji	10051

Imperial Crown	10661
Infinity	10054
Inteq	10017
JBL	10054
JCB	10000
Jean	10156, 10051, 10236, 10092
Jensen	10761
Jiahua	10051
Jinfeng	10051
Jinxing	10054, 10156, 10145
JVC	10053, 11923, 11253
Kangli	10661
KEC	10180
Kenwood	10030
KLH	10765, 10767
Kolin	10180, 10150, 10053
KTV	10180, 10030
Kunlun	10051, 10661
LG	10060, 10030, 10178, 10856, 10700, 10025
Lloyd's	11904
LXI	10047, 10054, 10154, 10156, 10178
Magnasonic	11928, 11913
Magnavox	11454, 10054, 10030, 10706, 11931, 11254, 11913, 11904, 11944
Magnin	11907
Marantz	10054, 10030, 10704
Matsushita	10250, 10650
Maxent	11755
Megapower	10700
Megatron	10178, 10145
Memorex	10154, 10463, 10150, 10178, 11911, 11926, 11924, 11920, 11927
MGA	10150, 10030, 10178, 11907
Midland	10047, 10017, 10051
Mitsubishi	10154, 10250, 10093, 10236, 10180, 11250, 10150, 10030, 10178, 11917, 10836
Monivision	10843, 10700
Motorola	10093
MTC	10060, 10030
Mudan	10051
Multitech	10180
NAD	10156, 10178, 10866
National	10051
NEC	10154, 10156, 10051, 10053, 10030, 10178, 11704
Newave	10093, 10178, 10092
Nikko	10030, 10178, 10092
Norcent	10748, 10824
NTC	10092
Onwa	10180
Optimus	10154, 10250, 10166, 10650, 11927, 11924, 11913
Optonica	10093
Orion	10236, 10463, 11929, 11911, 11905
Panasonic	10054, 10250, 10051, 10650, 11941, 11927, 11924
Panda	10051, 10706
Penney	10047, 10156, 10051, 10060, 10030, 10178, 11926, 11907
Philco	10054, 10180, 10030, 10178
Philips	11454, 10054, 10000, 10051, 10030, 10178, 10092, 10690
Pilot	10030
Pioneer	10166, 10866, 10679
Portland	10092
Prima	10761
Princeton	10700
Prism	10051
Proscan	11447, 10047, 11922
Proton	10030, 10178
Pulsar	10017
Qingdao	10051
Quasar	10250, 10051, 11924, 10650
RadioShack	10047, 10154, 10180, 10030, 10178, 11920, 11904

RCA	11447, 10047, 11454, 10000, 10030, 10178, 11547, 11922, 11917, 10092, 11907, 11948,
10090, 10679	
Realistic	10154, 10180, 10030, 10178
Rowa	10748
Runco	10017, 10030
Sampo	10154, 10093, 10030, 10178, 10171, 10700, 10650, 11755, 10092
Samsung	10154, 10156, 10060, 10812, 10702, 10030, 10178, 11060, 10814, 10092, 11903, 10090,
10766	
Sansui	10463, 11904, 11935, 11929, 11911
Sanyo	10154, 10156, 10180, 10145, 11907
Sanyuan	10093
Scotch	10178
Scott	10236, 10180, 10178
Sears	10047, 10054, 10154, 10156, 10178, 10171, 11926, 11904
Shaofeng	10145
Sharp	10093, 10030, 10650, 11917
Shen Ying	10092
Shencai	10145
Sheng Chia	10093, 10236
Skygiant	10180
Skyworth	10748
Sony	11100, 10000, 10650, 11925, 11904
Soundesign	10180, 10178
Sowa	10156, 10051, 10060, 10178, 10092
Squareview	10171
SSS	10180
Starlite	10180
Studio Experience	10843
Supreme	10000
SVA	10748, 10865
Sylvania	10054, 10030, 10171, 11944, 11931
Symphonic	10180, 10171, 11913, 11904
Synco	10000, 10451, 10093, 10060, 10178, 10092
Tacico	10178, 10092
Tandy	10093
Tashiko	10092, 10650
Tatung	10054, 10154, 10156, 10051, 10060, 11156, 11756, 11254
Technics	10250, 10051
Techwood	10051
Teco	10051, 10093, 10178, 10092
Teknika	10054, 10180, 10150, 10060, 10092
Telefunken	10702
Tera	10030
Thomas	11904
Tiane	10093
TMK	10178
TNCi	10017
Tobo	10748
Toshiba	10154, 10156, 10060, 10145, 11945, 11704, 11936, 11156, 11935, 10650, 11918
Tuntex	10030, 10092
TVS	10463
V Inc.	11756, 10885, 10864
Vector Research	10030
Victor	10250, 10053, 10650
Vidikron	10054
Vidtech	10178
Viewsonic	11755, 10885, 10864
Wards	10054, 10030, 10178, 10866, 11156
Warumaia	10661
Waycon	10156
White Westinghouse	10463, 11909, 10623
Yamaha	10030
Yapshe	10250
Zenith	10017, 10463, 10178, 11904, 11929, 11911, 11909, 10092

### Set Codes for VCRs

ABS	21972
Admiral	20048, 20209
Aiko	20278
Aiwa	20037, 20479
Alienware	21972
America Action	20278
American High	20035
Amoisonic	20479
Anam	20162, 20037, 20240, 20278
Anam National	20162
Asha	20240
Audiovox	20037, 20278
Beaumarck	20240
Bell & Howell	20104
Broksonic	20184, 20121, 20209, 20002, 20479
Calix	20037
Canon	20035
Carver	20081
CCE	20072, 20278
Changhong	20048, 20081
Citizen	20037, 20278
Colt	20072
Craig	20037, 20047, 20240, 20072
Curtis Mathes	20060, 20035, 20162
Cybernex	20240
CyberPower	21972
Daewoo	20045, 20104, 20278
Dell	21972
Denon	20042
DirecTV	20739
Durabrand	20039, 20038
Electrohome	20037
Electroponic	20037
Emerex	20032
Emerson	20035, 20037, 20184, 20240, 20045, 20121, 20043, 20209, 20002, 20278, 20479
Fisher	20047, 20104
Fuji	20035, 20033
Fujitsu	20045
Gateway	21972
GE	20060, 20035, 20240
General	20045
Go Video	20432
GoldStar	20037, 20209, 20038, 20225
Haojie	20240
Harman/Kardon	20081, 20038
Harwood	20072
Hewlett Packard	21972
HI-Q	20047
Hitachi	20037, 20042, 20055
Howard Computers	21972
HP	21972
Hughes Network Systems	20042, 20739
iBUYPOWER	21972
JVC	20045, 20067
KEC	20037, 20278
Kenwood	20067, 20038
KLH	20072
Kodak	20035, 20037
Kolin	20043
LG	20037, 20045, 20042, 20209, 20038
Logik	20072
LXI	20037
Magnavox	20035, 20039, 20081
Magnin	20240
Marantz	20035, 20081
Marta	20037



Matsushita	20035, 20162
Media Center PC	21972
MEI	20035
Memorex	20035, 20162, 20037, 20048, 20039, 20047, 20240, 20104, 20209, 20479
MGA	20240, 20043
MGN Technology	20240
Microsoft	21972
Mind	21972
Minolta	20042
Mitsubishi	20067, 20043
Motorola	20035, 20048
MTC	20240
Multitech	20072
NEC	20035, 20037, 20048, 20104, 20067, 20038
Newave	20037
Nikko	20037
Noblex	20240
Northgate	21972
Olympus	20035
Optimus	21062, 20162, 20037, 20048, 20104, 20432
Orion	20184, 20209, 20002, 20479
Panasonic	21062, 20035, 20162, 20616, 20225
Penney	20035, 20037, 20240, 20042, 20038
Pentax	20042
Philco	20035, 20479
Philips	20035, 20081, 20739, 20618
Pilot	20037
Pioneer	20042, 20067
Polk Audio	20081
Profitronic	20240
Proscan	20060
Protec	20072
Pulsar	20039
Qisheng	20060
Quasar	20035, 20162
Radix	20037
Randex	20037
RCA	20060, 20035, 20240, 20042, 20880
Realistic	20035, 20037, 20048, 20047, 20104
ReplayTV	20616
Runco	20039
Sampo	20037, 20048
Samsung	20240, 20045, 20432
Sanky	20048, 20039
Sansui	20067, 20209, 20479
Sanyo	20047, 20240, 20104
Scott	20184, 20045, 20121, 20043
Sears	20035, 20037, 20047, 20042, 20104
Sharp	20048, 20209
Shintom	20072
Shogun	20240
Singer	20072
Sonic Blue	20616
Sony	20035, 20032, 20033, 20636, 21972
STS	20042
Sylvania	20035, 20081, 20043
Systemax	21972
Tagar Systems	21972
Tashiko	20037
Tatung	20045, 20067
Technics	20035, 20162
Teco	20035, 20037, 20048, 20038
Teknika	20035, 20037
Tivo	20636, 20618, 21503, 20739
TMK	20240
Toshiba	20045, 20042, 20067, 20043, 21503, 21008, 21972

Totevision	20037, 20240
Touch	21972
Unitech	20240
Vector	20045
Vector Research	20038
Victor	20067
Video Concepts	20045
Videomagic	20037
Videosonic	20240
Viewsonic	21972
Wards	20060, 20035, 20048, 20047, 20081, 20240, 20042, 20072
White Westinghouse	20209, 20072
XR-1000	20035, 20072
Yamaha	20038
Zenith	20039, 20033, 20209, 20479
ZT Group	21972

## CARE

- Keep the remote dry. If it gets wet, wipe it dry immediately.
- Use and store the unit only in normal temperature environments.
- Handle the remote gently and carefully. Don't drop it.
- Wipe the remote with a damp cloth to keep it looking like new.

For service, support and warranty information, visit [www.polaroid.com](http://www.polaroid.com) or in the US call 1-866-289-5168, in Canada call 1-866-301-7922 and in Mexico call 01-800-400-2443.

"Polaroid" and "Polaroid and Pixel" are trademarks of Polaroid Corporation, Waltham, MA, USA.

