

USER'S MANUAL (1/2)

(Specification and Part Names)

WIDE PLASMA DISPLAY

P63XHA30W/P63XHA30A/
 P55XHA30W/P55XHA30A/
 P50XHA30W/P50XHA30A/
 P42HHA30W/P42HHA30A/
 P42VHA30W/P42VHA30A/
 P42VHA31W/P42VHA31A

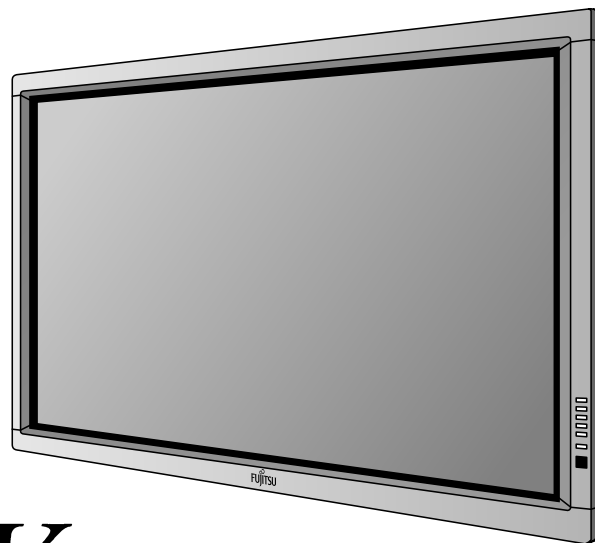

Plasmavision™ W

Contents

	Page	
• Accessories	E-2	Before Use
• Part Names and Functions	E-3–E-5	• Safety Precautions
• Installation	E-6	User's manual (2/2)
• Options	E-7	Usage
• Main Supported Signals	E-8	• Handy Tips
• Specification	E-9–E-12	User's manual (2/2)
		• Connecting the Display to External Equipment
		User's manual (2/2)
		• Using the Remote Control ...
		User's manual (2/2)
		• Basic Operations
		User's manual (2/2)
		• Selecting Input Mode
		User's manual (2/2)
		• Other Basic Operations
		User's manual (2/2)
		• Watching Pictures on the Wide Screen
		User's manual (2/2)
		Adjustments
		• Adjustment Menu
		User's manual (2/2)
		• Adjusting Pictures (PICTURE Menu)
		User's manual (2/2)
		• Adjusting Screen Position and Size (POSITION/SIZE Menu)
		User's manual (2/2)
		• Adjusting Audio (AUDIO Menu)
		User's manual (2/2)
		• Other Adjustments (FEATURES Menu)
		User's manual (2/2)
		• Initialization of User Adjustment Value (FACTORY DEFAULT)
		User's manual (2/2)
		• Cleaning and Maintenance ...
		User's manual (2/2)

Before using the display, read the User's manual (1/2) and the User's manual (2/2) carefully so that you know how to use the display correctly.

Refer to these manuals whenever questions or problems about operation arise. Be sure to read and observe the safety precautions.

Keep these manuals where the user can access them readily.

** Installation and removal require special expertise. Consult your product dealer for details.*

ACCESSORIES

CHECKING ACCESSORIES

One remote control Two AA batteries Two user's manuals One power cable

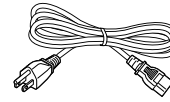
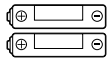

(W Type)

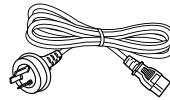

(A Type)

Two big ferrite cores



Two small ferrite cores

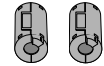

CONNECTING THE DISPLAY TO EXTERNAL EQUIPMENT

Carefully check the terminals for position and type before making any connections.

Loose connectors can result in picture or color problems. Make sure that all connectors are securely inserted into their terminals.

Ferrite cores

These ferrite cores are used to attenuate undesired signals.

Two big ferrite cores

When connecting a cable to the power input terminal, RS-232C terminal, attach one of these ferrite cores to the cable near the terminal.

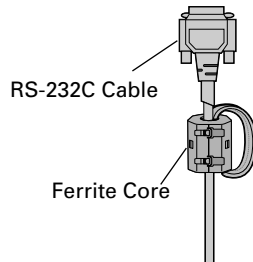
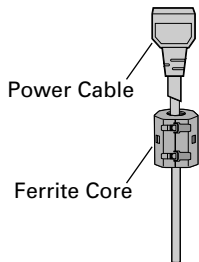

Two small ferrite cores

When connecting a cable to the external speaker output terminal attach one of these ferrite cores to the cable near the terminal.

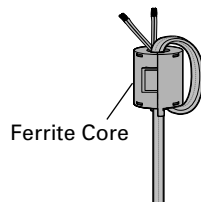
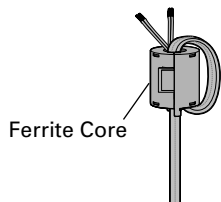

PART NAMES AND FUNCTIONS

DISPLAY SECTION – FRONT

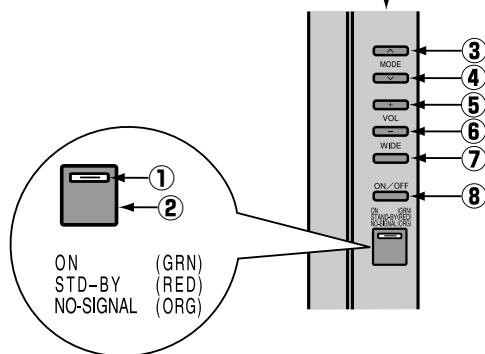
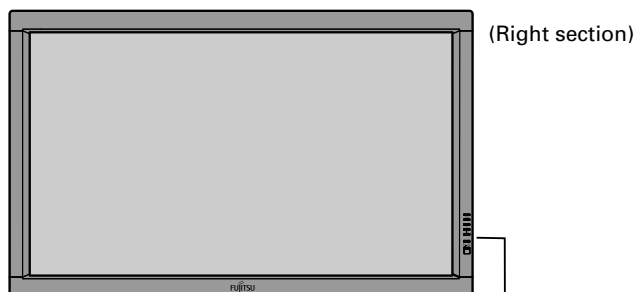

Control Panel (Right side of display)

① Power indicator lamp

This lamp shows the state of the power supply.

- | | |
|--------------------------|--|
| Lit (red): | Stand-by |
| Lit (green): | Power ON |
| Lit (orange): | Power saving (DPMS: Power saving function) mode ON.
(Please refer to E-30 of the User's Manual(2/2).) |
| Flashing (red or green): | Malfunction (Flashes differently depending on the type of malfunction.) |

② Remote control signal receiver

Receives signals from the remote control.

③ Input mode selector button ▲ [MODE]

④ Input mode selector button ▼ [MODE]

Switches between picture input modes.

⑤ VOL + button

⑥ VOL - button

Adjusts the audio volume.

⑦ Wide screen selector button [WIDE]

Switches the screen over to a desired wide screen.

⑧ ON/OFF button

Turns the power "ON" and "OFF (standby state)".

Warning

If the power indicator lamp flashes red or green, this signifies that the display has developed a problem. When this happens, be sure to remove the power plug from the receptacle and contact your dealer. Leaving the display power ON can result in fire or electric shock.

PART NAMES AND FUNCTIONS (Continued)

Back and bottom

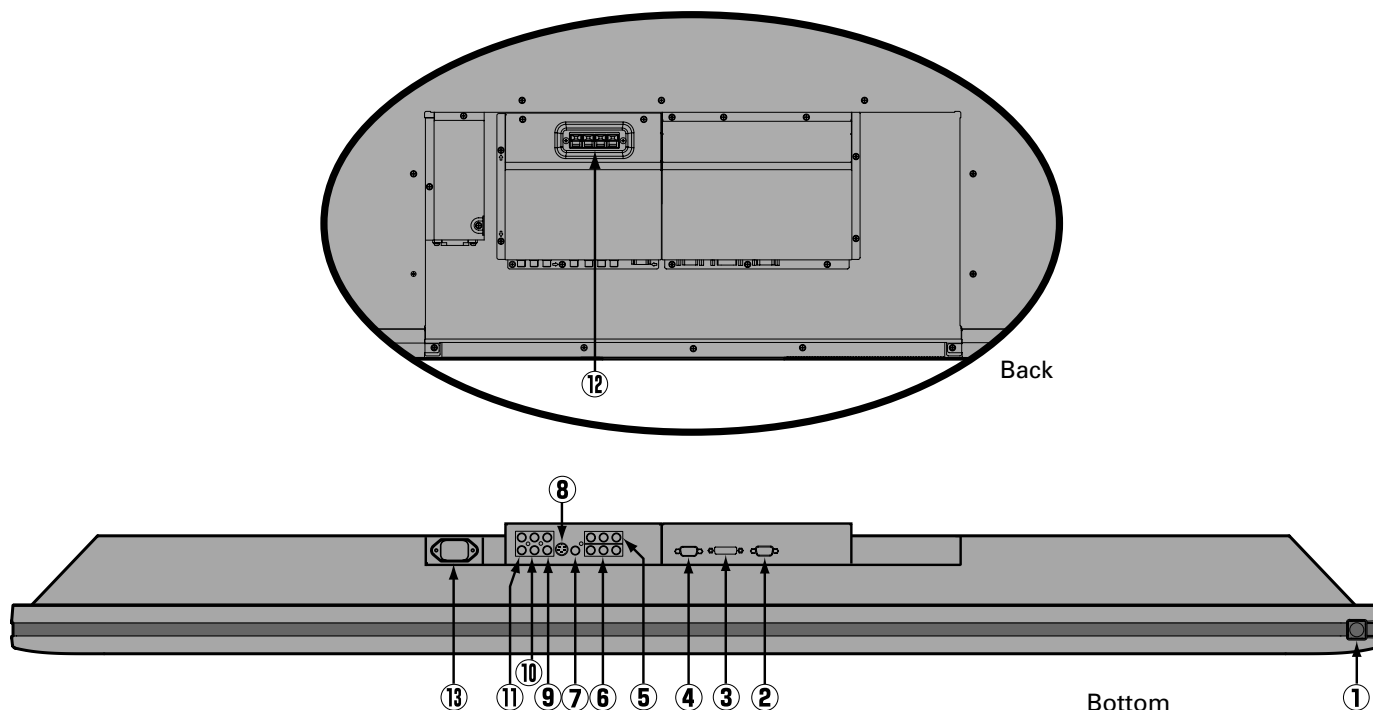

- ① **⏻/I power switch**
When pressed while in the “OFF” state, the power indicator lamp lights and the display is placed in the “ON ⏻” state, and the power can be turned “ON” or “OFF” by the remote control or on the control panel of the display. When pressed while in the “ON ⏻” state, the power indicator lamp goes out and the display is placed in the “OFF” state where power is still partly supplied.
- ② **RS-232C terminal (RS-232C)**
This terminal is provided for you to control the display from the PC. Connect it to the RS-232C terminal on the PC. When connecting a cable, attach a ferrite core to the cable. (See P. E-2.)
- ③ **RGB1 input terminal (RGB1 INPUT/DVI-D)**
Connect this terminal to the PC’s display (digital RGB) output terminal.
*The connection cable No.88741-8000 made by **molex Inc.** is recommended.
- ④ **RGB2 input terminal (RGB2 INPUT/mD-sub)**
Connect this terminal to the PC’s display (analog RGB) output terminal or decoder (digital broadcast tuner, etc.) output terminal.
- ⑤ **Component video input terminal (VIDEO3 INPUT)**
- ⑥ **Component video input terminal (VIDEO4 INPUT)**
Connect this terminal to the component video output (color difference output) terminal of your HDTV unit or DVD player.
- ⑦ **Video input terminal (VIDEO1 INPUT)**
Connect this terminal to the video output terminal of your VCR.
- ⑧ **S-Video input terminal (VIDEO2 INPUT)**
Connect this terminal to the S-video output terminal of your VCR.
- ⑨ **Audio3 input terminal (AUDIO3 INPUT)**
- ⑩ **Audio2 input terminal (AUDIO2 INPUT)**
- ⑪ **Audio1 input terminal (AUDIO1 INPUT)**
Connect this terminal to the audio output terminal of your VCR, etc. (See the User’s manual (2/2) for the selection of audio input for video input.)

⑫ **External speaker output terminal (EXT SP)**

Connect this terminal to the optionally available speaker.

When connecting a cable, attach a ferrite core to the cable. (See P. E-2.)

*See the speaker instruction manual for more information.

⑬ **Power input terminal**

Connect this terminal to the power cable supplied with the display.

When connecting a cable, attach a ferrite core to the cable. (See P. E-2.)

Description of Input Terminals

DVI-D terminal (RGB1 INPUT/DVI-D)

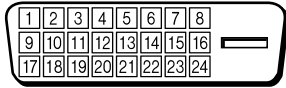

Pin No.	Signal	Pin No.	Signal	Pin No.	Signal
1	T.M.D.S. Data2-	9	T.M.D.S. Data1-	17	T.M.D.S. Data0-
2	T.M.D.S. Data2+	10	T.M.D.S. Data1+	18	T.M.D.S. Data0+
3	T.M.D.S. Data2 Shield	11	T.M.D.S. Data1 Shield	19	T.M.D.S. Data0 Shield
4	—	12	—	20	—
5	—	13	—	21	—
6	DDC Clock	14	+5V Power	22	T.M.D.S. Clock Shield
7	DDC Data	15	Ground(for +5V)	23	T.M.D.S. Clock+
8	—	16	Hot Plug Detect	24	T.M.D.S. Clock-

RGB2 input terminal (RGB2 INPUT/mD-sub)

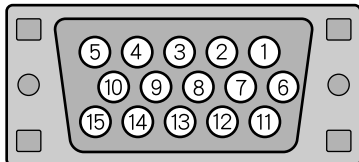

Pin No.	Input signal	Pin No.	Input signal
1	Red	9	—
2	Green	10	Ground
3	Blue	11	—
4	—	12	—
5	Ground	13	Horizontal synchronization
6	Ground	14	Vertical synchronization
7	Ground	15	—
8	Ground	Frame	Ground

RS-232C terminal (RS-232C)

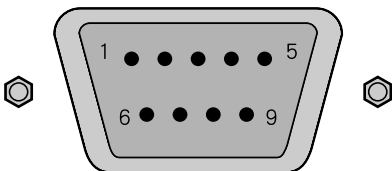

Pin No.	Signal
1	DCD (Data Carrier Detect)
2	RD (Received Data)
3	TD (Transmit Data)
4	DTR (Data Terminal ready)
5	GND (Ground)
6	DSR (Data Set Ready)
7	RTS (Request To send)
8	CTS (Clear To Send)
9	RI (Ring Indication)

* Terminal layout may differ and functions may not be available with some models and some device options.

INSTALLATION

To prevent the display's internal components from overheating, make sure that the display is installed in a well-ventilated location.

Be sure to use the optional desktop stand, ceiling-mounting unit, wall-mounting unit and other unit when installing this display. Also, be sure that your dealer performs the installation.

See the appropriate instruction manual for more information on the installation hardware you select.

To ensure proper heat radiation, provide at least as much space around the display as shown below.

- * Make sure that the display is installed in a location where the temperature can be maintained between 0°C and 40°C.
- * Install this device in a well-ventilated area. Keep the air vents of the device free from obstruction.
- * Never attempt to tilt the display sideways or backward.
- * To prevent the power and other cables from being accidentally pulled, be sure to make the wiring work along the wall or through the corners of floor.
- * To prevent an accident and ensure safety in the event of an earthquake, fix the display securely into position as described below.

Horizontal type

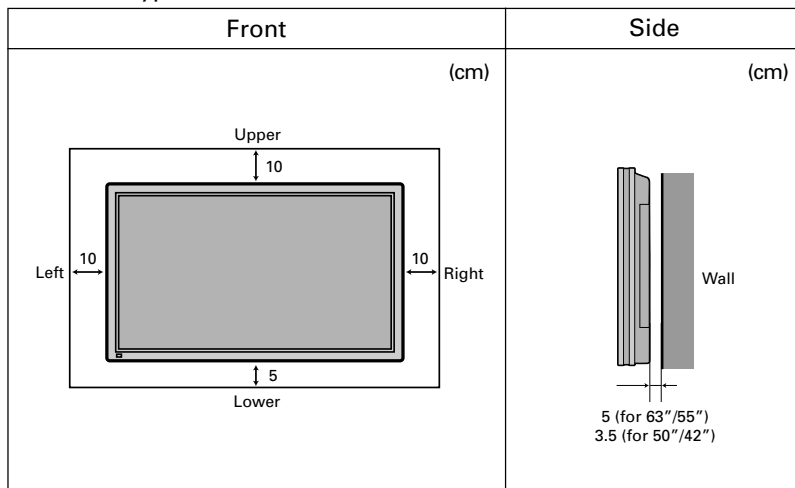

Note

The display is a highly precise piece of equipment and therefore must be packed properly before transportation. Be sure to use only those packing materials originally supplied with the display when repacking it.

Reference

See P.E-7 for more information on options.

OPTIONS

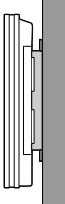
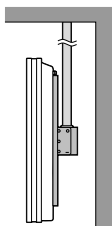
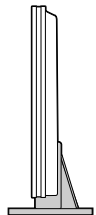
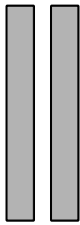
Wall-mounting Bracket	0° to 15° mounting angle	P-WB6300 (for 63"/55") P-WB4201 (for 50"/42")	
Ceiling-mounting unit	0° to 15° mounting angle	P-CT6300 (for 63"/55") P-CT4200 (for 50"/42")	
Desktop Stand unit		P-TT6300 (for 63"/55") P-TT4200 (for 50"/42")	
Speaker		P-SP6300 (for 63"/55") P-SP5000 (for 50") P-SP4200 (for 42") (1 set of 2 speakers)	

- * When installing an option, make sure that all installation requirements for that option (as given in the relevant instruction manual) are met.
- * The colors of options do not match the display colors perfectly.
- * To improve the function and performance of optional accessories, specifications and part names may change. Consult your local dealer before purchasing.

Warning

To prevent injury, fire, and electric shock, arrange for options to be initially installed (or installed at a different location) by your dealer.

CAUTION: This display (P63XHA30, P55XHA30) is for use only with Fujitsu General Limited's option (P-WB6300, P-CT6300, P-TT6300).
 This display (P50XHA30, P42HHA30, P42VHA30, P42VHA31) is for use only with Fujitsu General Limited's option (P-WB4201, P-CT4200, P-TT4200).
 Using this display with other option can cause instability resulting in possible injury.

MAIN SUPPORTED SIGNALS

This display can store the latest four types of signals for RGB adjustment value. The fifth input signal will replace the adjustment value of the first input signal.

To do this, select a desired signal and follow the instructions in “Adjusting Screen Position and Size” on the User’s manual (2/2) to adjust the parameters. When you finish, the settings will be automatically stored. Thus, when the display receives that signal, pictures will be displayed in accordance with the settings you most recently selected.

Main corresponding signals (RGB mode)

Display (dots x lines)	Horizontal frequency (kHz)	Vertical frequency (Hz)	Signal	DVI-D
640 x 480	31.47	59.94	VGA	○
640 x 480	37.50	75.00	VGA 75 Hz	
640 x 480	43.27	85.01	VGA 85 Hz	
720 x 400	31.47	70.09	400 lines	○
800 x 600	37.88	60.32	SVGA 60 Hz	○
800 x 600	46.88	75.00	SVGA 75 Hz	
800 x 600	53.67	85.06	SVGA 85 Hz	
1024 x 768	48.36	60.00	XGA 60 Hz	○
1024 x 768	60.02	75.03	XGA 75 Hz	
1024 x 768	68.68	84.99	XGA 85 Hz	
1280 x 1024	63.98	60.02	SXGA 60 Hz	
1280 x 1024	79.98	75.03	SXGA 75 Hz	
848 x 480	31.02	60.00		○
852 x 480	31.72	59.97		
1360 x 768	47.71	60.01		○ ※
720 x 485	15.73	59.94	60 fields	
720 x 575	15.63	50.00	50 fields	

* With some input signals, “Out of range” may appear even when the horizontal and vertical frequencies are within their permissible ranges. In this event, match the input signals to another frequency rather than those listed above.

* In the DVI-D mode, the input signal can be restricted partly.

※ It doesn’t support the model with 42” display.

In the Comp.video and Video/S-video modes, the display has been factory-set as follows for different input signals:

Main corresponding signals (Comp.video mode)

Horizontal frequency (kHz)	Vertical frequency (Hz)	Signal
15.73	59.94	SDTV 480I
15.63	50.00	SDTV 576I
31.47	59.94	SDTV 480P
31.25	50.00	SDTV 576P
45.00	60.00	HDTV 720P
37.50	50.00	HDTV 720P
33.75	60.00	HDTV 1080I
28.13	50.00	HDTV 1080I

Main corresponding signals (Video, S-video mode)

Horizontal frequency (kHz)	Vertical frequency (Hz)	Signal
15.73	59.94	NTSC
15.63	50.00	PAL
15.63	50.00	SECAM
15.63	59.52	PAL60
15.63	50.00	N-PAL
15.73	59.95	M-PAL
15.73	59.94	4.43NTSC

- Depending on the input signal, the display may show pictures of reduced size due to size reduction and interpolation.
- “Out of range” appears if the display receives a signal whose characteristic does not fall within the display’s permissible range.
- You can check input signals through “Information” on the FEATURES Menu screen. (See User’s Manual (2/2))
- In order to facilitate the explanations, pictures and diagrams in this manual may differ slightly from the actual items.
- All terms (i.e., company and product names) used in this document are trademarks or registered trademarks.
- Function may be different or unavailable with some models and some device options.

SPECIFICATION

Model	P63XHA30W/A		
Screen size	63" wide screen: 139.3 cm (W) x 78.3 cm (H) (159.8 cm diagonal) 54.8 inch (W) x 30.8 inch (H) (62.9 inch diagonal)		
Aspect ratio	16:9 (wide)		
Weight	72 kg / 159 lbs		
Outer dimensions	150.6 (W) x 89.6 (H) x 12.3 (D) cm 59.3 (W) x 35.3 (H) x 4.8 (D) inch (does not include outer projections)		
Power supply	110–240 VAC 50/60 Hz		
Current rating	7.9–3.0 A		
Number of pixels	1366 (H) x 768 (V)		
External equipment terminals			
Video input terminals	VIDEO1 INPUT (Video input)	1 RCA terminal	1 Vp-p/75 Ω
	VIDEO2 INPUT (S-video input)	1 S terminal	Y: 1 Vp-p/75 Ω C: 0.286 Vp-p/75 Ω
	VIDEO3/VIDEO4 INPUT (Component video input)	3 RCA terminals	Y: 1 Vp-p/75 Ω Pb/Cb: 0.7 Vp-p/75 Ω Pr/Cr: 0.7 Vp-p/75 Ω
Applicable systems	NTSC/PAL/SECAM/PAL60/N-PAL/M-PAL/4.43NTSC		
PC input terminal	RGB1 input RGB2 input	1 DVI-D terminal (EIA/CEA-861B Compliant) mD-sub, 3 rows, 15-pin Picture signal: 0.7 Vp-p/75 Ω Synchronization signal:TTL level	
Audio terminals	2 audio input pin jacks (L/R) (3 lines) 500 mVrms/at least 22 kΩ		
Control terminal	1 RS-232C connector (D-sub 9-pin)		
External speaker output terminal	Effective max. output: 10 W + 10 W (EIAJ), 6 Ω		
Operating conditions	Temperature: 0 to 40 °C / 32 to 104 °F Humidity: 20 to 80 %		
Accessories	1 remote control, 2AA batteries, 2 user's manuals, 1 power cable, 2 big ferrite cores, 2 small ferrite cores		

Regulation

- UL, CSA Safety: UL6500, C-UL
EMC: FCC Part 15 Class B, ICES-003 Class B
- CE Safety: EN60065
EMC: EN55022 1998, Class B
EN61000-3-2 1995
EN61000-3-3 1995
EN55024 1998
EN61000-4-2 1995
EN61000-4-3 1996
EN61000-4-4 1995
EN61000-4-5 1995
EN61000-4-6 1996
EN61000-4-8 1993
EN61000-4-11 1994
- AS Safety: IEC60065
EMC: AS/NZS 3548

• Viewing the screen constantly for extended periods can strain your eyes. Be sure to stay at a proper distance (at least 2.4 m or 7.9 feet for 63") from the screen and to look occasionally away while working.

SPECIFICATION (Continued)

Model	P55XHA30W/A		
Screen size	55" wide screen: 122.9 cm (W) x 69.1 cm (H) (140.0 cm diagonal) 48.4 inch (W) x 27.2 inch (H) (55.1 inch diagonal)		
Aspect ratio	16:9 (wide)		
Weight	55 kg / 121 lbs		
Outer dimensions	137.8 (W) x 81.0 (H) x 12.3 (D) cm 54.3 (W) x 31.9 (H) x 4.8 (D) inch (does not include outer projections)		
Power supply	110–240 VAC 50/60 Hz		
Current rating	5.9–2.5 A		
Number of pixels	1366 (H) x 768 (V)		
External equipment terminals			
Video input terminals	VIDEO1 INPUT (Video input)	1 RCA terminal	1 V _{p-p} /75 Ω
	VIDEO2 INPUT (S-video input)	1 S terminal	Y: 1 V _{p-p} /75 Ω C: 0.286 V _{p-p} /75 Ω
	VIDEO3/VIDEO4 INPUT (Component video input)	3 RCA terminals	Y: 1 V _{p-p} /75 Ω P _B /C _B : 0.7 V _{p-p} /75 Ω P _R /C _R : 0.7 V _{p-p} /75 Ω
Applicable systems	NTSC/PAL/SECAM/PAL60/N-PAL/M-PAL/4.43NTSC		
PC input terminal	RGB1 input RGB2 input	1 DVI-D terminal (EIA/CEA-861B Compliant) mD-sub, 3 rows, 15-pin Picture signal: 0.7 V _{p-p} /75 Ω Synchronization signal:TTL level	
Audio terminals	2 audio input pin jacks (L/R) (3 lines) 500 mV _{rms} /at least 22 kΩ		
Control terminal	1 RS-232C connector (D-sub 9-pin)		
External speaker output terminal	Effective max. output: 10 W + 10 W (EIAJ), 6 Ω		
Operating conditions	Temperature: 0 to 40 °C / 32 to 104 °F Humidity: 20 to 80 %		
Accessories	1 remote control, 2AA batteries, 2 user's manuals, 1 power cable, 2 big ferrite cores, 2 small ferrite cores		

Regulation

- UL, CSA Safety: UL6500, C-UL
EMC: FCC Part 15 Class B, ICES-003 Class B
- CE Safety: EN60065
EMC: EN55022 1998, Class B
EN61000-3-2 1995
EN61000-3-3 1995
EN55024 1998
EN61000-4-2 1995
EN61000-4-3 1996
EN61000-4-4 1995
EN61000-4-5 1995
EN61000-4-6 1996
EN61000-4-8 1993
EN61000-4-11 1994
- AS Safety: IEC60065
EMC: AS/NZS 3548

• Viewing the screen constantly for extended periods can strain your eyes. Be sure to stay at a proper distance (at least 2.1 m or 6.9 feet for 55") from the screen and to look occasionally away while working.

Model	P50XHA30W/A		
Screen size	50" wide screen: 110.6 cm (W) x 62.2 cm (H) (126.9 cm diagonal) 43.5 inch (W) x 24.5 inch (H) (50 inch diagonal)		
Aspect ratio	16:9 (wide)		
Weight	45 kg / 99 lbs		
Outer dimensions	121.4 (W) x 72.8 (H) x 9.8 (D) cm 47.8 (W) x 28.7 (H) x 3.9 (D) inch (does not include outer projections)		
Power supply	110–240 VAC 50/60 Hz		
Current rating	5.2–2.1 A		
Number of pixels	1366 (H) x 768 (V)		
External equipment terminals			
Video input terminals	VIDEO1 INPUT (Video input)	1 RCA terminal	1 Vp-p/75 Ω
	VIDEO2 INPUT (S-video input)	1 S terminal	Y: 1 Vp-p/75 Ω C: 0.286 Vp-p/75 Ω
	VIDEO3/VIDEO4 INPUT (Component video input)	3 RCA terminals	Y: 1 Vp-p/75 Ω Pb/Cb: 0.7 Vp-p/75 Ω Pr/Cr: 0.7 Vp-p/75 Ω
Applicable systems	NTSC/PAL/SECAM/PAL60/N-PAL/M-PAL/4.43NTSC		
PC input terminal	RGB1 input RGB2 input	1 DVI-D terminal (EIA/CEA-861B Compliant) mD-sub, 3 rows, 15-pin Picture signal: 0.7 Vp-p/75 Ω Synchronization signal:TTL level	
Audio terminals	2 audio input pin jacks (L/R) (3 lines) 500 mVrms/at least 22 kΩ		
Control terminal	1 RS-232C connector (D-sub 9-pin)		
External speaker output terminal	Effective max. output: 10 W + 10 W (EIAJ), 6 Ω		
Operating conditions	Temperature: 0 to 40 °C / 32 to 104 °F Humidity: 20 to 80 %		
Accessories	1 remote control, 2AA batteries, 2 user's manuals, 1 power cable, 2 big ferrite cores, 2 small ferrite cores		

Regulation

- UL, CSA Safety: UL6500, C-UL
EMC: FCC Part 15 Class B, ICES-003 Class B
- CE Safety: EN60065
EMC: EN55022 1998, Class B
EN61000-3-2 1995
EN61000-3-3 1995
EN55024 1998
EN61000-4-2 1995
EN61000-4-3 1996
EN61000-4-4 1995
EN61000-4-5 1995
EN61000-4-6 1996
EN61000-4-8 1993
EN61000-4-11 1994
- AS Safety: IEC60065
EMC: AS/NZS 3548

• Viewing the screen constantly for extended periods can strain your eyes. Be sure to stay at a proper distance (at least 1.9 m or 6.2 feet for 50") from the screen and to look occasionally away while working.

SPECIFICATION (Continued)

Model	P42VHA30W/A	P42VHA31W/A	P42HHA30W/A
Screen size	42" wide screen: 92.1 cm (W) x 51.8 cm (H) (105.7 cm diagonal) 36.3 inch (W) x 20.4 inch (H) (41.6 inch diagonal)		42" wide screen: 92.2 cm (W) x 52.2 cm (H) (106.0 cm diagonal) 36.3 inch (W) x 20.6 inch (H) (41.7 inch diagonal)
Aspect ratio	16:9 (wide)		
Weight	30 kg / 66 lbs		
Outer dimensions	103.7 (W) x 64.2 (H) x 8.5 (D) cm 40.8 (W) x 25.3 (H) x 3.3 (D) inch (does not include outer projections)		
Power supply	110–240 VAC 50/60 Hz		
Current rating	3.5–1.35 A	4.2–1.7 A	4.0–1.95 A
Number of pixels	852 (H) x 480 (V)		1024 (H) x 1024 (V)
External equipment terminals			
Video input terminals	VIDEO1 INPUT (Video input)		1 RCA terminal 1 V _{p-p} /75 Ω
	VIDEO2 INPUT (S-video input)		1 S terminal Y: 1 V _{p-p} /75 Ω C: 0.286 V _{p-p} /75 Ω
	VIDEO3/VIDEO4 INPUT (Component video input)		3 RCA terminals Y: 1 V _{p-p} /75 Ω P _B /C _B : 0.7 V _{p-p} /75 Ω P _R /C _R : 0.7 V _{p-p} /75 Ω
Applicable systems	NTSC/PAL/SECAM/PAL60/N-PAL/M-PAL/4.43NTSC		
PC input terminal	RGB1 input RGB2 input	1 DVI-D terminal (EIA/CEA-861B Compliant) mD-sub, 3 rows, 15-pin Picture signal: 0.7 V _{p-p} /75 Ω Synchronization signal:TTL level	
Audio terminals	2 audio input pin jacks (L/R) (3 lines) 500 mV _{rms} /at least 22 kΩ		
Control terminal	1 RS-232C connector (D-sub 9-pin)		
External speaker output terminal	Effective max. output: 10 W + 10 W (EIAJ), 6 Ω		
Operating conditions	Temperature: 0 to 40 °C / 32 to 104 °F Humidity: 20 to 80 %		
Accessories	1 remote control, 2AA batteries, 2 user's manuals, 1 power cable, 2 big ferrite cores, 2 small ferrite cores		

Regulation

- UL, CSA Safety: UL6500, C-UL
EMC: FCC Part 15 Class B, ICES-003 Class B
- CE Safety: EN60065
EMC: EN55022 1998, Class B
EN61000-3-2 1995
EN61000-3-3 1995
EN55024 1998
EN61000-4-2 1995
EN61000-4-3 1996
EN61000-4-4 1995
EN61000-4-5 1995
EN61000-4-6 1996
EN61000-4-8 1993
EN61000-4-11 1994
- AS Safety: IEC60065
EMC: AS/NZS 3548

- Specifications and external appearance may be change for the sake of improvement.
- Viewing the screen constantly for extended periods can strain your eyes. Be sure to stay at a proper distance (at least 1.6 m or 5.2 feet for 42") from the screen and to look occasionally away while working.
- **Plasmavision** is a worldwide trademark of Fujitsu General Limited and is a registered trademark in Japan, the U.S.A. and other countries or areas.

USER'S MANUAL (2/2) (Precautions and Adjustment Methods)

WIDE PLASMA DISPLAY

Plasmavision™

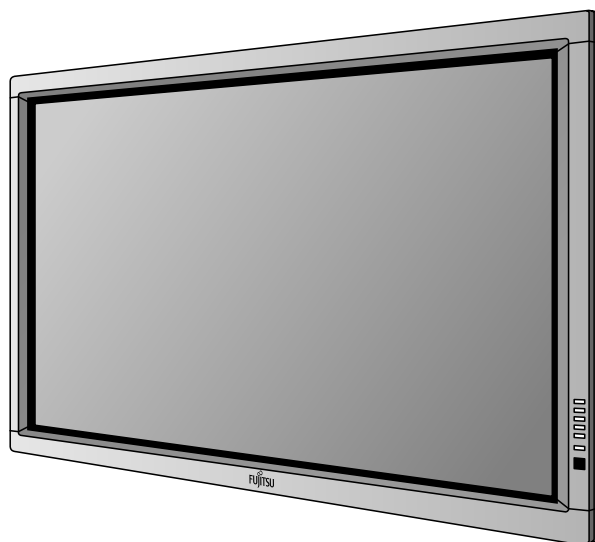

Contents

	Page
Before Use	
• Safety Precautions	E-2-E-3
Usage	
• Handy Tips	E-4
• Connecting the Display to External Equipment	E-5-E-8
• Using the Remote Control	E-9-E-11
• Basic Operations	E-12-E-13
• Selecting Input Mode	E-14
• Other Basic Operations	E-15
• Watching Pictures on the Wide Screen	E-16-E-17
Adjustments	
• Adjustment Menu	E-18
• Adjusting Pictures (PICTURE Menu)	E-19-E-21
• Adjusting Screen Position and Size (POSITION/SIZE Menu)	E-22-E-23
• Adjusting Audio (AUDIO Menu)	E-24-E-25
• Other Adjustments (FEATURES Menu)	E-26-E-32
• Initialization of User Adjustment Value (FACTORY DEFAULT)	E-33
• Cleaning and Maintenance	E-34

Before using the display, read the User's manual (1/2) and the User's manual (2/2) carefully so that you know how to use the display correctly.

Refer to these manuals whenever questions or problems about operation arise. Be sure to read and observe the safety precautions.

Keep these manuals where the user can access them readily.

** Installation and removal require special expertise. Consult your product dealer for details.*

SAFETY PRECAUTIONS

IMPORTANT INFORMATION

IMPORTANT



The lightning flash with arrowhead symbol, within an equilateral triangle, is intended to alert the user to the presence of uninsulated “dangerous voltage” within the product’s enclosure that may be of sufficient magnitude to constitute a risk of electric shock to persons.



CAUTION:
TO PREVENT THE RISK OF ELECTRIC SHOCK, DO NOT REMOVE COVER (OR BACK). NO USER-SERVICEABLE PARTS INSIDE. REFER SERVICING TO QUALIFIED SERVICE PERSONNEL.



The exclamation point within an equilateral triangle is intended to alert the user to the presence of important operating and maintenance (servicing) instructions in the literature accompanying the appliance.

WARNING: This is a Class A and Class B product. In a domestic environment this product may cause radio interference in which case the user may be required to take adequate measures.

WARNING: TO REDUCE THE RISK OF FIRE AND ELECTRIC SHOCK, DO NOT EXPOSE THIS PRODUCT TO RAIN OR MOISTURE.

FCC NOTICE

• A Class A digital device

This equipment has been tested and found to comply with the limits for a Class A digital device, pursuant to Part 15 of the FCC Rules. These limits are designed to provide reasonable protection against harmful interference when the equipment is operated in a commercial environment. This equipment generates, uses, and can radiate radio frequency energy and, if not installed and used in accordance with the instruction manual, may cause harmful interference to radio communications. Operation of this equipment in a residential area is likely to cause harmful interference in which case the user will be required to correct the interference at his own expense.

• A Class B digital device

This equipment has been tested and found to comply with the limits for a Class B digital device, pursuant to Part 15 of the FCC Rules. These limits are designed to provide reasonable protection against harmful interference in a residential installation. This equipment generates, uses and can radiate radio frequency energy and, if not installed and used in accordance with the instructions, may cause harmful interference to radio communications. However, there is no guarantee that interference will not occur in a particular installation. If this equipment does cause harmful interference to radio or television reception, which can be determined by turning the equipment off and on, the user is encouraged to try to correct the interference by one or more of the following measures:

- Reorient or relocate the receiving antenna.
- Increase the separation between the equipment and receiver.
- Connect the equipment into an outlet on a circuit different from that to which the receiver is connected.
- Consult the dealer or an experienced radio/TV technician for help.

IMPORTANT SAFETY INSTRUCTIONS

Electrical energy can perform many useful functions. This unit has been engineered and manufactured to assure your personal safety. But **IMPROPER USE CAN RESULT IN POTENTIAL ELECTRICAL SHOCK OR FIRE HAZARD.** In order not to defeat the safeguards incorporated into this product, observe the following basic rules for its installation, use and service. Please read these “Important Safeguards” carefully before use.

- 1) Read these instructions.
- 2) Keep these instructions.
- 3) Heed all warnings.
- 4) Follow all instructions.
- 5) Do not use this apparatus near water.
- 6) Clean only with dry cloth.
- 7) Do not block any ventilation openings. Install in accordance with the manufacturer’s instructions.
- 8) Do not install near any heat sources such as radiators, heat registers, stoves, or other apparatus (including amplifier’s) that produce heat.
- 9) Do not defeat the safety purpose of the polarized or grounding-type plug. A polarized plug has two blades with one wider than the other. A grounding type plug has two blades and a third grounding prong. The wide blade or the third prong are provided for your safety. If the provided plug does not fit into your outlet, consult an electrician for replacement of the obsolete outlet.
- 10) Protect the power cord from being walked on or pinched particularly at plugs, convenience receptacles, and the point where they exit from the apparatus.
- 11) Only use attachments/accessories specified by the manufacturer.

- 12) Use only with the cart, stand, tripod, bracket, or table specified by the manufacturer, or sold with the apparatus.

When a cart is used, use caution when moving the cart/apparatus combination to avoid injury from tip-over.

- 13) Unplug this apparatus during lightning storms or when unused for long periods of time.

- 14) Refer all servicing to qualified service personnel. Servicing is required when the apparatus has been damaged in any way, such as power-supply cord or plug is damaged, liquid has been spilled or objects have fallen into the apparatus, the apparatus has been exposed to rain or moisture, does not operate normally, or has been dropped.



- Unplug this product from the wall outlet before cleaning. Do not use liquid cleaners or aerosol cleaners. Use a damp cloth for cleaning.
- Do not use attachments not recommended by the product manufacturer as they may cause hazards.
- Do not use immediately after moving from a low temperature to high temperature, as this causes condensation, which may result in fire, electric shock, or other hazards.
- The apparatus shall not be exposed to dripping or splashing.
- No objects filled with liquids, such as vases, shall be placed on the apparatus.
- Do not place this product on an unstable cart, stand, or table. The product may fall, causing serious injury to a child or adult, and serious damage to the product. The product should be mounted according to the manufacturer's instructions, and should use a mount recommended by the manufacturer.
- When the product is used on a cart, care should be taken to avoid quick stops, excessive force, and uneven surfaces which may cause the product and cart to overturn, damaging equipment or causing possible injury to the operator.
- Slots and openings in the cabinet are provided for ventilation. These ensure reliable operation of the product and protect it from overheating. These openings must not be blocked or covered. (The openings should never be blocked by placing the product on bed, sofa, rug, or other similar surface. It should not be placed in a built-in installation such as a bookcase or rack unless proper ventilation is provided and the manufacturer's instructions have been adhered to.)

For proper ventilation, separate the product from other equipment, which may prevent ventilation, and keep distance more than 10 cm.

- This product should be operated only from the type of power source indicated on the label. If you are not sure of the type of power supply of your home, consult your product dealer or local power company.
- This product is equipped with a three-wire plug. This plug will fit only into a grounded power outlet. If you are unable to insert the plug into the outlet, contact your electrician to install the proper outlet. Do not defeat the safety purpose of the grounded plug.
- Power-supply cords should be routed so that they are not likely to be walked on or pinched by items placed upon or against them. Pay particular attention to cords at doors, plugs, receptacles, and the point where they exit from the product.
- For added protection for this product during a lightning storm, or when it is left unattended and unused for long periods of time, unplug it from the wall outlet and disconnect the cable system. This will prevent damage to the product due to lightning and power line surges.
- Do not overload wall outlets, extension cords, or convenience receptacles on other equipment as this can result in a risk of fire or electric shock.
- Never push objects of any kind into this product through openings as they may touch dangerous voltage points or short out parts that could result in a fire or electric shock. Never spill liquid of any kind on the product.
- Do not attempt to service this product yourself as opening or removing covers may expose you to dangerous voltages and other hazards. Refer all service to qualified service personnel.
- Unplug this product from the wall outlet and refer service to qualified service personnel if the product does not operate normally by following the operating instructions. Adjust only those controls that are covered by the Operation Manual, as an improper adjustment of other controls may result in damage and will often require extensive work by a qualified technician to restore the product to its normal operation.
- When replacement parts are required, be sure the service technician has used replacement parts specified by the manufacturer or with same characteristics as the original part. Unauthorized substitutions may result in fire, electric shock, or other hazards.
- Upon completion of any service or repairs to this product, ask the service technician to perform safety checks to determine that the product is in proper operating condition.
- The product should be placed more than one foot away from heat sources such as radiators, heat registers, stoves, and other products (including amplifiers) that produce heat.
- When connecting other products such as VCR's, and personal computers, you should turn off the power of this product for protection against electric shock.
- Do not place combustibles behind the cooling fan. For example, cloth, paper, matches, aerosol cans or gas lighters that present special hazards when overheated.
- Use only the accessory cord designed for this product to prevent shock.

The power supply voltage rating of this product is AC110–240 V and the power cord attached conforms to the following power supply voltage. Use only the power cord designated by our dealer to ensure Safety and EMC.

When it is used with other power supply voltage, the power cable must be changed.

Use the standard power plug and cord set of the specified country.

Consult your product dealer.

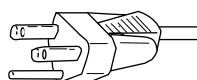

Power supply voltage:

AC 100–125 V

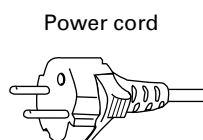

Power cord

AC 200–240 V

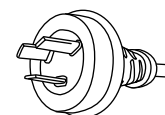

AC 240 V (SAA TYPE)

HANDY TIPS

RECEPTACLE

Make sure that the power cable's grounding wire is grounded.

The display comes with a 3-prong power plug; one prong is connected to the grounding wire. If you have only a 2-hole receptacle, you will need to have it replaced. Contact your dealer for more information.

- Have the display inspected and cleaned by your dealer at regular intervals.
- Pictures may become "burnt" into the screen phosphors if the screen is left on for extended periods. To ensure that the display has a prolonged service life, be sure to use a screen orbiter, white screen. This will ensure the same picture or pattern is not constantly displayed for long periods. (See P. E-31–E-32.)
- The plasma display panel, which is built for maximum precision, provides more than 99.99% effective pixels. You may find, however, that some pixels constantly remain lit or dimmed.
- The display has a fan to prevent its internal temperature from rising.
- Be careful with the air delivered by the fan. It may be very hot.
- Contact your dealer if you find that the display does not seem to function properly when used with other audio-visual equipment.
You may need to move your display if it produces degraded pictures or noise due to electromagnetic radiation, or if the infrared remote control does not function properly.
- Pictures may not be displayed properly if you connect a non-standard PC to the RGB input terminal. In this case, contact your dealer for more information.
- The protective circuit, built into the display, automatically turns off the power if the display has a problem. In this case, you will see that the power indicator lamp flashes red or green.

Warning

If the power indicator lamp flashes red or green, this signifies that the display has developed a problem. When this happens, be sure to remove the power plug from the receptacle to prevent fire or electric shock. Then contact your dealer.

Information

Cables for connecting the display to external equipment are not supplied. Contact your dealer for more information on these products.

CONNECTING THE DISPLAY TO EXTERNAL EQUIPMENT

EXAMPLE OF CONNECTION TO EXTERNAL COMPONENTS

Be sure to turn OFF the power to the display and external equipment before making any connections.

No cables are supplied with the display for connection to external equipment. The type of cable to be used varies depending on the PC model. Contact your dealer for more information.

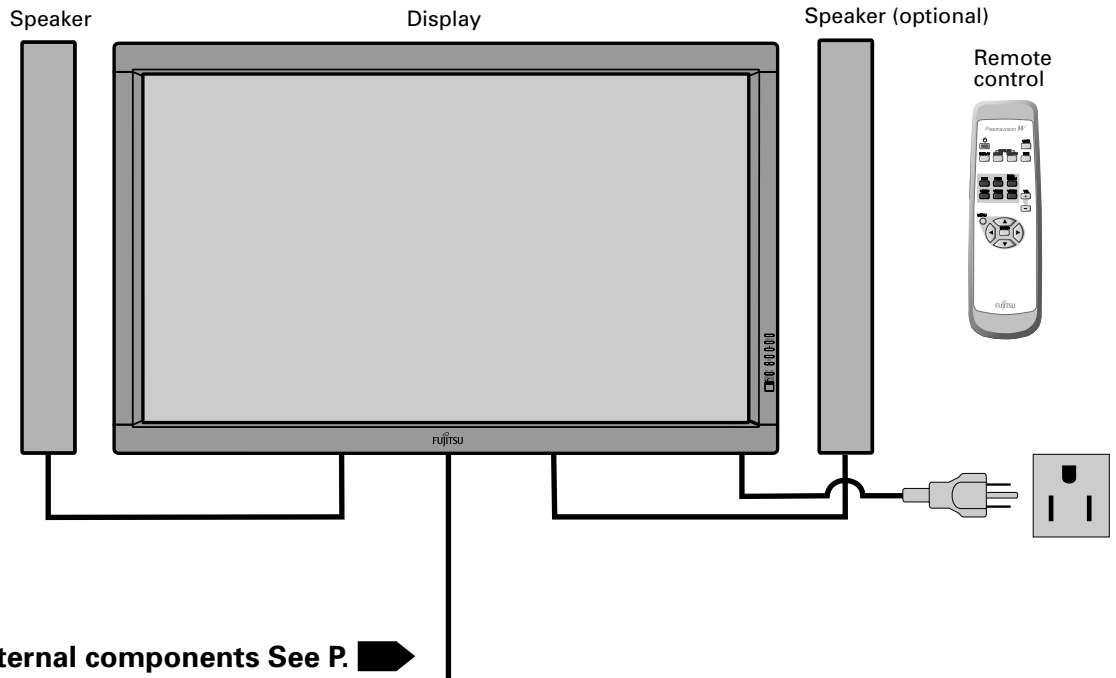

VCR or other external components See P.

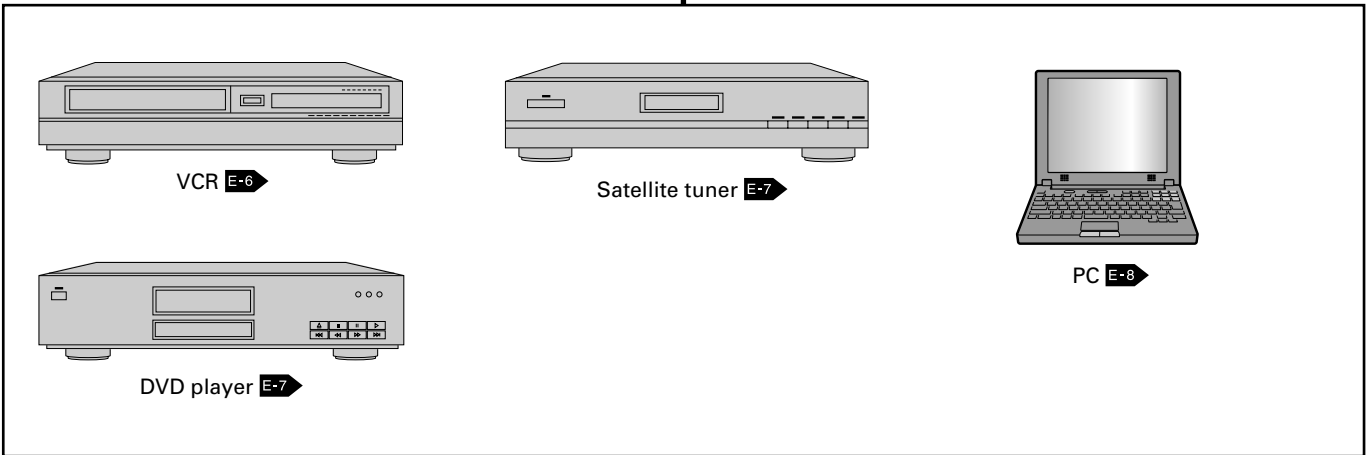

CONNECTING THE DISPLAY TO EXTERNAL EQUIPMENT (Continued)

VCR

- Connect the video signal cable to either the S-video input terminal or the video input terminal.

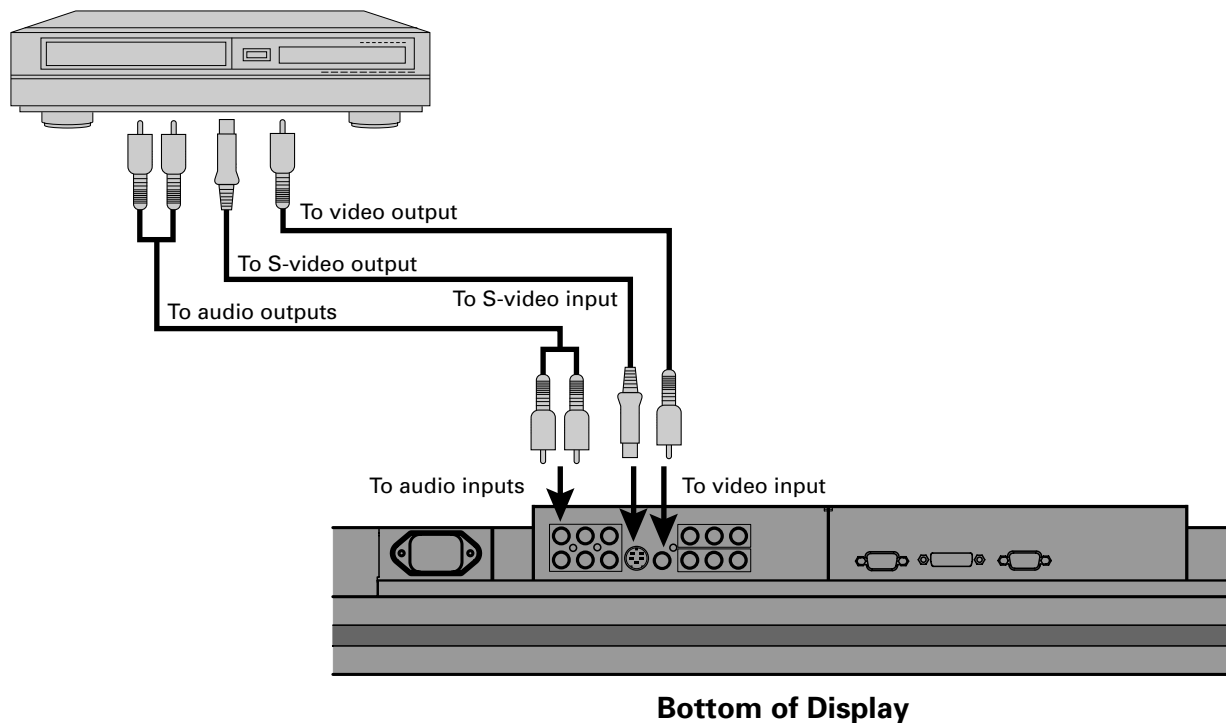

Note

- Unplug the power cord from the AC outlet before you connect external components.
- Also refer to the instructions for the component to be connected.
- * When inputting voice see "Selecting input terminals (page E-30)"
- * Terminal layout may differ and functions may not be available with some models and some device options.

DVD PLAYER

- Connect the video signal cable to the component video input terminal, S-video input terminal, or the video input terminal.
- If the component to be connected is equipped with component video output terminal, it is recommended to connect to the component video output terminal.

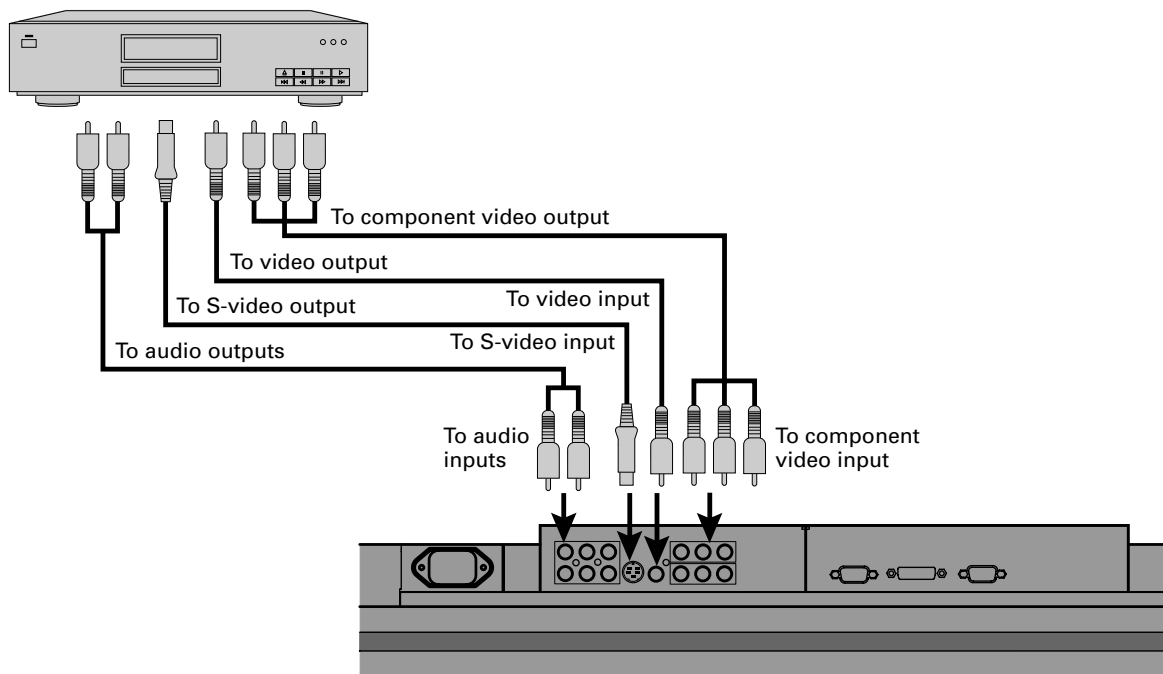

Bottom of Display

SATELLITE TUNER

- Connect the video signal cable to the component video input terminal, S-video input terminal, or the video input terminal.
- If the component to be connected is equipped with component video output terminal, it is recommended to connect to the component video terminal.

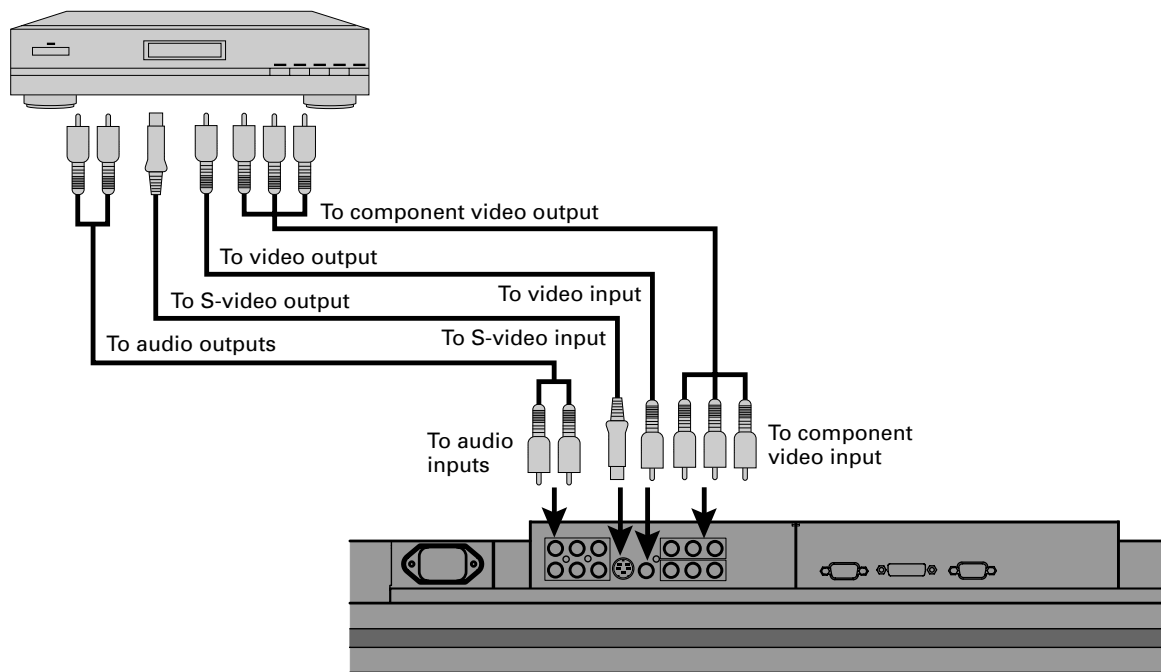

Bottom of Display

CONNECTING THE DISPLAY TO EXTERNAL EQUIPMENT (Continued)

PC

- As the cable for connecting a PC differs with the PC model, please consult your dealer for information on the right cable to purchase.
- The PC can be connected to either the front side or the rear side, whichever is most convenient.

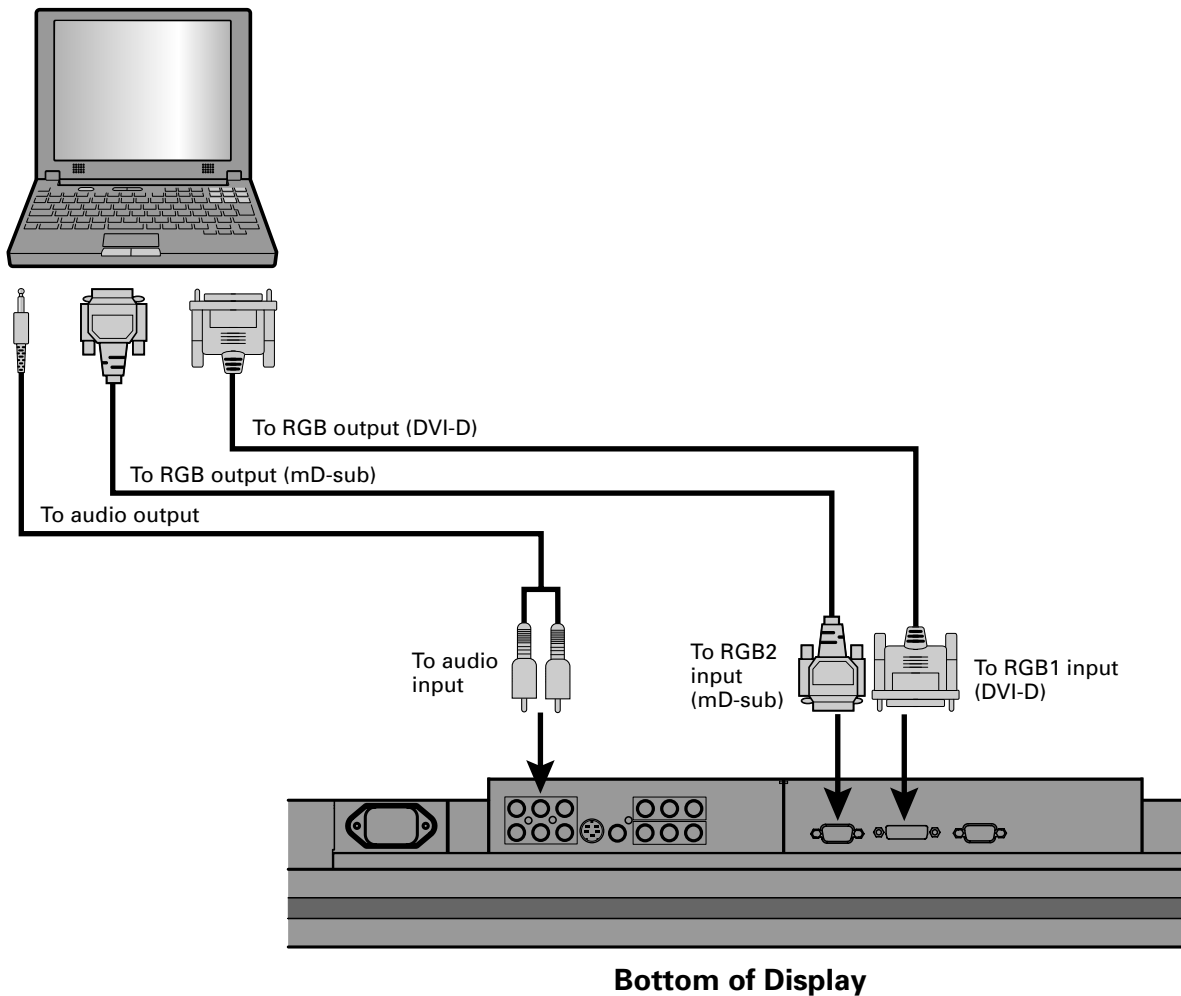



Note

- Unplug the power cord from the AC outlet before you connect external components.
- Also refer to the instructions for the component to be connected.
- * When inputting voice see "Selecting input terminals (page E-30)"
- * Terminal layout may differ and functions may not be available with some models and some device options.

USING THE REMOTE CONTROL

REMOTE CONTROL

For details, see page .

- ① **Power button**  **E-12**
Switches between power ON and standby state.
- ③ **DISPLAY OFF button** **E-15**
For showing on-screen-information.
- ④ **PICTURE MODE button** **E-15**
Switches the picture mode.
- ⑦ **RGB input mode selector button [RGB 1 – 2]** **E-14**
Selects RGB 1 – 2.
- ⑨ **Video input mode selector button [VIDEO 1 – 3]** **E-14**
Selects VIDEO 1 – 3.
- ⑪ **Menu button [MENU]** **E-18** – **E-33**
Use this button to display a desired menu for adjusting the picture.
- ⑫ **Enter button [ENTER]** **E-18** – **E-33**
Press this button to finalize the selection of a desired menu or option within a menu.

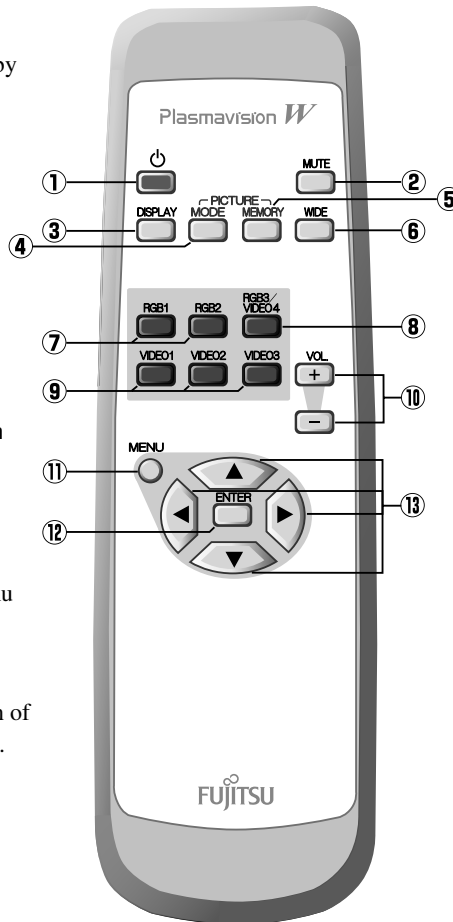

- ② **MUTE button** **E-13**
Temporarily mutes the audio.
- ⑤ **PICTURE MEMORY button** **E-15**
Recalls the PICTURE MEMORY.
- ⑥ **WIDE button** **E-16**
Switches the screen over to a desired wide screen.
- ⑧ **RGB3/VIDEO4 input mode selector button [RGB3/VIDEO4]** **E-15**
Selects VIDEO4.
- ⑩ **Volume adjustment buttons [VOL +/-]** **E-13**
Adjust the volume.
Press the + button to increase the volume.
Press the – button to reduce the volume.
- ⑬ **Adjustment buttons [◀/▶/▲/▼]** **E-18** – **E-33**
Use these buttons to scroll through options in a menu.

* Functions may not be available with some models and some device options.

USING THE REMOTE CONTROL (Continued)

PUTTING BATTERIES IN THE REMOTE CONTROL



- ① To remove the cover, slide it outwards while pressing it down.



- ② Place two AA batteries in the remote control. Make sure that the batteries are properly oriented.



- ③ Close the cover until it snaps into place.

PRECAUTIONS

To prevent malfunction, be sure not to apply any form of severe shock to the remote control.

To prevent malfunction or deformation, be sure not to allow the remote control to become wet; also, keep it away from hot locations or heating equipment.

Be sure not to clean the remote control using a cloth dampened in any volatile solvent, such as benzene or thinner.

CAUTION: Be sure to use replacement batteries of the same type as the original ones.
When disposing of used batteries, please comply with governmental regulations or environmental public institution's rules that apply in your country/area.

Note

The remote control will not function properly if the batteries are dead. Be sure to replace them as needed.
Do not use rechargeable batteries (Ni-Cd).

EFFECTIVE RANGE FOR THE REMOTE CONTROL

Point the remote control at the display's signal receiver when using it.

Make sure that there are no obstacles between the remote control and the display's signal receiver.

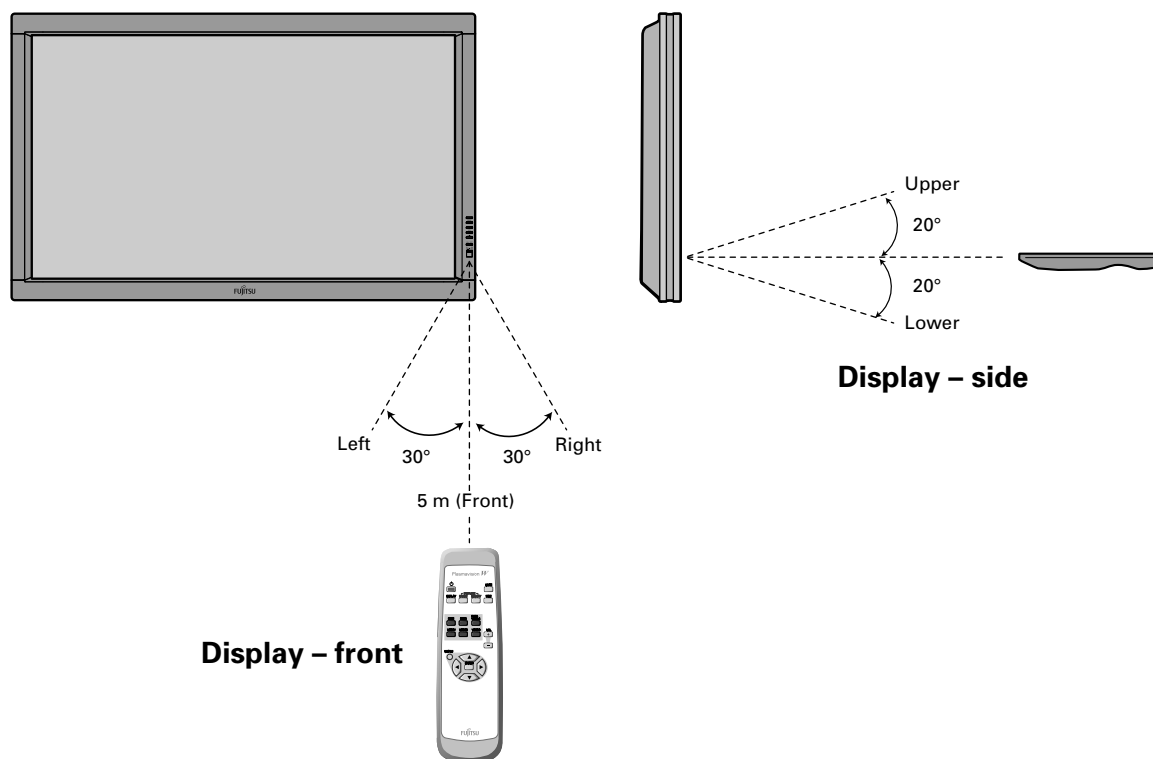

Information



The remote control may not function properly if you use a high-frequency fluorescent lamp. If you experience problems, move the lamp or use the remote control from a different position.

BASIC OPERATIONS

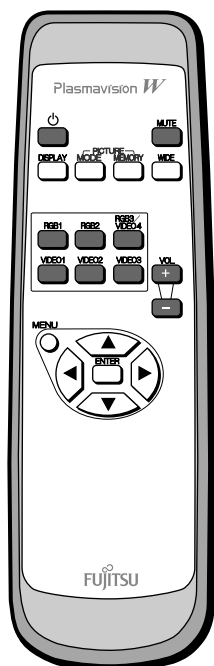
TURNING THE POWER ON AND OFF





* You can also use the buttons on the display's control panel to perform these steps.

1 Press  to the left at the bottom of the display to the ON  state.

The power lamp lights up.

2 Press  on the remote control.

The color of the power lamp changes from "Red" to "Green".

3 Press  -  or  -  or .

Select the video mode to be input.

Press  when the power is ON.

The color of the power lamp changes from "Green" to "Red" and the power turns "OFF".

ADJUSTING THE VOLUME

Press the Volume button

Press  to increase the volume.

Press  to reduce the volume.

* Note that the volume level remains stored even when you turn OFF the power.

Muting the audio

Press  .

The audio is removed.

Press again to restore the audio to the original level.

The mute mode can also be released by pressing the volume buttons.



When the volume adjustment button is pressed

SELECTING INPUT MODE

VIDEO INPUT MODE

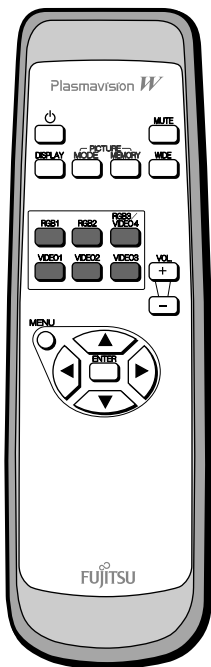

1

Press the **VIDEO1** – **RGB3/VIDEO4** buttons to select the input mode.

You can select from VIDEO1 mode to VIDEO4 mode.

The video modes corresponding to each input terminal are as follows.

- VIDEO1: Video
- VIDEO2: S-video
- VIDEO3: Component video
- VIDEO4: Component video

* For selection of the input terminal, see “SETTING THE INPUT TERMINALS” on P. E-29.



Video1 mode

* You can also use the buttons on the display's control panel to perform these steps.

RGB INPUT MODE

1

Press the **RGB1** – **RGB2** buttons to select the input mode.

You can select between the modes from RGB1 to RGB2.

The input terminal of each RGB mode is as follows.

- RGB1: DVI-D
- RGB2: mD-sub

* For selection of the input terminal, see “SETTING THE INPUT TERMINALS” on P. E-29.



RGB1 mode

CONVENIENT FUNCTIONS

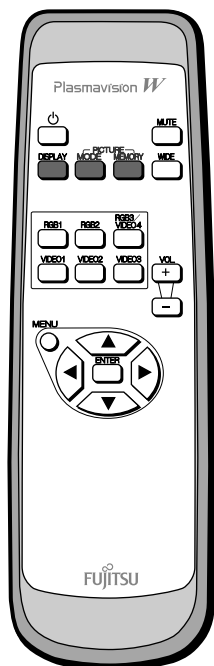

On-screen information (DISPLAY)

Press  .

The mode is indicated on the screen for 5 seconds.

Picture Mode (PICTURE MODE)

Press  .

This button can be used to switch the picture mode.

In the picture mode, you can switch between the set status and the fine mode.

* For the picture mode settings, see “Setting Picture Mode (P. E-20)”.

Picture Memory (PICTURE MEMORY)

Press  .

This button can be used to recall the settings of the picture memories 1 – 8. Each time this button is pressed, the setting changes as follows.

→Memory1→Memory2→Memory3→Memory4→Memory5→Memory6→Memory7→Memory8→

* For the picture memory settings, see “Picture Memory (P. E-21)”.

WATCHING PICTURES ON THE WIDE SCREEN

SWITCHING BETWEEN SCREEN SIZES

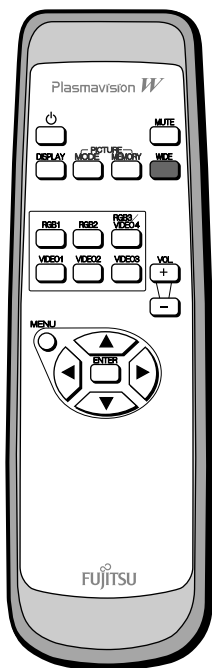

* You can also use the buttons on the display's control panel to perform these steps.

1 Press .

The currently selected mode will appear.

2 Press  to select a desired picture mode.

Each time you press , a different picture mode appears. The sequences used are as follows:

When you are in a Video or S-video input mode

→Normal→Auto→Wide1→Wide2
Zoom2 ← Zoom1 ←

When you are in a Comp.video input mode

→Normal→Wide1→Wide2
Zoom2 ← Zoom1 ←

When you are in an RGB input mode

→Normal→Wide→Zoom

* Depending on the type of signal, some aspects may not be selected.

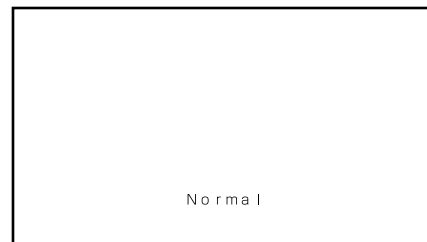

Normal mode



Wide1 mode

Note

- Displaying a picture in a Normal mode for extended periods of time may cause phosphor burn-in.
- A variety of picture modes are available with this display. Remember that if you select a mode with an aspect ratio (ratio of frame width to frame height) different from that of the TV program or video media, the pictures will appear differently than if you had selected a mode having the same aspect ratio.
- Showing a movie or similar premium event at a different aspect ratio from its original one at any event site, restaurant, or bar for profit-making purposes or for a public audience may constitute a copyright infringement.
For films, try to select a mode having the same aspect ratio as the original picture; this enables the director's original intentions to be preserved.

Reference

See P. E-22–E-23 for how to adjust the picture size and position.

SCREEN SIZE

Normal

Displays pictures of normal size (i.e., a 4:3 aspect ratio).

Auto

The screen size changes automatically in accordance with the contents of image software you use.

Wide1

Displays natural-looking pictures of standard size on the wide screen.

Wide2/Wide

Ideal for displaying vertically extended pictures such as squeezed pictures.

Zoom1/Zoom

Enlarges horizontally extended pictures equally in all directions to maintain the aspect ratio constant.

Zoom2

Reduces the height of horizontally extended pictures with captions, without eliminating the caption. Only the height of pictures is reduced, not the height of the caption.

(Captions may not be easy to read, however, depending on the picture.)

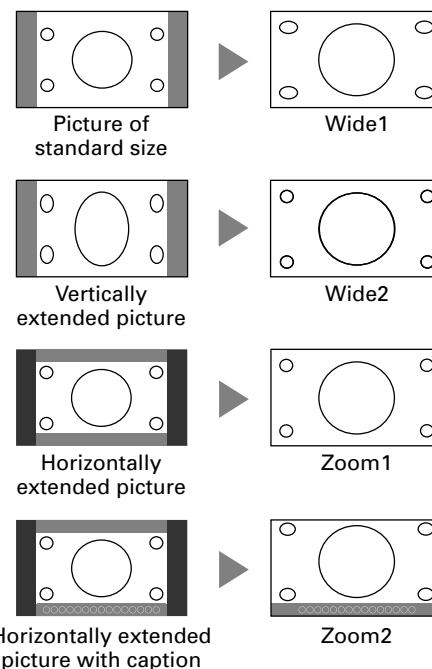

ASPECT RATIO

The following aspect ratios are available.

4:3 aspect ratio
(VHF/UHF broadcasting, BS broadcasting)

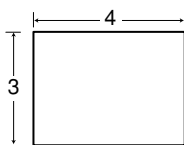

16:9 aspect ratio
(HDTV broadcasting)

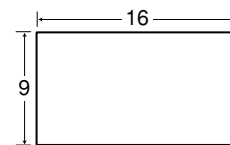

1.85:1 aspect ratio
(Vista Vision size)

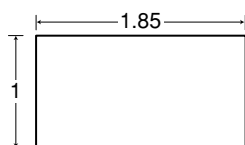

2.35:1 aspect ratio
(Cinema Vision size)

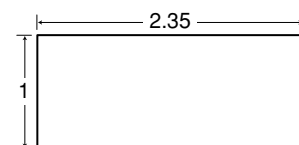

Information

You may find dark areas on top and at the bottom of the screen if you select one of the Zoom modes for media while using the Vista Vision or Cinema Vision size i.e., the sizes used frequently for picture software.

* Functions may not be available with some models and some device options.

ADJUSTMENT MENU

ADJUSTMENT MENU

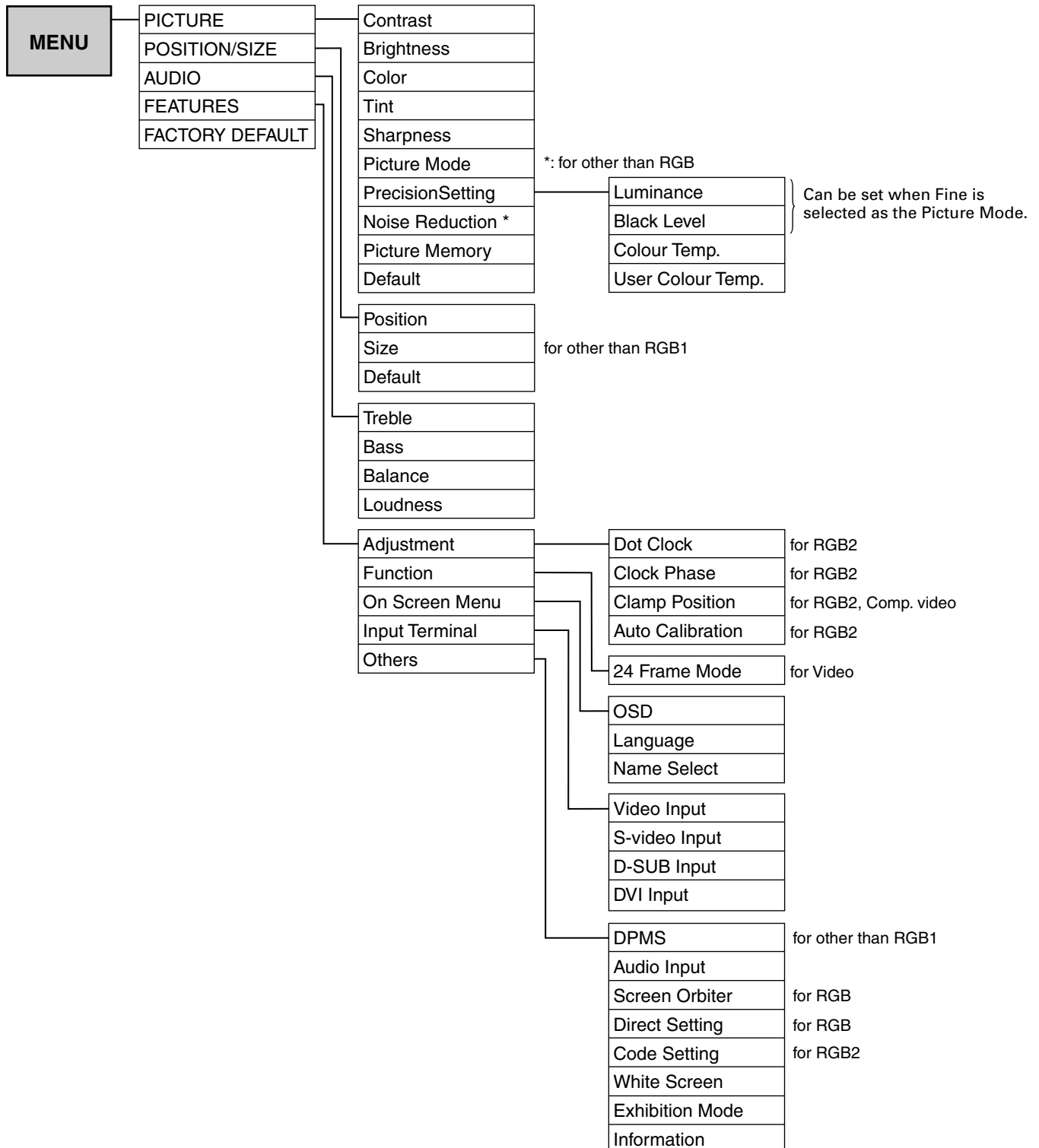

* Some type of signal can not be selected.

ADJUSTING PICTURES (PICTURE MENU)

BASIC OPERATIONS [EX.: ADJUSTING TINT (Tint)]

You can make changes to all picture adjustment options in the PICTURE Menu.

The changes you make will be stored for a selected input mode. Therefore, you need to select a desired input mode before making any changes.

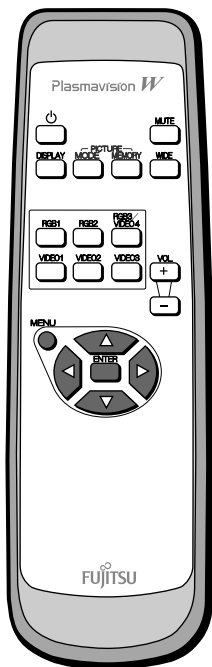

1 Press .
The main menu screen will appear.

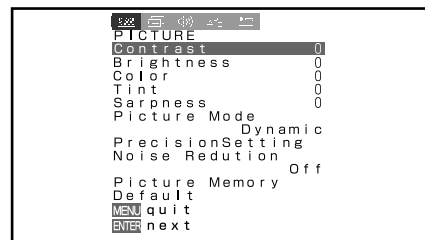

"PICTURE" selected in the main menu screen (Video Input Mode)

2 Press or to select "PICTURE".

Each time you press or , one of the available menus appears in the following sequence:

PICTURE ↔ POSITION/SIZE ↔ AUDIO ↔ FEATURES ↔ FACTORY DEFAULT

The PICTURE Menu screen will appear.

3 Press or to select "Tint".

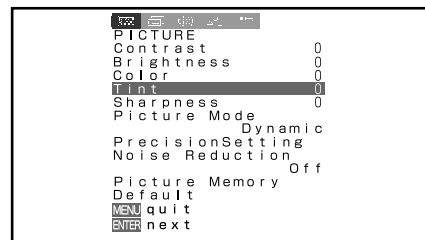

"Tint" selected in the PICTURE Menu screen (Video Input Mode)

4 Press .
The "Tint" adjustment screen will appear.

5 Press or to change tint values.

: More greenish colors

: More purplish colors

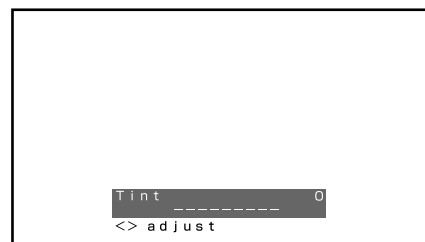

"Tint" adjustment screen

6 Press to store.

Press when you finish.

* Repeat steps 3, 4, 5 and 6 when you wish to make changes to other options.

* When is pressed after you have selected "Default", the settings are returned to those that were valid when you purchased the set.

* On-screen information disappears if you do not take any action for about 60 seconds.



* Functions may not be available with some models and some device options.

* The adjustment range varies with the display signal. You can adjust the display quality to the value you want within the adjustable range.

ADJUSTING PICTURES (PICTURE MENU) (Continued)



- **Contrast, brightness, color darkness, tint, and picture sharpness are adjusted as shown in the following chart.**

Select the item with  , and then adjust with  . Finally, press  to implement the adjustments.

Adjustment Item		
Contrast	Lower contrast	Higher contrast
Brightness	Darker screen	Brighter screen
Color	Lighter colors	Darker colors
Tint	More purplish colors	More greenish colors
Sharpness	Softer pictures	Sharper pictures

- **Setting Picture Mode (Picture Mode)**

Can set up the picture mode.

Each time you press  or , one of the available choices appears in the following sequence:

→ Natural ↔ Fine ↔ Effective ↔ Conventional ↔ Still ←

Natural: You can watch the natural color/high clear picture. Suitable for watching a normal motion picture. (Standard)

Fine: Suitable for watching a dark picture such as movie.

Effective: Makes a strong contrast picture.

Conventional: Makes close to a conventional TV picture.





Still: Suitable for watching a still picture.











Press  to store.

*Select Natural, Fine, Effective, Conventional or Still to suit your taste.

- **Precision Setting (for more advanced adjustment)**

Luminance, Black Level, Color Temperature, and User Color Temperature are adjusted as shown in the following chart.

Select the item with  , and then adjust with  . Finally, press  to implement the adjustments.

Adjustment Item	Contents of Adjustments	Operation
Luminance	Adjusts the luminance level. (when the Picture Mode is Fine)	Use   to adjust.
Black Level	Adjusts the picture when watching a dark image. (when the Picture Mode is Fine)	Use   to adjust.
Color Temperature	Set to low to obtain a warm atmosphere, and set to high to obtain a cold atmosphere.	Use   to adjust.
User Color Temperature	Enables individual adjustment of Red, Green and Blue.	Use   to select, and use   to adjust.



• Setting Noise Reduction (Noise Reduction)

Can select the noise reduction (This can make the flicker picture clear).

Each time you press ◀ or ▶, one of the available choices appears in the following sequence:



Off: Noise reduction does not function.

Min.: Weak setting

Std.: Standard setting

Max.: Strong setting

Press to store.

*Some type of signal can not be selected.

• Storing the setting of PICTURE (Picture Memory)

Stores 8 patterns of adjustments set by PICTURE.

Read out and store to suit your taste.

In case of "Load"

When setting "Load": Read out your desired Setting.

(1) Select "Picture Memory" and press .

The "Picture Memory" screen will appear.

(2) Press ◀ or ▶ to select Load.

(3) Select Data number to make Load.

(4) Press to read out.

In case of "Save"

When setting "Save": Set to suit your taste and store.

(1) Select "Picture Memory" and press .

The "Picture Memory" screen will appear.

(2) Press ◀ or ▶ to select Save.

(3) Select Data number to make Save.

(4) Press to save.

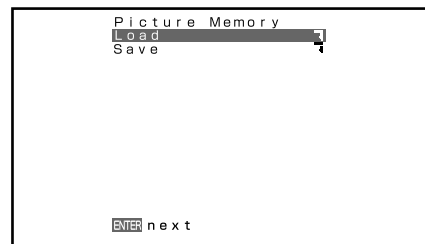

"Picture Memory" selection screen

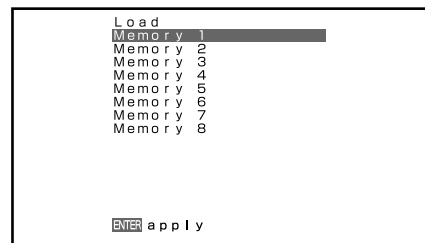

"Load" selection screen

* On-screen information disappears if you do not take any action for about 60 seconds.

* Functions may not be available with some models and some device options.

* The adjustment range varies with the display signal. You can adjust the display quality to the value you want within the adjustable range.

ADJUSTING SCREEN POSITION AND SIZE (POSITION/SIZE MENU)

BASIC OPERATION [EX.: ADJUSTING HORIZONTAL DIRECTION OF SCREEN POSITION]

You can make changes to all screen adjustment options in the POSITION/SIZE Menu.

The changes you make will be stored for the selected input mode. Therefore, you need to select a desired input mode before making any changes.

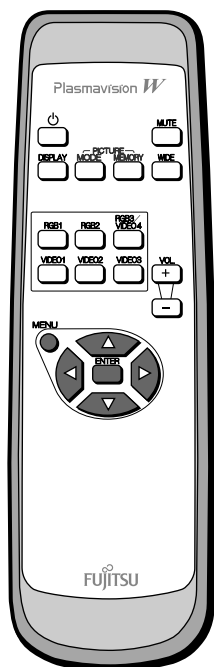

1 Press .

The main menu screen will appear.

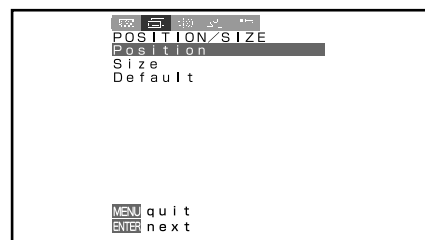

"POSITION/SIZE" selected from the main menu screen

2 Press or to select "POSITION/SIZE".

Each time you press or , one of the available menus appears in the following sequence:

PICTURE \leftrightarrow POSITION/SIZE \leftrightarrow AUDIO \leftrightarrow FEATURES \leftrightarrow FACTORY DEFAULT

The POSITION/SIZE Menu screen will appear.

3 Press or to select "Position".

4 Press .

The "Position" adjustment screen will appear.

5 Press , , or to change position values.

: Moves screen up.

: Moves screen down.

: Moves screen to the right.

: Moves screen to the left.

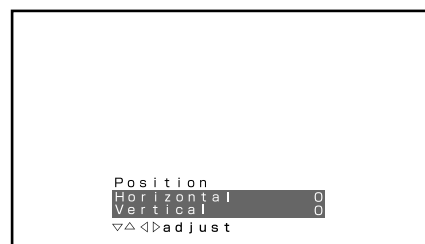

"Position" adjustment screen

6 Press to store.

Press when you finish.

* Repeat steps 3 to 6 when you wish to make changes to other options.

* When is pressed after you have selected "Default", the settings are returned to those that were valid when you purchased the set.



Adjusting Screen Position (Position)

Horizontal position (Horizontal)

▶ : Moves screen to the right.

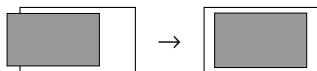

◀ : Moves screen to the left.

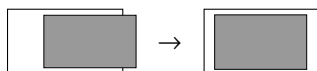

Vertical position (Vertical)

▲ : Moves screen up.

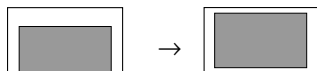

▼ : Moves screen down.



Press **ENTER** to store.

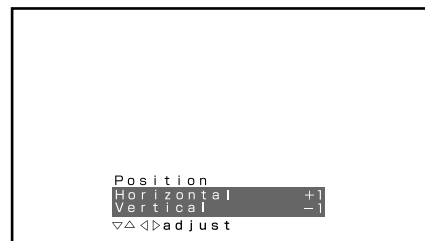

"Position" adjustment screen

Adjusting Screen Size (Size)

Screen width (Width)

▶ : Increases width.

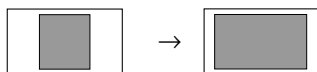

◀ : Reduces width.

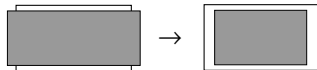

Screen height (Height)

▲ : Increases height.



▼ : Reduces height.

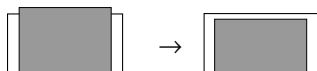

Press **ENTER** to store.

*You cannot adjust screen size in RGB1 (DVI-D) mode.



"Size" adjustment screen

* On-screen information disappears if you do not take any action for about 60 seconds.
* Functions may not be available with some models and some device options.
* The adjustment range varies with the display signal. You can adjust the display quality to the value you want within the adjustable range.

ADJUSTING AUDIO (AUDIO MENU)

BASIC OPERATION [EX.: ADJUSTING VOLUME BALANCE (Balance)]

You can make changes to all audio adjustment options in the AUDIO Menu.

The changes you make will be stored for the selected input mode. Therefore, you need to select a desired input mode before making any changes.

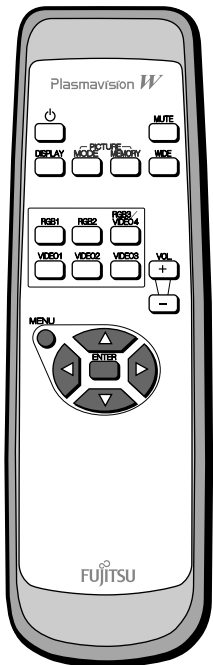

1 Press .

The main menu screen will appear.

2 Press or to select "AUDIO".

Each time you press or , one of the available menus appears in the following sequence:

PICTURE \leftrightarrow POSITION/SIZE \leftrightarrow AUDIO \leftrightarrow FEATURES \leftrightarrow FACTORY DEFAULT

The AUDIO Menu screen will appear.

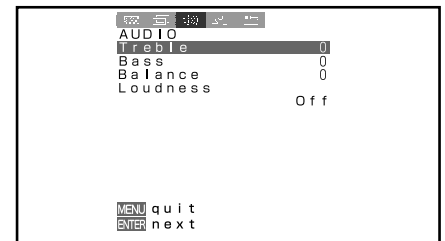

"AUDIO" selected in the main menu screen

3 Press or to select "Balance".

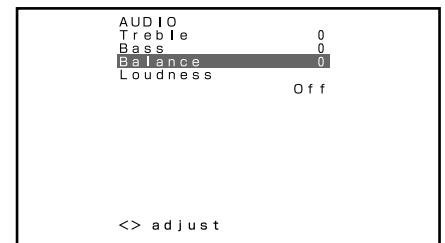

"Balance" selected in the AUDIO Menu screen

4 Press .

The "Balance" adjustment screen will appear.

5 Press or to adjust the balance.

: Higher volume from the right-hand speaker

: Higher volume from the left-hand speaker

6 Press to store.

Press when you finish.

* Repeat steps 3 to 6 when you wish to make changes to other options.

* Audio Input menu will not be displayed when "No Audio" is selected. (See P. E-30.)



Adjusting Treble (Treble)

Press to make adjustments.

: Stronger treble

: Weaker treble

Adjusting Bass (Bass)

Press to make adjustments.

: Stronger bass

: Weaker bass

Adjusting Volume Balance (Balance)

Press to make adjustments.

: Higher volume from the right-hand speaker

: Higher volume from the left-hand speaker

Setting Loudness (Loudness)

Corrects the balance between bass and treble for easy listening even with weak volume.

Each time you press or , one of the available choices appears in the following sequence:

On Off

On : Corrects bass and treble.

Off : Loudness dose not function.

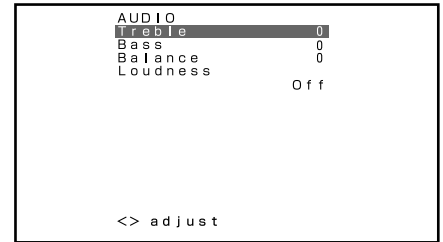

AUDIO Menu screen

* On-screen information disappears if you do not take any action for about 60 seconds.

* Functions may not be available with some models and some device options.

* The adjustment range varies with the display signal. You can adjust the display quality to the value you want within the adjustable range.

OTHER ADJUSTMENTS (FEATURES MENU)

BASIC OPERATION [EX.: SELECTING LANGUAGE (Language)]

You can make the following changes in the FEATURES Menu.

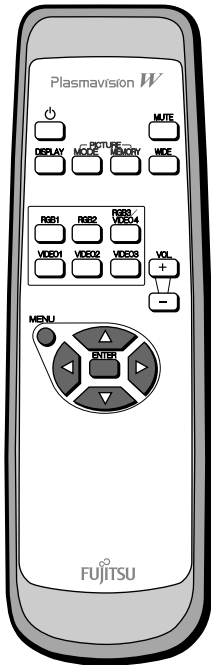

1 Press .
The main menu screen will appear.

2 Press or to select "FEATURES".

Each time you press or , one of the available menus appears in the following sequence:

PICTURE \longleftrightarrow POSITION/SIZE \longleftrightarrow AUDIO \longleftrightarrow FEATURES \longleftrightarrow FACTORY DEFAULT

The FEATURES Menu screen will appear.

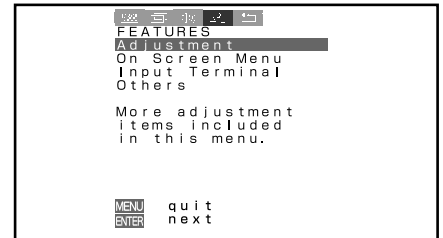

"FEATURES" selected in the main menu screen

3 Press or to select "On Screen Menu".

- Select a desired option for adjustment/setup from Adjustment, Function, On Screen Menu, Input Terminal and Others.

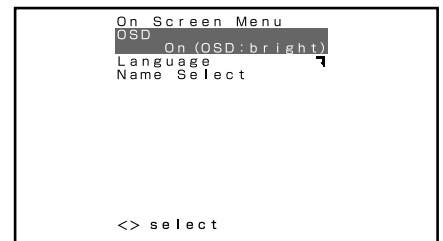

On Screen Menu screen

4 Press .
• On Screen Menu appears.

5 Press or to select "Language".



"Language" selection screen

6 Press .
The "Language" selection screen will appear.

7 Press or to select the language.

8 Press .
The menu is displayed in the selected language.

Press when you finish.

* Repeat steps 3 to 8 when you wish to make changes to other options.

• **FEATURES setup screen has the following 5 options.**

- Adjustment : Can make a fine adjustment of pictures such as Dot Clock, Clamp Position.
- Function : Allows setting of 24-frame mode. (See P. E-28.)
- On Screen Menu : Can make a display setting such as OSD, Language. (See P. E-28.)
- Input Terminal : Can make an input terminal setting such as Video Input. (See P. E-29.)
- Others : Can make other settings. (See P. E-30–E-32.)

ADJUSTMENT

Dot Clock, Clock Phase, Clamp Position, and Auto Calibration are adjusted as shown in the following chart.

Select the item with , and then adjust with . Finally, press to implement the adjustments.

Adjustment Item	Contents of Adjustments	Operation
Dot Clock (RGB2)	You may find the vertically-striped pattern in pictures, depending on the clock frequency of your PC's processor. If you experience blurring, you can obtain a clearer picture by adjusting the "Dot Clock".	Use to adjust to minimize vertically-striped pattern in pictures.
Clock Phase (RGB2)	Pictures and the outline of letters may blur or flicker as the clock phase of your PC may be different. In this case, adjust the clock phase manually. Normally, the automatic setting ensures the optimal value.	Use to adjust to minimize pictures blur.
Clamp Position (RGB2, Comp. video)	Adjusts the extremely dark or bright pictures. Normally, the automatic setting ensures the optimal value.	Use to adjust pictures optimally.
Auto Calibration (RGB2)	Adjusts the dynamic range of images to the optimum. Performed while a white screen signal is received.	Display the Auto Calibration screen and select Execute, and then use to select the item.

* On-screen information disappears if you do not take any action for about 60 seconds.

* Functions may not be available with some models and some device options.



* The adjustment range varies with the display signal. You can adjust the display quality to the value you want within the adjustable range.

OTHER ADJUSTMENTS (FEATURES MENU) (Continued)

FUNCTION

• Displaying the optimum movie pictures (24 Frame Mode) for Video

Can make the optimum display of 24 frames/second signals such as movie pictures.

Each time you press  or , one of the available choices appears in the following sequence:

On  Off

On : Displays the optimum movie pictures.

Off : Displays normal pictures.



Press  to store.





* Some type of signal can not be selected.

ON SCREEN MENU

• Setting Display Information (OSD)

You can use this option to select whether to display information other than menus. (Error messages are displayed regardless of what choice you make for this option.)

Each time you press  or , one of the available choices appears in the following sequence:

 On(OSD:bright)  On(OSD:dark)  Off 

On (OSD:bright): On-screen information shown in light color.

On (OSD:dark): On-screen information shown in dark color.

Off: Except for menus and error messages, on-screen information is not displayed.



Press  to store.

• Selecting Language (Language)

You can use this option to select the language displayed on the screen.

(1) Select "Language" and press .

The "Language" selection screen will appear.

(2) Press  or  to select your desired language.

日本語 (Japanese)

English

Deutsch (German)

Español (Spanish)

Français (French)

Italiano (Italian)

Português (Portuguese)

(3) Press .

The menu is displayed in the selected language.



• Selection of indications

You can change the settings for indications for video inputs and RGB inputs.

Video input

You can change the settings for indications for the VIDEO inputs.

Select the desired indication in accordance with the connected equipment.

Each time   is pressed, the setting is switched. (In the case of VIDEO1)



 Video1  DVD1  DVD2  VCR1  VCR2  GAME  Camcorder  STB  Satellite  Cable TV 









Press  to store.

RGB input

You can change the settings for indications for the RGB inputs.

Select the desired indication in accordance with the connected equipment.

Each time   is pressed, the setting is switched. (In the case of RGB 1)

 RGB1  PC1  PC2  DVD1  DVD2  STB  Satellite  Cable TV 

Press  to store.

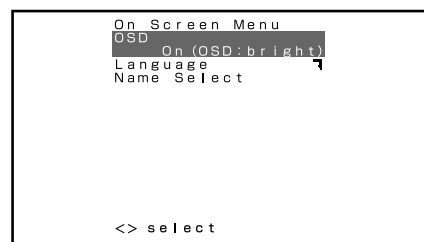

OSD selection screen



"Language" selection screen

SETTING THE INPUT TERMINALS

• Selecting the settings of Video/S-video Input terminal

You can use this option to select the color format appropriate for the input signal.

Each time you press or , one of the available modes appears in the following sequence:

→Auto1↔Auto2↔NTSC↔PAL↔SECAM↔PAL60↔N-PAL↔M-PAL↔4.43NTSC←

Auto1: Automatically selects NTSC, PAL and SECAM.

Auto2: Automatically selects NTSC and M-PAL.

Other than Auto: You need to select a system appropriate to the input signal.

Press to store.

• Selecting the settings of D-SUB Input terminal

You can use this option to select the signal system it will receive to D-SUB Input terminal.

(1) Select D-SUB Input and press .

D-SUB Input screen appears.

(2) Select the signal system to receive.

Each time you press or , one of the available choices appears in the following sequence:

RGB-PC ↔ Decoder

RGB-PC: For using RGB for PC

Decoder: For using digital broadcast tuner

(3) Press or to select Mask.

(4) Select Decoder by FUNCTION to set up Mask.

Each time you press or , one of the available choices appears in the following sequence:

→Off ↔ 5 ↔ 10 ↔ 15←

Off: Does not mask.

Number: Masks the fringe (top, bottom, right and left) of the screen by the number of pixels specified.

(5) Press to store.

• Selecting the settings of DVI-D Input terminal

You can select the signal method input to the DVI input terminal.

Each time or is pressed, the setting is changed.

DVI1 ↔ DVI2

DVI1: Used when connecting to a PC.

DVI2: Used when connecting to a DVD player or digital tuner.

Press to store.

* Set according to the signal method before connecting peripheral device.

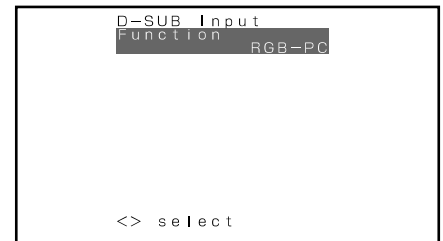

“D-SUB Input” selection screen

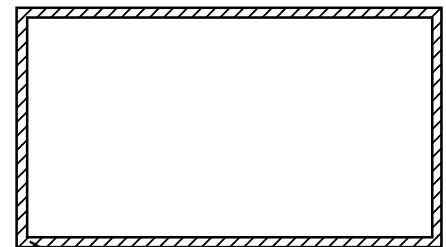

This fringe part is masked.

* On-screen information disappears if you do not take any action for about 60 seconds.

* Functions may not be available with some models and some device options.

* The adjustment range varies with the display signal. You can adjust the display quality to the value you want within the adjustable range.

OTHER ADJUSTMENTS (FEATURES MENU) (Continued)

OTHER SETTINGS

DPMS

for other than RGB1

You can use this option to select the amount of time before the DPMS function starts.

DPMS (which stands for “display power management signaling”) allows the display to maintain an automatic power saving function.

This function causes on-screen information to disappear until the next input operation, if the power is ON and the display has not received any signals for the predetermined period of time. When DPMS is active, the power indicator lamp turns orange.

- (1) Select DPMS and press .

DPMS screen appears.

- (2) Press  or  to select Time.

- (3) Each time you press  or , one of the available choices appears in the following sequence:

➔ Off ↔ 1min. ↔ 15min. ↔ 45min. ↔ 60min. ←



Off: Disables DPMS



Number: Approximate time before DPMS starts. (Unit: minutes)

* The power indicator lamp turns orange while the DPMS is ON.

* The power turns ON automatically when the display receives a signal.

- (4) Can specify background colour.

Press  or  to select background colour.

Each time you press  or , one of the available choices appears in the following sequence:

Black ↔ White

Black: Mutes images in Black background.

White: Mutes images in White background.

* Switches approx. 20 seconds after the display stops receiving signals.

- (5) Press  to store.

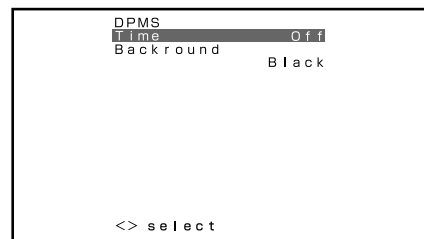



DPMS selection screen

• Selecting input terminals (Audio Input)



You can use this option to select the available terminals to receive the audio from input equipment.

- (1) Select “Audio Input” and press .

The “Audio Input” selection screen will appear.

- (2) Press  or  to select video input terminal.

- (3) Select a related audio input terminal.

Each time you press  or , one of the available choices appears in the following sequence:

➔ No Audio ↔ Audio 1 ↔ Audio 2 ↔ Audio 3 ←

No audio: No audio in the corresponding mode.

Audio 1-3: Selects Audio 1 through 3 for receiving audio in the corresponding mode.

* Repeat steps (2) and (3) for each piece of input equipment.

- (4) Press  to store.

*Audio Input menu will not be displayed when "No Audio" is selected.

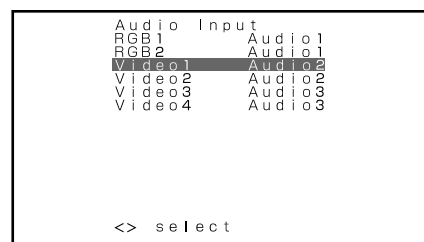

“Audio Input” selection screen

• Minimizing phosphor burn-in (Screen Orbiter) for RGB

You can use this option to move the screen position to minimize phosphor-induced “burn-in”.

Follow the steps below.

- (1) Select “Screen Orbiter” and press .

The “Screen Orbiter” setting screen will appear.

- (2) Press or to select “Mode/Time”.
 (3) Select a desired pattern.

Each time you press or , one of the available choices appears in the following sequence:

Off: Disables Screen Orbiter.

Time: Moves the pattern approximately every one hour.

Mode: Moves the pattern when the power is turned ON or when you switch between modes.

- (4) Press or to select “Moving Area”.
 (5) Press or to select the range for moving the pattern.

Each time you press or , one of the available choices appears in the following sequence:

Min.: Pattern moves in small range. (About 5 pixels)

Std.: Pattern moves in moderate range. (About 10 pixels)

Max.: Pattern moves in wide range. (About 15 pixels)

- (6) Press to store.

* When the Screen Orbiter function is operated in RGB1 mode, some letters at the top, bottom, right or left of the screen may be missed.

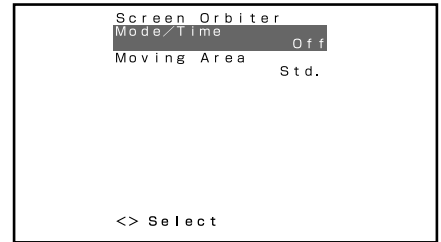

“Screen Orbiter” setting screen

• Setting RGB Input Signal Compulsorily (Direct Setting) for RGB

You can use this option to switch the setting for RGB input signal.

Each time you press or , one of the available choices appears in the following sequence:

For RGB1 mode:

For RGB2 mode:

Auto: The optimum display is obtained automatically for input signals.

Others: The optimum resolution setting is fixed for each signal.

Press to store.

* In Auto mode, the resolution of VGA, WVGA, 480P, XGA, WXGA, SXGA and SXGA+ may not be automatically distinguished. Switch to the fixed display when the image is not displayed properly.

* On-screen information disappears if you do not take any action for about 60 seconds.

* Functions may not be available with some models and some device options.

* The adjustment range varies with the display signal. You can adjust the display quality to the value you want within the adjustable range.

OTHER ADJUSTMENTS (FEATURES MENU) (Continued)

• Specifying RGB Input Signal (Code Setting)

for RGB2

Normally, use this option in Auto mode.

• Displaying white over entire screen (White Screen)

You can use this option to display white over the entire screen to minimize phosphor burn-in.

Each time you press  or , one of the available choices appears in the following sequence:

On  Off



Off: Does not display white.

On: Displays a white screen immediately.

Press  to store.

• Setting Exhibition Mode (Exhibition Mode)

You can use this option to display the enhanced contrast, which is most suitable for the use by unspecified persons.

Each time you press  or , one of the available choices appears in the following sequence:

On  Off

On: Sets up Exhibition mode.

Off: Sets up normal mode.

Press  to store.

* In Exhibition mode, the display returns to the original setting in about 5 minutes even if the adjustment is changed.

* The setup will be cancelled when removing the power plug from the receptacle.

• Displaying System Status (Information)

Displays system operation status.

Select "Information" and press .

The "Information" screen will appear.

Mode: Input mode appears at the upper right corner of the screen.

Freq. Scan Mode: Frequency scanning

Input Signal: Video mode

Input Sync.: Signal type

Freq.: Synchronized signal frequency, polarity

Preset No.: RGB code number

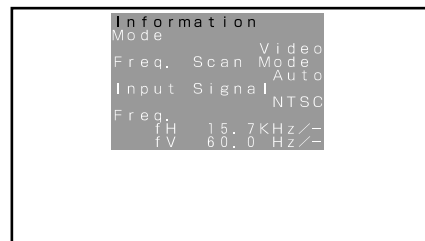

Information screen (Video Mode)

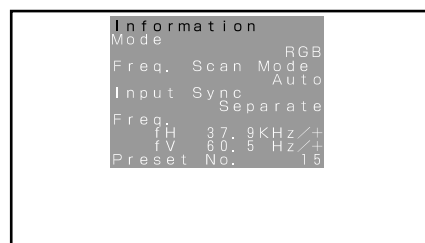

Information screen (RGB Mode)

* On-screen information disappears if you do not take any action for about 60 seconds.

* Functions may not be available with some models and some device options.

* The adjustment range varies with the display signal. You can adjust the display quality to the value you want within the adjustable range.

INITIALIZATION OF USER ADJUSTMENT VALUE (FACTORY DEFAULT)

You can restore the values of the adjustment/setting made in the MENU to factory settings.

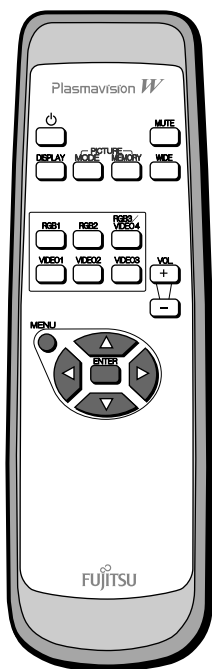

1 Press .
The main menu screen will appear.

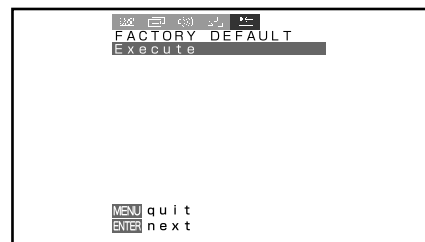

2 Press or to select "FACTORY DEFAULT".

Each time you press or , one of the available menus appears in the following sequence:

PICTURE ↔ POSITION/SIZE ↔ AUDIO ↔ FEATURES ↔ FACTORY DEFAULT

The FACTORY DEFAULT Menu screen will appear.

"FACTORY DEFAULT" selected in the main menu screen

3 Press .

- Displays the message of whether to proceed with the initialization.

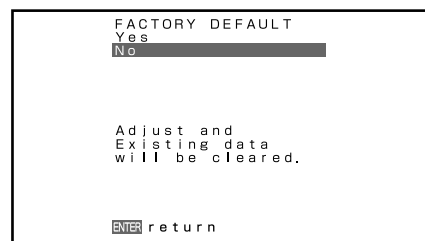

Displays the message of whether to proceed the initialization

4 Press or to select the Yes.

5 Press .

- The message of having completed the initialization will be displayed after initializing.

Press when you finish.



Displays the message of having completed the initialization

CLEANING AND MAINTENANCE

Precautions

Be sure to remove the power plug from the receptacle before cleaning the display.

Be sure not to clean the display using a cloth dampened with volatile solvents, such as benzene or thinner. Such solvents can harm the display's cabinet, the filter at the screen front, and the remote control. They can also cause paint to come off these sections.

Cleaning the Screen

Clean the screen gently with a soft cloth.

The screen surface is fragile. Never attempt to clean it with a hard material, press on it forcefully, or tap it.

Cleaning the Cabinet and Remote Control

Use a soft cloth for cleaning.

If the cabinet or remote control is heavily stained, soak a soft cloth in a mixture of water and detergent and squeeze it dry before wiping off the stains. Use a soft, dry cloth for final cleaning.

Cleaning the ventilation grille

Remove dust from the ventilation grille in the rear of the main unit periodically with a vacuum cleaner as the accumulated dust can increase the internal temperature of the main unit causing machine failure or fire hazard.

HANDY TIPS

In the event of problems with the display, check the following explanations before contacting your dealer for servicing.

Problem	Action
• Power does not turn ON.	• Check whether the power plug is securely inserted into the receptacle.
• No pictures are displayed.	• Check cables for disconnection. • Check whether the power for all input equipment is ON. • Check for connection to wrong terminals or for wrong input mode. • Check whether the input mode display is colored pink. Special setup may have been made. Return to original setup or initialize the User adjustment value.
• Remote control does not function properly.	• Check for incorrect battery orientation. • Check for dead batteries. • Check for distance from the display. • Check whether you are pointing the remote control transmitter properly at the display's receiver. • Check for any obstacle between the remote control and the display.
• The display makes a snapping sound.	• This sound is produced when the cabinet expands or contracts due to variations in temperature. This sound does not indicate that the display has a problem.
• The display makes a buzzing sound.	• The display has fans to maintain the temperature of internal components at a constant level. This sound is produced by the fan as it rotates.
• There are spots on the screen.	• Check whether your AV equipment is affected by interference from automobiles, trains, high-voltage transmission lines, neon signs or other potential sources of interference.
• Degraded colors/tints	• Check whether all picture adjustments have been properly made. (See "Adjusting Pictures" on P. E-19-E-21.)
• Improper screen position/size	• Check whether screen position and size have been properly adjusted. (See "Adjusting Screen Position and Size" on P. E-22-E-23.)
• No audio from external speakers	• Check cables for disconnection.
• No audio	• Check whether you have selected "No Audio" for the "Audio Input" setting. Check whether the proper audio input have been selected. (See "Features" on P. E-30.)
• If "Out of range" appears, the display is receiving a signal whose picture or signal cannot be reproduced by the display. • The screen turns to black and white.	• Input proper signals. Make sure to check the vertical frequency of the input signal. (See the user's manual (1/2))
• If "Error message Condition 1" appears, the fan is defective.	• Remove the power plug from the receptacle, and contact your dealer for repairs.
• If "Error message Condition 2" appears, the display's internal components are extremely hot.	• Remove the power plug from the receptacle. (You can turn the power back ON again when the components have cooled sufficiently.) If the message appears again when you turn the power back on, remove the power plug from the receptacle, and contact your dealer for a repairs.
• If "Change refresh rate to 60Hz" appears,	• The picture may get blurred with vertical frequency of other than 48.3-51.8 or 58.4-61.4 (Hz). Change the setting of your PC, etc.
• If the power indicator lamp flashes red or green.	• Remove the power plug from the receptacle, and inform your dealer about how the lamp flashed. The power indicator lamp flashes differently depending on the type of problem.

* Functions may not be available with some models and some device options.