

Haier®

TFT-LED LCD TV OWNER'S MANUAL

Please READ this manual carefully before operating your TV, and keep it for future reference.

Haier

Haier

MODELS :
LE26B13200
LE32B13200

The Haier logo consists of a solid grey square with the word "Haier" written in white, sans-serif font inside it.

Contents

Safety and warnings.....	2-3
Introduction.....	4
Stand installation guide.....	5
Installation.....	6-9
Remote Control.....	10
Operation.....	11-15
Trouble Shooting.....	16
Warranty.....	17

IMPORTANT SAFETY INSTRUCTION

- 1) Read these instructions.
- 2) Keep these instructions.
- 3) Heed all warnings.
- 4) Follow all instructions.
- 5) Do not use this apparatus near water.
- 6) Clean only with dry cloth.
- 7) Do not block any ventilation openings, install in accordance with the instructions.
- 8) Do not install near any heat sources such as radiations, heat registers, stoves, or other apparatus (including amplifiers) that produce heat.
- 9) Do not defeat the safety purpose of the polarized plug. If the provided plug does not fit into your outlet, consult an electrician for replacement of the obsolete outlet.
- 10) Protected the power cord from being walked on or pinched particularly at plugs, convenience receptacles, and the point where they exit from the apparatus.
- 11) Only use attachments/accessories specified by the manufacturer.
- 12) Unplug this apparatus during lightning storms or when unused for long periods of time.
- 13) Refer all servicing to qualified service personnel. Servicing is required when the apparatus has been damaged in any way, such as power-supply cord or plug is damaged, liquid has been spilled or objects have fallen into the apparatus, the apparatus has been exposed to rain or moisture, does not operate normally, or has been dropped.
- 14) Mains plug is used as the disconnect device, the disconnect device shall remain readily operable.
- 15) The ventilation should not be impeded by covering the ventilation openings with items, such as newspapers, table-cloth, curtains, etc.
- 16) No naked flame sources, such as lighted candles, should be placed on the apparatus.
- 17) Attention should be drawn to the environmental aspects of battery disposal.
- 18) The use of apparatus in moderate climate.
- 19) The apparatus shall not be exposed to dripping or splashing and that no objects filled with liquids, such as vases, shall be placed on the apparatus.



The symbol indicates that dangerous voltages constituting a risk of electric shock are present within this unit.



The symbol indicates that there are important operating and maintenance instructions in the literature accompanying this unit.

WARNING:
To reduce the risk of fire or electric shock, do not expose this apparatus to rain or moisture.

WARNING:
The batteries shall not be exposed to excessive heat such as sunshine, fire or the like.

WARNING:
The excessive sound pressure from earphones and headphones can cause hearing loss.



This symbol indicates that this product incorporates double insulation between hazardous mains voltage and user accessible parts. When servicing use only identical replacement parts.



This marking indicates that this product should not be disposed with other household wastes throughout the EU. To prevent possible harm to the environment or human health from uncontrolled waste disposal, recycle it responsibly to promote the sustainable reuse of material resources. To return your used device, please use the return and collection systems or contact the retailer where the product was purchased. They can take this product for environmental safe recycling.

<div style="display: inline-block; border: 1px solid black; padding: 2px; text-align: center; font-size: 8px;"> CAUTION RISK OF ELECTRIC SHOCK DO NOT OPEN! </div>
CAUTION TO REDUCE THE RISK OF ELECTRIC SHOCK, DO NOT REMOVE COVER (OR BACK). NO USER SERVICEABLE PARTS INSIDE. REFER SERVICING TO QUALIFIED SERVICE PERSONNEL.

Haier is committed to safely recycling electronic products and product materials. Please check for a local recycling location in the United States at: 1800RECYCLING.COM or call 1.800.RECYCLING.

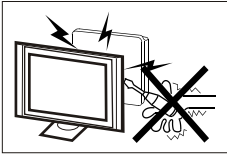

High voltages are used in the operation of this television receiver. Do not open the cabinet. Refer servicing to qualified service personnel.

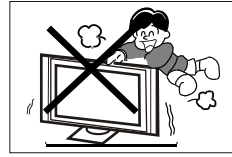

Never stand on, lean on, or suddenly push the television or its stand. You should pay special attention to children. Serious injury may result if it falls.

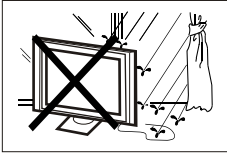

To prevent fire or electrical shock hazard, do not expose the television receiver to rain or moisture.

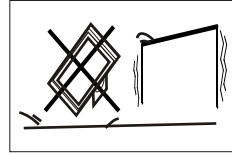

Do not place your television on an unstable cart, stand, shelf or table. Serious injury to an individual and/or damage to the television may result if it falls.

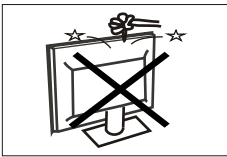

Do not drop or push objects into the television cabinet slots or openings. Never spill any kind of liquid on the television receiver.

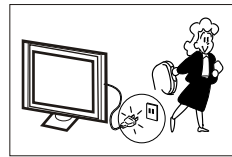

When the television receiver is not used for an extended period of time, it is advisable to disconnect the AC power cord from the AC outlet.

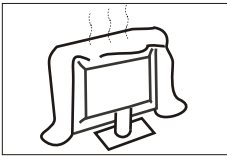

Do not block the ventilation holes on the back cover of the TV. Adequate ventilation is essential to prevent failure of electrical components.

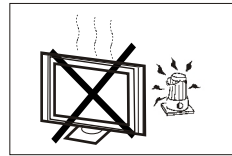

Avoid exposing the television receiver to direct sunlight and other sources of heat. Do not stand the television receiver directly on other products which give off heat, e.g. video cassette players and audio amplifiers. Do not place naked flame sources, such as lighted candles on or near the television.

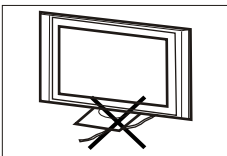

Do not trap the power supply cord under the television receiver's stand.

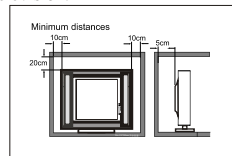

If the television is to be built into a compartment or similar enclosure, the minimum distances must be maintained. Heat build-up can reduce the life of your television, and can also be dangerous.

Main features

- Integrated ATSC TV tuner for HDTV broadcast reception
- High brightness provides a vivid and brilliant picture
- Deeper blacks and brighter whites with high contrast
- Wide Screen aspect ratio (16:9) for a complete home theater experience
- HDMI input for true digital connection
- VGA port for connection to PC
- Built-in stereo speaker system
- Full-function Remote Control

Accessories

Power Cable.....	1
Infrared Remote Control.....	1
User's Manual	1
Battery(AAA).....	2

Main parameter

Viewing Picture Size (diagonal)	26 inches	32 inches
Resolution:	1366x768	1366x768
Power consumption:	55W	90W
Audio Output Power (THD ≤ 7%):	2x5W	2x8W
Input Power Voltage:	AC 100V-240V 50/60Hz	
Aspect Ratio:	16:9	
TV System:	ATSC Digital system and NTSC Analog system	
Video Signal System:	NTSC	
Receiving Channel:	Cable :1-135/ Air: 2-69 (ATV&DTV)	
High-Definition Multimedia Interface (HDMI) Input	x 2	
YCb(Pb)Cr(Pr) Input	x 1	
Composite Video Input	x 1	
Analog RGB (VGA) Input	x 1	
Audio Input	x 2	
Headphone Output	x 1	
Coaxial Output	x 1	
USB Input	x 1	
Horizontal definition (TV line)	Composite Video Input ≥350 Video Input ≥400 YCb(Pb)Cr(Pr) ≥400	

Base Stand Assembly Instruction

1. Attach the base stand neck to the base stand bottom with the included 3 screws.

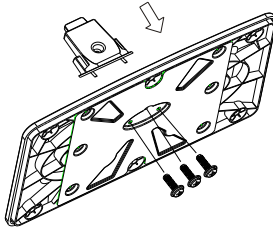

2. Place the TV with the display side down on a flat surface. Use a cloth or the material from the TV packaging to protect the screen.

3. Place the base stand neck in the slot on the bottom of the TV and push firmly upwards. Attach with the included screw.

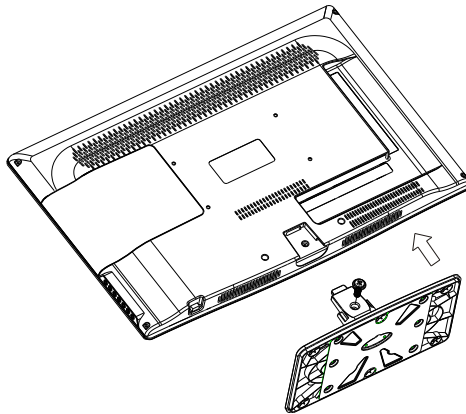

Front panel

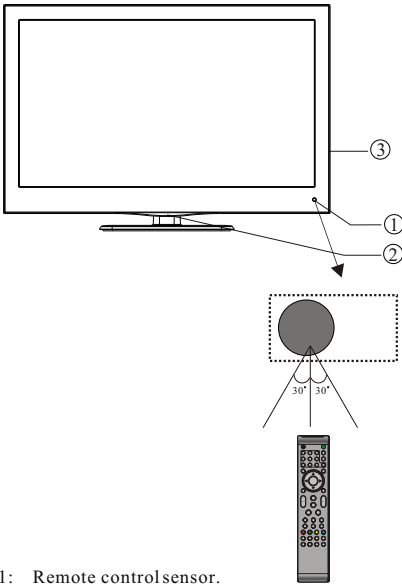

- 1: Remote control sensor.
- 2: Indicator LED: BLUE ● POWER ON.
RED ● STANDBY.
- 3: Side panel keys

Side panel

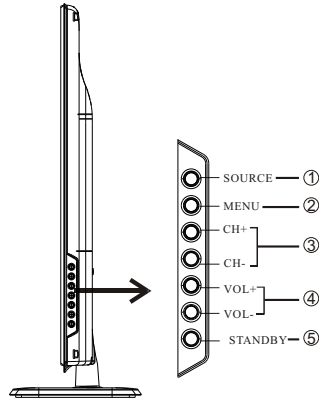

- 1. **SOURCE:** Display the input source menu.
- 2. **MENU:** Display main MENU.
- 3. **CH+/CH-:** In TV mode, press "CH+" or "CH-" to change the channel up and down. In MENU mode, press "CH+" or "CH-" to select items in standby mode, press "CH+" or "CH-" to turn on the TV.
- 4. **VOL+/VOL-:** Adjust sound level. In MENU mode, press "VOL+" or "VOL-" to adjust the item that you selected.
- 5. **STANDBY:** Press this button to turn the unit ON from STANDBY mode. Press it again to turn the set back to STANDBY.

REAR Connections



All the terminals are (from left to right):
POWER SOCKET, VIDEO, AUDIO INPUT, YPbPr INPUT
Note: AV and YPbPr share one audio channel.

SIDE Connections



All the terminals are (from left to right):
HDMI1, HDMI2, USB, VGA, HEADPHONE, PC AUDIO, COAXIAL, RF.
Note: 1. When HDMI1 port get DVI signal ,the audio signal receives from the PC Audio channel.
2. When HDMI2 port get DVI signal ,the audio signal receives from the YPbPr/AV Audio channel.

ANTENNA

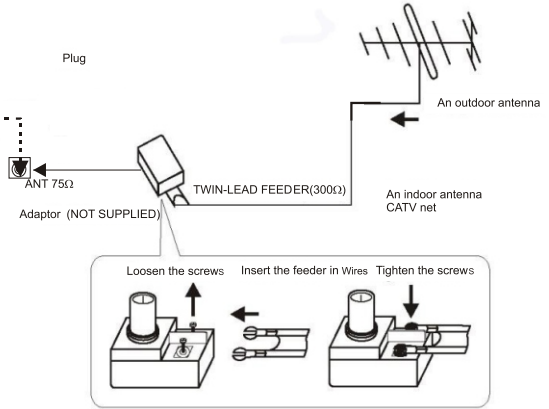
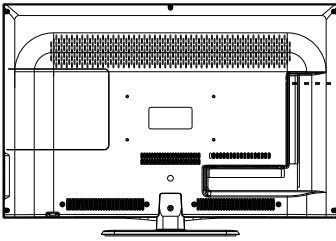

Note:
Aerial connections:IEC(female).
Input impedance:75Ω unbalanced.

PC

STEPS:

Be sure both the TV and computer are set to Power off.

- 1.Connect VGA and audio cable.
- 2.Connect the power cord.
- 3.Power on the TV, switch to PC mode.
- 4.Power on the PC.

This sequence is very important.

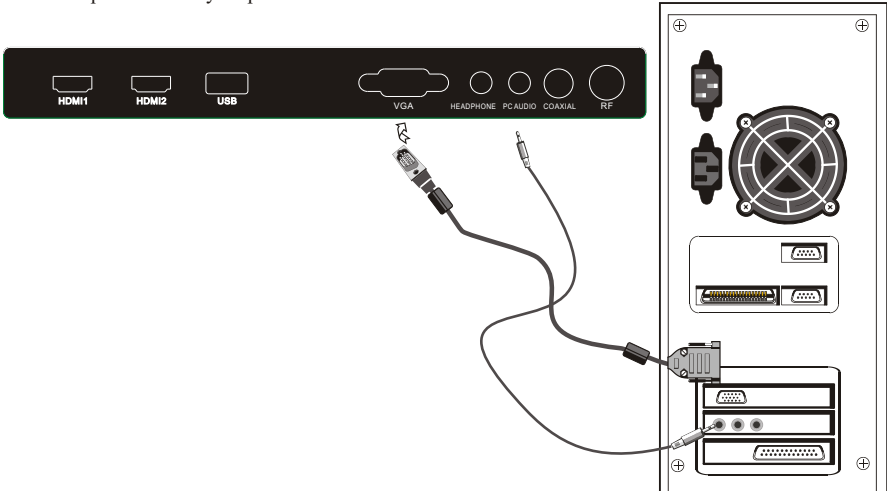

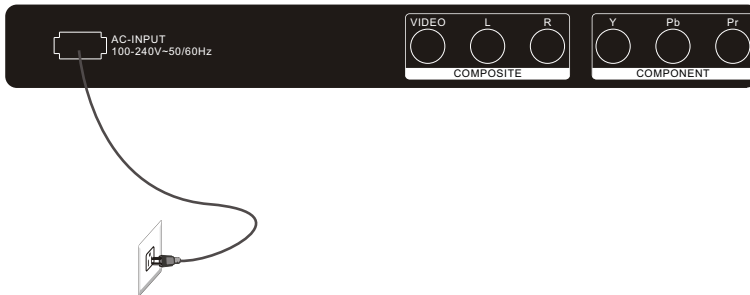

PC

PRESET MODE

	RESOLUTION	V.Freq.(Hz)	H.Freq.(KHz)
1	720*400	70	31.47
2	640*480	60	31.47
3	640*480	75	37.50
4	800*600	60	37.88
5	800*600	75	46.88
6	1024*768	60	48.36
7	1024*768	70	56.48
8	1024*768	75	60.02
9	1280*1024	60	63.98
10	1280*1024	75	80.00

AV EQUIPMENT

You can use the input terminals on TV set rear as follows.

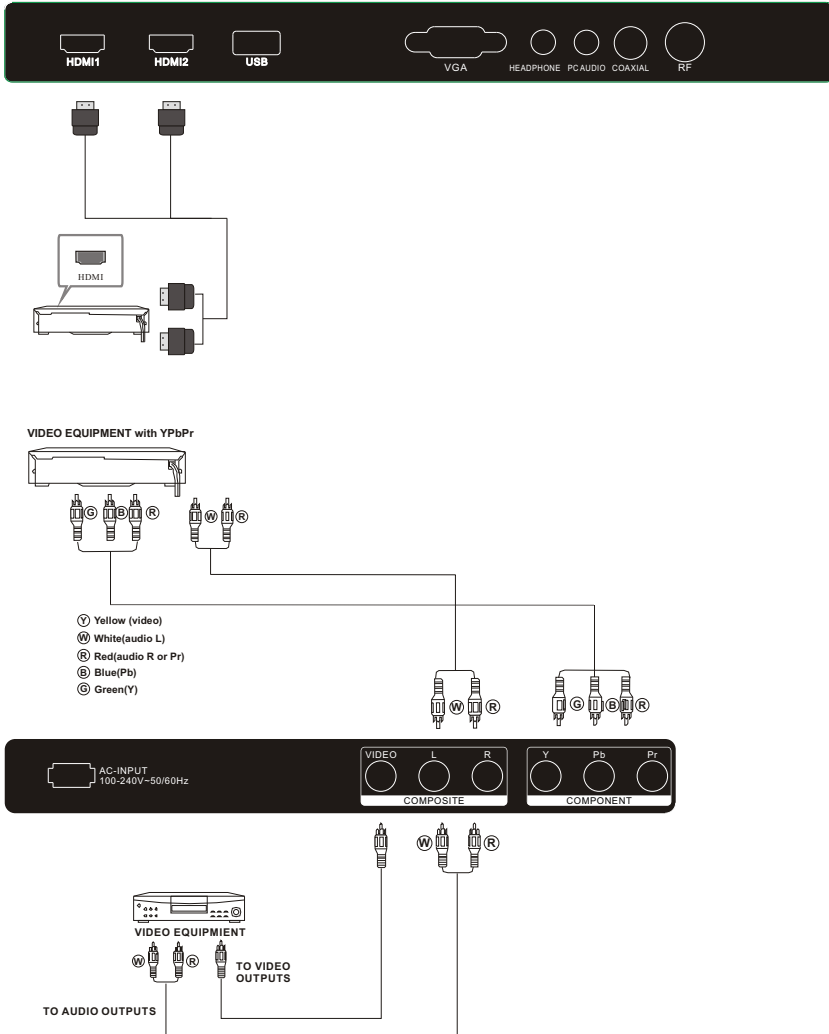

It can be connected to the following appliances: VCR, multi disc player, DVD, camcorder, video game or stereo system, etc.....
 YPbPr can support these video formats:480i,576i,480p,576p,720p,1080i.

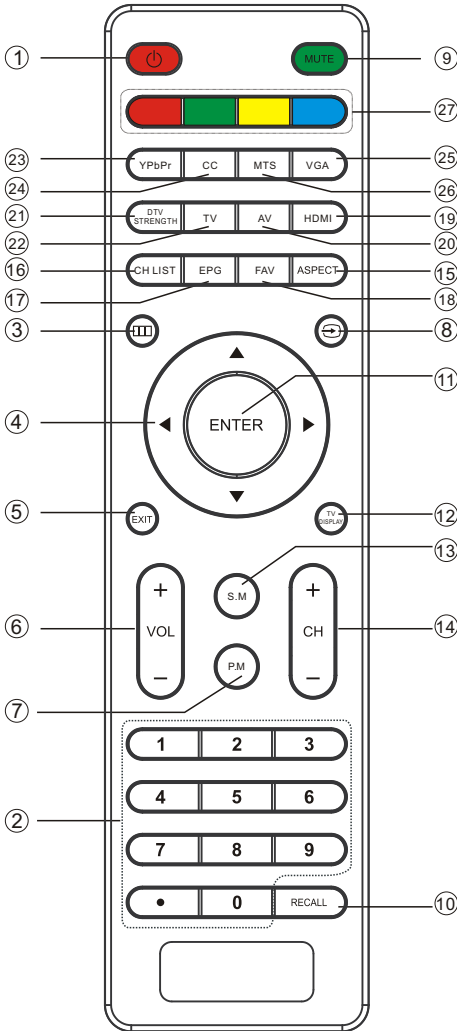

- 1: **POWER**
To set the TV standby or on.
- 2: **NUMBER KEY**
For direct access to program.
- 3: **□**
Displays the main on-screen menu.
- 4: **CURSOR**
To move within the menu.
- 5: **EXIT**
Used to exit menu.
- 6: **VOL+/-**
To adjust sound level.
- 7: **P.M**
To switch picture mode.
- 8: **↔**
Press to display and select the available video sources.
- 9: **MUTE**
To disable or enable the sound.
- 10: **RECALL**
To access the previously viewed program.
- 11: **ENTER**
Confirms selection.
- 12: **TV DISPLAY**
Displays/removes the program information.
- 13: **S.M**
To switch sound mode.
- 14: **CH+/CH-**
To access the next or previous program.
- 15: **ASPECT**
To change picture aspect.
- 16: **CH LIST**
Used to display the channel list.
- 17: **EPG**
Display all the information of DTV programs.
- 18: **FAV**
Used to access your favourite channels in digital TV mode.
- 19: **HDMI**
Hot key directly go to HDMI source.
- 20: **AV**
Hot key directly go to AV source.
- 21: **DTV STRENGTH**
Used to display the DTV signal strength menu.
- 22: **TV**
Hot key directly go to TV source.
- 23: **YPbPr**
Hot key directly go to YPbPr source.
- 24: **CC**
Enable or disable the CC function.
- 25: **VGA**
Hot key directly go to VGA source.
- 26: **MTS**
Switch the sound stereo.
- 27: **COLOR KEYS**
Reserved keys

1. PICTURE MENU

The first item of the MENU is the PICTURE MENU. This menu provides several video adjustment options for fine tuning the video display. Press $\blacktriangledown\blacktriangle$ to select, press $\blacktriangleleft\blacktriangleright$ to adjust, press MENU to exit.

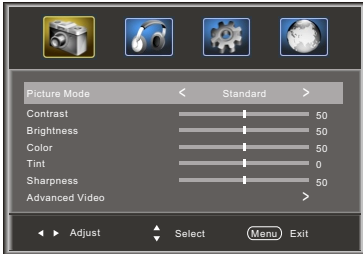

Note:

If you want to adjust contrast, brightness, color, and sharpness, the picture mode must be set to "Custom".

Advanced Video:

Press $\blacktriangledown\blacktriangle$ to select Advanced Video, press \blacktriangleright , and the screen shown below will be displayed.

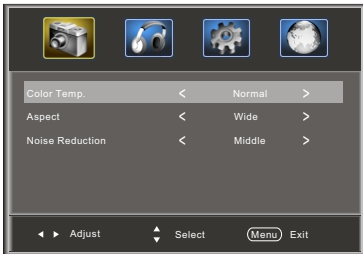

2. AUDIO menu

The second item of the MENU is the AUDIO MENU. You can adjust sound options here.

Press $\blacktriangledown\blacktriangle$ to select, press $\blacktriangleleft\blacktriangleright$ to adjust, press MENU to exit.

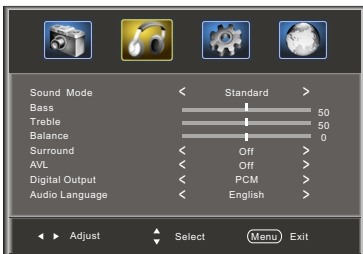

Note:

The Audio language option is only available for ATSC (DTV) programs.

3. SETUP MENU

The third item of the MENU is the SETUP MENU. You can set system settings here.

Press $\blacktriangledown\blacktriangle$ to select, press $\blacktriangleleft\blacktriangleright$ to adjust, press MENU to exit.



Note:

Restore Default: Reset all settings to the factory default value.

After changing TV channel name in the menu, the operating "reset to default", the channels label name could not be reset manual.

3.1. Parental Controls:

Press $\blacktriangledown\blacktriangle$ to select Parental Controls, press \blacktriangleright , and the screen shown below will be displayed.

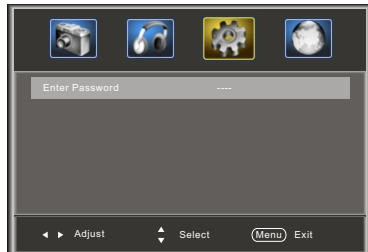

Input the password, and you will enter the Parental Control menu. The factory default password is 0000.

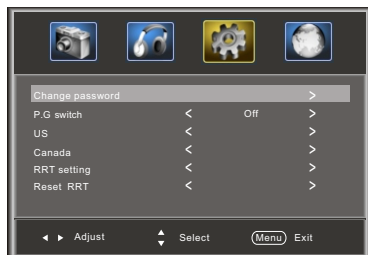

Change Password:

Press **▶**, and the screen shown below will be displayed.

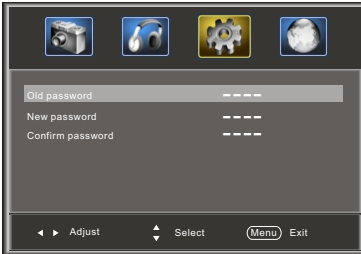

- 1). Old password: Input the old password
- 2). New password: Input the new password
- 3). Confirm password: Input the new password again

P.G switch:

When the Parental Control is ON, the options shown below can be adjusted.

US: Press **▶**, and the screen shown below will be displayed.



- 1): TV: Press **▶**, and the screen shown below will be displayed.



Rating	Content	Content				
		FV (Fantasy violence)	V (Violence)	S (Sexual situation)	L (Adult language)	D (Sexually suggestive dialog)
Suggested age	TV-Y (All children)					
	TV-Y7(Direct to order children)	X				
	TV-G(General audience)					
	TV-PG(Parental Guidance suggested)		X	X	X	X
	TV-14(Parents strongly cautioned)		X	X	X	X
	TV-MA(Mature audience only)		X	X	X	

Press the ENTER key to lock/unlock Parental Controls.

- 2). MPAA: switch the movie-rating control level: N/A, G, PG, PG-13, R, NC-17, X.

Rating	Description
G	General audiences, All Ages admitted
PG	Parental Guidance suggested. Some material may not be Suitable for children.
PG-13	Parents strongly cautioned. Some material may be Inappropriate for children under 13.
R	Restrict. Under 17 requires accompanying parent or adult guardian (age varies in some jurisdictions).
NC-17	No one 17 and under admitted.
X	X is an orderrating that is unified with NC-17 but may be encoded in the data of older movies.

Canada: Press **▶**, and the screen shown below will be displayed.

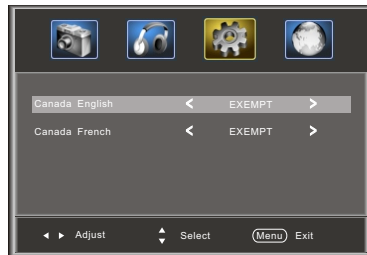

- 1): Canada English: switch the English-rating control level: EXEMPT, C, C8+, G, PG, 14+, 18+.

Rating	Description
E	Exempt: Includes news, sports, documents and other information programming: talk shows, music videos, and variety programming.
C	Children: Intended for younger children under the age of 8 years. Pays careful attention to themes that could threaten their sense of security and well-being.
CS+	Children over 8 years old: Contains no portrayal of violence as the preferred, acceptable, or only way to resolve conflict; nor encourage children to imitate dangerous acts which they may see on the screen.
G	General: Considered acceptable for all age groups. Appropriate viewing for the entire family, contains very little violence, physical, verbal or emotional.
PG	Parental Guidance: Intended for a general audience, but may not be suitable for younger children (under the age of 8) because it could contain controversial themes or issues.
14+	Over 14 Years: Could contain themes where violence is one of the dominant elements of the story line, but it must be integral to the development of plot or character. Language usage could be profane and nudity, present within the context of the theme.
18+	Adults: Intended for viewers 18 years and older and might contain depictions of violence, which while related to the development of plot, character or themes, are intended for adult viewing. Could contain graphic language and portrayals of nudity.

2). Canada French: switch the French-rating control level: E, G, 8ANS+, 13ANS+, 16ANS+, 18ANS+.

Rating	Description
E	Exempt programming
G	General: All ages and children, contains minimal direct violence, but may be integrated into the plot in a humorous or unrealistic manner.
8ans+	General but inadvisable for young children: May be viewed by a wide public audience, but could contain scenes disturbing to children under 8 who cannot distinguish between imaginary and real situations. Recommended for viewing with parental guidance.
13ans+	Over 13 years: Could contain scenes of frequent violent scenes and intense violence.
16ans+	Over 16 years: Could contain frequent violent scenes and violence.
18ans+	Over 18 years: Only for adult viewing. Could contain frequent violent scenes and extreme violence.

RRT setting: in ATSC digital TV mode, it could be adjusted

Reset RRT: Press **▶**, and the screen shown below will be displayed.

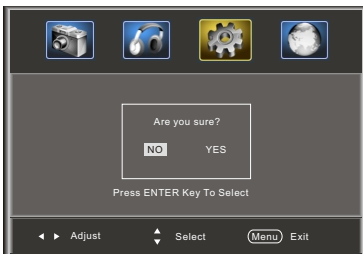

3.2 Timer

You can adjust timers here.

Press **▼▲** to select, press **◀▶** to adjust, press **MENU** to exit.

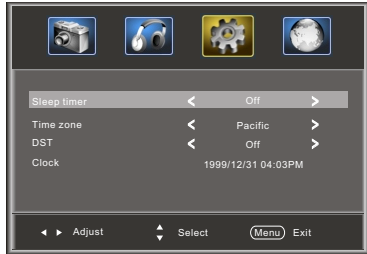

Sleep Timer: You can set the sleep timer.

Note:

Time zone, DST and Clock are available in ATSC mode, and the Clock can't be adjusted.

3.3 Closed Caption: switch the closed caption mode.

Press **▼▲** to select Closed Caption, press **▶**, and the screen shown below will be displayed.



1): Advanced selection: only available in ATSC mode.

2): Option: You can edit the closed caption options.

Press **▶**, and the screen shown below will be displayed.

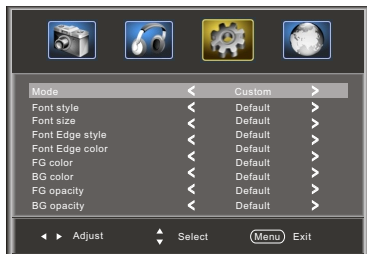

NOTE: Only available in ATSC mode.

3.4 Menu Settings

You can adjust Menu Settings here.

Press ▼▲ to select, press ◀▶ to adjust, press MENU to exit.



3.5 VGA Settings: Only available in VGA (PC input) mode.

Press ▼▲ to select VGA Settings, press ▶, and the screen shown below will be displayed.

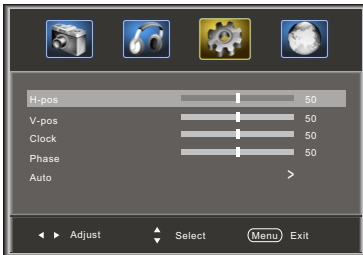

- 1). H-Pos: Adjust the horizontal position of the screen.
- 2). V-Pos: Adjust the vertical position of the screen.
- 3). Clock: Finetune the screen width.
- 4). Phase: Finetune the phase of the screen. Usually you don't need to adjust this item option.
- 5). Auto: Auto adjust to fit the screen.

4. Channel MENU

The fourth item of the MENU is the Channel MENU.

You can adjust digital and analog TV Channel. Press ▼▲ to select, press ◀▶ to adjust.

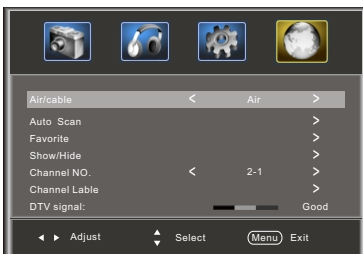

- 1). Air/Cable: Select Air TV signal or Cable TV signal.
- 2). Auto Scan: If it's the first time you use the TV, you should scan all the TV channels first.

Press the ▶ to confirm, and the screen shown below will be displayed.



Select "YES" and press the **ENTER** to confirm, and the screen shown below will be displayed, which indicates that the auto search is progressing.



- 3). Favorite: Press ◀▶ to add/delete favorite channels.
- 4). Show/Hide: Press the ENTER button to display or hide channels.
- 5). Channel NO. : Display the current channel number. Press ◀▶ to change the channel.
- 6). Channel label: Press ▲▼ to edit the current channel name.
- 7). DTV signal: Display DTV signal strength. It can't be selected and adjusted.

5. Multimedia MENU

If you select the storage source. You can use the Multimedia Menu to display JPEG pictures and play MP3 music.

1. Select a Photo

The screen shown below will be displayed.

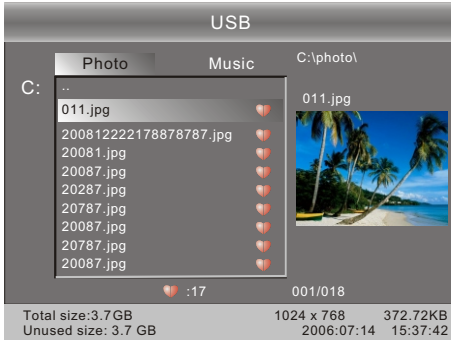







Use **◆** select the .Jpg files or folders, press ENTER to play, press EXIT to stop playing or go to the previous menu.

















2. Select Music

The screen shown below will be displayed.

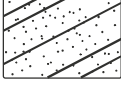

Use **◆** select the .MP3 files or folders, press ENTER to play, press EXIT to go to the previous menu.

-  : play
-  : pause
-  : stop
-  : fast backward
-  : previous
-  : next
-  : fast forward
-  : repeat all
-  : random play

Trouble phenomenon Symptom		Inspection Check
Picture	Audio	
 Snow	 Noise	antenna position, direction or connection
 Ghost	 Normal audio	antenna position, direction or connection
 Interference	 Noise	electronic equipment, car/ motorcycle, fluorescent light
 Normal Picture	 Mute	Volume (check if mute is activated or if the audio system connections are not correct)
 No picture	 Mute	Power cord is not inserted Power switch is not opened Contrast and brightness/volume setup Press standby key on the remote control for inspecting
 No color	 Normal audio	Color control
 Picture breaking up	 Normal audio or weak	Retune channel
 No color	 Noise	TV system

The LCD TV panel is built with very high precision technology giving you fine picture details in vibrant color. Occasionally, a few non-active pixels may appear on the screen as a fixed point of red, green, blue, black or white. Please note this does not affect the performance of the product.

Warranty

This Haier brand product, when shipped in its original container, will be free from defective workmanship and materials, and agrees that it will, at its option, either repair the defect or replace the defective product with a new or re-manufactured equivalent, for parts or labor for the periods set forth below:

This warranty does not apply to the appearance of the product or the exterior of the product, which has been damaged or defaced, altered or modified in design or construction. It does not apply to the additional excluded items set forth below:

The warranty commences on the date the item was purchased and the original purchase receipt must be presented to the authorized service center before warranty repairs are rendered.

The limited warranty described herein is in addition to whatever implied warranties may be granted to purchasers by law. **ALL IMPLIED WARRANTIES INCLUDING THE WARRANTIES OF MERCHANTABILITY AND FITNESS FOR USE ARE LIMITED TO THE PERIOD(S) FROM THE DATE OF PURCHASE SET FORTH BELOW.** Some states do not allow limitations on how long an implied warranty lasts, so the above limitation may not apply to you.

Neither the sales personnel of the seller nor any other person is authorized to make any warranties other than those described herein, or to extend the duration of any warranties beyond the time period described herein on behalf of Haier.

The warranties described herein shall be the sole and exclusive warranties granted by Haier and shall be the sole and exclusive remedy available to the purchaser. Correction of defects in the manner and for the period of time described herein, shall constitute complete fulfillment of all abilities and

Responsibility of Haier to the purchaser with respect to the product, and shall constitute full satisfaction of all claims, whether based on contract, negligence, strict liability or otherwise. In no event shall Haier be liable, or in any way responsible for any damages or defects in the product which were caused by repairs or attempted repairs performed by anyone other than an authorized service center or dealer; nor shall Haier be liable, or in any way responsible for incidental or consequential economic or property damage. Some states do not allow the exclusion of incidental or consequential damages, so that above exclusion may not apply to you.

THIS WARRANTY GIVES YOU SPECIFIC LEGAL RIGHTS. YOU MAY ALSO HAVE OTHER RIGHTS WHICH VARY FROM STATE TO STATE.

Warranty period for this product is one year parts and labor. Additional items excluded from warranty coverage: non-rechargeable batteries. What to do to obtain service or to obtain product literature, accessories, supplies or customer assistance: Simply call 1-877-337-3639. Be sure to have proof of purchase.

Haier®