

Haier®

LED TV OWNER'S MANUAL

Please READ this manual carefully before operating your TV, and keep it for future reference.

Haier

Haier

MODELS:
LE32C13200
LE40C13800

Haier

DIGITAL TELEVISION TRANSITION NOTICE

This device contains a digital television tuner, so it should receive digital over the air TV programming, with a suitable antenna, after the end of full-power analog TV broadcasting in the United States on June 12 2009. Some older television receivers, if they rely on a TV antenna, will need a TV Converter to receive over the air digital programming, but should continue to work as before for other purposes (e.g., for watching low-power TV stations still broadcasting in analog, watching pre-recorded movies, or playing video games).

For more information,
call the FCC at 1-888-CALL-FCC (1-888-225-5322)
or see www.DTV.gov.



For information on the TV Converter program, and on government coupons that may be used toward the purchase of one, see www.dtv2009.gov,
or call the NTIA at 1-888-DTV-2009.

AVISO RELATIVO A LA TRANSICIÓN A TELEVISIÓN DIGITAL

Este equipo incorpora un sintonizador de televisión digital, lo que le permitirá recibir una programación digital televisada por aire, con una antena adecuada, cuando se terminará la transmisión de alta potencia de la televisión analógica en los Estados Unidos el 12 de Junio de 2009. Ciertos receptores de televisión antiguos, si dependen de una antena de TV, necesitarán un conversor de TV para recibir por el aire una programación digital, pero seguirán funcionando como antes para otros usos (por ejemplo para ver emisoras de TV de baja potencia que todavía transmiten en analógico, para ver películas pregrabadas, o para utilizar sus videojuegos).

Para obtener más información,
llame FCC 1-888-CALL-FCC (1-888-225-5322)
o refiérase a www.DTV.gov.

Para toda información sobre el programa de conversores de TV, y acerca de los cupones del gobierno que se pueden usar para comprarlos, refiérase a www.dtv2009.gov,
o llame al NTIA al 1-888-DTV-2009.

SYMBOL	SYMBOL DEFINITION
	<p>DANGEROUS VOLTAGE: The lightning flash with arrowhead symbol, within an equilateral triangle, is intended to alert the user to the presence of uninsulated “dangerous voltage” within the product’s enclosure that may be of sufficient magnitude to constitute a risk of electrical shock to persons.</p>
	<p>INSTRUCTIONS: The exclamation point within an equilateral triangle to alert the user to the presence of important operating and maintenance (servicing) instruction in the literature accompanying the appliance.</p>

Apparatus shall not be exposed to dripping or splashing and no objects filled with liquids, such as vases, shall be placed on the apparatus.

CAUTION - Danger of explosion if battery is incorrectly replaced. Replace only with the same or equivalent type.

Batteries installed warning

CAUTION - Danger of explosion if battery is incorrectly replaced. Replace only with the same or equivalent type.

The batteries (battery pack or batteries installed) shall not be exposed to excessive heat such as sunshine, fire or the like.

FOR YOUR SAFETY

Before operating the TV please read this manual thoroughly. This manual should be retained for future reference.

FCC Class B Radio Frequency Interference Statement

WARNING:

(FOR FCC CERTIFIED MODELS)

NOTE: This device complies with Part 15 of FCC Rules. Operation of this product is subject to the following two conditions: (1) this device may not cause harmful interference, and (2) this device must accept any interference received, including interference that may cause undesired operation. This equipment has been tested and found to comply with the limits for a Class B digital device, pursuant to Part 15 of the FCC Rules. These limits are designed to provide reasonable protection against harmful interference in a residential installation. This equipment generates, uses and can radiate radio frequency energy, and if not installed and used in accordance with the instructions, may cause harmful interference to radio communications. However, there is no guarantee that interference will not occur in a particular installation. If this equipment does cause harmful interference to radio or television reception, which can be determined by turning the equipment off and on, the user is encouraged to try to correct the interference by one or more of the following measures:

1. Reorient or relocate the receiving antenna.
2. Increase the separation between the equipment and receiver.
3. Connect the equipment into an outlet on a circuit different from that to which the receiver is connected.
4. Consult the dealer or an experienced radio/TV technician for help.







NOTICE

1. The changes or modifications not expressly approved by the party responsible for compliance could void the user's authority to operate the equipment.
2. Shielded interface cables and AC power cord, if any, must be used in order to comply with the emission limits.
3. The manufacturer is not responsible for any radio or TV interference caused by unauthorized modification to this equipment. It is the responsibilities of the user to correct such interference.

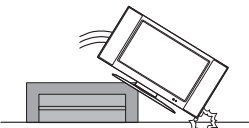
WARNING:

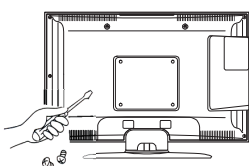
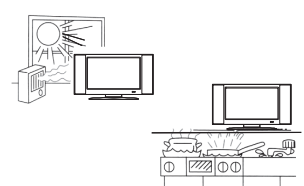
To reduce the risk of fire or electric shock, do not expose this apparatus to rain or moisture

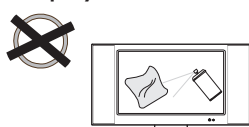
PRECAUTIONS AND REMINDERS

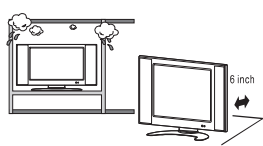
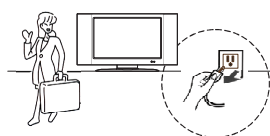
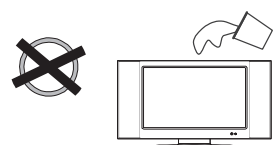
<p>Place unit on even surfaces.</p> 	<p>Unplug immediately if other foreign materials are put inside TV box or if the TV fell down.</p> 	<p>Do not cover or block any vents and openings. Inadequate ventilation may shorten the life of the display unit and cause overheating.</p> 
<p>Unplug immediately if there is a malfunction like no picture, no video/audio, smoke and bad odor from TV.</p> 	<p>Prohibit/Avoid opening TV cabinet.</p> 	<p>Avoid direct sunlight, dusty, high humidity and smoky areas.</p> 
<p>Don't throw any object inside the TV box like metals or other flammable materials.</p> 	<p>Remember to unplug the AC cord from the AC outlet before cleaning. Do not use liquid cleaners or aerosol cleaners to clean the display.</p> 	<p>Call service personnel to clean the internal part of the TV once a year.</p> 
<p>Don't place the TV in confined spaces or in a box when using it.</p> 	<p>Make sure to unplug the unit when not in use for a long period of time (days).</p> 	<p>Do not place the display near water, such as bathtub, washbasin, kitchen sink laundry tub, swimming pool or in a damp basement.</p> 

Notice for Remote Controller

<p>Avoid Dropping</p> 	<p>Avoid Liquids</p> 	<p>Avoid Aerosol Cleaners</p> 
---	--	---

IMPORTANT SAFETY INSTRUCTIONS

Read before operating equipment

1. Read these instructions.
2. Keep these instructions.
3. Heed all warnings.
4. Follow all instructions.
5. Do not use this apparatus near water.
6. Clean only with a dry cloth.
7. Do not block any ventilation openings. Install in accordance with the manufacturer's instructions.
8. Do not install near any heat sources such as radiators, heat registers, stoves, or other apparatus (including amplifiers) that produce heat.
9. Do not defeat the safety purpose of the polarized or grounding-type plug. A polarized plug has two blades with one wider than the other. A grounding type plug has two blades and a third grounding prong. The wide blade or the third prong are provided for your safety. If the provided plug does not fit into your outlet, consult an electrician for replacement of the obsolete outlet.
10. Protect the power cord from being walked on or pinched particularly at plugs, convenience receptacles, and the point where they exit from the apparatus.
11. Only use attachments/accessories specified by the manufacturer.
12. Use only with the cart, stand, tripod, bracket, or table specified by the manufacturer, or sold with the apparatus. When a cart is used, use caution when moving the cart/apparatus combination to avoid injury from tip-over.



13. Unplug this apparatus during lightning storms or when unused for long periods of time.
14. Refer all servicing to qualified service personnel. Servicing is required when the apparatus has been damaged in any way, such as power-supply cord or plug is damaged, liquid has been spilled or objects have fallen into the apparatus, the apparatus has been exposed to rain or moisture, does not operate normally, or has been dropped.
15. The TV should be operated only from the type of power source indicated on the label. If you are not sure of the type of power supplied to your home, consult your dealer or local power company.
16. The mains plug or appliance coupler is used as the disconnect device, the disconnect device shall remain readily operable.
17. CAUTION – These servicing instructions are for use by qualified service personnel only. To reduce the risk of electric shock, do not perform any servicing other than that contained in the operating instructions unless you are qualified to do so.
18. Wall Mount Bracket – For use only with UL Listed Wall Mount Bracket with minimum weight/load: Please see page 25.

19. **CONSUMER ALERT** – This television receiver has only an analog broadcast tuner and will require a converter box after June 12 2009, to receive over-the-air broadcasts with an antenna because of the Nation's transition to digital broadcasting. Analog-only TVs should continue to work as before with cable and satellite TV services, gaming consoles, VCRs, DVD players, and similar products, For more information, call the Federal Communications Commission at 1-888-225-5322 (TTY: 1-888-835-5322) or visit the Commission's digital television website at: www.DTV.gov.
- Information about the DTV transition –after June 12 2009, a television receiver with only an analog broadcast tuner will require a converter box to receive full power over the- air broadcasts with an antenna because of the Nation's transition to digital broadcasting. Analog-only TVs should continue to work as before to receiver low power, Class A or translator television stations an with cable and satellite TV services, gaming consoles, VCRs, DVD players, and similar products. For more information about the DTV transition is available from <http://www.DTV.gov> or 1-888-CALL-FCC, and from <http://www.dtv2009.gov> or 1-888-DTV-2009 for information about subsidized coupons for digital-to-analog converter boxed.
20. **Tilt/Stability** – All televisions must comply with recommended international global safety standards for tilt and stability properties of its cabinets design.
- Do not compromise these design standards by applying excessive pull force to the front, or top, of the cabinet, which could ultimately overturn the product.
 - Also, do not endanger yourself, or children, by placing electronic equipment/toys on the top of the cabinet. Such items could unsuspectingly fall from the top of the set and cause product damage and/or personal injury.
21. **Wall or Ceiling Mounting** – The appliance should be mounted to a wall or ceiling only as recommended by the manufacturer.
22. **Power Lines** – An outdoor antenna should be located away from power lines.

23. Outdoor Antenna Grounding – If an outside antenna is connected to the receiver, be sure the antenna system is grounded so as to provide some protection against voltage surges and built up static charges. Section 810 of the National Electric Code, ANSI/NFPA No. 70-1984, provides information with respect to proper grounding of the mats and supporting structure grounding of the lead-in wire to an antenna-discharge unit, size of grounding connectors, location of antenna discharge unit, connection to grounding electrodes and requirements for the grounding electrode. See Figure below.

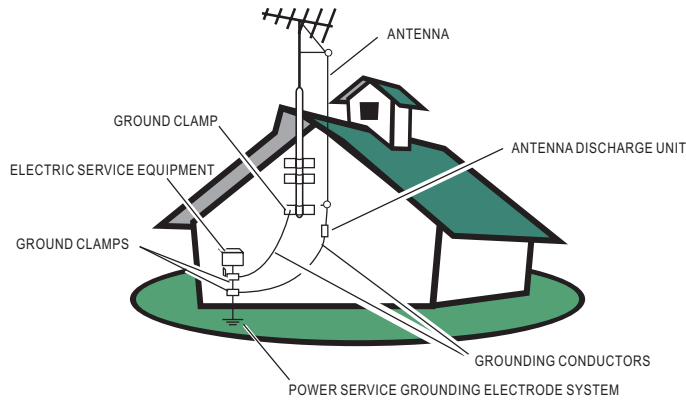

EXAMPLE OF ANTENNA GROUNDING AS PER NATIONAL ELECTRICAL CODE

Note to the CATV system installer: This reminder is provided to call the CATV system installer's attention to Article 820-40 of the NEC that provides guidelines for proper grounding and, in particular, specifies that the cable ground shall be connected to the 6 English grounding system of the building, as close to the point of cable entry as practical. Please, make sure to connect the power plug to the wall outlet socket after connecting the TV to the adapter!



ENERGY STAR compliant

By being ENERGY STAR compliant you are assured that your Haier model is helping the environment by using less energy while saving you money. ENERGY STAR is a joint program of the U.S. Environmental Protection Agency and the U.S. Department of Energy promoting energy efficiency.

SAVE THESE INSTRUCTIONS

Thank you for purchasing this Haier product. This easy-to-use manual will guide you in getting the best use of your product. Remember to record the model and serial number. They are on the label on the back of the unit.

Model number

Serial number

Date of purchase

Staple your receipt to your manual. You will need it to obtain warranty service.

TABLE OF CONTENTS

DIGITAL TELEVISION TRANSITION NOTICE	1
FOR YOUR SAFETY	3
PRECAUTIONS AND REMINDERS	4
IMPORTANT SAFETY INSTRUCTIONS	5
PREPARATION.....	10
ATTACHING THE BASE.....	10
PREPARING YOUR LCD HDTV FOR WALL MOUNTING	10
PERIPHERAL CONNECTION GUIDE	12
OPERATING INSTRUCTIONS.....	13
TO USE THE FRONT PANEL CONTROLS.....	13
TO USE THE REMOTE CONTROL.....	14
TO USE THE MENUS	16
TV MENU	16
VIDEO MENU	16
AUDIO MENU.....	17
SETUP MENU.....	18
VGA MENU.....	22
TIPS.....	22
PRODUCT SPECIFICATIONS	24
TROUBLESHOOTING.....	26
GLOSSARY	27
WARRANTY	28

PREPARATION

IMPORTANT: Do not apply pressure to the screen display area which may compromise the integrity of the display. The manufacturer's warranty does not cover user abuse or improper installations.

ATTACHING THE BASE

IMPORTANT: The base of the HDTV must be assembled prior to usage.

1. Place the TV unit face down on a soft and flat surface (blanket, foam, cloth, etc.) to prevent any damage to the HDTV.
2. Carefully align and insert the base to the stand.
3. Gently push the base towards the HDTV until the locking mechanism locks into place.
4. Secure the four screws on the bottom of the base.

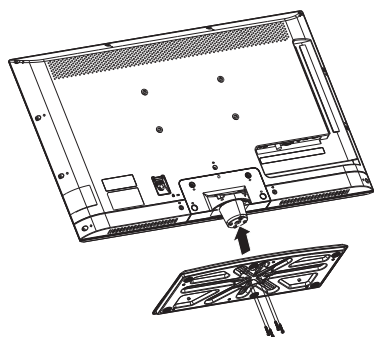

PREPARING YOUR LCD HDTV FOR WALL MOUNTING

We suggest that you keep your TV at least 2.36 inches (60 mm) from the wall to prevent cable interference.

Before mounting your TV on the wall, you need to remove the base.

For your safety, please use only with UL listed wall mount brackets with minimum weight of the TV without stand. (Please see page 25.)

To attach a wall mount bracket to your TV:

1. Remove the screws holding your TV to the stand and remove the base from your TV.
2. Use the screws left from removing the base to secure an optional cover plate to the bottom of the TV.
3. Secure the wall mount bracket to the back of your TV using four screws, as indicated in the illustration.

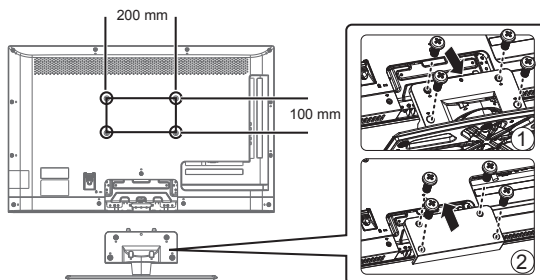

NOTE

- The cover plate, wall mount bracket, and the screws are optional parts, not included in the package.

Please make sure to connect the power plug to the wall outlet socket after connecting the TV to the power cord!

1. Install the base stand; place the TV on a solid surface.

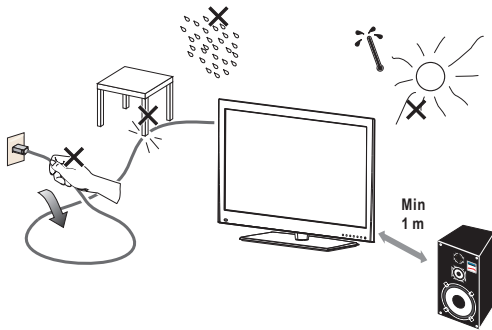

Ensure that the TV is placed in a position to allow free flow of air. Do not cover the ventilation openings on the back cover.

To prevent any unsafe situations, no naked flame sources, such as lighted candles, should be placed on or in the vicinity.

Avoid heat, direct sunlight and exposure to rain or water. The equipment shall not be exposed to dripping or splashing.

2. Connect the antenna cable or CATV cable to the aerial socket ANT IN 75Ω at the back of the TV set.

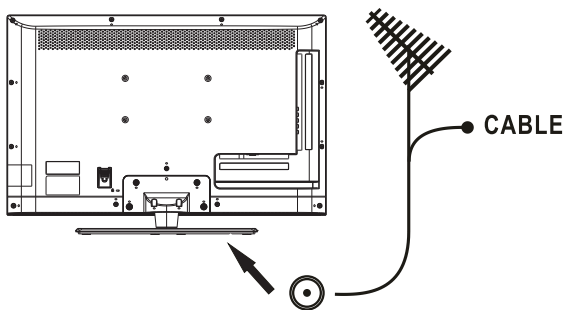

3. Remote control:

Remove the cover of the battery compartment. Insert the 2 supplied batteries (Type AAA 1.5V).

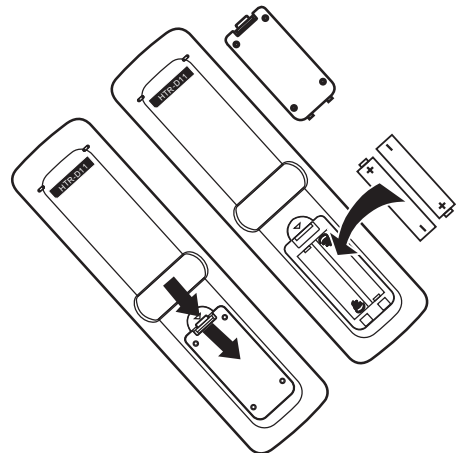

4. Power:

Insert the power cord in the wall socket with AC power supply.

5. Turn the TV on:

Press the Power key on the remote control or the front panel touch control keys. The TV will turn on within a few seconds.

Power Key

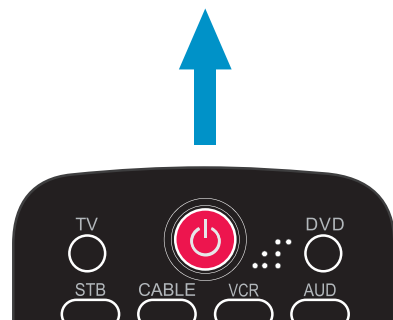

PERIPHERAL CONNECTION GUIDE

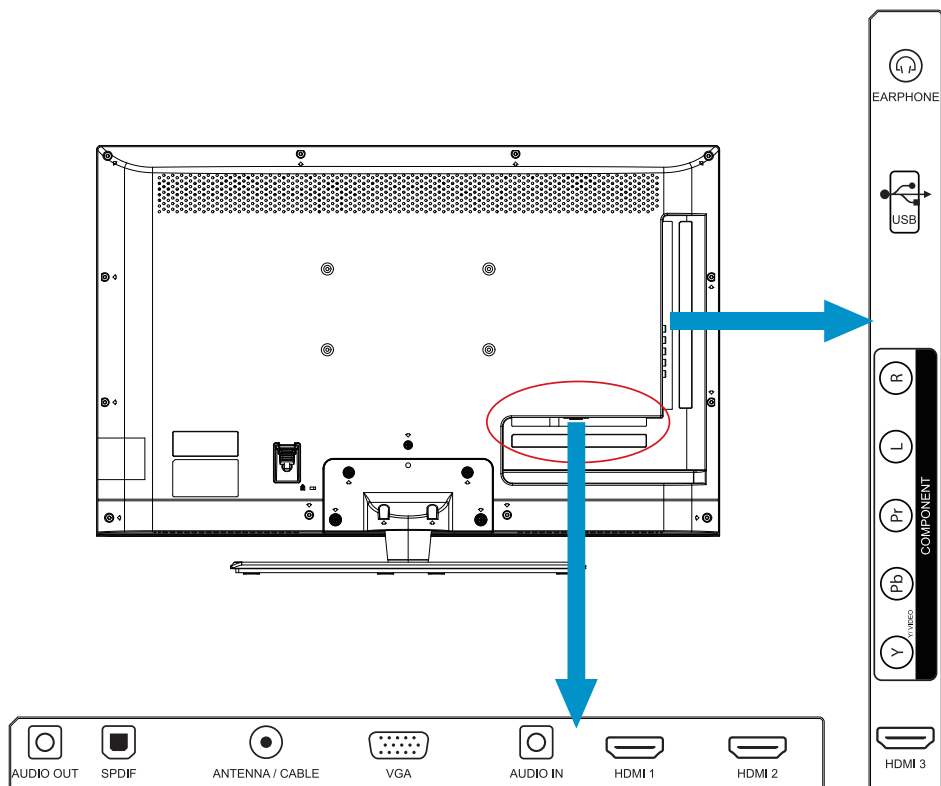



- **HDMI** – Connect the primary source for digital video such as a DVD player, Blu-ray player, or set top box through this all digital connector.
 - **VGA/AUDIO IN** – Connect the video and audio cables from a computer here.
 - **COMPONENT (Y/Pb/Pr with Audio L/R)** – Connect the primary source for component video devices such as a DVD Player or set top box here. Use red for Pr, blue for Pb, green for Y, red for right audio (R) and white for left audio (L) inputs. Composite Video and L/R Audio Input. (share with Component-Y)
 - **ANTENNA/CABLE** – Connect to an antenna or digital cable (out-of-the-wall, not from Cable Box) for Digital TV.
 - **SPDIF (Optical Digital Audio Out)** – When a digital audio signal is associated with the input selected for viewing, the digital audio will be available on this SPDIF connection to your home theater system.
 - **AUDIO OUT** – Output the TV audio to your stereo amplifier.
 - **USB PORT** – Insert USB storage device to the USB port to view JPEG photos, or listen to MP3 music.
 - **EARPHONE** – Connect to the headphone output. When the headphone is inserted to the plug, the integrated speakers will be muted.
- Once your equipment is connected, press the INPUT button on the remote control to select the source you want to view. (ex: Press INPUT button to select “Component” if you have connected a video recorder to the Component input.)

OPERATING INSTRUCTIONS

TO USE THE FRONT PANEL CONTROLS

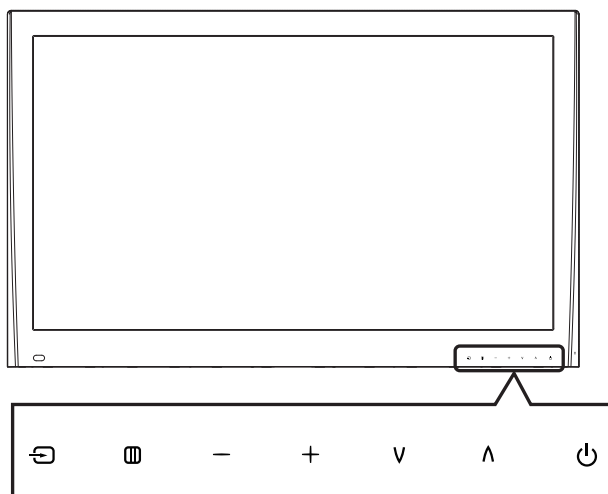
The front panel controls are touch keys. Simply touch the icon with your finger.



 • Power on/off (standby) the TV set.

 • Menu displayed: Navigate up.
• Menu not displayed: Browse the TV channels.

 • Menu displayed: Navigate down.
• Menu not displayed: Browse the TV channels.

 • Menu displayed: Navigate right or confirm/change a selection.
• Menu not displayed: Adjust volume up.

 • Menu displayed: Navigate left.
• Menu not displayed: Adjust volume down.

 • Enter or exit the OSD (on-screen display) menu.

 • Select the input source.
• Confirm/change a selection.

TO USE THE REMOTE CONTROL



Power

Press to power ON/OFF (standby) TV.
Note: The TV is never completely powered off unless physically unplugged.

TV, DVD, STB, CABLE, VCR, AUD

Select one of the system modes in which the remote control can be used.

PICTURE

Press to change the picture mode: Standard, Eco, Movie, Personal, Vivid.

AUDIO

Press to change the audio mode: Standard, Music, Speech, Personal.

PC

Press to change the input to PC mode.

HDMI

Press to directly change the input to the last HDMI input. Press to switch to other HDMI input when current source is HDMI.

0 ~ 9 / • number

Press to enter a TV channel number (Press "•" to choose the sub-channel).

INPUT

Press to show the input source list. Use the up and down arrow keys to select a source, and then press the ENTER key.

MUTE

Switch the sound on/off.

RECALL

Press to display the previous channel.

VOL+ / VOL-

Press to adjust volume.

CHA / CHV

Press to browse through the TV channels.

MENU

Press to enter or exit the menu.

EXIT

Press to exit the menu or OSD (on screen display).

▲ ▼ ◀ ▶: To navigate the on-screen menus and adjust the system settings.

ENTER

Press to confirm a selection.

SLEEP

Press to set the sleep timer: (off / 5 / 10 / 15 / 30 / 60 / 90 / 120 / 180 / 240 mins). The TV will automatically turn off (standby mode) after selected period of time passes.

DISPLAY

Press to show the information about the input source, TV channel, display resolution and current time.

USB

Press to change the input mode to USB (only when a USB storage device is connected).

MTS/SAP

For analog TV, press to switch sound mode as Stereo, SAP or Mono. For digital TV, press to switch audio language if the TV program provides.

FREEZE

Press once to display a frozen image of the current program, but audio continues. Press again to return to the program.

CH.LIST

Press to display the channel list.

GUIDE

Press to display the Electronic Program Guide.

CCD

Press repeatedly to change the closed caption type: CC On / CC Off / CC On With Mute.

ARC

Press to change the display aspect ratio: Normal, Zoom1, Wide, Zoom2, or HDMI PC mode.

Note: HDMI PC mode is only available for HDMI 480i/480p/720p/1080i/1080p signal.

FAVORITE

Press to show the Favorite Channel List. Use the up and down arrow keys to select a channel, and then press ENTER.

USB

- For non JPEG/MP3 mode:
Press to display the "Multimedia List" menu.
- For JPEG/MP3 mode:
Press to toggle MP3/JPEG mode.

For Multimedia (JPEGViewer/MP3MusicBox) use:

PLAY/PAUSE ▶||

Press to toggle Play/Pause function in Multimedia source.

STOP ■

Press to stop playing in Multimedia source.

REPEAT

Press to toggle Repeat On/Off mode in MP3 MusicBox.

REV ◀◀

Press to focus/view on previous item in JPEGViewer.

FWD ▶▶

Press to focus/view on next item in JPEGViewer.

PREV ◀◀◀

Press to focus/view on the first item in JPEGViewer.

Press to play previous MP3 file in MP3MusicBox.

NEXT ▶▶▶

Press to focus/view on the last item in JPEGViewer.

Press to play next MP3 file in MP3MusicBox.

Once HDMI CEC Control feature is enabled, PLAY/PAUSE, STOP, REV, FWD, PREV and NEXT control buttons provide the function control of compatible DVD players with HDMI-CEC control.

TO USE THE MENUS

1. Press the **Menu** button to display or close the main menu.
2. Use the **Navigation Ring** to move around to select, adjust or confirm an item in the OSD (On Screen Display) menu.

Press the **Menu** button to enter the main OSD. You can adjust the items in the **Video, Audio, TV, Setup,** and **VGA menus.** However, some options in the menus may only be enabled in particular source modes.

TV MENU

The TV menu in TV mode is shown below.

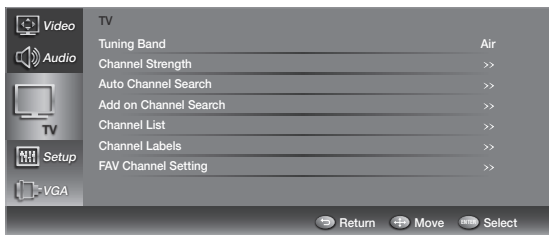

1. **Tuning Band:** Select the TV source signal: Air (antenna) or Cable (CATV).
2. **Channel Strength:** Show the intensity of the received DTV signal.
3. **Auto Channel Search:** Automatically scan all NTSC / ATSC TV channels and then store them in the channel table. During the channel scan process, the OSD will display the number of channels which have been found.
4. **Add on Channel Search:** Rescan the channels and add channels that are newly found.
5. **Channel List:** Show the Channel

List. User can edit (Show/Hide) channels or switch directly to a selected channel.

6. **Channel Labels:** Show the NTSC / ATSC TV Channel Labels menu for modifying channel labels.
7. **FAV Channel Setting:** Show the Favorite Channel List. You can edit (add/delete) the favorite channels.

VIDEO MENU

The Video menu in most source modes is shown below. It provides several video adjustment items for fine tuning the video display. In VGA source mode, the Picture menu only provides **Picture mode, Brightness, Contrast, Color Temp, Backlight, Aspect Ratio,** and **Preset** options.

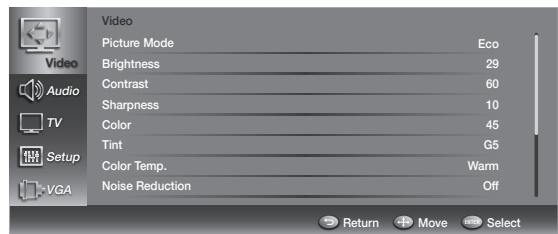

1. **Picture Mode:** Adjust the picture appearance by selecting the preset picture mode: Vivid, Standard, Eco, Movie, or Personal. Select personal to manually adjust the brightness, contrast, etc.
2. **Brightness:** Video brightness adjustment, the tuning range is 0 ~ 100.
3. **Contrast:** Video contrast adjustment, the tuning range is 0 ~ 100.
4. **Sharpness:** Video sharpness adjustment, the tuning range is 0 ~ 100.

5. **Color:** Video color chroma adjustment, the tuning range is 0 ~ 100.
6. **Tint:** Video tint adjustment, the tuning range is R50 ~ G50.
7. **Color Temp.:** Three color temperature modes. (Cool / Normal / Warm)
8. **Noise Reduction:** Gives four NR effect degrees: Low, Mid, High and Off.
9. **Adaptive Contrast:** Turn this option on to enable adaptive contrast. This function analyzes the video signal and automatically adjusts and enhances the contrast to provide the best picture.
10. **DCR:** Turn this option on to enable dynamic contrast. This function analyzes the video signal and adjusts the backlight to provide the deepest blacks and brightest whites.
11. **Backlight:** Backlight strength adjustment, the tuning range is 0 ~ 50.
12. **Aspect Ratio:** Choose the display aspect ratio: Normal / Zoom1 / Wide / Zoom2 / HDMI PC mode (HDMI PC mode is only for HDMI 480i/480p/720p/1080i/1080p signal).
13. **Preset:** Restores all video settings to the factory default value..

AUDIO MENU

The Audio menu in TV mode is shown below. It provides adjustments for the audio settings. Audio Language item is only available in digital TV and Audio Source item is only available in analog TV source mode. Either Audio

Language or Audio Source item is unavailable in other source modes.

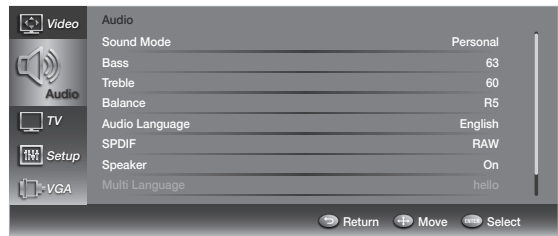

1. **Sound Mode:** Choose the audio mode: Standard / Music / Speech / Personal.
2. **Bass:** Bass tone adjustment, the tuning range is 0 ~ 63.
3. **Treble:** Treble tone adjustment, the tuning range is 0 ~ 63.
4. **Balance:** Audio balance adjustment, the tuning range is L50 ~ R50.
5. **Audio Source:** Select the audio source from Stereo, SAP or Mono. (This option is available for analog TV signals.)
6. **Audio Language:** Change the audio language for digital TV programs. The number of the supported audio languages depends on the digital TV programs: English, Spanish, French. (This option is available for digital TV signals only.)
7. **SPDIF:** Digital audio output format. Select from RAW and PCM. (This option is only available for HDMI or digital TV source mode, this option is fixed on PCM mode for other sources.)
8. **Speaker:** Choose to turn on / off the TV's integrated internal speakers. The digital audio output signals and headphone output signal will not be turned off even though

the TV speaker is off. The default setting is On.

9. **AVL:** Turn the Auto Volume Leveler On or Off. When AVL is on, the TV will maintain a steady volume during commercials or when the channel is changed.
10. **Preset:** Restores all audio settings to the factory default value.

SETUP MENU

The Feature menu is shown below. This menu contains options to set the language, time, and other settings. Depending on the current source mode (TV, HDMI, etc.), some options may not be available.

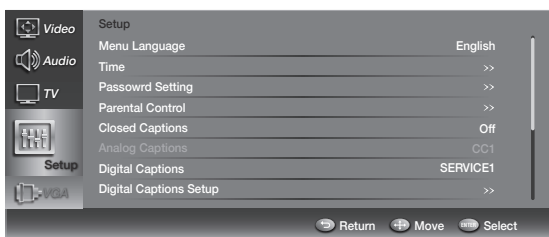

1. **Menu Language:** Select the menu display language: English, Français, Español.
2. **Time:** Set the current time. The sub-menu includes Time Mode, Time Zone, and Daylight Savings.
 - [Time Mode]** – Choose from Auto or Manual. Select Manual to set the Year, Month, Date, and Time manually.

[Time Zone] – Set the current time zone.

[Daylight Savings] – Set to On or Off.

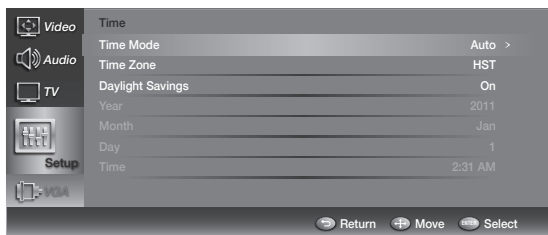

3. **Password Setting:** Change the 4-digit parental control password. Three steps are required for changing the password: Enter Old Password → Enter New Password → Confirm New Password.

Note: This option is only available in TV or Composite source mode. The default password is 『0000』.

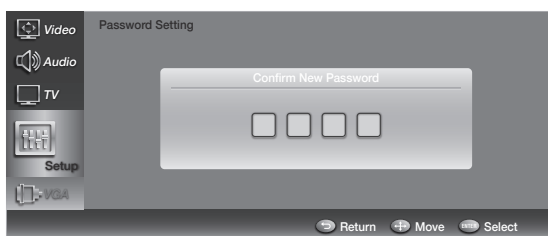
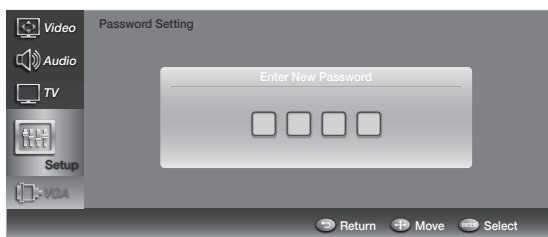

4. **Parental Control:** Provides the parental Control (V-chip) function setting. Before entering the Parental Control sub-menu, you must enter the password first. Enter the Parental Lock item, then you can block programs using the MPAA or

TV Rating table. After exiting the main menu, the parental control function is enabled. The blocked channels or source signals can be unlocked by entering the password. Note: This feature is only available in TV or Composite source mode. (The default password is: 『 0 0 0 0 』 .)



[Button Lock] – Select On or Off to lock or unlock the touch keys on the front TV panel. When this function is enabled, the touch keys on your TV will be locked and the TV can be controlled by the remote control only.

[Block Unrated TV] – When Block Unrated TV is set to on, your TV will block unrated programs.

[USA Parental Locks] – Set the parental control level using the MPAA or TV Rating.

[Canadian Parental Locks] – Set the parental control level using the English Rating or French Rating.

[Open V-Chip] – Open V-Chip is an advanced V-Chip rating

system for digital channels that are received.

The rating table will be updated by programs using the RRT5 rating information.

5. **Closed Captions:** Select closed caption options: Off, On or With Mute.
6. **Analog Captions:** Select analog caption options: CC 1-4 or TEXT 1-4 (This option is only available for analog TV or Composite source mode.)
7. **Digital Captions:** Select digital caption options: SERVICE 1-6 or CC 1-4. (This option is only available for digital TV source mode.)
8. **Digital Captions Setup:** Provides numerous options for setting the digital closed caption style. (This option is only available for digital TV source mode.)

[Style] – Set to Automatic or Custom mode. If Custom mode is selected, you can modify the style. The setting result will be shown immediately on the bottom of the sub-menu OSD.

[Size] – Set the digital closed caption font size: Automatic, Small, Normal, or Large.

[Font] – Set the digital closed caption font style: Automatic, Default, or Font 1 ~ 7.

[Text Color] – Set the text color: Automatic, White, Red, Green, Blue, Yellow, Magenta, Cyan, Black.

[Text Opacity] – Set the text opacity: Automatic, Solid, Flashing, Transparent, Translucent.

[Background Color] – Set the background color: Automatic, Black, White, Red, Green, Blue, Yellow, Magenta, Cyan.

[Background Opacity] – Set the background opacity: Automatic, Solid, Flashing, Transparent, Translucent.

[Edge Effect] – Set the edge effect: Automatic, None, Raised, Depressed, Uniform, Left Shadow, Right Shadow.

[Edge Color] – Set the edge color: Automatic, Red, Green, Blue, Yellow, Magenta, Cyan, Black, White.

9. **HDMI CEC:** This option is available only for HDMI source mode. Your Haier HDTV supports some HDMI CEC (Consumer Electronic Control) functions. When you connect another HDMI CEC device (ex. Blu-ray player) to the TV, they can discover and communicate with each other. This TV supports the following HDMI CEC functions: system standby, one-touch play, remote control pass through, device menu control, and device list.

[HDMI Control] – Enable or Disable the HDMI CEC function Control.

[Device Auto Off] – Enable or disable "Device Auto Off". By enabling this menu option, turning off the TV will command the CEC enabled device connected to the HDMI input to Standby mode.

[TV Auto On] – Set "TV Auto On". Pressing the "Play" button on the CEC enabled device (ex. Blu-

ray player) will command it to play, turn on the TV, and select the appropriate HDMI input.

[Root Menu] – Accesses the menu of connected HDMI CEC-compatible device with the TV remote control.

[Device List] – List the connected HDMI CEC devices and the available functions.

10. **Input Labels:** This option is available only for non-TV source mode. You can edit the input label for each non-TV source mode.
11. **Component Setting:** This option is only available in Component source mode. You can adjust the component display settings: Phase and Preset.

[Phase] – Adjust the Picture Phase to reduce Horizontal-Line noise. The tuning range is from 0 to 31.

[Preset] – Restore the default component setting values.

12. **MultiMedia Menu:** This option displays the photos (JPEG) or plays the music (MP3) stored on a USB storage device.

Note: Only the first 1000 files are recognized.

The photos that can be displayed are limited:

Minimum resolution: 8x8

Maximum resolution: 8000x6000

There are three ways to enter the JPEG Viewer and MP3 MusicBox interface:

- (1) After plugging in a USB storage device into the USB port on the side of your TV, the Multimedia List menu will be displayed.



(2) Select MultiMedia Menu in the Setup Menu to choose the JPEG Viewer or MP3 MusicBox. These two items are activated only if a USB storage device is plugged into the USB port.

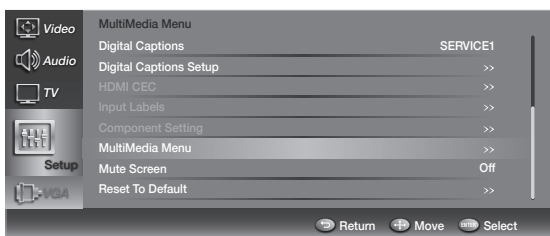

(3) When a USB storage device is plugged in: Press the USB key on the remote control to display the Multimedia List menu. Press the USB key to switch to the other multimedia mode. (JPEG →MP3 / MP3 →JPEG)



[JPEG Viewer] – Press the **Menu** button to display the control menu. Use the arrow keys to select a

photo. Press ENTER to display the selected photo.

- **Image Delay:** Set how quickly the pictures change in slideshow mode. There are three options: Fast, Slow, and Normal.
- **Music On Slide Show:** Enable background Music during slide show mode. It will play the MP3 files in the current folder repeatedly. The Music On Slide Show option will be grayed out if there are no MP3 files in the current folder.
- **Start Slide Show:** Enter Slide Show mode.
- **Rotate Photo:** Rotate selected picture: 0, 90, 180, 270.
- **Back to Upper Folder:** Return to the upper folder.
- **Back to Root Folder:** Return to root folder.
- **Exit:** Exit JPEG Viewer and return to the previous source mode.

[MP3 MusicBox]

- **ListInfoBar (at the bottom):** This part contains file and folder information: “Current Directory”, “Total File(s)”, “Total Folder(s)”, “Current Item” in current directory and Key Help Bar.
- **PlayList (on the right side):** This part lists all folders and MP3 music files in the current folder.
- **ControlPanel (on the left side):**
 - Bass, Treble, Balance, Volume:** Adjust the audio tone.
 - Mute Screen:** You can enable

(On) or disable (Off) the mute screen function. When enabled, the screen mute warning banner would be displayed on screen after 5 seconds if no key is pressed. Once the screen mute warning banner is displayed, click "Yes" to start muting screen or click "No" to disable mute screen function and then exit banner. Sound will continue to come from the speakers. You can press any key to turn on screen again when screen is muted.

Note: The mute screen option set in MP3 MusicBox is only valid in the MP3 MusicBox mode.

Preset: Restore all MP3 MusicBox settings to the factory default value.

Exit: Exit MP3 MusicBox interface.

13. Mute Screen: You can enable (On) or disable (Off) the mute screen function. When enabled, the screen mute warning banner would be displayed on screen after 5 seconds if no key is pressed. Sound will continue to come from the speakers. Press any key to turn on screen when screen is muted.

14. Reset to Default: Restore all setup menu settings to the factory default value.

VGA MENU

This option is only shown and available while in VGA mode, which provides several options to fine tune the VGA display.



1. **H-Position:** Adjust the horizontal position of the picture. (0-40)
2. **V-Position:** Adjust the vertical position of the picture. (0-16)
3. **Clock:** Adjust picture clock to reduce Vertical-Line noise. (0-16)
4. **Phase:** Adjust picture phase to reduce Horizontal-Line noise. (0-31)
5. **Auto Adjust:** Adjust the settings automatically.
6. **Preset:** Restore all VGA settings to the factory default value.

TIPS

Care of the screen

Do not rub or strike the screen with anything hard as this may scratch, mar, or damage the screen permanently.

Unplug the power cord before cleaning the screen. Dust the TV by wiping the screen and the cabinet with a soft, clean cloth. If the screen requires additional cleaning, use a clean, damp cloth. Do not use liquid cleaners or aerosol cleaners.

Mobile telephone warning

To avoid disturbances in picture and sound, malfunctioning of your TV or even damage to the TV, keep your mobile telephone away from the TV.

End of life directives

Your new TV contains materials, which can be recycled and reused.

At the end of its life, specialized companies can dismantle the discarded receiver to concentrate the reusable materials and to minimize the amount of materials to be disposed of.

Please ensure you dispose of your old receiver according to local regulations. Haier is committed to safely recycling electronic products and product materials. Please check for a local recycling location in the United States at : 1800RECYCLING.COM or call 1.800.RECYCLING.

Dolby License Notice and Trademark Acknowledgement



Manufactured under license from Dolby Laboratories.

Dolby and the double-D symbol are trademarks of Dolby Laboratories.

Regulatory Notices – Federal Communications Commission Notice

This device complies with Part 15 of FCC Rules. Operation of this product is subject to the following two conditions:(1) this device may not cause harmful interference, and (2) this device must accept any interference received, including interference that may cause undesired operation. This equipment has been tested and found to comply with the limits for a Class B digital device, pursuant to part 15 of the FCC Rules. These limits are designed to provide reasonable protection against harmful interference in a residential installation. This equipment generates, uses, and can radiate radio frequency energy and, if not installed and used in accordance with the instructions,

may cause harmful interference to radio communications. However, there is no guarantee that interference will not occur in a particular installation. If this equipment does cause harmful interference to radio or television reception, which can be determined by turning the equipment off and on, the user is encouraged to try to correct the interference by one or more of the following measures:

- Reorient or relocate the receiving antenna.
- Increase the separation between the equipment and the TV.
- Connect the equipment into wall power outlet on a circuit different from that to which the receiver is connected.
- Consult the dealer or an experienced radio or television technician for help.

Modifications

The FCC requires the user to be notified that any changes or modifications made to this device that are not expressly approved by our company may void the user's authority to operate the equipment.

Cables

Connections to this device must be made with shielded cables with metallic RF/EMI connector hoods to maintain compliance with FCC Rules and Regulations.

Canadian notice

This Class B digital apparatus complies with Canadian ICES-003.

Cet appareil numérique de la classes B est conforme a la norme NMB-003 du Canada. Standard Television Receiving Apparatus - Appareil de reception television ordinaire , Canada BETS-7/ NTMR-7

PRODUCT SPECIFICATIONS

NOTE

- This model complies with the specifications listed below.
- Designs and specifications are subject to change without notice.
- This model may not be compatible with features and/or specifications that may be added in the future.

Model No.	LE32C13200	LE40C13800
DISPLAY		
Viewable	32"	40"
Television System	<ul style="list-style-type: none"> • NTSC standard • ATSC standard (8-VSB, Clear-QAM) 	
Channel Coverage	<ul style="list-style-type: none"> • VHF: 2 through 13 • UHF: 14 through 69 • Cable TV: Mild band (A - 8 through A - 1, A through I), Super band (J through W), Hyper band (AA through ZZ, AAA, BBB), Ultra band (65 through 94, 100 through 135) 	
CONNECTIONS		
Down-facing Connectors	<ul style="list-style-type: none"> • Tuner Input: 75Ω 	
	<ul style="list-style-type: none"> • Audio In: Headphone mini-jack 	
	<ul style="list-style-type: none"> • VGA. Supported scan rate: 640x480@60Hz, 720x400@70Hz, 800x600@60Hz, 1024x768@60Hz, 1280x720@60Hz, 1280x768@60Hz, 1360x768@60Hz. • Recommend: 1360x768@60Hz 	<ul style="list-style-type: none"> • VGA. Supported scan rate: 640x480@60Hz, 720x400@70Hz, 800x600@60Hz, 1024x768@60Hz, 1280x720@60Hz, 1280x768@60Hz, 1280x1024@60Hz, 1440x900@60Hz, 1680x1050@60Hz, 1920x1080@60Hz • Recommend: 1920x1080@60Hz
	<ul style="list-style-type: none"> • HDMI 1, HDMI 2. Supported scan rates: 480i, 480p, 720p, 1080i, 1080p • HDMI 1: Supported DVI-to-HDMI adapter or cable connection. (The audio should be connected through the VGA/AUDIO IN for such connection.) 	
	<ul style="list-style-type: none"> • SPDIF 	
	<ul style="list-style-type: none"> • Audio Output 	

Model No.	LE32C13200	LE40C13800
Side Connectors	<ul style="list-style-type: none"> • Earphone Output • USB Port (USB plug thickness <9mm) • Component Video and L/R Audio input. Supported resolution: 480i, 480p, 720p, 1080i, 1080p • Composite Video and L/R Audio Input. (share with Component-Y) • HDMI 3. Supported scan rates: 480i, 480p, 720p, 1080i, 1080p 	
WEIGHT & DIMENSION		
Dimensions with Stand (W x H x D)	30.37 x 20.74 x 8.11 (inch)	37.52 x 24.83 x 9.40 (inch)
Dimensions without Stand (W x H x D)	30.37 x 19.05 x 1.59 (inch)	37.52 x 23.11 x 1.48 (inch)
Weight with Stand	19.56 (lbs)	29.98 (lbs)
Weight without Stand and Base	15.95 (lbs)	24.47 (lbs)
WALL MOUNTING		
VESA-compatible wall bracket (W x H)	200 x 100 mm	200 x 200 mm
Screw type	Metric 4 x 16 mm	Metric 6 x 18 mm
POWER		
Power Consumption	< 85W	< 115W
Standby	< 1W	
Mains Power	120V~ 60Hz	
Audio Power	10W + 10W	
Ambient Temperature	41°F ~ 95°F	
PACKAGE CONTENTS		
Supplied Accessories	<ul style="list-style-type: none"> • TV Unit x 1 • Base x 1 • Remote Control x 1 (with two size AAA alkaline batteries) • User Manual x 1 • Registration Card x 1 	

TROUBLESHOOTING

Please make these simple checks before calling service. These tips may save you time and money since charges for receiver installation and adjustments of customer controls are not covered under your warranty.

Symptoms	Items to Check and Actions to follow
"Ghost" or double image	<ul style="list-style-type: none"> This may be caused by obstruction to the antenna due to high rise buildings or hills. Using a highly directional antenna may improve the picture.
No power	<ul style="list-style-type: none"> Check if the TV's AC power cord is plugged into the mains socket. Unplug the TV, wait for 60 seconds. Then reinsert plug into the mains socket and turn on the TV again.
No picture	<ul style="list-style-type: none"> Check antenna connections at the rear of the TV to see if it is properly connected to the TV. Possible broadcast station trouble. Try another channel. Adjust the contrast and brightness settings. Check the Closed Captions control. Some TEXT modes could block the screen.
Good picture but no sound	<ul style="list-style-type: none"> Increase the VOLUME. Check if the TV is muted; press the MUTE button on the remote control.
Good sound but poor color	<ul style="list-style-type: none"> Adjust the contrast, color and brightness settings.
Poor picture	<ul style="list-style-type: none"> Poor picture quality may occur when an activated S-VHS camera or camcorder is connected to your TV and the other peripheral at the same time. Switch off one of the peripherals.
Snowy picture and noise	<ul style="list-style-type: none"> Check the antenna connection.
Horizontal dotted line	<ul style="list-style-type: none"> This may be caused by electrical interference (e.g. hair dryer, nearby neon lights, etc.) Turn off the equipment.
Television not responding to remote control	<ul style="list-style-type: none"> Check whether the batteries are working. Replace if necessary. Clean the remote control sensor lens on the TV. You can still use the buttons at the front of your TV. Select the TV mode to ensure your remote control is set in the TV mode.

GLOSSARY

HDTV

HDTV displays are technically defined as being capable of displaying a minimum of 720p or 1080i active scan lines.

HDMI Inputs

High-Definition Multimedia Interface

Audio / Video Inputs

Located on the rear of the receiver, these connectors (RCA phono type plug) are used for the input of audio and video signals. Designed for use with VCRs (or other accessories) in order to receive higher picture resolution and offer sound connection options.

Menu

An on-screen listing of features shown on the TV screen is made available for user adjustments.

MPAA

Motion Picture Association of America

Multichannel Television Sound (MTS)

The broadcasting standard, which allows stereo sounds to be transmitted with the TV picture.

RF

Radio Frequency or modulated signal design used as the carrier for television broadcasts.

Second Audio Program (SAP)

Another or additional audio channel provided for in the Multichannel Television Sound (MTS) broadcast standard. A monaural sound track included within the recorded or video signal (usually containing a second language translation for the displayed program).

Sleep Timer

You can set a time period for which the TV will be turn off automatically.

WARRANTY

This Haier brand product, when shipped in its original container, will be free from defective workmanship and materials, and agrees that it will, at its option, either repair the defect or replace the defective product with a new or re-manufactured equivalent, for parts or labor for the periods set forth below:

This warranty does not apply to the appearance of the product or the exterior of the product, which has been damaged or defaced, altered or modified in design or construction. It does not apply to the additional excluded items set forth below:

The warranty commences on the date the item was purchased and the original purchase receipt must be presented to the authorized service center before warranty repairs are rendered.

The limited warranty described herein is in addition to whatever implied warranties may be granted to purchasers by law. **ALL IMPLIED WARRANTIES INCLUDING THE WARRANTIES OF MERCHANTABILITY AND FITNESS FOR USE ARE LIMITED TO THE PERIOD(S) FROM THE DATE OF PURCHASE SET FORTH BELOW.** Some states do not allow limitations on how long an implied warranty lasts, so the above limitation may not apply to you.

Neither the sales personnel of the seller nor any other person is authorized to make any warranties other than those described herein, or to extend the duration of any warranties beyond the time period described herein on behalf of Haier.

The warranties described herein shall be the sole and exclusive warranties granted by Haier and shall be the sole and exclusive remedy available to the purchaser. Correction of defects in the manner and for the period of time described herein, shall constitute complete fulfillment of all abilities and Responsibility of Haier to the purchaser with respect to the product, and shall constitute full satisfaction of all claims, whether based on contract, negligence, strict duality or otherwise. In no event shall Haier be liable, or in any way responsible for any damages or defects in the product which were caused by repairs or attempted repairs performed by anyone other than an authorized service center or dealer; nor shall Haier be liable, or in any way responsible for incidental or consequential economic or property damage. Some states do not allow the exclusion of incidental or consequential damages, so that above exclusion may not apply to you.

THIS WARRANTY GIVES YOU SPECIFIC LEGAL RIGHTS. YOU MAY ALSO HAVE OTHER RIGHTS WHICH VARY FROM STATE TO STATE.

Warranty period for LE32C13200, and LE40C13800 1 year parts and labor.

Additional items excluded from warranty coverage: non-rechargeable batteries. What to do to obtain service or to obtain product literature, accessories, supplies or customer assistance: Simply call 1-877-337-3639. Be sure to have proof of purchase.

Haier®