

# PN-455

# LCD MONITOR

## ENGLISH

### IMPORTANT:

To aid reporting in case of loss or theft, please record the product's model and serial numbers in the space provided. The numbers are located in the rear of the product.

Model No.:

Serial No.:

U.S.A. ONLY

## IMPORTANT INFORMATION

**WARNING:** TO REDUCE THE RISK OF FIRE OR ELECTRIC SHOCK, DO NOT EXPOSE THIS PRODUCT TO RAIN OR MOISTURE.



### CAUTION

RISK OF ELECTRIC SHOCK  
DO NOT OPEN



CAUTION: TO REDUCE THE RISK OF ELECTRIC SHOCK, DO NOT REMOVE COVER.  
NO USER-SERVICEABLE PARTS INSIDE.  
REFER SERVICING TO QUALIFIED SERVICE PERSONNEL.



The lightning flash with arrowhead symbol, within an equilateral triangle, is intended to alert the user to the presence of uninsulated "dangerous voltage" within the product's enclosure that may be of sufficient magnitude to constitute a risk of electric shock to persons.



The exclamation point within a triangle is intended to alert the user to the presence of important operating and maintenance (servicing) instructions in the literature accompanying the product.

## IMPORTANT INFORMATION (Continued)

**WARNING:** FCC Regulations state that any unauthorized changes or modifications to this equipment not expressly approved by the manufacturer could void the user's authority to operate this equipment.

U.S.A. ONLY

**CAUTION:** Use the supplied AC cord as it is.

### INFORMATION:

This equipment has been tested and found to comply with the limits for Class A digital equipment, pursuant to Part 15 of the FCC Rules. These limits are designed to provide reasonable protection against harmful interference in a residential installation. This equipment generates, uses, and can radiate radio frequency energy and, if not installed and used in accordance with the instructions, may cause harmful interference to radio communications. However, there is no guarantee that interference will not occur in a particular installation. If this equipment does cause harmful interference to radio or television reception, which can be determined by turning the equipment off and on, the user is encouraged to try to correct the interference by one or more of the following measures:

- Relocate or adjust the receiving antenna.
- Increase the separation between the equipment and receiver.
- Connect the equipment into an outlet on a circuit different from that to which the receiver is connected.
- Consult an authorized dealer or experienced radio/TV technician for help.

U.S.A. ONLY

### CAUTION

**Danger of explosion if battery is incorrectly replaced.**

**Replace only with the same or equivalent type  
recommended by the manufacturer.  
Dispose of used batteries according  
to local regulations.**

This product utilizes fluorescent tubes containing a small amount of mercury. Disposal of these materials may be regulated due to environmental considerations. For disposal or recycling information, please contact your local authorities or the Electronic Industries Alliance: [www.eia.org](http://www.eia.org)

# DEAR SHARP CUSTOMER

Thank you for your purchase of a SHARP LCD product. To ensure safety and many years of trouble-free operation of your product, please read the Safety Precautions carefully before using this product.

## SAFETY PRECAUTIONS

Electricity is used to perform many useful functions, but it can also cause personal injuries and property damage if improperly handled. This product has been engineered and manufactured with the highest priority on safety. However, improper use can result in electric shock and/or fire. In order to prevent potential danger, please observe the following instructions when installing, operating and cleaning the product. To ensure your safety and prolong the service life of your LCD product, please read the following precautions carefully before using the product.

1. Read instructions — All operating instructions must be read and understood before the product is operated.
  2. Keep this manual in a safe place — These safety and operating instructions must be kept in a safe place for future reference.
  3. Observe warnings — All warnings on the product and in the instructions must be observed closely.
  4. Follow instructions — All operating instructions must be followed.
  5. Cleaning — Unplug the power cord from the AC outlet before cleaning the product. Use a damp cloth to clean the product. Do not use liquid cleaners or aerosol cleaners.
  6. Attachments — Do not use attachments not recommended by the manufacturer. Use of inadequate attachments can result in accidents.
  7. Water and moisture — Do not use the product near water, such as bathtub, washbasin, kitchen sink and laundry tub, swimming pool and in a wet basement.
  8. Stand — Do not place the product on an unstable cart, stand, tripod or table. Placing the product on an unstable base can cause the product to fall, resulting in serious personal injuries as well as damage to the product.
  9. Ventilation — The vents and other openings in the cabinet are designed for ventilation. Do not cover or block these vents and openings since insufficient ventilation can cause overheating and/or shorten the life of the product. Do not place the product on a bed, sofa, rug or other similar surface, since they can block ventilation openings. Do not place the product in an enclosed place such as a bookcase or rack, unless proper ventilation is provided or the manufacturer's instructions are followed.
- 
10. Power cord protection — The power cords must be routed properly to prevent people from stepping on them or objects from resting on them.
  11. The LCD panel used in this product is made of glass. Therefore, it can break when the product is dropped or applied with impact. Be careful not to be injured by broken glass pieces in case the LCD panel breaks.
  12. Overloading — Do not overload AC outlets or extension cords. Overloading can cause fire or electric shock.
  13. Entering of objects and liquids — Never insert an object into the product through vents or openings. High voltage flows in the product, and inserting an object can cause electric shock and/or short internal parts.  
For the same reason, do not spill water or liquid on the product.
  14. Servicing — Do not attempt to service the product yourself. Removing covers can expose you to high voltage and other dangerous conditions. Request a qualified service person to perform servicing.
  15. Repair — If any of the following conditions occurs, unplug the power cord from the AC outlet, and request a qualified service person to perform repairs.
    - a. When the power cord or plug is damaged.
    - b. When a liquid was spilled on the product or when objects have fallen into the product.
    - c. When the product has been exposed to rain or water.
    - d. When the product does not operate properly as described in the operating instructions.  
Do not touch the controls other than those described in the operating instructions. Improper adjustment of controls not described in the instructions can cause damage, which often requires extensive adjustment work by a qualified technician.

## SAFETY PRECAUTIONS (Continued)

---

- e. When the product has been dropped or damaged.
  - f. When the product displays an abnormal condition. Any noticeable abnormality in the product indicates that the product needs servicing.
16. Replacement parts — In case the product needs replacement parts, make sure that the service person uses replacement parts specified by the manufacturer, or those with the same characteristics and performance as the original parts. Use of unauthorized parts can result in fire, electric shock and/or other danger.
  17. Safety checks — Upon completion of service or repair work, request the service technician to perform safety checks to ensure that the product is in proper operating condition.
  18. Wall or ceiling mounting — When mounting the product on a wall or ceiling, be sure to install the product according to the method recommended by the manufacturer.
  19. Heat sources — Keep the product away from heat sources such as radiators, heaters, stoves and other heat-generating products (including amplifiers).
  20. Power source — This product must operate on a power source specified on the specification label. If you are not sure of the type of power supply used in your home, consult your dealer or local power company.  
For units designed to operate on batteries or another power source, refer to the operating instructions.

**WARNING:**

This is a class A product. In a domestic environment this product may cause radio interference in which case the user may be required to take adequate measures.

**WARNING:**

To reduce the risk of fire or electric shock, do not expose this product to rain or moisture.

## TIPS AND SAFETY PRECAUTIONS

- The TFT color LCD panel used in this monitor is made with the application of high precision technology. However, there may be minute points on the screen where pixels never light or are permanently lit. Also, if the screen is viewed from an acute angle there may be uneven colors or brightness. Please note that these are not malfunctions but common phenomena of LCDs and will not affect the performance of the monitor.
- Do not display the same image on the screen for a long period of time, as this may cause an afterimage to remain.
- The quality of the computer signal may influence the quality of the display. We recommend using a computer able to perform high quality video signals.
- Never rub or tap the monitor with hard objects.
- Please understand that Sharp Corporation bears no responsibility for errors made during use by the customer or a third party, nor for any other malfunctions or damage to this product arising during use, except where indemnity liability is recognized under law.
- This monitor and its accessories may be upgraded without advance notice.
- Do not use the monitor where ventilation is poor, where there is a lot of dust, where humidity is high, or where the monitor may come into contact with oil or steam, as this could lead to fire.
- Ensure that the monitor does not come into contact with water or other fluids. Ensure that no objects such as paper clips or pins enter the monitor as this could lead to fire or electric shock.
- Do not place the monitor on top of unstable objects or in unsafe places. Do not allow the monitor to receive strong shocks or to strongly vibrate. Causing the monitor to fall or topple over may damage it.
- Do not use in places where the monitor will be subject to direct sunlight, near heating equipment or anywhere else where there is likelihood of high temperature, as this may lead to generation of excessive heat and outbreak of fire.

### The Power Cord

- Do not damage the power cord nor place heavy objects on it, stretch it or over bend it. Also, do not add extension cords. Damage to the cord may result in fire or electric shock.
- Use only the power cord supplied with the monitor.
- Insert the power plug directly into the AC outlet. Adding an extension cord may lead to fire as a result of overheating.
- Do not remove or insert the power plug with wet hands. Doing so could result in electric shock.

### Manual Scope

- In this manual, Microsoft Windows XP will be referred to as "Windows XP", and Microsoft Windows 2000 as "Windows 2000".  
When there is no need to distinguish between programs, the term "Windows" will be used.
- Microsoft and Windows are registered trademarks of Microsoft Corporation.
- All other brand and product names are trademarks or registered trademarks of their respective holders.
- Language of OSD menu used in this manual is English by way of example.
- Illustrations in this manual may not exactly represent the actual product or display.

### Fluorescent Tubes

- The fluorescent tubes in this product have a limited lifetime.
  - \* If the screen gets dark, flashes, or does not turn on, change the fluorescent tubes with new exclusive ones.
  - \* For more information, please contact your product dealer.
- Because of the property of fluorescent tubes, the screen may flash during the initial period of use. If this happens, please turn off the main power switch on the top of the monitor and turn on again to confirm operation.

# Contents

<b>Introduction</b>	
<b>IMPORTANT INFORMATION</b> .....	1
<b>DEAR SHARP CUSTOMER</b> .....	3
<b>SAFETY PRECAUTIONS</b> .....	3
<b>TIPS AND SAFETY PRECAUTIONS</b> .....	5
<b>Features</b> .....	7
<b>Supplied Accessories</b> .....	8
<b>Part Names - Display</b> .....	9
Front view .....	9
Rear view .....	10
<b>Part Names - Remote Control Unit</b> .....	11
Removing the battery cover .....	12
Remote control operation range .....	12
<b>Connection and Installation</b>	
<b>Connecting Peripheral Equipment</b> .....	13
<b>Connecting External Speakers</b> .....	18
<b>Connecting the AC Cord</b> .....	19
<b>Connecting Multiple Monitors</b> .....	20
<b>Mounting Precautions</b> .....	21
<b>Mounting the Temporary Stands</b> .....	22
<b>Bundling Cables</b> .....	22
<b>Attaching the Carrying Handles</b> .....	23
<b>Basic Operation</b>	
<b>Turning on Power</b> .....	24
Main power switch .....	24
Turning power on/off using remote control .....	24
<b>Remote Control Unit</b> .....	25
<b>Menu Items</b> .....	26
Menu option selection .....	26
Menu screen explanation .....	28
<b>Initialization (Reset)/Functional Restriction Setting</b> .....	29
<b>Settings and Adjustments</b> .....	30
Screen display for adjustments (INPUT2) .....	36
Set-up information (INPUT1 / INPUT2) .....	37
<b>PC Operation</b>	
<b>PC Operation</b> .....	38
PC connection .....	38
Communication conditions .....	39
Communication procedure .....	40
RS-232C command table .....	47
<b>Troubleshooting and Specifications</b>	
<b>Troubleshooting</b> .....	52
<b>Specifications</b> .....	54
<b>Appendix</b>	
<b>PC Digital/Analog Signal Input Compatibility Chart</b> .....	56
<b>Connector Compatibility Charts</b> .....	57
<b>Dimensional Drawings</b> .....	58
<b>Menu Option Reference Chart</b> .....	59

# Features

## ● HIGH-DEFINITION (HD) LCD PANEL

- A large, flat LCD panel with 1920 x 1080 pixels lets you enjoy a detailed, high-definition picture.

## ● ASV\*LOW-REFLECTION BLACK TFT LCD PANEL

- SHARP's unique ASV\* low-reflection BLACK TFT LCD panel provides higher luminance, higher contrast, and a wider viewing angle. This reduces reflection in the monitor when it is placed near a window, and ensures brighter, more vivid image reproduction. With a wide viewing angle of 170 degrees, both horizontally and vertically, the image is beautiful, even when viewed off axis.

\* ASV: Advanced Super View

## ● EQUIPPED WITH A VARIETY OF TERMINALS

- PC digital RGB input terminal (See pages 10 and 13.)
- PC analog RGB input terminal (See pages 10 and 14.)
- Component input terminal (See pages 10 and 15)
- Composite Video input terminal (See pages 10 and 16.)
- S-video input terminal (See pages 10 and 16.)
- RS-232C input terminal (See pages 10 and 21.)

## ● ENLARGEMENT FUNCTION

- Allows output of enlarged images for 4- or 9-screen ("2 x 2" or "3 x 3") setups, without using special-purpose external equipment. (See page 33.)

## ● CHAIN CONNECTION OF MULTIPLE MONITORS

- Enables chain connection of monitors using PC analog RGB output terminal. (See page 20.)
- Enables individual control via PC of multiple sets connected in a daisy chain using RS-232C cables. (See pages 21 and 39.)

## ● EXTERNAL CONTROL AND STATUS MONITORING FROM A PC

- The monitor can be controlled in various ways from a PC. (See page 38.)
- Multiple monitors can be individually controlled by connecting them in a daisy chain. (See pages 21 and 39.)

## ● EXTERNAL SPEAKERS CAN BE CONNECTED

- Compatible speakers: L/R, 6  $\Omega$ , 10W or larger (See page 18.)

## ● CONTROL LOCK FUNCTIONS

- The monitor is equipped with various operation lock functions to prevent unintended operation or mischief. (See page 29.)

# Supplied Accessories

Make sure the following accessories are provided with the product.

Liquid Crystal Display (1)

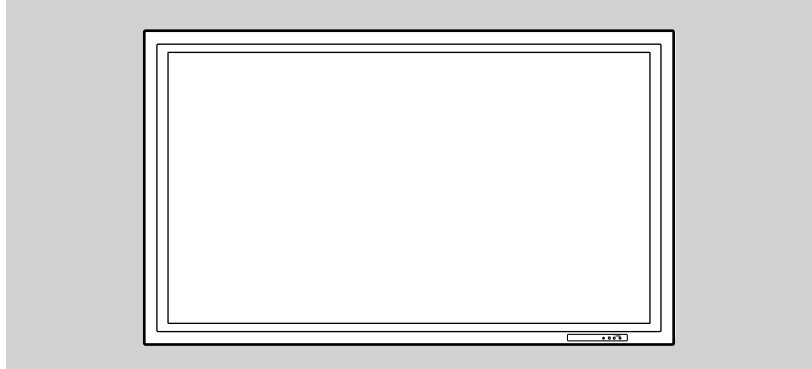

AC cord (1)

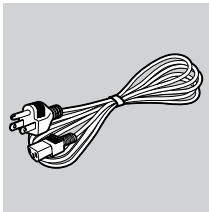

(0PEQACCU1026M)

CD-ROM (1)

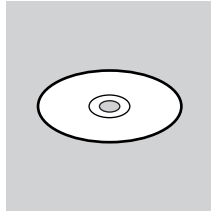

(Utility Disk for Windows)

Temporary stand (2)

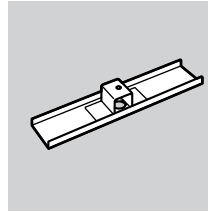

● Temporary stand mounting screw (2)

Cable clamp (2)

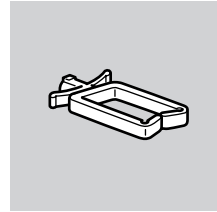

“AA” size battery (2)

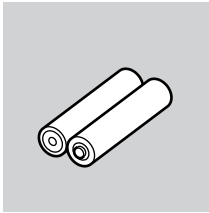

Remote control unit (1)

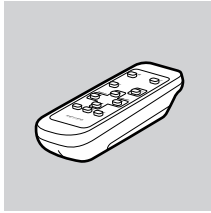

Carrying handle (2)

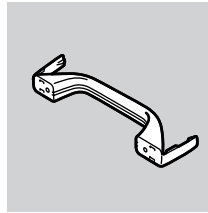

● Carrying handle mounting screw (4) / Spacer (4)

AC cord clamp (1)

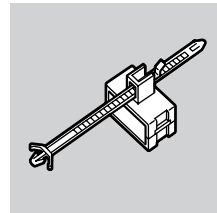

● Operation manual (1)    ● Video connection cable (1) (0PE1S8022411/)    ● Component connection cable (1) (0PEQCNW-1165M)



- You are advised to retain the carton in case the monitor needs to be transported.
- Sharp Corporation holds authorship rights to the Utility Disk program. Do not reproduce it without permission.



# Part Names - Display

## Front view

Liquid Crystal Display panel

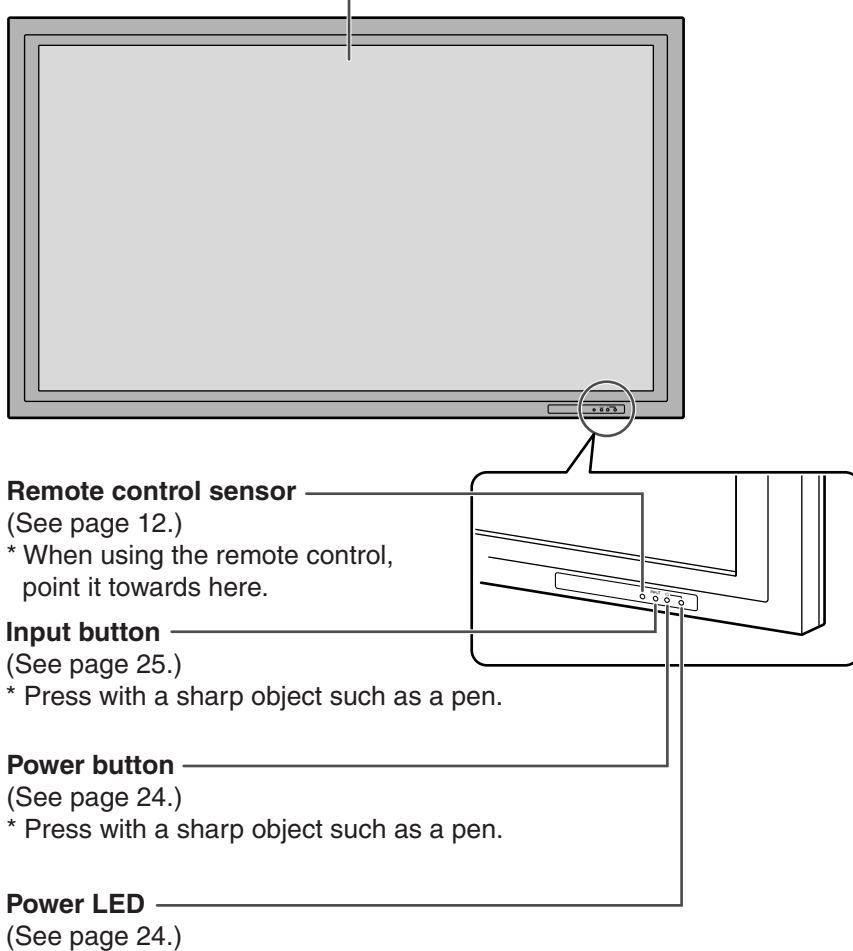

# Part Names - Display (Continued)

## Rear view

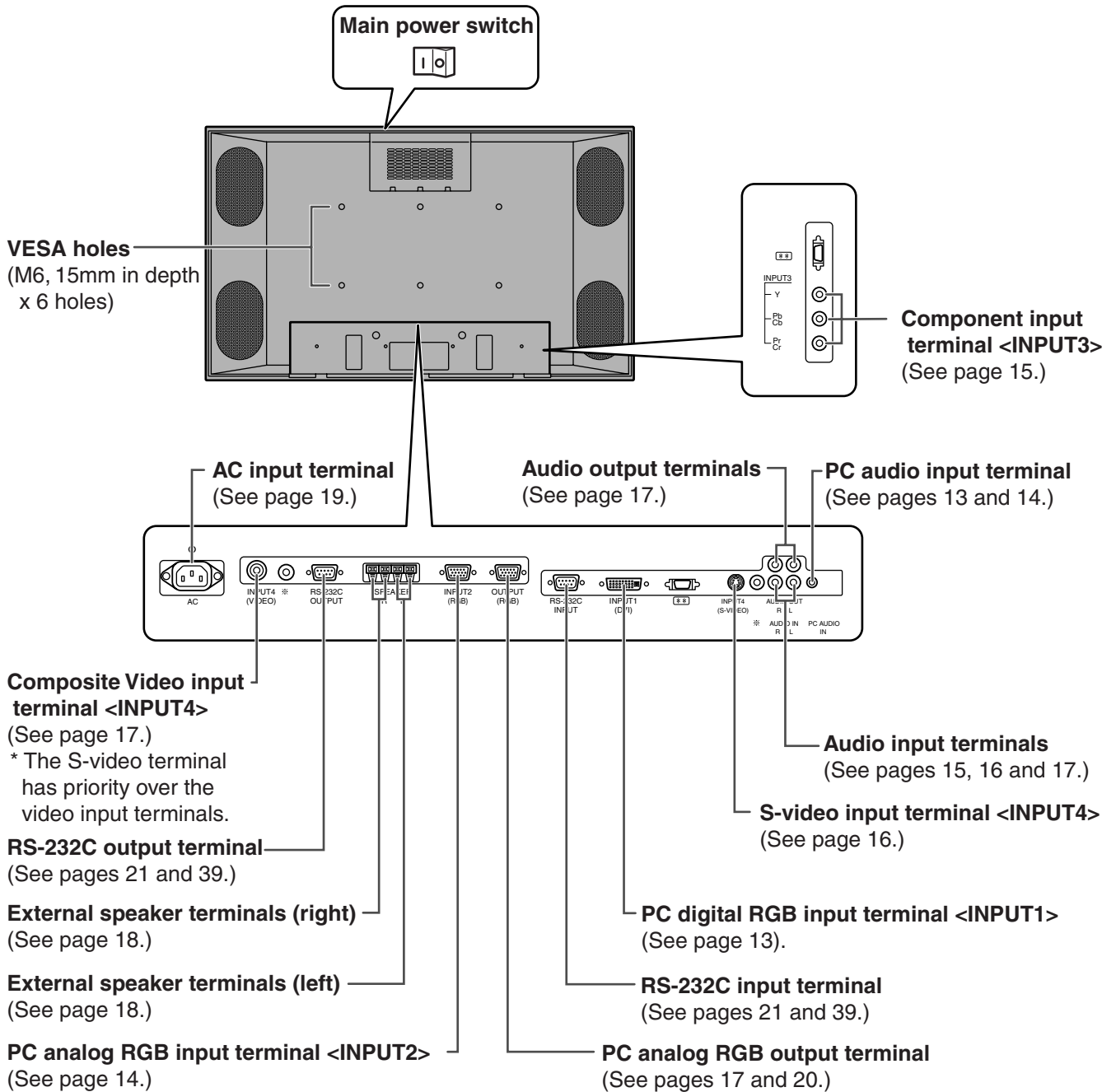

# Part Names - Remote Control Unit

## Remote control unit

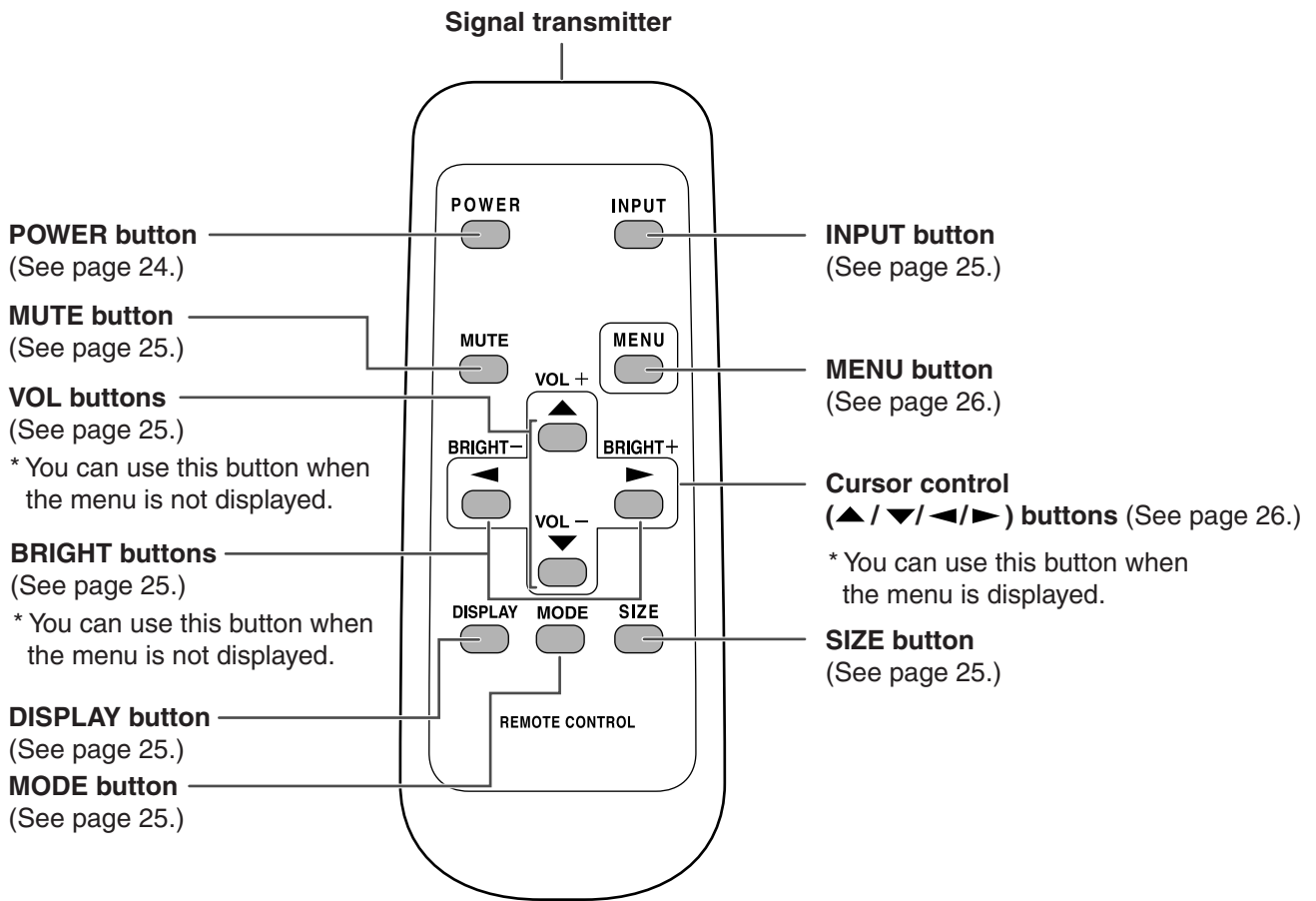

# Part Names - Remote Control Unit (Continued)

## Removing the battery cover

Gently hold down and press in the arrow direction.

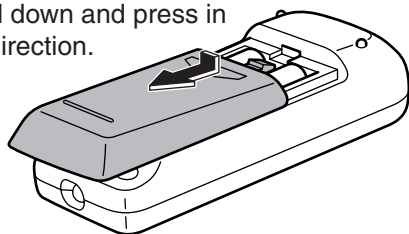

## Cautions regarding remote control unit

- Do not expose the remote control unit to shock. In addition, do not expose the remote control unit to liquids, and do not place it in an area with high humidity.
- The remote control unit may not work properly if the remote control sensor is under direct sunlight or strong lighting. In such cases, change the angle of the lighting or the monitor, or operate the remote control unit closer to the remote control sensor.



- The batteries supplied with this product may have a shorter life expectancy due to storage conditions. Replace with new batteries at the earliest opportunity.
- If you will not use the remote control for a long time, remove the batteries.
- If the remote control does not work, even with new batteries, take the batteries out, check whether they are facing the right way, then replace them.
- Do not use rechargeable (Nickel-metal-hydride) batteries.

## Remote control operation range

Operation range of the remote control unit is approx. 7 m (23 ft.) and an angle of approx. 10° from the center to the top/bottom/right/left of the remote control sensor.

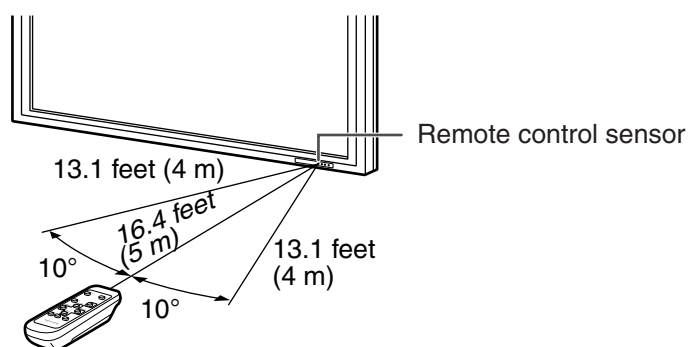

## If the remote control unit does not work well:

- Objects between the remote control unit and the remote control sensor may prevent proper operation.
- Replace the batteries when they run low as this may shorten the remote control's operation range.
- If a fluorescent light is illuminated near the remote control unit, it may interfere with proper operation.
- Do not use it with the remote control of other equipment such as air conditioner, stereo components, etc.

# Connecting Peripheral Equipment

The various terminals on the LCD panel are described below.

## INPUT1 (PC DIGITAL)

- Connect with the digital RGB output terminal on your computer using a digital signal cable (commercially available).
  - \* Connection with computers that have an output terminal (DVI-D 24 pin or DVI-I 29 pin) conforming to DVI is possible. (However, images may not display properly depending on the computer.)
- Connect with an audio output jack on your computer using a PC audio cable (commercially available).

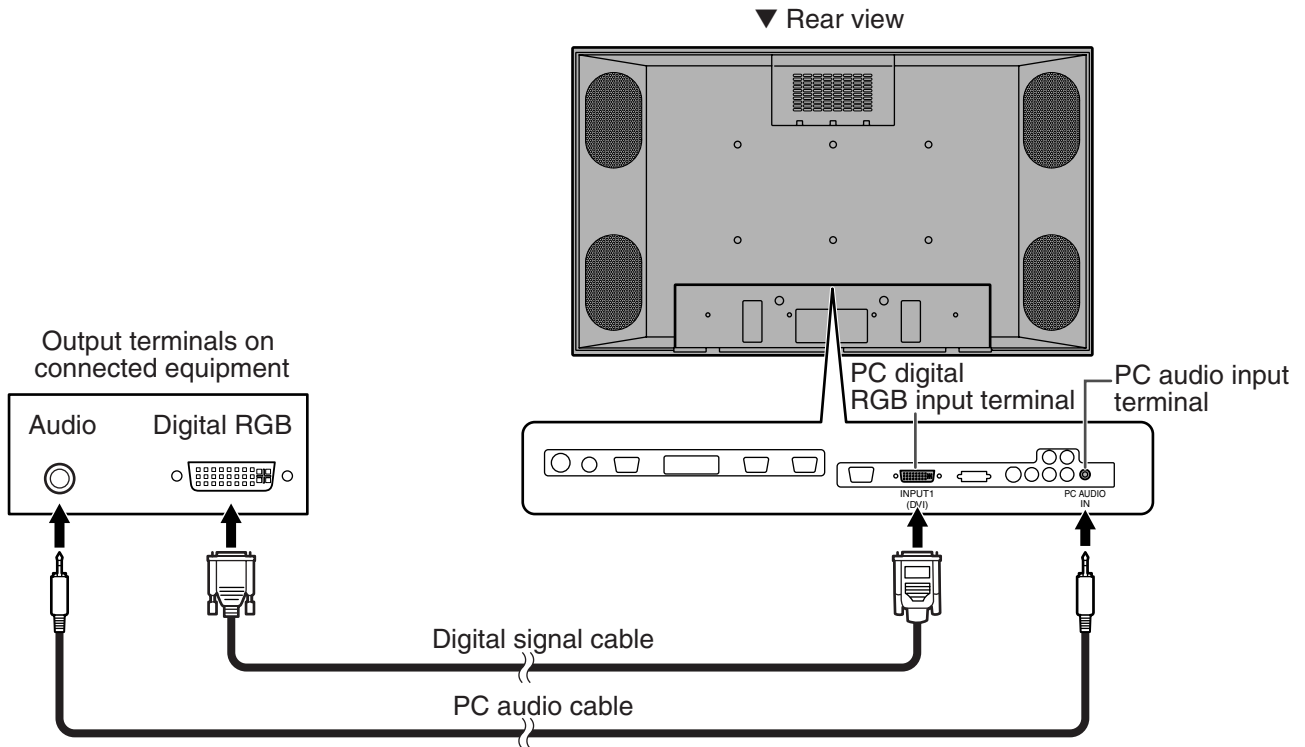

\* See page 56 for compatible signals.

# Connecting Peripheral Equipment (Continued)

## INPUT2 (PC ANALOG)

- Connect with the display connector on your computer using a RGB cable (commercially available).
- Connect with an audio output jack on your computer using a PC audio cable (commercially available).

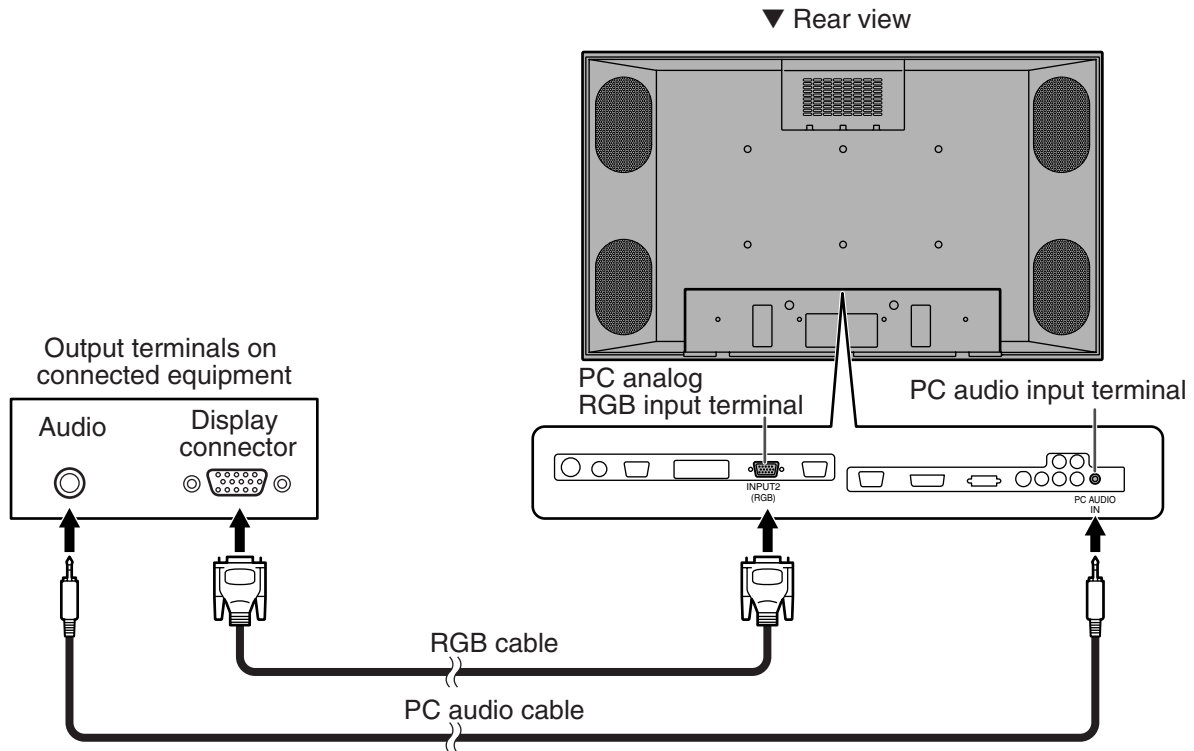

\*1 Auto-detects sync signal type.

\*2 Sync signal presence is detected in the order: Composite Sync, Separate Sync and Sync-on-green. If for some reason Composite Sync and Separate Sync are not input, the system will operate assuming that the signal is a Sync-on-green (i.e. that the sync signal is contained in the G signal of RGB). This may result in an unstable image, depending on the video signal.

\*3 See page 56 for compatible signals.

## INPUT3 (COMPONENT)

- Connect with component output terminals using a component cable (commercially available).
- Connect with an audio output terminal using an audio (RCA) cable (commercially available).

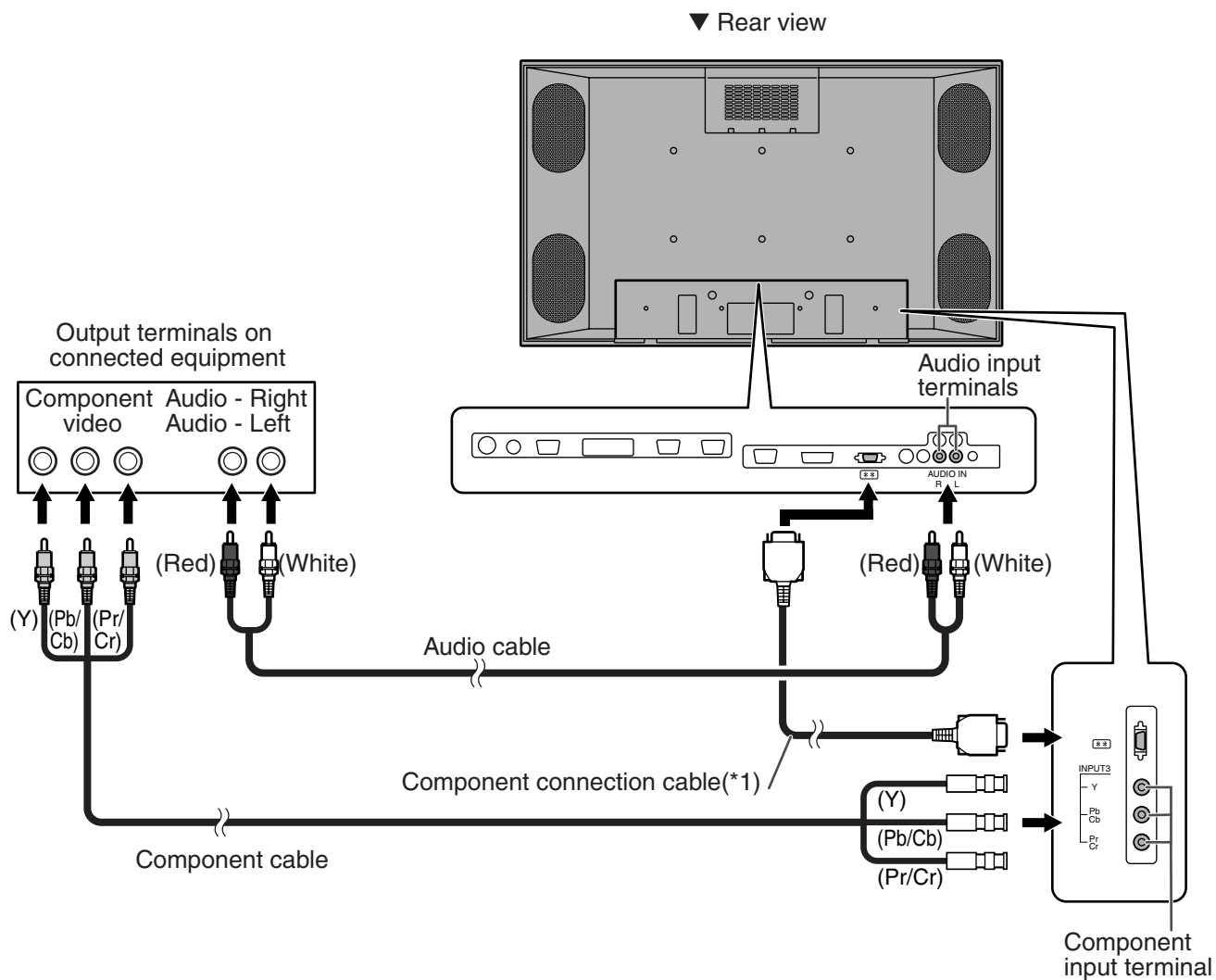

\*1 When you connect the monitor with equipment that has a component output terminal, you can use the supplied component connection cable as shown in the illustration above.

# Connecting Peripheral Equipment (Continued)

## INPUT4 (S-VIDEO/VIDEO)

- Connect with equipment that has an S-video output terminal using an S-video cable (commercially available).\*
- Connect with equipment that has a video output terminal using a video (BNC) cable (commercially available).\*
- Connect with an audio output terminal using an audio (RCA) cable (commercially available).

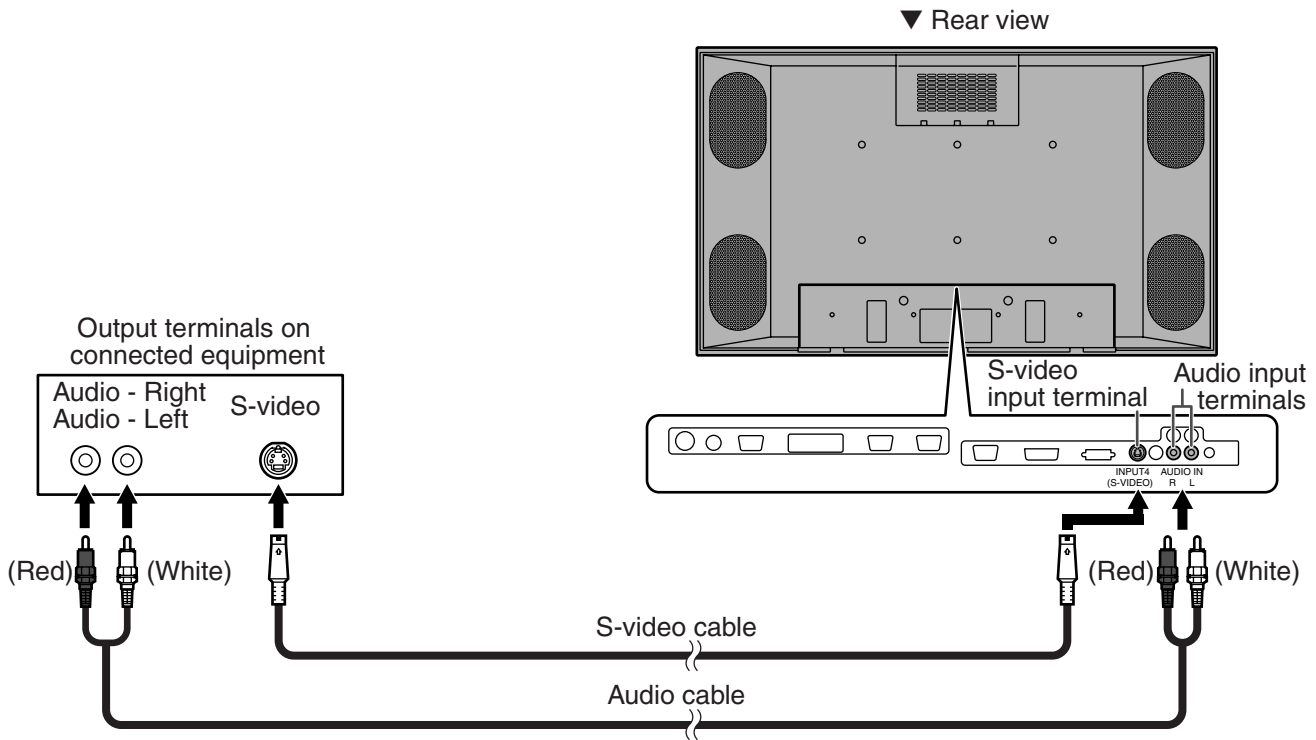

Compatible S-video signal	NTSC (3.58 MHz)
---------------------------	-----------------

\* S-video input will have priority over composite video when connected.



▼ Rear view

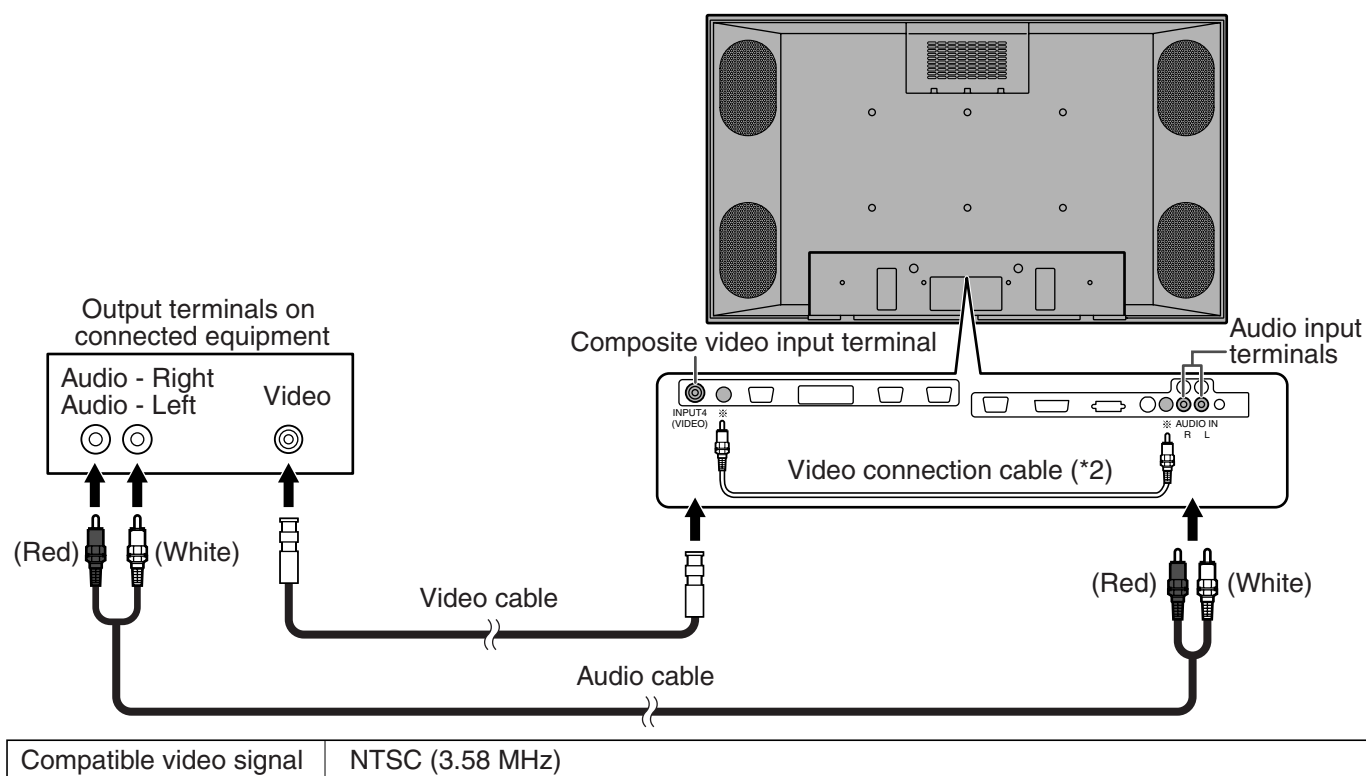

\*1 S-video input will have priority over composite video when connected.

\*2 When you connect the monitor with equipment that has a video output terminal, you can use the supplied video connection cable as shown in the illustration above.

## PC ANALOG RGB OUTPUT TERMINAL

- Video signal from INPUT2 (PC analog) is output. Use when connecting multiple monitors in a daisy chain via RGB cables (commercially available). See page 20 for a detailed connection example.

## AUDIO OUTPUT TERMINAL

- Audio from the equipment connected to the audio input terminal or PC audio input terminal is output. Connect to the audio input terminal of the connected equipment using an audio (RCA) cable (commercially available) or a PC audio cable (commercially available).
- The terminal for which audio is output differs by screen mode.
  - When input mode is INPUT1 or 2, the audio from the PC audio input terminal will be output.
  - When input mode is INPUT3 or 4, the audio from the audio input terminal will be output.

# Connecting External Speakers

Be sure to use external speakers with an impedance of 6 ohms and a rated input of at least 10 W.

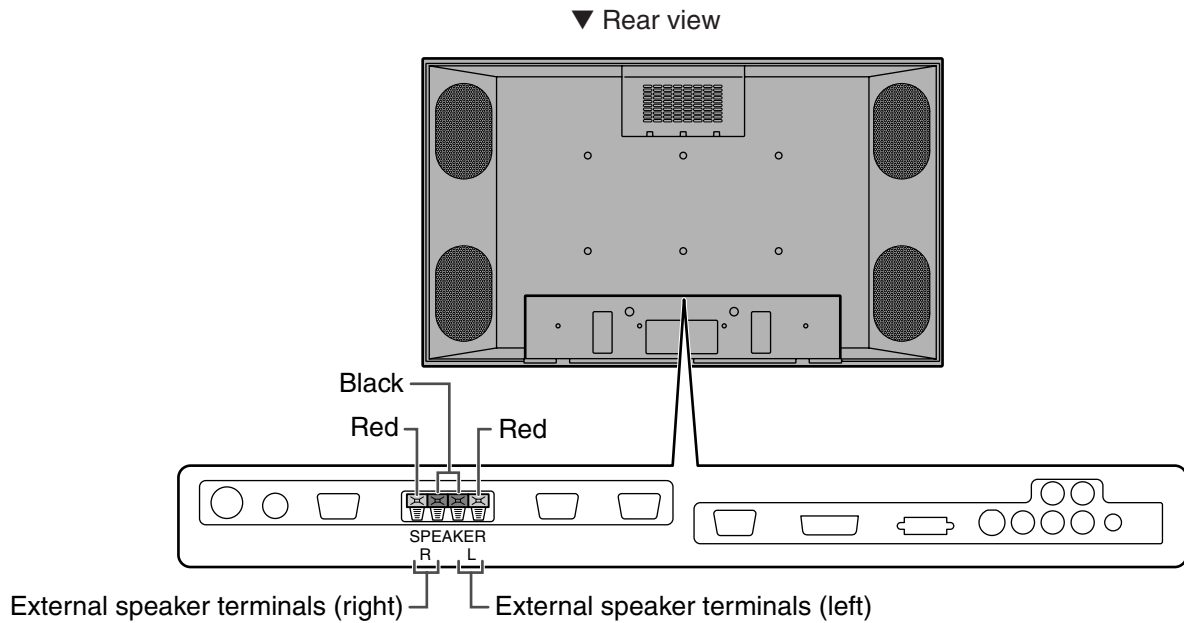

## Connecting the speaker cables

1. While pushing the tab, insert the tip of the cable.
2. Release the tab.

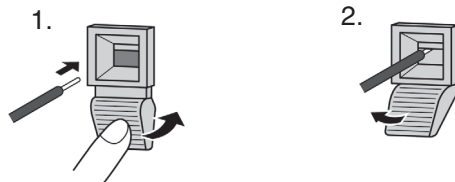

## Make sure to connect the speaker jack and cable polarity ( $\oplus$ , $\ominus$ ) properly.

The speaker jacks have plus  $\oplus$  and minus  $\ominus$  polarity. Plus is red and minus is black.

The speaker cables are also divided into plus and minus.

When connecting the left/right speakers, be sure to connect the plus/minus jacks with the correct cables.

# Connecting the AC Cord

Be sure to turn the main power switch off when connecting the cord.

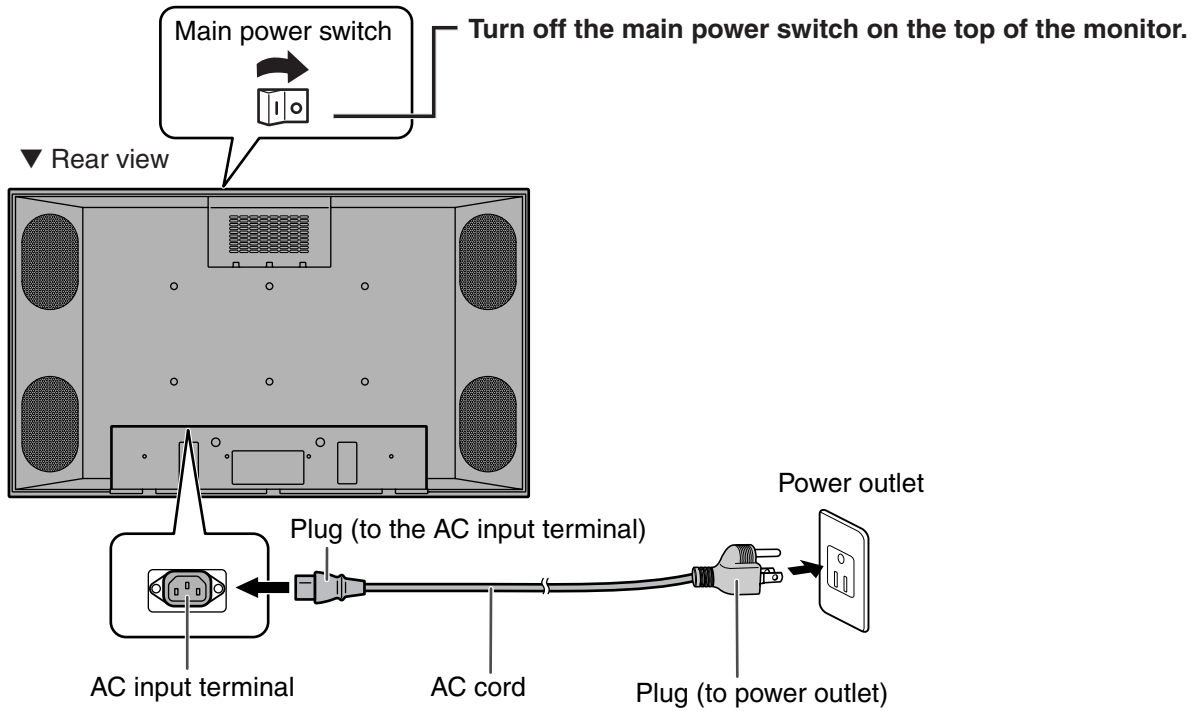

## Connecting the AC cord

1. Plug the AC cord into the AC input terminal of the monitor.
2. Plug the AC cord into the AC power outlet.

# Connecting Multiple Monitors

Multiple monitors can be connected in a daisy chain using the input/output terminals for video signals.

## Connection example

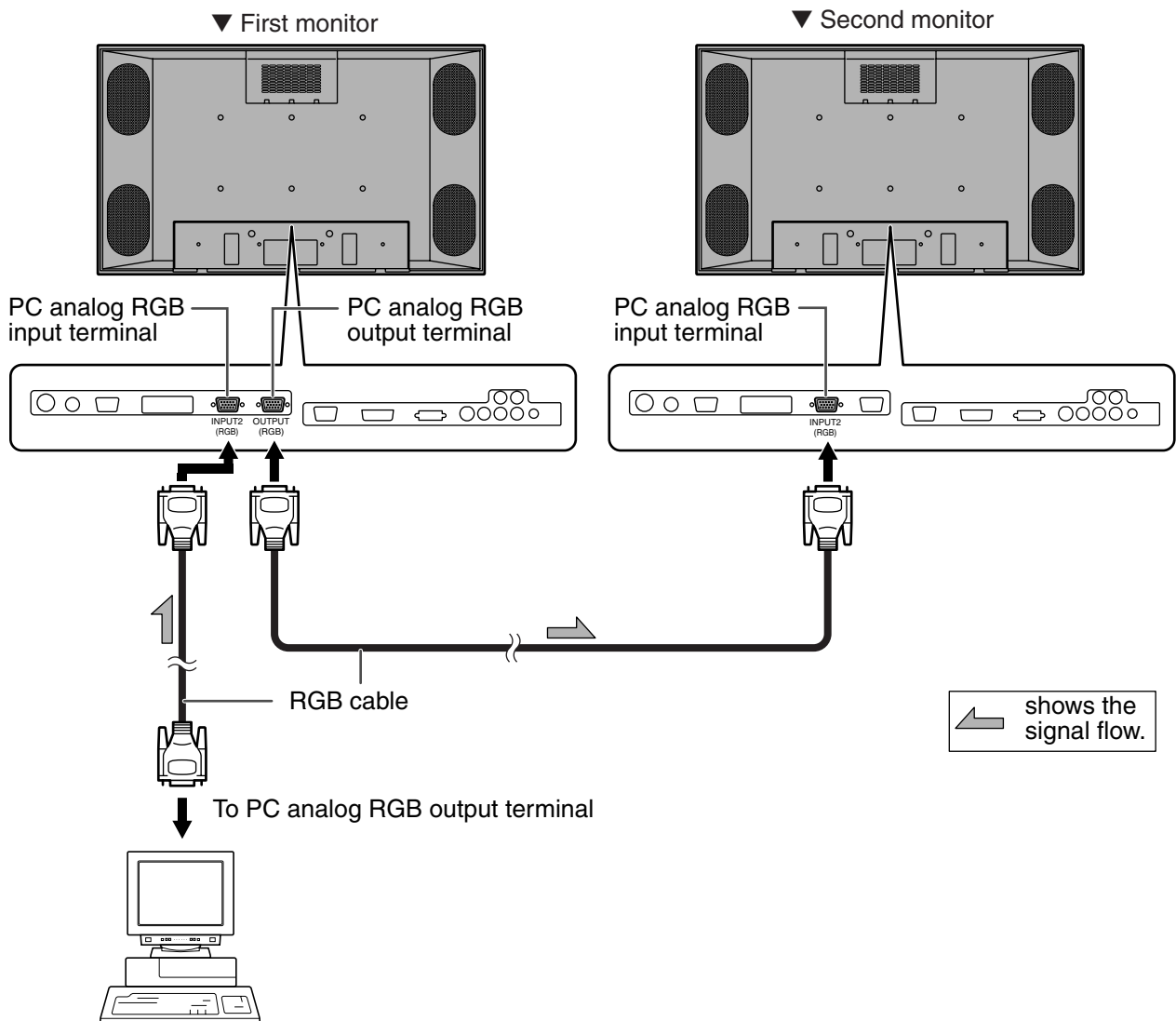

\*1 Multiple monitors cannot be connected in a daisy chain for audio. Connect the external audio amplifier to the audio output terminals.

\*2 The length of RGB cable or surrounding environment may affect the image quality.

## Connection example for RS-232C

Monitors can be externally controlled using the RS-232C interface (COM port) of a PC, and, in this case too, multiple monitors can be connected in a daisy chain. By assigning each monitor an ID number (see page 46), you can perform input switching, adjustment and status monitoring of individual monitors.

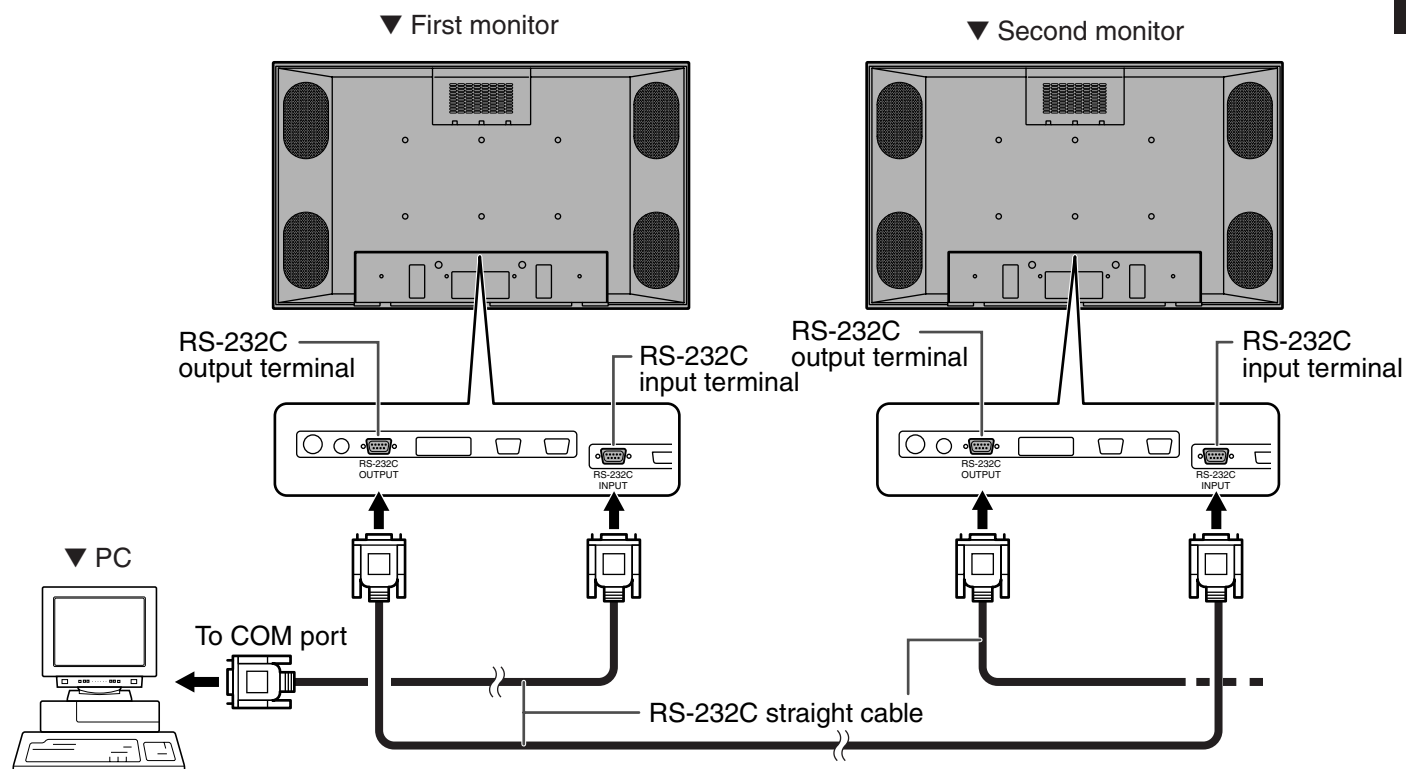

## Mounting Precautions

- Special techniques are required to mount this monitor, so be sure to rely on an authorized Sharp dealer for installation work. You should never perform any of this work yourself. Our company will bear no responsibility for accidents or injuries caused by improper mounting or handling.
- Moving or installing the monitor must be done by two or more people.
- Keep the monitor surface perpendicular to a level surface or tilt up to a maximum of 20 degrees downward.
- This monitor is equipped with two temporary stands when shipped from the factory. Please note that these stands are for temporary use only until the monitor is properly mounted.
- Be sure to use a stand or a wall-mount/ceiling-mount bracket designed or designated for mounting the monitor.
- Do not lay the monitor display-side down or up as this could lead to a malfunction.
- When mounting the monitor, the following amount of open space is required to clear the ventilation for the monitor; at least 7.9 inch (20 cm) above, 1.97 inch (5 cm) right/left/below, and 2.76 inch (7 cm) behind the monitor. Do not block any ventilation openings. If the temperature inside the monitor rises, this could lead to a malfunction.

# Mounting the Temporary Stands

Please note that the temporary stands are for temporary use only until the monitor is properly mounted. Attach each temporary stand to the bottom of the monitor as shown below.

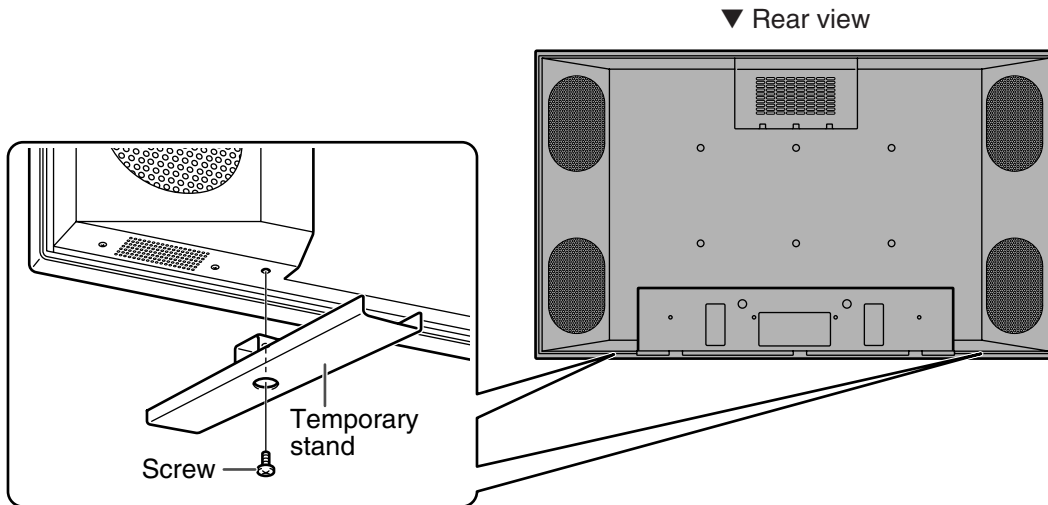

# Bundling Cables

The AC cord can be fastened using the supplied AC cord clamp. This will prevent the AC cord from falling off.

Also, the cables connected to the terminals on the back of the monitor from the external equipment can be neatly bundled using the supplied cable clamps as shown in the illustration below. This will prevent stray or disorganized cables at the back of the monitor.

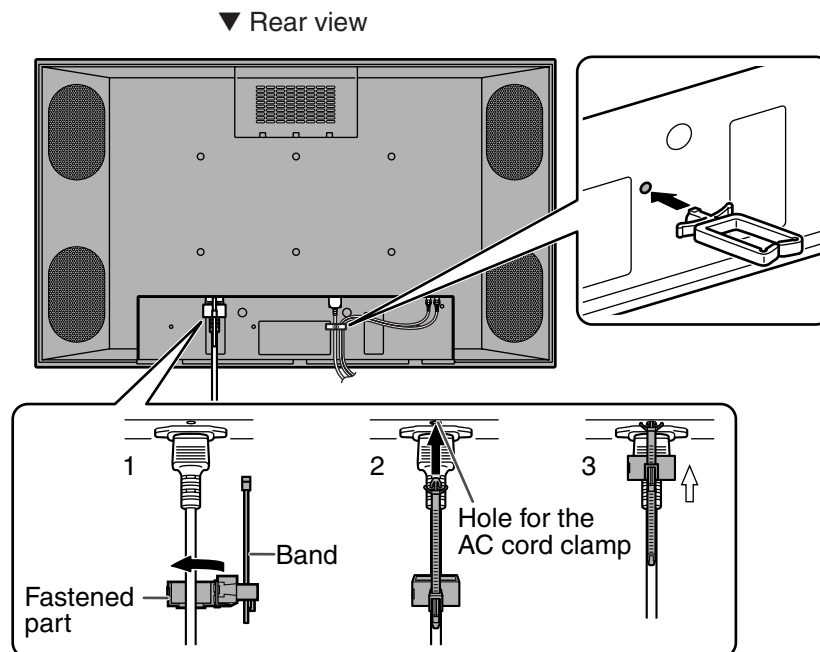

## Fastening the AC cord

1. Attach the supplied AC cord clamp to the AC cord, making sure the AC cord clamp is circular hole-side down.
2. Insert the tip of the band into the hole for the AC cord clamp.
3. While holding the tail of the band, slide the fastened part toward the AC input terminal.

# Attaching the Carrying Handles

When carrying the monitor, attach the two carrying handles to the top of the monitor as shown below.

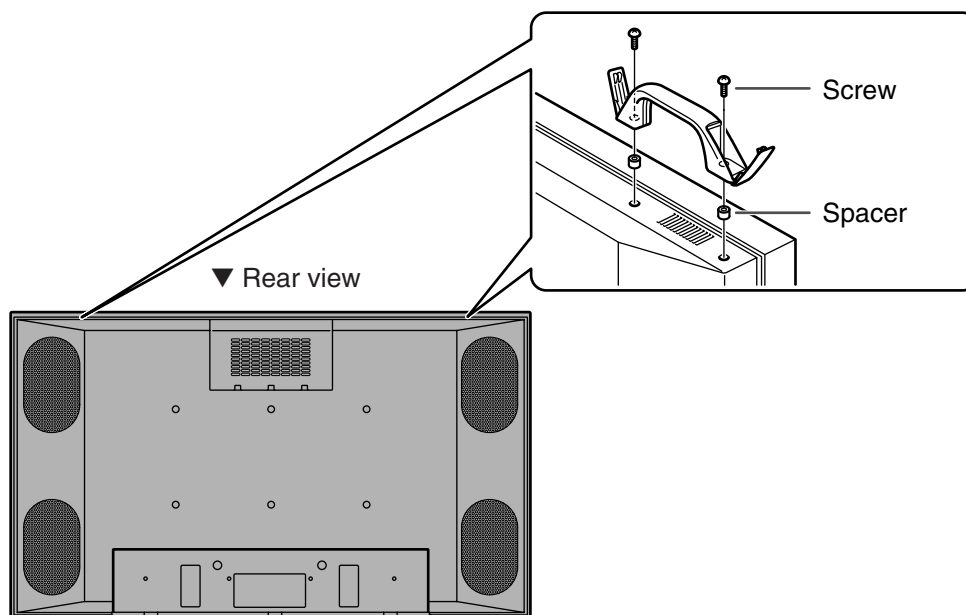

\* After mounting the monitor, remove the carrying handles from the monitor.

# Turning on Power

Before turning on power, make sure that peripherals, external speakers, and the AC cord are connected properly.

There are two power supply switches: Main power switch on the top of the monitor and POWER button on the remote control unit.

If the monitor is connected to a computer, turn on the monitor first before turning on the computer.

## Main power switch

When the main power switch is off, the monitor is not turned on with the POWER button on the remote control unit.

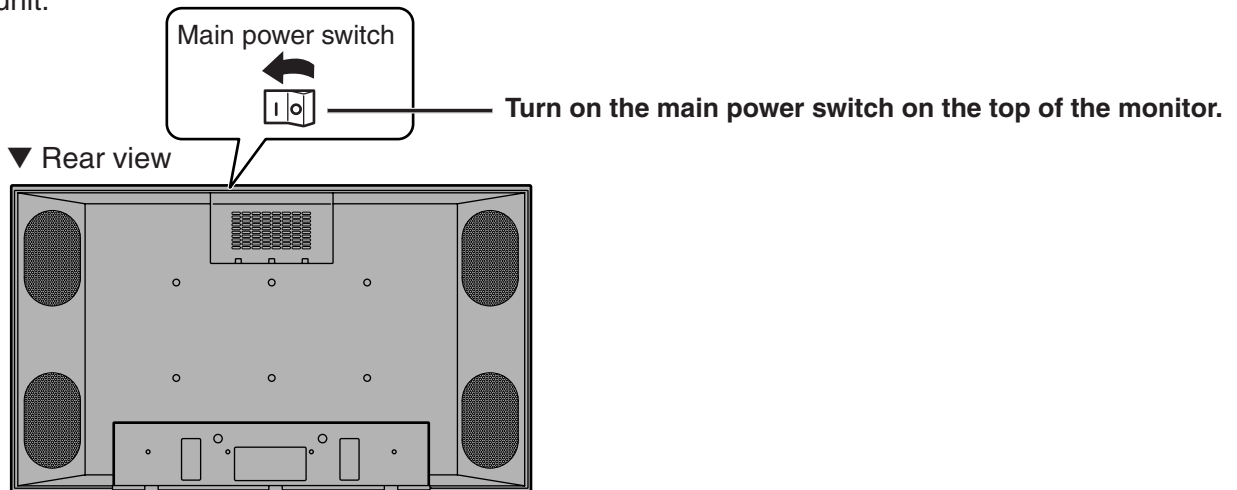

When switching the main power switch off and back on, always wait for at least 5 seconds. Rapid switching may result in a malfunction.

## Turning power on/off using remote control

### ▼ Remote control unit

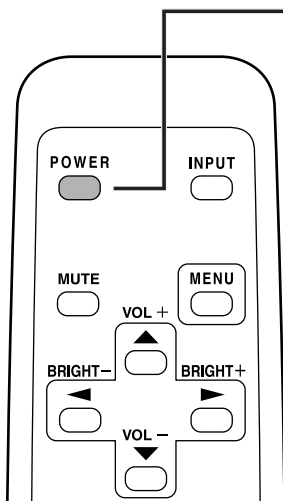

**Press the POWER button to turn the power ON/OFF.**

Power "On": Power LED lights up green.

Power "Off": Power LED lights up orange. (Standby mode)

### ▼ Front view

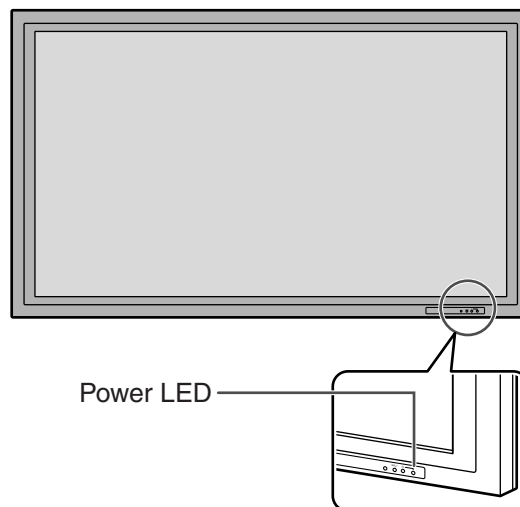

- After turning on the power, if there is no video signal, the backlight of the monitor is turned off. (Waiting mode)
- In waiting mode, the power LED blinks green.
- In waiting mode, if you press the POWER button on the remote control unit, the monitor will be turned off.
- If the remote control is not available, you can turn on/off by pressing the POWER button beside the power LED with a sharp object.



# Remote Control Unit

Generally the monitor is operated using the remote control unit.

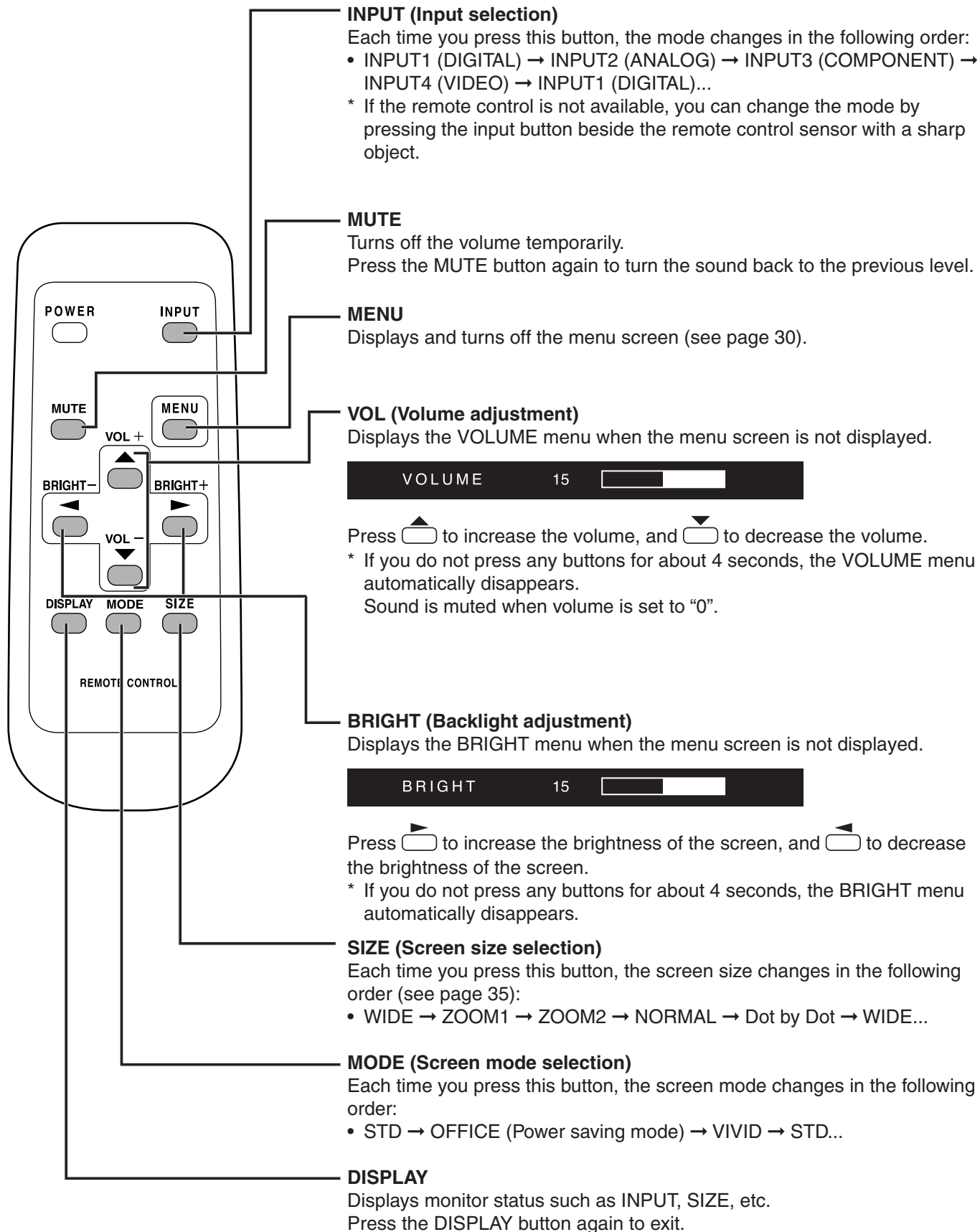

# Menu Items

Menus can be displayed on the screen to enable video and audio adjustment and the setting of various functions using the remote control unit. For more information, refer to the pages where each topic is explained.

## Menu option selection

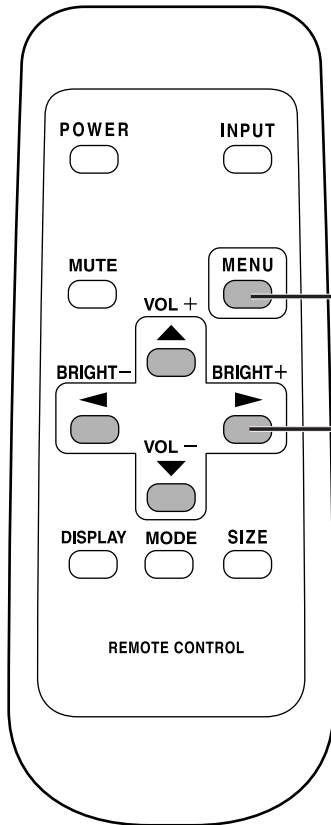

### MENU button

- Displays and turns off the menu screen.
- Switches menu screens.

### Cursor control (UP/DOWN/LEFT/RIGHT)

- / : Selects a desired item on the screen.

- / : Adjusts the selected item.

Pressing increases a value.

Pressing decreases a value.

## Example of menu operation: Adjusting CONTRAST (video) in the GAIN CONTROL menu.

1. Press to display the menu screen.

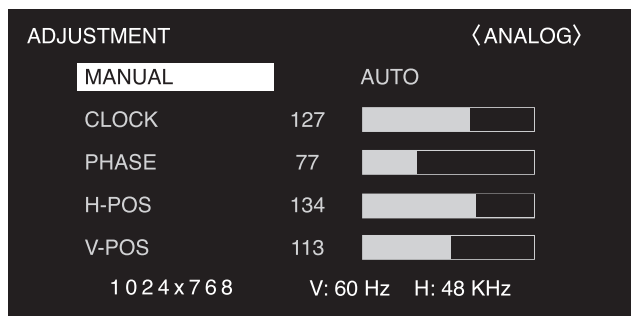

2. Press  to display the GAIN CONTROL menu.

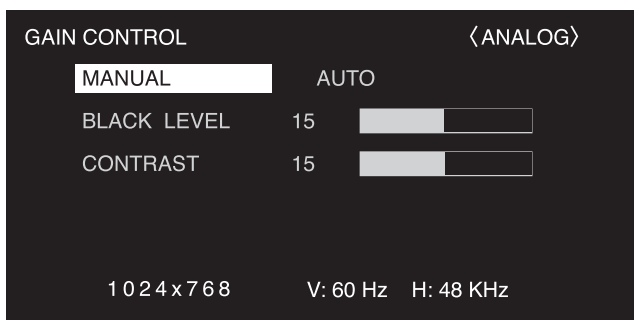

3. Press  to select CONTRAST.

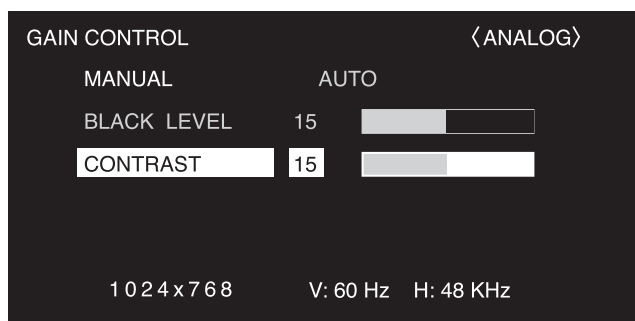

4. Press  (or ) to adjust the setting.

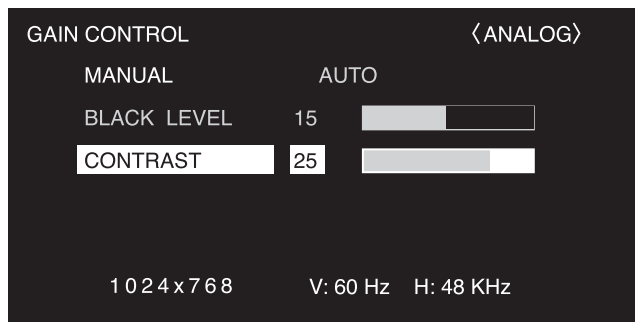

5. Press  more than once to close the menu screen.

The menu screen will close automatically if no operation is performed for about 15 seconds.



- The menu displayed when you press the MENU button will differ depending on the type of input signal.

# Menu Items (Continued)

## Menu screen explanation

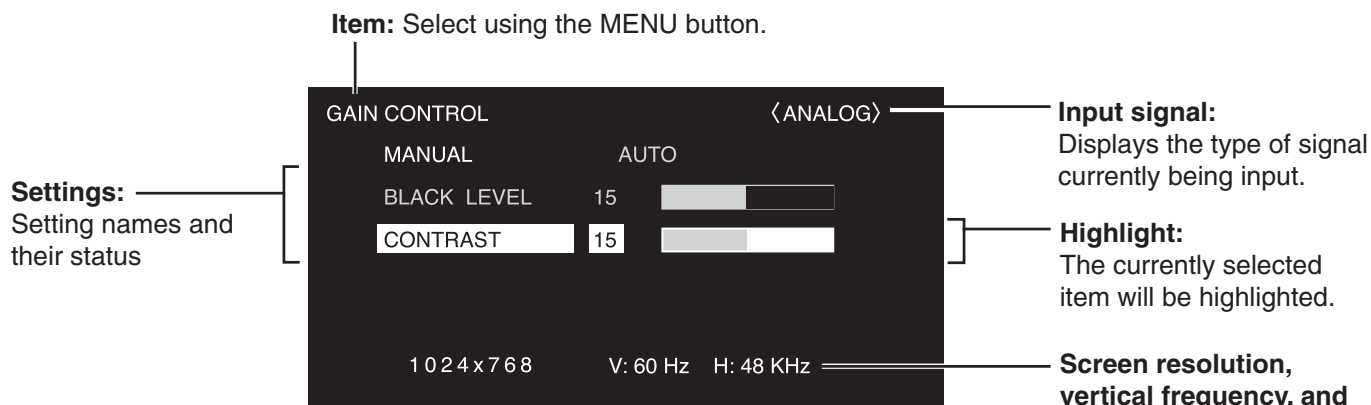

Yellow: Current setting

Blue: Selectable items

Gray: Items that cannot be selected

\* There are various reasons why items cannot be selected, but the main reasons are as follows:

- There is no signal.
- The function is not compatible with the current input signal.

### Menu screen duration

- The menu screen will revert to the normal screen if there is no operation for about 15 seconds while the menu screen is displayed.



- The menu item illustrations in this operation manual are for explanation purposes only and may vary slightly from what is actually displayed.

# Initialization (Reset)/Functional Restriction Setting

In the FUNCTION 1 screen, you can return contrast, image quality, and other settings to their factory-preset values, specify whether LEDs lights, and enable control via RS-232C (see page 38) among other functions.

**1. After pressing  for about 5 seconds, press , , , and  in that order.**

The FUNCTION 1 screen will appear.



**2. Select and set the items you want.**

<b>[ALL RESET]</b>	
Function	Returns all settings to their factory preset values. After initialization (reset), turn the main power switch off and then back on.
<b>[ADJUSTMENT LOCK]</b>	
Function	Specifies whether to lock settings such as ADJUSTMENT and WHITE BALANCE. While locked, the remote control unit cannot perform operations other than turning power on/off (POWER button) and displaying the FUNCTION 1 screen.
Default	UNLOCKED
LOCKED	Locks the setting.
UNLOCKED	Unlocks the setting.
<b>[OSD DISPLAY]</b>	
Function	Hides/shows menus. The FUNCTION 1 screen cannot be hidden.
Default	ON
ON	Displays the menus.
OFF	Hides the menus.
<b>[LED]</b>	
Function	Specifies whether to light LEDs.
Default	ON
ON	Lights LEDs.
OFF	Does not light LEDs.
<b>[RS-232C]</b>	
Function	Specifies whether to allow control (see page 38) via RS-232C.
Default	UNLOCKED
LOCKED	Disables control via RS232C.
UNLOCKED	Enables control via RS-232C.

**3. Press  to return to the normal screen.**

# Settings and Adjustments

## ■ ADJUSTMENT (INPUT2)

### [MANUAL / AUTO]

Function	Adjusts CLOCK, PHASE, H-POS (horizontal positioning), and V-POS (vertical positioning) are adjusted.
Adjustable range	MANUAL/AUTO
MANUAL	The CLOCK, PHASE, H-POS, and V-POS are manually adjusted. You can use the adjustment pattern on the supplied CD-ROM to adjust each parameter. See page 41 for more information on the screen display for making adjustments.
AUTO	The CLOCK, PHASE, H-POS, and V-POS are automatically adjusted.

### [MANUAL (CLOCK)]

Function	Adjusts frequency for sampling clock for applicable video. Adjust when there is flickering in the form of vertical stripes. When using the adjustment pattern (see page 36), make adjustments so that no vertical stripe noise appears in it.
Adjustable range	0 - 255
Default	127
+ direction	Clock frequency increases.
- direction	Clock frequency decreases.

### [MANUAL (PHASE)]

Function	Adjusts sampling clock phase for applicable video. Useful when small characters appear with low contrast and/or there are flickers at corners. When using the adjustment pattern (see page 36), make adjustments so that no horizontal stripe noise appears in it.
Adjustable range	0 - 255
Default	127
+ direction	Advances clock phase.
- direction	Delays clock phase.

### [MANUAL (H-POS)]

Adjustable range	0 - 255
Default	127
+ direction	Image shifts right.
- direction	Image shifts left.

### [MANUAL (V-POS)]

Adjustable range	0 - 255
Default	127
+ direction	Image shifts up.
- direction	Image shifts down.

## ■ GAIN CONTROL (INPUT2)

<b>[MANUAL / AUTO]</b>	
Function	Adjusts BLACK LEVEL and CONTRAST.
Adjustable range	MANUAL / AUTO
MANUAL	The BLACK LEVEL and CONTRAST are manually adjusted.
AUTO	The BLACK LEVEL and CONTRAST are automatically adjusted.
<b>[MANUAL (BLACK LEVEL)]</b>	
Adjustable range	0 - 31
Default	15
+ direction	Brightens entire video signal.
- direction	Darkens entire video signal.
<b>[MANUAL (CONTRAST)]</b>	
Adjustable range	0 - 31
Default	15
+ direction	For more contrast
- direction	For less contrast

## ■ WHITE BALANCE

<b>[THRU / COOL / • / STD / • / WARM / USER] (INPUT1 / INPUT2)</b>	
Adjustable range	THRU / COOL / • / STD / • / WARM / USER
Default	STD
THRU	Displays the input signal level as it is. This item is only selectable for INPUT1.
COOL	Color tone bluer than standard
•	Color tone slightly bluer than standard
STD	Color tone standard setting
•	Color tone slightly redder than standard
WARM	Color tone redder than standard
USER	Allows you to individually adjust R-CONTRAST, G-CONTRAST, and B-CONTRAST.
<b>[COPY to USER] (INPUT1 / INPUT2)</b>	
Adjustable range	OFF / SET
SET	Copies the values set for COOL / • / STD / • / WARM to USER settings.
<b>[USER (R-CONTRAST)] (INPUT1 / INPUT2)</b>	
Adjustable range	0 - 255
+ direction	Brightens red component.
- direction	Darkens red component.
<b>[USER (G-CONTRAST)] (INPUT1 / INPUT2)</b>	
Adjustable range	0 - 255
+ direction	Brightens green component.
- direction	Darkens green component.
<b>[USER (B-CONTRAST)] (INPUT1 / INPUT2)</b>	
Adjustable range	0 - 255
+ direction	Brightens blue component.
- direction	Darkens blue component.

# Settings and Adjustments (Continued)

<b>[CONTRAST] (INPUT3 / INPUT4)</b>	
Adjustable range	0 - 31
Default	15
+ direction	For more contrast
- direction	For less contrast
<b>[BLACK LEVEL] (INPUT3 / INPUT4)</b>	
Adjustable range	0 - 31
Default	15
+ direction	Brightens entire video signal.
- direction	Darkens entire video signal.
<b>[TINT] (INPUT3 / INPUT4)</b>	
Adjustable range	0 - 31
Default	15
+ direction	Changes skin tone closer to magenta.
- direction	Changes skin tone closer to green.
<b>[COLORS] (INPUT3 / INPUT4)</b>	
Adjustable range	0 - 31
Default	15
+ direction	For more color intensity
- direction	For less color intensity (Monochrome at "0")
<b>[SHARPNESS] (INPUT3 / INPUT4)</b>	
Adjustable range	0 - 31
Default	15
+ direction	For more sharpness
- direction	For less sharpness
<b>[WHITE BALANCE] (INPUT3 / INPUT4)</b>	
Adjustable range	COOL / • / STD / • / WARM
Default	STD
COOL	Color tone bluer than standard
•	Color tone slightly bluer than standard
STD	Color tone standard setting
•	Color tone slightly redder than standard
WARM	Color tone redder than standard



## ■ MODE SELECT 1

### [480 LINES] (INPUT2)

Function	Manually selects input resolution.
Adjustable range	852 / 848 / 640
Default	640

### [768 LINES] (INPUT2)

Function	Manually selects input resolution.
Adjustable range	1366 / 1360 / 1280 / 1024
Default	1024

### [ENLARGE] (INPUT1/INPUT2)

Function	Sets the image enlargement ratio to be enlarged.
Adjustable range	OFF / 2 x 2 / 3 x 3
Default	OFF

### [ENLARGE POS] (INPUT1 / INPUT2)

Function	Sets the part of the original image to be enlarged.
Adjustable range (2 x 2)	0 - 3
Adjustable range (3 x 3)	0 - 8
Default	0

### [MULTI ZOOM] (INPUT1 / INPUT2)

Function	Adjusts the enlarged screen.
IMAGE ZOOM	Adjusts the scale of enlargement.
H-POS	Adjusts the horizontal position.
V-POS	Adjusts the vertical position.

## ■ Enlarge

You can set up 4 or 9 monitors and integrate them into a single screen to display video. Each monitor displays an enlargement of 1/4 or 1/9 of the original image.

### How to use the "Enlarge" feature

- 4 screen monitor set-up

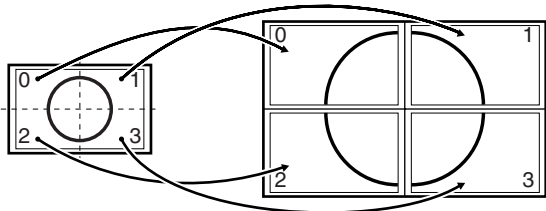



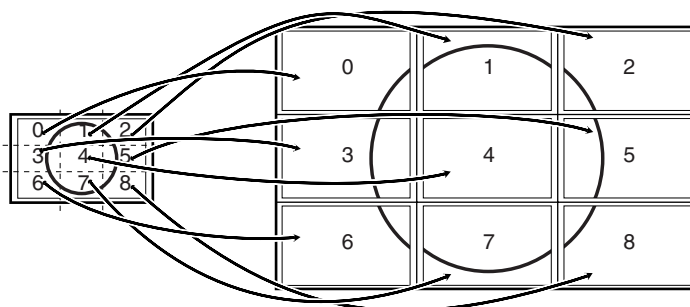



- 9 screen monitor set-up



# Settings and Adjustments (Continued)

## ■ MODE SELECT 2

<b>[OFF TIMER]</b>	
Function	Specifies the remaining time before turning off the power.
Adjustable range	0 - 23
Default	0
<b>[OSD H-POSITION]</b>	
Function	Adjusts the horizontal display position of menu screen.
How to adjust	Use  /  to move menu screen.
Default	Center
<b>[OSD V-POSITION]</b>	
Function	Adjusts the vertical display position of menu screen.
How to adjust	Use  /  to move menu screen.
Default	Center
<b>[LANGUAGE]</b>	
Function	Switches the OSD language.
Available languages	ENGLISH / DEUTSCH / FRANÇAIS / ITALIANO / ESPAÑOL
Default	ENGLISH
<b>[ID NO SET]</b>	
Function	Assigns ID numbers to monitors connected in a daisy chain (see page 39), using RS-232C cables.
Adjustable range	0 - 255
Default	0
Note	The numbers 1 to 255 are available for ID numbers. (If "0" is set, the system regards this as the state where no ID number is set.) Although numbers up to 255 can be used for monitor IDs, the number of connectable monitors varies depending on the length of RS-232C cables and the installation environment. Use  /  to increase or decrease values.

■ Switching the screen size (INPUT1 / INPUT2)

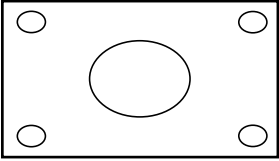
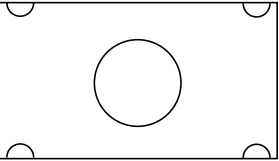
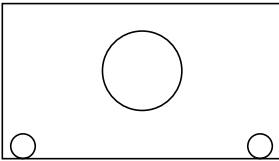
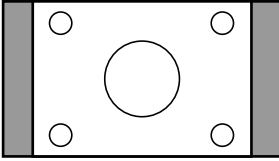
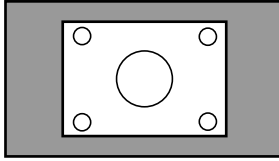
WIDE	ZOOM 1	ZOOM 2
 <p data-bbox="233 517 561 577">Displays image so it fills the entire screen.</p>	 <p data-bbox="600 517 928 607">Displays edge portion of the image which is normally cut off.</p>	 <p data-bbox="967 517 1248 577">Use this size if ZOOM1 cuts off the subtitles.</p>
NORMAL	Dot by Dot	
 <p data-bbox="233 907 561 1025">Displays image so it fills the screen vertically, while maintaining the original aspect ratio.</p>	 <p data-bbox="600 907 928 1064">Detects the resolution of the signal and displays an image with the same number of pixels on the screen. (See page 56.)</p>	

■ Switching the screen size (INPUT3 / INPUT4)

The desired screen size can be selected to suit the input signal.

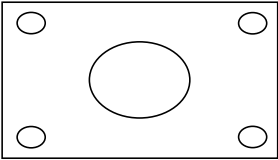
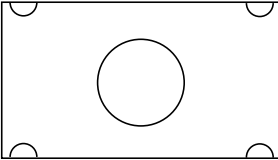
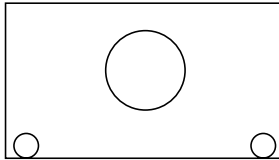
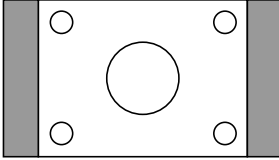
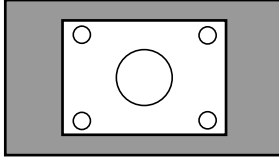
WIDE	ZOOM 1	ZOOM 2
 <p data-bbox="236 1496 549 1615">In this mode the image is progressively stretched toward each side of the screen.</p>	 <p data-bbox="603 1496 932 1585">Displays edge portion of the image which is normally cut off.</p>	 <p data-bbox="970 1496 1251 1556">Use this size if ZOOM1 cuts off the subtitles.</p>
NORMAL	Dot by Dot	
 <p data-bbox="236 1886 564 1975">For 4:3 "Standard" pictures. A side bar appears on each side.</p>	 <p data-bbox="603 1886 932 2042">Detects the resolution of the signal and displays an image with the same number of pixels on the screen.</p>	

# Settings and Adjustments (Continued)



- Using this monitor's screen size switching function to compress or expand the screen for commercial or public viewing in establishments like cafes or hotels may infringe on the rights of the creators, as protected by Copyright Law, so please be careful.
- When set to "Enlarge" (i.e. with a "2 x 2" or "3 x 3" setting), the screen size is fixed in "WIDE" mode.
- When using the screen size selection function of this monitor, the appearance of the original video may change if you select a screen size with a different aspect ratio than the original image (i.e. TV broadcast or video input from external equipment). Please consider this point when selecting the screen size.
- When an ordinary non-wide image (4:3) is viewed with the whole screen using the screen size switching function of this monitor, the edge of the image may be lost or appear distorted. If you wish to respect the creator's intentions, set the screen size to "NORMAL".
- When playing commercial software, parts of the image (like subtitles) may be cropped. In this case select the optimal screen size using "Wide Mode" and adjust the vertical position (see "Position" on page 30). With some software, there may be noise or distortion at the edges or top of the screen. This is due to the characteristics of the software, and is not a malfunction.
- Depending on the original image size (i.e. CinemaScope size), black bands may remain at the top and bottom of the screen.

## Screen display for adjustments (INPUT2)

Before making adjustments in the ADJUSTMENT menu (see page 30), display an image to brighten the entire screen.

If you are using a Windows PC, use the adjustment pattern on the supplied CD-ROM.

### Retrieving the adjustment pattern

This explanation assumes you are using Windows 2000/XP and your CD-ROM drive is the "D" drive.

1. Connect the monitor and computer.
2. Load the supplied CD-ROM into the computer's CD-ROM drive.
3. Open the CD-ROM in [My Computer].
4. Double-click [Adj\_uty.exe] to start the adjustment program.  
The adjustment pattern will appear.

<Adjustment pattern>

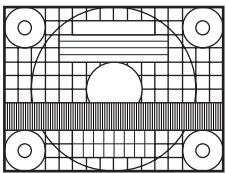

5. When adjustment is finished, press the [ESC] on the computer's keyboard to quit the adjustment program.



- If the display mode on the computer you are using is 65,000 colors, the color levels in the color pattern may appear differently or grayscale may appear to be colored. (This is due to the specifications of the input signal and is not a malfunction.)

## Set-up information (INPUT1 / INPUT2)

Depending on the type of computer or OS, you may need to install monitor set-up information on your system. If so, follow the steps below to install monitor set-up information. (Depending on the type of computer or OS, command names and methods may differ. Please follow the computer's own operation manual while reading this.)

### Installing set-up information

#### For Windows 2000

This explanation is for installing and setting monitor set-up information on a Windows 2000 computer, and it assumes your CD-ROM drive is the "D" drive.

1. Connect the monitor and computer.
2. Load the supplied CD-ROM into the computer's CD-ROM drive.
3. Click the [Start] button. From [Settings], choose [Control Panel].
4. Double-click [Display].
5. Click [Settings], [Advanced], and [Monitor].
6. Click [Properties], [Driver], and [Update Driver].
7. When the [Upgrade Device Driver Wizard] appears, click [Next].
8. Select [Display a list of the known drivers for this device so that I can choose a specific driver] and click [Next].
9. When [Models] is displayed, click [Have disk], confirm that [Copy manufacturer's files from:] is [D:], and click [OK].
10. Select the monitor from the list displayed and click [Next].
11. Click [Next], confirm that the monitor's name appears on the screen, and click [Finish]. If [The Digital Signature Not Found] appears, click [Yes].
12. Click [Close] to close [Display Properties].
13. Click [OK] to close the window.
14. Eject the CD-ROM from the CD-ROM drive.

#### For Windows XP

This explanation is for installing and setting monitor set-up information on a Windows XP computer, and it assumes your CD-ROM drive is the "D" drive.

1. Connect the monitor and computer.
2. Load the supplied CD-ROM into the computer's CD-ROM drive.
3. Click the [Start] button. Choose [Control Panel].
4. Click [Appearance and Themes] and [Display].  
When using Classic View, double-click [Display].
5. Click [Settings], [Advanced], and [Monitor].
6. Click [Properties], [Driver], and [Update Driver].  
The [Hardware Update Wizard] appears.  
When you are asked whether to search Windows Update for the device driver, select [No, not this time] and click [Next].
7. Select [Install from a list or specific location] and click [Next].
8. Select [Don't search. I will choose the driver to install.] and click [Next].
9. Click [Have Disk], confirm that [Copy manufacturer's files from:] is [D:], and click [OK].
10. Select the monitor from the list displayed and click [Next].  
If [has not passed Windows Logo testing...] appears, click [Continue Anyway].
11. Confirm that the monitor's name appears on the screen and click [Finish].
12. Click [Close] to close [Screen Properties].
13. Click [OK] to close the window.
14. Eject the CD-ROM from the CD-ROM drive.

# PC Operation

## PC connection

### 1. One-to-one connection with a PC..... Basic operation

Connect with RS-232C straight cable between the PC COM port (RS-232C connector) and the RS-232C input terminal on the back of monitor.

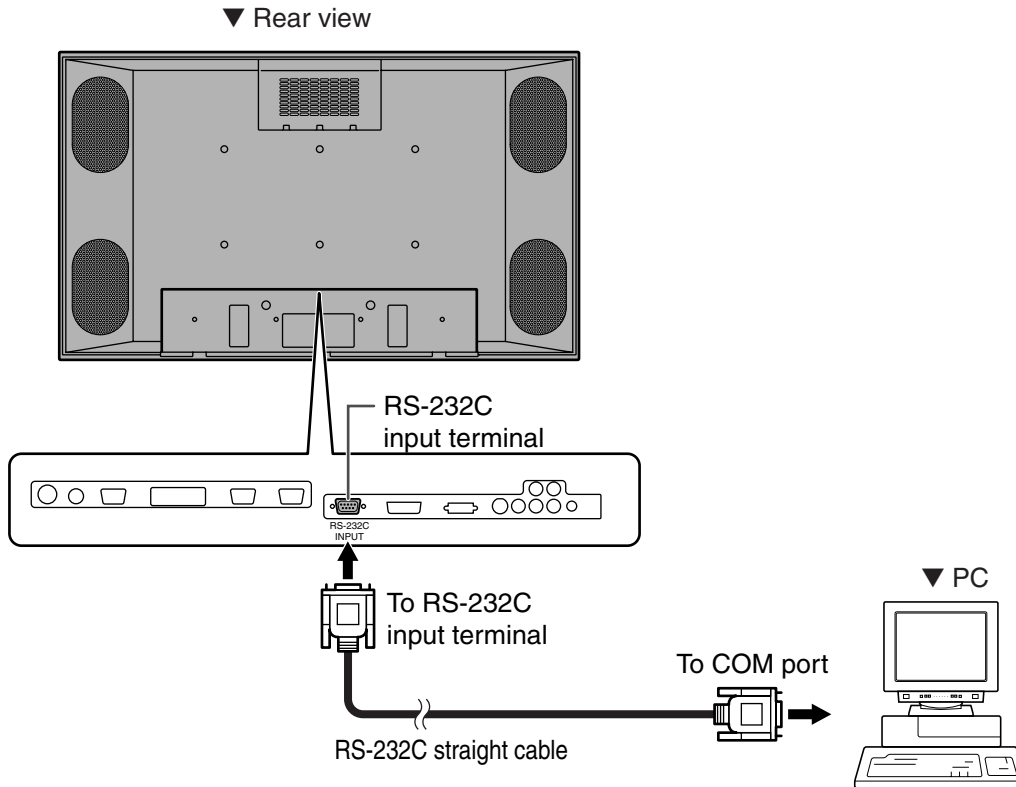

## 2. Daisy chain connection from a single PC..... **Advanced operation**

Connect with RS-232C straight cable between the PC COM port (RS-232C connector) and the RS-232C input terminal on the back of monitor.

Next, connect RS-232C straight cable to the first monitor's RS-232C output terminal and to the second monitor's RS-232C input terminal. Connect in the same way to the third and subsequent monitors. The number of connectable monitors varies depending on the length of the cable used and the surrounding environment.

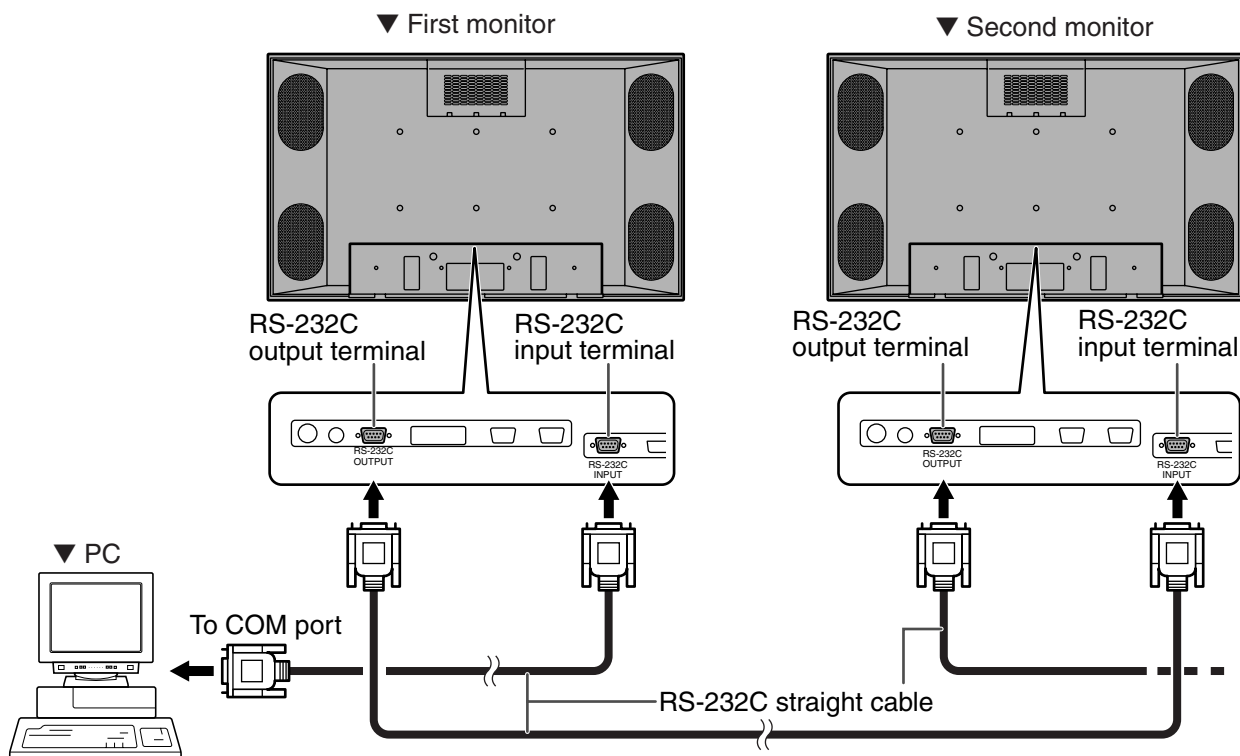

### Communication conditions

Set the RS-232C communication settings on the PC to match the monitor's communication settings.

Baud rate	9,600 bps
Data length	8 bits
Parity bit	None

Stop bit	1 bit
Flow control	None

# PC Operation (Continued)

## Communication procedure

### Basic operation

#### <Command format>

When a command is sent from the PC to the monitor, the monitor operates according to the received command, and sends a response message to the PC.

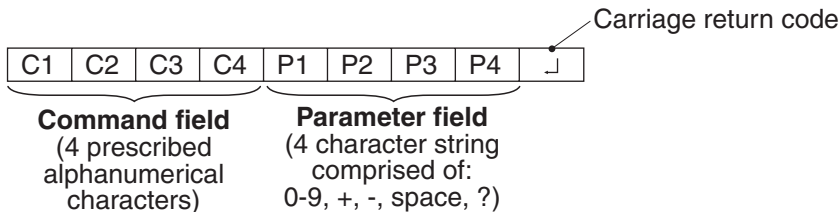

Example: VOLM0030

POWR␣␣␣␣1 (“␣” indicates a space.)

\* Be sure to input 4 characters for the parameter. Pad with spaces if necessary.

× VOLM30␣␣

○ VOLM␣␣␣30␣␣ (“␣” indicates a space. “␣␣” is the carriage return code (0DH, 0AH or 0DH).)

If a command has “R” listed for “DIRECTION” in the “RS-232C Command table” on page 52, the current value can be returned by using “?” as the parameter.

Example: 1. If an ID number has not been set:

VOLM???? ← From PC to monitor (Current volume setting: ?)

30 ← From monitor to PC (Current volume setting: 30)

2. If an ID number has been assigned (For example, ID number = 001)

VOLM␣␣␣? ← From PC to monitor (“␣” indicates a space.)

30␣001 ← From monitor to PC (“␣” indicates a space.)

#### <Response code format>

##### ■ When a command has been executed correctly

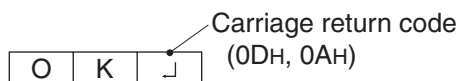

This is returned when execution of the command is finished.

##### ■ When a command has not been executed correctly\*

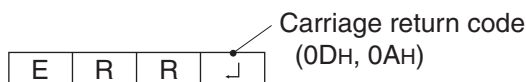

\* This is returned when there is no such command, or when the command cannot be used in the current state of the monitor (i.e. video auto-adjustment with video display).

\* If there is a bad connection between the PC and monitor, or if communication has not been established, nothing is returned (not even ERR).

##### ■ If execution of the command is taking some time



If a command takes some time to execute, WAIT may be returned as the return value. Wait for a moment, and OK or ERR will be returned. New commands cannot be received during this time, even if they are sent.

##### ■ If RS-232C is locked

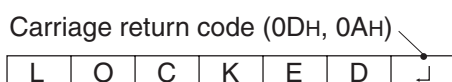

If RS-232C control has been locked with the operation lock (see page 29), LOCKED is returned as the returned value.



## Advanced operation

This section explains commands for daisy chain connection. The basic communication procedure is the same as in the “Basic operation” section.

### <ID numbers>

You can assign a unique ID number to each monitor (see page 34). This allows you to control a particular monitor in a daisy chain of monitors.

Up to about 20 monitors can be connected, depending on the length of RS-232C cables and installation environment.

You can assign ID numbers either from the menu screen (via remote control or the control buttons on the monitor) or from the PC using RS-232C cable.

#### [Example]

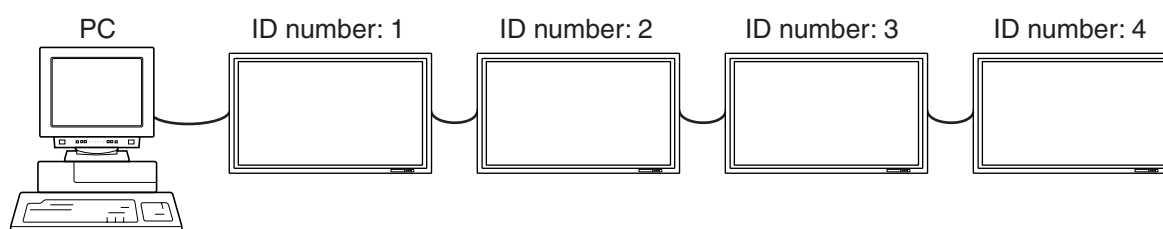

If monitors are connected as shown above, you can execute commands like “Set the volume of the monitor with ID 4 to 20”.

When controlling monitors linked in a daisy chain by designating ID numbers, you should basically avoid any duplication of ID numbers.

If the same ID number is assigned to multiple monitors, only the monitor closest to the PC can be controlled with that ID number.

If monitors are connected as shown below, only the monitor (1) can be accessed with ID number 2. Monitor (2) cannot be controlled using that ID number.

#### [Example]

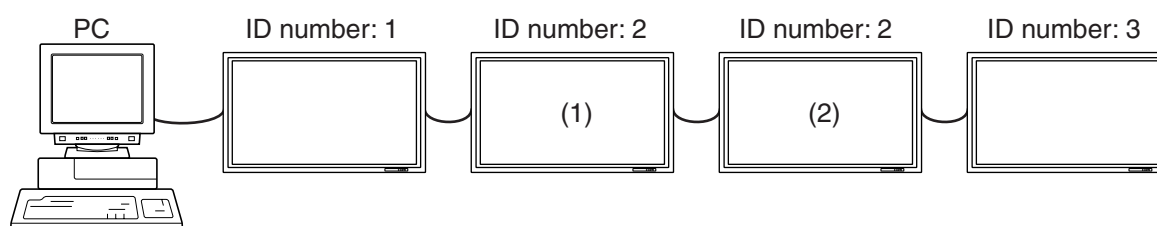

ID numbers do not have to be assigned in ascending order starting from the PC. They can also be connected as shown below.

#### [Example]

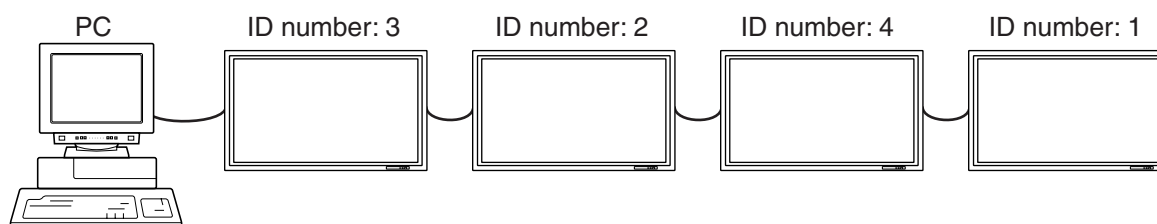

# PC Operation (Continued)

## <Commands for ID control>

The command examples shown on this page assume the following connection and ID number set up.

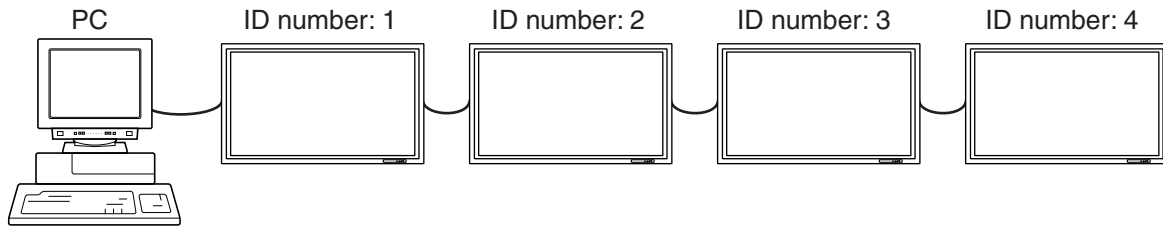

IDST.....A monitor receiving this command sets its own ID number in the parameter field.

Example: IDST001

OK\_001 ← The ID number of this monitor is set to 1.

## Note

After linking monitors, you can automatically assign ID numbers by using the IDST command with the Repeater control (see “Repeater control” on page 49).

### [Example]

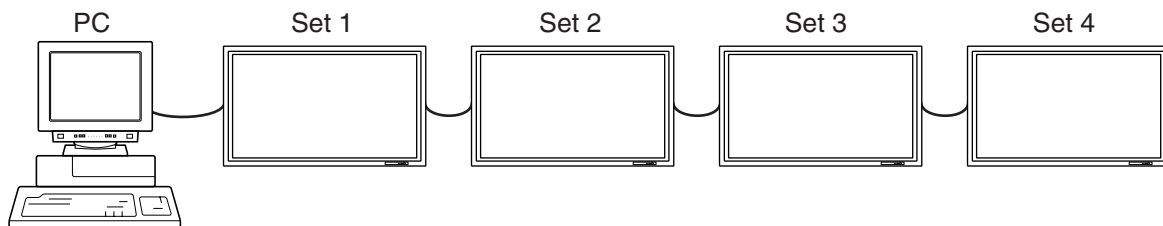

If you connect monitors as shown above, and use the command “IDST001+”, ID numbers will be set automatically, as shown below.

### [Example]

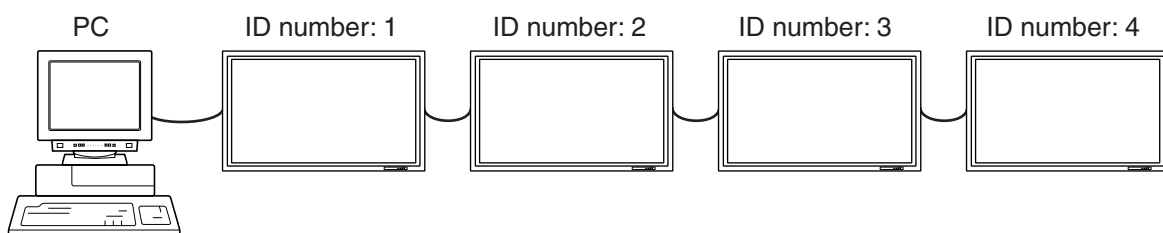

IDST001+ ← ID setting command with repeater control

WAIT

OK 001 ← ID = “OK” response from ID number=1

OK 002 ← ID = “OK” response from ID number=2

OK 003 ← ID = “OK” response from ID number=3

OK 004 ← ID = “OK” response from ID number=4 (End)

IDSL ..... The parameter of this command sets the ID number indicating the monitor subject to the next command.

**Example:**

IDSL0002	← The next command is for the monitor with ID number=2.	
WAIT	← Searching for monitor with ID number=2	
OK_002	← Found monitor with ID number=2	
VOLM0030	← Sets volume of monitor with ID number=2 to 30.	
WAIT	← Processing	
OK_002	← OK response from monitor with ID number=2	
VOLM0020	← Sets volume to 20.	} The IDSL command is effective only once, for the immediately succeeding command.
OK_001	← The volume of the monitor with ID number=1 (the one directly connected to the PC) is set to 20.	

IDLK ..... The parameter of this command sets the ID number indicating the monitor subject to all subsequent commands.

**Example:**

IDLK0002	← Following commands are for the monitor whose ID number is "2".	
WAIT	← Searching for monitor with ID number=2	
OK_002	← Found monitor with ID number=2	
VOLM0030	← Sets volume of monitor with ID number=2 to 30.	} The IDLK command remains effective until it is canceled, or power is shut off.
WAIT	← Processing	
OK_002		
VOLM0020	← Sets volume of monitor with ID number=2 to 20.	
WAIT		
OK_002		
IDLK0000	← Canceling ID number setting	
WAIT	← Canceling IDLK	
OK_002	← Cancelation complete	
VOLM0010		
OK_001	← The volume of the monitor with ID number=1 (the one directly connected to the PC) is set to 10.	

IDCK ..... Provides screen display of the ID number currently assigned to a monitor, and the ID number currently set for IDLK (if any).

**Example:**

(After executing IDLK0002)

IDCK0000	← (Parameter has no meaning.)
ID:001 IDLK:002	← Returned response. The ID number is also displayed on the monitor screen.
IDCK000+	← Repeater control (If a command is used with repeater control, ID designation using IDSL or IDLK is canceled.)
WAIT	
ID:001 IDLK:002	
ID:002 IDLK:002	
ID:003 IDLK:002	
ID:004 IDLK:002	

# PC Operation (Continued)

## <Repeater control>

This system has a function to allow setting of multiple monitors connected in a daisy chain using a single command. This function is called repeater control.

The number of connectable monitors varies depending on the length of the cable used and the surrounding environment.

You can use Repeater control function without assigning ID numbers.

### [Example]

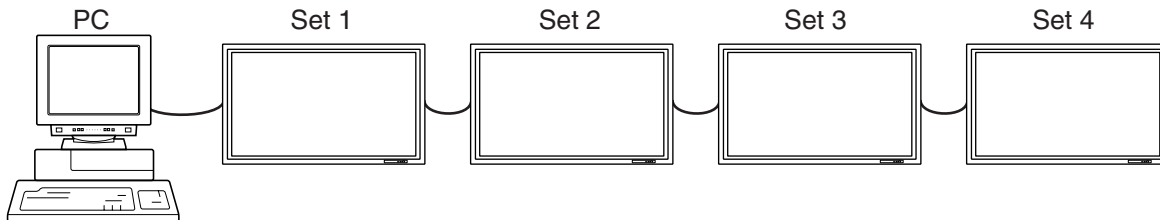

If monitors are connected as shown above, you can execute a command like “Set all monitors’ input settings to INPUT1”.

## <Repeater control command>

Repeater control is achieved by setting the FOURTH CHARACTER of the parameter to “+”.

### Example:

VOLM030+ ← Sets volume of all monitors to 30.

In repeater control, responses are returned by all the connected monitors.\*

If you want to determine that a value has been returned by a specific set, assign ID numbers to each monitor in advance.

If no response is returned, this may be because the monitor has not received (or is still processing) the command, so it is possible that new commands may not be executed even if they are sent.

\* If power is turned “OFF” using Repeater control, only the monitor closest to the PC returns a response.

### Example:

(When 4 monitors are connected, and assigned ID numbers 1 through 4)

VOLM030+

WAIT

OK\_001

OK\_002

OK\_003

OK\_004

← If 4 monitors are connected in a chain, reliable operation can be ensured by sending a new command only after a reply has been returned by 4th (last) monitor.

Repeater control can also be used for reading settings.

### Example:

VOLM???+

WAIT

10 001

20 002

30 003

40 004

} Volume settings for all monitors are returned.



- If repeater control is used during ID designation (IDSL, IDLK), the ID designation is canceled.

## <Response format in **Advanced operation**>

### ■ Normal response

- Response when no ID number has been set

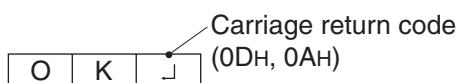

A response is returned when execution of the pertinent command is finished.

- Response when an ID number has been set

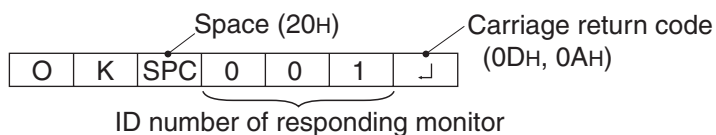

### ■ When a command has not been executed correctly\*

- Response when no ID number has been set

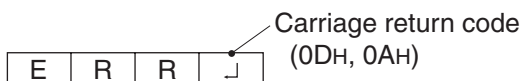

- Response when an ID number has been set

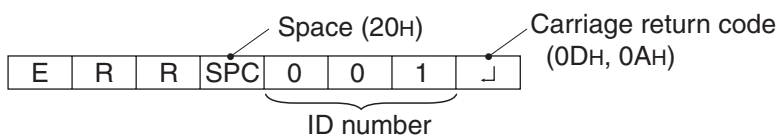

\* This is returned when there is no such command, or when the command cannot be used in the current state of the monitor (i.e. video auto-adjustment with video display).

\* If communication has not been established for reasons like a bad connection with the monitor, nothing is returned (not even ERR).

\* If no monitor has been assigned the designated ID number (e.g. if the command IDSL0002  is used, but no monitor with ID=002 is found), no response is returned.

# PC Operation (Continued)

## ■ If execution of the command is taking some time

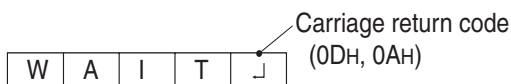

If execution of a command takes some time, WAIT may be returned as the returned value. In this case, a value will be returned if you wait a while. During this time, new commands will not be received, even if they are sent.

No ID number is attached to WAIT response.

- Cases where WAIT is returned
  - When repeater control is used
  - When an IDSL or IDLK command is used
  - When one of the following commands is used: RSET, INPS, ASNC, WIDE, EMAG, EPOS, PXSL, POWR

## ■ When control via RS-232C is locked (to prevent use) using the operation lock function (see page 34)



## ■ If a timeout occurs while waiting for a command



## ■ If a timeout occurs while waiting for a command (when the monitor waiting for the command is assigned an ID number = 001 in the following example)

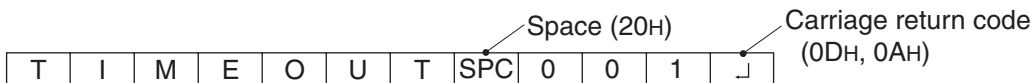

## ■ If the current parameter is read out using “?” for the parameter (for numerical values etc.)

- Response when no ID number has been set

**Example:**

VOLM????

10

- Response when an ID number has been set (In the example below: ID=001)

**Example:**

VOLM????

10\_001

## <Communication interval>

- If the next command is sent in the interval before OK or ERR is returned, it will basically be ignored. (Exception: Forced end using ASNC command)
- Leave an interval of 100 ms between command response and transmission of the next command.

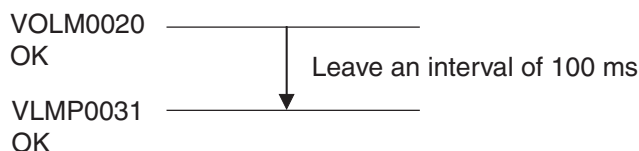

## RS-232C command table

### <How to read the command table>

- Command: Command field (See page 40.)
- Direction: W When the "Parameter" is set in the parameter field (see page 40), the command functions as described under "Control/Response Contents".
- R The returned value indicated under "Reply" can be obtained by setting "????", "\_\_\_?" or "???" (repeater control) in the parameter field (see page 40).
- Parameter: Parameter field (See page 40.)
- Reply: Response (Returned value)
- \* A circle indicates commands which can be used in power standby mode.

### Power control/Input selection, etc.

\*can be used in standby mode

Control item	Command	Direction	Parameter	Reply	Control/Response contents	*
Power Setting	POWR	W	0		Switches to standby.	Yes
			1		Returns from standby.	
		R		0	Standby mode	
				1	Normal mode	
				2	Waiting mode	
Input Selection	INPS	W	0		Toggle change	Yes
			1		INPUT1 : DVI	
			2		INPUT2 : RGB	
			3		INPUT3 : Component	
			4		INPUT4 : S-Video/Video	
		R		1	INPUT1 : DVI	
				2	INPUT2 : RGB	
				3	INPUT3 : Component	
				4	INPUT4 : S-Video/Video	

# PC Operation (Continued)

## Picture Adjustment (INPUT1)

\*can be used in standby mode

Control item		Command	Direction	Parameter	Reply	Control/Response contents	*
WHITE BALANCE	THRU	CTMP	WR	0	0		Yes
	COOL		WR	1	1		
	•		WR	2	2		
	STD		WR	3	3		
	•		WR	4	4		
	WARM		WR	5	5		
	USER		WR	6	6		
	R-CONTRAST	CRTR	WR	0-max value	0-max value		
	G-CONTRAST	CRTG	WR	0-max value	0-max value		
	B-CONTRAST	CRTB	WR	0-max value	0-max value		
RESOLUTION CHECK		PXCK	R		—	Returns current resolution in the form of xxx, xxx.	No
ENLARGE	ENLARGE SETTING	EMAG	WR	0	0	ENLARGE OFF	No
				1	1	2 x 2	
				2	2	3 x 3	
	IMAGE POSITION (2 x 2)	EPOS	WR	0	0	SETTING: 2 x 2) UPPER LEFT	
				1	1	SETTING: 2 x 2) UPPER RIGHT	
				2	2	SETTING: 2 x 2) LOWER LEFT	
				3	3	SETTING: 2 x 2) LOWER RIGHT	
	IMAGE POSITION (3 x 3)	EPOS	WR	0	0	SETTING: 3 x 3) UPPER LEFT	
				1	1	SETTING: 3 x 3) UPPER MIDDLE	
				2	2	SETTING: 3 x 3) UPPER RIGHT	
				3	3	SETTING: 3 x 3) MIDDLE LEFT	
				4	4	SETTING: 3 x 3) CENTER	
				5	5	SETTING: 3 x 3) UPPER RIGHT	
				6	6	SETTING: 3 x 3) LOWER LEFT	
				7	7	SETTING: 3 x 3) UPPER MIDDLE	
8	8	SETTING: 3 x 3) LOWER RIGHT					
WIDE MODE	WIDE	WR	1	1	WIDE	Yes	
			2	2	NORMAL		
			3	3	Dot by Dot		
			4	4	ZOOM1		
			5	5	ZOOM2		



# Picture Adjustment (INPUT2)

\*can be used in standby mode

Control item		Command	Direction	Parameter	Reply	Control/Response contents	*
Auto Sync.	AUTO ADJUSTMENT	ASNC	W	1			No
Sync. Adjustment	Clock	CLCK	WR	0-max value	0-max value	Returns Error in case of DVI or Video input mode.	No
	Phase	PHSE	WR	0-max value	0-max value		
	H-Position	HPOS	WR	0-max value	0-max value		
	V-Position	VPOS	WR	0-max value	0-max value		
Auto Gain	AUTO ADJUSTMENT	AGIN	W	1			No
Picture adjustment	Black level	BLVL	WR	0-max value	0-max value	Returns Error in case of DVI or Video input mode.	Yes
	Contrast	CONT	WR	0-max value	0-max value		
WHITE BALANCE	COOL	CTMP	WR	1	1		Yes
	•		WR	2	2		
	STD		WR	3	3		
	•		WR	4	4		
	WARM		WR	5	5		
	USER		WR	6	6		
	R-CONTRAST	CRTR	WR	0-max value	0-max value		
	G-CONTRAST	CRTG	WR	0-max value	0-max value		
B-CONTRAST	CRTB	WR	0-max value	0-max value			
RESOLUTION CHECK		PXCK	R		—	Returns current resolution in the form of xxx, xxx.	
768 LINES	DOTS SETTING	PXSL	WR	0	0	V=768 / 1366 x 768	No
				1	1	V=768 / 1360 x 768	
				2	2	V=768 / 1280 x 768	
				3	3	V=768 / 1024 x 768	
480 LINES	DOTS SETTING	PXSL	WR	4	4	V=480 / 852 x 480	
				5	5	V=480 / 848 x 480	
				6	6	V=480 / 640 x 480	
ENLARGE	ENLARGE SETTING	EMAG	WR	0	0	ENLARGE OFF	
				1	1	2 x 2	
				2	2	3 x 3	
	IMAGE POSITION (2 x 2)	EPOS	WR	0	0	SETTING: 2 x 2) UPPER LEFT	
				1	1	SETTING: 2 x 2) UPPER RIGHT	
				2	2	SETTING: 2 x 2) LOWER LEFT	
				3	3	SETTING: 2 x 2) LOWER RIGHT	
	IMAGE POSITION (3 x 3)	EPOS	WR	0	0	SETTING: 3 x 3) UPPER LEFT	
				1	1	SETTING: 3 x 3) UPPER MIDDLE	
				2	2	SETTING: 3 x 3) UPPER RIGHT	
				3	3	SETTING: 3 x 3) MIDDLE LEFT	
				4	4	SETTING: 3 x 3) CENTER	
				5	5	SETTING: 3 x 3) UPPER RIGHT	
				6	6	SETTING: 3 x 3) LOWER LEFT	
7	7	SETTING: 3 x 3) UPPER MIDDLE					
8	8	SETTING: 3 x 3) LOWER RIGHT					
WIDE MODE	WIDE	WR	1	1	WIDE	Yes	
			2	2	NORMAL		
			3	3	Dot by Dot		
			4	4	ZOOM1		
			5	5	ZOOM2		

# PC Operation (Continued)

## Picture Adjustment (INPUT3/INPUT4)

\*can be used in standby mode

Control item		Command	Direction	Parameter	Reply	Control/Response contents	*
WHITE BALANCE	CONTRAST	CONT	WR	0-max value	0-max value		Yes
	BLACK LEVEL	BLVL	WR	0-max value	0-max value		
	COLOR	COLR	WR	0-max value	0-max value		
	TINT	TINT	WR	0-max value	0-max value		
	SHARPNESS	SHRP	WR	0-max value	0-max value		
	COOL	CTMP	WR	1	1		
	•		WR	2	2		
	STD		WR	3	3		
	•		WR	4	4		
WARM	WR		5	5			
WIDE MODE		WIDE	WR	1	1	WIDE	Yes
				2	2	ZOOM1	
				3	3	ZOOM2	
				4	4	NORMAL	
				5	5	Dot by Dot	





## Special Control

\*can be used in standby mode

Control item		Command	Direction	Parameter	Reply	Control/Response contents	*	
OFF TIMER		OFTM	W	0		TIMER OFF	No	
				1-23		OFF TIMER		
			R		0			TIMER OFF
					1-23			Remaining time
ID NUMBER	ID NO. SETTING	IDST	W	0-255		Sets the monitor's ID number.	Yes	
			R		0-255	Returns the monitor's ID number.		
	ID NO. SETTING (ONCE)	IDSL	W	1-255		Sets a monitor ID number. This ID number is only effective for the command immediately after this command.	Yes	
				0		Clears the ID number if one has been designated.		
	ID NO. SETTING (SUBSEQUENT)	IDLK	W	1-255		Sets a monitor ID number. This ID number is effective for the next and all subsequent commands after this command.	Yes	
				0		Clears the ID number if one has been designated.		
	ID CHECK	IDCK	W	0		Displays selected ID number and the monitor's own ID number on the screen.	Yes	
	Information	MODEL	INF1	R		Value		Yes
SERIAL NO.		SRNO	R		Value			
Display mode		BMOD	WR	0	0	STANDARD	Yes	
				1	1	OFFICE MODE		
				2	2	VIVID MODE		
Brightness		VLMP	WR	0-max value	0-max value	BRIGHTNESS	Yes	
Volume		VOLM	WR	0-max value	0-max value		Yes	
Mute		MUTE	WR	0	0	OFF	No	
				1	1	ON		
ALL RESET		RSET	W	0		ALL RESET	No	
ADJUSTMENT		ALCK	WR	0	0	OSD DISPLAY ON	Yes	
				1	1	OSD DISPLAY OFF		
OSD DISPLAY		LOSD	WR	0	0	ADJUSTMENT UNLOCKED	Yes	
				1	1	ADJUSTMENT LOCKED		
LED OFF		OFLD	WR	0	0	LED ON	Yes	
				1	1	LED OFF		
CAUSE OF LAST STANBY		STCA	W	0		Initialization	Yes	
			R	0		No detectable error has occurred		
				1		Standby by remote control		
				2		Standby by power switch		
				3		Standby by RS-232C		
				4		Waiting by No Signal/Out of Timing (Incl: VESA DPMS/DMPM)		
				5		Standby by FAN error		
				6		Standby by abnormal temperature		
Status check	Temperature	ERRT	R		Value	Temperature	No	
	Fan	ERRF	R	0		No error		
1					FAN error			

# Troubleshooting

Before calling for repair services, make sure following checks for possible remedies to the encountered symptoms.

Problem	Check item	Page
 <p>There is no picture or sound.</p>	<ul style="list-style-type: none"> <li>• Is the AC cord disconnected?</li> <li>• Is the main power switch turned off or is the monitor in standby mode?</li> <li>• Make sure external equipment is connected properly.</li> <li>• Make sure correct INPUT is selected.</li> <li>• Make sure the connected external equipment is operating (playing back).</li> </ul>	<p>19 24 13 to 17 25 –</p>
 <p>There is no picture.</p>	<ul style="list-style-type: none"> <li>• The signal may be incompatible.</li> </ul>	–
Picture disappears.	<ul style="list-style-type: none"> <li>• Is the monitor in waiting mode?</li> </ul>	24
Remote control does not work.	<ul style="list-style-type: none"> <li>• Are the batteries inserted with polarity (⊕, ⊖) aligned?</li> <li>• Are the batteries worn out?</li> <li>• Point the remote control unit toward the monitor's remote control sensor.</li> <li>• Is the menu display locked?</li> </ul>	<p>12 29</p>
 <p>Sound from left and right speakers is reversed. Sound is heard from only one side.</p>	<ul style="list-style-type: none"> <li>• Are audio cables connected properly?</li> <li>• Make sure audio cables for external speakers are connected properly: left and right cables may be reversed or one of the two cables may not be connected.</li> </ul>	<p>13 to 17 18</p>
 <p>There is a picture but no sound.</p>	<ul style="list-style-type: none"> <li>• Make sure the volume is not set to minimum.</li> <li>• Video, S-video, component and RGB terminals are for video only. Make sure audio cables are also connected.</li> <li>• Is the audio corresponding to the selected image being input?</li> </ul>	<p>25 13 to 17 13 to 17</p>
 <p>Faint color or bad hue.</p>	<ul style="list-style-type: none"> <li>• Check "Color" and "Tint" adjustments.</li> <li>• Make sure the connection sequence is correct.</li> </ul>	<p>31 to 32 13 to 17</p>

### ■ Warning when temperature rises

Nature of warning:

- The power LED lights up red and the monitor enters standby mode.

Solution:

- If the monitor enters standby mode due to a rise in temperature, you can turn off the main power switch and turn it back on again. However the monitor will enter standby mode again if the cause of the temperature rise is not eliminated.
- Check whether the monitor is placed at a location where a quick rise in temperature is likely. Internal temperature rises quickly if the vents on the back are blocked.
- Internal temperature rises quickly if dust accumulates inside the monitor or around the vents. Remove dust if possible. Ask your dealer about removing internal dust.
- If the power LED blinks red, there might be a problem with the fan.

### Cracking sound

The monitor sometimes makes a cracking sound.

- You may hear cracking sound from the monitor. This happens when the cabinet slightly expands and contracts according to change in temperature. This does not affect the monitor's performance.

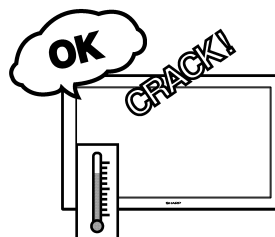

# Specifications

## ■ Product Specifications

Model	PN-455			
LCD element	45" wide (113.1 cm diagonal) ASV low-reflection black TFT LCD			
Max. resolution (pixels)	1920 x 1080			
Max. colors	16.77 M colors (8 bits/color)			
Viewing angle	170° right/left/up/down (contrast ratio ≥10)			
Screen active area inch (mm)	38-7/8 x 21-7/8 (985.9 X 554.6)			
Computer input signal	Digital DVI 1.0 standard-compliant, analog RGB (0.7Vp-p) [75Ω]			
Sync signal	Horizontal/vertical separate (TTL: positive/negative), Sync-on-green, Composite sync (TTL: positive/negative)			
Video signal system	NTSC (3.58MHz)			
Plug and play	VESA DDC2B			
Power management	VESA DPMS, DVI DMPM			
Input terminals	Computer signal	Digital	DVI-D 24 pin	
		Analog	Mini D-sub 15 pin, 3 rows	
	Computer audio	3.5 mm mini stereo jack		
	Serial	RS-232C		
	Composite video	BNC *1		
	S-video	1 line *1		
	Component	BNC (Y, Pb/Cb, Pr/Cr)		
Output terminals	Audio	RCA pin (L/R)		
	Computer signal	Analog *2	Mini D-sub 15 pin, 3 rows	
		Serial	RS-232C	
	Audio	RCA pin (L/R)		
	Speaker	10 W + 10 W [6Ω]		
	Power requirement	AC120 V, 60 Hz		
	Operating temperature	0°C to 40°C		
Operating humidity	20% to 80% (no condensation)			
Power consumption	312 W, 18 W in waiting mode, 2.9 W in standby mode			
Dimensions inch (mm)	Approx. 42-7/8 x 3-3/4 x 25-3/8 (1,089 x 96 x 645) (excluding protrusions)			
Weight lbs. (kg)	Approx. 59.5 (27)			

\*1 S-video input will have priority over composite video when connected.

\*2 Through output for the analog computer input signal. Does not support plug and play.



- As a part of our policy of continuous improvement, SHARP reserves the right to make design and specification changes for product improvement without prior notice. The performance specification figures indicates are normal values of production units: There may be some deviation from these values in individual units.

## ■ Power management

This monitor conforms to VESA DPMS and DVI DMPM. Both your video card and computer must support the same standard in order for the monitor's power management function to work.

DPMS: Display Power Management Signaling

DPMS	Screen	Power consumption	Hsync	Vsync
ON STATE	Display	312 W	Yes	Yes
STANDBY	No display	18 W	No	Yes
SUSPEND			Yes	No
OFF STATE			No	No

DMPM: Digital Monitor Power Management

DMPM	Screen	Power consumption
Monitor ON	Display	312 W
Active OFF	No display	18 W

## ■ DDC (plug and play)

The monitor supports the VESA DDC (Display Data Channel) standard.

DDC is a signal standard for plug and play between monitors and computers. Information about resolution and other parameters is exchanged between the two. This function can be used if the computer supports DDC and it has been configured to detect plug-and-play monitors.

There are several types of DDC, depending on the communication method used. This monitor supports DDC2B.

# PC Digital/Analog Signal Input Compatibility Chart

- Video Analog RGB (0.7 Vp-p) [75 Ω]
- Sync Conforms to DVI (digital visual interface) standard 1.0  
H/V separate (TTL: Positive/negative), Sync-on-green,  
Composite sync (TTL: Positive/negative)
- Supported frequencies See the Screen resolution chart shown below.

## ■ Screen resolution chart

Screen resolution		Hsync	Vsync	Dot frequency	Analog signal	Digital signal
VESA • IBM AT compatible	640 x 480	31.5 kHz	60.0 Hz	25.175 MHz	○	○
		37.9 kHz	72.0 Hz	31.5 MHz	○	○
		37.5 kHz	75.0 Hz	31.5 MHz	○	○
	800 x 600	35.1 kHz	56.0 Hz	36.0 MHz	○	—
		37.9 kHz	60.0 Hz	40.0 MHz	○	○
		48.1 kHz	72.0 Hz	50.0 MHz	○	○
		46.9 kHz	75.0 Hz	49.5 MHz	○	○
	1024 x 768	48.4 kHz	60.0 Hz	65.0 MHz	○	○
		56.5 kHz	70.0 Hz	75.0 MHz	○	○
		60.0 kHz	75.0 Hz	78.75 MHz	○	○
1280 x 1024	63.3 kHz	60.0 Hz	108.2 MHz	○	○	
Wide	848 x 480	31.1 kHz	60.0 Hz	33.3 MHz	○	—
	852 x 480	31.7 kHz	60.0 Hz	35.0 MHz	○	—
	1280 x 720	44.7 kHz	60.0 Hz	74.4 MHz	○	—
	1280 x 768	47.986 kHz	60.0 Hz	81.0 MHz	○	—
		60.15 kHz	75.0 Hz	102.977 MHz	○	—
	1360 x 768	47.7 kHz	60.0 Hz	84.7 MHz	○	—
	1366 x 768	48.3 kHz	60.0 Hz	81.9 MHz	○	—
1920 x 1080	67.5 kHz	60.0 Hz	148.5 MHz	○	○	
US TEXT	720 x 400	31.5 kHz	70.0 Hz	28.3 MHz	○	○

- \* All are compliant only with non-interlaced.
- \* If the monitor is receiving timing signals that are not compatible, [OUT OF TIMING] will appear. In this case, please change the setting so that the timing signals will be compatible with the monitor, according to your PC manual.
- \* If the monitor is not receiving any signal (sync signal), [NO SIGNAL] will appear.



# Connector Compatibility Charts

## ■ PC digital RGB input terminal pins (DVI-D 24 pin)

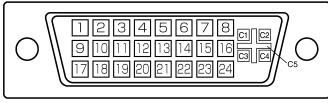

No.	Function	No.	Function
1	TMDS data 2-	16	Hot-plug detection
2	TMDS data 2+	17	TMDS data 0-
3	TMDS data 2/4 shield	18	TMDS data 0+
4	N.C.	19	TMDS data 0/5 shield
5	N.C.	20	N.C.
6	DDC clock	21	N.C.
7	DDC data	22	TMDS clock shield
8	N.C.	23	TMDS clock +
9	TMDS data 1-	24	TMDS clock -
10	TMDS data 1+	C1	N.C.
11	TMDS data 1/3 shield	C2	N.C.
12	N.C.	C3	N.C.
13	N.C.	C4	N.C.
14	+5 V	C5	GND
15	GND		

## ■ PC analog RGB input terminal pins (Mini D-sub 15 pin)

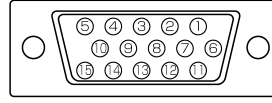

No.	Function	No.	Function
1	Red video signal input	9	+5 V
2	Green video signal input	10	GND
3	Blue video signal input	11	N.C.
4	N.C.	12	DDC data
5	GND	13	Hsync signal input
6	GND for red video signal	14	Vsync signal input
7	GND for green video signal	15	DDC clock
8	GND for blue video signal		

## ■ RS-232C input terminal pins (D-sub 9 pin)

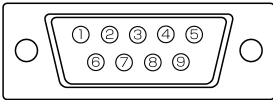

No.	Function	No.	Function
1	N.C.	6	Data set ready
2	Transmitted data	7	Request to send
3	Received data	8	Clear to send
4	Data terminal ready	9	N.C.
5	GND		

## ■ PC analog RGB output terminal pins (Mini D-sub 15 pin)

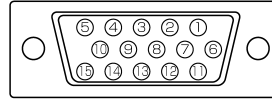

No.	Function	No.	Function
1	Red video signal input	9	+5 V
2	Green video signal input	10	GND
3	Blue video signal input	11	N.C.
4	N.C.	12	N.C.
5	GND	13	Hsync signal output
6	GND for red video signal	14	Vsync signal output
7	GND for green video signal	15	N.C.
8	GND for blue video signal		

## ■ RS-232C output terminal pins (D-sub 9 pin)

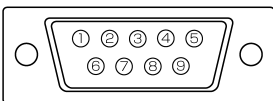

No.	Function	No.	Function
1	Carrier detect	6	Data set ready
2	Received data	7	Request to send
3	Transmitted data	8	Clear to send
4	Data terminal ready	9	Ring indicator (open)
5	GND		

# Dimensional Drawings

Unit: inch [mm]

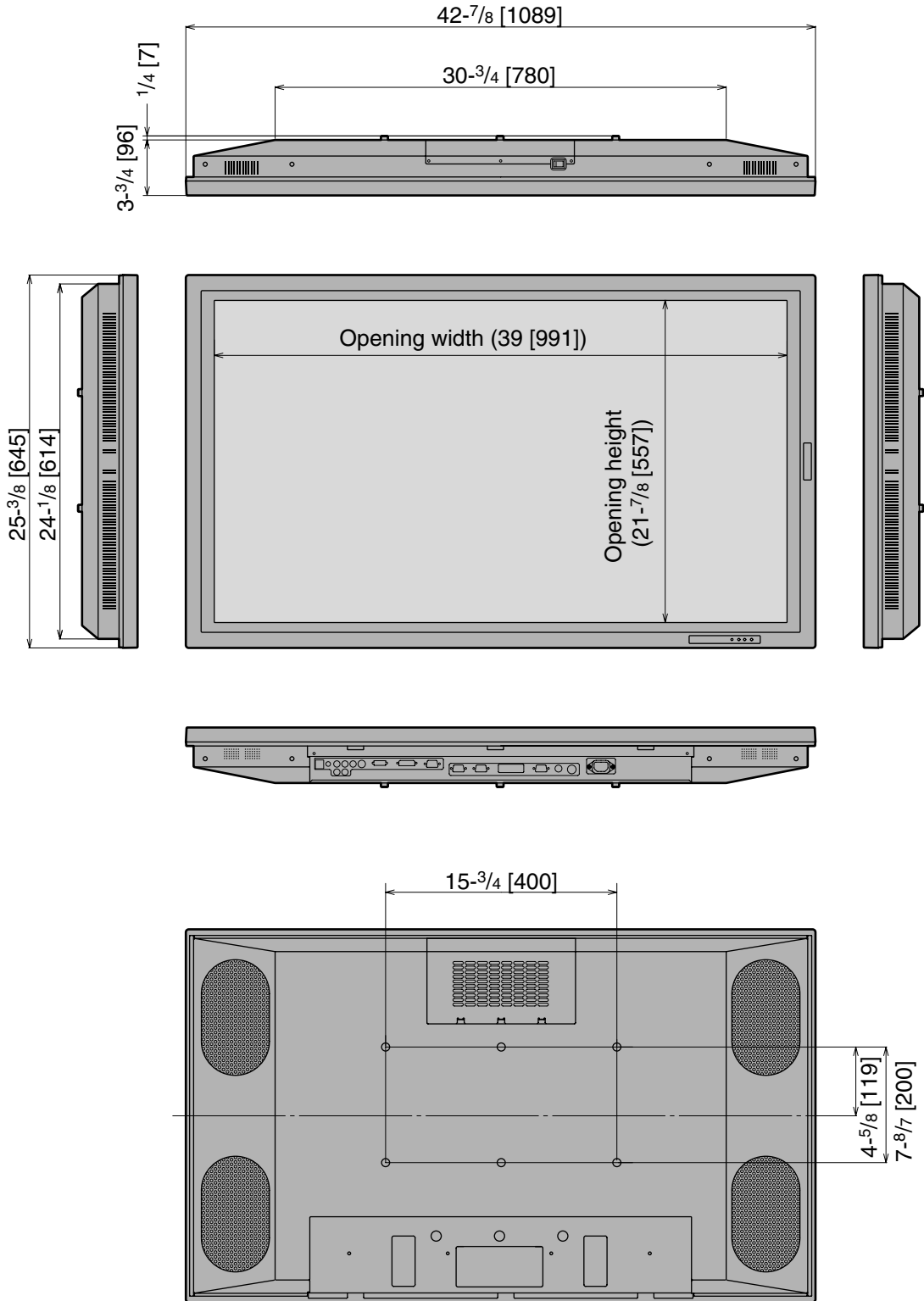

# Menu Option Reference Chart

## INPUT1

WHITE BALANCE	<table border="1"> <tr><td>THRU</td></tr> <tr><td>COOL</td></tr> <tr><td>•</td></tr> <tr><td>STD</td></tr> <tr><td>•</td></tr> <tr><td>WARM</td></tr> <tr><td>USER</td></tr> </table>	THRU	COOL	•	STD	•	WARM	USER	<table border="1"> <tr><td>R-CONTRAST</td><td>0 to 255</td></tr> <tr><td>G-CONTRAST</td><td>0 to 255</td></tr> <tr><td>B-CONTRAST</td><td>0 to 255</td></tr> </table>	R-CONTRAST	0 to 255	G-CONTRAST	0 to 255	B-CONTRAST	0 to 255
THRU															
COOL															
•															
STD															
•															
WARM															
USER															
R-CONTRAST	0 to 255														
G-CONTRAST	0 to 255														
B-CONTRAST	0 to 255														
MODE SELECT1	<table border="1"> <tr><td>ENLARGE</td><td>OFF, 2 x 2, 3 x 3</td></tr> <tr><td>ENLARGE POS</td><td>2 x 2: 0 to 3, 3 x 3: 0 to 8</td></tr> <tr><td>MULTI ZOOM</td></tr> </table>	ENLARGE	OFF, 2 x 2, 3 x 3	ENLARGE POS	2 x 2: 0 to 3, 3 x 3: 0 to 8	MULTI ZOOM	<table border="1"> <tr><td>IMAGE ZOOM</td></tr> <tr><td>H-POS</td></tr> <tr><td>V-POS</td></tr> </table>	IMAGE ZOOM	H-POS	V-POS					
ENLARGE	OFF, 2 x 2, 3 x 3														
ENLARGE POS	2 x 2: 0 to 3, 3 x 3: 0 to 8														
MULTI ZOOM															
IMAGE ZOOM															
H-POS															
V-POS															
MODE SELECT 2	<table border="1"> <tr><td>OFF TIMER</td><td>0 to 23</td></tr> <tr><td>OSD H-POSITION</td></tr> <tr><td>OSD V-POSITION</td></tr> <tr><td>LANGUAGE</td></tr> <tr><td>ID NO SET</td><td>0 to 255</td></tr> </table>	OFF TIMER	0 to 23	OSD H-POSITION	OSD V-POSITION	LANGUAGE	ID NO SET	0 to 255							
OFF TIMER	0 to 23														
OSD H-POSITION															
OSD V-POSITION															
LANGUAGE															
ID NO SET	0 to 255														

## INPUT2

ADJUSTMENT	<table border="1"> <tr><td>MANUAL</td></tr> <tr><td>AUTO</td></tr> </table>	MANUAL	AUTO	<table border="1"> <tr><td>CLOCK</td><td>0 to 255</td></tr> <tr><td>PHASE</td><td>0 to 255</td></tr> <tr><td>H-POS</td><td>0 to 255</td></tr> <tr><td>V-POS</td><td>0 to 255</td></tr> </table>	CLOCK	0 to 255	PHASE	0 to 255	H-POS	0 to 255	V-POS	0 to 255		
MANUAL														
AUTO														
CLOCK	0 to 255													
PHASE	0 to 255													
H-POS	0 to 255													
V-POS	0 to 255													
GAIN CONTROL	<table border="1"> <tr><td>MANUAL</td></tr> <tr><td>AUTO</td></tr> </table>	MANUAL	AUTO	<table border="1"> <tr><td>BLACK LEVEL</td><td>0 to 31</td></tr> <tr><td>CONTRAST</td><td>0 to 31</td></tr> </table>	BLACK LEVEL	0 to 31	CONTRAST	0 to 31						
MANUAL														
AUTO														
BLACK LEVEL	0 to 31													
CONTRAST	0 to 31													
WHITE BALANCE	<table border="1"> <tr><td>COOL</td></tr> <tr><td>•</td></tr> <tr><td>STD</td></tr> <tr><td>•</td></tr> <tr><td>WARM</td></tr> <tr><td>USER</td></tr> </table>	COOL	•	STD	•	WARM	USER	<table border="1"> <tr><td>R-CONTRAST</td><td>0 to 255</td></tr> <tr><td>G-CONTRAST</td><td>0 to 255</td></tr> <tr><td>B-CONTRAST</td><td>0 to 255</td></tr> </table>	R-CONTRAST	0 to 255	G-CONTRAST	0 to 255	B-CONTRAST	0 to 255
COOL														
•														
STD														
•														
WARM														
USER														
R-CONTRAST	0 to 255													
G-CONTRAST	0 to 255													
B-CONTRAST	0 to 255													
MODE SELECT1	<table border="1"> <tr><td>480 LINES</td><td>852, 848, 640</td></tr> <tr><td>768 LINES</td><td>1366, 1360, 1280, 1024</td></tr> <tr><td>ENLARGE</td><td>OFF, 2 x 2, 3 x 3</td></tr> <tr><td>ENLARGE POS</td><td>2 x 2: 0 to 3, 3 x 3: 0 to 8</td></tr> <tr><td>MULTI ZOOM</td></tr> </table>	480 LINES	852, 848, 640	768 LINES	1366, 1360, 1280, 1024	ENLARGE	OFF, 2 x 2, 3 x 3	ENLARGE POS	2 x 2: 0 to 3, 3 x 3: 0 to 8	MULTI ZOOM	<table border="1"> <tr><td>IMAGE ZOOM</td></tr> <tr><td>H-POS</td></tr> <tr><td>V-POS</td></tr> </table>	IMAGE ZOOM	H-POS	V-POS
480 LINES	852, 848, 640													
768 LINES	1366, 1360, 1280, 1024													
ENLARGE	OFF, 2 x 2, 3 x 3													
ENLARGE POS	2 x 2: 0 to 3, 3 x 3: 0 to 8													
MULTI ZOOM														
IMAGE ZOOM														
H-POS														
V-POS														

# Menu Option Reference Chart (Continued)

## MODE SELECT 2

OFF TIMER	0 to 23
OSD H-POSITION	
OSD V-POSITION	
LANGUAGE	
ID NO SET	0 to 255

## ■ INPUT3/4

### WHITE BALANCE

CONTRAST	0 to 31
BLACK LEVEL	0 to 31
TINT	0 to 31
COLORS	0 to 31
SHARPNESS	0 to 31
WHITE BALANCE	COOL, •, STD, •, WARM

## MODE SELECT 2

OFF TIMER	0 to 23
OSD H-POSITION	
OSD V-POSITION	
LANGUAGE	0 to 255
ID NO SET	

# Part Names - Display (Continued)

## Rear view

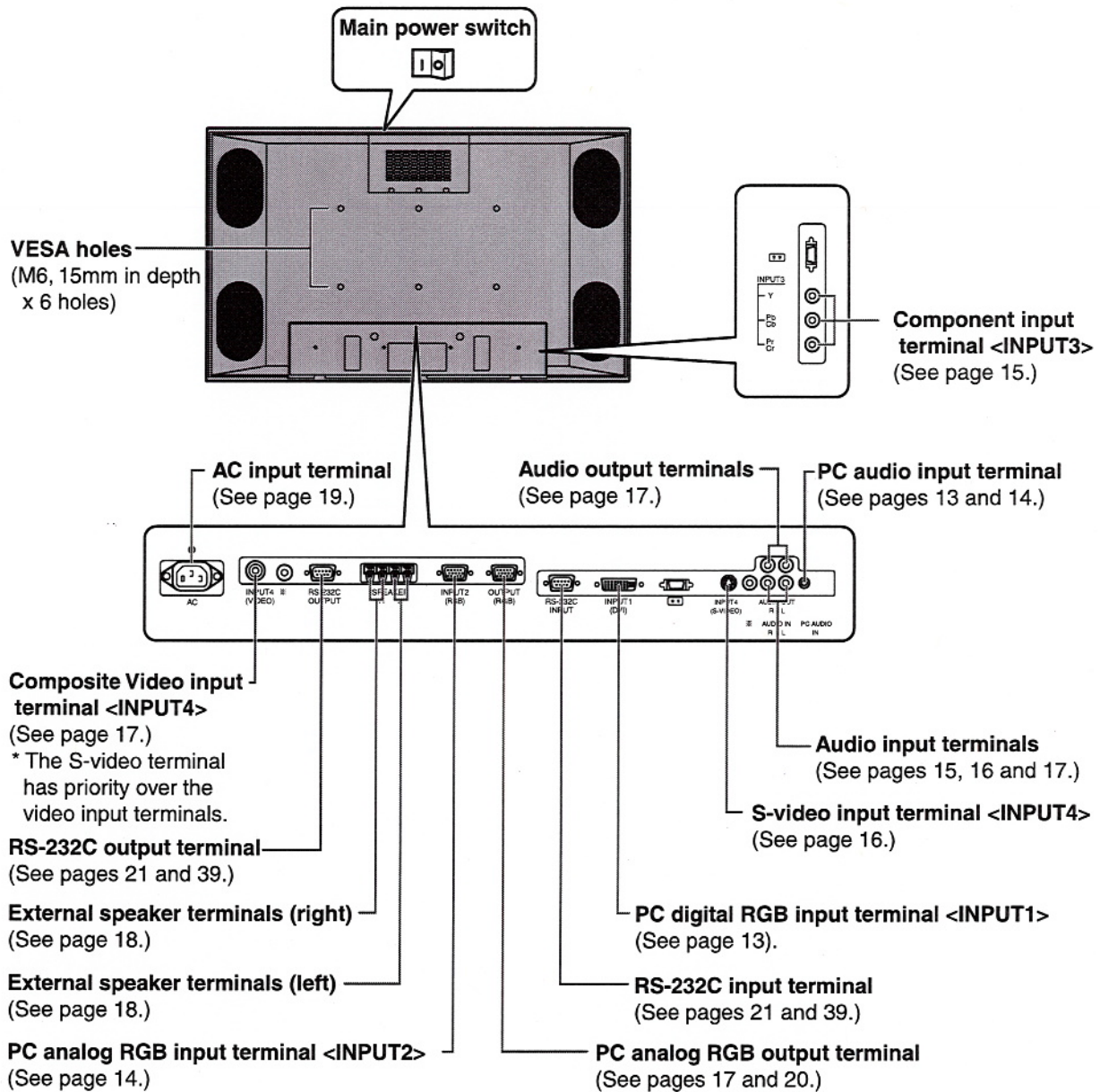



**Page 2: IN INFORMATION:**

The following section indicated in red was replaced with new sentence indicated in blue .

**INFORMATION:**

This equipment has been tested and found to comply with the limits for Class A digital equipment, pursuant to Part 15 of the FCC Rules. These limits are designed to provide reasonable protection against harmful interference in a residential installation. This equipment generates, uses, and can radiate radio frequency energy and, if not installed and used in accordance with the instructions, may cause harmful interference to radio communications. However, there is no guarantee that interference will not occur in a particular installation. If this equipment does cause harmful interference to radio or television reception, which can be determined by turning the equipment off and on, the user is encouraged to try to correct the interference by one or more of the following measures:

- Relocate or adjust the receiving antenna.
- Increase the separation between the equipment and receiver.
- Connect the equipment into an outlet on a circuit different from that to which the receiver is connected.
- Consult an authorized dealer or experienced radio/TV technician for help.

**INFORMATION:**

This equipment has been tested and found to comply with the limits for a Class A digital device, pursuant to Part 15 of the FCC Rules. These limits are designed to provide reasonable protection against harmful interference when the equipment is operated in a commercial environment. This equipment generates, uses, and can radiate radio frequency energy and, if not installed and used in accordance with the instruction manual, may cause harmful interference to radio communications. Operation of this equipment in a residential area is likely to cause harmful interference in which case the user will be required to correct the interference at his own expense.

**Page 2 : The following section indicated in red was deleted.**

**CAUTION**

Danger of explosion if battery is incorrectly replaced.

Replace only with the same or equivalent type  
recommended by the manufacturer.

Dispose of used batteries according  
to local regulations.

**Page 3. IN SAFETY PRECAUTIONS**

**: The following sentence indicated in red was deleted.**

"8. Stand — Do not place the product on an unstable cart, stand, tripod or table. Placing the product on an unstable base can cause the product to fall, resulting in serious personal injuries as well as damage to the product."

**Page 10 was replaced with attached addendum sheet.**