



SAMSUNG PLASMA DISPLAY

Owner's Instructions

SPN4235



ELECTRONICS

SERVICE DIVISION
400 Valley Road, Suite 201
Mount Arlington, NJ 07856
TEL : 1-800-SAMSUNG (1-800-726-7864)
www.samsungusa.com



Warning! Important Safety Instructions

CAUTION
RISK OF ELECTRIC SHOCK
DO NOT OPEN

CAUTION: TO REDUCE THE RISK OF ELECTRIC SHOCK, DO NOT REMOVE COVER (OR BACK). NO USER SERVICEABLE PARTS INSIDE. REFER SERVICING TO QUALIFIED SERVICE PERSONNEL.



This symbol indicates high voltage is present inside. It is dangerous to make any kind of contact with any inside part of this product.



This symbol alerts you that important literature concerning operation and maintenance has been included with this product.

Note to CATV system installer: This reminder is provided to call CATV system installer's attention to Article 820-40 of the National Electrical Code (Section 54 of Canadian Electrical Code, Part I), that provides guidelines for proper grounding and, in particular, specifies that the cable ground shall be connected to the grounding system of the building as close to the point of cable entry as practical.

Caution: FCC/CSA regulations state that any unauthorized changes or modifications to this equipment may void the user's authority to operate it.

Caution: To prevent electric shock, match the wide blade of plug to the wide slot, and fully insert the plug.

Attention: pour éviter les chocs électriques, introduire la lame le plus large de la fiche dans la borne correspondante de la prise et pousser jusqu'au fond.

Important: One Federal Court has held that unauthorized recording of copyrighted TV programs is an infringement of U.S. copyright laws. Certain Canadian programs may also be copyrighted and any unauthorized recording in whole or in part may be in violation of these rights.

TO PREVENT DAMAGE WHICH MAY RESULT IN FIRE OR ELECTRIC SHOCK HAZARD, DO NOT EXPOSE THIS APPLIANCE TO RAIN OR MOISTURE.

Thank You for Choosing Samsung

Thank you for choosing Samsung! Your new Samsung product represents the latest in television technology. We designed it with easy-to-use on-screen menus and closed captioning capabilities, making it one of the best products in its class. We are proud to offer you a product that will provide convenient, dependable service and enjoyment for years to come.

Important Safety Information

Always be careful when using your PDP. To reduce the risk of fire, electrical shock, and other injuries, keep these safety precautions in mind when installing, using, and maintaining your machine.

- Read all safety and operating instructions before operating your PDP.
- Keep the safety and operating instructions for future reference.
- Heed all warnings on the PDP and in the operating instructions.
- Follow all operating and use instructions.
- Unplug the PDP from the wall outlet before cleaning. Use a damp cloth; do not use liquid or aerosol cleaners.
- Never add any attachments and/or equipment without approval of the manufacturer. Such additions can increase the risk of fire, electric shock, or other personal injury.
- Do not use the PDP where contact with or immersion in water is a possibility, such as near bath tubs, sinks, washing machines, swimming pools, etc.
- Do not place the PDP on an unstable cart, stand, tripod, bracket, table, or floor where it can fall. A falling PDP can cause serious injury to a child or adult, and serious damage to the appliance. Use only with a cart, stand, tripod, bracket, or table recommended by the manufacturer or sold with the PDP. Follow the manufacturer's instructions when mounting the unit, and use a mounting accessory recommended by the manufacturer. Move the PDP and cart with care. Quick stops, excessive force, and uneven surfaces can make the unit and cart unsteady and likely to overturn.
- Provide ventilation for the PDP. The unit is designed with slots in the cabinet for ventilation to protect it from overheating. Do not block these openings with any object, and do not place the PDP on a bed, sofa, rug, or other similar surface. Do not place it near a radiator or heat register. If you place the PDP on a rack or bookcase, ensure that there is adequate ventilation and that you've followed the manufacturer's instructions for mounting.
- Operate your PDP only from the type of power source indicated on the marking label. If you are not sure of the type of power supplied to your home, consult your appliance dealer or local power company.
- Use only a grounded or polarized outlet. For your safety, this PDP is equipped with a polarized alternating current line plug having one blade wider than the other. This plug will fit into the power outlet only one way. If you are unable to insert the plug fully into the outlet, try reversing the plug. If the plug still does not fit, contact your electrician to replace your outlet.



FCC Information

- Protect the power cord. Power supply cords should be routed so that they won't be walked on or pinched by objects placed on or against them. Pay particular attention to cords at plugs, convenience receptacles, and the point where they exit from the unit.
- Unplug the PDP from the wall outlet and disconnect the antenna or cable system during a lightning storm or when left unattended and unused for long periods of time. This will prevent damage to the unit due to lightning and power-line surges.
- Avoid overhead power lines. An outside antenna system should not be placed in the vicinity of overhead power lines or other electric light or power circuits or where it can fall into such power lines or circuits. When installing an outside antenna system, be extremely careful to keep from touching the power lines or circuits. Contact with such lines can be fatal.
- Do not overload the wall outlet or extension cords. Overloading can result in fire or electric shock.
- Do not insert anything through the openings in the unit, where they can touch dangerous voltage points or damage parts. Never spill liquid of any kind on the PDP.
- Ground outdoor antennas. If an outside antenna or cable system is connected to the PDP, be sure the antenna or cable system is grounded so as to provide some protection against voltage surges and built-up static charges. Section 810 of the National Electrical Code, ANSI/NFPA No. 70-1984, provides information about proper grounding of the mast and supporting structure, grounding of the lead-in wire to an antenna discharge unit, size of grounding conductors, location of antenna discharge unit, connection to grounding electrodes, and requirements for the grounding electrode.
- Do not attempt to service the PDP yourself. Refer all servicing to qualified service personnel. Unplug the unit from the wall outlet and refer servicing to qualified service personnel under the following conditions:
 - when the power-supply cord or plug is damaged
 - if liquid has been spilled on the unit or if objects have fallen into the unit
 - if the PDP has been exposed to rain or water
 - if the PDP does not operate normally by following the operating instructions
 - if the PDP has been dropped or the cabinet has been damaged
 - when the PDP exhibits a distinct change in performance
- If you make adjustments yourself, adjust only those controls that are covered by the operating instructions. Adjusting other controls may result in damage and will often require extensive work by a qualified technician to restore the PDP to normal.
- When replacement parts are required, be sure the service technician uses replacement parts specified by the manufacturer or those that have the same characteristics as the original part. Unauthorized substitutions may result in additional damage to the unit.
- Upon completion of any service or repairs to this PDP, ask the service technician to perform safety checks to determine that the PDP is in a safe operating condition.
- The PDP can properly operate in a temperature range of 32-104°F(0-40°C) and 80% humidity. Do not use in a hot and humid place.
- Before moving the PDP equipped with speakers, separate the speakers from the PDP. If you move the PDP with the speakers attached, it may result in damage or injury.

User Instructions

The Federal Communications Commission Radio Frequency Interference Statement includes the following warning:
 NOTE: This equipment has been tested and found to comply with the limits for a Class B digital device, pursuant to Part 15 of the FCC Rules. These limits are designed to provide reasonable protection against harmful interference in a residential installation. This equipment generates, uses, and can radiate radio frequency energy and, if not installed and used in accordance with the instructions, may cause harmful interference to radio communications. However, there is no guarantee that interference will not occur in a particular installation.

If this equipment does cause harmful interference to radio or television receptions, which can be determined by turning the equipment off and on, the user is encouraged to try to correct the interference by one or more of the following measures:

- Reorient or relocate the receiving antenna.
- Increase the separation between the equipment and receiver.
- Connect the equipment into an outlet on a circuit different from that to which the receiver is connected.
- Consult the dealer or an experienced radio/TV technician for help.

User Information

Changes or modifications not expressly approved by the party responsible for compliance could void the user's authority to operate the equipment. If necessary, consult your dealer or an experienced radio/television technician for additional suggestions. You may find the booklet called How to Identify and Resolve Radio/TV Interference Problems helpful. This booklet was prepared by the Federal Communications Commission. It is available from the U.S. Government Printing Office, Washington, DC 20402, Stock Number 004-000-00345-4.

The party responsible for product compliance:
 SAMSUNG ELECTRONICS CO., LTD
 America QA Lab of Samsung
 3351 Michelson Drive,
 Suite #290, Irvine, CA92612 USA

This device complies with part 15 of the FCC Rules. Operation is subject to the following two conditions:
 (1) This device may not cause harmful interference, and
 (2) This device must accept any interference received, including interference that may cause undesired operation.
 This television receiver provides display of television closed captioning in accordance with §15.119 of the FCC rules.

Warning

User must use shielded signal interface cables to maintain FCC compliance for the product. Provided with this monitor is a detachable power supply cord with IEC320 style terminations. It may be suitable for connection to any UL Listed personal computer with similar configuration. Before making the connection, make sure the voltage rating of the computer convenience outlet is the same as the monitor and that the ampere rating of the computer convenience outlet is equal to or exceeds the monitor voltage rating. For 120 Volt applications, use only UL Listed detachable power cord with NEMA configuration 5-15P type (parallel blades) plug cap. For 240 Volt applications use only UL Listed Detachable power supply cord with NEMA configuration 6015P type (tandem blades) plug cap.

IC Compliance Notice

This Class B digital apparatus meets all requirements of the Canadian Interference-Causing Equipment Regulations of ICES-003.

Cet appareil Numérique de classe B respecte toutes les exigences du Règlement NMB-03 sur les équipements produisant des interférences au Canada.

Notice de Conformité IC

Cet appareil numérique de classe B respecte toutes les exigences du Règlement ICES-003 sur les équipements produisant des interférences au Canada.

VCCI

This is a Class B product based on the standard of the Voluntary Control Council for Interference by Information Technology Equipment (VCCI). If this is used near a radio or television receiver in a domestic environment, it may cause radio interference. Install and use the equipment according to the instruction manual.

*This Class B digital apparatus complies with Canadian ICES-003.
 Cet appareil numérique de la classe B est conforme à la norme NMB-003 du Canada.*

Important Warranty Information Regarding Television Format Viewing

Wide screen format PDP Displays (16:9, the aspect ratio of the screen width to height) are primarily designed to view wide screen format full-motion video. The images displayed on them should primarily be in the wide screen 16:9 ratio format, or expanded to fill the screen if your model offers this feature and constantly moving. Displaying stationary graphics and images on screen, such as the dark side-bars on non-expanded standard format television video and programming, should be limited to no more than 5% of the total television viewing per week.

Additionally, viewing other stationary images and text such as stock market reports, video game displays, station logos, web sites or computer graphics and patterns, should be limited as described above for all televisions. **Displaying stationary images that exceed the above guidelines can cause uneven aging of PDP Displays that leave subtle, but permanent burned-in ghost images in the PDP picture. To avoid this, vary the programming and images, and primarily display full screen moving images, not stationary patterns or dark bars.** On PDP models that offer picture sizing features, use these controls to view different formats as a full screen picture.

Be careful in the selection and duration of television formats used for viewing. Uneven PDP aging as a result of format selection and use, as well as burned-in images, are not covered by your Samsung limited warranty.

User Instructions

Screen Image retention

Do not display a still image (such as on a video game or when hooking up a PC to this PDP) on the plasma display panel for more than several minutes as it can cause screen image retention. This image retention is also known as "screen burn". To avoid such image retention, refer to page 40 of this manual to reduce the degree of brightness and contrast of this screen when displaying a still image.

Cell Defect

The plasma display panel consists of fine cells. Although the panels are produced with more than 99.9 percent active cells, there may be some cells that do not produce light or remain lit.

Altitude

The PDP will not operate normally at altitudes above 6500 ft.

Table of Contents

General Information

Your New Plasma Display Panel	10
Remote Control Buttons	12
Wall Installation Instructions	14

Connections

Connecting VHF and UHF Antennas	20
Connecting Cable TV	21
Connecting Speakers	23
Connecting a VCR	24
Connecting a Camcorder	25
Connecting a DVD Player	26
Connecting a DTV Receiver	27

Operation

Turning the PDP On and Off	30
Memorizing the Channels	32
Setting Up Your Remote Control	37

Picture Control

Customizing the Picture	40
Using Automatic Picture Settings	41
Selecting the Color Tone	42
DNLe (Digital Natural Image engine)	43
Viewing the Picture-in-Picture	44
Changing the Screen Size	50
Freezing the Picture	51

Sound Control

Customizing the Sound	54
Using Automatic Sound Settings	55
Choosing a Multi-Channel Sound (MTS) Soundtrack	56
Using the Auto Volume	57
Using Dolby Virtual	58
Using a Subwoofer	59

Channel Control

Fine Tuning Channels	62
LNA (Low Noise Amplifier)	63

Connecting a PC and Operation

Connecting to a PC	66
Adjusting the PC Screen	70
Changing the Position of the Image	71
Changing the Size of the Image	72
Information	73
Picture Quality Adjustment	74

Time Setting

Setting the Clock	78
Setting the Sleep Timer	79
Setting the Timers	80
Setting the Preferred Channel and Volume Level	82

Function Description

Selecting a Menu Language	84
Viewing Closed Captions	85
Digital Noise Reduction	86
Setting Auto Power Off	87
Using the V-Chip	88
Selecting the Film Mode	94

Appendix

Troubleshooting	96
Care and Maintenance	97
Specifications	98

SAMSUNG

P L A S M A D I S P L A Y P A N E L

General Information



Your New Plasma Display Panel	10
Remote Control Buttons	12
Wall Installation Instructions	14



Your New Plasma Display Panel

Front Panel

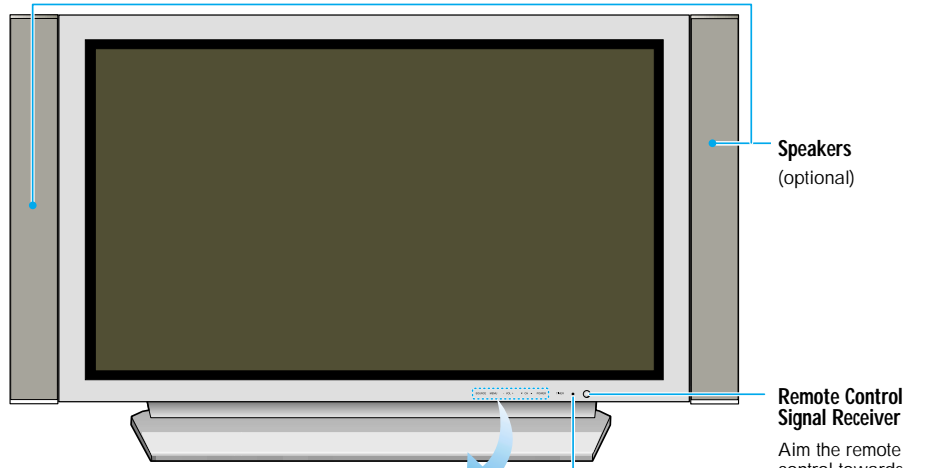

- SOURCE button**
Press to display all of the available video sources (ie., Video, S-Video, Component1, Component2, PC).
- MENU button**
Displays the main on-screen menu.
- VOL(+,-) button**
Press to increase or decrease the volume. Also used to select or adjust items on the on-screen menu.
- CH(▼,▲) button**
Press CH▲ or CH▼ to change Channels. Also used to move up or down in the On-screen menu.
- POWER button**
Press to turn the PDP on and off.

- Power Indicator**
Power Off : LED Red
Power On (Timer On) : LED Green
Power On (Timer Off) : LED Off

Rear Panel

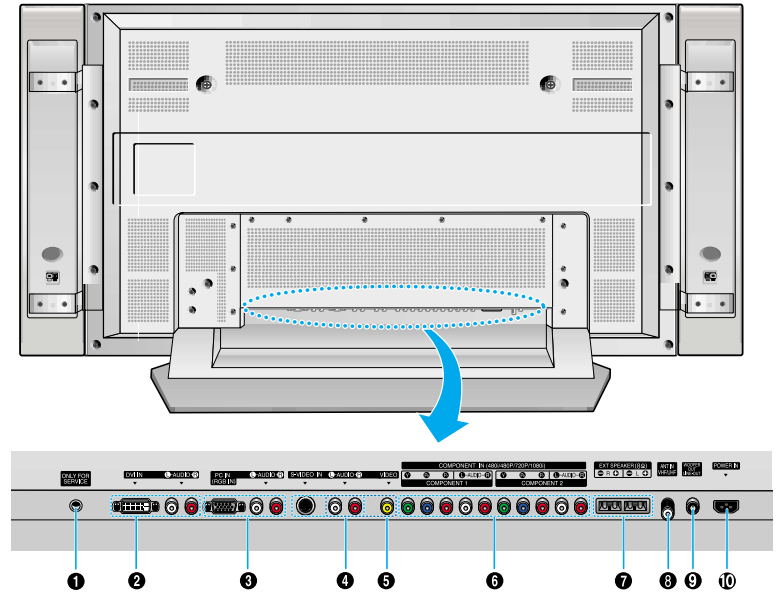

- 1 Service jack**
For service only.
- 2 DVI Input jacks**
Receives the digital video/audio signals from a set top box or PC.
- 3 PC(RGB) Input jacks(15pin)**
Connect to the video/audio output jacks on your PC.
- 4 S-Video Input jacks**
Connect S-Video/audio signals from external sources such as VCRs or DVD players.
- 5 Video Input jacks**
Connect video/audio signals from external sources such as VCRs or DVD players.
- 6 Component Video/Audio Input jacks (Y/Pb/Pr/Audio L/Audio R)**
Connect to the audio and component output jacks of a DVD player or Set-Top Box.
- 7 External Speaker Out jacks**
Connect external speakers.
- 8 Antenna jack**
Connect to antenna.
- 9 Sub-woofer speaker output jack**
Connect to the Sub-woofer speaker jack.
- 10 Power Input jack**
Connect the supplied power cord.

Checking Accessories

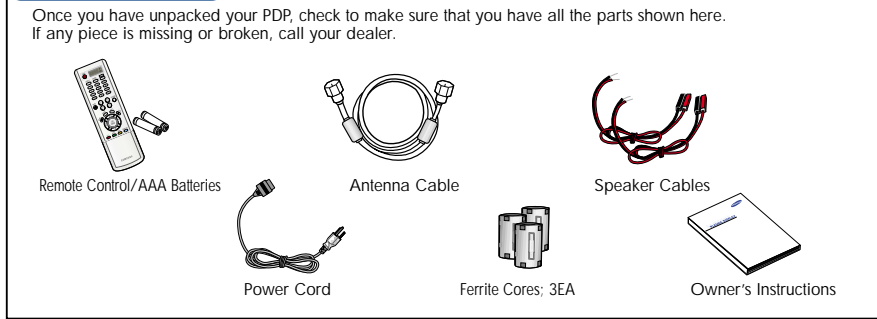



Remote Control Buttons

Remote Control

- 1 POWER button**
Turns the PDP on and off.
- 2 ASPECT button**
Press to change the screen size.
- 3 Number buttons**
- 4 +100 button**
Press to select channels over 100. For example, to select channel 121, press "+100", then press "2" and "1."
- 5 MUTE button**
Press to mute the PDP sound.
- 6 VOL (Volume) buttons**
Use it to adjust volume.
- 7 SLEEP button**
Press to select a preset time interval for automatic shutoff.
- 8 MENU button**
Displays the main on-screen menu.
- 9 ENTER button**
Confirms a selection.
- 10 PIP button**
Activates picture in picture.
- 11 STILL button**
Press to pause the current screen.
- 12 LED Display**
When you press a button, ' ' appears along with selected mode (TV, VCR, CATV, DVD or STB) and remaining batteries on LED.
- 13 P.MODE button**
Adjust the PDP picture by selecting one of the preset factory settings (or select your personal, customized picture settings.)
- 14 MODE button**
Selects a target device to be controlled by the Samsung remote control (ie., VCR, Cable, DVD players or STB). If you change modes, the new mode is momentarily displayed on LED.
- 15 PRE-CH button**
Tunes to the previous channel.
- 16 TV/VIDEO button**
Press to display all of the available video sources (ie., Video, S-Video, Component1, Component2, PC, DVI).
- 17 CH (Channel) buttons**
Use it to switch channels.
- 18 INFO button**
Press to display information on the PDP screen.
- 19 EXIT button**
Press to exit the menu.
- 20 Up/Down Left/Right buttons**
Control the cursor in the menu.

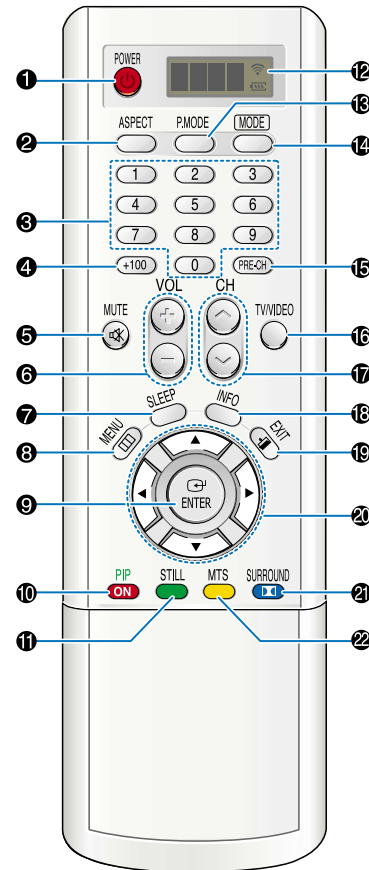

- 21 SURROUND button**
Press the hear the Dolby surround effect.
- 22 MTS button**
Press to choose stereo, mono or Separate Audio Program (SAP broadcast).
- 23 AUTO PROG. button**
The TV automatically cycles through all of the available channels and stores them in memory.
- 24 ADD/DEL button**
Press to add or delete channels in the TV's memory.
- 25 DNIe button**
Activates DNIe (Digital Natural Image engine).
- 26 CAPTION button**
Controls the caption decoder.
- 27 SET button**
Used during set up of this Samsung remote control, so that it will work compatibly with other devices (VCR, cable box, DVD)
- 28 PIP control buttons**
 - SWAP : Exchanges the video signal that is currently displayed on the main screen with the signal in the PIP window.
 - SIZE : Press to make the PIP window Large, Small or Double.
 - CH▲▼ : Displays the available channels in sequence. (These buttons change channels in the PIP window only).
- 29 VCR, DVD control buttons**
Controls VCR tape or DVD disc functions: Stop, Rewind, Play/Pause, Fast Forward.
- 30 RESET button**
If your remote control is not functioning properly, take out the batteries and press the reset button for about 2-3 seconds. Re-insert the batteries and try using the remote control again.

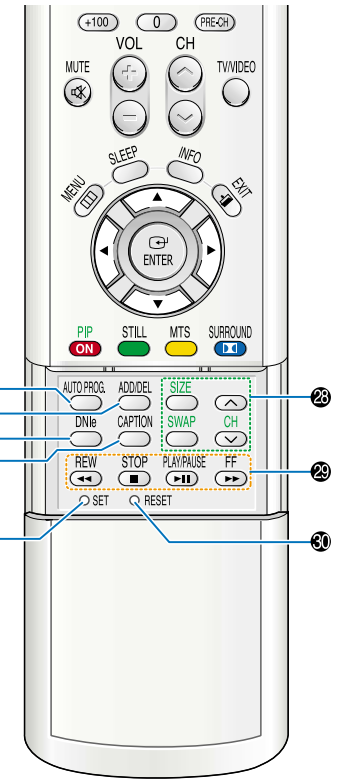

Installing the Batteries in Your Remote Control

- 1** Slide the back cover to open the battery compartment of the remote control.
- 2** Install two AAA size batteries. Make sure to match the "+" and "-" ends of the batteries with the diagram inside the compartment.
- 3** Slide the cover back into place.



Remote Control Operation Range.

You can use your remote control within a distance of 23 feet and an angle of 30 degrees from the left and right sides of the PDP's remote control receiver.



Wall Installation Instructions

Installation Notes

- 1 Do not install the PDP in any location other than a vertical wall.
- 2 To protect the performance of the PDP and prevent problems, avoid the following places.
 - Do not install next to smoke and fire detectors.
 - Do not install in an area subjected to vibration.
 - Do not install in an area subjected to high voltage.
 - Do not install near or around any heating apparatus.
- 3 Use only recommended parts and components.

Parts (Wall attachment panel is sold separately. Check with your dealer)

Wall attachment panel

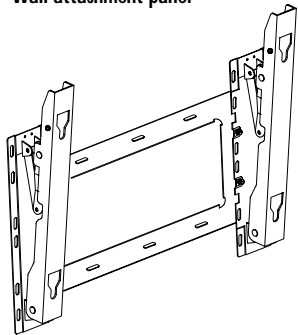

Insulation holders ; 4 EA



Screws ; 4 EA

Fixing the PDP panel to the wall attachment panel bracket

- 1 Remove the screws on the rear of the PDP panel.

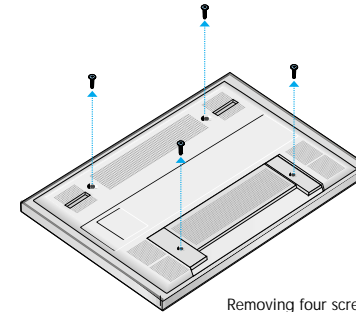

Removing four screws

- 2 Connect Insulation holders to screws. (see the illustration below)



- 3 Tighten the screws connected to the Insulation holders on the rear of the PDP panel.

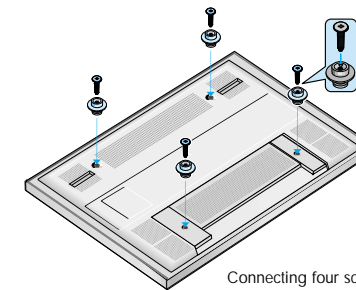

Connecting four screws

- 4 Put the 4 pegs on the PDP in the grooves of the wall mount bracket and pull down on the PDP (1) to secure it to the wall mount bracket. (2) Tighten the screws as shown (3) so that the PDP cannot be separated from wall mount bracket.

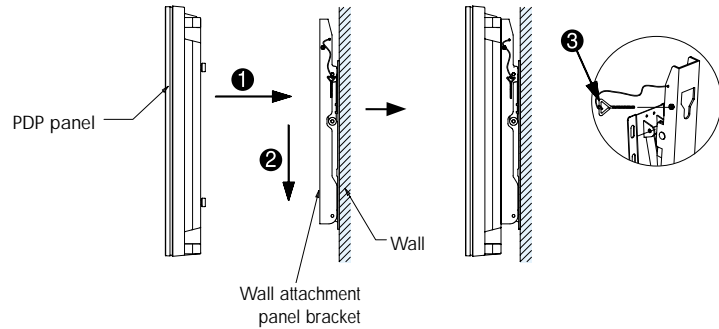

How to Adjust Mounting Angle

Notice : Please secure the mounting bracket on the wall surface after setting its angle at 0°

Factory default

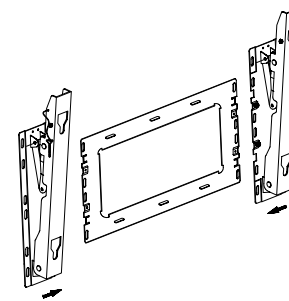

The wall mount bracket is delivered separately. Please tighten the captive screw in the direction of the arrow after assembling the bracket.

Changing the angle

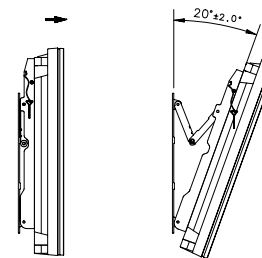

- 1 Secure the PDP to the wall mount bracket. (Please refer to the following instructions.)
- 2 Set the angle by pulling the upper end of the PDP attached to bracket in the direction of the arrow.
- 3 The angle can be adjusted from 0° to 20° by $\pm 2^\circ$.



1. Contact an authorized technician when installing the wall attachment panel.
2. After hanging the PDP panel on the wall attachment panel, make sure that the insulation holders are completely hung.
3. Be careful so that fingers are not caught.
4. Make sure the wall attachment panel brackets are tightened. Otherwise, the PDP panel may fall down and you might be hurt.

SAMSUNG

P L A S M A D I S P L A Y P A N E L

Connections



Connecting VHF and UHF Antennas	20
Connecting Cable TV	21
Connecting Speakers	23
Connecting a VCR	24
Connecting a Camcorder	25
Connecting a DVD Player	26
Connecting a DTV Receiver	27



Connecting VHF and UHF Antennas

Antennas with 75-ohm Round Leads

If your antenna looks like this:  it has 75-ohm round leads.

- 1 Plug the antenna lead into the VHF/UHF terminal on the PDP. Use the Antenna Cable, an accessory included in the product package.

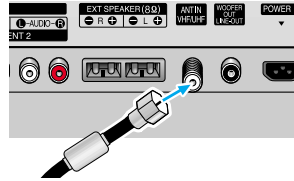

Connecting Cable TV

You can connect different cable systems to your PDP, including cable without a cable box, and cable with a cable box that descrambles some or all channels.

Cable without a Cable Box

- 1 Plug the incoming cable into the VHF/UHF terminal on the PDP. Use the Antenna Cable, an accessory included in the product package.

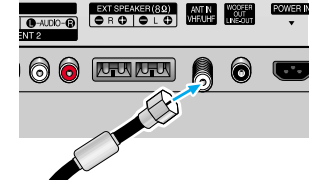

Cable with a Cable Box that Descrambles All Channels.

- 1 Find the cable connected to the ANTENNA OUT terminal on your cable box. This terminal might be labeled "ANT OUT", "VHF OUT", or simply "OUT".
- 2 Connect the cable to the VHF/UHF terminal on the PDP. Use the Antenna Cable, an accessory included in the product package.

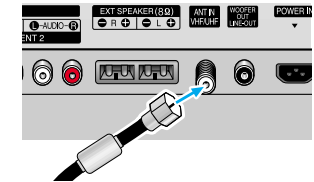



Connecting Speakers

External speakers are sold separately. Check with your dealer.

Cable with a Cable Box that Descrambles Some (But Not All) Channels

To complete this connection you will need a two-way splitter, an RF (A/B) switch, and four coaxial cables (which you can buy from your Samsung dealer or any electronics store).

- 1 Find and disconnect the cable that is connected to the ANTENNA IN terminal of your cable box. This terminal might be labeled "ANT IN", "VHF IN", or simply, "IN". Connect this cable to a two-way splitter.

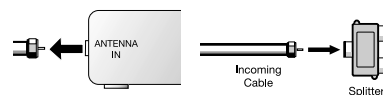

- 2 Connect a coaxial cable between an OUTPUT terminal of the splitter and the IN terminal of the cable box.

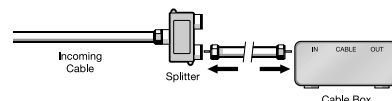

- 3 Connect a coaxial cable between the ANTENNA OUT terminal of the cable box and the B-IN terminal of the A/B switch.

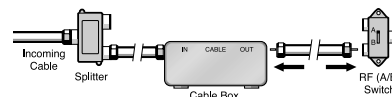

- 4 Connect a coaxial cable between the ANTENNA OUT terminal of the cable box and the B-IN terminal of the A/B switch.

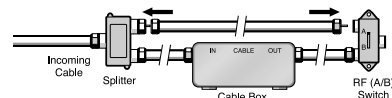

- 5 Connect the last coaxial cable between the OUT terminal of the RF (A/B) switch and the VHF/UHF terminal on the PDP.

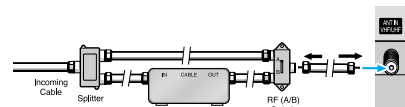

After you've made this connection, set the A/B switch to the "A" position for normal viewing. Set the A/B switch to the "B" position to view scrambled channels. (When you set the A/B switch to "B", you will need to tune your Set-Top Box to the cable box's output channel, which is usually channel 3 or 4.)

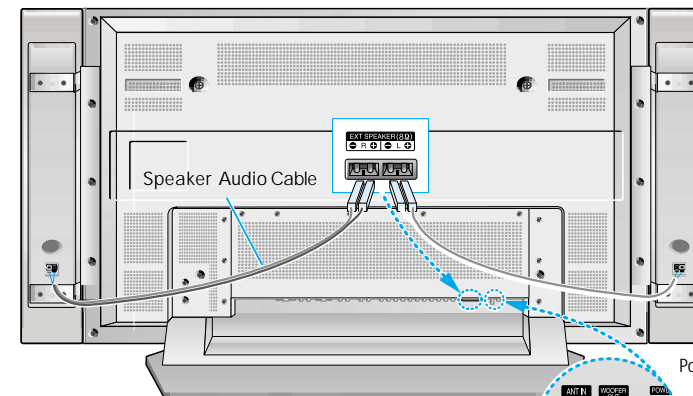

- * External speakers MUST have a power handling capability of 10 watts minimum (impedance 8 ohm).

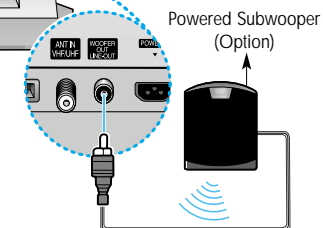

Please use the speaker-built in amplified audio.

How to Connect

Connect the speaker audio cable to the external speaker output jack on the PDP matching the "+" and "-" ends of the cable with the diagram on the PDP.

Connecting PDP and Speakers

- 1 Fix the bracket onto the guide pole located on the rear of speaker and fasten the screws.
- 2 After removing the three screws on the PDP, clamp the speaker and the PDP together and fasten the screws.

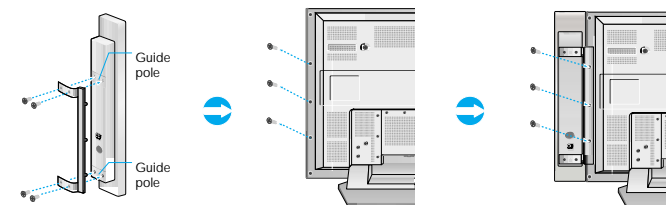



Connecting a VCR

Connecting a VCR to the Video or S-Video/Audio jack

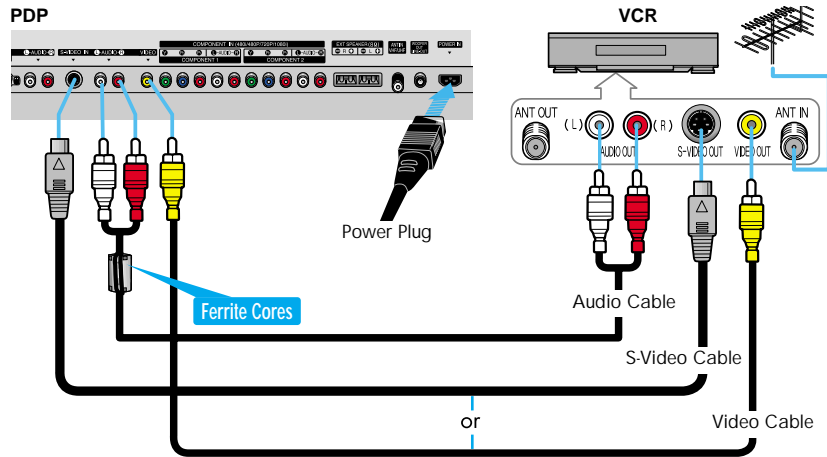

How to Connect

Connect the Video/Audio cables between the AUDIO(L/R)/VIDEO jacks on the PDP and AUDIO/VIDEO OUT jacks on the VCR. (Note: For better video, you can use an S-Video cable.)

Videotape Playback:

1. Turn on your PDP, and press the TV/VIDEO button on the remote control.
2. Press the UP or DOWN button to select "Video" or "S-Video", then press the ENTER button.
3. Turn on your VCR, insert a videotape and press the play button.

Ferrite Cores

The ferrite cores are used to attenuate undesired signals. When connecting the audio cable (PC, DVI, S-Video, Video), attach one of these ferrite cores to the cable near the connector.

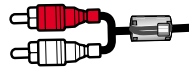

When you connect the audio cable (PC, DVI, S-Video, Video, Component1, Component2) to the connectors, bind the ferrite core around the cable to secure it.



Connecting a Camcorder

Viewing camcorder tapes

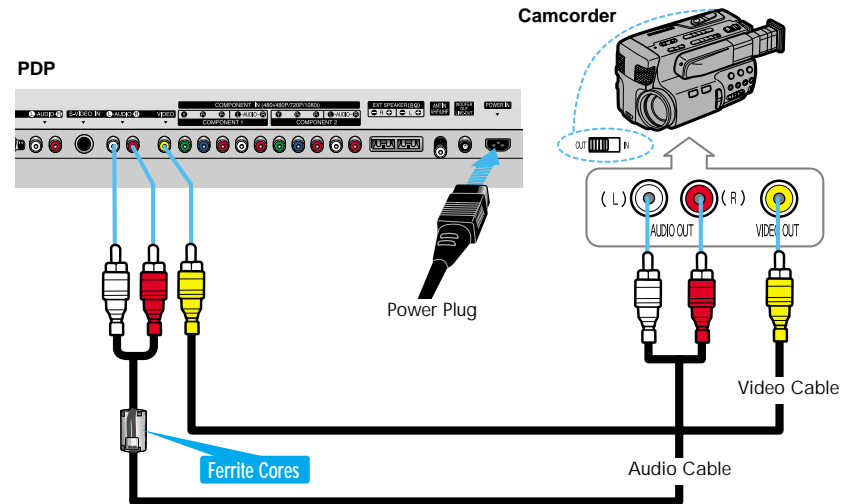

How to Connect

Connect a Video/Audio cable between the AUDIO(L/R)/VIDEO jacks on the PDP and the VIDEO/AUDIO OUTPUT jacks on the camcorder.

Viewing Tapes

1. Turn on your PDP, and press the TV/VIDEO button on the remote control.
2. Press the UP or DOWN button to select the "Video", then press the ENTER button.
3. Turn on your camcorder and set it to Video Mode. (For details, refer to your camcorder owner's instructions.)
4. Set the IN/OUT switch on your camcorder to OUT.
5. Insert the tape into the camcorder and press the Play button.



Connecting a DVD Player (480i, 480p)

This PDP displays the optimum picture in 720p mode.

Playing DVD

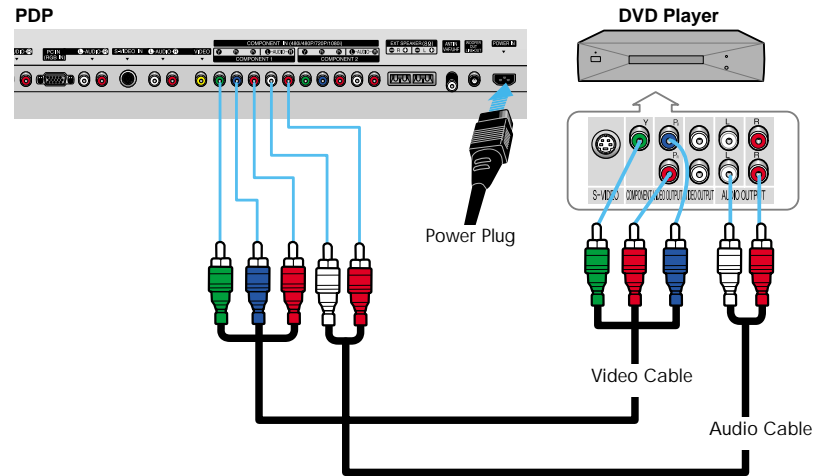

How to Connect

- 1 Connect a Video Cable between the Y, Pb, Pr (COMPONENT1, 2) input jacks on the PDP and Y/P_b/P_r output jacks on the DVD players.
- 2 Connect a Audio Cable between the AUDIO L/R(COMPONENT1, 2) input jacks on the PDP and the AUDIO OUT jacks on the DVD player.

To Play DVD:

1. Turn on your PDP, and press the TV/VIDEO button on the remote control.
2. Press the UP or DOWN button to select "COMPONENT1" or "COMPONENT2", then press the ENTER button.
3. Turn on your DVD player, insert a DVD disc and press the Play button.
 - For an explanation of Component video, see your DVD owner's instructions.



Connecting a DTV Receiver (480p, 720p, 1080i)

This PDP displays the optimum picture in 720p mode.

Watching DTV

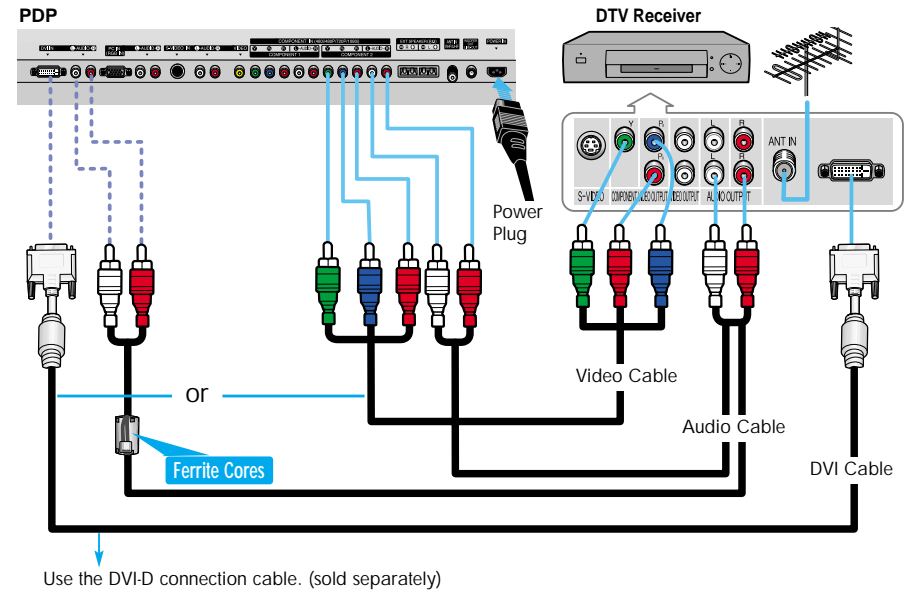

Use the DVI-D connection cable. (sold separately)

How to Connect

- 1 Connect the cable or antenna to the antenna input jack on the DTV.
- 2 Connect a Video cable between the Y, Pb, Pr (COMPONENT 1, 2) or DVI jack on the PDP and the Y, P_b, P_r (VIDEO OUTPUT JACKS) on the DTV receiver.
- 3 Connect an Audio cable between the COMPONENT 1, 2 (L/R AUDIO) or DVI jacks on the PDP and the AUDIO OUTPUT jacks on the DTV.

To Watch DTV:

1. Turn on your PDP, and press the TV/VIDEO button on the remote control.
2. Press the UP or DOWN button to select "COMPONENT1", "COMPONENT2" or "DVI", then press the ENTER button.
3. Turn on your DTV receiver.
 - For an explanation of Component video, see your DTV receiver owner's instructions.

SAMSUNG

P L A S M A D I S P L A Y P A N E L

Operation



Turning the PDP On and Off	30
Memorizing the Channels.....	32
Setting Up Your Remote Control	37



Turning the PDP On and Off

Turning the PDP On and Off

Press the Power button on the remote control. The PDP will be turned on and you will be ready to use its features. You can also use the POWER(I/O) button on the front of the PDP.

Notes:

- If your PDP isn't turned on when the power button is pressed: Press the [MODE] button to check if the TV mode has been chosen ().

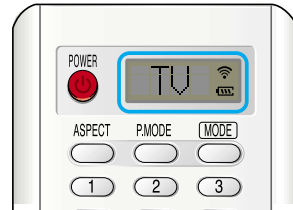

Displaying Status Information

Press the INFO button on the remote control. The PDP will display the Picture mode, Sound mode, MTS, Signal and Caption. Press the INFO button on the remote control again. The PDP will display the Clock.

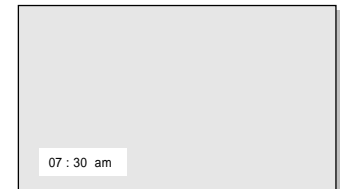
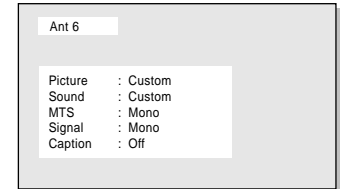

Viewing the Menus and Displays

Your PDP has a simple, easy-to-use menu system that appears on the PDP screen. This system makes it convenient and fast to use features on the PDP. Your PDP also lets you display the status of many of your PDP's features.

Viewing the Menus

- 1 With the power on, press the MENU button on the remote control. The main menu appears on the screen. The Picture menu is selected.

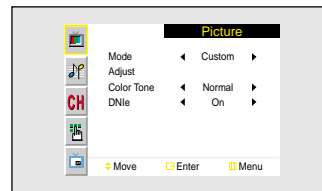

- 2 Press the UP/DOWN buttons to move items in the menu. Press the LEFT/RIGHT buttons to display, change, or use the selected items. Press the ENTER () button to enter items in the menu. On screen menus disappear from the screen automatically after about thirty seconds, or you can press the EXIT button on your remote control to exit the menu.

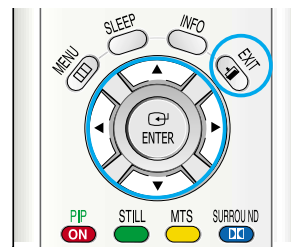



Memorizing the Channels

Your PDP can memorize and store all of the available channels for both “off-air” (antenna) and cable channels. After the available channels are memorized, use the CH ^ and CH v buttons to scan through the channels. This eliminates the need to change channels by entering the channel digits. There are three steps for memorizing channels: selecting a broadcast source, memorizing the channels (automatic) and adding and deleting channels (manual).

Selecting the Video Signal-source

Before your television can begin memorizing the available channels, you must specify the type of signal source that is connected to the PDP (i.e., an antenna or a cable system).

- 1 Press the MENU button. Press the UP or DOWN button to select “Channel”, then press the ENTER button.

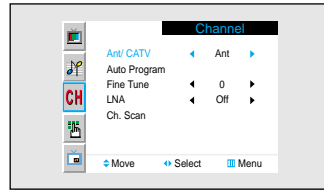

- 2 Press the LEFT or RIGHT button to select “Ant”, “STD”, “HRC” or “IRC”.
 - If you are connected to an antenna, leave "Ant" displayed. If you connected cable, press the LEFT or RIGHT button to the display the type of cable system: "STD", "HRC", or "IRC". (If you are not sure which type of cable system you have, contact your cable company).

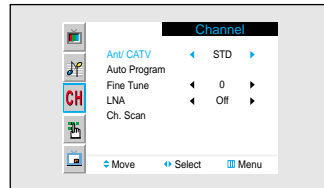

- 3 Press the MENU button to exit.

Note

- STD, HRC and IRC identify various types of cable TV systems. Contact your local cable company to identify the type of cable system that exists in your particular area. At this point the signal source has been selected. Proceed to “Storing Channels in Memory” (next page).

Storing Channels in Memory (Automatic Method)

- 1 First, select the correct signal source (Ant, STD, HRC, IRC). See steps on previous page. Press the MENU button. Press the UP or DOWN button to select “Channel”, then press the ENTER button.

▶ Quick way to access the Automatic Channel Setting : Just press the “AUTO PROG.” button on the remote control.

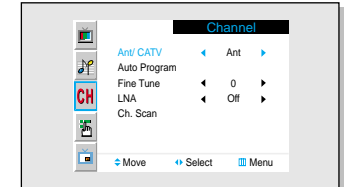

- 2 Press the UP or DOWN button to select “Auto Program”, then press the ENTER button.

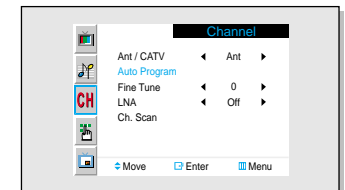

- 3 The PDP will begin memorizing all of the available channels. After all the available channels are stored, the Auto program menu reappears. Press the RIGHT button to stop.

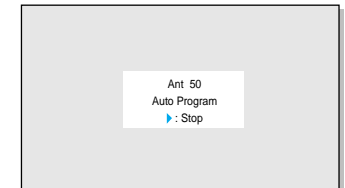

Note

- The PDP automatically cycles through all of the available channels and stores them in memory. This takes about one to two minutes.

Adding and Erasing Channels (Manual Method)

1 Use the number buttons to directly select the channel that will be added or erased.

Ex) Channel "4"

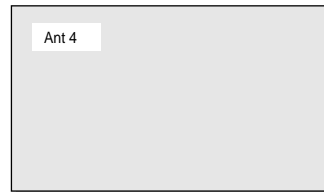

2 Press the ADD/DEL button: Repeatedly pressing this button will alternate between "Added" and "Erased."

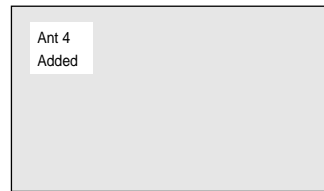
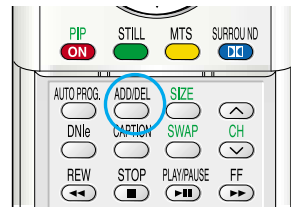

Note

- You can view any channel (including an erased channel) by using the number buttons on the remote control.

To View Memorized Channel (PIP Mode)

1 Press the MENU button. Press the UP or DOWN button to select "Channel", then press the ENTER button.

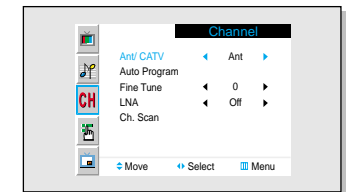

2 Press the UP or DOWN button to select "Ch Scan", then press the ENTER button. Only the memorized channels are chosen. Press the RIGHT button to stop.

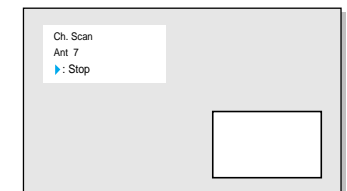
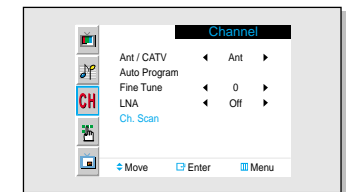



Changing Channels

Using the Channel Buttons

Press the CH \wedge or CH \vee buttons to change channels.

When you press the CH \wedge or CH \vee buttons, the PDP changes channels in sequence. You will see all the channels that the PDP has memorized. (The PDP must have memorized at least three channels.) You will not see channels that were either erased or not memorized.

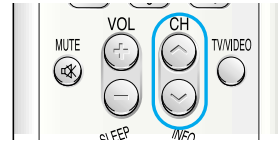

Directly Accessing Channels

Press the number buttons to go directly to a channel. For example, to select channel 27, press "2" then "7". The TV will change channels when you press the second number.

When you use the number buttons, you can directly select channels that were either erased or not memorized. To change to single-digit channels (0-9) faster, press "0" before the single digit. (For channel "4" press "0", then "4".)

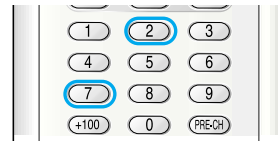

Using the Pre-CH button to select the previous channel

Press the PRE-CH button. The TV will switch to the last channel viewed.

To quickly switch between two channels that are far apart, tune to one channel, then use the number button to select the second channel. Then, use the PRE-CH button to quickly alternate between them.



Adjusting the Volume

Using the Volume Buttons

Press the VOL + or VOL - buttons to increase or decrease the volume.

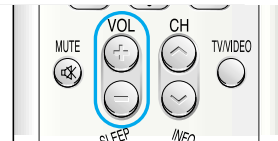

Using Mute

Using the MUTE Buttons

At any time, you can temporarily cut off the sound using the MUTE button.

1 Press the MUTE button and the sound cuts off. The word "Mute" will appear in the lower-left corner of the screen.

2 To turn mute off, press the MUTE button again, or simply press the VOL + or VOL - button.



This PDP's remote control can operate almost any VCR, cable box or DVD. After it has been set up properly, your remote control can operate in four different modes :TV, VCR, Cable or DVD. Pressing the corresponding button on the remote control allows you to switch between these modes, and control whichever piece of equipment you choose.

- Note :**
- The remote control may not be compatible with all DVD Players, VCRs, Cable boxes.
 - The remote control can operate only on STB made by Samsung.

Setting Up the Remote to Operate Your VCR, Cable box or DVD player

1 Turn off your VCR. (or Cable box, DVD player)

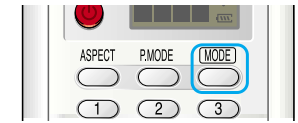

2 Press the MODE button. Mode is changed whenever MODE button is pressed(New mode is displayed on LED screen).



3 Press the SET button on your TV's remote control.



4 Using the number buttons on your remote control, enter three digits of the VCR (or Cable box, DVD player) code listed on page 38 of this manual for your brand of VCR (or CATV, DVD). Make sure you enter three digits of the code, even if the first digit is a "0". (If more than one code is listed, try the first one.)

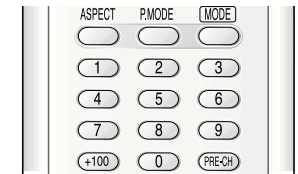

5 Press the Power button on the remote control. Your VCR (or CATV, DVD) should turn on if your remote is set up correctly. If your VCR (or CATV, DVD) does not turn on after setup, repeat steps 2, 3, and 4, but try one of the other codes listed for your brand of VCR (or CATV, DVD). If no other codes are listed, try each code, 000 through 089 (or Cable box: 000 through 077, DVD player: 000 through 008).

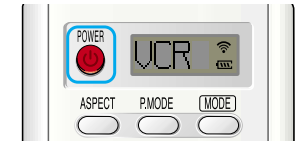

Notes

- When your remote control is in "VCR" mode, the VCR control buttons (Stop, REW, Play/Pause, FF) still operate your VCR.
- When your remote control is in "CATV" or "DVD" mode, the VCR control buttons (Stop, REW, Play/Pause, FF) still operate your VCR.

Remote Control Codes

VCR Codes

Brand	Codes	Brand	Codes	Brand	Codes
Admiral	020	JVC	007 008 018 021 026 037	RCA	
Aiwa	025	Kenwood	007 008 018 026 037		017 019 002 021 035 041 043 057 068
Akai	027 004 032	KLH	070	Samsung	000 001 002 003 004 005
Audio Dynamics	007 026	Lloyd	025	Sansui	026
Bell&Howell	018	Logik	038	Sanyo	018 024
Broksonic	022	LXI 025		Scott	003 047 052 067
Candle	002 006 003 015 008 055	Magnavox	021 036 056 059	Sears	018 019 006 024 028 029 041
Canon	021 056	Marantz	008 007 018 021 026 036		048 051
Citizen	002 003 006 008 015 055		037 062	Sharp	020 034 045 015
Colortyme	007	Marta	006	Shimom	027 033 038 058
Craig	002 024	MEI	021	Signature	025
CurtisMathes	002 017 007 008	Memorex	006 021 024 025	Sony	027 033 044
	021 025 056 064 066	MGA	034	Sylvania	021 025 036 056 059
Daewoo	003 015 010 011 012 013	Midland	005	Symphonic	025
	014 016	Minolta	019 041	Tandy	018 025
DBX	007 026	Mitsubishi	019 034 041 046	Tashika	006
Dimensia	017	Montgomery Ward	020	Tatung	037
Dynatech	034	MTC	002 025	Teac	025 037 068
Ernerson	001 003 006 021 022 025	Multitech	002 025 038 005	Technics	021
	030 032 034 040 047 050	NEC	018 007 026 037 008 062 064	Teknika	021 006 025 031
	052 060 063 065 066 067	Optimus	020	TMK	066
	069	Panasonic	021 056 071 072	Toshiba	003 019 029 051 052
Fisher	018 024 028 029 048 051 061	Pentax	019 041	Totevision	002 006
Funai	025	Pentex Research	008	Unitech	002
GeneralElectric	017 002 021	Philco	021 036 056 059	VectorResearch	007 026
	005 056	Philips	021 036	Victor	026
Go Video	002	Pioneer	019 026 039 053	Video Concepts	007 026
Goldstar	006 007 008 009 010	Portland	015 049 055	Videosonic	002
Harman Kardon	007	ProScan	017	Wards	002 003 006 019 020 021
Hitachi	019 025 041 042	Quartz	018		024 025 034 038 041
InstantReplay	021	Quasar	021 056	Yamaha	007 008 018 026 037
JC Renney	002 007 018 019 021	Radio Shack/Realistic		Zenith	023 027 033 073
	026 037 041 054 056	006 018 020 021 024 025 029 034 048 056			

Cable Box Codes

Brand	Codes	Brand	Codes	Brand	Codes
Anvission	017 018	Philips	019 021 023 028	Sprucer	022
GI	041	Pioneer	018 020 004 044	Stargate	2000 036
Hamlin	003 024 031	RCA	014 022 040	Sylvania	016
Hitachi	025 030	Regal	003	Texscan	016
Jerrold	038 039	Regency	015 023	Tocom	032
Macom	025,030	SA	042 043	Universal	033 034
magnavox	019 023 028	Samsung	000 001 002 003 004 005	Viewstar	019 021 023 028
Oak	026		006 007	Wameramex	046
Panasonic	003 022 027 037 044	ScientificAtlanta	042 043	Zenith	017 029 035 037 045

DVD Codes

Brand	Codes
Samsung	000 001
JVC	002
ProScan,RCA	003
Panasonic	005
LG	006
Sony	007
DENON	008
CurtisMathes	009

S
M
M
S
U
N
G

P L A S M A D I S P L A Y P A N E L



Picture Control

Customizing the Picture	40
Using Automatic Picture Settings	41
Selecting the Color Tone	42
DNle (Digital Natural Image engine)	43
Viewing the Picture-in-Picture	44
Changing the Screen Size	50
Freezing the Picture	51



Customizing the Picture

You can use the on-screen menus to change the Contrast, Brightness, Sharpness, Color, and Tint settings of your PDP.

1 Press the MENU button, then press the ENTER button.

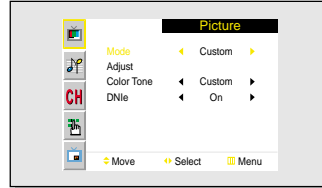

2 Press the UP or DOWN button to select "Adjust", then press the ENTER button. You will also see the items "Contrast", "Brightness", "Sharpness", "Color" and "Tint".

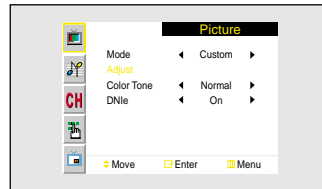

3 Press the UP or DOWN button to select the item you wish to change.

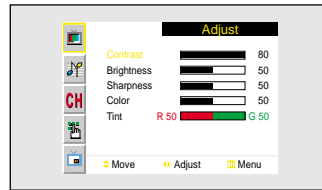

4 Press the LEFT or RIGHT button to change the value of the item.

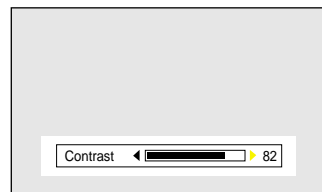

5 Press the MENU button to exit.

Note

- In the PC/DVI mode, you can't adjust the Color and Tint.



Using Automatic Picture Settings

Your PDP has automatic picture settings that allow you to adjust the video display easily.

1 Press the MENU button, then press the ENTER button.

▶ Quick way to access the picture setting: Just press the "P.MODE" button under the cover of the remote control.

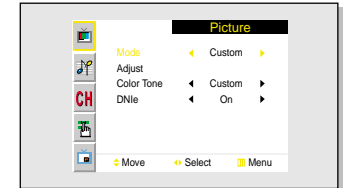

2 Press the LEFT or RIGHT button to select "Custom", "Dynamic", "Standard" or "Movie" picture setting. You can select "High", "Middle", "Low" or "Custom" in PC/DVI mode.

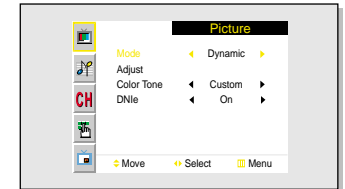

3 Press the MENU button to exit.



Selecting the Color Tone

1 Press the MENU button, then press the ENTER button.

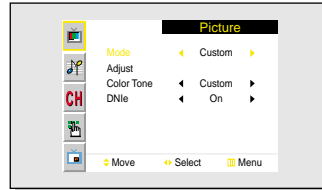

2 Press the UP or DOWN button to select "Color Tone", then press the LEFT or RIGHT button to select "Normal", "Warm1", "Warm2", "Cool2" or "Cool1".

- You can select "Custom", "Color1", "Color2" or "Color3" in PC mode.
- You can select "Color1", "Color2" or "Color3" in DVI mode.

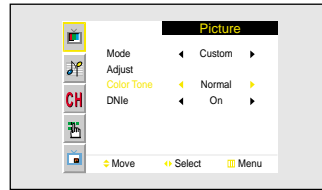

3 Press the MENU button to exit.



DNle (Digital Natural Image engine)

Samsung's New Technology brings you more detailed images with contrast and white enhancement and 3D noise reduction.

1 Press the MENU button, then press the ENTER button.

➤ Quick way to select DNle : Simply press the "DNle" button under the cover of the remote control.

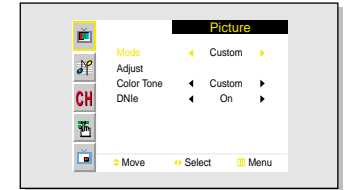

2 Press the UP or DOWN button to select "DNle", then press the LEFT or RIGHT button to select "On", "Off" or "Demo".

- On : Switches on the DNle mode.
- Demo : The screen before applying DNle appears on the right and the screen after applying DNle appears on the left.
- Off : Switches off the DNle mode.

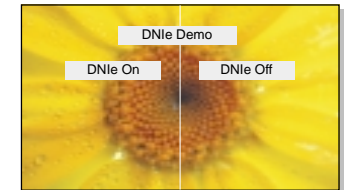
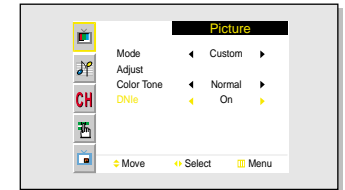

3 Press the MENU button to exit.



Viewing the Picture-in-Picture

Selecting the PIP Screen

1 Press the MENU button. Press the UP or DOWN button to select "PIP", then press the ENTER button.

▶ Quick way to access the PIP mode: Just press the "PIP" button on the remote control.

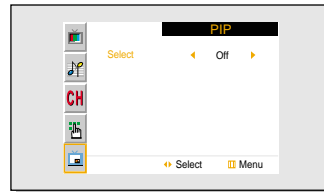

2 Press the LEFT or RIGHT button to select "On". The PIP image will appear in the corner of the screen.
 • Pressing the LEFT or RIGHT button will alternate between "On" and "Off."

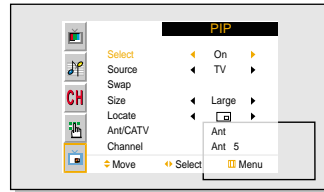

3 Press the MENU button to exit.

PIP Settings

○ : PIP and Swap Operate
 X : PIP doesn't Operate

Main screen \ PIP screen	TV	Video	S-Video	Component 1	Component 2	PC	DVI
TV	○	○	○	○	○	○	○
Video	○	X	○	○	○	○	○
S-Video	○	○	X	○	○	○	○
Component 1	○	○	○	X	X	X	X
Component 2	○	○	○	X	X	X	X
PC	○	○	○	X	X	X	X
DVI	○	○	○	X	X	X	X

Selecting an External Signal

You can use PIP to view a signal from an external source, such as a VCR.

1 Press the MENU button. Press the UP or DOWN button to select "PIP", then press the ENTER button.

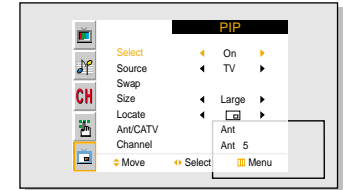

2 Press the UP or DOWN button to select "Source".

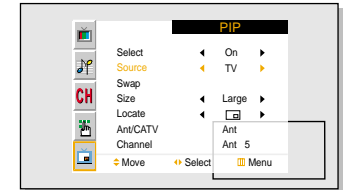

3 Press the LEFT or RIGHT button to cycle through all of the available signal sources: "TV", "Video", "S-Video", "Component 1", "Component 2", "PC" and "DVI".

The signal from these inputs will not appear if you have not connected any equipment to the PDP's respective input jacks.

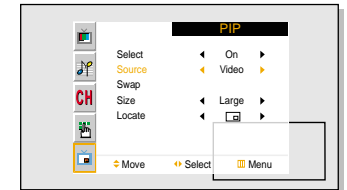

4 Press the MENU button to exit.

Note

- The PIP function operates in Wide screen.
- Using Multi-Screen in the Normal, Zoom1 or Zoom2 screen will change the size of the main screen to Wide screen.

Swapping the Contents of the PIP Image and Main Image

1 Press the MENU button. Press the UP or DOWN button to select "PIP", then press the ENTER button.

➤ Quick way to access swapping: Just press the "SWAP" button under the cover of the remote control.

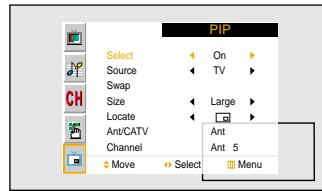

2 Press the UP or DOWN button to select "Swap", then press the ENTER button.
 • The image in the PIP window will appear on the main screen, and vice versa.

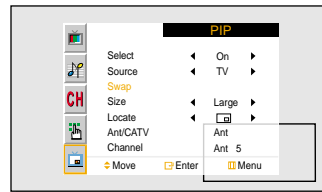

3 Press the MENU button to exit.

Changing the Size of the PIP Window

1 Press the MENU button. Press the UP or DOWN button to select "PIP", then press the ENTER button.

➤ Quick way to access the PIP size: Just press the "SIZE" button under the cover of the remote control.

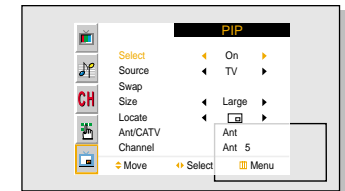

2 Press the UP or DOWN button to select "Size".

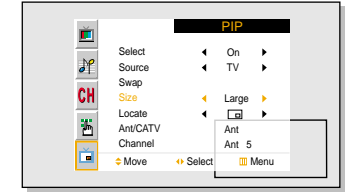

3 Press the LEFT or RIGHT button to select "Small", "Double" or "Large".

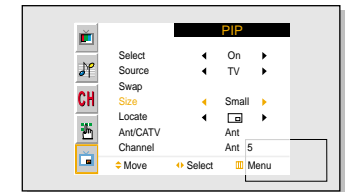

4 Press the MENU button to exit.

Changing the Location of the PIP Image

1 Press the MENU button. Press the UP or DOWN button to select "PIP", then press the ENTER button.

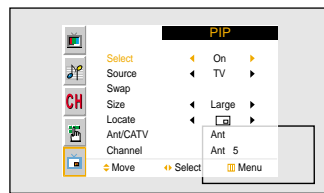

2 Press the UP or DOWN button to select "Locate".

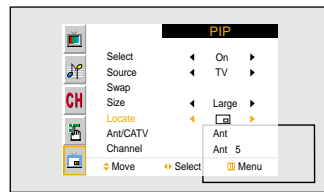

3 Press the LEFT or RIGHT button to move the PIP screen where you want.

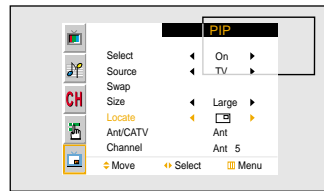

4 Press the MENU button to exit.

Changing the PIP Channel

1 Press the MENU button. Press the UP or DOWN button to select "PIP", then press the ENTER button.

▶ Quick way to change the PIP channel: Just press the "CH▲" or "CH▼" button under the cover of the remote control.

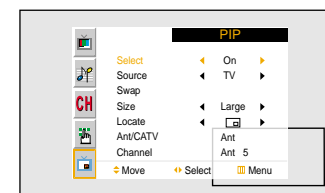

2 Press the UP or DOWN button to select "Ant/CATV". Press the LEFT or RIGHT button to select "Ant", "STD", "HRD" or "IRC".

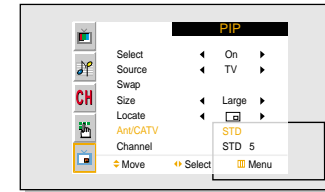

3 Press the UP or DOWN button to select "Channel". Press the LEFT or RIGHT button to change the channel that appears in the PIP window.

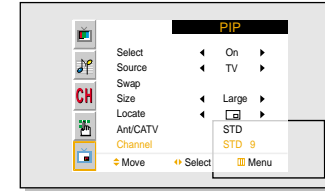

4 Press the MENU button to exit.



Changing the Screen Size

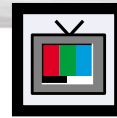

Changing the Screen Size

When you press the ASPECT button on the remote control, the PDP's screen mode should appear in sequence. The screen displays in this order: Wide, Panorama, Zoom1, Zoom2, Normal.

Note

- If you watch a still image or the Normal (4:3) mode for a long time (over 2 hours), an image may be burned onto the screen. View the monitor in Wide or Panorama mode as much as possible.

Wide

Sets the picture to 16:9 wide mode.

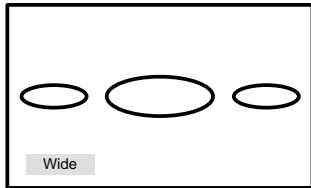

Zoom2

The screen size when the Zoom1 screen is vertically enlarged.

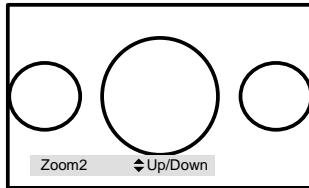

Panorama

Converts regular 4:3 aspect ratio screen to wide screen.

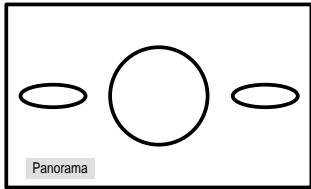

Normal (4:3)

Sets the picture to 4:3 normal mode.

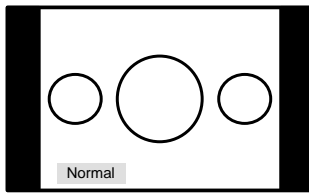

Zoom1

The screen size when Wide screen is vertically enlarged.

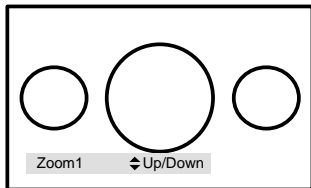

Notes

- In TV, VIDEO, S-VIDEO and Component(480i) modes, all screen modes can be selected. (Wide → Panorama → Zoom1 → Zoom2 → Normal).
- In PC/DVI mode, only Wide & Normal modes can be selected.
- In Component(480p, 720p, 1080i) modes, Panorama mode can't be selected.
- In Component(480p, 720p, 1080i) modes, you can move the picture on screen by pressing the Up▲ or Down▼ button. (All screen modes)
- Changing the screen size to Normal, Zoom1 or Zoom2 during PIP mode will cause the PIP window to disappear.

Still

Press the Still button on the remote control to freeze a moving picture. Press again to cancel.

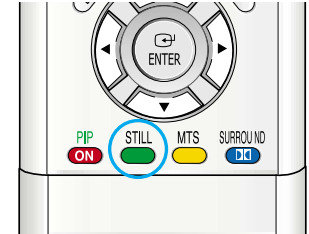

Sound Control



Customizing the Sound	54
Using Automatic Sound Settings	55
Choosing a Multi-Channel Sound (MTS) Soundtrack	56
Using the Auto Volume	57
Using Dolby Virtual	58
Using a Subwoofer	59



Customizing the Sound

1 Press the MENU button. Press the UP or DOWN button to select "Sound", then press the ENTER button.

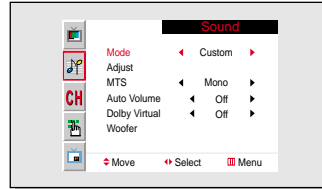

2 Press the UP or DOWN button to select "Adjust", then press the ENTER button. You will also see the items "Bass", "Treble" and "Balance".

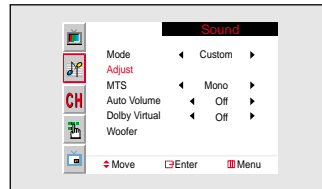

3 Press the UP or DOWN button to select the item you wish to change.

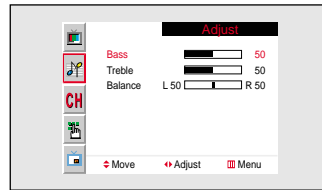

4 Press the LEFT or RIGHT button to change the value of the item.

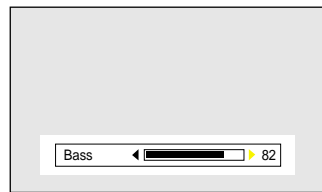

5 Press the MENU button to exit.



Using Automatic Sound Settings

1 Press the MENU button. Press the UP or DOWN button to select "Sound", then press the ENTER button.

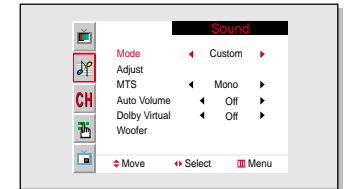

2 Press the LEFT or RIGHT button to select "Adjust", "Standard", "Music", "Movie" or "Speech" sound setting.

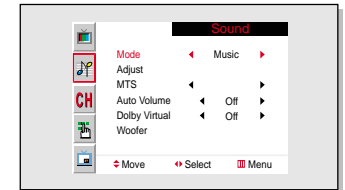

3 Press the MENU button to exit.



Choosing a Multi-Channel Sound (MTS) Soundtrack

Depending on the particular program being broadcast, you can listen to stereo, mono, or a Separate Audio Program. (SAP audio is usually a foreign-language translation. Sometimes SAP has unrelated information like news or weather.)

1 Press the MENU button. Press the UP or DOWN button to select "Sound", then press the ENTER button.

▶ Quick way to access the MTS menu: Just press the "MTS" button on the remote control.

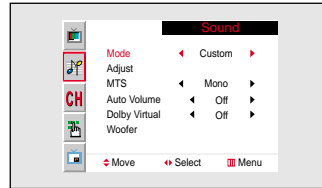

2 Press the UP or DOWN button to select "MTS".

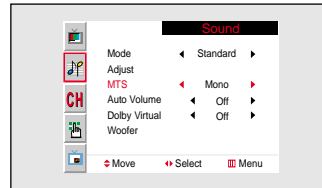

3 Press the LEFT or RIGHT button to select "Mono", "Stereo" or "SAP".

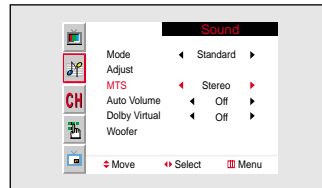

4 Press the MENU button to exit.

- Choose *Stereo* for channels that are broadcasting in stereo.
- Choose *Mono* for channels that are broadcasting in mono, or if you are having difficulty receiving a stereo signal.
- Choose *SAP* to listen to the Separate Audio Program, which is usually a foreign-language translation.

Note

- The MTS function operates in TV mode only.



Using the Auto Volume

Each broadcasting station has its own signal conditions, which can make it necessary to adjust the volume every time the channel is changed. "Auto volume" lets you automatically adjust the volume of the desired channel by lowering the sound output when the modulation signal is high or by raising the sound output when the modulation signal is low.

1 Press the MENU button. Press the UP or DOWN button to select "Sound", then press the ENTER button.

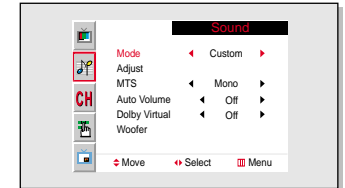

2 Press the UP or DOWN button to select "Auto Volume".

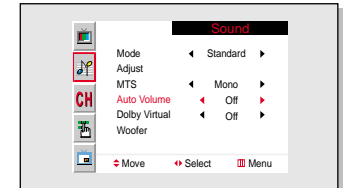

3 Press the LEFT or RIGHT button to select "On".

- Pressing the LEFT or RIGHT button will alternate between "On" and "Off."

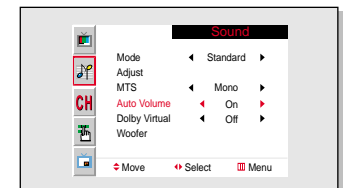

4 Press the MENU button to exit.



Using Dolby Virtual

This feature allows the PDP's optional L/R speakers to provide a Home Theater-like Dolby effect. The center and surround sounds are mixed into the L/R speakers.

1 Press the MENU button. Press the UP or DOWN button to select "Sound", then press the ENTER button.

▶ Quick way to access the Surround: Just press the "SURROUND" button on the remote control.

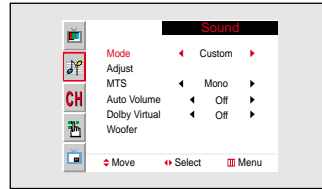

2 Press the UP or DOWN button to select "Dolby Virtual".

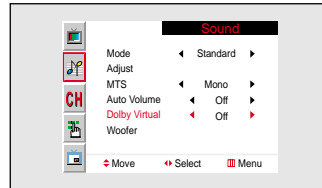

3 Press the LEFT or RIGHT button to select "On".
• Pressing the LEFT or RIGHT button will alternate between "On" and "Off."

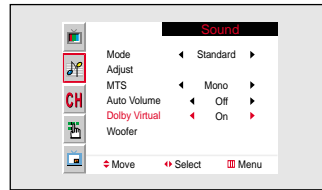

4 Press the MENU button to exit.



Using a Subwoofer

1 Press the MENU button. Press the UP or DOWN button to select "Sound", then press the ENTER button.

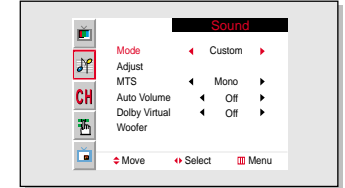

2 Press the UP or DOWN button to select "Woofer", then press the ENTER button.

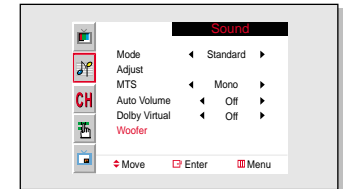

3 Press the LEFT or RIGHT button to select "On".
• Pressing the LEFT or RIGHT button will alternate between "On" and "Off."

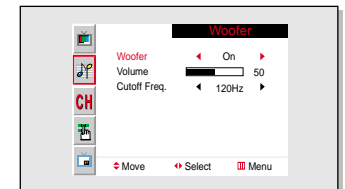

4 Press the UP or DOWN button to select "Volume", then press the LEFT or RIGHT button to adjust the value of the item.
This sets the volume for the subwoofer.

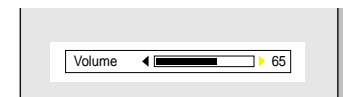
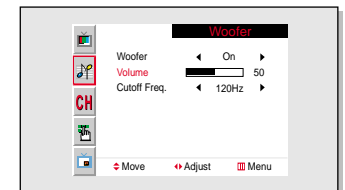

5 Press the UP or DOWN button to select "Cutoff Freq.", then press the LEFT or RIGHT button to adjust the value of the item.
This sets the cutoff frequency for the subwoofer. For example, if you set the cutoff frequency at 130Hz, the subwoofer will reproduce frequencies of 130Hz and lower.

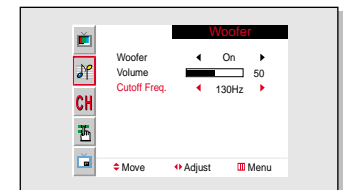

6 Press the MENU button to exit.

SAMSUNG

P L A S M A D I S P L A Y P A N E L

Channel Control



Fine Tuning Channels.....	62
LNA (Low Noise Amplifier).....	63



Fine Tuning Channels

Use fine tuning to manually adjust a particular channel for optimal reception.

- 1 Press the MENU button. Press the UP or DOWN button to select "Channel", then press the ENTER button.

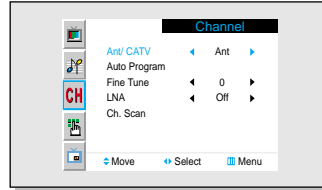

- 2 Press the UP or DOWN button to select "Fine Tune".

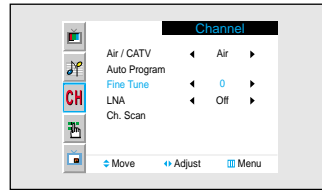

- 3 Press the LEFT or RIGHT button to adjust the fine tuning.

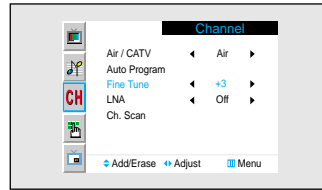

- 4 To store the fine tuning setting in the TV's memory, press the UP button. (A star icon <*> will appear.) To reset the fine tuning to "0", press the DOWN button.

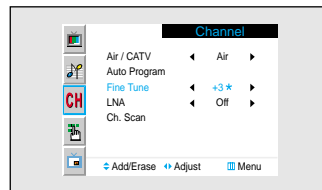

- 5 Press the MENU button to exit.



LNA (Low Noise Amplifier)

If the TV is operating in a weak-signal area, sometimes the LNA function can improve the reception (a low-noise preamplifier boosts the incoming signal).

- 1 Press the MENU button. Press the UP or DOWN button to select "Channel", then press the ENTER button.

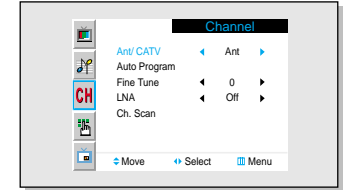

- 2 Press the UP or DOWN button to select "LNA".

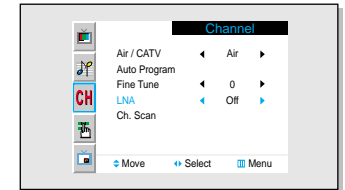

- 3 Press the LEFT or RIGHT button to select "On."
 - Pressing the LEFT or RIGHT button will alternate between "On" and "Off."

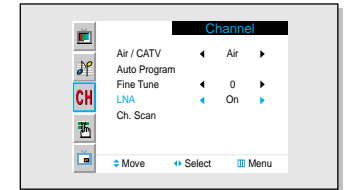

- 4 Press the MENU button to exit.

Connecting a PC and Operation



Connecting to a PC	66
Adjusting the PC Screen.....	70
Changing the Position of the Image.....	71
Changing the Size of the Image	72
Information	73
Picture Quality Adjustment	74



Connecting to a PC

Connection to a Macintosh computer may require in adapter.

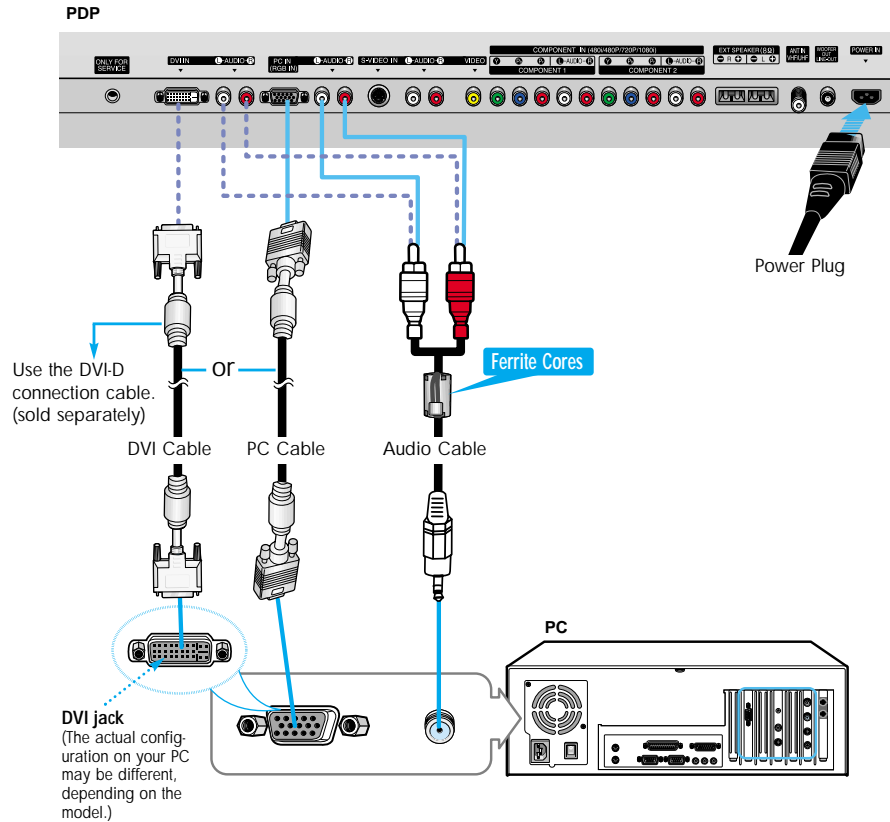

Connecting a PC to the PDP

- 1 Connect a PC (15pin) cable between the PC Output jack (or DVI jack) on the PC and the RGB IN(or DVI IN) Input jack (15p D-SUB) on the PDP.
- 2 Connect a Audio cable between the Audio (RGB or DVI) on the PC and the Audio L/R (RGB or DVI) input jacks on the PDP.

To watch the PC screen:

1. Turn on your PDP, and press the TV/VIDEO button on the remote control.
2. Press the UP or DOWN button to select "PC", then press the ENTER button.
3. Turn on PC and check for PC system requirements. (Refer to pages 66 and 67 for PC system requirements.)
4. Adjust the PC screen. (Refer to pages 70 and 76.)

Pin Configuration

D-Sub Cable

- 15Pin Signal Cable (based on protruded pin)

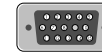

Pin No.	PC IN	PC OUT
1	Red (R)	Red (R)
2	Green (G)	Green (G)
3	Blue (B)	Blue (B)
4	Grounding	Grounding
5	Grounding [DDC]	Grounding [DDC]
6	Red (R) Grounding	Red (R) Grounding
7	Green (G) Grounding	Green (G) Grounding
8	Blue (B) Grounding	Blue (B) Grounding
9	Reserved	Reserved
10	Sync Grounding	Sync Grounding
11	Grounding	Grounding
12	Data [DDC]	Data [DDC]
13	Horizontal sync.	Horizontal sync.
14	Vertical sync.	Vertical sync.
15	Clock [DDC]	Clock [DDC]

DVI-D Cable (Digital-Only Connector)

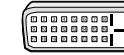

Pin No.	Signal Assignment	Pin No.	Signal Assignment
1	T.M.D.S. Data2-	13	T.M.D.S. Data3+
2	T.M.D.S. Data2+	14	+5V Power
3	T.M.D.S. Data2/4 Shield	15	Ground (for +5V)
4	T.M.D.S. Data4-	16	Hot Plug Detect
5	T.M.D.S. Data4+	17	T.M.D.S. Data0-
6	DDC Clock	18	T.M.D.S. Data0+
7	DDC Data	19	T.M.D.S. Data0/5 Shield
8	No Connect	20	T.M.D.S. Data5-
9	T.M.D.S. Data1-	21	T.M.D.S. Data5+
10	T.M.D.S. Data1+	22	T.M.D.S. Clock Shield
11	T.M.D.S. Data1/3 Shield	23	T.M.D.S. Clock+
12	T.M.D.S. Data3-	24	T.M.D.S. Clock-

Setting up Your PDP (Plug and Play)

Our adoption of the new VESA® Plug and Play solution eliminates complicated and time consuming setup. It allows you to install your monitor in a Plug and Play compatible system, without the usual setup hassles and confusion. Your PC system can easily identify and configure itself for use with your display. This monitor automatically tells the PC system its Extended Display Identification data (EDID) using Display Data Channel (DDC) protocols.

How to Set up Your PC Software (Windows only)

The Windows display-settings for a typical computer are shown below. However, the actual screens on your PC will probably be different, depending upon your particular version of Windows and your particular video card. But even if your actual screens look different, the same, basic set-up information will apply in almost all cases. (If not, contact your computer manufacturer or Samsung Dealer.)

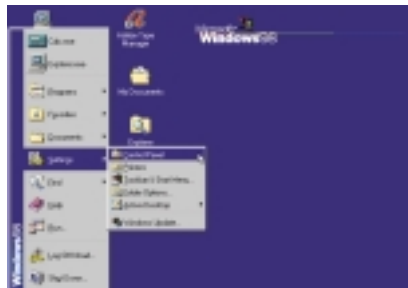

On the windows screen, select in the following sequence : Start → Settings → Control Panel.

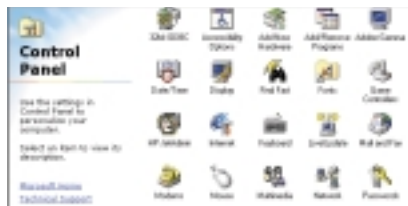

When the control panel screen appears, click on "Display" and a display dialog-box will appear.

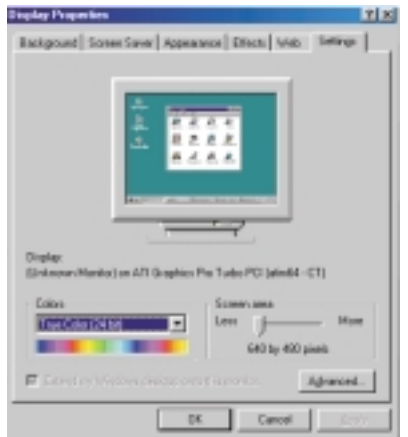

Select the "Settings" tab in the display dialog-box.

The two key variables that apply to the PDP-PC interface are "resolution" and "colors". The correct settings for these two variables are:

- Size (sometimes called "resolution") :640 x 480 pixels.
- Color: "24-bit" color (might also be expressed as "16 million colors") Shown at left is a typical screen for "Display" dialog box.

If a vertical-frequency option exists on your display settings dialog box, the correct value is "60" or "60 Hz." Otherwise, just click "OK" and exit the dialog box.

Continued...

Notes:

Both screen position and size will vary, depending on the type of PC monitor and its resolution. The table below shows all of the display modes that are supported:

Video signal	Dot X Line	Vertical Frequency (Hz)	Horizontal Frequency (KHz)	Vertical polarity	Horizontal polarity	
IBM PC / AT Compatible	640 X 350	70.086	31.469	N	P	
		85.080	37.861	N	P	
	640 X 400	85.080	37.861	P	N	
		720 X 400	70.087	31.469	P	N
	640 X 480	720 X 400	85.039	37.927	P	N
			59.940	31.469	N	N
		800 X 600	72.809	37.861	N	N
			75.000	37.500	N	N
	800 X 600	1024 X 768	85.008	43.269	N	N
			56.250	35.156	N/P	N/P
		60.317	37.879	P	P	
		72.188	48.077	P	P	
		75.000	46.875	P	P	
		85.061	53.674	P	P	
1024 X 768	800 X 600	60.004	48.363	N	N	
		70.069	56.476	N	N	
	1024 X 768	75.029	60.023	P	P	
		84.997	68.677	P	P	

- The interlace mode is not supported.
- The PDP operates abnormally if a non-standard video format is selected.

Notes:

- When this PDP is used as a PC display, 32-bit color is supported.
- Depending on the manufacturer, your PC display screen might appear different. (and depending on your particular version of Windows).
Check your PC instruction book for information about connecting your PC to a PDP.
- If a vertical and horizontal frequency-select mode exists, select 60Hz (vertical) and 31.5kHz (horizontal).
- In some cases, abnormal signals (such as stripes) might appear on the screen when the PC power is turned off (or if the PC is disconnected). If so, press the Source button to enter the VIDEO mode. Also, make sure that the PC is connected.
- Connect only a PC monitor to the monitor output port while viewing the PC screen. (Otherwise, random signals might appear).



Adjusting the PC Screen

Adjusting the R.G.B

Preset:

- Press the TV/VIDEO button, then press the UP or DOWN button to select PC. Press the ENTER button to select PC mode.

1 Press the MENU button, then press the ENTER button.

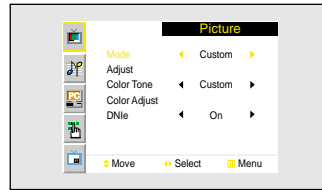

2 Press the UP or DOWN button to select "Color Tone", then Press the LEFT or RIGHT button to select "Custom". When "Custom" is selected, the word "Color Adjust" will appear on the screen.

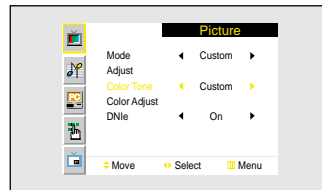

3 Press the UP or DOWN button to select "Color Adjust", then press the ENTER button.

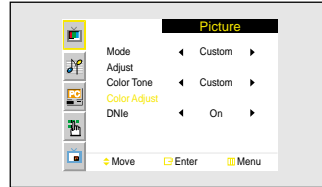

4 Press the UP or DOWN button to select the item you want to change, then press the RIGHT or LEFT button to change the value of the item, using the on-screen gauge as your guide.

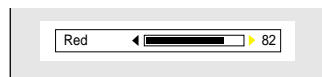
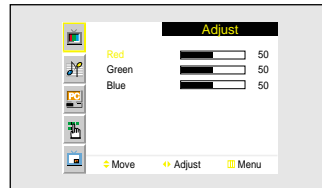

5 Press the MENU button to exit.



Changing the Position of the Image

After connecting the PDP to your PC, adjust the position of the screen if it is not well-aligned.

Preset:

- Press the TV/VIDEO button, then press the UP or DOWN button to select PC. Press the ENTER button to select PC mode.

1 Press the MENU button. Press the UP or DOWN button to select "PC", then press the ENTER button.

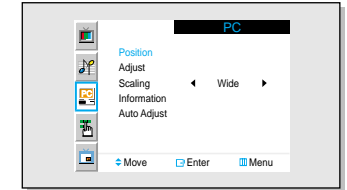

2 Press the MENU button, then adjust the screen position by using the UP/DOWN/LEFT/RIGHT button.

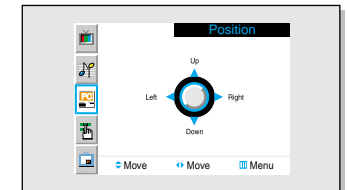

3 Press the MENU button to exit.



Changing the Size of the Image

Preset:

- Press the TV/VIDEO button, then press the UP or DOWN button to select PC. Press the ENTER button to select PC mode.

- 1 Press the MENU button. Press the UP or DOWN button to select "PC", then press the ENTER button.

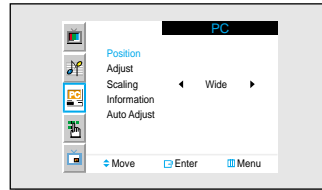

- 2 Press the UP or DOWN button to select "Scaling".

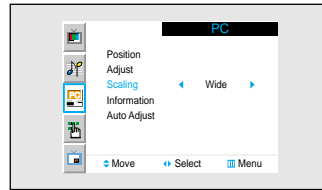

- 3 Press the LEFT or RIGHT button to select "Wide" or "Normal".

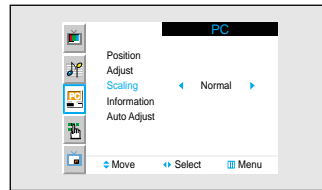

- 4 Press the MENU button to exit.



Information

Preset:

- Press the TV/VIDEO button, then press the UP or DOWN button to select PC. Press the ENTER button to select PC mode.

- 1 Press the MENU button. Press the UP or DOWN button to select "PC", then press the ENTER button.

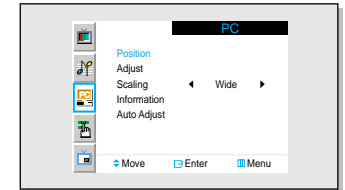

- 2 Press the UP or DOWN button to select "Information", then press the ENTER button. The vertical, horizontal frequencies and resolution appear.

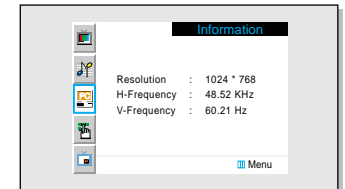
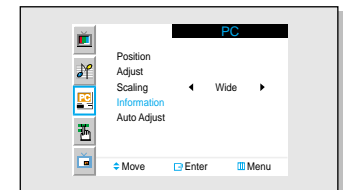

- 3 Press the MENU button to exit.



Picture Quality Adjustment

Picture Automatic Adjustment

Preset:

- Press the TV/VIDEO button, then press the UP or DOWN button to select PC. Press the ENTER button to select PC mode.

1 Press the MENU button. Press the UP or DOWN button to select "PC", then press the ENTER button.

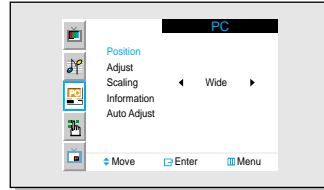

2 Press the UP or DOWN button to select "Auto Adjust", then press the ENTER button.

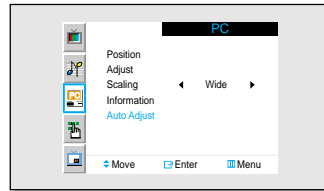

3 The message "Auto Adjust" appears on the screen and the picture adjustments are automatically activated.

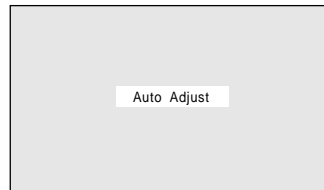

4 Press the MENU button to exit.

Coarse Adjustment

Preset:

- Press the TV/VIDEO button, then press the UP or DOWN button to select PC. Press the ENTER button to select PC mode.

1 Press the MENU button. Press the UP or DOWN button to select "PC", then press the ENTER button.

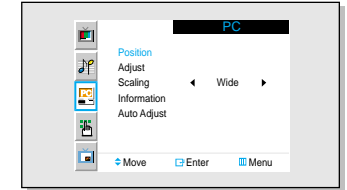

2 Press the UP or DOWN button to select "Adjust", then press the ENTER button.

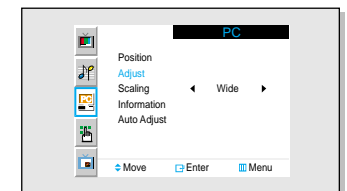

3 Press the UP or DOWN button to select "Coarse". Remove picture noise (vertical stripes) on the screen by pressing the LEFT or RIGHT button. (If Coarse is not set properly, vertical stripes will appear on the screen.)

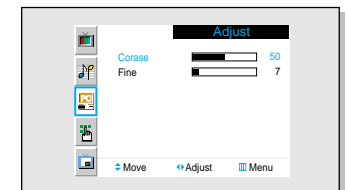

4 Press the MENU button to exit.

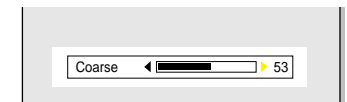

Fine Tuning (Fine)

Preset:

- Press the TV/VIDEO button, then press the UP or DOWN button to select PC. Press the ENTER button to select PC mode.

- 1 Press the MENU button. Press the UP or DOWN button to select "PC", then press the ENTER button.

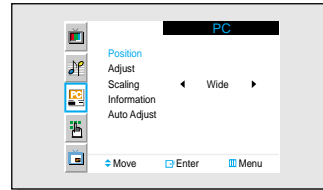

- 2 Press the UP or DOWN button to select "Adjust", then press the ENTER button.

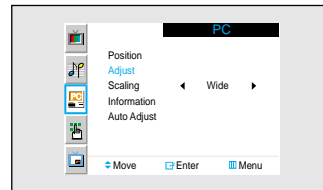

- 3 Press the UP or DOWN button to select "Fine". Remove picture noise on the screen by pressing the LEFT or RIGHT button. (If Fine is not set properly, noise will appear on the screen.)

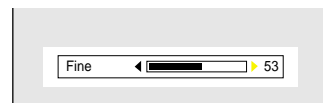
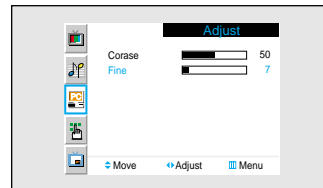

- 4 Press the MENU button to exit.

S
M
W
S
U
N
G

P L A S M A D I S P L A Y P A N E L

Time Setting



Setting the Clock	78
Setting the Sleep Timer	79
Setting the Timers	80
Setting the Preferred Channel and Volume Level	82



Setting the Clock

1 Press the MENU button. Press the UP or DOWN button to select "Function", then press the ENTER button.

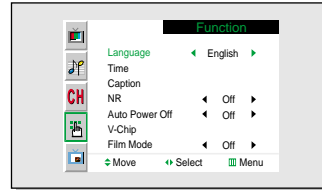

2 Press the UP or DOWN button to select "Time", then press the ENTER button.

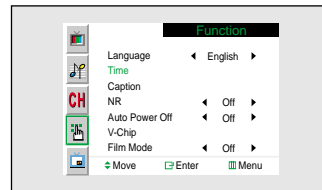

3 Press the LEFT or RIGHT button to select hour, then press the UP or DOWN button to select the correct hour.

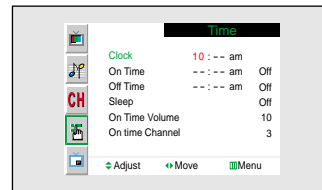

4 Press the LEFT or RIGHT button to select minute, then press the UP or DOWN button to select the correct minute.

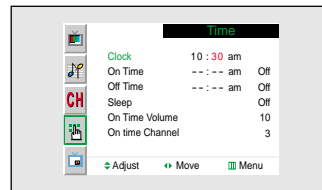

5 Press the MENU button to exit.

Note

- Time setting will be reset when you pull out the Power cord if the PDP is ON.
(If you want to keep the time setting, turn the PDP off using the POWER button on the remote control or the Front Panel.)



Setting the Sleep Timer

You can set your PDP to automatically turn off after a preset interval.

1 Press the MENU button. Press the UP or DOWN button to select "Function", then press the ENTER button.

▶ Quick way to access the sleep timer: Just press the "SLEEP" button on the remote control.

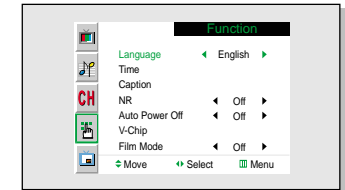

2 Press the UP or DOWN button to select "Time", then press the ENTER button.

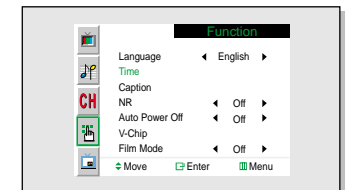

3 Press the UP or DOWN button to select "Sleep".

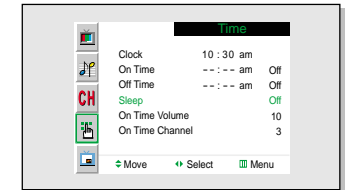

4 Press the LEFT or RIGHT button to select the time interval for the PDP to stay on. The interval ranges from 10 to 180 minutes.

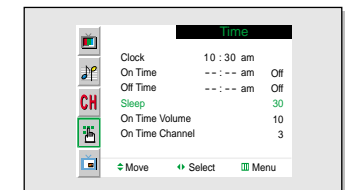

5 Press the MENU button to exit.



Setting the Timers

This PDP can be set to turn on or off automatically at specific times that you choose. Before using the timers, you must set the PDP's clock, as described previously.

Setting the On/Off Timer

- 1 Press the MENU button. Press the UP or DOWN button to select "Function", then press the ENTER button.
- 2 Press the UP or DOWN button to select "Time", then press the ENTER button.
- 3 Press the UP or DOWN button to select "On Time".
- 4 Press the LEFT or RIGHT button to select hour, then press the UP or DOWN button to select the correct hour.
- 5 Press the LEFT or RIGHT button to select minute, then press the UP or DOWN button to select the correct minute.

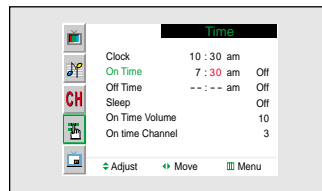
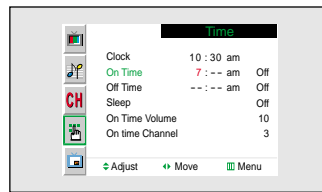
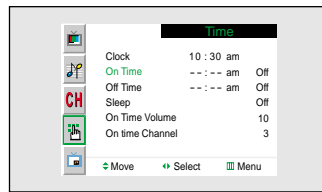
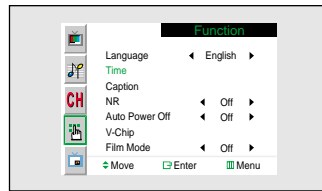
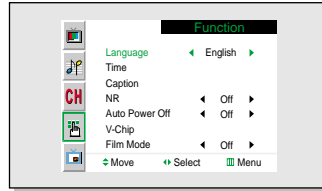

- 6 Press the LEFT or RIGHT button to select "Off" or "On", then press the UP or DOWN button to select "Off" or "On".
- 7 If you want to set Off Time, press the UP or DOWN button to select the "Off Time". Set the "Off Time" just as you set "On Time".

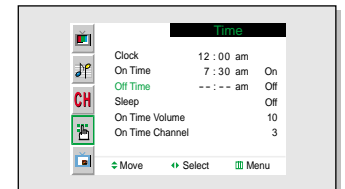
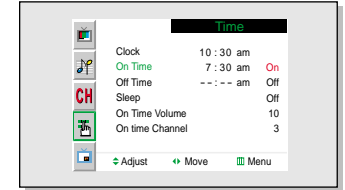

- 8 Press the MENU button to exit.

Note

- If you set to On Time or Off Time, the Power Indicator on the Front Panel is changed to Green.



Setting the Preferred Channel and Volume Level

The preferred channel and volume can be set for when the timer automatically turns on the TV.

1 Press the MENU button. Press the UP or DOWN button to select "Function", then press the ENTER button.

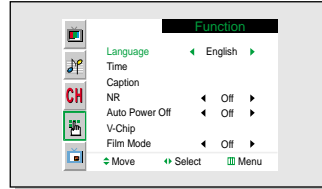

2 Press the UP or DOWN button to select "Time", then press the ENTER button.

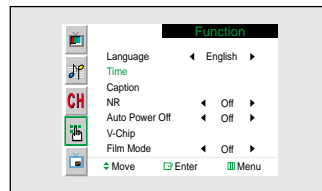

3 Press the UP or DOWN button to select "On Time Volume". Press the LEFT or RIGHT button to adjust volume level.

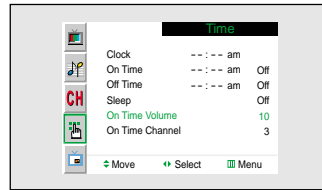

4 Press the UP or DOWN button to select "On Time Channel". Press the LEFT or RIGHT button to select the channel.

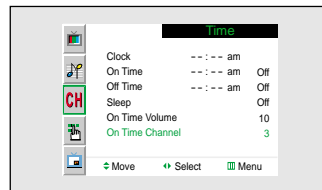

S
M
W
M
S
U
N
G

P L A S M A D I S P L A Y P A N E L

Function Description

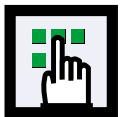

Selecting a Menu Language	84
Viewing Closed Captions	85
Digital Noise Reduction	86
Setting Auto Power Off	87
Using the V-Chip	88
Selecting the Film Mode.....	94



Selecting a Menu Language

1 Press the MENU button. Press the UP or DOWN button to select "Function", then press the ENTER button.

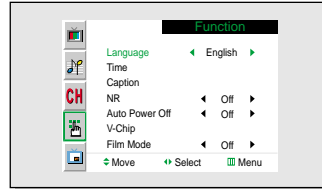

2 Press the LEFT or RIGHT button to select the appropriate language : English, Français or Español.

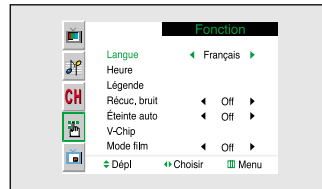

3 Press the MENU button to exit.



Viewing Closed Captions

Your TV decodes and displays the closed captions that are broadcast with certain TV shows. These captions are usually subtitles for the hearing impaired or foreign-language translations. All VCRs record the closed caption signal from television programs, so home-recorded video tapes also provide closed captions. Most pre-recorded commercial video tapes provide closed captions as well. Check for the closed caption symbol in your television schedule and on the tape's packaging: . Note: The Caption feature does not work with DVD or DTV signals.

1 Press the MENU button. Press the UP or DOWN button to select "Function", then press the ENTER button.

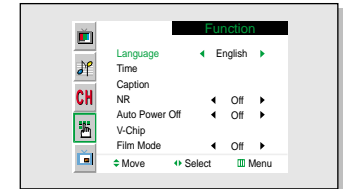

2 Press the UP or DOWN button to select "Caption", then press the ENTER button.

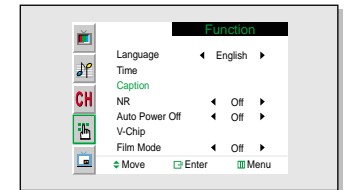

3 Press the LEFT or RIGHT button to turn closed captioning On/Off.

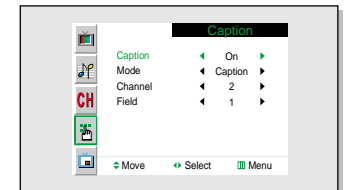

4 Press the UP or DOWN button to select "Mode", then press the LEFT or RIGHT button to select "Caption" or "Text."

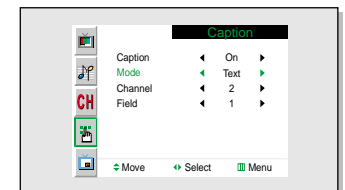

5 Depending on the particular broadcast, it might be necessary to make changes to "Channels" and "Field": Press the UP/DOWN/LEFT/RIGHT button to make the changes. (Follow the same procedure as in steps 3-4 above.) Press the MENU button to exit.

Note

- Different channels and fields display different information: Field 2 carries additional information that supplements the information in Field 1. (For example, Channel 1 may have subtitles in English, while Channel 2 has subtitles in Spanish.)

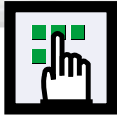

Digital Noise Reduction

If the broadcast signal received by your TV is weak, you can activate the Digital Noise Reduction feature to help reduce any static and ghosting that may appear on the screen.

- 1 Press the MENU button. Press the UP or DOWN button to select "Function", then press the ENTER button.

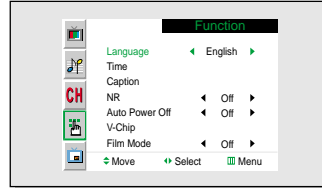

- 2 Press the UP or DOWN button to select "NR".

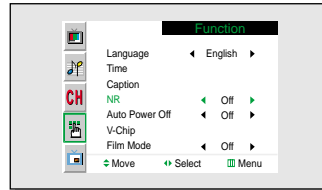

- 3 Press the LEFT or RIGHT button to select "On".

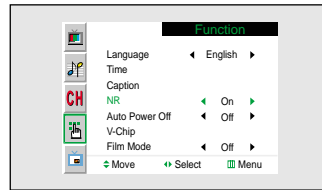

- 4 Press the MENU button to exit.

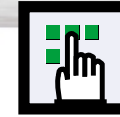

Setting Auto Power Off

The PDP can be set to turn off automatically if no buttons are pressed for 3 hours after the PDP turns on via the On timer.

- 1 Press the MENU button. Press the UP or DOWN button to select "Function", then press the ENTER button.

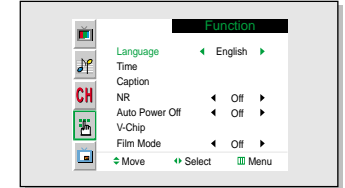

- 2 Press the UP or DOWN button to select "Auto Power Off".

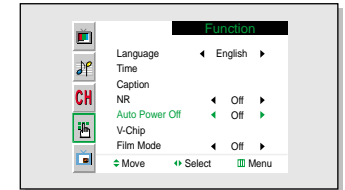

- 3 Press the LEFT or RIGHT button to select "On".

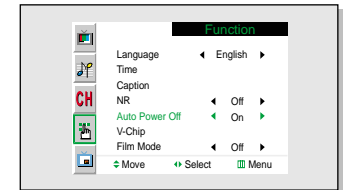

- 4 Press the MENU button to exit.

Note

- If the Off timer is set, Auto Power Off will not function.
- The power will be turned off automatically after 15 minutes if the PDP is ON and there is no input signal. (For instance, if you select a channel without a signal while in TV mode or when there is no input signal after selecting an output signal)

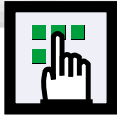

Using the V-Chip

The V-Chip feature automatically locks out programs that are deemed inappropriate for children. The user must enter a PIN (personal ID number) before any of the V-Chip restrictions are set up or changed.
 Note : When the V-chip feature is activated, the PIP and auto channel program features do not function.

Setting Up Your Personal ID Number (PIN)

- 1 Press the MENU button. Press the UP or DOWN button to select "Function", then press the ENTER button.
- 2 Press the UP or DOWN button to select "V-Chip", then press the ENTER button.
- 3 The message "Enter Pin" will appear. Enter your 4-digit PIN number.
 Note: The default PIN number of a new TV set is "0-0-0-0."
- 4 The "V-Chip" screen will appear. Press the UP or DOWN button to select "Change Pin," then press the ENTER button.
- 5 The Change pin screen will appear. Choose any 4-digits for your PIN and enter them. As soon as the 4 digits are entered, the "Confirm New Pin" screen appears. Re-enter the same 4 digits. When the Confirm screen disappears, your PIN has been memorized.
- 6 Press the MENU button to exit.

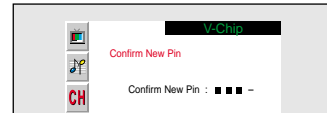
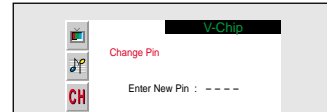
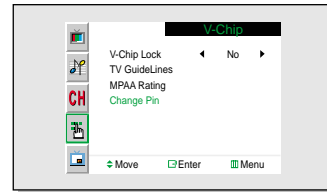
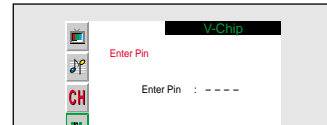
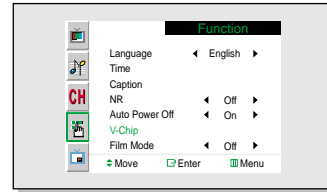
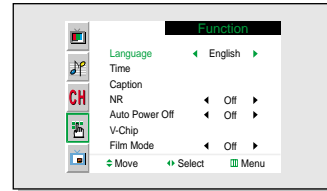

How to Enable/Disable the V-Chip

- 1 Press the MENU button. Press the UP or DOWN button to select "Function", then press the ENTER button.
- 2 Press the UP or DOWN button to select "V-Chip", then press the ENTER button.
- 3 The message "Enter Pin" will appear. Enter your 4-digit PIN number.
- 4 The "V-Chip" screen will appear. To enable the V-Chip feature, press the RIGHT button so that the "V-Chip Lock" field is Yes. (Pressing the left or right button will alternate between "Yes" and "No".)
- 5 Press the MENU button to exit.

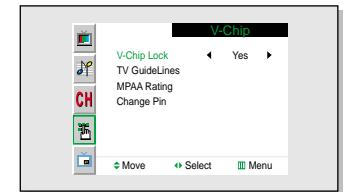
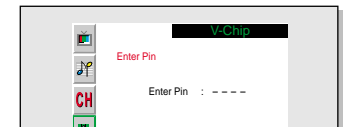
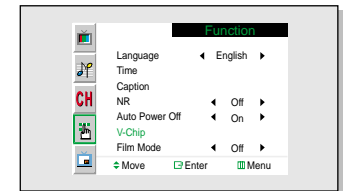
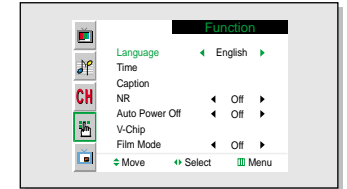

Note

- If you forget the PIN, press the remote-control buttons in the following sequence, which resets the pin to 0-0-0-0 : Power Off → Mute → 8 → 2 → 4 → Power On.

How to Set up Restrictions Using the "TV guidelines"

First, set up a personal identification number (PIN), and enable the V-Chip. (See previous section.) Parental restrictions can be set up using either of two methods: The TV guidelines or the MPAA rating.

- 1 Press the MENU button. Press the UP or DOWN button to select "Function", then press the ENTER button.

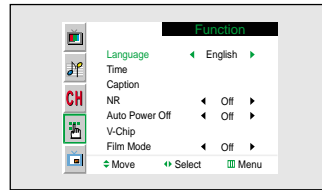

- 2 Press the UP or DOWN button to select "V-Chip", then press the ENTER button.

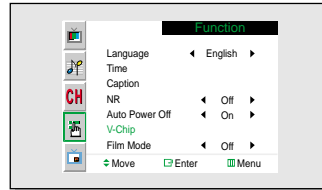

- 3 The message "Enter Pin" will appear. Enter your 4-digit PIN number.

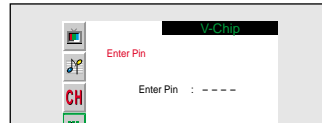

- 4 The "V-Chip" screen will appear. Press the UP or DOWN button to select "TV Guidelines", press the ENTER button.

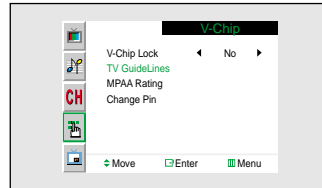

- 5 The "TV Guidelines" screen will appear. Press the UP or DOWN button to select one of the six age-based categories:

TV-Y	Young children
TV-Y7	Children 7 and over

TV-G	General audience
TV-PG	Parental guidance
TV-14	Viewers 14 and over
TV-MA	Mature audience

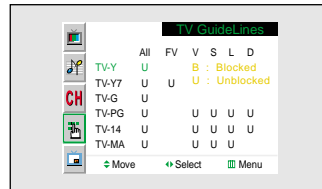

- 6 At this point, one of the TV-Ratings is selected. Press the RIGHT button : Depending on your existing setup, a letter "U" or "B" will start blinking. (U= Unblocked, B= Blocked)

While the "U" or "B" is blinking, press the UP or DOWN button to block or unblock the category. Press the RIGHT button to save the TV guidelines. A TV-Rating will be selected, and no letters will blink. To select a different TV-Rating, press the UP or DOWN button and then repeat the process.

Note 1: The TV-Y7, TV-PG, TV-14 and TV-MA have additional options. See the next step to change any of the following sub-ratings:

- FV: Fantasy violence
- D: Sexually Suggestive Dialog
- L: Adult Language
- S: Sexual situation
- V: Violence

Note 2: The V-Chip will automatically block certain categories that are "more restrictive". For example, if you block "TV-Y" category, then TV-Y7 will automatically be blocked. Similarly, if you block the TV-G category, then all the categories in the "young adult" group will be blocked (TV-G, TV-PG, TV-14 and TV-MA). The sub-ratings (D, L, S, V) work together similarly. (See next section.)

- 7 How to set the FV, D, L, S and V sub-ratings. First, select one of these TV-Ratings: TV-Y7, TV-PG, TV-14 or TV-MA (See Step 4, on previous page). Next, while the TV-Rating is selected, repeatedly press the RIGHT button. This will cycle through the available sub-ratings (FV,L, S, D or V). A blinking letter ("U" or "B") will be displayed for each sub-rating. While the "U" or "B" is blinking, press the UP or DOWN button to change the sub-rating. Press the RIGHT button to save the TV guidelines. A TV-Rating will be selected and no letters will select. To select a different TV-Rating, press the UP or DOWN button and then repeat the process.

Note: The V-chip will automatically block certain categories that are "More restrictive". For example, if you block "L" sub-rating in TV-PG, then the "L" sub-ratings in TV-14 and TV-MA will automatically be blocked.

- 8 Press the MENU button to clear all the screens. (Or proceed to the next section, and set up additional restrictions based on the MPAA codes).

Note

- Note: These categories consist of two separate groups: TV-Y and TV-Y7 (young children through age 7), and TV-G through TV-MA (everybody else). The TV-Y and TV-Y7 categories are colored blue.

The restrictions for these two groups work independently: If a household includes very young children as well as young adults, the TV guidelines must be set up separately for each age group. (See next step.)

How to Set up Restrictions using the MPAA Ratings: G, PG, PG-13, R, NC-17, X

The MPAA rating system uses the Motion Picture Association of America (MPAA) system, and its main application is for movies. When the V-Chip lock is on, the TV will automatically block any programs that are coded with objectionable ratings (either MPAA or TV-Ratings).

- 1 Press the MENU button. Press the UP or DOWN button to select "Function", then press the ENTER button.

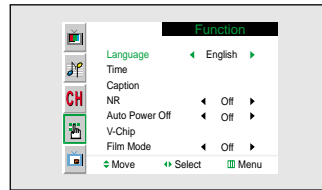

- 2 Press the UP or DOWN button to select "V-Chip", then press the ENTER button.

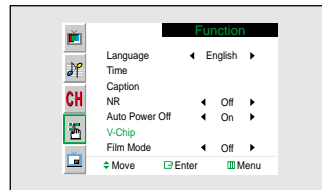

- 3 The message "Enter Pin" will appear. Enter your 4-digit PIN number.

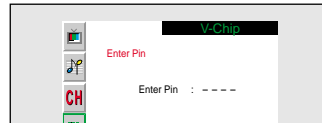

- 4 The "V-Chip" screen will appear. Press the UP or DOWN button to select "MPAA Rating," press the ENTER button.

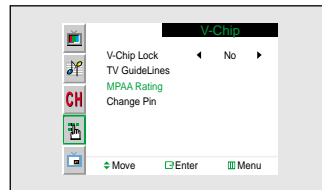

- 5 The "MPAA Rating" screen will appear. MPAA category. Pressing the UP or DOWN button will cycle through the MPAA categories:

G	General audience (no restrictions).
PG	Parental guidance suggested.
PG-13	PG-13 (Parents strongly cautioned).
R	R (Restricted. Children under 17 should be accompanied by an adult).
NC-17	No children under age 17.
X	X (Adults only).
NR	Not rated.

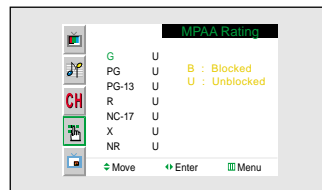

While a particular category is selected, press the RIGHT button to activate it. A selected letter ("U" or "B") will be displayed. Press the UP or DOWN button to select "U" or "B". Press the RIGHT button to save the settings.

Note: The V-Chip will automatically block any category that is "more restrictive." For example, if you block the "PG-13" category, then "R", "NC-17" and "X" will automatically be blocked also.

How to Reset the TV after the V-Chip Blocks a Channel ("Emergency Escape")

If the TV is tuned to a restricted channel, the V-Chip will block it. The screen will go blank and the following message will appear: "Excessive rating."

To resume normal viewing, tune to a different channel using the number buttons. Under certain conditions (depending on the rating of the local TV programs) the V-Chip might lock out all the channels. In this case, use the V.Chip function for an "emergency escape":

- 1 Press the MENU button.
- 2 Press the UP or DOWN button to select "V-Chip", then press the ENTER button.
- 3 Enter your PIN number, and press the RIGHT button to temporarily disable the V-Chip Lock.



Selecting the Film Mode

1 Press the MENU button. Press the UP or DOWN button to select "Function", then press the ENTER button.

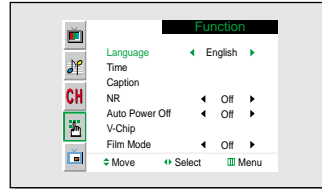

2 Press the DOWN button to select Film Mode, then press the RIGHT or LEFT button to select "On" or "Off".

- On: Automatically senses and processes film signals from all sources and adjusts the picture for optimum quality.
- Off: Switches off the Film mode.

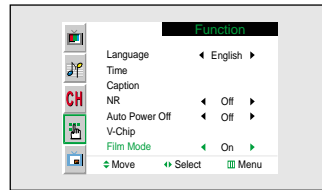

3 Press the MENU button to exit.

Note

- Film mode is supported in Video, S-Video, Component 480i.

S
M
M
S
U
N
G

P L A S M A D I S P L A Y P A N E L

Appendix



Troubleshooting.....	96
Care and Maintenance	97
Specifications	98



Troubleshooting

Before you call a service technician, please scan this list of problems and possible solutions. It may save you time and money.

Problem	Possible Solution
Poor picture.	Check all wire connections.
Your Remote control does not operate the PDP.	Press the "Mode" button to put your remote control in the "TV" mode.
The PDP won't turn on.	Check if the power plug is connected.
There is no screen image.	Check to see that both the PDP and the source are plugged in and turned on.
The image is too light or too dark.	Adjust the Brightness or Contrast settings.
The image is too large or too small.	Adjust the Size settings.



Care and Maintenance

With proper care, your PDP will give you many years of service. Please follow these guidelines to get the maximum performance from your PDP.

Identifying Problems

- Do not put the PDP near extremely hot, cold, humid or dusty places.
- Do not put the PDP near appliances that create magnetic fields.
- Keep the ventilation openings clear.
- Do not place the PDP on a rough and slanted surface, such as cloth or paper.

Liquids

- Do not place liquids near or on the PDP.

Cabinet

- Never open the cabinet or touch the parts inside.
- Wipe your PDP with a clean, dry cloth. Never use water, cleaning fluids, wax, or chemicals.
- Do not put heavy objects on top of the cabinet.

Temperature

- If your PDP is suddenly moved from a cold to a warm place, unplug the power cord for at least two hours so that moisture that may have formed inside the unit can dry completely.



Specifications



Memo

Exterior design and product specifications are subject to change without prior notice to improve the performance of this product.

This PDP applies to Class B digital device.
 (Note: Class B system is for home use.)

This PDP has been registered for residential use in terms of EMI. So it can be used in all areas as well as residential areas.

Model		SPN4235
Dimensions	Display	1027 (W) X 79 (D) X 630.5 (H) mm ; 40.43 (W) X 3.11 (D) X 24.82(H) inches
	Remote Control	58 (W) X 21 (D) X 210 (H) mm ; 2.28 (W) X 0.83 (D) X 8.27 (H) inches
Weight	Display	31 kg ; 68.34 lbs (37.6 kg ; 82.89 lbs (with stand))
	Remote Control	134g ; 0.295 lbs (including batteries)
Voltage		120V~, 60Hz
Power Consumption		370 Watts
Number of Pixels		852(H) x 480(V)
Screen Size		107 Cm/42 inches
ANTENNA input		VHF, UHF (75Ω unbalanced)
VIDEO input		VIDEO S-VIDEO COMPONENT 1 - 480i / 480p / 720p / 1080i COMPONENT 2 - 480i / 480p / 720p / 1080i RGB : D-SUB 15P DVI
AUDIO input		VIDEO / S-VIDEO COMPONENT 1 COMPONENT 2 PC (RGB) DVI
AUDIO output		10W + 10W (8 Ω) Subwoofer (500mv RMS at 1KHz)