



Interactive Flat Panel User Manual

T420
TL550
T650



Disclaimer

BenQ Corporation makes no representations or warranties, either expressed or implied, with respect to the contents of this document. BenQ Corporation reserves the right to revise this publication and to make changes from time to time in the contents thereof without obligation to notify any person of such revision or changes.

Copyright

Copyright 2012 BenQ Corporation. All rights reserved. No part of this publication may be reproduced, transmitted, transcribed, stored in a retrieval system or translated into any language or computer language, in any form or by any means, electronic, mechanical, magnetic, optical, chemical, manual or otherwise, without the prior written permission of BenQ Corporation.

Table of Contents

Disclaimer.....	2
Copyright.....	2
Safety warnings and precautions	5
Important safety instructions.....	6
Notes on the LCD panel of this display.....	6
Safety notice for remote control.....	7
Battery safety notice.....	7
Package contents	8
Optional accessories.....	8
Parts of the display and their functions	9
Front panel.....	9
Rear panel	10
Input/output terminals.....	11
Remote control.....	13
Using the remote control.....	14
Setting up the display	15
Mounting the display.....	15
Connecting audio/video signals	18
Connecting the touch module.....	25
Connecting power.....	26
Using the touch screen.....	27
Calibrating the touch screen.....	30
Important instructions for using the touch screen.....	30
Basic operations.....	31
Turning the display on or off	31
Locking/unlocking the controls	31
Switching input signals	31
Adjusting audio volume level	31
The OSD (On-Screen Display) menu	32
OSD menu overview	32
Operations in the OSD menu	33
Picture menu	34

Sound menu.....	35
Option menu	36
Setting menu.....	38
Product information	40
Specifications.....	40
Supported input signal resolution	44
Supported PIP input signal combination	45
Supported signal source and resolution in PIP mode	46
Troubleshooting	55

Safety warnings and precautions



The lightning flash with arrowhead symbol, within an equilateral triangle, is intended to alert the user to the presence of uninsulated "dangerous voltage" within the product's enclosure that may be of sufficient magnitude to constitute a risk of electric shock to persons.



The exclamation point within an equilateral triangle is intended to alert the user to the presence of important operating and maintenance (servicing) instructions in the literature accompanying the appliance.

THIS EQUIPMENT MUST BE GROUNDED

To ensure safe operation, the three-pin plug must be inserted only into a standard three-pin power outlet which is effectively grounded through normal household wiring. Extension cords used with the equipment must have three cores and be correctly wired to provide connection to the ground. Wrongly wired extension cords are a major cause of fatalities.

The fact that the equipment operates satisfactorily does not imply that the power outlet is grounded or that the installation is completely safe. For your safety, if you are in any doubt about the effective grounding of the power outlet, please consult a qualified electrician.

- The mains plug of the power supply cord shall remain readily operable. The AC receptacle (mains socket outlet) shall be installed near the equipment and shall be easily accessible. To completely disconnect this equipment from the AC mains, disconnect the power cord plug from the AC receptacle.
- Do not place this display on an uneven, sloping or unstable surface (such as a trolley) where it may fall and cause damage to itself or others.
- Do not place this display near water, like a spa or pool, or in a position which will allow the splashing or spraying of water onto the display, like in front of an open window where rain water may enter.
- Do not install this display in a confined space without proper ventilation and air circulation, such as in a closed cabinet. Allow proper space around the display for dissipating heat inside. Do not block any openings and vents on the display. Overheating may result in hazards and electric shock.
- Installation of this display should only be performed by a qualified technician. Failure to install this display properly may cause injuries and damages to the personnels and the display itself. Check the installation regularly and maintain the display periodically to ensure the best working condition.
- Use only the accessories approved or recommended by the manufacturer to mount this display. Using wrong or unsuitable accessories may cause the display to fall and result in serious personal injuries. Make sure that the surface and fixing points are strong enough to sustain the weight of the display.
- To reduce the risk of electric shock, do not remove covers. No user serviceable parts inside. Refer servicing to qualified service personnel.
- To prevent personal injuries, mounting the display or installing desktop stands is required before use.

Important safety instructions

1. Read these instructions.
2. Keep these instructions.
3. Heed all warnings.
4. Follow all instructions.
5. Do not use this apparatus near water.
6. Clean only with dry cloth.
7. Do not block any ventilation openings. Install in accordance with the manufacturer's instructions.
8. Do not install near any heat sources such as radiators, heat registers, stoves, or other apparatus (including amplifiers) that produce heat.
9. Do not defeat the safety purpose of the polarized or grounding-type plug. A polarized plug has two blades with one wider than the other. A grounding-type plug has two blades and a third grounding prong. The wide blade or the third prong are provided for your safety. If the provided plug does not fit into your outlet, consult an electrician for replacement of the obsolete outlet.
10. Protect the power cord from being walked on or pinched particularly at plugs, convenience receptacles, and the point where they exit from the apparatus.
11. Only use attachments/accessories specified by the manufacturer.
12. Use only with the cart, stand, tripod, bracket, or table specified by the manufacturer, or sold with the apparatus. When a cart is used, use caution when moving the cart/apparatus combination to avoid injury from tip-over.
13. Unplug this apparatus during lightning storms or when unused for long periods of time.
14. Refer all servicing to qualified service personnel. Servicing is required when the apparatus has been damaged in any way, such as power-supply cord or plug is damaged, liquid has been spilled or objects have fallen into the apparatus, the apparatus has been exposed to rain or moisture, does not operate normally, or has been dropped.



Notes on the LCD panel of this display

- The Liquid Crystal Display (LCD) panel of this display has a very thin protective layer of glass which is liable to marking or scratching, and cracking if struck or pressured. The liquid crystal substrate is also liable to damage under excessive force or extreme temperatures. Please handle with care.
- The response time and brightness of the LCD panel may vary with the ambient temperature.
- Avoid placing the display in direct sun or where direct sun or spot lighting will shine onto the LCD panel, as the heat may damage the panel and the external casing of the display, and the bright light will make viewing the display more difficult than necessary.
- The LCD panel consists of individual pixels to display images and is manufactured according to the design specifications. While 99.9% of these pixels work normally, 0.01% of the pixels may remain constantly lit (in red, blue or green) or unlit. This is a technical limitation of the LCD technology and is not a defect.
- LCD screens, like plasma (PDP) and conventional CRT (Cathode Ray Tube) screens, are also susceptible to 'screen burn-in' or 'image retention' which can be found on the

screen as visible fixed lines and shades. To avoid such damage to the screen, avoid displaying still images (like On-Screen Display menus, TV station logos, fixed/inactive text or icons) for more than two hours. Change the aspect ratio from time to time. Fill the entire screen with the image and eliminate the black bars whenever possible. Avoid displaying images in 4:3 aspect ratio over a long period of time, otherwise there may be visible burn marks on the screen as two vertical lines.

- Note: Under certain circumstances, condensation may occur on the inner side of the cover glass, it's a natural phenomenon and will not affect the operation of the display. This condensation will usually disappear after around 2 hours of normal operation.

Safety notice for remote control

- Do not put the remote control in the direct heat, humidity, and avoid fire.
- Do not drop the remote control.
- Do not expose the remote control to water or moisture. Failure to do so could result in malfunction.
- Confirm there is no object between the remote control and the remote sensor of the product.
- When the remote control will not be used for an extended period, remove the batteries.

Battery safety notice

The use of the wrong type of batteries may cause chemical leaks or explosion. Please note the following:

- Always ensure that the batteries are inserted with the positive and negative terminals in the correct direction as shown in the battery compartment.
- Different types of batteries have different characteristics. Do not mix different types.
- Do not mix old and new batteries. Mixing old and new batteries will shorten battery life or cause chemical leaks from the old batteries.
- When batteries fail to function, replace them immediately.
- Chemicals which leak from batteries may cause skin irritation. If any chemical matter seeps out of the batteries, wipe it up immediately using a dry cloth, and replace the batteries as soon as possible.
- Due to varying storage conditions, the battery life for the batteries included with your product may be shortened. Replace them within 3 months or as soon as you can after initial use.
- There may be local restrictions on the disposal or recycling of batteries. Consult your local regulations or waste disposal provider.

Package contents

Open the sales package and check the contents. If any item is missing or damaged, please contact your dealer immediately.

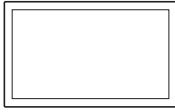

LCD display

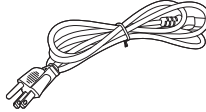

Power cord

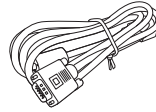

D-Sub (15-pin) cable

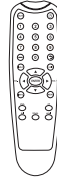

Remote control

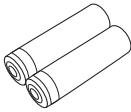

AAA batteries



Quick start guide

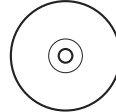

CD

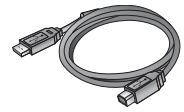

USB cable
(for T650)



- The type of power cord supplied may differ from that illustrated depending on your region of purchase.
- Before discarding the package, check that you haven't left any accessories inside the box.
- Do not leave plastic bags within reach of young children or babies.

Optional accessories

In addition to the items that come with the standard package, the following optional accessories are also available separately:

(For T420/TL550)

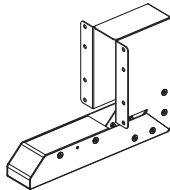

(For T650)

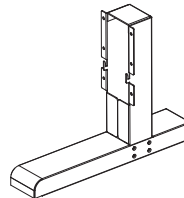

Desktop stands

Parts of the display and their functions

Front panel



T420

1

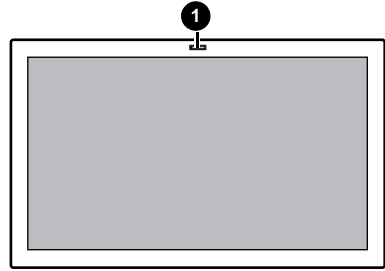

TL550 / T650

No.	Name	Description
1	 Remote control sensor / Ambient light sensor / Power indicator	<ul style="list-style-type: none"> • Receives command signals from the remote control. • Detects ambient lighting conditions around the display and adjusts screen brightness automatically when the Ambient Light Sensor function is activated. • Indicates the operating status of the display: <ul style="list-style-type: none"> - Lights up green when the power is turned on. - Lights up red when the display is turned off. - Lights up red when the display is in Standby Eco mode. - Flashes red when the display is in Standby Standard mode. - Off when the main power is turned off.

Rear panel

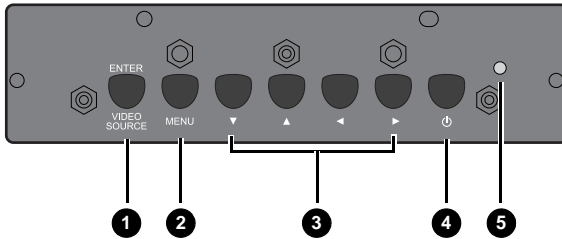
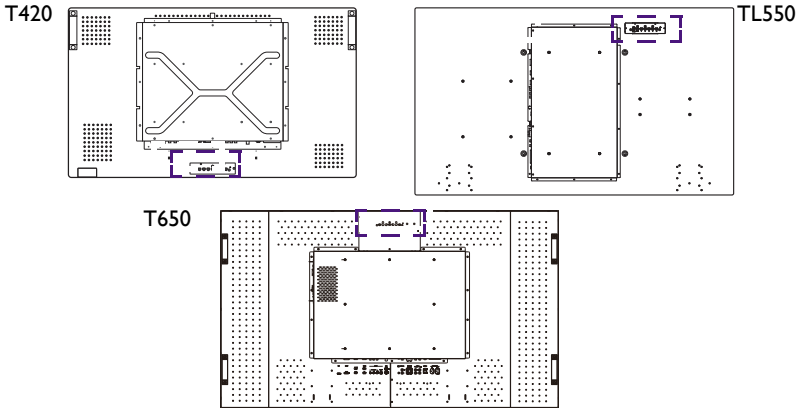

No.	Name	Description
1	ENTER/VIDEO SOURCE	<ul style="list-style-type: none"> • Selects a video source. • Confirms your selection or enters a submenu in the On-Screen Display (OSD) menu.
2	MENU	<ul style="list-style-type: none"> • Opens the OSD menu. • Returns to a previous menu or exits the OSD menu.
3	▼ / ▲ / ◀ / ▶	Scrolls through settings and options in the OSD menu.
4	Power button	Turns on the display or puts it in standby mode.
5	Power indicator	<p>Indicates the power status of the display:</p> <ul style="list-style-type: none"> - Lights up green when the power is turned on. - Lights up red when the display is turned off. - Lights up red when the display is in Standby Eco mode. - Flashes red when the display is in Standby Standard mode. - Off when the main power is turned off.

Input/output terminals

T420

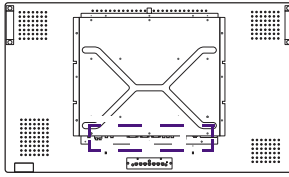

TL550

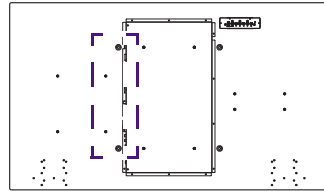

T650

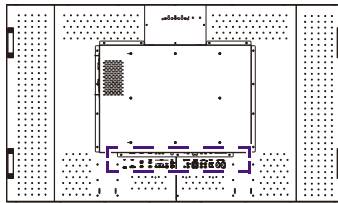

T420

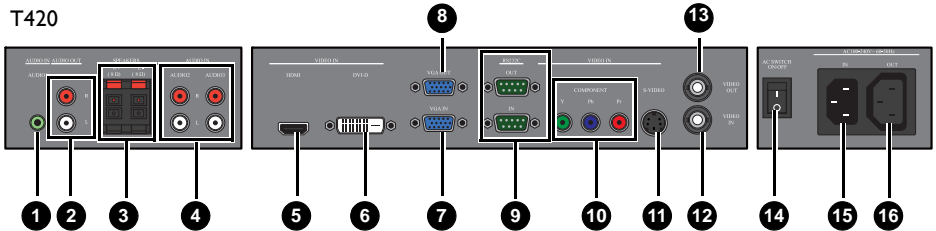

TL550 / T650

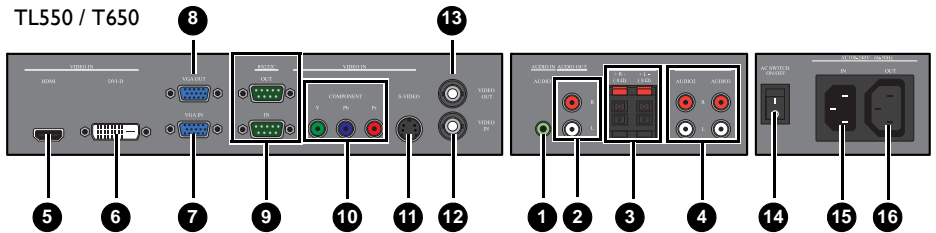

No.	Name	Description
1	AUDIO IN (AUDIO1)	Receives audio signals from an external device (such as a computer).
2	AUDIO OUT (R/L)	Outputs audio signals from an audio or HDMI input source to an external device.
3	SPEAKERS (R/L)	Outputs audio signals from an audio or HDMI input source to external speakers.
4	AUDIO IN (AUDIO2/AUDIO3)	Receives audio signals from an external device (such as a VCR or DVD player).
5	VIDEO IN (HDMI)	Receives HDMI signals from an external device (such as a Blu-ray disc player).

6	VIDEO IN (DVI-D)	Receives DVI signals from an external device (such as a computer).
7	VGA IN	Receives analog RGB signals from an external device (such as a computer).
8	VGA OUT	Outputs analog RGB signals from the VGA IN input to another display.
9	RS232C IN/OUT	For external control and multi-display operation. <ul style="list-style-type: none">• RS232C IN: receives control signals from a computer or another display.• RS232C OUT: outputs control signals from the RS232C IN input to another display.
10	VIDEO IN (COMPONENT)	Receives component video (YPbPr) signals from an external device (such as a DVD player, HDTV device or Laser disc player).
11	VIDEO IN (S-VIDEO)	Receives S-Video signals from an external device (such as a VCR or DVD player).
12	VIDEO IN	Receives composite video signals from an external device (such as a VCR or DVD player).
13	VIDEO OUT	Outputs composite video signals from the VIDEO IN input to another display.
14	AC SWITCH ON/OFF	Turns on or off the main power.
15	AC IN	Connects to a power outlet via the supplied power cord.
16	AC OUT	Relays the AC power from the AC IN jack to another display.

Remote control

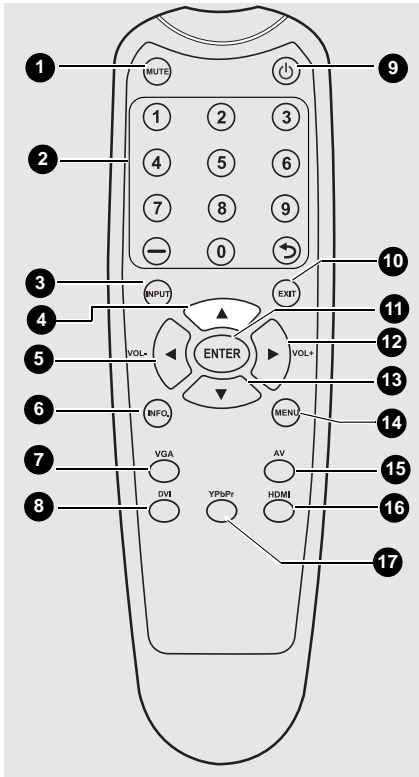

1 MUTE

Turns on or off the mute function.

2 Numeric buttons

These buttons are not used and do not work.

3 INPUT

Selects an input source.

4 ▲

Scrolls through settings and options in the OSD menu.

5 ◀ / VOL-

- Scrolls through settings and options in the OSD menu.
- Turns down the volume.

6 INFO

Shows the current input source and resolution.

7 VGA

Selects the **VGA** input source.

8 DVI

Selects the **DVI** input source.

9 Power

Turns on the display or puts it in standby mode.

10 EXIT

Returns to a previous menu or closes the OSD menu.

11 ENTER

Confirms your selection or save changes.

12 ▶ / VOL+

- Scrolls through settings and options in the OSD menu.
- Turns up the volume.

13 ▼

Scrolls through settings and options in the OSD menu.

14 MENU

Opens or closes the OSD menu.

15 AV

Selects the **AV** input source.

16 HDMI

Selects the **HDMI** input source.

17 YPbPr

Selects the **YPbPr** input source.

Using the remote control

Installing remote control batteries

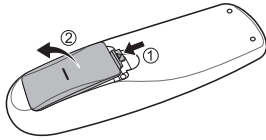

1. Open the remote control battery compartment cover.

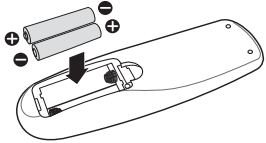

2. Insert the supplied batteries ensuring that the positive and negative marked battery terminals match the (+) and (-) marks in the battery compartment.



The supplied batteries are provided for your convenience so that you can operate the display straight away. You should replace them as soon as possible.

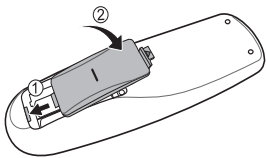

3. Refit the battery compartment cover.

Remote control usage tips

- Point and aim the top front of the remote control directly at the display's remote control sensor window when you press the buttons.
- Do not let the remote control become wet or place it in humid environments (like bathrooms).
- If the display's remote control sensor window is exposed to direct sunlight or strong light, the remote control may not operate properly. In this situation, change the light source, readjust the angle of the display or operate the remote control from a location closer to display's remote control sensor window.

T420

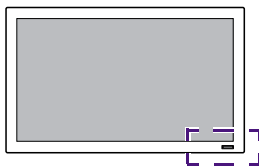

TL550 / T650

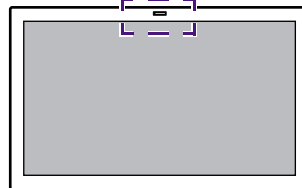

Max. 10 m
(32.8 feet)

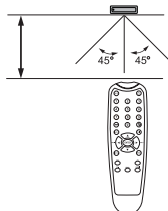

Setting up the display

Mounting the display

You can install the display on a vertical surface with a suitable wall mounting bracket or on a horizontal surface with the optional desktop stands. Please pay attention to the following notes during installation:

- This display should be installed by at least two adult persons. Attempting to install this display by only one person may result in danger and injuries.
- Refer the installation to qualified technicians. Improper installation may cause the display to fall or malfunction.

Installing the display on a wall

1. Place a clean, dry and lint-free cloth on a flat, horizontal and object-free surface. Make sure that the size of the cloth is larger than the display.
2. Gently lay the display on the cloth with the LCD screen facing down.
3. Remove the desktop stands from the display if installed.

4. Identify the wall mounting screw holes on the back of the display as shown in the illustration.

(For T420)

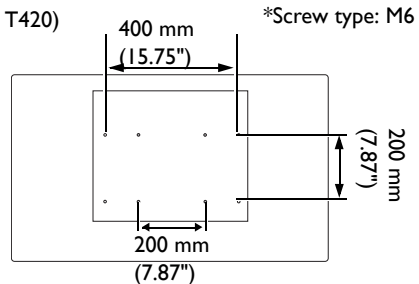

(For TL550)

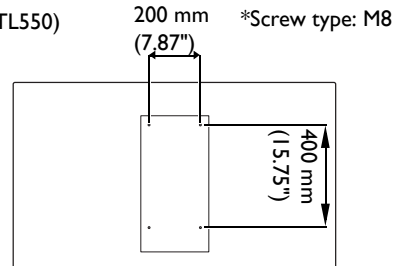

(For T650)

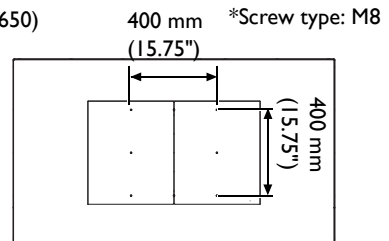

5. Install the wall mounting bracket on the display and attach the display to the wall according to the mounting bracket's instructions. The length of the screw should exceed the thickness of the wall mounting bracket by at least 10 mm. Make sure that all screws are tightened and secured properly. (Recommended torque: 470 - 635N•cm). The mounting means should be strong enough to bear the weight of the display.

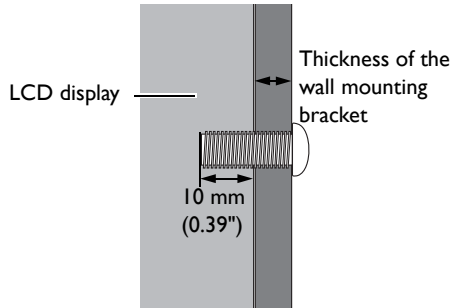

- To maintain proper ventilation, keep at least 10 mm of clear space from the back cover of the display to the wall.
- Please consult a professional technician for wall mount installations. The manufacturer accepts no liability for installations not performed by a professional technician.

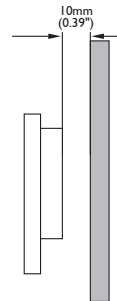

Installing the optional desktop stands

1. Place a clean, dry and lint-free cloth on a flat, horizontal and object-free surface. Make sure that the size of the cloth is larger than the display.
2. Gently lay the display on the cloth with the LCD screen facing down.

-
3. Place the desktop stands on the display as illustrated.

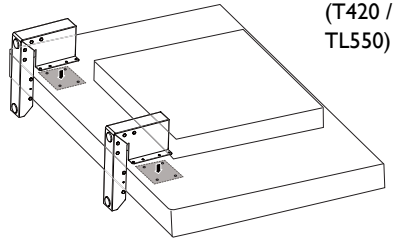
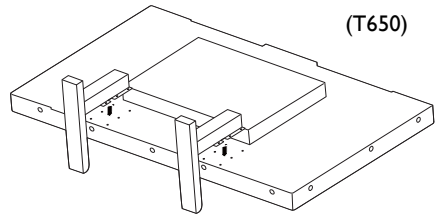

-
4. Use the screws and a suitable screwdriver to secure the stands on the display.

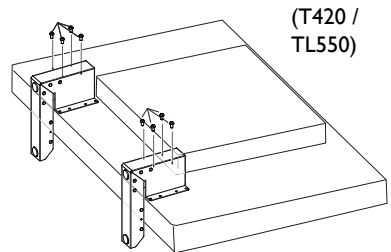
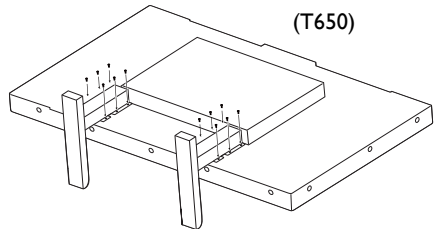

Connecting audio/video signals

Pay attention to the following notes when you connect cables:

- Please turn off all devices.
- Familiarize yourself with the audio/video ports on the display and the devices you want to use. Be aware that incorrect connections may adversely affect picture quality.
- Do not remove cables from the ports by pulling the cable itself. Always grasp and pull the connectors at the end of the cable.
- Ensure that all cables are fully inserted and firmly seated.

Connecting the VGA input

1. Connect the **VGA IN** jack on the display to the VGA output jack on a computer using a D-Sub (15-pin) cable.
2. Connect the computer's audio output jack to the **AUDIO IN (AUDIO1)** jack on the display using a suitable audio cable.
3. If a second display is used, connect the **VGA OUT** jack on the first display to the **VGA IN** jack on the second display using a D-Sub (15-pin) cable. This relays the VGA input signal from the first display to the second one.

- To view images from this input, press the **VGA** button on the remote control.

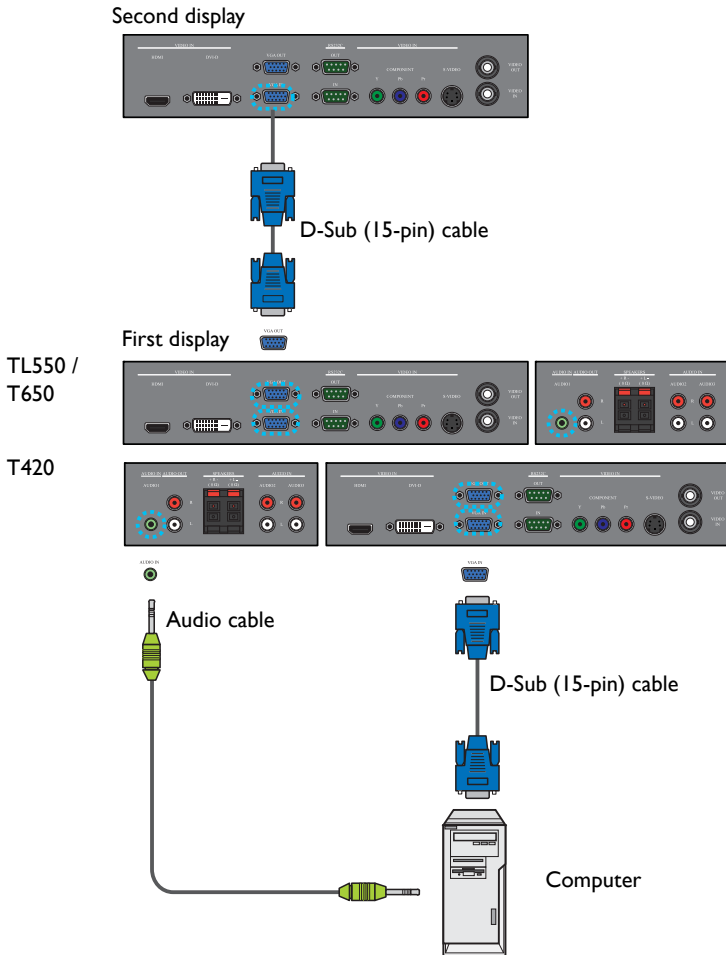

The audio cable is not supplied and should be purchased separately.

Connecting the digital input

1. Connect the **VIDEO IN (DVI-D)** jack on the display to the DVI-D output jack on a computer using a DVI-D cable. If the computer has an HDMI output jack, connect the computer's HDMI output jack to the **VIDEO IN (HDMI)** input jack on the display using an HDMI cable or a DVI-D to HDMI conversion cable.
2. Connect the computer's audio output jack to the **AUDIO IN (AUDIO1)** jack on the display using a suitable audio cable.
3. To view video image from this input, press the **DVI** or **HDMI** button on the remote control.

TL550 / T650



T420

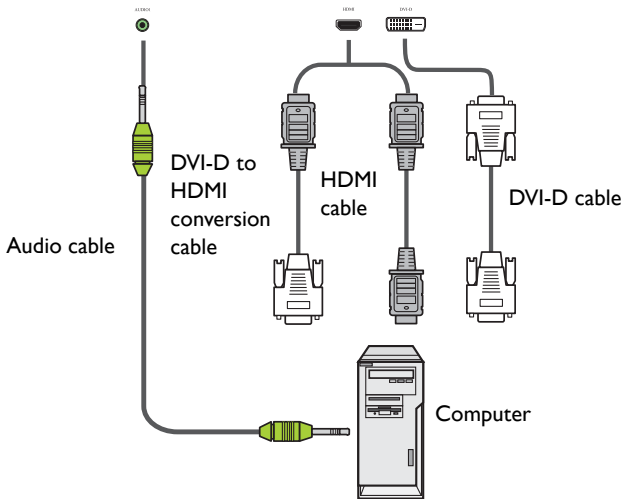

The cables are not supplied and should be purchased separately.

Connecting the YPbPr component video input

1. Connect the **VIDEO IN (COMPONENT)** jacks on the display to the component output jacks on an A/V device (such as a VCR or DVD player) using a component video cable.
2. Connect the DVD player's audio output jacks to the **AUDIO IN (AUDIO2 or AUDIO3)** jacks on the display using a suitable audio cable.
3. To view video image from this input, press the **YPbPr** button on the remote control.

TL550 /
T650



T420

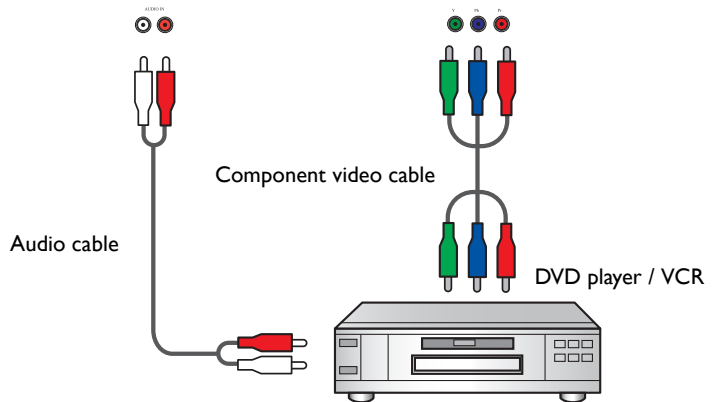

The cables are not supplied and should be purchased separately.

Connecting the AV and S-Video inputs

1. Connect the **VIDEO IN (S-VIDEO)** or **VIDEO IN** jack on the display to the output jack on an A/V device (such as a VCR) using an appropriate video cable.
2. Connect the VCR's audio output jacks to the **AUDIO IN (AUDIO2 or AUDIO3)** jacks on the display using a suitable audio cable.
3. If a second display is used, connect the **VIDEO-OUT** jack on the first display to the **VIDEO IN** jack on the second display using an AV cable. This relays the input signal from the first display to the second one.
4. To view video image from this input, press the **AV** button on the remote control for the AV signal, or press the **INPUT** button repeatedly for the S-Video signal.

Second display

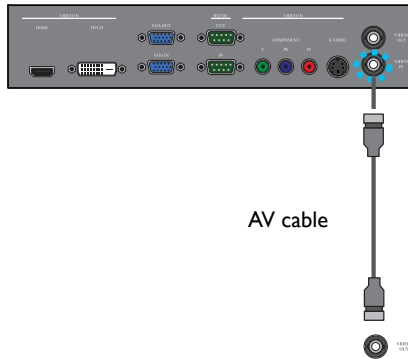

First display

TL550 /
T650



T420

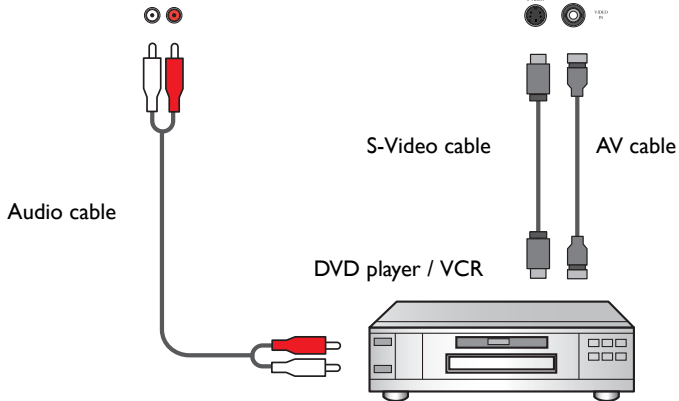

The cables are not supplied and should be purchased separately.

Connecting external speakers

The built-in amplifier on the display allows you to output audio signals through external speakers. Connect external speakers to the **SPEAKERS (R/L)** jacks on the display.

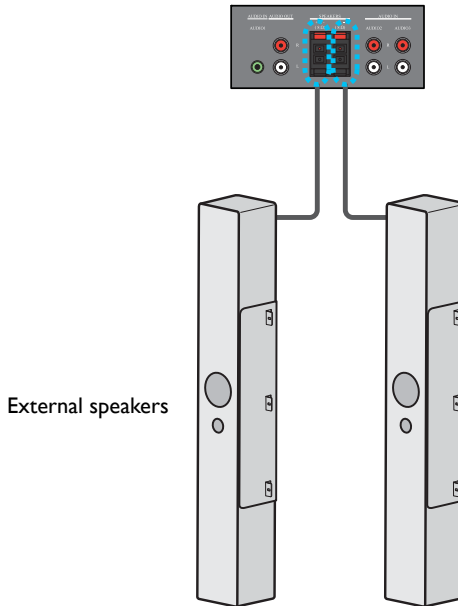

You can use the remote control or the control panel on the display to adjust the volume.

Connecting multiple displays

With the **RS232C IN/OUT** interfaces, you can connect multiple displays serially (daisy chain) to a computer for management. The number of displays you can connect serially depends on the resolution of the input signal you use.

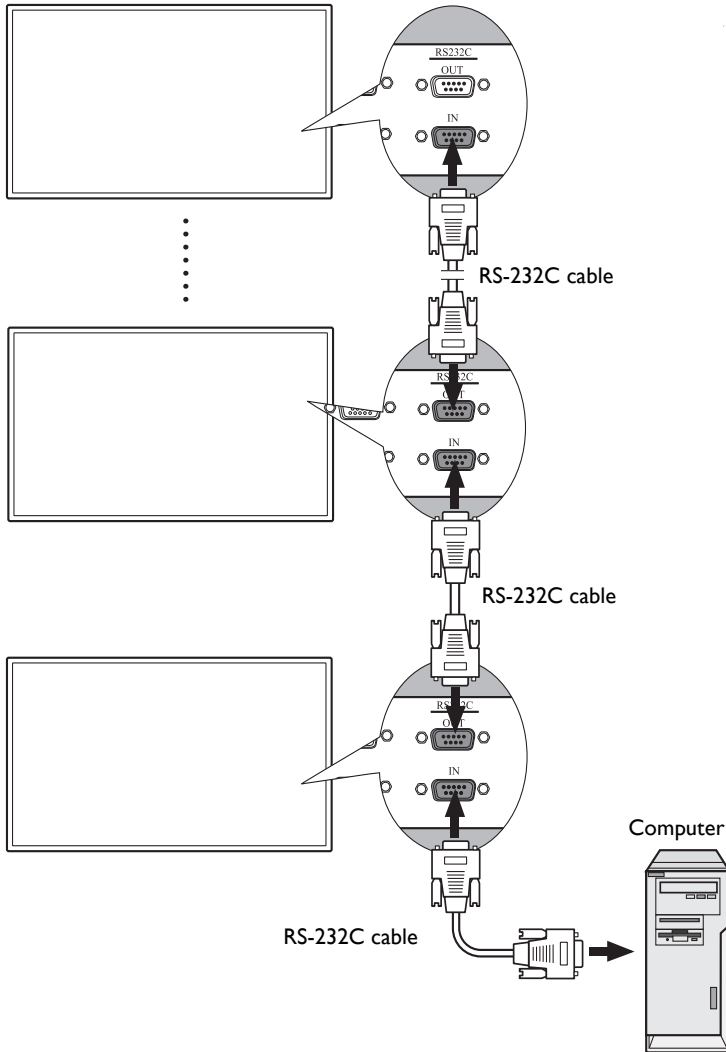

This function requires an RS-232C port equipped computer with the display management software installed.

Connecting the touch module

Connect the USB cable on the display to a computer.

The touch module supports easy Plug-and-Play operations. There is no need to install additional drivers on the computer.

T420

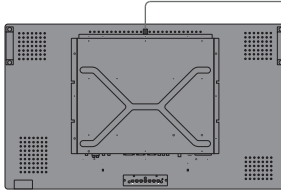

TL550

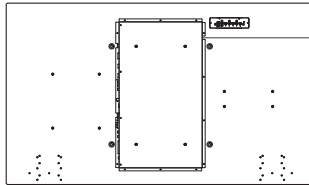

T650

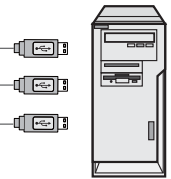
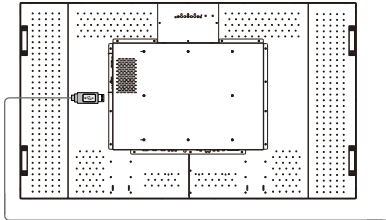

Connecting power

1. Plug one end of the power cord into the **AC IN** jack on the display and the other end into an appropriate power outlet (if the outlet is switched, turn on the switch).
2. Press the power switch to turn on the main power. The display will enter standby mode and the power indicator will light up red.

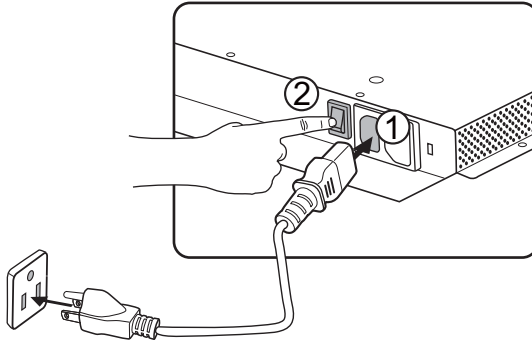

- The supplied power cord is suitable for use with 110-240V AC power only.
- The power cord and outlet illustrated may differ from the ones used in your region.
- Only use an appropriate power cord for your region. Never use a power cord which appears damaged or frayed, or change the plug type on the power cord.
- Be aware of the power loading when you use extension cords or multiple outlet power boards.
- There are no user serviceable parts in this display. Never unscrew or remove any covers. There are dangerous voltages inside the display. Turn off the power and unplug the power cord if you intend to move the display.

Using the touch screen

You can use the optical touch screen to control your operating system. The touch screen can emulate basic mouse functions and supports multi-touch functions for Windows 7*. The following table shows a list of gestures you can use on the touch screen.

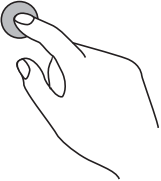
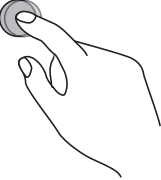
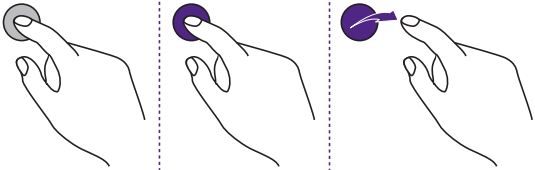
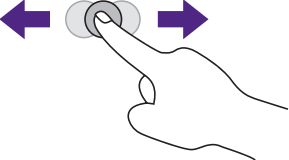

- Ensure that you have installed the USB cable on the display to a computer.
- *Multi-touch functions are only supported by Windows 7 - Home Premium, Professional, Enterprise and Ultimate versions. For Windows XP, Windows Vista and Windows 7 - Starter and Home Basic versions, multi-touch is not supported.
- Windows is a registered trademark of Microsoft Corporation in the United States and other countries.

OS functions	Gesture actions
For Windows XP, Windows Vista and Windows 7	
Click	Tap the screen once. 
Double-click	Tap the screen twice. 
Right-click	<ol style="list-style-type: none"> 1. Press on the target. 2. Hold and wait for a blue ring to appear. 3. Release your finger. 
Drag	Drag one finger left or right. 

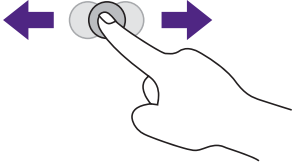
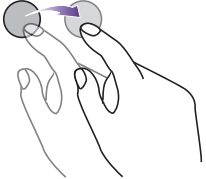
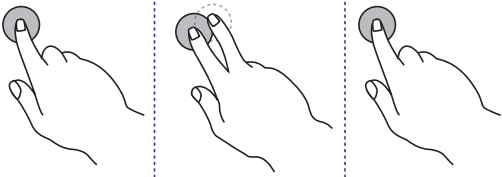
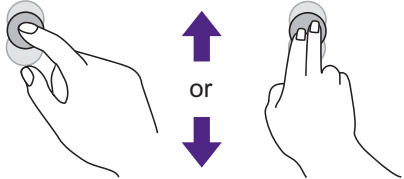
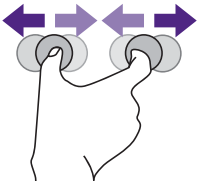
OS functions	Gesture actions
For Windows Vista and Windows 7	
Selection	<p>Drag one finger left or right.</p> 
Pan up / Pan down / Back / Forward	<p>Quickly drag your finger (Flick) in a desired direction.</p> 
Multi-touch functions For Windows 7 - Home Premium, Professional, Enterprise and Ultimate versions	
Right-click	<ol style="list-style-type: none"> 1. Press on the target. 2. Tap the screen with another finger. 3. Release the second finger. 
Scrolling	<p>Drag one or two fingers up or down.</p> 
Zoom	<p>Move two fingers apart or toward each other.</p> 

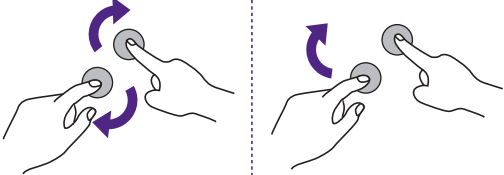
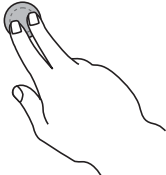
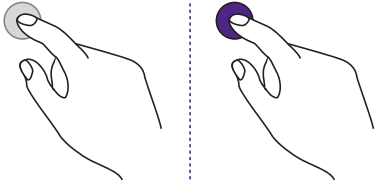
OS functions	Gesture actions
Supported by specific applications	<ul style="list-style-type: none">• Move two fingers in opposing directions.• Use one finger to pivot around another. 
Supported by specific applications	<p>Tap two fingers simultaneously. The target should be the midpoint between the fingers.</p> 
For Windows XP, Windows Vista and Windows 7	
Wakeup from Windows sleep mode (S3)	<p>Press and hold for 4 seconds.</p> 

Calibrating the touch screen



Ensure that you have installed the USB cable on the display to a computer.

You can calibrate the touch screen to use it more efficiently.

Refer to **Calibration tools** on the enclosed CD to perform the operation.

Important instructions for using the touch screen

- Do not bend the retro-reflective bars. The touch screen cannot function normally if the bars are bent.
- Keep the touch screen out of direct sunlight or spotlights.
- Avoid displaying still images to prevent image retention.
- Regularly clean the retro-reflective bars with a clean, soft cloth. A dusty environment may adversely affect the performance of your touch screen. Clean the retro-reflective bars as illustrated below. Do not clean the touch sensors on the top of the screen.

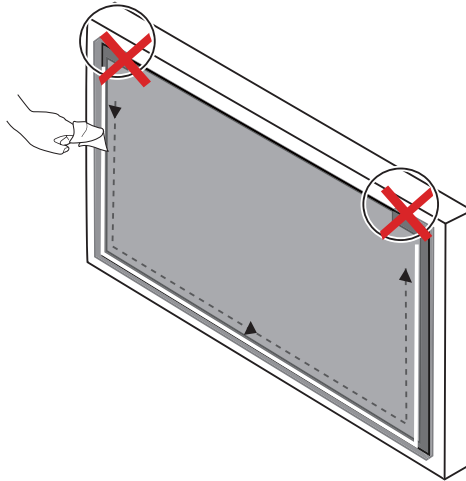

Basic operations

Turning the display on or off

To turn on or off the display, press the power button on the display's control panel or on the remote control.

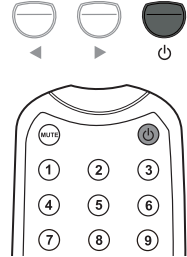

- The display's standby mode still consumes power. To completely cut off power supply, disconnect the power cord from the power outlet.
- The display follows the VESA approved DPM Power Management function. The power management function is an energy saving feature that automatically reduces the display's power consumption when the keyboard or the mouse has not been used for a fixed period.

Locking/unlocking the controls

You can lock/unlock the control panel to prevent unwanted or accidental operations.

Control panel buttons

Press and hold ◀ and ▶ simultaneously for 5 seconds. Once locked, the control panel buttons do not function unless unlocked.

OSD menu function

Press and hold ▲ and ▼ simultaneously for 5 seconds. Once locked, the **MENU** button on the control panel does not function unless unlocked.

Power on/off function

Press and hold **MENU** and ▶ for 5 seconds. Once locked, the power button on the control panel does not function unless unlocked.

Remote control functions

Press and hold **MENU** and ◀ for 5 seconds. Once locked, the display does not respond to any remote control operations unless unlocked.

Switching input signals

Press the **INPUT** button on the remote control or the **INPUT** button on the control panel to select an input signal.

Adjusting audio volume level

Press ▲/▼ on the control panel or **VOL+ / VOL-** on the remote control to adjust the volume.

The OSD (On-Screen Display) menu







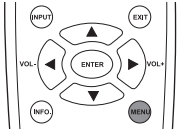

OSD menu overview

Menu name	Options/functions	See page
Picture	<ul style="list-style-type: none"> • Picture Mode • Contrast • Brightness • Color • Tint • Sharpness • Backlight • DCR • Color Temp • Input Resolution 	34
Sound	<ul style="list-style-type: none"> • Volume • Mute • Audio Source • Speaker 	35
Option	<ul style="list-style-type: none"> • Aspect ratio • PIP • Video Source • Auto Adjustment • Clock Frequency • Phase • H Position • V Position • Ambient Light Sensor • Auto Detection • Touch Feature 	36
Setting	<ul style="list-style-type: none"> • Language • Overscan • Schedule • Display Wall • Power Save • Set Monitor ID • Image Retention • Auto Adjustment • Advanced 	38

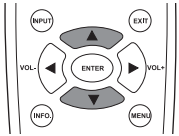

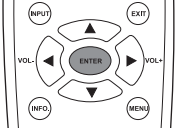

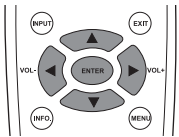
Some options are only available when a certain input signal source is selected.

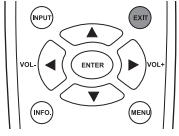
Operations in the OSD menu

Using the control panel buttons	Using the remote control
<p>1. Press MENU to open the OSD menu.</p>  <p>The diagram shows a row of seven buttons: ENTER, VIDEO MENU SOURCE, MENU, a downward arrow, an upward arrow, a leftward arrow, a rightward arrow, and a power button. A hand icon points to the MENU button.</p>	<p>1. Press MENU to open the OSD menu.</p>  <p>The diagram shows a remote control layout with buttons: INPUT, EXIT, VOL-, ENTER, VOL+, INFO, and MENU. The MENU button is highlighted with a grey circle.</p>
<p>2. In the OSD menu, press ▲ or ▼ to select an item.</p>  <p>The diagram shows the same row of seven buttons as above. A hand icon points to the upward arrow button.</p>	<p>2. Press ▲ or ▼ to select an item.</p>  <p>The diagram shows the same remote control layout as above. The upward arrow button is highlighted with a grey circle.</p>
<p>3. Press ENTER/VIDEO SOURCE to confirm selections.</p>  <p>The diagram shows the same row of seven buttons as above. A hand icon points to the ENTER button.</p>	<p>3. Press ENTER to confirm selections.</p>  <p>The diagram shows the same remote control layout as above. The ENTER button is highlighted with a grey circle.</p>
<p>4. Press ▲ or ▼ to select a feature and press ◀ or ▶ to adjust settings. Press ENTER/VIDEO SOURCE to save changes.</p>  <p>The diagram shows the same row of seven buttons as above. A hand icon points to the upward arrow button.</p>	<p>4. Press ▲ and ▼ to select a feature and press ◀ or ▶ to adjust settings. Press ENTER to confirm changes.</p>  <p>The diagram shows the same remote control layout as above. The upward and downward arrow buttons are highlighted with grey circles.</p>
<p>5. Press MENU to close the OSD menu.</p>  <p>The diagram shows the same row of seven buttons as above. A hand icon points to the MENU button.</p>	<p>5. Press EXIT to close the OSD menu.</p>  <p>The diagram shows the same remote control layout as above. The EXIT button is highlighted with a grey circle.</p>

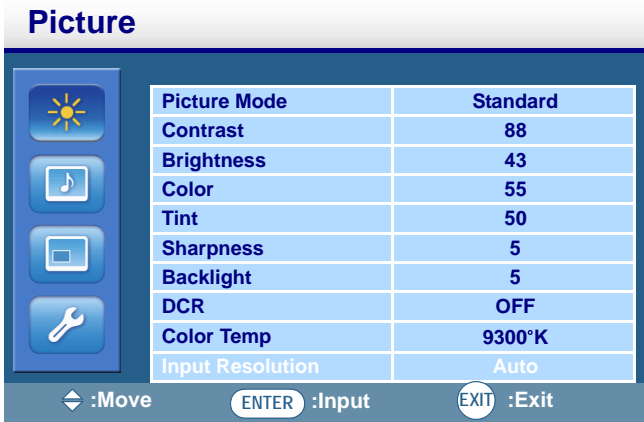
Picture menu



Name	Description
Picture Mode	Sets the display mode.
Contrast	Adjusts the image contrast when Picture Mode is set to User .
Brightness	Adjusts the image brightness when Picture Mode is set to User .
Color	Adjusts the color intensity when Picture Mode is set to User .
Tint	Adjusts the color tint when Picture Mode is set to User .
Sharpness	Adjusts the image sharpness when Picture Mode is set to User .
Backlight	Adjusts the backlight intensity for the screen.  This feature is not available if the Ambient Light Sensor function is set to HIGH or LOW .
DCR	Turns the DCR function on or off. This feature enhances image contrast for dark scenes.  This feature is not available if the Ambient Light Sensor function is set to HIGH or LOW .
Color Temp	Adjusts the color temperature.
Input Resolution	Sets the VGA input resolution. This is only required when the display cannot detect the resolution correctly.

Sound menu

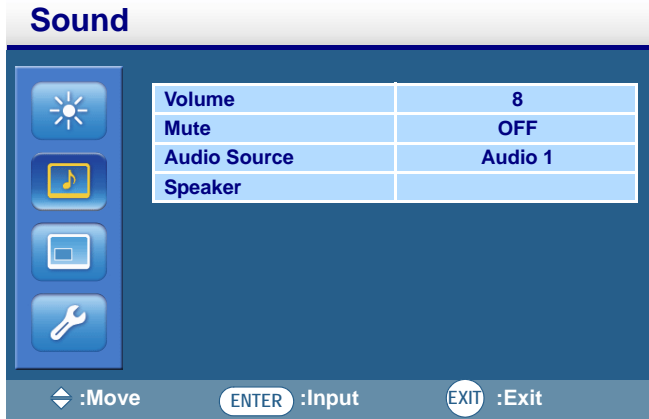

Name	Description
Volume	Adjusts the volume.
Mute	Turns the mute function on or off.
Audio Source	Sets the audio input source.
	<p>The diagram shows the rear connector panel with three audio input options: Audio 1 (green and white jacks), Audio 2 (red and white jacks), and Audio 3 (HDMI port). The panel also shows other connectors like AUDIO IN, SPEAKERS, and AUDIO OUT.</p>
Speaker	<p>Sets the audio source.</p> <p>External: Selects the audio output source from SPEAKERS (R/L) on the rear connector panel.</p> <p>Line-Out: Selects the audio output source from AUDIO OUT (R/L) on the rear connector panel.</p> <p>Internal: Select the audio input source from AUDIO IN on the rear connector panel. (This is an optional feature and may not be available for all models.)</p>

Option menu

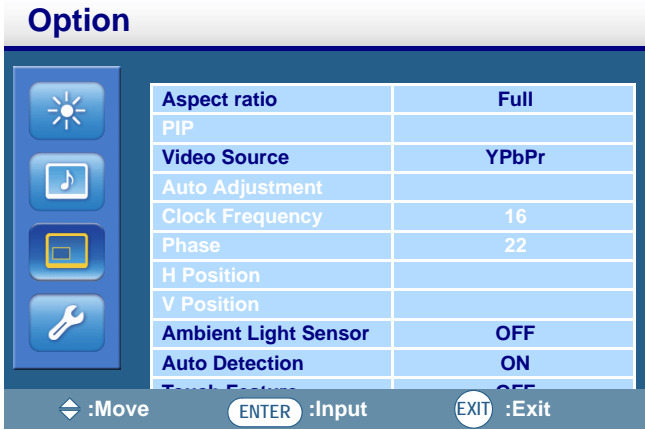

Name	Description
Aspect ratio	Displays the input image in its original aspect ratio (Original) or forces the display to fill the input image on the entire display area (Full).
PIP (Picture in Picture)	<ul style="list-style-type: none"> • ON/OFF: Turns on or off the PIP function. • Main Input: Sets an input source for the main picture. • Sub Input: Sets an input source for the sub picture. • PIP Size: Changes the size of the sub picture. • PIP Position: Changes the position of the sub picture.  <ul style="list-style-type: none"> • This feature is not available for AV and S-Video inputs. • PIP is not available for all signal source combinations. See Supported PIP input signal combination on page 45 for more information on supported combinations. • In PIP mode, only sounds from the Main Input picture will be available.
Video Source	Sets the video input source.
Auto Adjustment	Automatically optimizes image display for the VGA input.
Clock Frequency	Adjusts the clock frequency of the VGA or YPbPr input image.
Phase	Adjusts the phase of the VGA or YPbPr input image.
H Position	Adjusts the horizontal position of the VGA input image.
V Position	Adjusts the vertical position of the VGA input image.
Ambient Light Sensor	Adjusts the ambient light sensitivity around the display.
Auto Detection	Automatically detects available input sources.

Touch Feature

When turned on, **Input Resolution, Aspect ratio, PIP, Clock Frequency, Phase, H Position, V Position, Overscan and Display Wall** will be disabled to optimize touch performance.





This feature is only available for **VGA, DVI** and **HDMI** inputs.

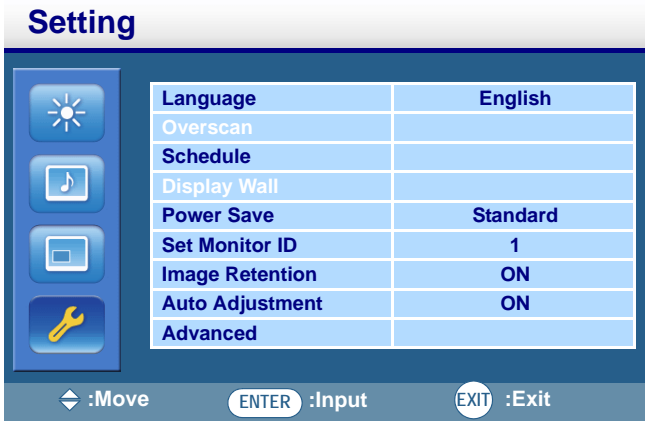

The adjustment of the **Clock Frequency, Phase, H Position** and **V Position** settings is only required when the **Auto Adjustment** function does not work perfectly on certain input signals.

Setting menu



Name	Description
Language	Sets your preferred language for the OSD menu.
Overscan	Turns the HDMI overscan function on or off.
Schedule	<ul style="list-style-type: none"> • Date and Time: Sets the current date and time. • Schedule: Sets when to turn on or off the display and which input source should be used for each schedule.  <ul style="list-style-type: none"> • Set the current time before you set the Schedule. • When schedule settings overlap, the Every Day setting takes priority over other weekly settings. • When schedule settings overlap, scheduled power-on time takes priority over scheduled power-off time. • If two schedules have the same settings, the first schedule on the list will take priority.
Display Wall	<ul style="list-style-type: none"> • H Monitors/V Monitors: Sets the number of displays used in the horizontal/vertical position. • H Position/V Position: Sets the horizontal/vertical position of the display wall matrix. • Frame Comp.: Adjusts images near the display edges for optimal demonstration across the display wall.

Power Save	<p>Sets the display to enter the power saving mode when there is no signal detected.</p> <ul style="list-style-type: none"> • Eco: All source can enter the power saving mode, but only a VGA signal can wake up the display or you have to press the power button to wake up the display when other source is connected. • Standard: All source can enter the power saving mode and wake up the display. • Off: If no source is detected, the backlight will continue on. • VGA Only: Only the VGA signal can enter the power saving mode and wake up the display. <p> Serial can bring any mode out of the power savings.</p>
Set Monitor ID	<p>Assigns an ID number for the current display when multiple displays are connected.</p>
Image Retention	<p>Automatically displays swift moving patterns every 10 seconds to prevent image retention on the screen.</p>
Auto Adjustment	<p>Automatically optimizes image display for the VGA input.</p>
Advanced	<ul style="list-style-type: none"> • Reset User Default: Resets all OSD settings (except the Language setting) to the factory settings. • OSD Info Box: When turned ON, the display will always show the current input source and resolution onscreen. Select OFF to show the information box onscreen only when you press INFO on the remote control. • Status <ul style="list-style-type: none"> - Thermal: Shows current temperature inside the display. - Ambient Light: Shows current ambient brightness around the display. - 5V Detect: Shows the current 5V voltage detection result. - 12V Detect: Shows the current 12V voltage detection result. - Operating Time: Shows the time elapsed since the display was last turned on. D=Day, H=Hour. - FW Version: Shows the current firmware version. - Input Source: Shows the current input source and its resolution.

Product information

Specifications

Item		Specifications	
		T420	TL550
LCD panel	Active area (H x V mm)	930.24 x 523.26	1209.6 x 680.4
	Pixel pitch (mm)	0.4845	0.630 x 0.630
	Native resolution (pixels)	1920 x 1080	1920 x 1080
	Brightness (cd/m ²) (typical)	500	450
	Contrast (typical)	1500:1	1300:1
	Dynamic contrast ratio (DCR)	4000:1	11000:1
	Response time (ms) (typical)	5	12
System	Brightness (cd/m ²) (typical)	440	400
Touch	Technology	Optical Dual Touches (for Win 7 only)	
	Resolution	32767 x 32767	
	Capacity	2 simultaneous touches	
	Accuracy	+/- 5mm over 95% of touchable area	+/- 5.75mm over 95% of touchable area
	Touch Output	USB 2.0	
	PC	Support Windows XP/Vista/7	
Glass	Tempered glass	3.8 mm + 0 mm/-0.3 mm	5 mm + 0 mm/-0.3 mm
Input	Computer	VGA (D-Sub 15-pin), DVI (DVI-D)	
	Video	Composite Video (BNC jacks), S-Video, YPbPr (RCA jacks), HDMI	
	Audio	L/R (RCA jacks), Line-in (3.5 mm Mini-jack)	
	Control	RS-232C (Mini D-Sub 9-pin)	
Output	Computer	VGA (D-Sub 15-pin)	
	Video	Composite Video (BNC jacks)	
	Speaker	External speaker jack (12W+12W, 8 Ohms)	
	Audio	L/R (RCA jacks)	
	Control	RS-232C (Mini D-Sub 9-pin)	
Audio	Audio W (Amp)	12W	12W
	Internal speaker	12W x 2	12W x 2
Power	Supply	100 - 240V AC, 50/60 Hz	
	Consumption Max.	< 210 W	< 185 W
	Consumption Standby	< 0.5 W	< 0.5 W
Environment	Operating Temperature	0 - 40°C, 32 - 104°F	
	Operating Humidity	10 - 90% (without condensation)	
	Storage Temperature	-20 - 60°C, 4 - 140°F	
	Storage Humidity	10 - 95% (without condensation)	

Mechanical	Weight (kg)	30.5 (Approximately)	45.0 (Approximately)
	Dimensions (W x H x D) (mm)	992 x 585 x 128.9	1263.2 x 744.2 x 95



Specifications and functions are subject to change without notice.

Item	Specifications	
T650		
LCD panel	Active area (H x V mm)	1428.48 x 803.52
	Pixel pitch (mm)	0.744
	Native resolution (pixels)	1920 x 1080
	Brightness (cd/m ²) (typical)	500
	Contrast (typical)	5000:1
	Dynamic contrast ratio (DCR)	9000:1
	Response time (ms) (typical)	8
System	Brightness (cd/m ²) (typical)	440
Touch	Technology	Optical Dual Touches (for Win 7 only)
	Resolution	32767 x 32767
	Capacity	2 simultaneous touches
	Accuracy	+/- 6mm over 95% of touchable area
	Touch Output	USB 2.0
	PC	Support Windows XP/Vista/7
Glass	Tempered glass	5 mm + 0 mm/-0.3 mm
Input	Computer	VGA (D-Sub 15-pin), DVI (DVI-D)
	Video	Composite Video (BNC jacks), S-Video, YPbPr (RCA jacks), HDMI
	Audio	L/R (RCA jacks), Line-in (3.5 mm Mini-jack)
	Control	RS-232C (Mini D-Sub 9-pin)
Output	Computer	VGA (D-Sub 15-pin)
	Video	Composite Video (BNC jacks)
	Speaker	External speaker jack (12W+12W, 8 Ohms)
	Audio	L/R (RCA jacks)
	Control	RS-232C (Mini D-Sub 9-pin)
Audio	Audio W (Amp)	12W
	Internal speaker	12W x 2
Power	Supply	100 - 240V AC, 50/60 Hz
	Consumption Max.	< 550 W
	Consumption Standby	< 0.5 W
Environment	Operating Temperature	0 - 40°C, 32 - 104°F
	Operating Humidity	10 - 90% (without condensation)
	Storage Temperature	-20 - 60°C, 4 - 140°F
	Storage Humidity	10 - 95% (without condensation)

Mechanical	Weight (kg)	71 (Approximately)
	Dimensions (W x H x D) (mm)	1522.2 x 889.2 x 145.8

Supported input signal resolution

Resolution	Input source					
	AV	S-Video	YPbPr	VGA	HDMI	DVI
640 x 480 @ 60Hz				○	○	○
640 x 480 @ 72Hz				○	○	○
640 x 480 @ 75Hz				○	○	○
720 x 400 @ 70Hz				○	○	○
800 x 600 @ 60Hz				○	○	○
800 x 600 @ 75Hz				○	○	○
1024 x 768 @ 60Hz				○	○	○
1024 x 768 @ 75Hz				○	○	○
1280 x 768 @ 60Hz				○	○	○
1280 x 960 @ 60Hz				○	○	○
1280 x 1024 @ 60Hz				○	○	○
1360 x 768 @ 60Hz				○	○	○
1366 x 768 @ 60Hz				○	○	○
1600 x 1200 @ 60Hz				○	○	○
1920 x 1080 @ 60Hz				○	○	○
576i (50Hz)	○	○	○		○	
480i (60Hz)	○	○	○		○	
480p (60Hz)			○		○	
576p (50Hz)			○		○	
720p (50Hz)			○		○	
720p (60Hz)			○		○	
1080i (50Hz)			○		○	
1080i (60Hz)			○		○	
1080p (50Hz)			○		○	
1080p (60Hz)			○		○	



- : supported
- Blank: not supported

Supported PIP input signal combination

		Main picture signal source					
		AV	S-Video	VGA	YPbPr	DVI	HDMI
Sub picture signal source	AV	×	×	×	×	×	×
	S-Video	×	×	×	×	×	×
	VGA	×	×	×	×	○	○
	YPbPr	×	×	×	×	○	○
	DVI	×	×	○	○	×	×
	HDMI	×	×	○	○	×	×

		Main picture									
		HDMI									
		1080p (60Hz)	1080p (50Hz)	1080i (60Hz)	1080i (50Hz)	720p (60Hz)	720p (50Hz)	576p (50Hz)	480p (60Hz)	480i (60Hz)	576i (50Hz)
Sub picture											
VGA	640 x 480 @ 60Hz					○	○	○	○	○	○
	640 x 480 @ 72Hz					○	○	○	○	○	○
	640 x 480 @ 75Hz					○	○	○	○	○	○
	720 x 400 @ 70Hz					○	○	○	○	○	○
	800 x 600 @ 60Hz					○	○	○	○	○	○
	800 x 600 @ 75Hz					○	○	○	○	○	○
	1024 x 768 @ 60Hz					○	○	○	○	○	○
	1024 x 768 @ 75Hz					○	○	○	○	○	○
	1280 x 768 @ 60Hz					○	○	○	○	○	○
	1280 x 960 @ 60Hz					○	○	○	○	○	○
	1280 x 1024 @ 60Hz					○	○	○	○	○	○
	1360 x 768 @ 60Hz					○	○	○	○	○	○
	1366 x 768 @ 60Hz					○	○	○	○	○	○
	1600 x 1200 @ 60Hz					○	○	○	○	○	○
	1920 x 1080 @ 60Hz					○	○	○	○	○	○

Troubleshooting

Problem	Solution
No picture	<p>Check the following:</p> <ul style="list-style-type: none"> • Is the display turned on? Check the power indicator of the display. • Is the signal source device turned on? Turn on the device and try again. • Are there any loose cable connections? Make sure that all cables are connected firmly. • Have you chosen an unsupported output resolution on the computer? Refer to Supported input signal resolution on page 44 to select a supported resolution and try again. • Have you chosen an unsupported output resolution on the DVD or Blu-ray disc player? Refer to Supported input signal resolution on page 44 to select a supported resolution and try again.
No sound	<p>Check the following:</p> <ul style="list-style-type: none"> • Have you turned on the mute function on the display or the input source device? Turn off the mute function or increase the audio volume level and try again. • Are there any loose cable connections? Make sure that all cables are connected firmly.
The computer input image looks strange	<ul style="list-style-type: none"> • Have you chosen an unsupported output resolution on the computer? Refer to Supported input signal resolution on page 44 to select a supported resolution and try again. • Use the Auto Adjustment function (See Auto Adjustment on page 36) to let the display automatically optimize the display of computer image. • If the result of the Auto Adjustment function is not satisfactory, use the Clock Frequency, Phase, H Position and V Position functions to manually adjust the image.
The control panel buttons do not work	<p>Have you locked the control panel buttons? Unlock the buttons and try again.</p>

<p>The remote control does not work</p>	<ul style="list-style-type: none">• Have you locked the remote control function? Unlock the function and try again.• Check for incorrect battery orientation.• Check for dead batteries.• Check your distance and angle from the display.• Check whether remote control is properly being pointed at the display's remote control sensor window.• Check for any obstacle between the remote control and the remote control sensor window.• Check that the remote control sensor window is not under strong fluorescent lighting, or in direct sunlight.• Check for any devices (computer or personal digital assistant, PDA) nearby that transmit infrared signals which may cause interference to signal transmission between the remote control and the display. Turn off the infrared function of these devices.
---	--