

# SHARP®

## LC-37GD4U LC-32GD4U LC-26GD4U

LIQUID CRYSTAL TELEVISION  
TÉLÉVISEUR ACL  
TELEVISOR CON PANTALLA DE CRISTAL LIQUIDO

OPERATION MANUAL  
MODE D'EMPLOI  
MANUAL DE OPERACIÓN

# AQUOS

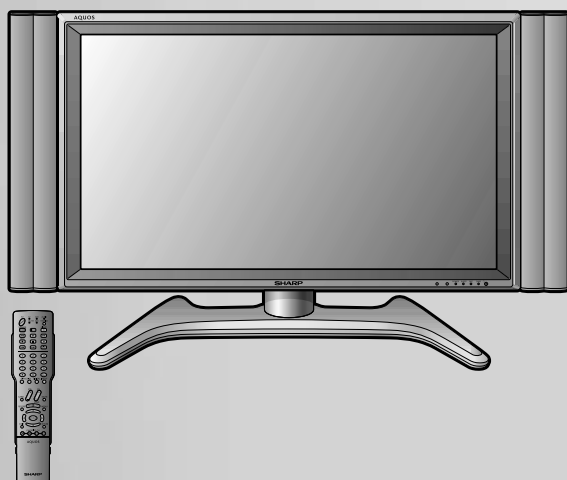

VIRTUAL  
DOLBY  
DIGITAL  
PRO LOGIC II

HDMI

1bit  
Technology

HDTV  
HIGH DEFINITION TELEVISION

PC  
Card

DCR

ENGLISH

FRANÇAIS

ESPAÑOL

# LC-37GD4U LC-32GD4U LC-26GD4U

## LIQUID CRYSTAL TELEVISION

### ENGLISH

#### OPERATION MANUAL

- The illustrations and on-screen displays in this operation manual are for explanation purposes and may vary slightly from the actual operations.
- Some items may be grayed out. They are not selectable.





**IMPORTANT:**

To aid reporting in case of loss or theft, please record the TV's model and serial numbers in the space provided. The numbers are located at the rear of the TV.

Model No.:
Serial No.:

## IMPORTANT INFORMATION

**WARNING: TO REDUCE THE RISK OF FIRE OR ELECTRIC SHOCK, DO NOT EXPOSE THIS PRODUCT TO RAIN OR MOISTURE.**

 <table border="1"><tr><td><b>CAUTION</b></td></tr><tr><td>RISK OF ELECTRIC SHOCK DO NOT OPEN</td></tr></table> 	<b>CAUTION</b>	RISK OF ELECTRIC SHOCK DO NOT OPEN	 <p>The lightning flash with arrow-head symbol, within an equilateral triangle, is intended to alert the user to the presence of uninsulated "dangerous voltage" within the product's enclosure that may be of sufficient magnitude to constitute a risk of electric shock to persons.</p>
<b>CAUTION</b>			
RISK OF ELECTRIC SHOCK DO NOT OPEN			
<p>CAUTION: TO REDUCE THE RISK OF ELECTRIC SHOCK, DO NOT REMOVE COVER (OR BACK). NO USER-SERVICEABLE PARTS INSIDE. REFER SERVICING TO QUALIFIED SERVICE PERSONNEL.</p>	 <p>The exclamation point within a triangle is intended to alert the user to the presence of important operating and maintenance (servicing) instructions in the literature accompanying the product.</p>		

# IMPORTANT INFORMATION

**CAUTION:** TO PREVENT ELECTRIC SHOCK, MATCH WIDE BLADE OF PLUG TO WIDE SLOT, FULLY INSERT.

**CAUTION:**

DO NOT PLACE THIS PRODUCT ON AN UNSTABLE CART, STAND, TRIPOD, BRACKET, OR TABLE. THE PRODUCT MAY FALL CAUSING SERIOUS PERSONAL INJURY AND SERIOUS DAMAGE TO THE PRODUCT. USE ONLY WITH A CART, STAND, TRIPOD, BRACKET, OR TABLE RECOMMENDED BY THE MANUFACTURER OR SOLD WITH THE PRODUCT. FOLLOW THE MANUFACTURER'S INSTRUCTIONS WHEN INSTALLING THE PRODUCT AND USE MOUNTING ACCESSORIES RECOMMENDED BY THE MANUFACTURER. A PRODUCT AND CART COMBINATION SHOULD BE MOVED WITH CARE. QUICK STOPS, EXCESSIVE FORCE, AND UNEVEN SURFACES MAY CAUSE THE PRODUCT AND CART COMBINATION TO OVERTURN.



**WARNING:** FCC Regulations state that any unauthorized changes or modifications to this equipment not expressly approved by the manufacturer could void the user's authority to operate this equipment.

**CAUTION:**

This product satisfies FCC regulations when shielded cables and connectors are used to connect the unit to other equipment. To prevent electromagnetic interference with electric appliances such as radios and televisions, use shielded cables and connectors for connections.

**DECLARATION OF CONFORMITY**

SHARP LIQUID CRYSTAL TELEVISION, MODEL LC-37GD4U  
SHARP LIQUID CRYSTAL TELEVISION, MODEL LC-32GD4U  
SHARP LIQUID CRYSTAL TELEVISION, MODEL LC-26GD4U

This device complies with Part 15 of the FCC Rules. Operation is subject to the following two conditions: (1) This device may not cause harmful interference, and (2) this device must accept any interference received, including interference that may cause undesired operation.

RESPONSIBLE PARTY:

SHARP ELECTRONICS CORPORATION  
Sharp Plaza, Mahwah, New Jersey 07430-2135  
TEL: 1-800-BE-SHARP

For Business Customers: URL <http://www.sharpusa.com>

**INFORMATION:**

This equipment has been tested and found to comply with the limits for a Class B digital device, pursuant to Part 15 of the FCC Rules. These limits are designed to provide reasonable protection against harmful interference in a residential installation. This equipment generates, uses and can radiate radio frequency energy and, if not installed and used in accordance with the instructions, may cause harmful interference to radio communications. However, there is no guarantee that interference will not occur in a particular installation. If this equipment does cause harmful interference to radio or television reception, which can be determined by turning the equipment off and on, the user is encouraged to try to correct the interference by one or more of the following measures:

- Reorient or relocate the receiving antenna.
- Increase the separation between the equipment and receiver.
- Connect the equipment into an outlet on a circuit different from that to which the receiver is connected.
- Consult the dealer or an experienced radio/TV technician for help.

"Note to CATV system installer: This reminder is provided to call the CATV system installer's attention to Article 820-40 of the National Electrical Code that provides guidelines for proper grounding and, in particular, specifies that the cable ground shall be connected to the grounding system of the building, as close to the point of cable entry as practical."

This product utilizes tin-lead solder, and fluorescent lamp containing a small amount of mercury. Disposal of these materials may be regulated due to environmental considerations. For disposal or recycling information, please contact your local authorities or the Electronic Industries Alliance: [www.eia.org](http://www.eia.org)

# DEAR SHARP CUSTOMER

Thank you for your purchase of the Sharp Liquid Crystal Television. To ensure safety and many years of trouble-free operation of your product, please read the **IMPORTANT SAFETY INSTRUCTIONS** carefully before using this product.

## IMPORTANT SAFETY INSTRUCTIONS

Electricity is used to perform many useful functions, but it can also cause personal injuries and property damage if improperly handled. This product has been engineered and manufactured with the highest priority on safety. However, improper use can result in electric shock and/or fire. In order to prevent potential danger, please observe the following instructions when installing, operating and cleaning the product. To ensure your safety and prolong the service life of your Liquid Crystal Television, please read the following precautions carefully before using the product.

- 1) Read these instructions.
- 2) Keep these instructions.
- 3) Heed all warnings.
- 4) Follow all instructions.
- 5) Do not use this apparatus near water.
- 6) Clean only with dry cloth.
- 7) Do not block any ventilation openings. Install in accordance with the manufacturer's instructions.
- 8) Do not install near any heat sources such as radiators, heat registers, stoves, or other apparatus (including amplifiers) that produce heat.
- 9) Do not defeat the safety purpose of the polarized or grounding-type plug. A polarized plug has two blades with one wider than the other. A grounding type plug has two blades and a third grounding prong. The wide blade or the third prong are provided for your safety. If the provided plug does not fit into your outlet, consult an electrician for replacement of the obsolete outlet.
- 10) Protect the power cord from being walked on or pinched particularly at plugs, convenience receptacles, and the point where they exit from the apparatus.
- 11) Only use attachments/accessories specified by the manufacturer.
- 12) Use only with the cart, stand, tripod, bracket, or table specified by the manufacturer, or sold with the apparatus. When a cart is used, use caution when moving the cart/apparatus combination to avoid injury from tip-over.
- 13) Unplug this apparatus during lightning storms or when unused for long periods of time.
- 14) Refer all servicing to qualified service personnel. Servicing is required when the apparatus has been damaged in any way, such as power-supply cord or plug is damaged, liquid has been spilled or objects have fallen into the apparatus, the apparatus has been exposed to rain or moisture, does not operate normally, or has been dropped.
- 15) Power Sources — This product should be operated only from the type of power source indicated on the marking label. If you are not sure of the type of power supply to your home, consult your product dealer or local power company. For products intended to operate from battery power, or other sources, refer to the operating instructions.
- 16) Overloading — Do not overload wall outlets, extension cords, or integral convenience receptacles as this can result in a risk of fire or electric shock.
- 17) Object and Liquid Entry — Never push objects of any kind into this product through openings as they may touch dangerous voltage points or short-out parts that could result in a fire or electric shock. Never spill liquid of any kind on the product.
- 18) Damage Requiring Service — Unplug this product from the wall outlet and refer servicing to qualified service personnel under the following conditions:
  - a) When the AC cord or plug is damaged,
  - b) If liquid has been spilled, or objects have fallen into the product,
  - c) If the product has been exposed to rain or water,
  - d) If the product does not operate normally by following the operating instructions.  
Adjust only those controls that are covered by the operating instructions as an improper adjustment of other controls may result in damage and will often require extensive work by a qualified technician to restore the product to its normal operation,
  - e) If the product has been dropped or damaged in any way, and
  - f) When the product exhibits a distinct change in performance – this indicates a need for service.
- 19) Replacement Parts — When replacement parts are required, be sure the service technician has used replacement parts specified by the manufacturer or have the same characteristics as the original part. Unauthorized substitutions may result in fire, electric shock, or other hazards.
- 20) Safety Check — Upon completion of any service or repairs to this product, ask the service technician to perform safety checks to determine that the product is in proper operating condition.
- 21) Wall or ceiling mounting — When mounting the product on a wall or ceiling, be sure to install the product according to the method recommended by the manufacturer.



# IMPORTANT SAFETY INSTRUCTIONS

- **Water and Moisture** — Do not use this product near water – for example, near a bath tub, wash bowl, kitchen sink, or laundry tub; in a wet basement; or near a swimming pool; and the like.

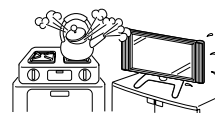

- **Stand** — Do not place the product on an unstable cart, stand, tripod or table. Placing the product on an unstable base can cause the product to fall, resulting in serious personal injuries as well as damage to the product. Use only a cart, stand, tripod, bracket or table recommended by the manufacturer or sold with the product. When mounting the product on a wall, be sure to follow the manufacturer's instructions. Use only the mounting hardware recommended by the manufacturer.



- **Ventilation** — The vents and other openings in the cabinet are designed for ventilation. Do not cover or block these vents and openings since insufficient ventilation can cause overheating and/or shorten the life of the product. Do not place the product on a bed, sofa, rug or other similar surface, since they can block ventilation openings. This product is not designed for built-in installation; do not place the product in an enclosed place such as a bookcase or rack, unless proper ventilation is provided or the manufacturer's instructions are followed.

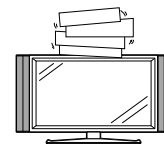

- **The Liquid Crystal panel** used in this product is made of glass. Therefore, it can break when the product is dropped or applied with impact. Be careful not to be injured by broken glass pieces in case the panel breaks.

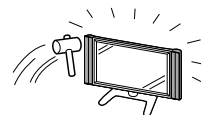

- **Heat** — The product should be situated away from heat sources such as radiators, heat registers, stoves, or other products (including amplifiers) that produce heat.

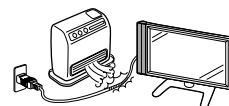

- The Liquid Crystal panel is a very high technology product with 3,147,264 thin film transistors, giving you fine picture details. Occasionally, a few non-active pixels may appear on the screen as a fixed point of blue, green or red. Please note that this does not affect the performance of your product.

## Precautions when transporting the Display

When transporting the Display, never carry it by holding onto the speaker. Be sure to always carry the Display by two people holding it with two hands—one hand on each side of the Display.

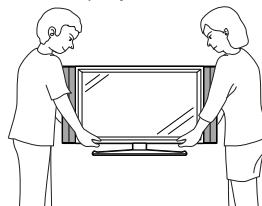

- **Lightning** — For added protection for this television equipment during a lightning storm, or when it is left unattended and unused for long periods of time, unplug it from the wall outlet and disconnect the antenna. This will prevent damage to the equipment due to lightning and power-line surges.

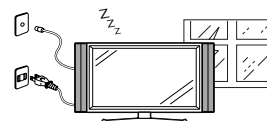

- **Power Lines** — An outside antenna system should not be located in the vicinity of overhead power lines or other electric light or power circuits, or where it can fall into such power lines or circuits. When installing an outside antenna system, extreme care should be taken to keep from touching such power lines or circuits as contact with them might be fatal.



# IMPORTANT SAFETY INSTRUCTIONS

- Outdoor Antenna Grounding — If an outside antenna is connected to the television equipment, be sure the antenna system is grounded so as to provide some protection against voltage surges and built-up static charges. Article 810 of the National Electrical Code, ANSI/NFPA 70, provides information with regard to proper grounding of the mast and supporting structure, grounding of the lead-in wire to an antenna discharge unit, size of grounding conductors, location of antenna-discharge unit, connection to grounding electrodes, and requirements for the grounding electrode.

EXAMPLE OF ANTENNA GROUNDING AS PER NATIONAL ELECTRICAL CODE, ANSI/NFPA 70

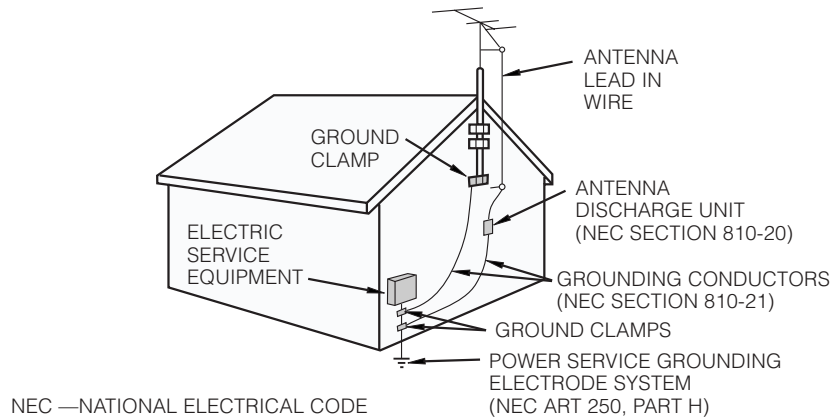

- To prevent fire, never place any type of candle or flames on the top or near the TV set.

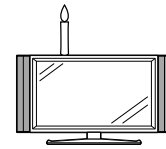

- To prevent fire or shock hazard, do not expose this product to dripping or splashing. No objects filled with liquids, such as vases, should be placed on the product.



- To prevent fire or shock hazard, do not place the AC power cord under the TV set or other heavy items.

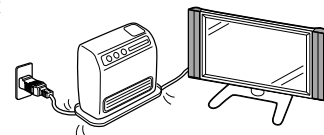

- Turn off the main power and unplug the AC cord from the wall outlet before handling.
- Use a soft cloth and gently wipe the surface of the display panel. Using a hard cloth may scratch the panel surface.
- Use a soft damp cloth to gently wipe the panel when it is really dirty. (It may scratch the panel surface when wiped strongly.)
- If the panel is dusty, use an anti-static brush, which is commercially available, to clean it.
- To protect the panel, do not use a dirty cloth, liquid cleaners or chemical cloth to clean it, such materials may damage the panel surface.

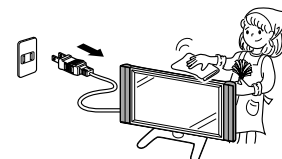

# Contents

<b>IMPORTANT INFORMATION</b> .....	<b>1</b>	Protecting/unprotecting still picture files .....	46
<b>DEAR SHARP CUSTOMER</b> .....	<b>3</b>	Deleting a still image file .....	46
<b>IMPORTANT SAFETY INSTRUCTIONS</b> .....	<b>3</b>	Deleting all still image files .....	46
<b>Contents</b> .....	<b>6</b>	Recording a motion picture .....	47
<b>Trademarks</b> .....	<b>7</b>	Displaying a motion picture .....	47
<b>COPYRIGHT AND LICENSE NOTICE</b> .....	<b>7</b>	Rec. Mode .....	47
<b>Patent Notice</b> .....	<b>7</b>	Pre Record .....	48
<b>Supplied accessories</b> .....	<b>8</b>	Repeat Play .....	48
<b>Preparation</b> .....	<b>9</b>	Protecting/unprotecting motion picture files ...	48
Where to place the TV .....	9	Deleting a motion picture file .....	49
Setting the TV .....	10	Deleting all motion picture files .....	49
Attaching speakers .....	11	Format .....	49
Removing the stand .....	12	<b>Using external equipment</b> .....	<b>50</b>
Setting the Display on the wall .....	12	Displaying an external equipment image .....	50
Inserting the batteries .....	13	Connecting a DVD player .....	51
Using the remote control unit .....	13	Connecting a VCR .....	52
Cautions regarding remote control unit ...	13	Connecting a game console	
<b>Part names</b> .....	<b>14</b>	or camcorder .....	52
Display .....	14	Connecting a Digital TV STB .....	53
Remote control unit .....	16	Connecting HDMI equipment .....	54
<b>Watching TV</b> .....	<b>17</b>	Displaying an image from HDMI	
Antennas .....	17	equipment .....	54
Cable TV converter/VCR connection .....	17	Connecting a PC .....	55
Outdoor antenna connection .....	19	Connecting D-VHS Decks	
Turning on the power .....	20	(i.LINK connection) .....	56
Turning off the power .....	20	About i.LINK .....	56
Initial setup .....	21	i.LINK connection .....	56
Changing channels Analog-TV .....	22	Connecting two or more D-VHS decks ...	56
Changing channels Digital-TV .....	22	Setting the recording mode .....	57
Changing volume/sound .....	23	Setting the Stand-by Mode .....	57
Setting MTS/SAP stereo mode .....	24	Selecting a D-VHS deck (i.LINK) .....	58
Connecting Digital Cable Module .....	25	Disabling the TV's operation of	
<b>Basic adjustment settings</b> .....	<b>26</b>	a D-VHS deck (i.LINK) .....	58
AV input mode menu items .....	26	Deleting a preset D-VHS deck (i.LINK) ...	59
PC input mode menu items .....	26	Controlling an i.LINK device .....	59
EZ setup .....	27	Automatic input switching to i.LINK .....	60
Channel setup .....	28	Recording digital programs	
Favorite channel setting .....	30	with a D-VHS deck (i.LINK) .....	61
Language setting .....	30	<b>Useful adjustment settings</b> .....	<b>62</b>
Antenna Setup-DIGITAL .....	31	Image position (AV input mode only) .....	62
Picture adjustments .....	32	Moving the picture on the screen .....	62
OPC setting .....	33	Connecting external speakers .....	63
C.M.S. (Color Management System) .....	33	Audio Quality Control .....	64
Color temperature .....	34	Auto Sync. adjustment (PC input mode only) ...	65
Black .....	34	Fine Sync. adjustment (PC input mode only) ...	65
3D-Y/C .....	34	Input Select .....	66
Monochrome .....	35	Input label .....	67
Film mode (3:2 pull-down) .....	35	Picture flip .....	67
I/P Setting .....	35	AV MODE .....	68
Sound adjustment .....	36	View mode for 4:3 Programs .....	68
Dolby virtual .....	36	View mode (for PC input mode) .....	69
Power control .....	37	Input signal (for PC input mode) .....	70
Power control for AV source .....	37	Digital Noise Reduction .....	70
Power control for PC source .....	37	Audio only .....	70
Digital Setup .....	38	Output Select .....	71
Video setup .....	38	Quick shoot .....	71
Audio setup .....	39	Sleep timer .....	71
<b>Using memory card</b> .....	<b>40</b>	Title Display Type .....	72
Important notes on using memory card .....	40	Closed caption .....	73
Card Setup mode menu items .....	42	Caption Size .....	74
Recording a still image .....	44	Font Style .....	74
Displaying a still image .....	44	Foreground Color .....	75
Displaying slide show .....	44	Foreground Opacity .....	75
Setting/unprotecting Slide Show .....	45	Background Color .....	75
My Program .....	45	Background Opacity .....	76
Audio Select .....	45	Character Edge .....	76

## Contents

---

Secret number setting for parental control (AV input mode only) .....	77
Parental control (setting V-CHIP level) .....	79
How to temporarily release the V-CHIP BLOCK .....	83
Reactivating the temporarily released V-CHIP BLOCK .....	83
Center Channel Input .....	84
<b>Other viewing options .....</b>	<b>85</b>
Viewing a list of Digital broadcast channels ...	85
Viewing information of the program .....	85
Twin picture functions .....	86
Presetting remote control function .....	86
<b>Appendix .....</b>	<b>92</b>
Troubleshooting .....	92
PC compatibility chart .....	93
RS-232C port specifications .....	94
Specifications .....	96
Optional accessory .....	96
<b>Dimensional drawings .....</b>	<b>97</b>

## Trademarks

---

- Manufactured under license from Dolby Laboratories. “Dolby”, “Pro Logic” and the double-D symbol are trademarks of Dolby Laboratories.

- Manufactured under license from BBE Sound, Inc.  
Licensed by BBE Sound, Inc. under USP4638258, 5510752 and 5736897. BBE and BBE symbol are registered trademarks of BBE Sound, Inc.

- “HDMI, the HDMI logo and High-Definition Multimedia Interface are trademarks or registered trademarks of HDMI Licensing LLC.”

## COPYRIGHT AND LICENSE NOTICE





---

- It is the intent of Sharp that this product be used in full compliance with the copyright laws of the United States and that prior permission be obtained from copyright owners whenever necessary.
- This product incorporates copyright protection technology that is protected by U.S. patents and other intellectual property rights. Use of this copyright protection technology must be authorized by Macrovision, and is intended for home and other limited viewing uses only unless otherwise authorized by Macrovision. Reverse engineering or disassembly is prohibited. U. S. Patent Nos. 4,631,603; 4,577,216; 4,819,098; 4,907,093; 5,315,448; 6,381,747; and 6,516,132.
- This digital television is capable of receiving analog basic, digital basic and digital premium cable television programming by direct connection to a cable system providing such programming. A security card provided by your cable operator is required to view encrypted digital programming. Certain advanced and interactive digital cable services such as video-on-demand, a cable operator’s enhanced program guide and data-enhanced television services may require the use of a set-top box. For more information call your local cable operator.

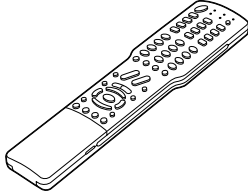

# Supplied accessories

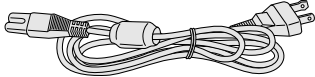
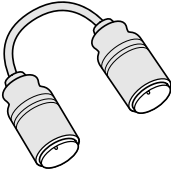
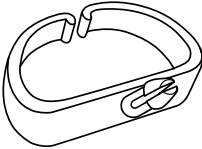
Make sure the following accessories are provided with the product.

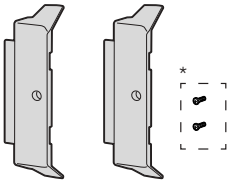
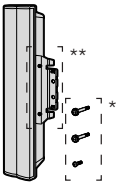
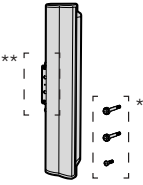
Remote control unit (× 1)	“AAA” size battery (× 2)	AC cord (× 1)
 RRMCGA264WJSA Page 13	 Page 13	 QACCD A019WJPZ Page 10
RF cable (× 1)	Cable clamp (× 1)	Operation manual (× 1)
 QCNW-A342WJZZ Pages 18 and 19	Only included with the LC-32GD4U and LC-37GD4U.  LHLDW0110CEZZ Page 10	 TINS-B241WJZZ
Bracket unit (× 1)	Speaker unit (× 1)	
The LC-26GD4U is shipped with the speakers attached.  LC-37GD4U/LC-32GD4U: GCOVAA856WJKB Page 11	The LC-26GD4U is shipped with the speakers attached.  Left speaker LC-37GD4U: DSP-ZA079UJ07 LC-32GD4U: DSP-ZA076UJ07 Page 11	
	 Right speaker LC-37GD4U: DSP-ZA079UJ08 LC-32GD4U: DSP-ZA076UJ08 Page 11	

\* The parts number for screws

	Parts number	Color	Q'ty
<b>Speaker unit</b>	LX-BZA063WJ01	—	4
	XEBSN40P08000	SILVER	2
<b>Bracket unit</b>	XEBS940P12000	BLACK	2

\*\* The parts number for speaker unit

<b>Angle</b>	LHLDZA375WJKA	—	2
--------------	---------------	---	---

## NOTE

- Always use the AC cord supplied with the LCD-TV.

# Preparation

## Where to place the TV

First select the location where to place the TV.

1

### Selecting the location of the TV

- Select a place with no direct sunlight and good ventilation.

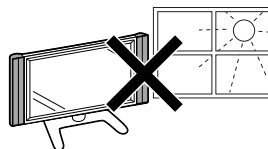

2

### Setting the TV in place

#### Handling the Display



- Do not remove the stand and speaker from the Display unless using an optional bracket to mount it.
- Keep enough space above and behind the Display.
- When you move TV, carry out by two people or more than it.
- When you move the Display, hold the portion of the Display, not the speaker.

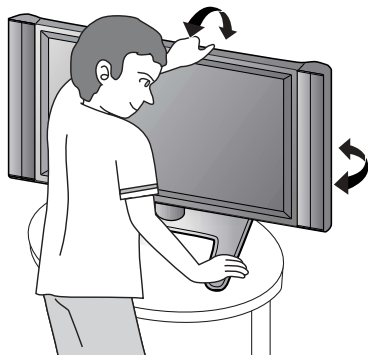
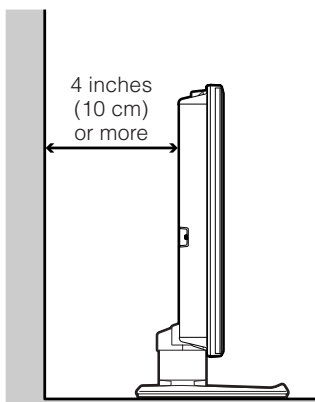

Adjust the screen with both hands. Put one hand on the Display and tilt the screen while steadying the stand with your other hand.

	Maximum Degree of Adjustment		
	Up	Down	Left/Right
LC-37GD4U	6°	2°	10° each
LC-32GD4U	6°	2°	10° each
LC-26GD4U	10°	5°	25° each

## Preparation

### Setting the TV

After putting the Display in place, connect the AC cord. Use the cable clamp for bundling the cables.

#### 1 Removing the terminal cover

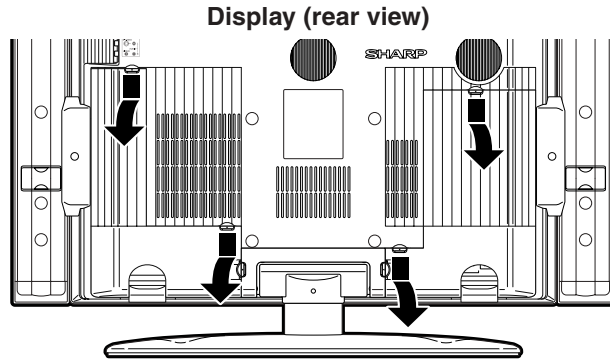

Press down the hooks to remove the cover toward you.

#### 2 Connecting the AC cord to the Display

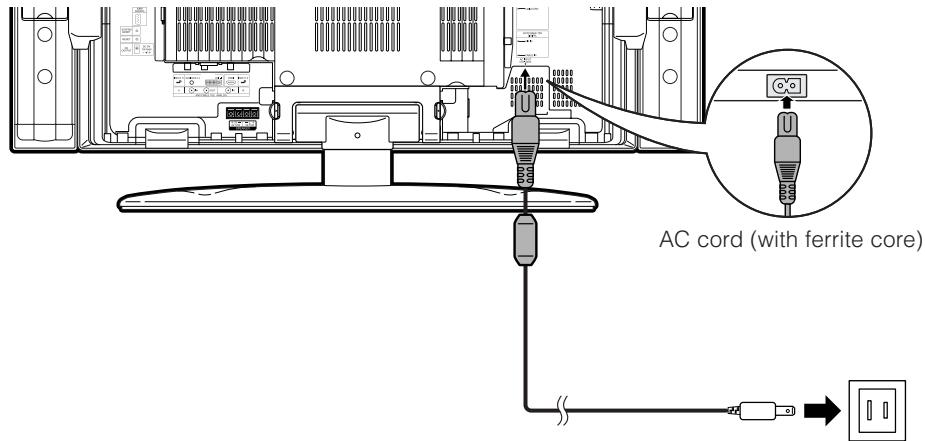

#### 3 Bundling the cables with the clamp

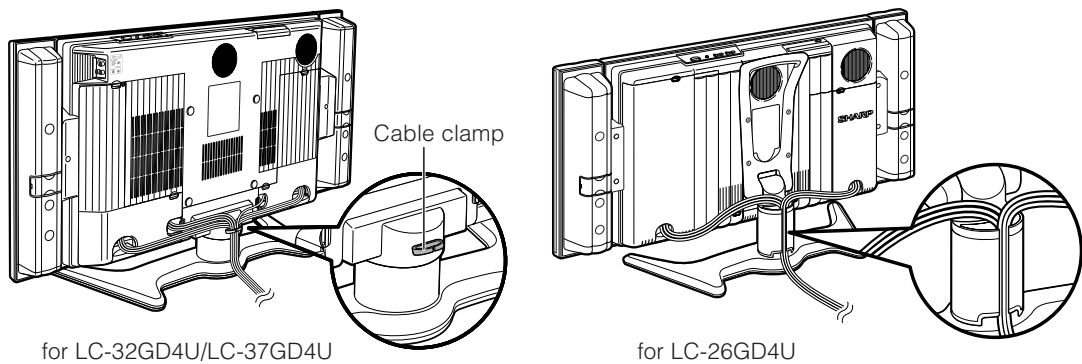

#### CAUTION

- TO PREVENT RISK OF ELECTRIC SHOCK, DO NOT TOUCH UN-INSULATED PARTS OF ANY CABLES WITH THE AC CORD CONNECTED.

## Preparation

### Attaching speakers

The illustration shows the LC-32GD4U.

1

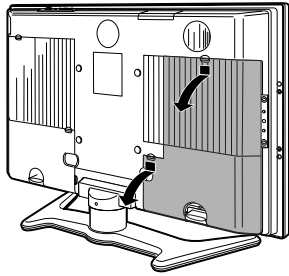

Remove the terminal cover as shown in the illustration.

5

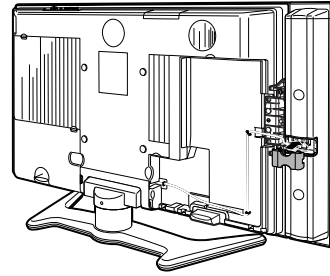

Attach the speaker terminal cover.

2

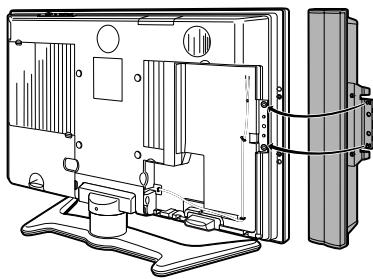

Insert the projecting bulges on the side of the speakers into the corresponding slots in the display.

6

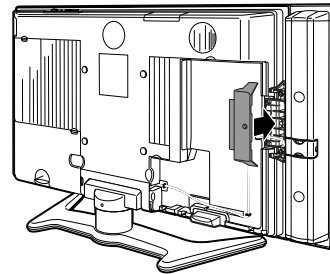

Align nub of the bracket with the groove and slot it into place.

3

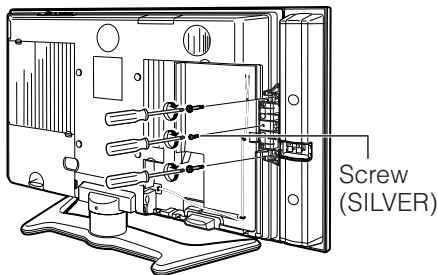

Fasten the screw.

7

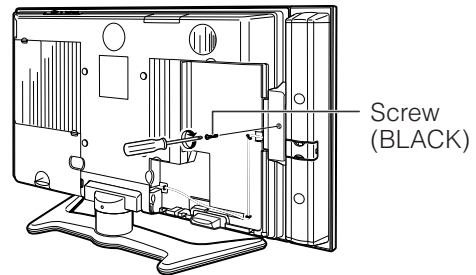

Fasten the bracket with the screw.

4

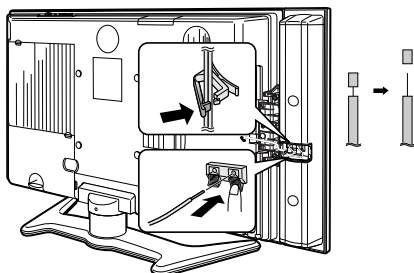

Fasten the speaker cable with the holder. Connect the ends of the cable to the speaker terminals as shown in the illustration.

8

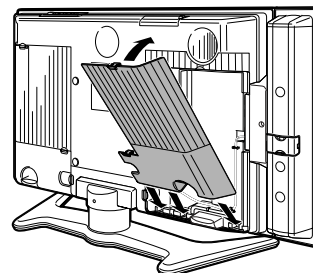

Attach the terminal cover as shown in the illustration.

### CAUTION

- Do not remove the stand and speaker from the Display unless using an optional bracket to mount it.
- Before performing work spread cushioning over the base area to lay the Display on. This will prevent it from being damaged.

### NOTE

- Perform the same steps for right speaker.
- To attach the speakers, perform the steps in reverse order.

## Preparation

### Removing the stand

Before detaching (or attaching) stand, unplug the AC cord from the AC input terminal.

#### CAUTION

- Do not remove the stand from the Display unless using an optional wall mount bracket to mount it.

#### Before attaching/detaching stand

- Before performing work make sure to turn off the TV.
- Before performing work spread cushioning over the base area to lay the Display on. This will prevent it from being damaged.

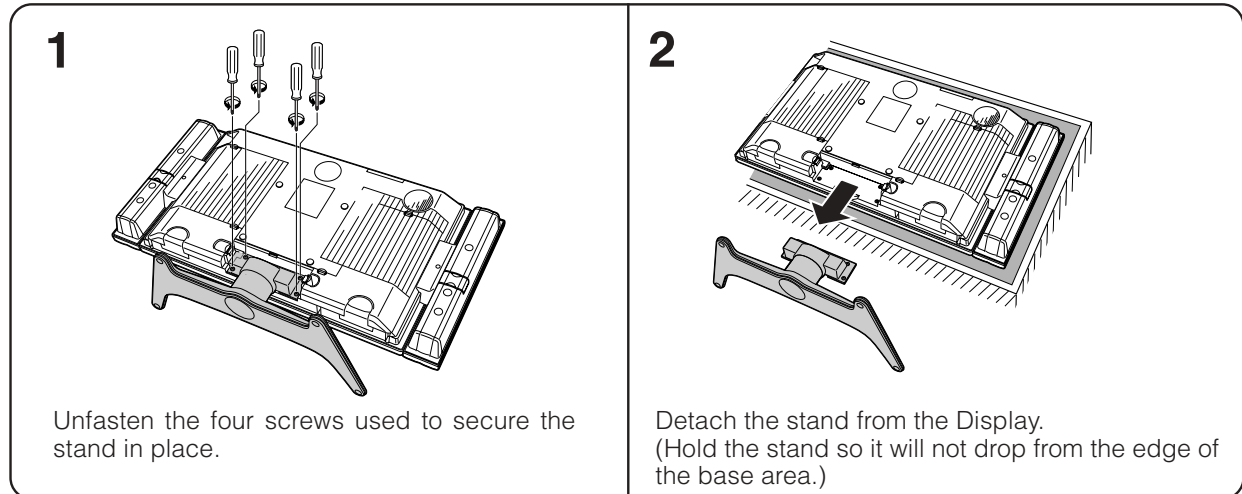

#### CAUTION

- Do not remove the stand and speaker from the Display unless using an optional bracket to mount it.

#### NOTE

- To attach the stand, perform the above steps in reverse order.

### Setting the Display on the wall

#### CAUTION

- Installing the Liquid Crystal Television requires special skill that should only be performed by qualified service personnel. Customers should not attempt to do the work themselves. SHARP bears no responsibility for improper mounting or mounting that results in accident or injury.

#### Using an optional bracket to mount the Display

- You can ask a qualified service personnel about using an optional AN-37AG2 bracket to mount the Display to the wall.
- Carefully read the instructions that come with the bracket before beginning work.

#### Hanging on the wall

AN-37AG2 wall mount bracket. (See the bracket instructions for details.)

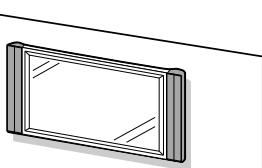

Vertical mounting

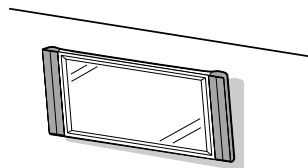

Angular mounting

#### About setting the Display angle

##### LC-37/32/26GD4U

- You can set the Display on the wall up to 20 degrees forward when the speakers are attached and up to 20 degrees forward when the speakers are not attached. Do not set the angle outside those ranges.

	Angle of Display	
	With Speakers Removed	With Speakers Attached
LC-37GD4U	10°	10°
LC-32GD4U	20°	20°

- We do not recommend attaching the LC-26GD4U to a wall surface.

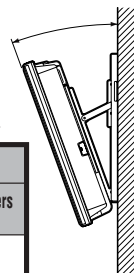

## Preparation

### Inserting the batteries

If the remote control fails to operate Liquid Crystal Television functions, replace the batteries in the remote control unit.

- 1 Open the battery cover.
- 2 Insert two "AAA" size batteries (supplied with the product).
- 3 Close the battery cover.

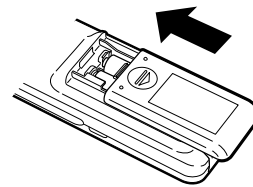
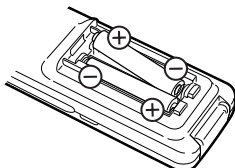
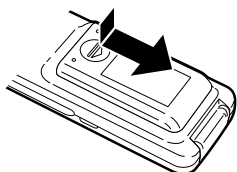

- Place the batteries with their terminals corresponding to the (+) and (-) indications in the battery compartment.

### CAUTION

Improper use of batteries can result in chemical leakage or explosion. Be sure to follow the instructions below.

- Place the batteries with their terminals corresponding to the (+) and (-) indications.
- Do not mix batteries of different types. Different types of batteries have different characteristics.
- Do not mix old and new batteries. Mixing old and new batteries can shorten the life of new batteries or cause chemical leakage in old batteries.
- Remove batteries as soon as they are worn out. Chemicals that leak from batteries can cause a rash. If you find any chemical leakage, wipe thoroughly with a cloth.
- The batteries supplied with this product may have a shorter life expectancy due to storage conditions.
- If you will not be using the remote control unit for an extended period of time, remove batteries from it.

### Using the remote control unit

Use the remote control unit by pointing it towards the remote control sensor on the Display. Objects between the remote control unit and the remote control sensor may prevent proper operation.

### Cautions regarding remote control unit

- Do not expose the remote control unit to shock. In addition, do not expose the remote control unit to liquids, and do not place in an area with high humidity.
- Do not install or place the remote control unit under direct sunlight. The heat may cause deformation of the remote control unit.
- The remote control unit may not work properly if the remote control sensor on the Display is under direct sunlight or strong lighting. In such cases, change the angle of the lighting or the Display, or operate the remote control unit closer to the remote control sensor.

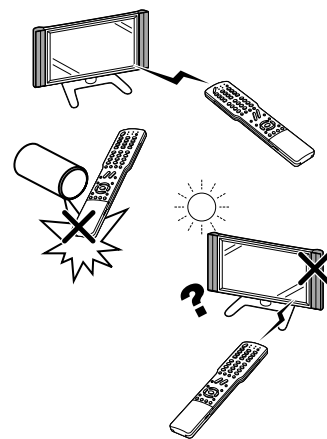

# Part names

## Display

\* The examples use throughout this manual are based on the 32GD4U model.

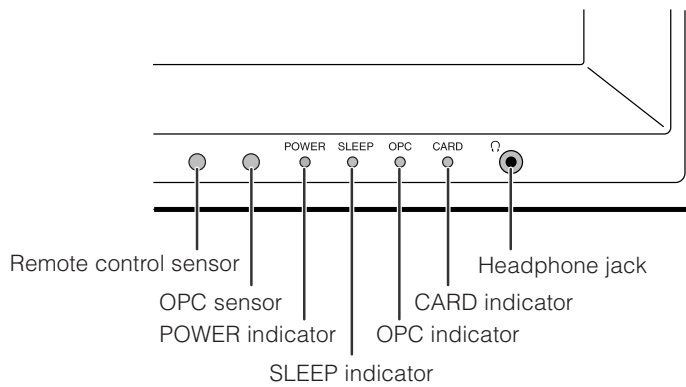
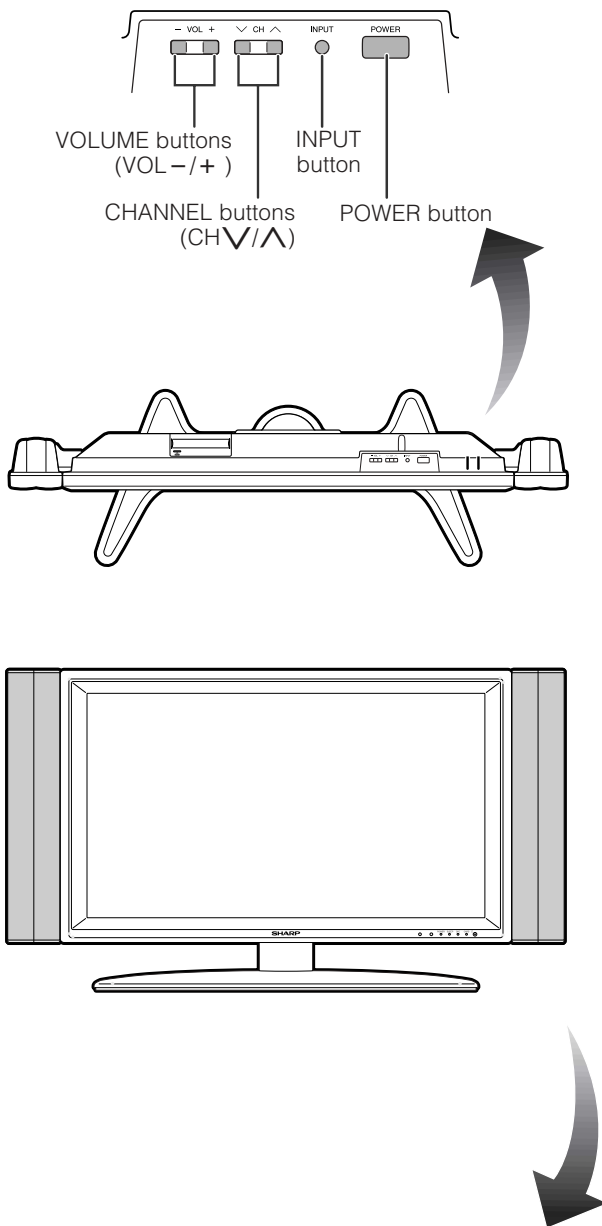

\*OPC: Optical Picture Control  
(See page 33.)

Part names

Display

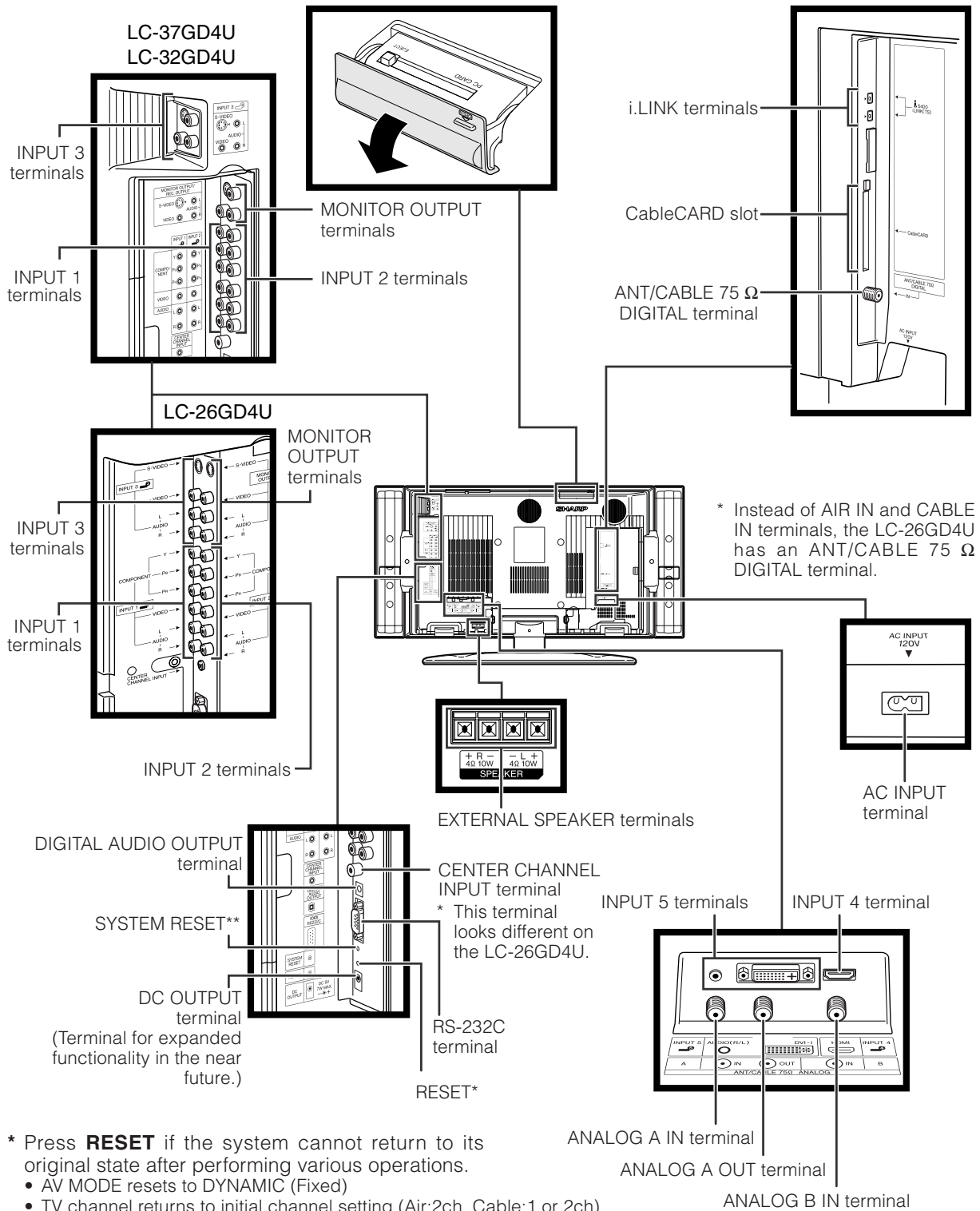

- \* Press **RESET** if the system cannot return to its original state after performing various operations.
  - AV MODE resets to DYNAMIC (Fixed)
  - TV channel returns to initial channel setting (Air:2ch, Cable:1 or 2ch)
  - Twin picture resets to normal
  - Audio setting initializes
  - Dolby virtual resets to off
  - Image position initializes
- \*\* Press **SYSTEM RESET** if the system does not operate after starting up.

**NOTE**

- Pressing **RESET** will not work if the System is in standby mode (indicator lights red).
- Pressing **RESET** will not delete channel preset or secret number. See page 66 for clearing the secret number when you know it. See page 100 for initializing to the factory preset values when you forget your secret number.



Remote control unit

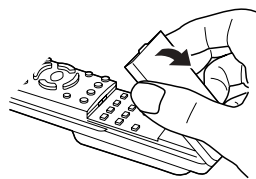
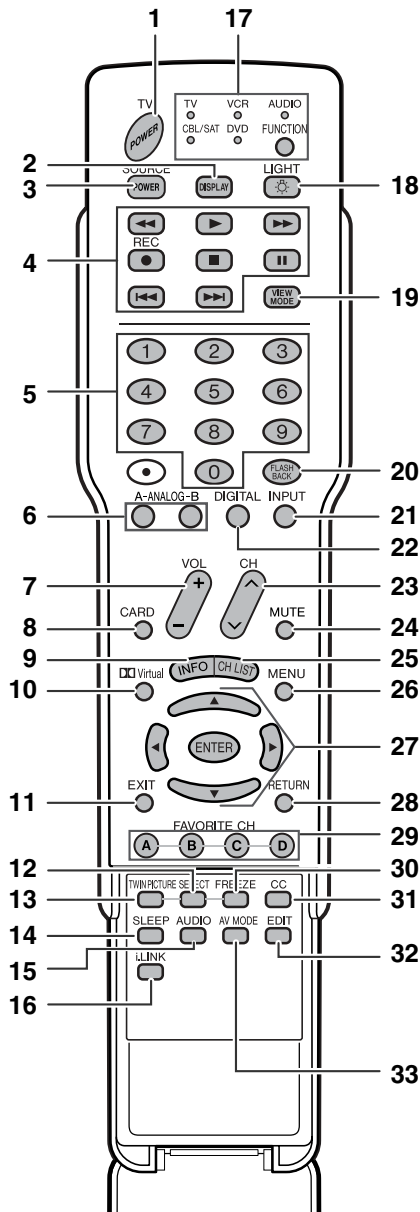

- 1 **TV POWER:** Switches the Liquid Crystal Television power on or Standby. (See page 20.)
  - 2 **DISPLAY:** Displays the channel information.
  - 3 **SOURCE POWER:** Turns the power of the external equipment on and off.
  - 4 **External equipment operational buttons:** Operates the external equipment.
  - 5 **0 – 9:** Sets the channel.
  - 6 **A-ANALOG-B:** Each button selects the corresponding antenna.
  - 7 **VOL +/-:** Sets the volume. (See page 23.)
  - 8 **CARD:** Switches to card mode.
  - 9 **INFO:** Displays the program information screen. (See page 85.)
  - 10 **Virtual:** Select Virtual Dolby Surround settings. (See page 36.)
  - 11 **EXIT:** Turns off the menu screen.
  - 12 **SELECT:** Selects the active screen. (See page 85.)
  - 13 **TWIN PICTURE:** Sets the twin picture mode. Press again to return to normal screen. (See page 86.)
  - 14 **SLEEP:** Sets the sleep timer. (See page 71.)
  - 15 **AUDIO:** Selects the MTS/SAP. (See page 24.)
  - 16 **i.LINK:** Displays the i.LINK panel. (See page 59.)
  - 17 **FUNCTION:** Switches the remote control for TV, CBL/SAT, VCR, DVD and AUDIO operation. Indicator lights up for the current mode. (See page 87 to 91 for details.)
  - 18 **Lighting:** When pressed all buttons on the remote control unit will light. The lighting will turn off if no operations are performed within about 5 seconds. This button is used for performing operations in dark places.
  - 19 **VIEW MODE:** Selects the screen size. (See pages 69 and 71.)
  - 20 **FLASHBACK:** Returns to the previous channel or input external mode. (See page 22.)
  - 21 **INPUT:** Selects a Liquid Crystal Television input source. (TV, INPUT 1, INPUT 2, INPUT 3, INPUT 4, INPUT 5, Card) (See pages 50 and 66.)
  - 22 **DIGITAL:** Receives digital broadcasts.
  - 23 **CH +/-:** Selects the channel.
  - 24 **MUTE:** Mutes the sound. (See page 23.)
  - 25 **CH LIST:** Displays the channel list screen.
  - 26 **MENU:** Displays the menu screen.
  - 27 **Arrow keys:** Selects a desired item on the screen.
  - 28 **RETURN:** Returns to the previous menu screen.
  - 29 **FAVORITE CH**  
**A, B, C, D:** Selects four preset favorite channels in four different categories. (See page 30 for details.)
- While watching, you can toggle the selected channels by pressing A, B, C and D.
- 30 **FREEZE:** Sets the still image. Press again to return to normal screen. (See page 86.)
  - 31 **CC:** Displays captions during closed-caption source. (See page 73.)
  - 32 **EDIT:** Registers favorite channel.
  - 33 **AV MODE:** Selects an audio or video setting. (See page 68.) (AV mode: STANDARD, MOVIE, GAME, USER, DYNAMIC (Fixed), DYNAMIC. PC mode: STANDARD, USER.)

# Watching TV

Simple operations for watching a TV program

## Antennas

To enjoy a clearer picture, use an outdoor antenna. The following is a brief explanation of the types of connections that are used for a coaxial cable. If your outdoor antenna uses a 75-ohm coaxial cable with an F-type connector, plug it into the antenna terminal at the rear of the AVC System.

### NOTE

- The antenna and the cable converter cannot be connected at the same time.

- A 75-ohm system is generally a round cable with F-type connector that can easily be attached to a terminal without tools (Commercially available).
- A 300-ohm system is a flat "twin-lead" cable that can be attached to a 75-ohm terminal through a 300/75-ohm adapter (Commercially available).

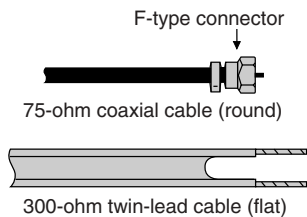

## Cable TV converter/VCR connection

- Be sure to connect the antenna or the cable converter as follows. Signal reception may fail if improperly connected.
- Be sure to remember what kind of connection is made with your System.
- The connection type will determine whether to select "Air" or "Cable" for both ANT-A and B when configuring "Air/Cable" settings.

### A-1. Connecting with cable TV Converter and VCR

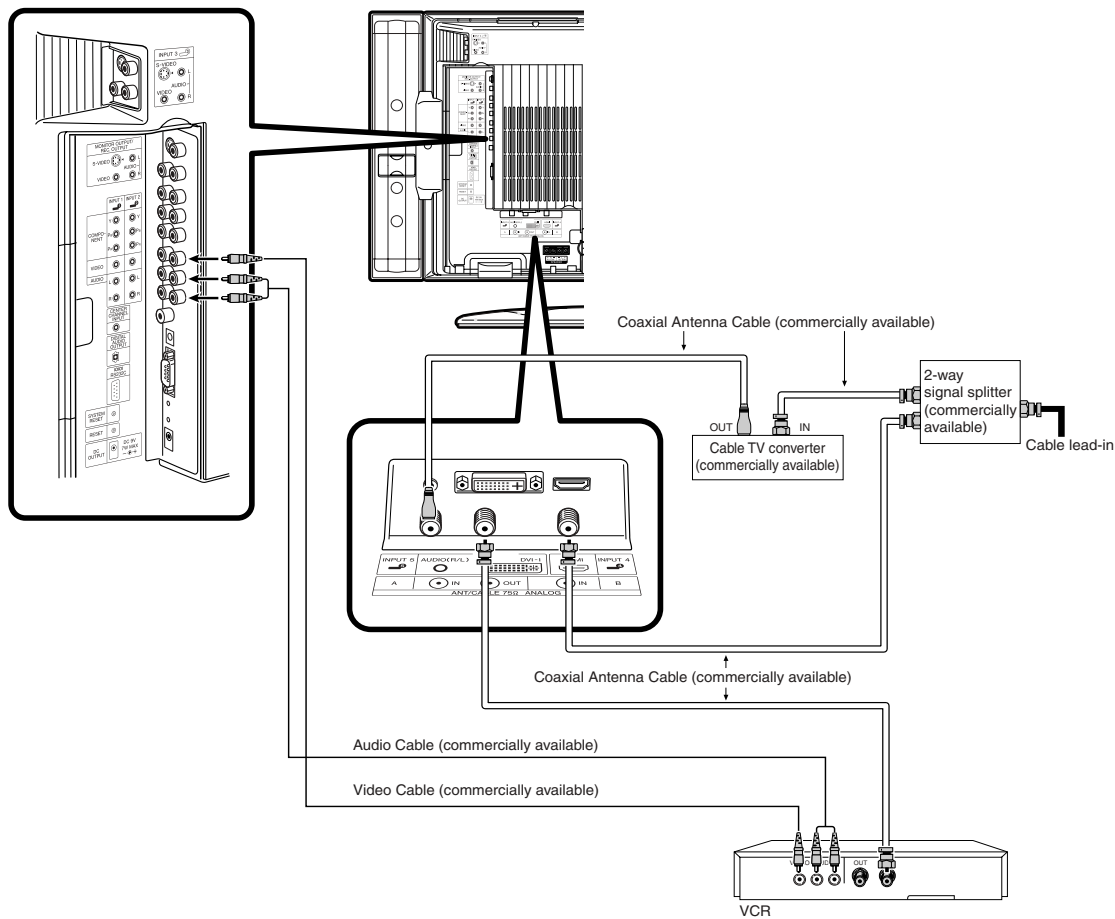

### NOTE

- Be sure to remember what kind of connection is made with your System.
- Shown here is the preferred method of connecting a VCR and CATV Converter to your TV if you are in an area with good signal reception. This way you can view either TV programs or VCR tapes and not be concerned about the position of the VCR's TV/VCR switch and you can enjoy stereo tape playback from a stereo VCR.
- While in STANDBY, no signal outputs from ANT-A OUT.

**Cable converter/VCR connection (continued)**

**A-2. Connecting with cable converter using AUX terminals for audio and video output.**  
 (If your cable TV converter has both RF OUTPUT and AUX terminals, it is recommended to connect it as shown in example A-1.)

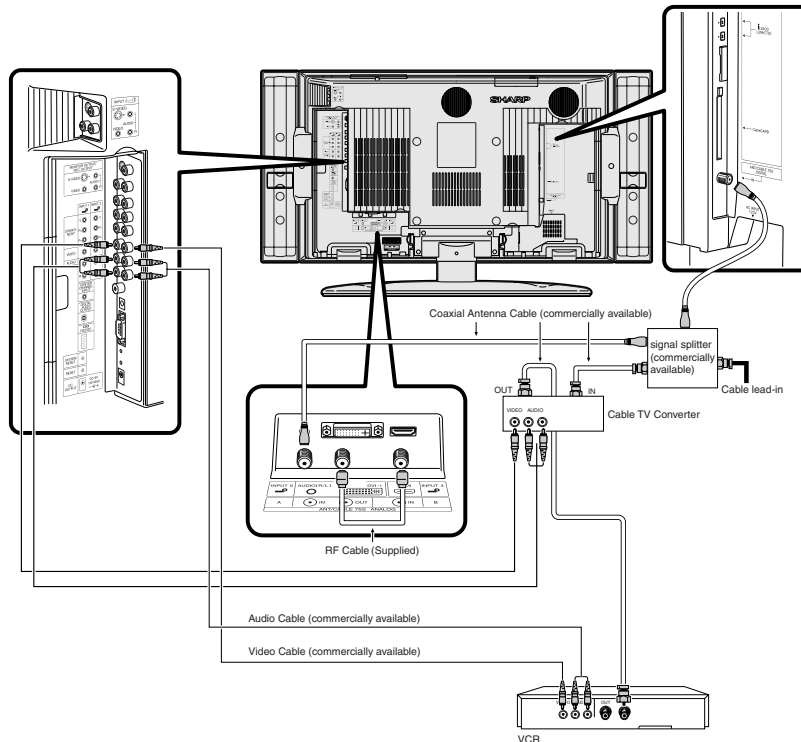

**NOTE**

- Be sure to remember what kind of connection is made with your System.
- Shown here is the preferred method of connecting a VCR and CATV Converter to your TV if you are in an area with good signal reception. This way you can view either TV programs or VCR tapes and not be concerned about the position of the VCR's TV/VCR switch and you can enjoy stereo tape playback from a stereo VCR.

**B. Connecting with Cable Converter without VCR**

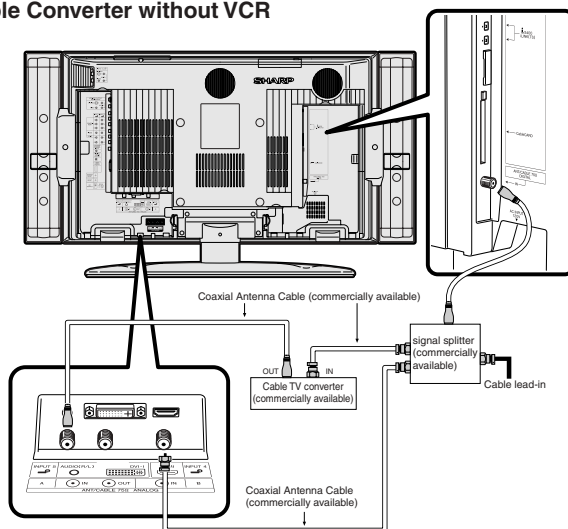

**NOTE**

- Be sure to remember what kind of connection is made with your System.
- Switching between ANALOG-A and ANALOG-B is possible by pressing the **A-ANALOG-B** button on the remote control.
- A good color picture depends on a good TV signal. So does good multi-channel sound. Ask your dealer for advice on how to install your outdoor antenna to receive the best possible signal.
- If you subscribe to Cable TV or have a central antenna for your building, you may not need an outdoor antenna.

**C. Connecting Antenna Cable with VCR**

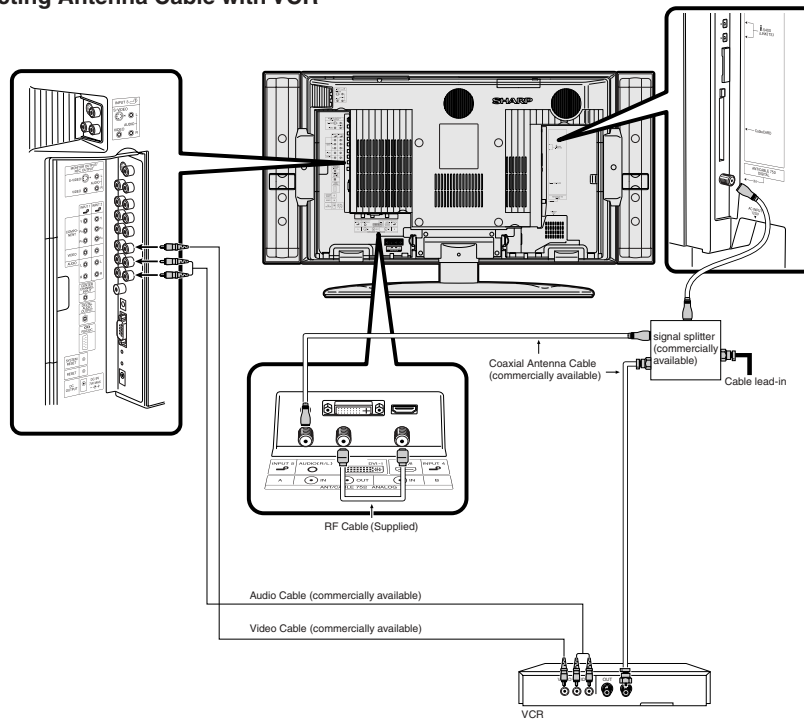

**NOTE**

- Be sure to remember what kind of connection is made with your System.
- Shown here is the preferred method of connecting a VCR to your TV if you are in an area with good signal reception. This way you can view either TV programs or VCR tapes and not be concerned about the position of the VCR's TV/VCR switch and you can enjoy stereo tape playback from stereo VCR.
- If your lead cable is a 300-ohm twin-lead cable or UHF/VHF separate cable, use a 300/75-ohm adapter or combiner (output side is 75-ohm coaxial) to connect to the TV (see below).

**Outdoor antenna connection**

**Connecting Antenna Cable**

Cable without a CATV converter  
Combination VHF/UHF antenna

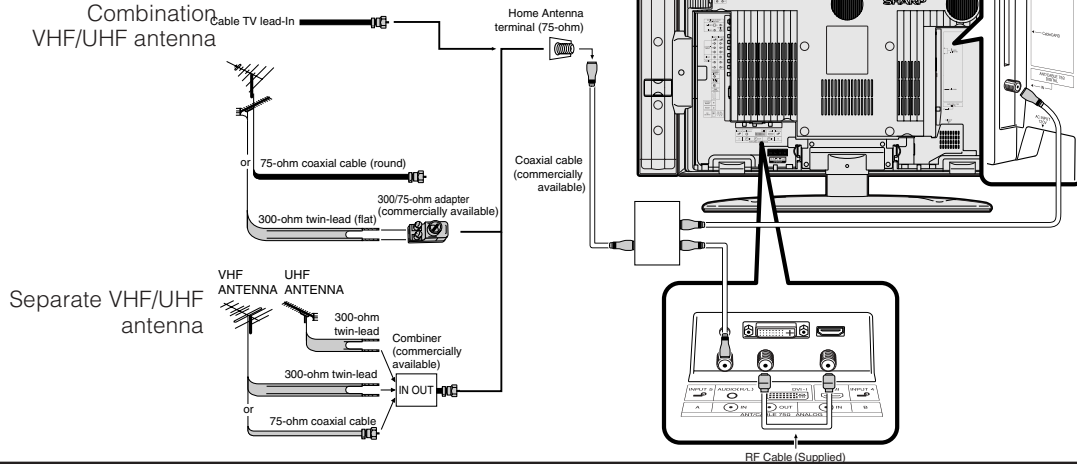

**NOTICE**

F-type connector

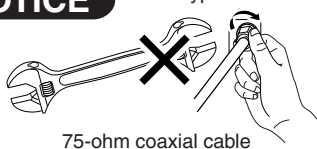

**F-type connector should be finger-tightened only.**

When connecting the RF cable to the TV set, do not tighten F-type connector with tools. If tools are used, it may cause damage to your TV set. (The breaking of internal circuit, etc.)

## Watching TV

### Display

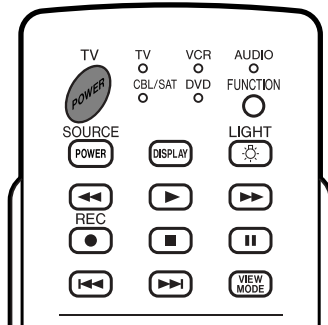
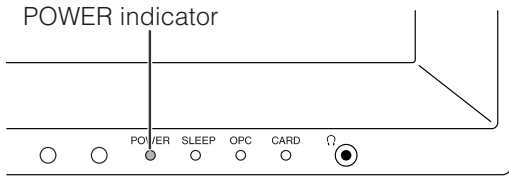
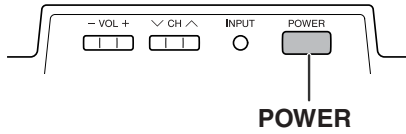

### Turning on the power

Press **POWER** on the Display.

- **POWER indicator (Blue):** The TV is on. (After a few seconds, a window appears with sound.)
- **POWER indicator (Off):** The TV is in standby. Press **TV POWER** on the remote control.

#### NOTE

- The initial setup starts when the TV powers on for the first time. If the TV has been turned on before, the EZ setup will not be invoked. See page XX to try EZ setup from the Setup menu.

### Turning off the power

Press **TV POWER** on the remote control.

- The TV enters standby mode and the image on the screen disappears.
- The **POWER indicator** on the Display gradually turns off.

Press **POWER** on the Display.

- The **POWER indicator** on the Display gradually turns off.
- The Power will not turn off unless the AC cord is pulled out from the wall outlet.

#### NOTE

- If you are not going to use this TV for a long period of time, be sure to remove the AC cord from the power outlet.

#### CAUTION

- Please do not unplug the AC cord when the **POWER indicator** is red.

### Display status indicator

		w/o CableCARD	When CableCARD inserted
ON		Lighting (Blue)	Lighting (Blue)
Standby	OFF (Standby)	Lights off	Lights off
	TV Guide On Screen function is downloading data	Lighting (Red)	Lighting (Red)
	CableCARD is downloading data.	—	Lighting (Red)

## Watching TV

### Initial setup

When you turn on the TV for the first time, it will automatically memorize the broadcasting channels where you live. Perform the following steps before you press **TV POWER** on the remote control unit.

1. Insert the batteries into the remote control unit. (See page 13.)
2. Connect the antenna cable to the Display. (See pages 17 to 19.)
3. Plug in the AC cord to the AC outlet. (See page 10.)

### Language setting

Select from among 3 languages: English, French and Spanish.

1

Press  $\blacktriangle/\blacktriangledown$  to select the desired language listed on the screen, and then press **ENTER**.



### Antenna setting

Make sure what kind of connection is made with your TV when selecting "Air" or "Cable" for both ANALOG-A and B.

2

Press  $\blacktriangleleft/\blacktriangleright$  to select "Air" or "Cable" for ANALOG-A, then press  $\blacktriangle/\blacktriangledown$  to move down. Press  $\blacktriangleleft/\blacktriangleright$  to select "Air" or "Cable" for ANALOG-B.

Press  $\blacktriangleleft/\blacktriangleright$  to select "Air" or "Cable" for DIGITAL (Cable), then press  $\blacktriangle/\blacktriangledown$  to move down.

Press **ENTER** to enter the setting.

- This operation makes the System search for both ANALOG-A and B.
- There are 3 kinds of CATV system, including Standard, HRC and IRC. Select the one matches to your TV. Select Auto when you do not know which one to select.

#### Example

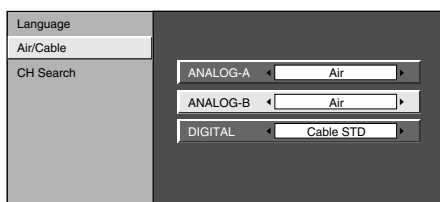
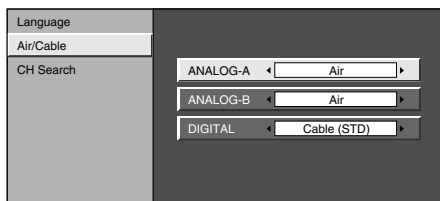

3

### Channel search

Channel auto search makes the System look for all channels viewable in the set area.

Press  $\blacktriangleleft/\blacktriangleright$  to select "Yes" for ANALOG-A, then press  $\blacktriangle/\blacktriangledown$  to move down. Press  $\blacktriangleleft/\blacktriangleright$  to select "Yes" for ANALOG-B, then press  $\blacktriangle/\blacktriangledown$  to move down. Press  $\blacktriangleleft/\blacktriangleright$  to select "Yes" for DIGITAL (AIR/Cable), and press UP/DOWN to move down. Select "Search Start", and then press **ENTER**.

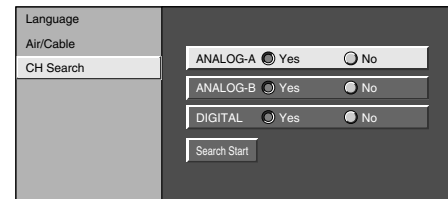

#### Example

#### DIGITAL (Cable)

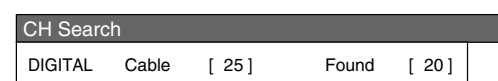
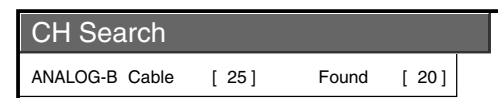
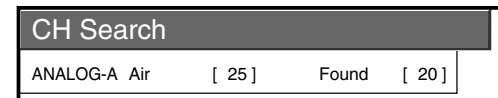

#### NOTE

- Make sure what kind of connection is made with your TV when selecting "Air" or "Cable" for both ANALOG-A, B and DIGITAL.
- If no channel is found, make sure what kind of connection is made with your TV and try EZ setup again (see page 27).

## Watching TV

### Changing channels - Analog-TV

You can change channels in several ways.

#### NOTE

- While watching a broadcast, press **A-ANALOG-B** to view the image received from the other tuner.

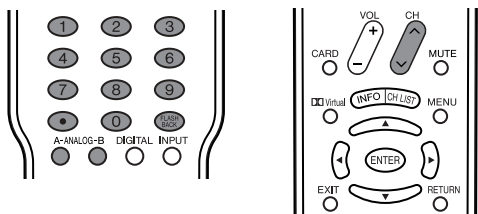

#### Method 1

Using CH $\wedge$ /V on the remote control unit or on the display.

#### Method 2

- Press **FLASHBACK** to switch to the previously tuned channel.
- Press **FLASHBACK** again to switch back to the currently tuned channel.

#### NOTE

- FLASHBACK** will not work if no channel has been changed after TV is turned on.

#### Method 3

Using remote control buttons (0-9 and **ENTER**) to select up to 125 channels for VHF/UHF/CATV.

**To select a 1 or 2-digit channel number (e. g., Channel 5):**

Press 5  $\rightarrow$  **ENTER**



#### NOTE

- Complete the above steps within a few seconds.
- When selecting a 1-digit channel number, it is not necessary to press 0 before the number.
- When you enter 0-9 only, channel selection will be made if there is no operation for 2 seconds.
- (dot) can be used instead of **ENTER**.

**To select a 3-digit channel number (e. g., Channel 69):**

Press 6  $\rightarrow$  9



#### NOTE

- Complete the above steps within a few seconds.
- When you enter 0-9 only, channel selection will be made if there is no operation for 2 seconds.
- If you push "0" by itself, nothing will happen
- (dot) can be used instead of **ENTER**.

### Changing channels - Digital-TV

You can change channels in several ways.

#### NOTE

- While watching a broadcast, press **DIGITAL**.

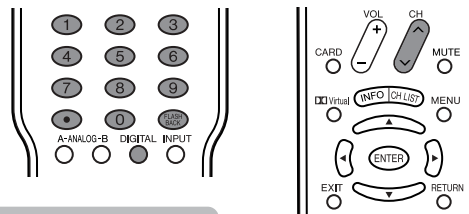

#### Digital - Air/Cable

#### Method 1

When you press CH $\wedge$ /V or **FLASHBACK**, repeat the same steps for Analog-TV.

#### Method 2

1. Using remote control buttons (0-9, • (dot) and **ENTER**) to select the channels including a decimal point.

**To select a 3-digit channel number (e. g., Channel 22.1):**

Press 2  $\rightarrow$  2  $\rightarrow$  •(dot)  $\rightarrow$  1  $\rightarrow$  **ENTER**



#### NOTE

- Complete the above steps within a few seconds.
- When you enter 0-9 and •(dot), channel selection will be made if there is no operation for 2 seconds.
- (dot) can be used instead of **ENTER**.
- When entering a 2-part channel number, pushing •(dot) after the second part of the number has the same function as **ENTER**.

#### Digital - Cable (One-part Number)

#### Method 1

When you press CH $\wedge$ /V or **FLASHBACK**, repeat the same steps for Analog-TV.

#### Method 2

Using remote control buttons (0-9 and **ENTER**) to select the channels including a decimal point.

**To select a 5-digit channel number (e. g., Channel 310):**

Press 3  $\rightarrow$  1  $\rightarrow$  0  $\rightarrow$  **ENTER**

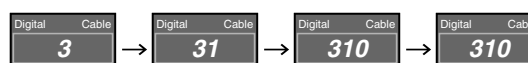

#### NOTE

- Complete the above steps within a few seconds.
- When you enter 0-9 only, channel selection will be made if there is no operation for 2 seconds.
- (dot) can be used instead of **ENTER**.
- Digital Cable Channels are shown by a number with a maximum of 5 digits.

## Watching TV

### Changing volume/sound

#### ■ Changing the volume

You can change the volume on the Display or on the remote control unit.

#### ■ Using VOL +/-

##### Display

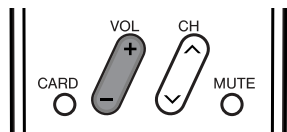
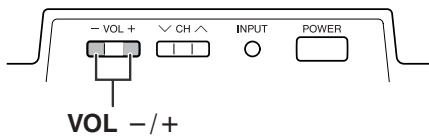

- To increase the volume, press **VOL +**.
- To decrease the volume, press **VOL -**.

#### NOTE

##### Volume adjustment



- **VOL -/+** on the Display operates the same as **VOL +/-** on the remote control unit.

#### Audio status

\* When "Output Select" is set to "Variable", the indicator on the screen changes as shown below.

Output device	Output Select	
	Fixed	Variable
Speaker	Variable sound	Mute
MONITOR OUT	Constant as specified	Variable sound

#### NOTE



- See page XX for details on the output select function.

#### ■ Using MUTE on the remote control unit

Mutes the current sound output.

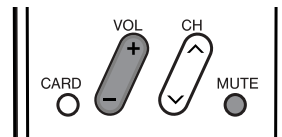

1

Press **MUTE**.

- "Mute" has been displayed on the screen for 30 minutes, and the sound is silenced.

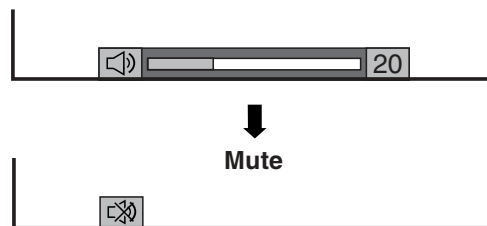

#### NOTE

- Within 30 minutes of pressing **MUTE**, mute can be canceled by using one of the methods below.
  - Mute will cancel if you press **VOL +/-** or **MUTE**.
- Mute will be canceled after 30 minutes have passed. However, the TV will not suddenly output a loud sound as the volume level is set to 0 automatically.



## Watching TV

### Setting MTS/SAP stereo mode

The TV has a feature that allows reception of sound other than the main audio for the program. This feature is called Multi-channel Television Sound (MTS). The TV with MTS can receive mono sound, stereo sound and Secondary Audio Programs (SAP). The SAP feature allows a TV station to broadcast other information, which could be audio in another language or something completely different like weather information.

#### You can enjoy Hi-Fi stereo sound or SAP broadcasts where available.

- **Stereo broadcasts**

View programs like live sporting events, shows and concerts in dynamic stereo sound.

- **SAP broadcasts**

Receive TV broadcasts in either MAIN or SAP sound.

MAIN sound: The normal program soundtrack (either in mono or stereo).

SAP sound: Listen to second language, supplementary commentary and other information. (SAP is mono sound.)

#### If stereo sound is difficult to hear.

- Obtain a clearer sound by manually switching to fixed mono-sound mode.

#### NOTE

- MTS only operates while in TV mode.

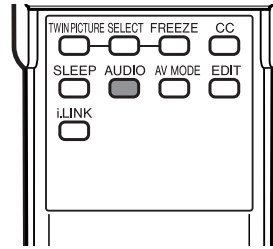

You can change MTS as shown below to match the television broadcast signal.

#### Examples: when receiving MTS and SAP

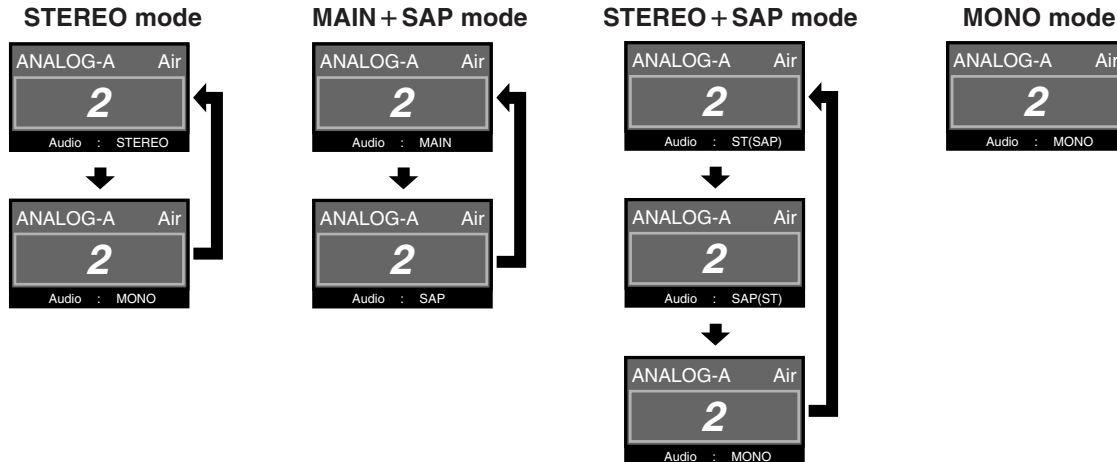

**Connecting Digital Cable Module**

Digital Cable Module is called CableCARD. By attaching the CableCARD, you can receive various digital services provided by your Cable Company. To obtain and use a CableCARD you need to first submit an application. Please contact your cable company to discuss receiving and application. Digital Cable allow you to tune digital and high-definition cable channels through the cable antenna. This module is called the CableCARD.

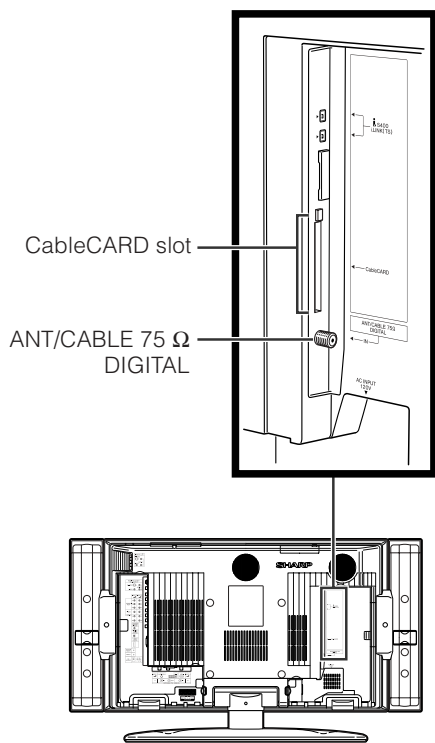

**1**

Turn on the **POWER**.

**2**

Connect the cable antenna to **ANT/CABLE 75 Ω DIGITAL IN**.

**3**

Select "Cable" in "Antenna Setup". (See page 30)

**4**

Insert the CableCARD (upper side facing left) into the **CableCARD slot**.

- A message will appear on the screen. (It might take a couple of minutes before the message appears.) Call the number on the screen and tell the operator the CableCARD ID and Host ID numbers displayed on the screen.

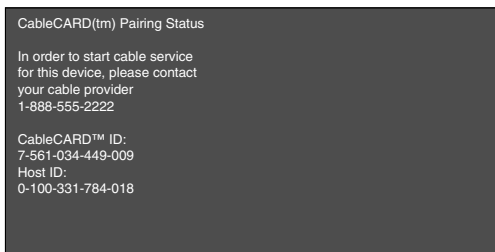

**NOTE**

- Do not insert a PCMCIA card into the CableCARD slot.
  - Please do not pull the AC cord out while the CableCARD is inserted.
- If the above procedure does not work, please follow the following steps instead.**

**1**

Press **MENU** and the MENU screen appears.

**2**

Press **◀/▶** to select "Digital Setup", **▲/▼** to select "CableCARD MENU", **▲/▼** to select "Pairing Information", and then press **ENTER**.

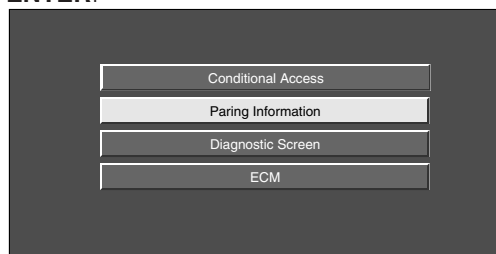

- The words "Pairing Information" may be replaced by a different expression depending of the manufacturer of the CableCARD.

**3**

A message will appear on the screen. Call the number on the screen and tell the operator the CableCARD ID and Host ID numbers displayed on the screen.

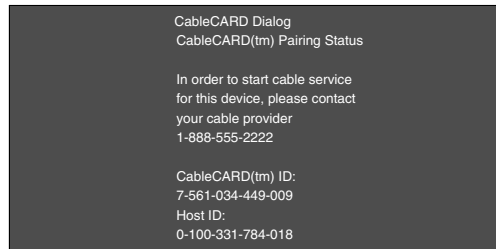

- If there is a white triangle at the right side of the screen, the screen is not showing the entire message. Press **▲/▼** on your remote control to display the rest of the message.
- When there is a "LINK" button on the screen, there is a link to the next page. Press **ENTER** to go to the next page.

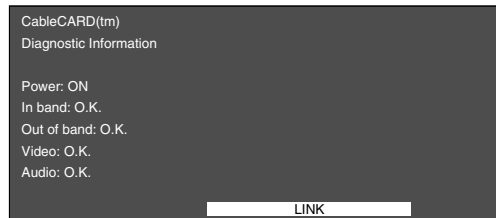

**Removing CableCARD**

- Turn on the **POWER**.
- Check that the CableCARD upgrade screen is not displayed. If it is displayed, wait until it disappears.
- Remove the cableCARD.

**Disconnecting the cable antenna**

- Turn on the **POWER**.
- Check that the CableCARD upgrade screen is not displayed. If it is displayed, wait until it disappears.
- Disconnect the cable antenna.

# Basic adjustment settings

## AV input mode menu items

List of AV menu items to help you with operations

### Picture

OPC .....	Page 33
Backlight .....	Page 32
Contrast .....	Page 32
Brightness .....	Page 32
Color .....	Page 32
Tint .....	Page 32
Sharpness .....	Page 32
Advanced	
C.M.S. ....	Page 33
Color Temp. ....	Page 33
Black .....	Page 34
3D-Y/C .....	Page 34
Monochrome .....	Page 35
Film Mode .....	Page 35
I/P Setting .....	Page 35

### Audio

Treble .....	Page 36
Bass .....	Page 36
Balance .....	Page 36
Dolby Virtual .....	Page 36

### Power Control

No Signal Off .....	Page 37
No Operation Off .....	Page 37

### Setup

EZ Setup .....	Page 27
CH Setup .....	Pages 28-29
Antenna Setup-DIGITAL .....	Page 31
Speaker Setup .....	Page 64
Input Label .....	Page 64
Parental CTRL .....	Pages 79-83
Position .....	Page 62
Picture Flip .....	Page 64
Language .....	Page 30

### Option

Audio Only .....	Page 70
Digital Noise Reduction .....	Page 70
HDMI Setup .....	Page 54
Input Select .....	Page 66
Output Select .....	Page 71
Quick Shoot .....	Page 71
Center Channel Input .....	Page 84
Caption Setup .....	Page 73-75
Title Display Type .....	Page 72

### Digital Setup

CableCARD Menu .....	Page 25
Video Setup .....	Page 38
Audio Setup .....	Page 39
i.LINK Setup .....	Page 58

## \*PC input mode menu items

List of PC menu items to help you with operations

\*When INPUT4 is set to PC.

### Picture

OPC .....	Page 33
Backlight .....	Page 32
Contrast .....	Page 32
Brightness .....	Page 32
Red .....	Page 32
Green .....	Page 32
Blue .....	Page 32
Advanced	
C.M.S. ....	Page 33

### Audio

Treble .....	Page 36
Bass .....	Page 36
Balance .....	Page 36
Dolby Virtual .....	Page 36

# Basic adjustment settings

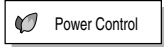

**Power Management ..... Page 37**

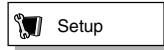

**Speaker Setup ..... Page 64**  
**Input Signal ..... Page 70**  
**Auto Sync. .... Page 65**  
**Input Label ..... Page 67**  
**Fine Sync. .... Page 65**  
**Picture Flip ..... Page 64**  
**Language ..... Page 30**

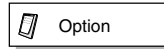

**Audio Only ..... Page 70**  
**Input Select..... Page 66**  
**Output Select..... Page 71**  
**Quick Shoot ..... Page 71**  
**Center Channel Input ..... Page 84**



**i.LINK Setup..... Page 25**

## EZ setup

You can run EZ Setup again, even after setting up the preset channels.

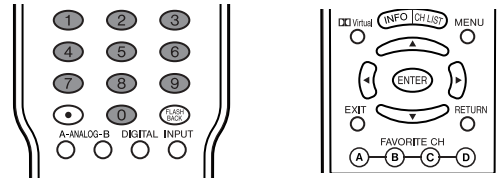

## Language setting

Select from among 3 languages: English, French and Spanish.

**1** Press **MENU** and the MENU screen displays.

**2** Press **◀/▶** to select "Setup".

**3** Press **▲/▼** to select "EZ Setup", and then press **ENTER**.

- If you already set the Secret No., go to step 4. If not, skip to step 5.

**4** Input the 4-digit secret number by using **0 – 9**.

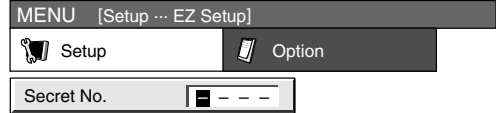

**5** Press **▲/▼** to select the desired language listed on the screen, and then press **ENTER**.



## Basic adjustment settings

### Antenna setting

Make sure what kind of connection is made with your TV when selecting "Air" or "Cable" for ANALOG-A, B and DIGITAL.

6

Press ◀/▶ to select "Air" or "Cable" for ANALOG-A, then press ▲/▼ to move down. Press ◀/▶ to select "Air" or "Cable" for ANALOG-B. Press ◀/▶ to select "Cable (STD)", "Cable (HRC)" or "Cable (IRC)" for DIGITAL (cable).

Press **ENTER** to enter the setting.

- This operation makes the System search for both ANALOG-A and B.
- There are 3 kinds of CATV system, including Standard, HRC and IRC. Select the one matches to your TV. Select Auto when you do not know which one to select.

### Channel search

Channel auto search makes the System look for all channels viewable in the set area.

7

Press ◀/▶ to select "Yes" for ANALOG-A, then press ▲/▼ to move down. Press ◀/▶ to select "Yes" for ANALOG-B, then press ▲/▼ to move down. Press ◀/▶ to select "Cable (STD)", "Cable (HRC)" or "Cable (IRC)" for DIGITAL (cable).

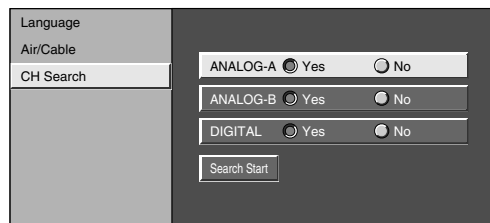

#### Searching TV channels Example

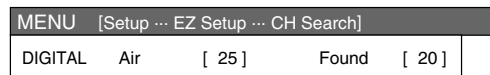
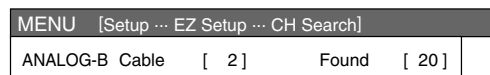
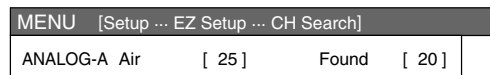

#### NOTE

- If no channel is found, make sure what kind of connection is made with your TV and try EZ setup again.
- Make sure what kind of connection is made with your TV when selecting "Air" or "Cable" for both ANALOG-A and B.

### Channel setup

If initial setup does not memorize all the channels in your region, follow the instructions below to manually memorize the channels.

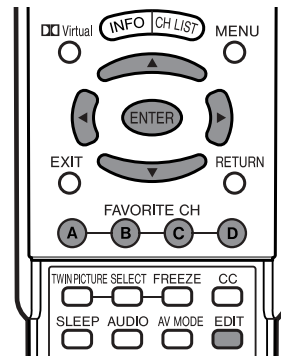

### Antenna setting

1

Press **MENU** and the MENU screen displays.

2

Press ◀/▶ to select "Setup".

3

Press ▲/▼ to select "CH Setup", and then press **ENTER**.

- If you already set the Secret No., input the 4-digit secret number here. See page XX for setting a secret number.

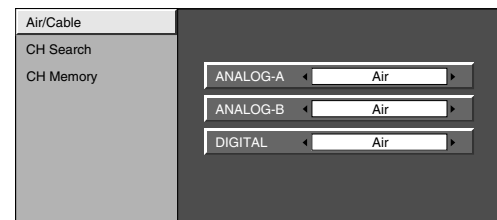

4

Press ▲/▼ to select "Air/Cable", and then press **ENTER**.

5

Press ◀/▶ to select "Air" or "Cable" for ANALOG-A, then press ▲/▼ to move down. Press ◀/▶ to select "Air" or "Cable" for ANALOG-B.

Press ◀/▶ to select "Air" or "Cable" for DIGITAL, then press ▲/▼ to move down. Press **ENTER** to enter the setting.

#### Example

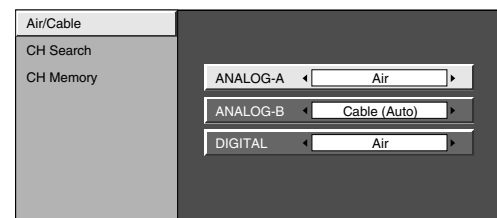

## Basic adjustment settings

### NOTE

- Make sure what kind of connection is made with your TV when selecting "Air" or "Cable" for both ANALOG-A, B and DIGITAL.
- There are 3 kinds of CATV system, including Standard, HRC and IRC. Select the one matches to your TV. Select Auto when you do not know which one to select.

### Channel search

Channel auto search makes the System look for all channels viewable in the set area.

**1** Press **MENU** and the MENU screen displays.

**2** Press **◀/▶** to select "Setup".

**3** Press **▲/▼** to select "CH Setup", and then press **ENTER**.

- If you already set the Secret No., input the 4-digit secret number here. See page 66 for setting a secret number.

**4** Press **▲/▼** to select "CH Search", and then press **ENTER**.

**5** Press **◀/▶** to select "Yes" for ANALOG-A, then press **▲/▼** to move down. Press **◀/▶** to select "Yes" for ANALOG-B, then press **▲/▼** to move down. Press **◀/▶** to select "Yes" for DIGITAL (Air/Cable), and press **▲/▼** to move down. Select "Search Start", and then press **ENTER**.

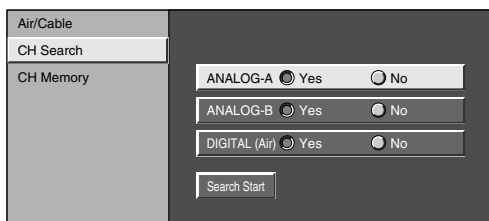

#### Example: CH Search

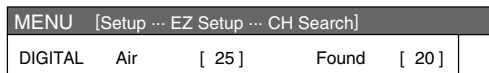
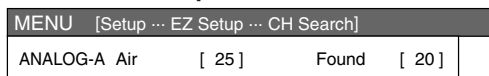

### NOTE

- Make sure what kind of connection is made with your TV.

## Channel memory setting

**1** Press **MENU** and the MENU screen displays.

**2** Press **◀/▶** to select "Setup".

**3** Press **▲/▼** to select "CH Setup", and then press **ENTER**.

- If you already set the Secret No., input the 4-digit secret number here. See page 66 for setting a secret number.

**4** Press **▲/▼** to select "CH Memory-ANALOG" or "CH Memory-DIGITAL", and then press **ENTER**.

### Example

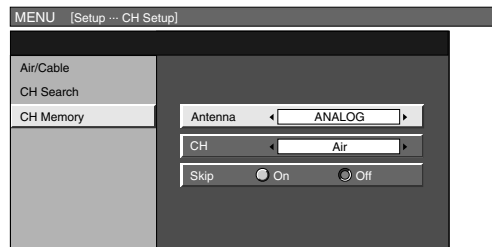

**5** Press **◀/▶** to select ANALOG-A, B or DIGITAL.

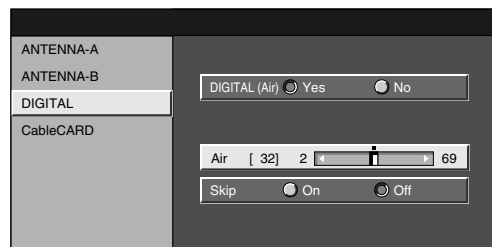

**6** Press **▲/▼** and press **◀/▶** to select the channel you want to skip or not.

**7** Press **▲/▼** to select "Skip", and press **◀/▶** to select "On" or "Off".

- On: Skips channels. (Channel selection disabled using **CH▲/▼**.)
- Off: Does not skip channels. (Channel selection enabled using **CH▲/▼**.)

### NOTE

- Make sure what kind of connection is made with your TV.

## Basic adjustment settings

### Favorite channel setting

This function allows you to program 4 favorite channels, in 4 different categories. By setting the favorite channels in advance, you can select your favorite channels easily.

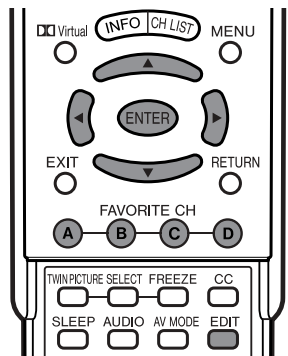

**1** Select the channel you want to register as a favorite channel.

**2** Press **EDIT**.

**3** Press **▲/▼** to select “Register”, and then press **ENTER**.

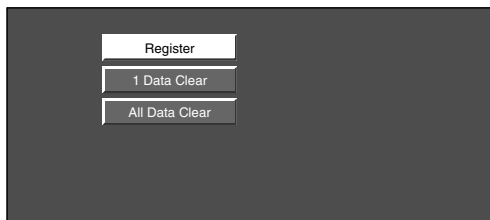

**4** Press **▲/▼/◀/▶** to select the position in the area, and then press **ENTER** to register.

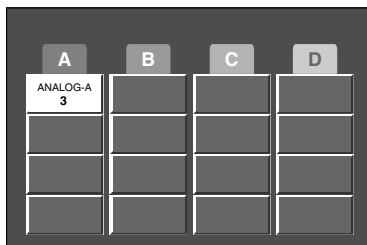

### Delete favorite channel

**1** Press **EDIT** and the favorite channel screen displays.

**2** Press **▲/▼** to select “1 Data Clear”, and then press **ENTER**.

**3** Press **▲/▼/◀/▶** to select the channel you want to delete, and then press **ENTER**.

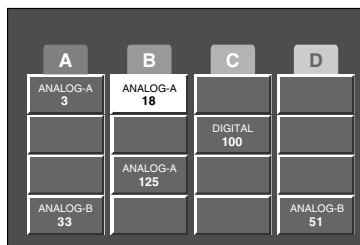

**4** Press **◀/▶** to select “Yes”, and then press **ENTER**.

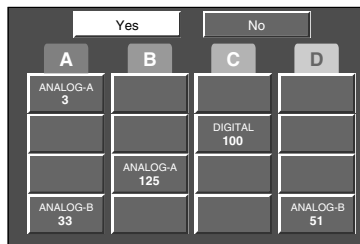

### NOTE

- You can delete all the favorite channels by selecting “All Data Clear” in step 2 in Delete favorite channel.

### Language setting

You can also select a language from the Setup menu. Select from among 3 languages: English, French and Spanish.

**1** Press **MENU** and the MENU screen displays.

**2** Press **◀/▶** to select “Setup”.

**3** Press **▲/▼** to select “Language”, and then press **ENTER**.

**4** Press **▲/▼** to select the desired language listed on the screen, and then press **ENTER**.



## Basic adjustment settings

### Antenna Setup - DIGITAL

This function allows you to set the connected digital antenna.

**1** Press **MENU** and the MENU screen displays.

**2** Press **◀/▶** to select “Setup”.

**3** Press **▲/▼** to select “Antenna Setup - DIGITAL”, and then press **ENTER**.

- If you already set the Secret No., input the 4-digit secret number here. See page 77 for setting a secret number.

**4** Press **▲/▼** to select “Ant. Power Setup”, and press **ENTER**.

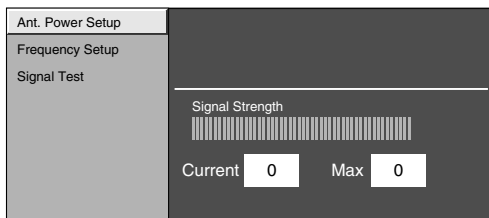

When the Label indicator is max, press **ENTER**.

**5** Press **▲/▼** to select “Frequency Setup”, and then press **ENTER**.

**6** Press **▲/▼** to select “Signal Test”, and input a channel number using 0-9.

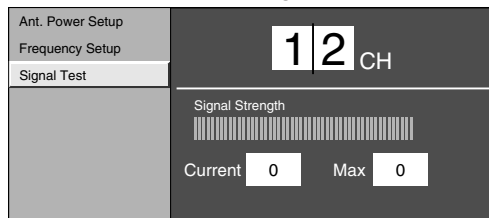



## Basic adjustment settings

### Picture adjustments

Adjusts the picture to your preference with the following picture settings.

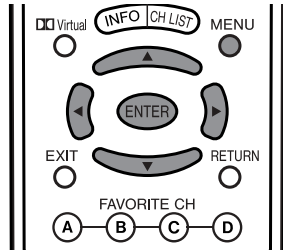

1

Press **MENU** and the MENU screen displays.

2

Press **◀/▶** to select "Picture".

3

Press **▲/▼** to select a specific adjustment item.

4

Press **◀/▶** to adjust the item to your desired position.

#### NOTE

- For resetting all adjustment items to factory preset values, press **▲/▼** to select "Reset", press **ENTER**, press **◀/▶** to select "Yes", and then press **ENTER**.

#### Adjustments items for AV source

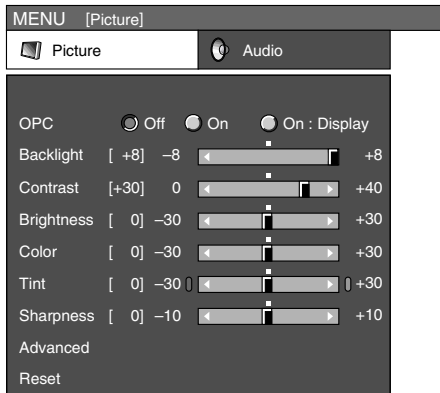

#### Adjustments items for PC source

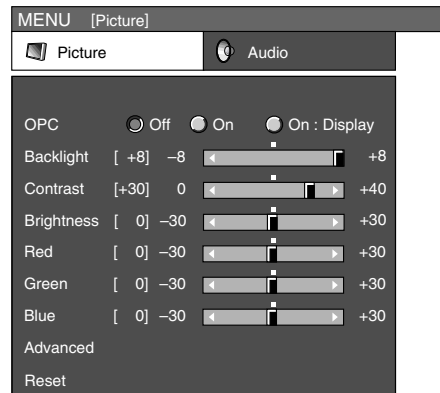

Selected item	◀ button	▶ button
<b>Backlight</b>	The screen dims	The screen brightens
<b>Contrast</b>	For less contrast	For more contrast
<b>Brightness</b>	For less brightness	For more brightness
<b>Color</b>	For less color intensity	For more color intensity
<b>Tint</b>	Skin tones become purplish	Skin tones become greenish
<b>Sharpness</b>	For less sharpness	For more sharpness

#### NOTE

- Select "Advanced" and then press **ENTER** to set "C.M.S-Hue", "C.M.S-Saturation", "C.M.S-Value", "Color Temp.", "Black", "3D-Y/C", "Monochrome", "Film Mode" or "I/P Setting". See pages 33 to 35.

Selected item	◀ button	▶ button
<b>Backlight</b>	The screen dims	The screen brightens
<b>Contrast</b>	For less contrast	For more contrast
<b>Brightness</b>	For less brightness	For more brightness
<b>Red</b>	For weaker red	For stronger red
<b>Green</b>	For weaker green	For stronger green
<b>Blue</b>	For weaker blue	For stronger blue

#### NOTE

- Select "Advanced" and then press **ENTER** to set "C.M.S-Hue", "C.M.S-Saturation" and "C.M.S-Value".

## Basic adjustment settings

### OPC setting

Automatically adjusts the brightness of the screen.

**1** Press **MENU** and the MENU screen displays.

**2** Press **◀/▶** to select "Picture".

**3** Press **▲/▼** to select "OPC".

**4** Press **◀/▶** to select "On" or "On: Display".

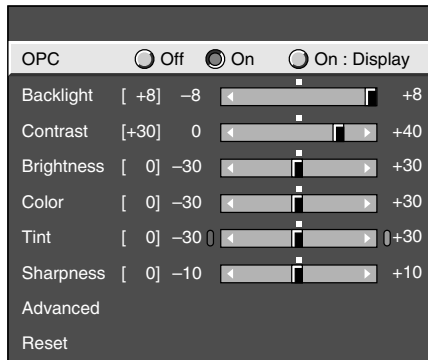

Selected item	Description
<b>Off</b>	The brightness is fixed at the value set in "Backlight" (see page XX).
<b>On</b>	Automatically adjusts
<b>On: Display</b>	Displays the OPC effect on the screen while adjusting the brightness of the screen.

#### NOTE

- When set to "On", the OPC senses the surrounding light and automatically adjusts the backlight brightness. Make sure no object obstructs the OPC sensor, which could affect its ability to sense surrounding light.
- When set to "On: Display", OPC effect displays on the screen while OPC is adjusting the screen brightness.

### C.M.S. (Color Management System)

Color tone is managed using the six-color adjustment setting.

**1** Press **MENU** and the MENU screen displays.

**2** Press **◀/▶** to select "Picture".

**3** Press **▲/▼** to select "Advanced", and then press **ENTER**.

**4** Press **▲/▼** to select "C.M.S.-Hue", and then press **ENTER**.

- You can select "C.M.S.-Saturation" or "C.M.S.-Value" here instead of selecting "C.M.S.-Hue".

**5** Press **▲/▼** to select a specific adjustment item. Press **◀/▶** to adjust the item to your desired position.

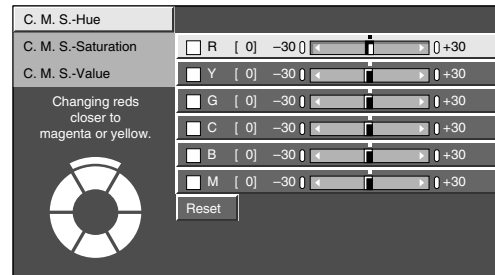

Selected item	Description
<b>C.M.S.-Hue</b>	This is a standard to adjust the color either more reddish or more bluish in tone.
<b>C.M.S.-Saturation</b>	Increases or decreases the saturation of a selected color.
<b>C.M.S.-Value</b>	A higher value makes the image brighter. A lower value makes the image darker.

#### NOTE

- For resetting all adjustment items to the factory preset values, press **▲/▼** to select "Reset", and then press **ENTER**.

## Basic adjustment settings

### Color temperature

For a better white balance, use color temperature correction.

**1** Press **MENU** and the MENU screen displays.

**2** Press **◀/▶** to select "Picture".

**3** Press **▲/▼** to select "Advanced", and then press **ENTER**.

**4** Press **▲/▼** to select "Color Temp.", and then press **ENTER**.



**5** Press **▲/▼** to select the desired level, and then press **ENTER**.

Selected item	Description
High	White with Bluish tone
Mid-High	
Middle	
Mid-Low	
Low	White with Reddish tone

### Black

For easier viewing, change the viewing depth by selecting a level for automatically adjusting the dark portion of an image.

**1** Repeat steps 1 to 3 in **Color temperature**.

**2** Press **▲/▼** to select "Black", and then press **ENTER**.

**3** Press **◀/▶** to select "On", and then press **ENTER**.

Selected item	Description
Off	No adjustment
On	For high detail in black portions

### 3D-Y/C

Provides high quality images with minimal dot crawl and cross color noise.

**1** Repeat steps 1 to 3 in **Color temperature**.

**2** Press **▲/▼** to select "3D-Y/C", and then press **ENTER**.

**3** Press **▲/▼** to select the desired level, and then press **ENTER**.

Selected item	Description
Standard	Normal adjustment
Fast	For movie image
Slow	For still image

### NOTE

- 3D-Y/C is not available for S-video, Component, DVI, HDMI, CARD, DIGITAL-TV or i.Link inputs.

## Basic adjustment settings

### Monochrome

For viewing a video in monochrome.

**1** Press **MENU** and the MENU screen displays.

**2** Press **◀/▶** to select "Picture".

**3** Press **▲/▼** to select "Advanced", and then press **ENTER**.

**4** Press **▲/▼** to select "Monochrome", and then press **ENTER**.

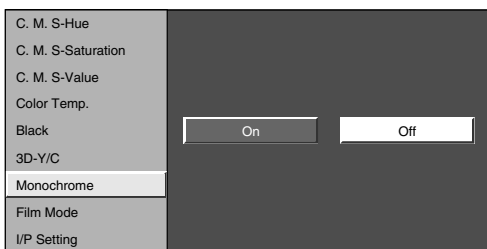

**5** Press **◀/▶** to select "On", and then press **ENTER**.

Selected item	Description
Off	Normal color
On	For viewing in monochrome

### Film mode (3:2 pull-down)

Automatically detects a film-based source (originally encoded at 24 frames/second), analyzes it then recreates each still film frame for high-definition picture quality.

**1** Repeat steps 1 to 3 in **Monochrome**.

**2** Press **▲/▼** to select "Film Mode", and then press **ENTER**.

**3** Press **◀/▶** to select "On", and then press **ENTER**.

Selected item	Description
Off	Normal viewing mode
On	Detects, analyzes, converts film source

### I/P Setting

Adjusting the image and input signal can give you a more beautiful picture.

**1** Repeat steps 1 to 3 in **Monochrome**.

**2** Press **▲/▼** to select "I/P Setting", and then press **ENTER**.

**3** Press **◀/▶** to select "Interlace" or "Progressive", and then press **ENTER**.

#### NOTE

- I/P Setting is set to Progressive when Film Mode is "On".
- "I/P Setting" is not selectable when channel display shows an input resolution of 480P, 720P or 1080I.

## Basic adjustment settings

### Sound adjustment

You can adjust the sound quality to your preference with the following settings.

**1** Press **MENU** and the MENU screen displays.

**2** Press **◀/▶** to select “Audio”.

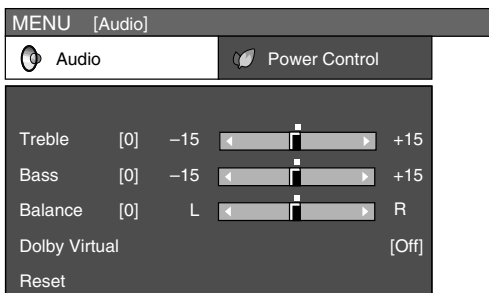

**3** Press **▲/▼** to select a specific adjustment item.

**4** Press **◀/▶** to adjust the item to your desired position.

Selected item	◀button	▶button
<b>Treble</b>	For weaker treble	For stronger treble
<b>Bass</b>	For weaker bass	For stronger bass
<b>Balance</b>	Decrease audio from the right speaker	Decrease audio from the left speaker

#### NOTE

- Audio menu is grayed out when Output Select is set to “Variable” or when headphones are in use.
- Balance and Audio Quality Control are grayed out when Dolby Virtual is set to “On”.
- For resetting all adjustment items to factory preset values, press **▲/▼** to select “Reset”, press **ENTER**, press **◀/▶** to select “Yes”, and then press **ENTER**.

### Dolby virtual

You can enjoy the SURROUND 2ch stereo with Dolby Pro Logic II technology.

VIRTUAL DOLBY DIGITAL is a technology certified by Dolby Laboratories that creates a virtualized surround sound experience from two speakers using Dolby Pro Logic or Dolby Pro Logic II.

VIRTUAL DOLBY DIGITAL retains all the original multichannel audio information and provides the listener with the sensation of being surrounded by additional speakers.

**1** Press **MENU** and the MENU screen displays.

**2** Press **◀/▶** to select “Audio”.

**3** Press **▲/▼** to select “Dolby Virtual”, and then press **ENTER**.

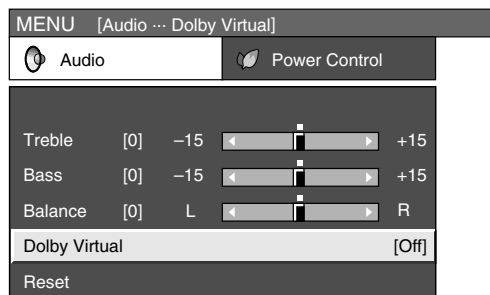

**4** Press **◀/▶** to select “On”, and then press **ENTER**.

#### NOTE

- Audio menu is grayed out when Output Select is set to “Variable” or when headphones are in use.
- Balance and Audio Quality Control are grayed out when Dolby Virtual is set to “On”.
- For some discs, setup may be required on your DVD. In this case, please refer to the operation manual of your DVD player.
- You may not get the Dolby Virtual Surround effect if you adjust “Treble” or “Bass” setting.

## Basic adjustment settings

### Power control

Power control setting allows you to save energy.

#### Power control for AV source

##### No signal off

When set to "Enable", the power will automatically shut down if no signal inputs for 15 minutes.

**1** Press **MENU** and the MENU screen displays.

**2** Press **◀/▶** to select "Power Control".

**3** Press **▲/▼** to select "No Signal Off", and then press **ENTER**.

**4** Press **◀/▶** to select "Enable", and then press **ENTER**.

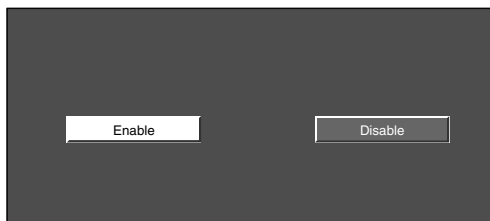

- Five minutes before the power shuts down, remaining time displays every minute.

#### NOTE

- "Disable" is factory preset value.
- When a TV program finishes, this function may not operate.

##### No operation off

When set to "Enable", the power will automatically shut down if there is no operation for 3 hours.

**1** Repeat steps 1 and 2 in **No signal off**.

**2** Press **▲/▼** to select "No Operation Off", and then press **ENTER**.

**3** Press **◀/▶** to select "Enable", and then press **ENTER**.

- Five minutes before the power shuts down, remaining time displays every minute.

#### NOTE

- "Disable" is factory preset value.

### Power control for PC source

Power control setting allows you to save energy.

#### Power management

When set, the power will automatically shut down.

**1** Repeat steps 1 and 2 in **No signal off**.

**2** Press **▲/▼** to select "Power Management", and then press **ENTER**.

**3** Press **▲/▼** to select "Mode1" or "Mode2", and then press **ENTER**.

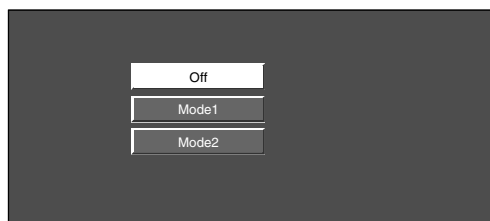

Selected item	Description
<b>Off</b>	<ul style="list-style-type: none"> <li>• No power management</li> <li>• Factory preset value.</li> </ul>
<b>Mode1</b>	<ul style="list-style-type: none"> <li>• If no signal inputs for 8 minutes, the power shuts down.</li> <li>• Even if you start using the PC and the signal inputs again, the TV stays off.</li> <li>• The TV turns on again by pressing <b>TV POWER</b> on the remote control unit. (See page 20).</li> <li>• Press <b>POWER</b> on the display will have the same result.</li> </ul>
<b>Mode2</b>	<ul style="list-style-type: none"> <li>• If no signal inputs for 8 seconds, the power shuts down.</li> <li>• When you start using the PC and the signal inputs again, the TV turns on.</li> </ul>

#### NOTE

- When using a digital PC and setting "Mode2" in Power management, the power may not turn back on automatically even if the signal inputs again.
- If you turn off the power by disconnecting AC cord when setting "Mode2" in power management, the TV may not function properly after turning the power on again. In such case, press **TV POWER** on the remote control unit.
- Press **POWER** on the display will have the same result.

## Basic adjustment settings (DIGITAL)

### Digital Setup

This setting allows you to set the image of Digital broadcasting.

#### Video Setup

You can adjust the settings for Digital image.

#### Screen Size

Set the format of image of Digital broadcasting.

**1** Press **MENU** and the MENU screen displays.

**2** Press **◀▶** to select "Digital Setup".

**3** Press **▲/▼** to select "Video Setup", and then press **ENTER**.

**4** Press **▲/▼** to select "Screen Size", and then press **ENTER**.

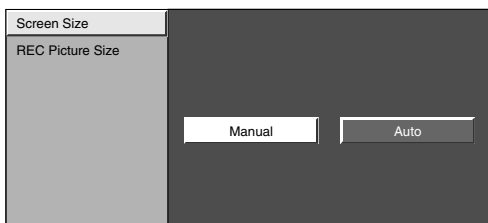

Selected item	Description
<b>Manual</b>	Broadcasts in formats other than 480i will be converted and displayed in the 1080i format. With 480i broadcasts you can change the screen size to the size of your choice.
<b>Auto</b>	All broadcasts will be converted and displayed in the 1080i format.

#### NOTE

- "Manual" is factory preset value.

### REC Picture Size

Select the screen size to record on 16:9 video.

**1** Press **MENU** and the MENU screen displays.

**2** Press **◀▶** to select "Digital Setup".

**3** Press **▲/▼** to select "Video Setup", and then press **ENTER**.

**4** Press **▲/▼** to select "REC Picture Size", and then press **ENTER**.

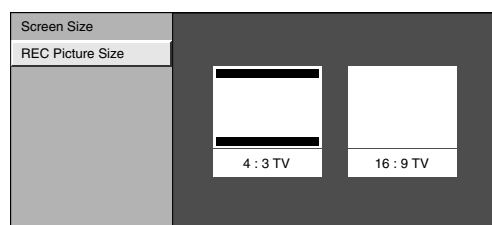

**5** Press **◀▶** to select the desired picture size, and then press **ENTER**.

Selected item	Description
<b>4:3 TV</b>	Bars may appear on the top and bottom with some programmes
<b>16:9 TV</b>	Display the full screen and keep a picture quality

## Basic adjustment settings (DIGITAL)

---

### Audio setup

Select the optical digital audio of Digital broadcasting.

**1** Press **MENU** and the MENU screen displays.

**2** Press ◀/▶ to select “Digital Setup”.

**3** Press ▲/▼ to select “Audio Setup”, and then press **ENTER**.

**4** Press ▲/▼ to select “PCM” or “Dolby Digital”, and then press **ENTER**.

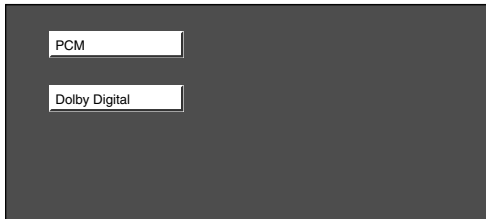

Selected item	Description
<b>PCM</b>	The optical output terminal outputs audio signal by PCM form. If your digital audio system does not support Dolby Digital, select "PCM".
<b>Dolby Digital</b>	The optical output terminal outputs audio signal by Dolby Digital form. It reproduces sound from surround program of digital.



# Using memory card

## Important notes on using memory cards

- We will not be liable for misuse of the LCD TV set, any troubles during use, or other problems, or any damages arising out of the use of the LCD TV set, except for the cases for which we are liable by statute.
- If you or other people misuse the LCD TV set, or the LCD TV set is affected by static electricity or electrical noise, the recorded data may be in danger of being changed or lost.
- If you are making a record of importance, run a test in advance to ensure that the recording would be performed correctly in terms of picture or sound quality.
- We do not capture responsibility nor compensate even if pictures or sound could not be recorded correctly because of troubles.

### Copyright

Duplicating images and music by copying and/or editing from videocassettes and/or TV programs that are subject to copyrights is only permitted when the edited or copied versions are used for personal pleasure. With the exception of cases when the user personally is the owner of the copyrights of the object in question or when specific and written permission has been obtained from the owner(s) of the object in question, the user is not permitted to make copies and/or duplications and/or edited versions as this constitutes a violation of the copyright laws, possibly exposing the user to demands for compensation for damages. Therefore, strictly adhere to the existing copyright laws.

In addition when using image data that includes third parties, the use without prior permission of these images may constitute an intrusion on the privacy of third parties, so strictly refrain from such usage.

## The recording formats

<b>Still picture</b>	<b>Recording/Playback file format</b>	JPEG (DCF compliant)
	<b>Size of a captured still picture</b>	640 × 480 dots
<b>Motion Picture</b>	<b>Recording file format</b>	SP/LP... ASF (Motion Picture: MPEG-4 compliant, Sound: WMA-compliant) EP..... ASF (Motion Picture: MPEG-4 compliant, Sound: G.726-compliant)
	<b>Size of a recorded motion picture/number of frames</b>	SP ... Size: 320 × 240 dots, Frame: approx. 30 frames/sec LP ... Size: 320 × 240 dots, Frame: approx. 30 frames/sec EP ... Size: 320 × 240 dots, Frame: approx. 15 frames/sec
	<b>Playback file format</b>	ASF (Motion Picture: MPEG-4 compliant, Sound: WMA-compliant) ASF (Motion Picture: MPEG-4 compliant, Sound: G.726-compliant)

## Approximate number of recordable pictures/time

Still Pictures

	Picture size	Memory card	
		32MB	128MB
<b>Still picture</b>	640 × 480	Approx. 300 pictures	Approx. 1000 pictures

\* Recordable numbers may vary depending on the receiving condition of the LCD TV set and/or content of images.

Motion pictures

	Picture size	Recording mode	Memory card capacity	
			256MB	5GB
<b>Recordable time</b>	320 × 240	SP	Approx. 10 min.	Approx. 4h.
	320 × 240	LP	Approx. 30 min.	Approx. 10h.
	320 × 240	EP	Approx. 1h.	Approx. 25h.

- Recordable time may vary depending on receiving condition of the LCD TV set or content of images.
- The maximum amount of data you can record on a memory card is 1,024 pictures in total including still and motion pictures.

## Using memory card

You can use memory cards (commercially available) for recording and playing back pictures.

- Please use an appropriate PC card adapter (commercially available) for each memory card.
- Following memory cards are available. (Note that names for memory cards vary depending on manufacturers.)

Memory card name	Storage capacity
SD Memory Card	512 MB or less
mini SD™ Card	32 MB or less
CompactFlash	2 GB or less
MultiMediaCard	128 MB or less
SmartMedia	128 MB or less
Memory Stick	128 MB or less
Memory Stick PRO	1 GB or less
Microdrive	2 GB or less
xD Picture Card	128 MB or less
PC Card Hard Disk	5 GB or less

\* Each memory card name is a trademark.

\* The capacity of memory card is approximate. The capacity varies depending on the manufacturer.

- To read picture files recorded with digital cameras, use the PC card adapter recommended by the corresponding manufacturer. (The names for PC card adapters vary depending on manufacturers.)
- For directions for use of digital cameras or PC card adapters, please refer to the operation manual provided for each product.

You can playback DCF compliant JPEG pictures captured with other devices in the card playback mode.

- DCF (Design rule for Camera File system) is a standard of the Japan Electronics and Information Technology Industries Association (JEITA). This standard specifies the image file format used for images shot with a digital camera.
- Some motion pictures recorded with other devices may not be played back correctly.

## Commercially available memory cards

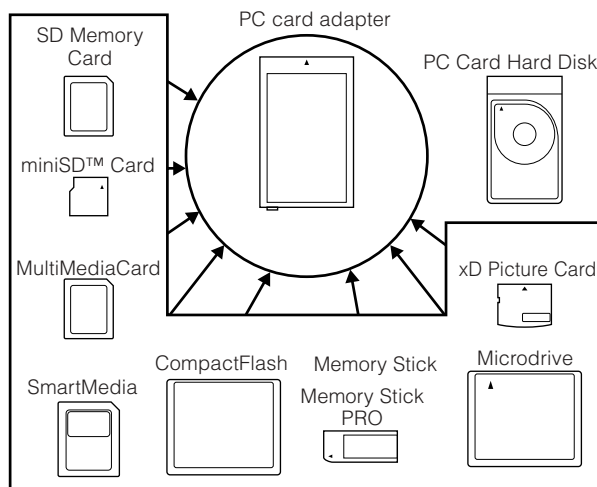

- Please use an appropriate PC card adapter (commercially available) for each memory card.

## Preparing a memory card

Insert a memory card (commercially available) into a PC card adapter (commercially available).

Example:  
Inserting the SD memory card into a PC card adapter.

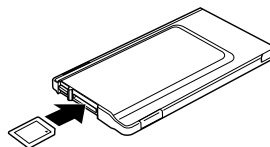

### Notes on using memory cards and PC card adapter

Please note the following when using memory cards and PC card adapters to avoid corruption of data or malfunction of the LCD TV set.

- If you use memory cards other than those shown above, recording or playing back pictures are not guaranteed.
- Some PC card adapters have restrictions of memory card capacity. Refer to the relevant operation manual for such restrictions.
- Some pictures which have been created, modified, or copied on your PC may not be played back.
- Do not bend, drop or apply a shock to memory cards or PC card adapters.
- Keep memory cards or PC card adapters away from heat, water or direct sunlight.
- Do not dismantle or modify memory cards or PC card adapters.
- Refer to the appropriate operation manuals for details on using or keeping memory cards or PC card adapters.
- Do not turn the LCD TV set off while a memory card is in operation (e.g. playing back, recording or displaying a slideshow).

## Using memory card

### Card Setup mode menu items

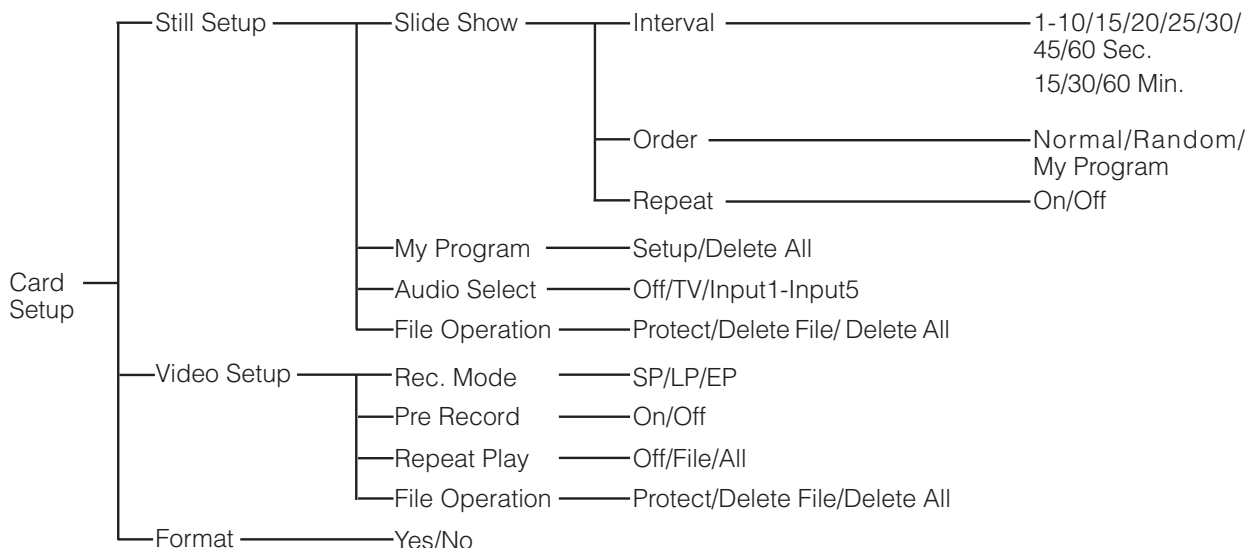

### Slide show operation panel

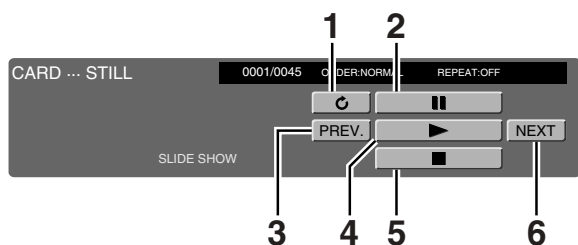

- 1 Rotate the image
- 2 Pause
- 3 Go to previous image
- 4 Start slide show
- 5 Stop slide show
- 6 Go to next image

### Motion picture operation panel

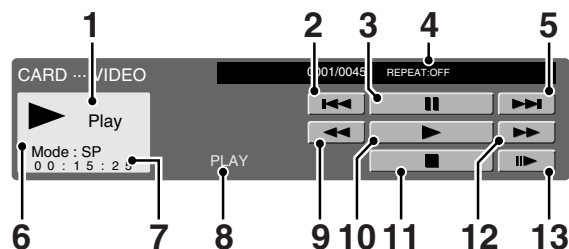

- 1 Action
- 2 Go back to the beginning of the file
- 3 Pause
- 4 Repeat playback setting
- 5 Go to the beginning of the next file
- 6 Recording mode
- 7 Counter
- 8 Current action
- 9 Reverse
- 10 Playback
- 11 Stop
- 12 Fast forward
- 13 Slow playback

### Precautions when playing back PC image data on the LCD TV

#### Recording formats of image data:

When recording image data on the LCD TV, the recording formats are as follows.

- When recording motion pictures: The SD\_VIDEO folder is created and the data is stored in. When playing the card, the SD\_VIDEO recording format is recognized.
- When recording still pictures: The DCIM folder is created and the data is stored in. When playing the card, the DCIM recording format is recognized.

#### When playing the card, record PC data in a recording format the LCD TV can recognize.

1. When copying motion pictures from a PC to a card recorded with the LCD TV, first place the pictures in the SD\_VIDEO folder before playing them.
2. When copying still pictures from a PC to a card recorded with the LCD TV, first place the pictures in the DCIM folder before playing them.
3. When using a new card for copying motion pictures, first format the card and create an SD\_VIDEO folder before placing the data in the folder for playback.
4. When using a new card for copying still pictures, first format the card and create a DCIM folder before placing the data in the folder for playback.

**When creating, revising, or copying images using your PC, the edited images may not playback correctly.**

## Using memory card

### Opening the PC CARD slot cover

Use your fingertip to slide the catch in the direction of the arrow.

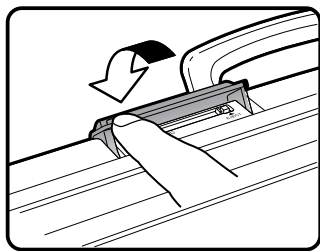

### Inserting a PC card adapter

- Press in the EJECT button if it is popped out.
- Insert a memory card to a PC card adapter beforehand. (See page XX.)
- Insert the PC adapter card slowly.

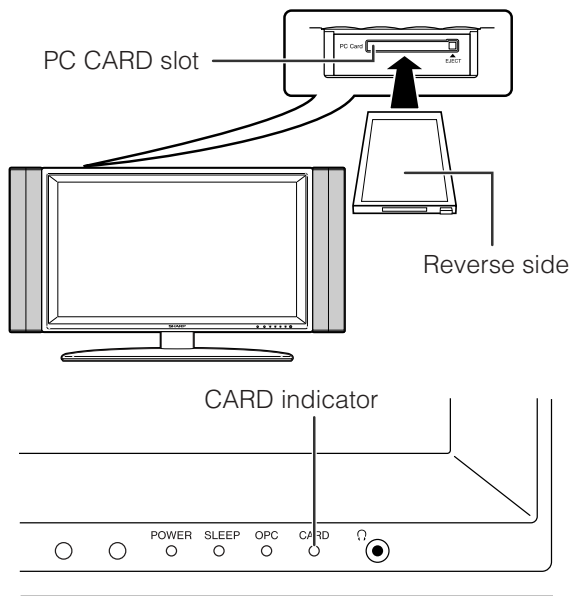

- CARD indicator lights up green when the card is inserted.

### Ejecting the card

- Make sure the card indicator lights up green.

1

- Press **EJECT** button.
- EJECT button is popped up.

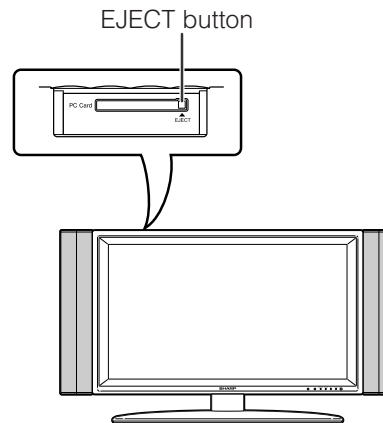

2

- Press **EJECT** button again.

#### NOTE

- Please do not insert a CableCARD (POD card) in the PC Card slot.
- When "Please insert a PC card" is displayed, eject the PC card adapter, and then insert the PC card adapter slowly all the way to the end.
- When over a thousand files are in a card, it takes several minutes to load. (approx. 5 minutes.)
- Even if the green light is on, you can not record on a card right after you inserted it.
- Make sure the CARD indicator lights green when you take out a card. Never take out a card when the CARD indicator lights red. This may damage the card.

### Selecting Still and Video mode

1

- Press **CARD** and the card mode screen displays.

2

- Press **◀/▶** to select "Still" or "Video", and then press **ENTER**.
- When in CARD mode, press **0-9, CH ▲/▼, FAVORITE CH** or **INPUT** to switch either TV or AV input mode.

## Using memory card

### Recording a still image

You can record a still image on the card.

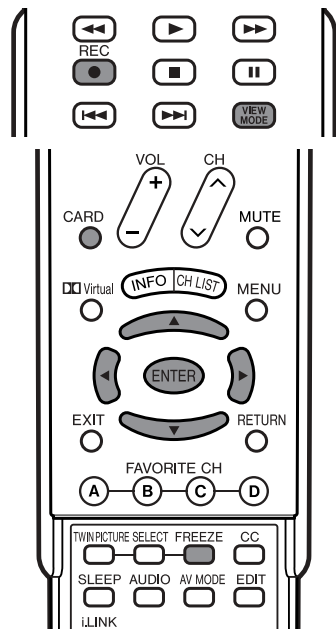

**1** Press **FREEZE**.

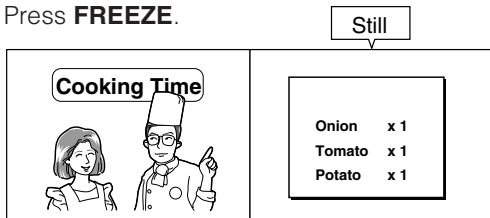

**2** Press **REC**.

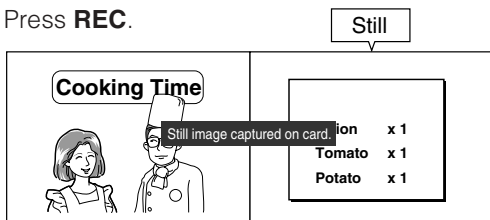

• "Still image captured on card." displays.

**3** Press **ENTER** to update the still image.

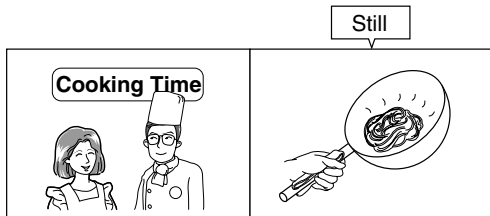

#### NOTE

The list of broadcasting type or input signal not available for recording:

- ① COMPONENT input
- ② HDMI input
- ③ DVI-I input
- ④ Card picture
- ⑤ Copy guarded signal
- ⑥ V-chip blocked program
- ⑦ i.LINK input
- ⑧ DTV Program

### Displaying a still image

**1** Press **CARD** and the card mode screen displays.

**2** Press **◀/▶** to select "Still", and then press **ENTER**.

**3** Press **▲/▼/◀/▶** to select a file you want to display, and then press **ENTER**.

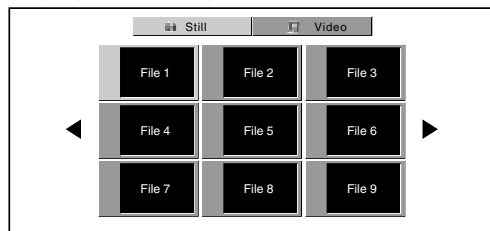

- To display the files that are in the previous or next page, select **◀/▶** on the index screen and press **ENTER**.
- When viewing a still image, by pressing **VIEW MODE** the image size changes. Normal – Full. This function does not work when displaying the index screen.

### Displaying slide show

**1** Repeat steps 1 to 3 in Displaying a still image above.

- The operation panel displays.

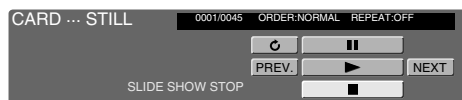

**2** Press **▲/▼/◀/▶** to select **▶**, and then press **ENTER**.

- Slide show starts.
- Operate slide show with the operation panel appears on the screen.
- To turn off the operation panel, press **CARD** on the remote control.

#### NOTE

- See page 42 for operation panel function.
- You can not rotate the image during slide show. Stop slide show to rotate the image.

## Using memory card

### Setting/unprotecting Slide Show

You can adjust the interval, order and repeat settings.

- 1 Press **CARD** and the card mode screen displays.
- 2 Press **MENU** and the MENU screen displays.
- 3 Press **◀/▶** to select "Card Setup".
- 4 Press **▲/▼** to select "Still Setup", and then press **ENTER**.
- 5 Press **▲/▼** to select "Slide Show", and then press **ENTER**.

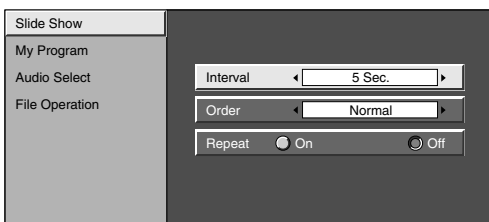

- 6 Press **▲/▼/◀/▶** to select the desired slide show setting, and then press **ENTER**.

Selected item	Description
<b>Interval</b>	Set the frame interval for a slideshow.
<b>Order</b>	Set the frame order for a slideshow. See the right column for My Program setting.
<b>Repeat</b>	If set to On, the slideshow will play again after showing the last frame.

### My Program

You can select up to thirty-two pictures and specify the order for displaying in slide show.

- 1 Repeat steps 1 to 4 in **Setting Slide Show**.
- 2 Press **▲/▼** to select "My Program", and then press **ENTER**.
- 3 Press **◀/▶** to select "Setup", and then press **ENTER**.
- 4 Press **▲/▼/◀/▶** to select the files, and then press **ENTER**.
- 5 Repeats the operation in step 4. (You can select up to 32 files.)
- 6 After selecting all the files you want, press **RETURN** to return to MENU.

### To cancel My Program setting

- 1 Performs step 1 and 2 in My Program.
- 2 Press **◀/▶** to select "Delete All", and then press **ENTER**.
- 3 Press **◀/▶** to select "Yes", and then press **ENTER**.
  - All the registered numbers are cleared.

### Audio Select

You can enjoy the audio from TV or other external equipment during the still image playback.

- 1 Repeat steps 1 to 4 in **Setting Slide Show**.
- 2 Press **▲/▼** to select "Audio Select", and then press **ENTER**.
- 3 Press **▲/▼/◀/▶** to select the desired sound output, and then press **ENTER**.

## Using memory card

### Protecting/unprotecting still picture files

You can protect any file you do not want to delete.

**1** Repeat steps 1 to 4 in **Audio Select**.

**2** Press **▲/▼** to select "File Operation", and then press **ENTER**.

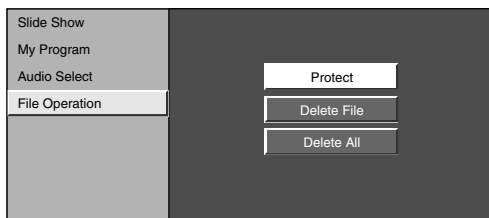

**3** Press **▲/▼** to select "Protect", and then press **ENTER**.

**4** Press **▲/▼/◀/▶** to select the file you want to protect, and then press **ENTER**.

- Protect mark (🔒) displays.
- Select the file with a protect mark and press **ENTER** to cancel file protect.

**5** Repeats the operation in step 4.

**6** After setting the files you want to protect, press **RETURN** to return to MENU.

#### NOTE

- You cannot delete a protected file on the card.

### Deleting a still image file

**1** Repeat steps 1 to 5 in **Protecting still picture files**.

**2** Press **▲/▼** to select "Delete File", and then press **ENTER**.

**3** Press **▲/▼/◀/▶** to select the file you want to delete, and then press **ENTER**.

**4** Press **◀/▶** to select "Yes", and then press **ENTER**.

**5** Repeat the operations in steps 7 and 8 above.

**6** After deleting the images you no longer need, press **RETURN** to return to MENU.

#### NOTE

- You cannot delete a protected file on the card.
- Do not turn off the power or take out a card when deleting a file. The card may malfunction.

### Deleting all still image files

**1** Repeat steps 1 to 5 in **Protecting still picture files**.

**2** Press **▲/▼** to select "Delete All", and then press **ENTER**.

**3** Press **◀/▶** to select "Yes", and then press **ENTER**.

#### NOTE

- You cannot delete a protected file on the card.
- Do not turn off the power or take out a card when deleting a file. The card may malfunction.

## Using memory card

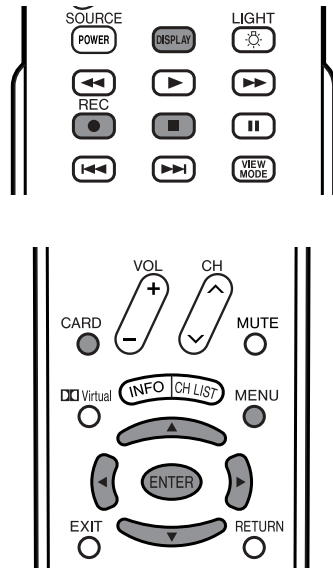

### Recording a motion picture

Use this setting to record images you are currently watching. Record with the settings made in “Rec. Mode” and “Pre Record”.

- 1 Press **REC** to start recording.
  - CARD indicator lights up red.
  - Recording information displays in the lower right corner of the screen.

- 2 Press **■** to stop recording.

#### NOTE

The list of broadcasting type or input signal not available for recording:

- ① COMPONENT input
- ② HDMI input
- ③ DVI-I input
- ④ Card picture
- ⑤ Copy guarded signal
- ⑥ V-chip blocked program
- ⑦ i.LINK input
- ⑧ DTV Program

### To display the remaining record time.

Press **DISPLAY** while not recording.

- Remaining record time displays in the lower right corner of the screen.

#### NOTE

- Do not remove the AC cord from the socket.
- Recording stops if you press **POWER** on the remote control while recording.
- When card has no capacity for recording, “Card is full” displays and stops recording.
- You cannot change the channel or switch the input source while recording.

### Displaying a motion picture

- 1 Press **CARD** and the card mode screen displays.

- 2 Press **◀/▶** to select “Video”, and then press **ENTER**.

- 3 Press **▲/▼/◀/▶** to select the file you want to play, and then press **ENTER**.
  - Video playback starts.

- 4 Press **CARD** again to display the operation panel.
  - See page XX for the operation panel information.
  - When viewing a motion picture, by pressing **VIEW MODE** the picture size changes. Small – Medium – Large.

### Rec. Mode

Use this setting for recording images you are currently watching. You can select the recording mode (picture quality) for a motion picture.

- 1 Press **CARD** and the card mode screen displays.

- 2 Press **MENU** and the MENU screen displays.

- 3 Press **◀/▶** to select “Card Setup”.

- 4 Press **▲/▼** to select “Video Setup” and then press **ENTER**.

- 5 Press **▲/▼** to select “Rec. Mode”, and then press **ENTER**.

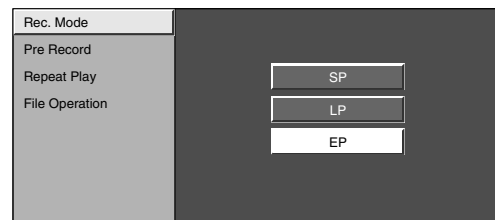

- 6 Press **▲/▼** to select the desired mode, and then press **ENTER**.



## Using memory card

### Pre Record

You can record the picture slightly before the point where you pressed the record button, enabling you to record just the scene you wanted.

**1** Repeat steps 1 to 4 in **Rec. Mode**.

**2** Press **▲/▼** to select "Pre Record", and then press **ENTER**.

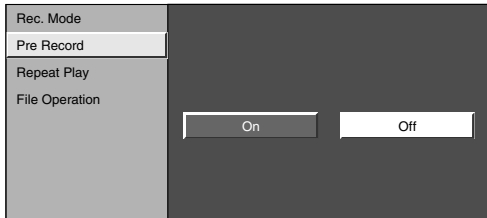

**3** Press **◀/▶** to select "On", and then press **ENTER**.

### Repeat Play

You can specify one file or all files to replay repeatedly.

**1** Repeat steps 1 to 4 in **Rec. Mode**.

**2** Press **▲/▼** to select "Repeat Play", and then press **ENTER**.

**3** Press **▲/▼** to select desired setting, and then press **ENTER**.

Selected item	Description
Off	No playback or repeat.
File	Plays back and repeats one file.
All	Plays back all movie files on the card then repeats.

### Protecting/unprotecting motion picture files

You can protect any file you do not want to delete.

**1** Press **CARD** and the card mode screen displays.

**2** Press **MENU** and the MENU screen displays.

**3** Press **◀/▶** to select "Card Setup".

**4** Press **▲/▼** to select "Video Setup", and then press **ENTER**.

**5** Press **▲/▼** to select "File Operation", and then press **ENTER**.

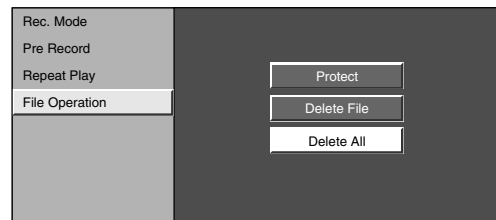

**6** Press **▲/▼** to select "Protect", and then press **ENTER**.

**7** Press **▲/▼/◀/▶** to select the file you want to protect, and then press **ENTER**.

- Protect mark (🔒) displays.
- Select the file with a protect mark and press **ENTER** to cancel file protect.

**8** Repeats the operation in step 4.

**9** After setting the files you want to protect, press **RETURN** to return to MENU.

## Using memory card

### Deleting a motion picture file

- 1 Repeat step 1 to 5 in **Protecting motion picture files**.
- 2 Press ▲/▼ to select "Delete File", and then press **ENTER**.
- 3 Press ▲/▼/◀/▶ to select the file you want to delete, and then press **ENTER**.
- 4 Press ◀/▶ to select "Yes", and then press **ENTER**.
- 5 Repeat the operations in steps 7 and 8 above.
- 6 After deleting the images you no longer need, press **RETURN** to return to MENU.

#### NOTE

- You cannot delete a protected file on the card.
- Do not turn off the power or take out a card when deleting a file. The card may malfunction.

### Deleting all motion picture files

- 1 Repeat step 1 to 5 in **Protecting motion picture files**.
- 2 Press ▲/▼ to select "Delete All", and then press **ENTER**.
- 3 Press ◀/▶ to select "Yes", and then press **ENTER**.

#### NOTE

- You cannot delete a protected file on the card.
- Do not turn off the power or take out a card when deleting a file. The card may malfunction.

### Format

- 1 Press **MENU** and the MENU screen displays.
- 2 Press ◀/▶ to select "Card Setup".
- 3 Press ▲/▼ to select "Format" and then press **ENTER**.
- 4 Press ◀/▶ to select "Yes", and then press **ENTER**.

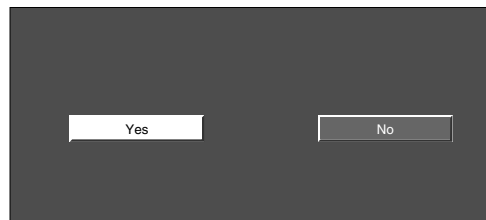

#### NOTE

- Formatting a card deletes all files including the ones which set to protect.
- Do not turn off the power or take out a card while it is being formatted.

# Using external equipment

You can connect many types of external equipment to your System, like a DVD player, VCR, Digital TV tuner, PC, HDMI equipment, game console and camcorder. To view external source images, select the input source from **INPUT** on the remote control unit or on the Display.

## Displaying an external equipment image

Explanation here is for the setting when connecting DVD to INPUT1 terminal.

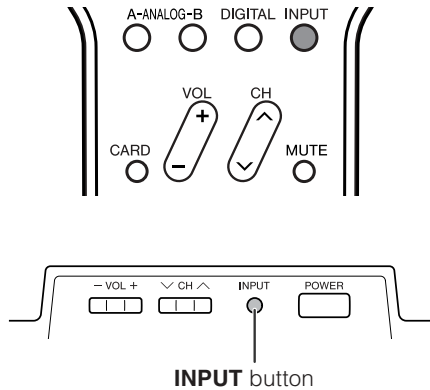

To watch a DVD image, select "INPUT1" from "INPUT SOURCE" menu using **INPUT** on the remote control unit or on the Display. (See page XX.)

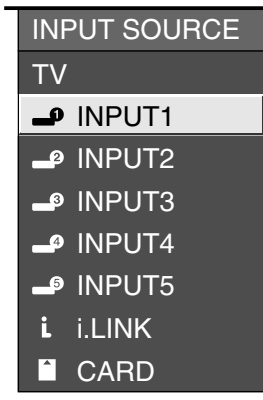

### NOTE

- If the image does not come in clearly, you may need to change the input signal type setting on the "Input Select" menu.

## Selecting the INPUT signal

1

Press **MENU** and the MENU screen displays.

2

Press **◀/▶** to select "Option".

3

Press **▲/▼** to select "Input Select", and then press **ENTER**.

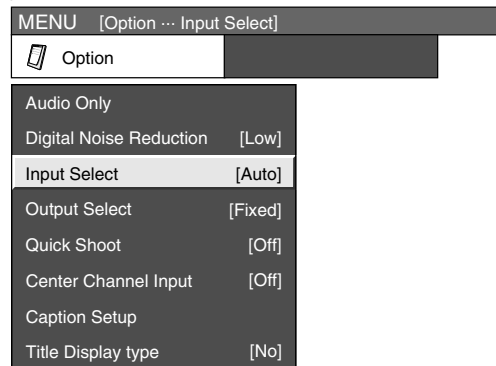

4

Select the desired signal type.

### For INPUT1 signal

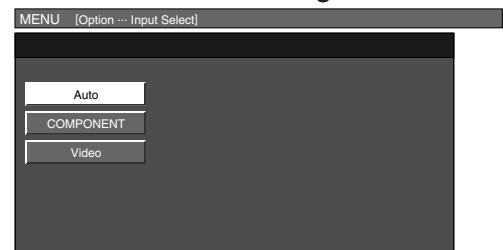

The setting is stored and can be selected on the "INPUT SOURCE" menu.

### CAUTION

- To protect all equipment, always turn off the TV before connecting to a DVD player, VCR, Digital TV tuner, PC, HDMI equipment, game console, camcorder or other external equipment.

### NOTE

- See pages XX to XX for external equipment connection.
- Please refer to the relevant operation manual (DVD player, PC, etc.) carefully before making connections.
- Each time **INPUT** is pressed, the input source toggles.
- Refer to your external equipment operation manual for the signal type.

## Using external equipment

### Connecting a DVD player

You can use the INPUT 1, INPUT 2, INPUT 4 or INPUT 5 terminals when connecting to a DVD player and other audiovisual equipment.

#### When using component cable.

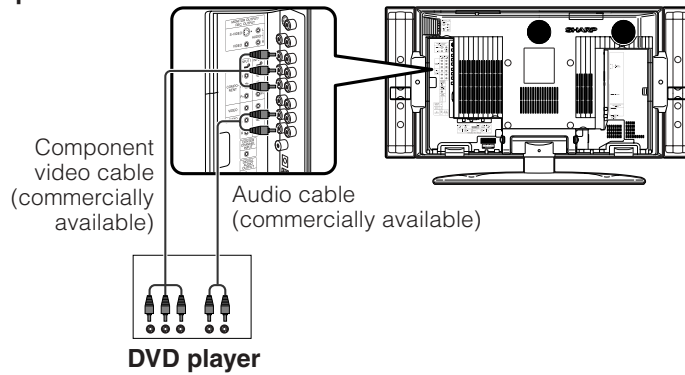

#### When using composite cable.

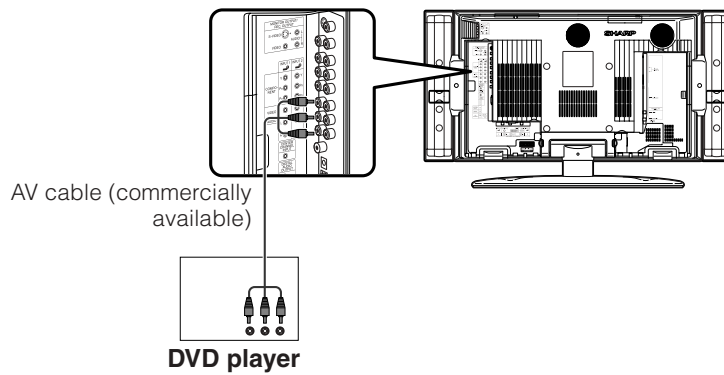

#### When using DVI cable. (INPUT 5)

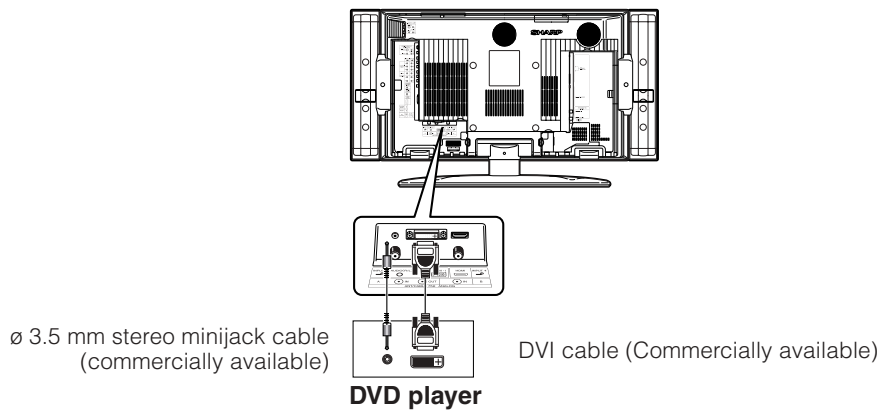

#### NOTE

- See page 54 for connecting a DVD player with HDMI terminal.

## Using external equipment

### Connecting a VCR

You can use the INPUT 3 terminal when connecting a VCR and other audiovisual equipment.

#### NOTE

- The S-video terminal has priority over the video terminals.

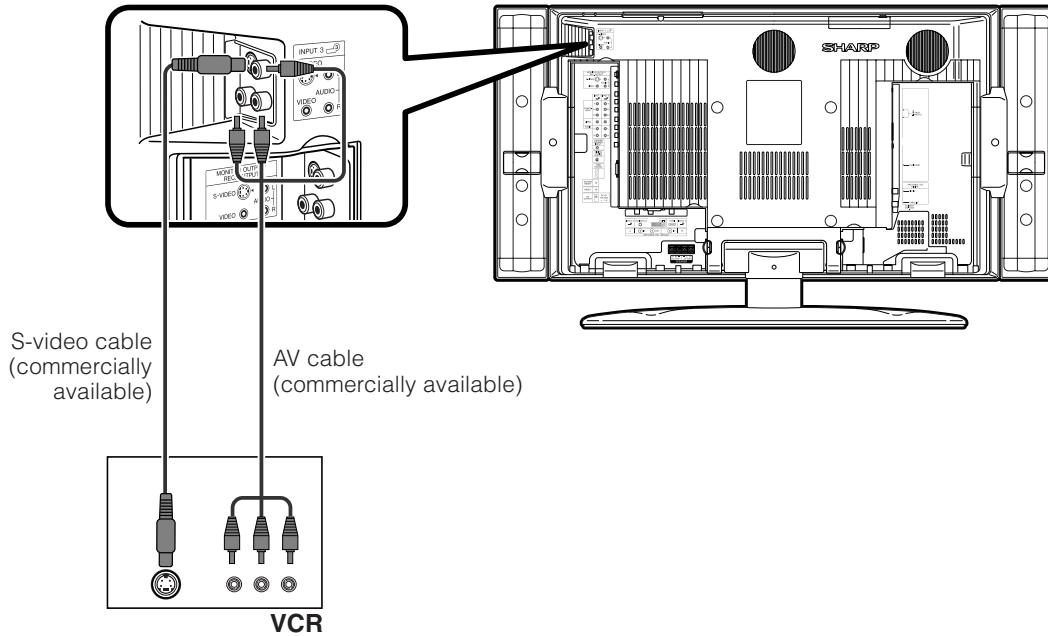

### Connecting a game console or camcorder

A game console, camcorder and some other audiovisual equipment are conveniently connected using the INPUT 3 terminals.

#### NOTE

- The S-video terminal has priority over the video terminals.

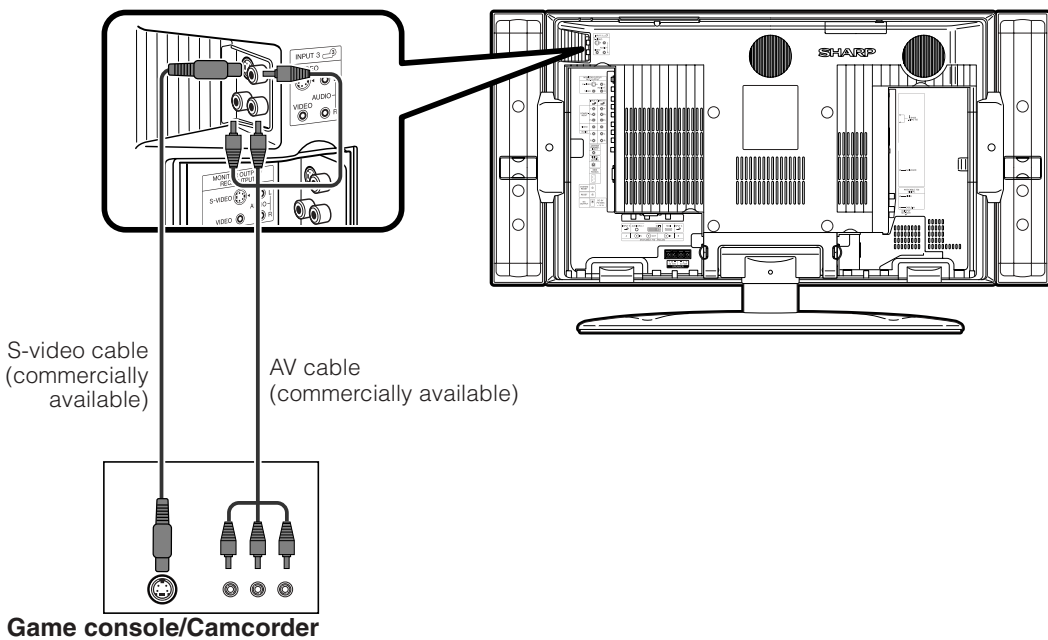

## Using external equipment

### Connecting a Digital TV STB

You can use the INPUT 1, INPUT 2, INPUT 4 or INPUT 5 terminals when connecting a Digital TV STB and other audiovisual equipment.

#### When using component cable.

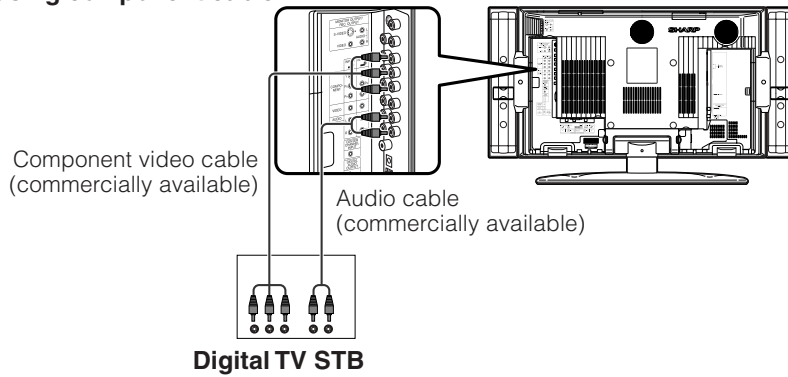

#### When using composite cable.

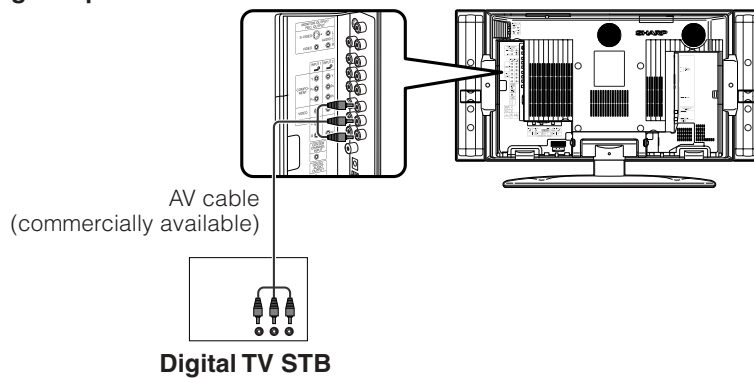

#### When using DVI cable. (INPUT 5)

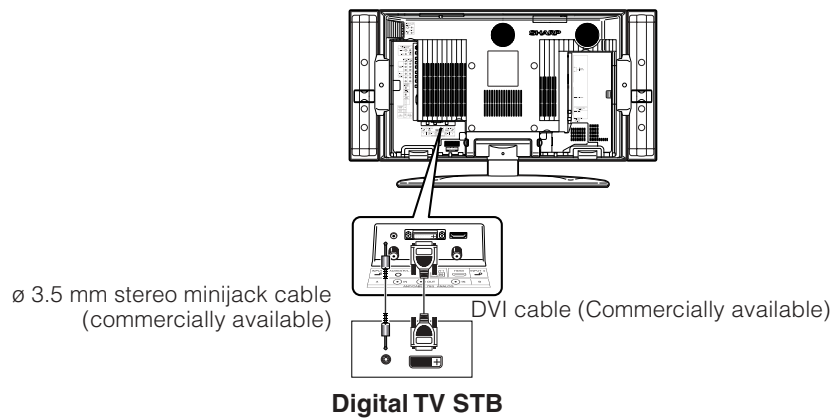

#### NOTE

- See page 54 for connecting a Digital TV STB to HDMI terminal.

## Using external equipment

### Connecting HDMI equipment

You can use the INPUT 4 terminal when connecting an HDMI equipment.

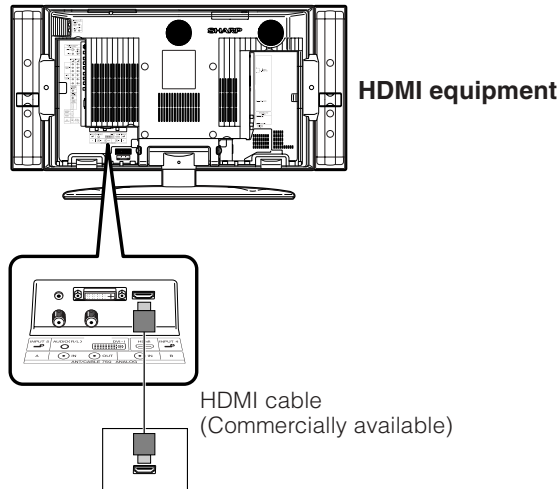

### Displaying an image from HDMI equipment

- To watch an HDMI equipment image, select "INPUT4" from "INPUT SOURCE" menu using **INPUT** on the remote control unit or on the Display. (See page 66.)

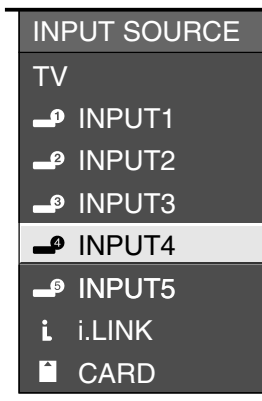

- Press **MENU** and the MENU screen displays.

- Press **◀▶** to select "Option".

- Press **▲/▼** to select "HDMI Setup", and then press **ENTER**.

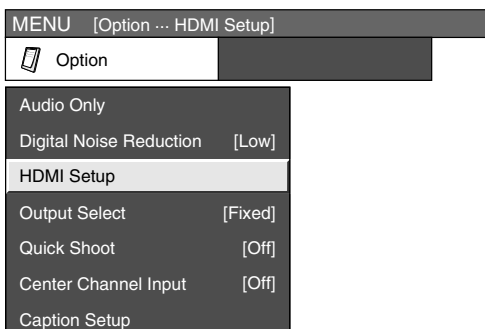

- Press **▲/▼** to select the desired item and press **ENTER**.

- Press **▲/▼/◀▶** to select the desired setting and press **ENTER**.

HDMI Setup items	Selectable items	Description
<b>Signal Type</b>	Auto/RGB/YCbCr 4:4:4/YCbCr 4:2:2	Select the signal type from an HDMI terminal. Unless the image quality looks obviously poor, select Auto.
<b>Color Matrix</b>	Auto/ITU601/ITU709	Select the internal color space conversion method when an RGB signal is input. Normally, select Auto.
<b>Dynamic Range</b>	Standard/Out of standard	Select the signal amplitude range. Normally, select Standard.
<b>Auto View</b>	Enable/Disable	Set whether or not to use VIEW MODE based on signal recognition, including an HDMI signal.

#### NOTE

- Refer to your external equipment operation manual for the signal type.

## Using external equipment

### Connecting a PC

Use the INPUT 5 terminal to connect a PC.

#### NOTE

- Refer to page 81 for a list of PC signals compatible with the TV.

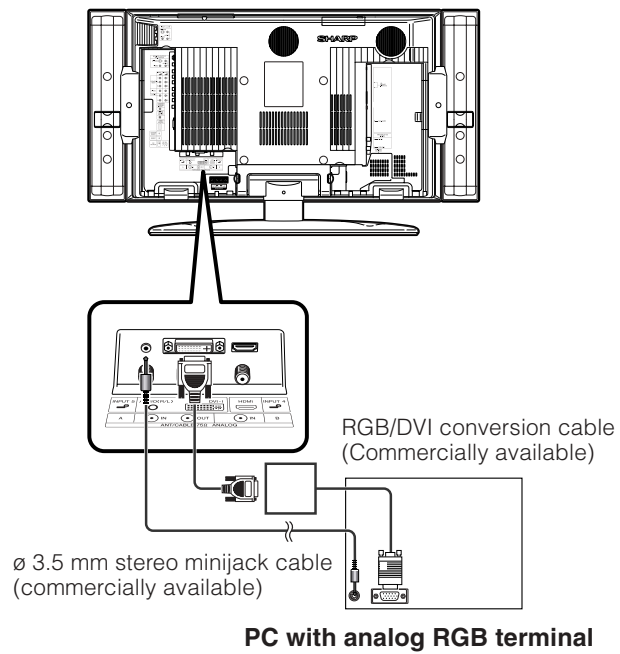
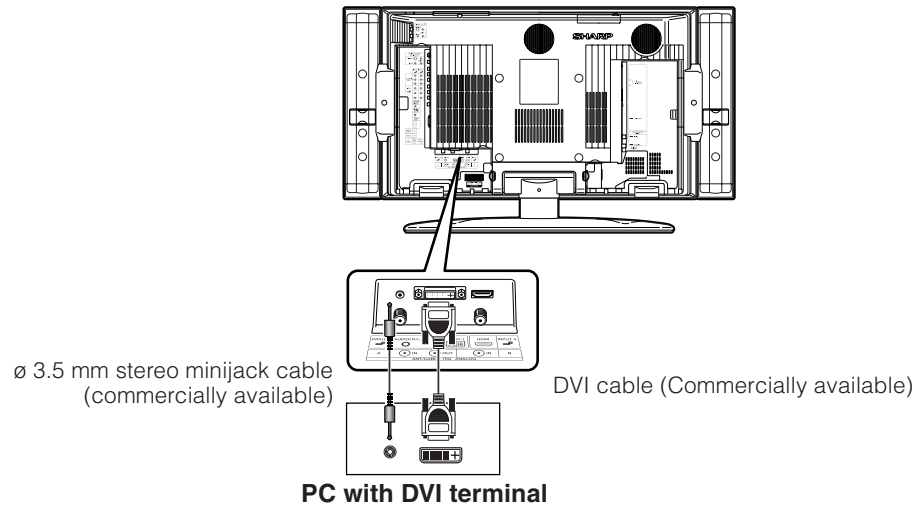



## Using external equipment

### Connecting D-VHS Decks (i.LINK connection)

#### About i.LINK

i.LINK is an interface connection using a serial transfer system and is able to transfer multimedia data, such as digital images and digital sound, between devices that have i.LINK terminals. i.LINK is a term defined in the IEEE 1394 (Institute of Electrical and Electronics Engineers) standard. Currently, the transfer speeds are at 100 Mbps, 200 Mbps and 400 Mbps, each of them expressed as S100, S200 and S400 respectively. On this TV, the maximum speed is 400 Mbps.

#### i.LINK devices that can be connected to this TV.

Only D-VHS decks can be connected to this TV. Other devices such as DVD recorders, digital video cameras, computers or computer peripheral devices do not meet the specifications for this TV and therefore, cannot be connected.

#### Materials that can be recorded with the i.LINK

Only digital programs can be recorded by D-VHS decks connected to this TV using the i.LINK. i.LINK recording is not compatible with ground-wave broadcasts or external input signals (INPUT terminals 1 through 5).

#### i.LINK connection

E.g. When only one D-VHS deck is connected:

#### NOTE

- Please make sure the shapes of the terminal and the plug match, and insert the plug into the terminal straight, not on an angle.
- Use either one of the terminals. These two terminals do not differ in quality or function.

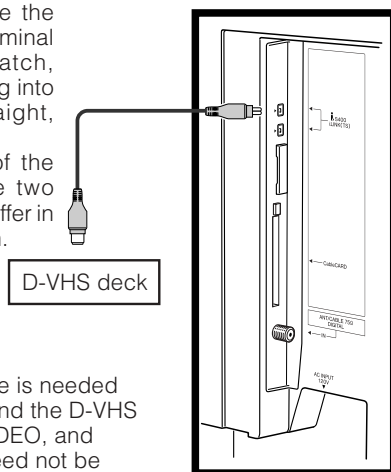

Only an i.LINK cable is needed to connect the TV and the D-VHS deck. (VIDEO, S-VIDEO, and AUDIO terminals need not be connected.)

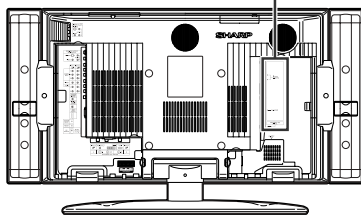

### Connecting two or more D-VHS decks

Up to 16 D-VHS decks can be connected using a daisy-chain connection with i.LINK cables.

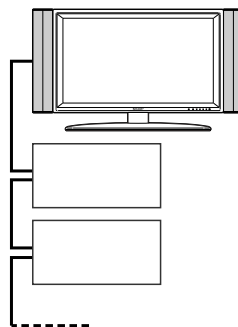

When 3 or more D-VHS decks are connected, branch connection can be used. With branch connections, up to 62 D-VHS decks can be connected.

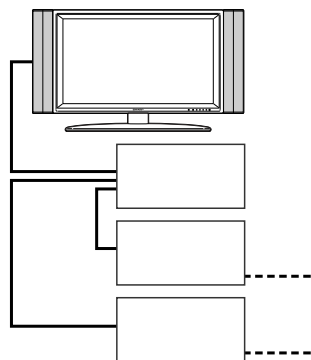

#### Cautions regarding i.LINK connection

- Please use S400 type i.LINK cables.
- Some i.LINK devices may not relay data if their power is off. This TV can relay data during power off, by selecting "Yes" in the "Stand-by Mode" option in "i.LINK setup". (See Page 57.)
- Please do NOT use a loop connection as shown in the diagram.

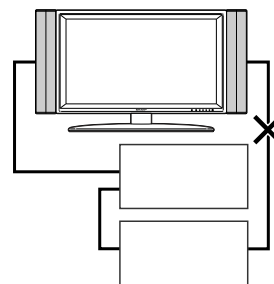

- When using the i.LINK, do not turn off the power of, or pull the cable from i.LINK devices, even if that i.LINK device is not in use. This may affect the picture and the sound from a D-VHS deck in use.
- If devices such as a DVD recorders, digital video cameras, computers and computer peripheral devices which are not compatible with this TV, are connected to the TV using i.LINK, other i.LINK connections may be disrupted.

## Using external equipment

### Setting the recording mode (i.LINK)

- The function for automatically adjusting the recording mode of connected D-VHS decks can be turned on or off.
- Since most of the currently available D-VHS decks automatically recognize the transfer rates of the pictures and sound being recorded and control the recording mode accordingly, **you should always set this Mode to “No” in normal circumstances.**
- Depending on the D-VHS deck used and the type of broadcast being recorded, this TV may not adjust the recording mode properly. In this case, please set the “Recording Mode” to “No”.

**1** Press **MENU** and the MENU screen displays.

**2** Press **◀/▶** to select “Digital Setup”.

**3** Press **▲/▼** to select “i.LINK Setup”, and then press **ENTER**.

**4** Press **▲/▼** to select “Recording Mode”, and then press **ENTER**.

**5** Press **◀/▶** to select “Yes” or “No”, and then press **ENTER**.

- Normally, this should be set to “No”.

### Setting the Stand-by Mode (i.LINK)

- Power consumption during stand-by mode can be minimized by changing the setting of the “Standby Mode” in “i.LINK Setup”.
- When i.LINK is not in use, select “No” in “Stand-by Mode”.

**1** Press **MENU** to display the MENU.

**2** Press **◀/▶** to select “Digital Setup”.

**3** Press **▲/▼** to select “i.LINK Setup”, and then press **ENTER**.

**4** Press **▲/▼** to select “Stand-by Mode”, and then press **ENTER**.

**5** Press **◀/▶** to select “Yes” or “No”, and then press **ENTER**.

“Yes”: Power continues to pass through the i.LINK circuit so data can be relayed.

“No”: Power consumption is minimized during stand-by mode. Data cannot be sent at this setting.

#### NOTE

- When the main power of the TV is in standby mode (POWER indicator lights up in red), i.LINK control commands cannot be received from a D-VHS deck. This does not change even if the “Stand-by Mode” is set to “Yes”. To control the TV from a D-VHS deck, turn the TV power on (POWER indicator lights up in green).
- Data cannot be relayed between i.LINK devices when all the following conditions are met: 1) More than one i.LINK device is connected to the TV with i.LINK cables, 2) “Stand-by Mode” is set to “No”, and 3) The main power of the TV is in standby mode (POWER indicator lights up in red). When the TV is connected between two i.LINK devices in series, select “Yes” in “Stand-by Mode” or connect the TV at an end of the series as shown in the diagram.

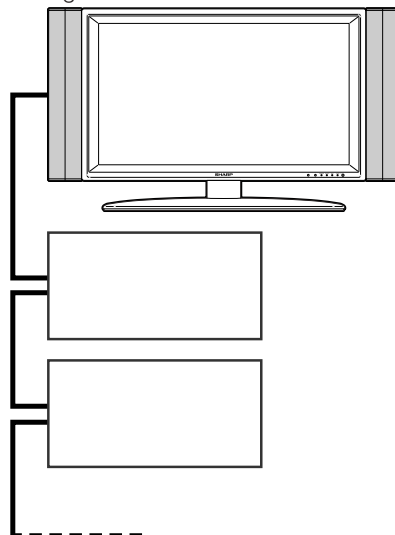

## Using external equipment

### Selecting a D-VHS deck (i.LINK)

- In order to control a D-VHS deck from the TV, you must first choose the D-VHS deck to be controlled.
- One D-VHS deck can be chosen from up to 16 i.LINK connected decks.
- All D-VHS decks connected with i.LINK cables should automatically appear in the selection screen.

1

Press **i.LINK** to display the i.LINK control panel.



- When there is no D-VHS deck connected, the message "No i.LINK model is available" appears. In this case, please connect a D-VHS deck. (See page 57.)
- When there is no D-VHS deck selected, the selection screen appears. In this case, please go to step 3.

2

Press **▲/▼/◀/▶** to select "Model" and press **ENTER**.

- Selection screen appears.

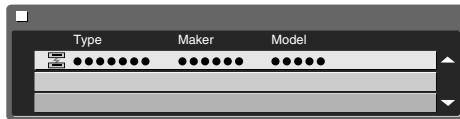

3

Press **▲/▼** to select a device, and then press **ENTER**.

- The control panel for the D-VHS deck appears.

### NOTE

- Devices that cannot be used with this TV will not appear in the selection screen.
- When an item in the selection screen is grayed out, the item is not recognized by the TV and cannot be selected. (The item may not be connected properly.)

### Disabling the TV's operation of a D-VHS deck (i.LINK)

- By disabling the TV's operation of a D-VHS deck, the deck can be operated from another i.LINK device.

1

Press **i.LINK** to display the i.LINK control panel.



- When there is no D-VHS deck connected, "No i.LINK model is available" appears. Please connect one. (See page 57.)
- When there is no D-VHS deck selected, the selection screen appears. Please go to step 3.

2

Press **▲/▼/◀/▶** to select "Model" and press **ENTER**.

- Selection screen appears.

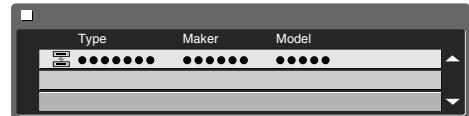

3

Press **▼** to select "Cancel Connection" and press **ENTER**.

- Operation of the D-VHS deck from the TV is disabled.

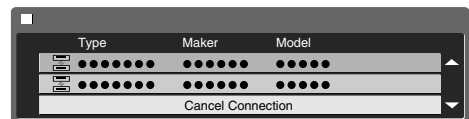

## Using external equipment

### Deleting a preset D-VHS deck (i.LINK)

- Preset D-VHS decks can be selected from a list.
- If a D-VHS deck is connected, it cannot be deleted from the list.

**1** Press **i.LINK** to display the i.LINK control panel.

**2** Press **▲/▼/◀/▶** to select “Selecting a device”, and then press **ENTER**.

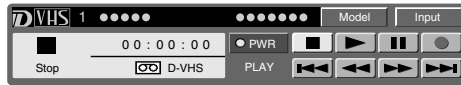

**3** Press **▲/▼** to select a device to be deleted, and then press **ENTER**.

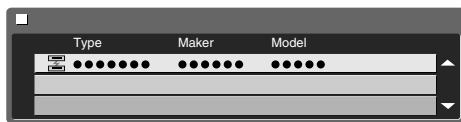

**4** Press **◀** to select “Delete”, and then press **ENTER**.

- The selected D-VHS deck is deleted from the list.
- Select “Cancel” to undelete a device.

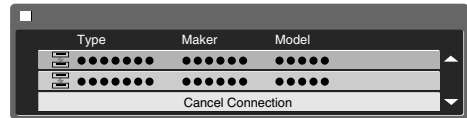

### Controlling an i.LINK device

- An i.LINK compatible D-VHS deck can be controlled from the TV using the i.LINK control panel on the screen.
- The steps in “i.LINK Setup” on page XX need to be completed beforehand.
- Please also refer to the operation manual of the D-VHS deck to be used with this TV.

### Basic operation

**1** Press **i.LINK** to display the i.LINK control panel.

- The **i.LINK** button is also used to exit the i.LINK control panel.

**2** Press **▲/▼/◀/▶** to select a function, and then press **ENTER**.

### The i.LINK control panel

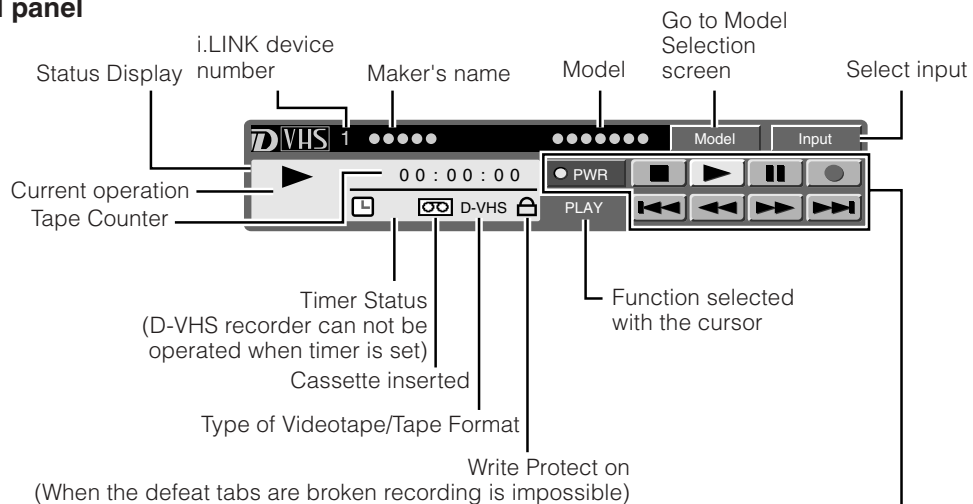

	Power On/Off		Skip back
	STOP		REWIND
	PLAY		FAST FORWARD
	PAUSE		Skip forward
	REC START		

### NOTE

- The input selection button is used to select either digital broadcasting or i.LINK input.

## Using external equipment

### NOTE

- Even when a connected D-VHS deck is playing, input signal can be switched to digital broadcasting by shifting the cursor to the input selection button and pressing **ENTER**.
- This TV may not be able to operate some D-VHS decks using the control panel, or to display picture and/or sound input from some D-VHS decks.
- Depending on the D-VHS deck, this TV's i.LINK may not allow viewing of VHS and S-VHS tape or analog recorded D-VHS tape. In this case, connect the D-VHS deck's analog output with the TV's analog input, and switch the TV's input mode to external input.
- If a D-VHS deck is operated with the TV's control panel during timer recording, the recording may fail. Do not use the TV's control panel to operate the D-VHS deck during timer recording.
- When the TV's control panel is used to record a program, what is recorded with the D-VHS deck are the pictures and sound of the digital program that the TV is receiving.
- To record the picture and sound of a digital program which the TV is receiving, use D-VHS tape. VHS or S-VHS tape will not record.
- The i.LINK control panel cannot be used during timer recording.
- The i.LINK control panel cannot be displayed together with the TV Guide On Screen™ or other menus.
- There may be some programs which D-VHS decks cannot record.
- With some D-VHS decks, the quality of the picture may be distorted during fast forwarding or rewinding.
  
- IEEE 1394 is the IEEE's international standard.
- i.LINK and the i.LINK logo are registered trademarks of Sony Electronic, Inc.
- A copy protection technology is used on D-VHS decks that incorporate copyright protection. This technology has received the approval of the Digital Transmission Licensing Administrator (DTLA), an organization that administers copyright protection technologies. Some picture and sound data have restrictions on duplication. Such data cannot be digitally copied using the i.LINK. Some picture and sound data may not be able to be sent back and forth between a D-VHS deck that has DTLA copyright protection technology and one that does not.

### Automatic input switching to i.LINK

- Input mode can be set to automatically switch to i.LINK when a D-VHS deck connected to the TV is played.

1

Press **MENU** to display the MENU screen.

2

Press **◀/▶** to select "Digital Setup", and then press **ENTER**.

3

Press **▲/▼** to select "i.LINK setup", and then press **ENTER**.

4

Press **▲/▼** select "i.LINK Autoswitch", and then press **ENTER**.

5

Press **◀/▶** to select "Yes", and then press **ENTER**.

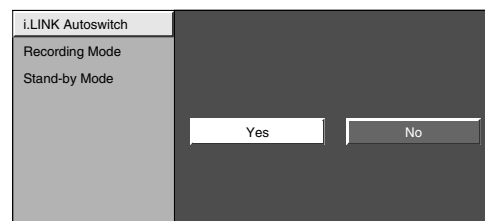

## Using external equipment

---

### Recording digital programs with a D-VHS deck (i.LINK)

- Before commencing this procedure, the steps in "i.LINK Setup" on page 58 need to be completed beforehand.
- Please also refer to the operation manual of the D-VHS deck to be used with this TV.

**1** Select a digital program to be recorded.

**2** Press **i.LINK** to display the i.LINK control panel.



**3** Press **▲/▼/◀/▶** to select **●**, and then press **ENTER**.

- Recording starts.
- Select **●** and press **ENTER** to stop recording.

#### NOTE

- Input mode cannot be switched to i.LINK during recording.
- Some D-VHS decks may not be able to be operated using the TV's i.LINK control panel.
- When a D-VHS deck connected to the TV is under timer recording, the deck cannot be operated using the TV's control panel.
- When the TV's control panel is used to record a program, what is recorded with the D-VHS deck are the pictures and sound of the digital program that the TV is receiving.
- To record the picture and sound of a digital program which the TV is receiving, use D-VHS tape. VHS or S-VHS tape will not record.
- The i.LINK control panel cannot be used during timer recording.

# Useful adjustment settings

## Image position (AV input mode only)

For adjusting a picture's horizontal and vertical position.

- 1 Press **MENU** and the MENU screen displays.
- 2 Press **◀/▶** to select "Setup".
- 3 Press **▲/▼** to select "Position", and then press **ENTER**.
- 4 Press **▲/▼** to select "H-Pos." or "V-Pos.".
- 5 Press **◀/▶** to adjust the item to your desired position.

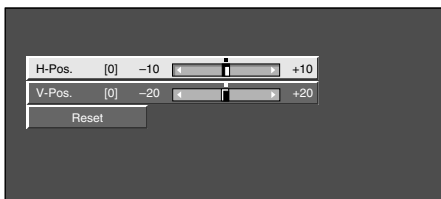

### NOTE

- For resetting all adjustment items to the factory preset values, press **▲/▼** to select "Reset", and then press **ENTER**.
- **Adjustments are stored separately according to input source.**
- You can easily move the image position as shown on this page, but when the power is switched off the image will return to the previously memorized position.

Selected item	Description
<b>H-Pos.</b>	Centers the image by moving it to the left or right.
<b>V-Pos.</b>	Centers the image by moving it up or down.

## Moving the picture on the screen

You can move the picture around on the screen.

Press **▲/▼/◀/▶** to move an image on the screen to the desired position. Press **ENTER** to return to the initial image position.

### NOTE

- While pressing **▲/▼/◀/▶**, an on-screen image, "Adjusting Position" displays to the desired position.
- This setting cannot be stored. Once the TV shuts down or enters standby mode, the setting is erased. To move the picture around the screen again, you must perform the above procedure again.
- The image position setting using the steps on page 63 can be stored. Select either according to your objectives.
- "TV", "INPUT1", "INPUT2", "INPUT3" and "INPUT4" can each adjust the image position setting on this page. The same for view modes.
- An on-screen image from PC and card cannot be moved around.
- Even when the image fills the screen, its position can be adjusted with this function.
- Press **ENTER** to reset the image to original positions.

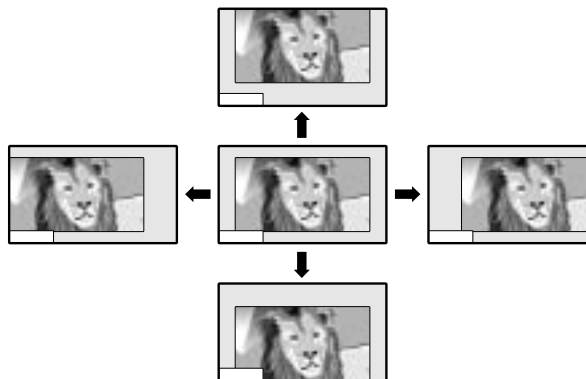



## Useful adjustment settings

### Connecting external speakers

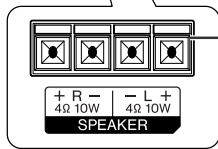
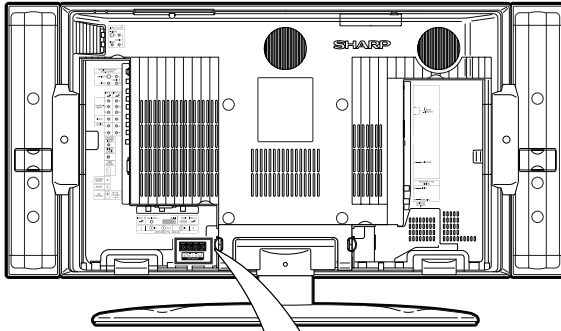
#### Rear view



#### How to connect the speaker cable

- 1 Push down the tab. 
- 2 Insert the end of the cable. 
- 3 Lift the tab back up. 

When using external speakers

- Change the speaker setting to external speakers. (See page 64.)

Make sure to connect the speaker terminal and cable polarity (+, -) properly

- The speaker terminals have plus (+) and minus (-) polarity.
- Plus is red and minus is black.
- The cables are also divided into plus and minus.
- When connecting the left/right speakers, be sure to connect the plus/minus terminals with the correct cables.

#### NOTE

- Unplug the AC cord from the AC outlet before installing the speakers.

#### CAUTION

- Make sure external speakers have 4 ohm and 10 watt specifications.
- Connect the plus/minus terminals with the correct cables. Incorrect connection may cause a short.



## Useful adjustment settings

---

### Audio Quality Control

Audio Quality Control automatically optimizes the audio quality to suit internal (supplied) speakers.

**1** Press **MENU** and the MENU screen displays.

**2** Press **◀/▶** to select "Setup".

**3** Press **▲/▼** to select "Speaker Setup", and then press **ENTER**.

**4** Press **▲/▼** to select "Audio Quality Control", and then press **ENTER**.

**5** Press **◀/▶** to select "Equalizer" or "Flat", and then press **ENTER**.

Selected item	Description
<b>Equalizer</b>	Sets the optimum Audio Quality Control for the attached speakers.
<b>Flat</b>	When you are using your own speakers, output the original sound without using Audio Quality Control.

#### NOTE

- When DOLBY Virtual is on, Audio Quality Control automatically sets to Flat.

## Useful adjustment settings

### Auto Sync. adjustment (PC input mode only)

For automatically adjusting the PC image.

**1** Press **MENU** and the MENU screen displays.

**2** Press **◀/▶** to select "Setup".

**3** Press **▲/▼** to select "Auto Sync.", and then press **ENTER**.

**4** Press **◀/▶** to select "Yes", and then press **ENTER**.

- Auto Sync. starts and "Now adjusting the image" displays.

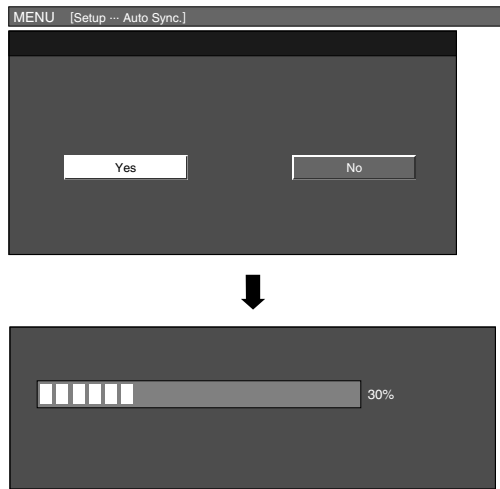

#### NOTE

- When Auto Sync. is successful, "Auto Sync completed successfully" displays. If not, Auto Sync. failed.
- Auto Sync. may fail even if "Auto Sync completed successfully" displays.
- Auto Sync. may fail if the computer image has low resolution, has unclear (black) edges, or is moved while executing Auto Sync.
- Be sure to connect the PC to the TV and switch it on before starting Auto Sync.

### Fine Sync. adjustment (PC input mode only)

Ordinarily you can easily adjust the picture as necessary to change image position using Auto Sync. In some cases, however, manual adjustment is needed to optimize the image.

**1** Press **MENU** and the MENU screen displays.

**2** Press **◀/▶** to select "Setup".

**3** Press **▲/▼** to select "Fine Sync.", and then press **ENTER**.

**4** Press **▲/▼** to select the specific adjustment item.

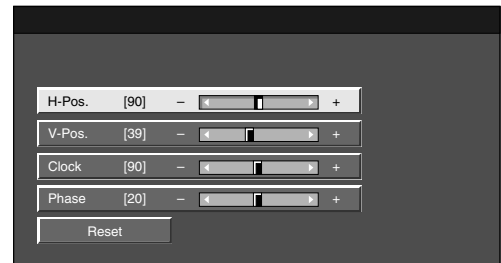

**5** Press **◀/▶** to adjust the item to your desired position.

#### NOTE

- For resetting all adjustment items to the factory preset values, press **▲/▼** to select "Reset", and then press **ENTER**.

Selected item	Description
<b>H-Pos.</b>	Centers the image by moving it to the left or right.
<b>V-Pos.</b>	Centers the image by moving it up or down.
<b>Clock</b>	Adjusts the clock frequency.
<b>Phase</b>	Adjusts the clock phase.

## Useful adjustment settings

### Input Select

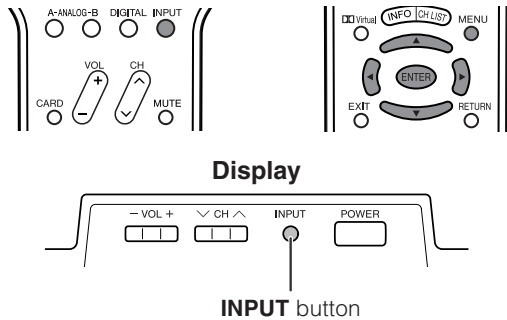

#### Selecting input source

Use this menu to select the input source.

- 1 Press **INPUT**.
  - A list of selectable sources appears.
- 2 Press **INPUT** again to select the input source.
  - An image from the selected source automatically displays.
  - You can also select the input source by pressing **▲/▼**.
  - If the corresponding input is not plugged in, you cannot change the input. Be sure to connect the equipment beforehand.

#### Selecting input signal type

For setting the signal type of external equipment connected to INPUT 1 and INPUT 2 terminals.

- 1 Press **MENU** and the MENU screen displays.
- 2 Press **◀/▶** to select "Option".
- 3 Press **▲/▼** to select "Input Select", and then press **ENTER**.
- 4 Press **▲/▼** to select a signal type you want to set, and then press **ENTER**.
  - If the selected signal type is incorrect, images are not displayed or displayed without any color.

#### NOTE

- If you set INPUT1 and INPUT2 to Auto, the TV will automatically select the input signal.
- Check the operation manual of the external equipment for the signal type.
- Setting INPUT 1 and INPUT 2 signal selection to "Auto" when other equipment is connected will result in the following connectivity priority.

INPUT 1 and INPUT 2
1. COMPONENT VIDEO
2. VIDEO

### DVI input signal setting

- 1 Press **INPUT** to select INPUT5.

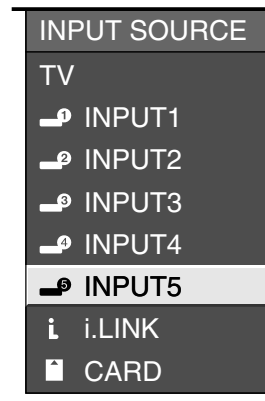

- 2 Press **MENU** and the MENU screen displays.
- 3 Press **◀/▶** to select "Option".
- 4 Press **▲/▼** to select "Input Select", and then press **ENTER**.

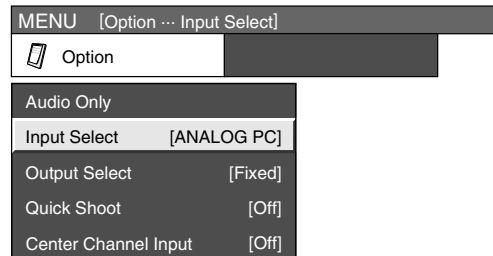

- 5 Press **▲/▼** to select the equipment connected to INPUT 5 terminal, and then press **ENTER**.

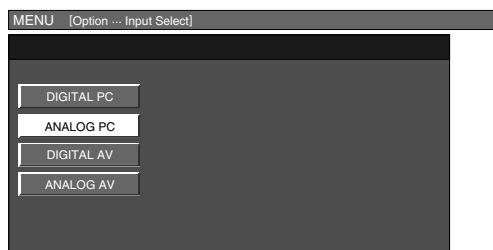

## Useful adjustment settings

### Input Label

Lets you set the input terminal displayed using the INPUT SOURCE menu or channel display.

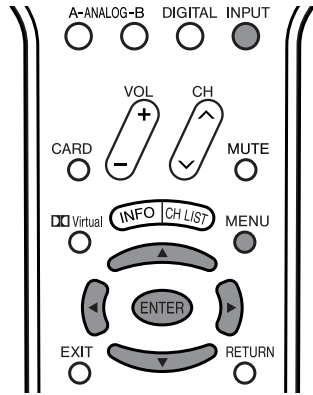

- 1 Press **MENU** and the MENU screen displays.
- 2 Press **◀▶** to select "Setup".
- 3 Press **▲/▼** to select "Input Label", and then press **ENTER**.
- 4 Press **▲/▼/◀▶** to select the new name for the channel, and then press **ENTER**.

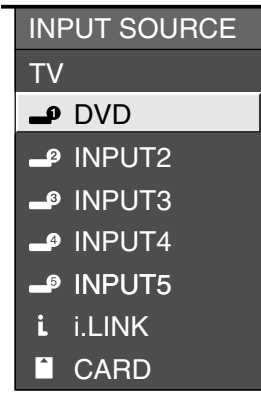

(Example)

#### NOTE

- You cannot change labels if the INPUT SOURCE is TV, i.LINK or CARD.

### Picture Flip

You can set the orientation of the picture.

- 1 Repeat steps 1 and 2 in **Input Label**.
- 2 Press **▲/▼** to select "Picture Flip", and then press **ENTER**.
- 3 Press **▲/▼** to select the desired mode, and then press **ENTER**.

[Standard]: normal image.

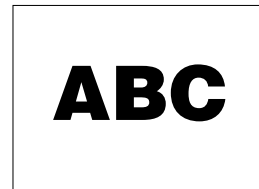

[Mirror]: mirror image.



[Upside Down]: upside down image.



[Rotate]: rotated image.



## Useful adjustment settings

### AV MODE

AV MODE gives you six viewing options to choose from to best match environment of the System, which can vary due to factors like room brightness, type of program watched or the type of image input from external equipment.

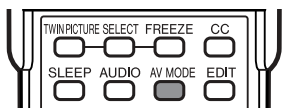

1

Press **AV MODE**.

- Present AV MODE displays.

2

Press **AV MODE** again before the mode displayed on the screen disappears.

- The mode changes as shown below.

#### Mode selection for TV, INPUT 1 to 5, i.LINK and CARD mode (Example)

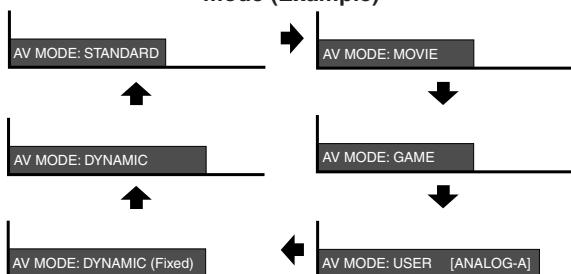

#### Mode selection for the PC terminal (Example)



Selected item	Description
<b>STANDARD</b>	For a highly defined image in a normally bright room
<b>MOVIE</b>	For a movie
<b>GAME</b>	Lowers image brightness for easier viewing
<b>USER</b>	Allows the user to customize settings as desired. You can set the mode for each input source.
<b>DYNAMIC (Fixed)</b>	Changing image and sound settings to factory preset values. No adjustments are allowed.
<b>DYNAMIC</b>	For a clear-cut image emphasizing high contrast for sports viewing

#### NOTE

- You can select a different AV MODE item for each input mode. (For example, select STANDARD for TV input and DYNAMIC for VIDEO input.)
- When AV MODE is set to DYNAMIC (Fixed), “No picture adjustments available in Dynamic (Fixed) mode” displays.

### View mode for 4:3 Programs

1

Press **VIEW MODE**.

- The View mode menu displays.
- The menu lists the view mode options selectable for the type of video signal currently received.

2

Press **VIEW MODE** or ▲/▼ while the View mode menu is still on the screen.

- You can sequentially select a view mode that has its own aspect ratio.

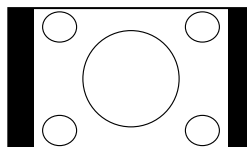
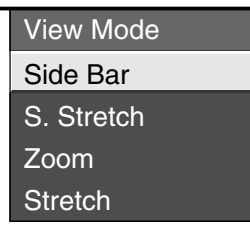
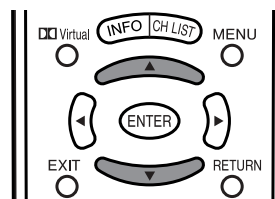

**Side Bar:** Suitable for viewing conventional 4:3 programs in their normal format.

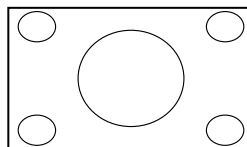

**S.Stretch: (Smart stretch)** Suitable for stretching 4:3 programs to fill the screen.

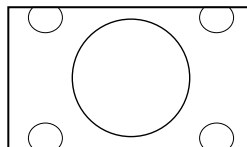

**Zoom:** Suitable for viewing wide-screen 2.35:1 anamorphic DVDs in full screen.

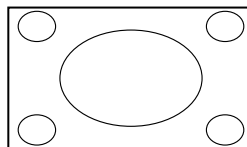

**Stretch:** This mode is useful for 1.78:1 DVDs. When viewing 1.85:1 DVDs, stretch mode will still show very thin black bands at the top and bottom of the screen.

# Useful adjustment settings

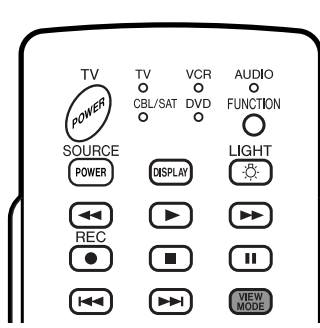

**EXAMPLE**

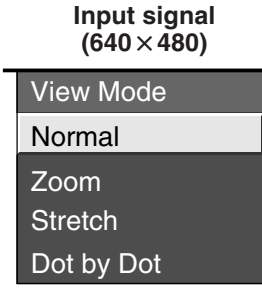

## View mode (for PC input mode)

You can select the screen size.

**NOTE**

- Connect the PC before making adjustments. (See page 55.)
- Selectable screen size may vary with input signal type.

**1** Press **VIEW MODE**.

- The View mode menu displays.

**2** Press **VIEW MODE** or **▲/▼** to select a desired item on the menu.

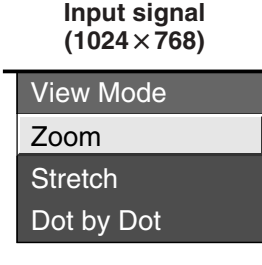
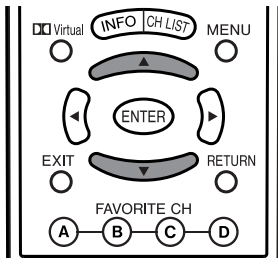

**EXAMPLE**

Screen size images.

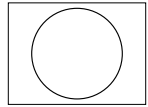
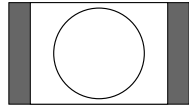
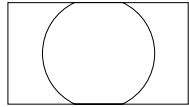
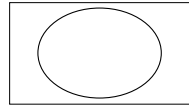
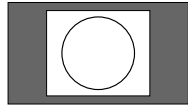
Input signal	Normal	Zoom	Stretch	Dot by Dot
 ex. 640 × 480	 Keeps the original aspect ratio in a full screen display.	 Keeps the original aspect ratio in a full screen display. The top and bottom of the image is slightly cropped.	 An image fully fills the screen.	 Detects the resolution of the signal and displays an image with the same number of pixels on the screen.

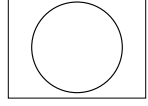
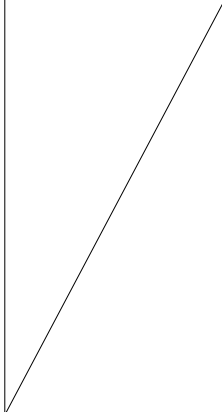
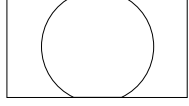
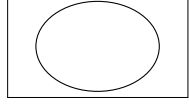
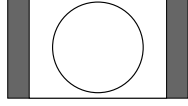
Input signal	Normal	Zoom	Stretch	Dot by Dot
 1024 × 768	 (This cell is empty in the original image)	 Keeps the original aspect ratio in a full screen display. The top and bottom of the image is slightly cropped.	 An image fully fills the screen.	 Detects the resolution of the signal and displays an image with the same number of pixels on the screen.

## Useful adjustment settings

### Input signal (for PC input mode)

- Some input signals may have to be registered manually to display properly.
- The pairs of input signals (resolutions) in the list below are not distinguishable when received. In such case, you have to set the correct signal manually. After setting once, it will display when the same signal (resolution) is input again.

640 × 400	720 × 400
640 × 480	848 × 480
1024 × 768	1280 × 768

#### NOTE

- You can only select the "Input Signal" on the Setup menu when receiving one of the 6 input signals listed above.

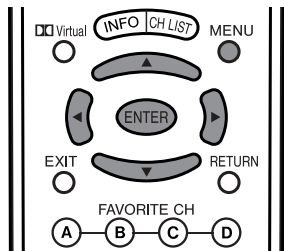

- 1 Press **MENU** and the MENU screen displays.
- 2 Press **◀/▶** to select "Setup".
- 3 Press **▲/▼** to select "Input Signal" and then press **ENTER**.
- 4 Press **▲/▼** to select the desired input signal on the display.

#### Example

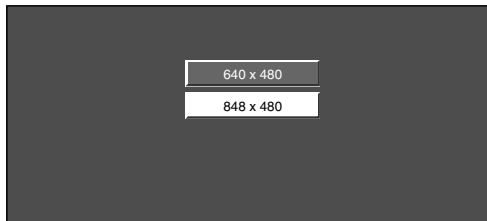

### Digital Noise Reduction

Produces a clearer video image.

- 1 Press **MENU** and the MENU screen displays.
- 2 Press **◀/▶** to select "Option".
- 3 Press **▲/▼** to select "Digital Noise Reduction", and then press **ENTER**.
- 4 Press **▲/▼** to select the desired level, and then press **ENTER**.

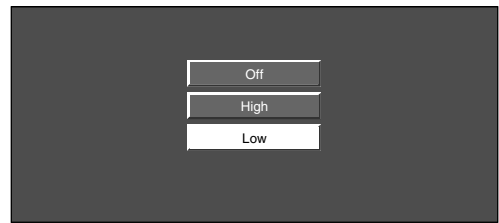

### Audio Only

When listening to music from a music program, you can set the Liquid Crystal display off and enjoy audio only.

- 1 Repeat steps 1 and 2 in **Digital Noise Reduction**.
- 2 Press **▲/▼** to select "Audio Only", and then press **ENTER**.
- 3 Press **◀/▶** to select "On", and then press **ENTER**.

Selected item	Description
On	Audio is output without screen image.
Off	Both screen images and audio are output.

## Useful adjustment settings

### Output Select

Allows you to select what controls the audio output.

- 1 Press **MENU** and the MENU screen displays.
- 2 Press **◀/▶** to select "Option".
- 3 Press **▲/▼** to select "Output Select", and then press **ENTER**.
- 4 Press **◀/▶** to select "Fixed" or "Variable", and then press **ENTER**.

Selected item	Description
<b>Fixed</b>	<ul style="list-style-type: none"> <li>• Sound via speaker is adjusted with <b>VOL +/-</b> on the remote control unit or <b>VOL +/-</b> on the Display.</li> <li>• Sound via the MONITOR OUTPUT terminal is not adjustable and constantly outputs.</li> </ul>
<b>Variable</b>	<ul style="list-style-type: none"> <li>• Sound via the MONITOR OUTPUT terminal is adjusted with <b>VOL +/-</b> on the remote control unit or <b>VOL +/-</b> on the Display.</li> <li>• Sound via speaker is muted.</li> </ul>

### Quick Shoot

Use Quick Shoot Operation to record action video more clearly.

- 1 Repeat steps 1 and 2 in **Output Select**.
- 2 Press **▲/▼** to select "Quick Shoot", and then press **ENTER**.
- 3 Press **◀/▶** to select "On", and then press **ENTER**.

#### NOTE

- Quick Shoot may cause image noise. If this occurs turn the function "Off".

### Sleep timer

Allows you to set a time when the TV automatically switches to standby.

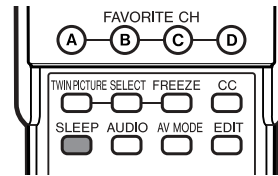

- 1 Press **SLEEP**.
  - Remaining time displays when sleep timer has been set.

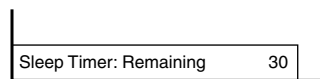

- 2 Each time you press **SLEEP**, the remaining time switches as shown below.
  - When set, the time automatically starts counting down.
  - If you want to adjust the sleep timer, you can press **SLEEP** twice then change the time setting.
  - Five minutes before time expires, the remaining time displays each minute.

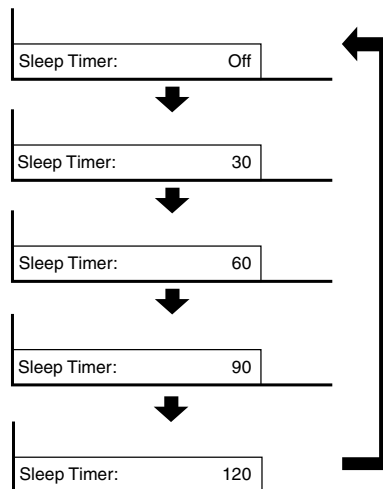

#### NOTE

- Select "OFF" by pressing **SLEEP** to cancel the sleep timer.
- If the sleep timer is activated when set to zero, the TV will enter STANDBY mode.



## Useful adjustment settings

---

### Title Display Type

Select the CH display for Digital broadcasting.

**1** Press **MENU** and the MENU screen displays.

**2** Press ◀▶ to select "Setup".

**3** Press ▲/▼ to select "Title Display Type", and then press **ENTER**.

**4** Press ◀▶ to select "On" or "Off", and then press **ENTER**.

Selected item	Description
On	"Channel call" displays
Off	"Channel call" does not display

## Useful adjustment settings

### Closed caption

- Your TV is equipped with an internal closed caption decoder. Closed caption is the system which allows you to view conversations, narration, and sound effects in TV programs and home videos as subtitles on your Display.
- Not all programs and videos offer closed caption. Please look for the “**CC**” symbol to ensure that captions will be shown.
- “CC1” or “CC2” displays subtitles of TV dramas and news programs while allowing a full view of the picture.
- “Text1” or “Text2” superimposes on the picture other information (e.g. TV guide, weather) that is independent of the TV in progress.

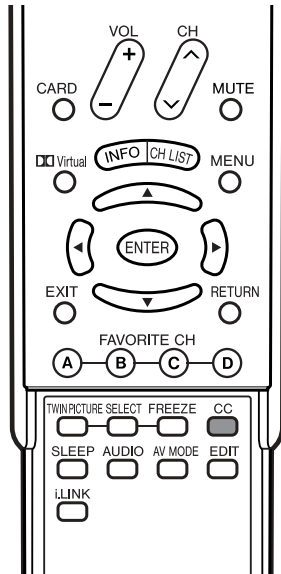

1

Press **CC**.

- Present Closed caption information displays.

2

Press **CC** while the Closed caption information is still on the screen.

- You can sequentially select a closed caption service which you prefer.

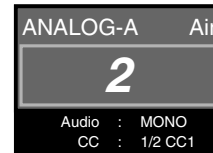

Closed caption information

- Depending on the signal, information such as 1/4 or 1/2 will appear. 1/2 shows the first of two services.

Example:

When a program has two services (CC1 and Text 1), closed caption will toggles like below.

1/2 CC1 → 2/2 Text1 → OFF

#### NOTE

- See page 74 to 76 for the detailed closed caption settings.
- When using Twin Picture functions (see page 86), Closed Caption the program on the active screen will be displayed.
- When using Freeze functions, closed caption will not be displayed on the right screen (still image).
- When the program contains no closed caption, “ — ” displays in the closed caption information.
- Four kinds of closed caption service(CC1, CC2, Text1, Text2) are available. However, selectable service(CC1, CC2, Text1, Text2) are depends on the programs contains.

## Useful adjustment settings

### Caption Size

Select a caption size.

**1** Press **MENU** and the MENU screen displays.

**2** Press ◀/▶ to select "Option".

**3** Press ▲/▼ to select "Caption Setup".

**4** Press ▲/▼ to select "Caption Size".

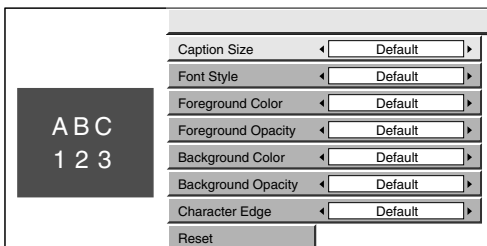

**5** Press ◀/▶ to select the desired size.

#### NOTE

- Default: The caption size specified by broadcasting station or default size.
- For resetting all adjustment items to the factory preset values, press ▲/▼ to select "Reset", and then press **ENTER**.

### Font Style

Select a font style.

**1** Press **MENU** and the MENU screen displays.

**2** Press ◀/▶ to select "Option".

**3** Press ▲/▼ to select "Caption Setup".

**4** Press ▲/▼ to select "Font Style".

**5** Press ◀/▶ to select the desired style.

Selected item	Description
<b>Default</b>	The font specified by broadcasting station or default font.
<b>Type 0</b>	Proportional font used in the MENU screen.
<b>Type 1</b>	Monospaced with serifs.
<b>Type 2</b>	Proportionally spaced with serifs.
<b>Type 3</b>	Monospaced without serifs.
<b>Type 4</b>	Proportionally spaced without serifs.
<b>Type 5</b>	Casual font type.
<b>Type 6</b>	Cursive font type.
<b>Type 7</b>	Small capitals.

#### NOTE

- For resetting all adjustment items to the factory preset values, press ▲/▼ to select "Reset", and then press **ENTER**.

## Useful adjustment settings

### Foreground Color

Select a character foreground color.

**1** Press **MENU** and the MENU screen displays.

**2** Press **◀/▶** to select "Option".

**3** Press **▲/▼** to select "Caption Setup".

**4** Press **▲/▼** to select "Foreground Color".

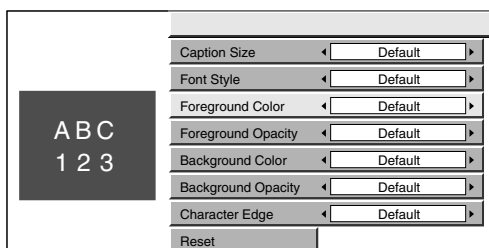

**5** Press **◀/▶** to select the desired color.

#### NOTE

- Default: The foreground color specified by broadcasting station or default color.
- For resetting all adjustment items to the factory preset values, press **▲/▼** to select "Reset", and then press **ENTER**.

### Foreground Opacity

Select a foreground opacity value.

**1** Repeat steps 1 to 3 in **Foreground Color**.

**2** Press **▲/▼** to select "Foreground Opacity".

**3** Press **◀/▶** to select the desired value.

#### NOTE

- Default: The foreground opacity value specified by broadcasting station or default opacity value.
- For resetting all adjustment items to the factory preset values, press **▲/▼** to select "Reset", and then press **ENTER**.

### Background Color

Select a character background color.

**1** Repeat steps 1 to 3 in **Foreground Color**.

**2** Press **▲/▼** to select "Background Color".

**3** Press **◀/▶** to select the desired color.

#### NOTE

- Default: The background color specified by broadcasting station or default color.
- For resetting all adjustment items to the factory preset values, press **▲/▼** to select "Reset", and then press **ENTER**.

## Useful adjustment settings

---

### Background Opacity

Select a background opacity value.

**1** Press **MENU** and the MENU screen displays.

**2** Press ◀/▶ to select “Option”.

**3** Press ▲/▼ to select “Caption Setup”.

**4** Press ▲/▼ to select “Background Opacity”.

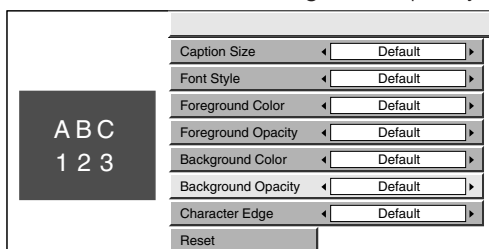

**5** Press ◀/▶ to select the desired value.

#### NOTE

- Default: The background opacity value specified by broadcasting station or default opacity value.
- For resetting all adjustment items to the factory preset values, press ▲/▼ to select “Reset”, and then press **ENTER**.

### Character Edge

Select a character edge.

**1** Press **MENU** and the MENU screen displays.

**2** Press ◀/▶ to select “Option”.

**3** Press ▲/▼ to select “Caption Setup”, and then press **ENTER**.

**4** Press ▲/▼ to select “Character Edge”.

**5** Press ◀/▶ to select the desired setting.

#### NOTE

- Default: The character edge specified by broadcasting station or default edge.
- For resetting all adjustment items to the factory preset values, press ▲/▼ to select “Reset”, and then press **ENTER**.

## Useful adjustment settings

### Secret number setting for parental control (AV input mode only)

Allows you to use a secret number to protect certain settings from being accidentally changed.

#### IMPORTANT:

Three conditions must be met to enable V-Chip (see pages 79 to 83):

- ① Secret No. is registered.
- ② V-Chip settings have been made.
- ③ "Status" is set to "On".

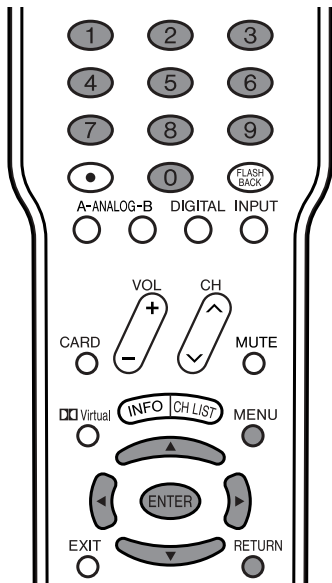

### Setting a secret number

**1** Press **MENU** and MENU screen displays.

**2** Press **◀/▶** to select "Setup".

**3** Press **▲/▼** to select "Parental CTRL", and then press **ENTER**.

**4** Press **▲/▼** to select "Secret No.", and then press **ENTER**.

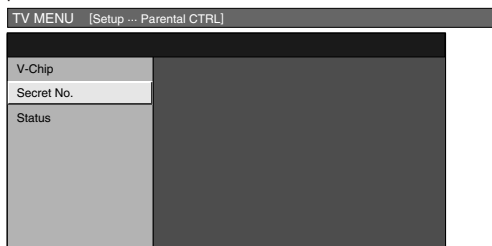

**5**

Select "New Secret No.", and then press **ENTER**.

Input the new 4-digit secret number by using **0 - 9**.

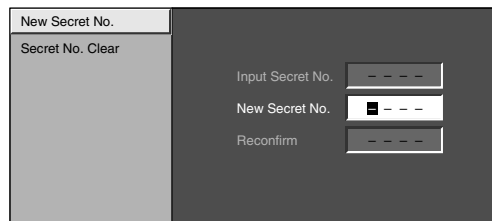

**6**

Input the same 4-digit number on the "Reconfirm" screen as in step 5 to confirm.

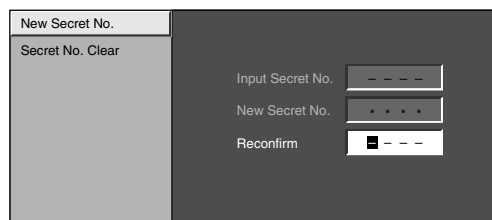

**7**

Press **RETURN** to start configuring V-Chip settings. (See pages 80 and 82 for details.)

### Setting parental control status

Used to enable or disable the parental control function.

**1**

Repeat steps 1 to 3 in **Setting a secret number**.

- Secret number setting menu displays.

**2**

Input the 4-digit secret number by using **0 - 9**.

**3**

Press **▲/▼** to select "Status", and then press **ENTER**.

**4**

Press **◀/▶** to select "On" or "Off", and then press **ENTER**.

- Select "On" to enable and "Off" to disable Parental CTRL.

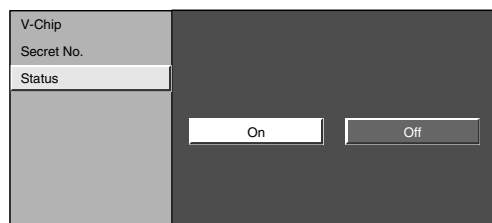

#### NOTE

- You can skip step 1 and 2 above while in Parental CTRL screen.

## Useful adjustment settings

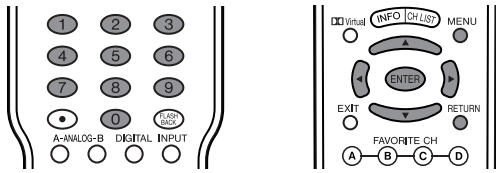

### Changing the secret number

Allows you to change your current secret number.

- 1 Repeat steps 1 to 3 in **Setting a secret number**.
  - Secret number setting menu displays.
- 2 Input the 4-digit secret number by using **0 – 9**.
- 3 Press **▲/▼** to select “Secret No.”, and then press **ENTER**.
- 4 Press **▲/▼** to select “New Secret No.”, and then press **ENTER**.
- 5 Input the old 4-digit number you have set using **0 – 9**.

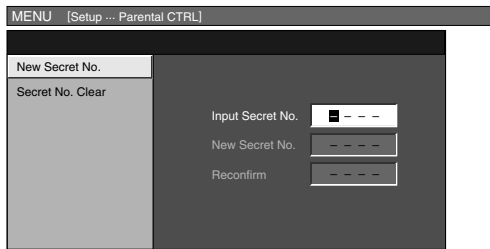

- 6 Input the new 4-digit number using **0 – 9**.

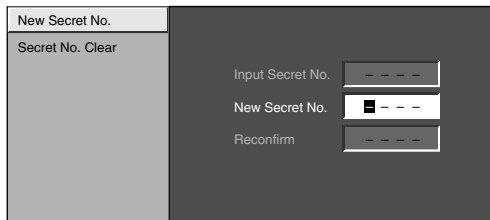

- 7 Input the same 4-digit number on the “Reconfirm” screen as in step 6 to confirm.

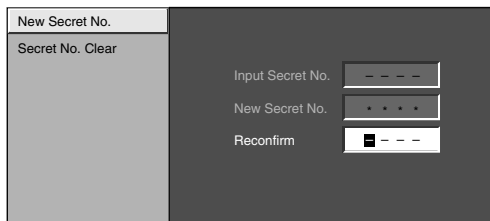

### Clearing the secret number

Allows you to clear your secret number.

- 1 Repeat steps 1 to 3 in **Setting a secret number**.
  - Secret number setting menu displays.
- 2 Input the 4-digit secret number by using **0 – 9**.
- 3 Press **▲/▼** to select “Secret No.”, and then press **ENTER**.
- 4 Press **▲/▼** to select “Secret No. Clear”, and then press **ENTER**.
- 5 Press **◀/▶** to select “Yes”, and then press **ENTER**.
  - Your secret number is cleared.

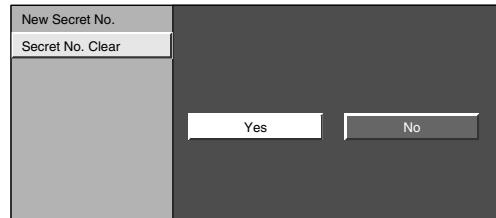

#### NOTE

- See page 77 for re-registering with a new secret number after being cleared.
- **As a precautionary measure, make a note of your secret number and keep it in a familiar place. If you lose or forget your secret number, initialize the Liquid Crystal Television to return all settings except for the TV channel settings to factory preset values. (See page 100.)**
- If the secret number is cleared the Status setting automatically sets to “Off”. “V-Chip” and “Status” will not be selectable from the menu.

## Useful adjustment settings

### Parental control (setting V-CHIP level)

V-CHIP is an electronic filtering device built into your TV. This tool gives parents a great degree of control over broadcasts accessed by their children. It allows parents to select programs judged suitable for child viewing while blocking ones judged not suitable. It does so automatically once you activate the V-CHIP feature in your Liquid Crystal Television.

**“V-Chip” and “Status” will not be selectable from the menu if you do not first configure your secret number.** (See page 77 for Secret number setting for parental control.)

- The U.S. has two rating systems for viewing content: TV Parental Guidelines and movie ratings.
- The TV Parental Guidelines work in conjunction with the V-CHIP to help parents screen out inappropriate television shows from their children.
- Movie ratings are used for original movies rated by the Motion Picture Association of America (MPAA) as watched on cable TV and not edited for television. The V-CHIP can also be set to block MPAA-rated movies.

### Voluntary movie rating system (MPAA)

Rating		Description
Age	G	General audiences. All ages admitted.
	PG	Parental guidance suggested. Some material may not be suitable for children.
	PG-13	Parents strongly cautioned. Some material may be inappropriate for children under 13.
	R	Restricted. Under 17 requires accompanying parent or adult guardian (age varies in some jurisdictions).
	NC-17	No one 17 and under admitted.
	X	X is an older rating that is unified with NC-17 but may be encoded in the data of older movies.

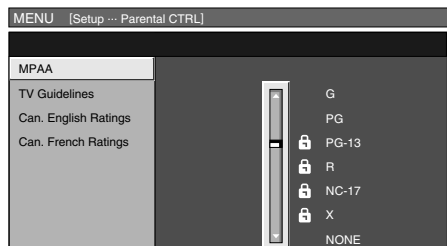

#### EXAMPLE

- If you select “PG-13”, this will automatically block the higher ratings “R”, “NC-17” and “X”.

#### NOTE

- Voluntary movie rating system only uses an age-based rating.

### TV Parental Guidelines

Rating		Content				
		FV (Fantasy violence)	V (Violence)	S (Sexual situation)	L (Adult language)	D (Sexually suggestive dialog)
Suggested age	TV-Y (All children)					
	TV-Y7 (Directed to older children)	X				
	TV-G (General audience)					
	TV-PG (Parental Guidance suggested)		X	X	X	X
	TV-14 (Parents strongly cautioned)		X	X	X	X
	TV-MA (Mature audience only)		X	X	X	

X: Content rating can be set.



## Useful adjustment settings

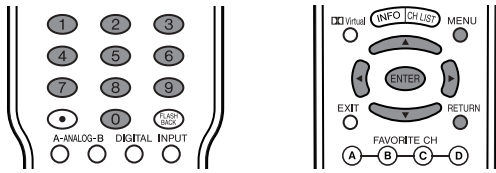

### Voluntary movie rating system (MPAA)

**1** Press **MENU** and the MENU screen displays.

**2** Press **◀/▶** to select "Setup".

**3** Press **▲/▼** to select "Parental CTRL", and then press **ENTER**.

- Secret number setting menu displays only when "Secret No." is set. (See page 77.)
- "V-Chip" and "Status" will not be selectable from the menu if you do not first configure your secret number. (See page 77.)

**4** Input the 4-digit secret number by using **0-9**.

**5** Press **▲/▼** to select "V-Chip", and then press **ENTER**.

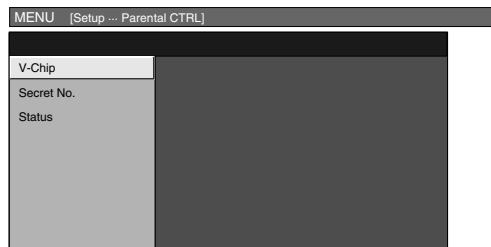

**6** Press **▲/▼** to select "MPAA", and then press **ENTER**.

**7** Press **▲/▼** to adjust the item to your desired position. "🔒" indicates the item is blocked. Press **RETURN**.

- The setting automatically enters "Block" for any ratings below your selection.
- If Status is not set to "On" the configuration settings will not work. (See page 77.)

#### Example

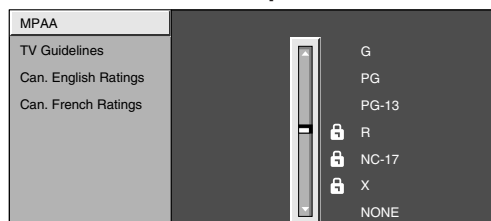

### TV Parental Guidelines (TV Guidelines)

**1** Repeat steps 1 to 5 in **Voluntary movie rating system (MPAA)**.

**2** Press **▲/▼** to select "TV Guidelines", and then press **ENTER**.

**3** Press **▲/▼** to adjust the item to your desired position. "🔒" indicates the item is blocked.

- The setting automatically enters "Block" for any ratings below your selection.

#### Example

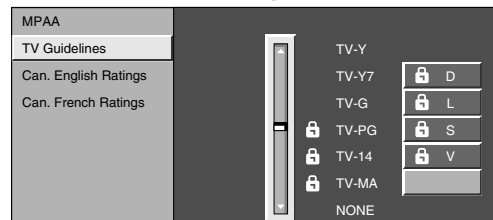

When setting an individual content-based rating item, do as follows:

- ① Press **▶** to access block content items from the currently selected age-based rating item.
- ② Press **▲/▼** to select an individual item, and then press **ENTER** to unblock ("🔒" is removed). Repeat the same steps for other items.
- ③ Press **◀** or **RETURN** to register after all individual content rating items are set.

#### Example

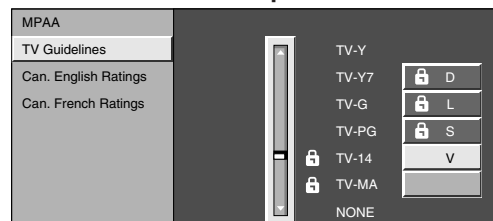

- If Status is not set to "On" the configuration settings will not work. (See page 77.)

## Useful adjustment settings

### Canadian Rating Systems

- The TV rating systems in Canada are based on the Canadian Radio-Television and Telecommunications Commission (CRTC) policy on violence in television programming.
- While violence is the most important content element to be rated, the structure developed takes into consideration other program content like language, nudity, sexuality and mature themes.
- When setting the V-CHIP on the Canadian system you can choose either the Canadian English ratings or the Canadian French ratings.

### Canadian English ratings

Rating		Description
Age	E	Exempt: Includes news, sports, documentaries and other information programming; talk shows, music videos, and variety programming.
	C	Children: Intended for younger children under the age of 8 years. Pays careful attention to themes that could threaten their sense of security and well-being.
	C8+	Children over 8 years old: Contains no portrayal of violence as the preferred, acceptable, or only way to resolve conflict; nor encourage children to imitate dangerous acts which they may see on the screen.
	G	General: Considered acceptable for all age groups. Appropriate viewing for the entire family, contains very little violence, physical, verbal or emotional.
	PG	Parental Guidance: Intended for a general audience, but may not be suitable for younger children (under the age of 8) because it could contain controversial themes or issues.
	14+	Over 14 Years: Could contain themes where violence is one of the dominant elements of the storyline, but it must be integral to the development of plot or character. Language usage could be profane and nudity present within the context of the theme.
	18+	Adults: Intended for viewers 18 years and older and might contain depictions of violence, which while related to the development of plot, character or themes, are intended for adult viewing. Could contain graphic language and portrayals of sex and nudity.

### Canadian French ratings

Rating		Description
Age	E	Exempt programming.
	G	General: All ages and children, contains minimal direct violence, but may be integrated into the plot in a humorous or unrealistic manner.
	8ans +	General but inadvisable for young children: May be viewed by a wide public audience, but could contain scenes disturbing to children under 8 who cannot distinguish between imaginary and real situations. Recommended for viewing with parent.
	13ans +	Over 13 years: Could contain frequent violent scenes and therefore recommended for viewing with parent.
	16ans +	Over 16 years: Could contain frequent violent scenes and intense violence.
	18ans +	Over 18 years: Only for adult viewing. Could contain frequent violent scenes and extreme violence.

## Useful adjustment settings

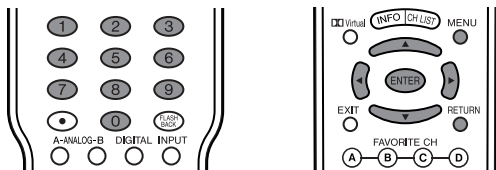

### Canadian English ratings

**1** Press **MENU** and the MENU screen displays.

**2** Press **◀/▶** to select "Setup".

**3** Press **▲/▼** to select "Parental CTRL", and then press **ENTER**.

- Secret number setting menu displays only when "Secret No." is set. (See page 77.)
- "V-Chip" and "Status" will not be selectable from the menu if you do not first configure your secret number. (See page 77.)

**4** Input the 4-digit secret number by using **0 – 9**.

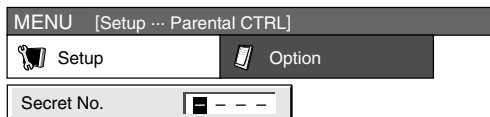

**5** Press **▲/▼** to select "V-Chip", and then press **ENTER**.



**6** Press **▲/▼** to select "Can. English Ratings", and then press **ENTER**.

**7**

Press **▲/▼** to adjust the item to your desired position. "🔒" indicates the item is blocked.

- The setting automatically enters "Block" for any ratings below your selection.
- If Status is not set to "On" the configuration settings will not work. (See page 77.)

#### Example

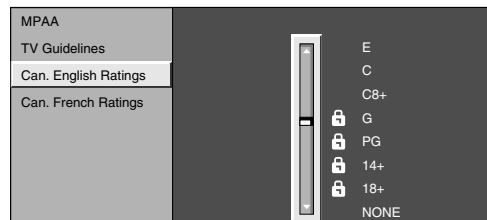

### Canadian French ratings

**1** Repeat steps 1 to 5 in **Canadian English ratings**.

**2** Press **▲/▼** to select "Can. French Ratings", and then press **ENTER**.

**3** Press **▲/▼** to adjust the item to your desired position. "🔒" indicates the item is blocked.

- The setting automatically enters "Block" for any ratings below your selection.
- If Status is not set to "On" the configuration settings will not work. (See page 77.)

#### Example

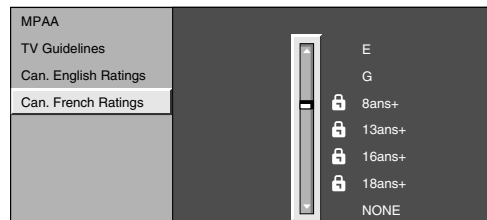

## Useful adjustment settings

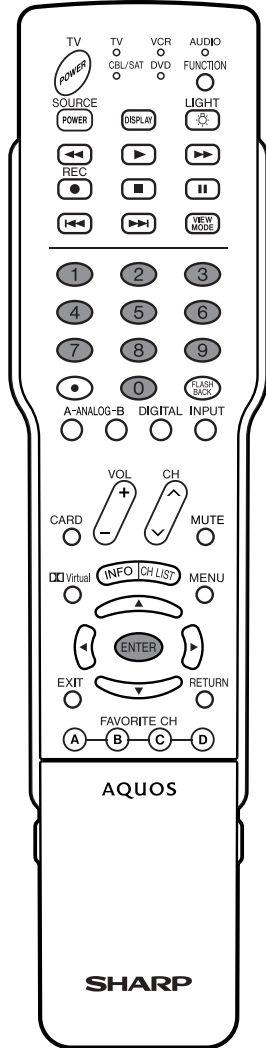

### How to temporarily release the V-CHIP BLOCK

- The V-CHIP BLOCK is working and censors a broadcast, "V-CHIP HAS BEEN ACTIVATED." displays.

**1**

Press **ENTER** while the V-CHIP is working and then the secret number setting menu displays.

**2**

Enter your 4-digit secret number with **0 – 9** and then press **ENTER**. At this time V-CHIP BLOCK temporarily releases.

### Reactivating the temporarily released V-CHIP BLOCK

- You can reactivate the temporarily released V-CHIP BLOCK as shown below.

#### Method 1:

Select "Status" setting from the Parental CTRL menu to reactivate BLOCK. See page 77.

#### Method 2:

Select "V-Chip" setting ("MPAA", "TV Guidelines", "Can. English Ratings" or "Can. French Ratings") from the Parental CTRL to reactivate BLOCK. See pages 80 and 82.

#### Method 3:

Switch off the TV power.

#### NOTE

- Performing any of the three above will activate the V-CHIP BLOCK.

## Useful adjustment settings

### Center Channel Input

You can use the display speakers as center speaker when using 5.1ch surrounding sound system.

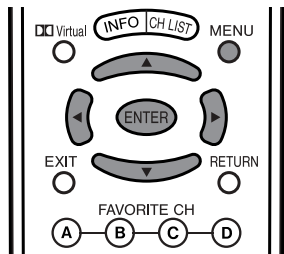
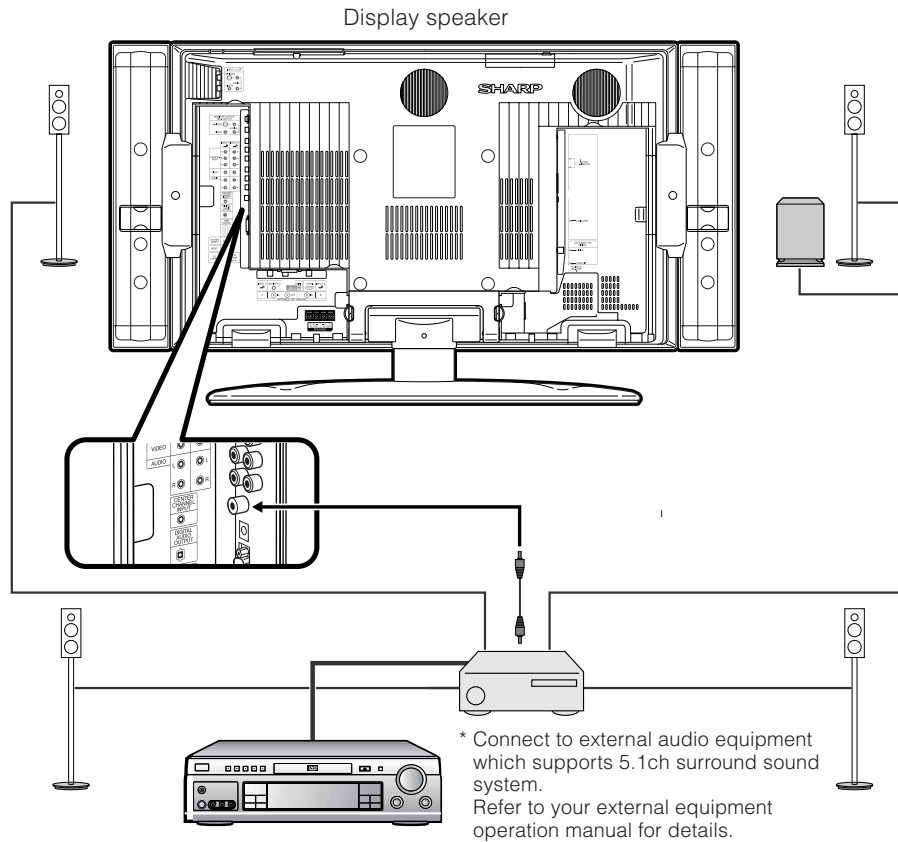

- 1 Press **MENU** and the MENU screen displays.
- 2 Press **◀/▶** to select "Option", and then press **ENTER**.
- 3 Press **▲/▼** to select "Center Channel Input", and then press **ENTER**.

- 4 Press **◀/▶** to select "On", and then press **ENTER**.

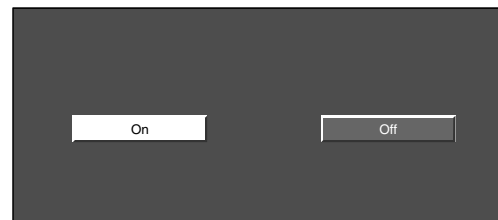

#### NOTE

- Sound from Center Channel Input terminal is output from the display speaker.

# Other viewing options

## Viewing a list of Digital broadcast channels

You can view a list of all currently watchable digital broadcast channels.

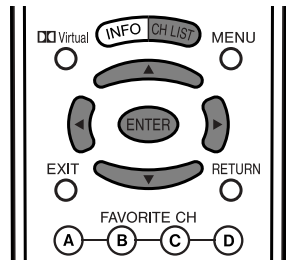

- 1 Push **CH LIST** while watching a digital broadcast.
  - A list of all digital channels (over-the-air or cable) currently watchable will be displayed.

Air/Cable	
CH LIST	
[DTV-Air]	
Broadcast station	
WGBH-SD	2.1
CH. Number	
PBS-HD	2.2
WGBH-DX	2.10

(Example) Channel List Screen for Over-the-Air Broadcasts

- 2 Press **▲/▼** to select the channel you want to watch, and then press **ENTER** to display the selected channel.

- 3 Press **◀/▶** to scroll between pages of the Channel List.

## Viewing information of the program

You can view information about a digital broadcast you are currently watching.

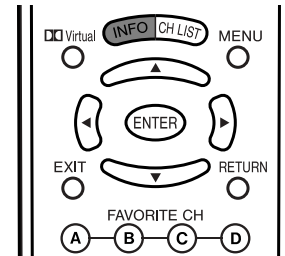

- 1 Press **INFO** while watching a digital broadcast.
  - Information of the current program will be displayed.

Broadcast station	WGBH-SD																							
Program	WGBH DTV Broadcast Signal																							
Program information	<table border="1"> <tr> <th colspan="4">Input Info.</th> </tr> <tr> <td>Video</td> <td>480i</td> <td>Optic.</td> <td>REC OK</td> </tr> <tr> <td>Audio</td> <td>Stereo</td> <td>i.Link</td> <td>REC OK</td> </tr> <tr> <td>C.C.</td> <td>--</td> <td></td> <td></td> </tr> <tr> <td>Rating</td> <td>--</td> <td></td> <td></td> </tr> </table>				Input Info.				Video	480i	Optic.	REC OK	Audio	Stereo	i.Link	REC OK	C.C.	--			Rating	--		
Input Info.																								
Video	480i	Optic.	REC OK																					
Audio	Stereo	i.Link	REC OK																					
C.C.	--																							
Rating	--																							

Sample program information

### NOTE

- Sometimes the name of the program is not broadcast. In that case, the program name will not be displayed.

## Other viewing options

### Twin picture functions

Allows you to display two pictures on the screen at one time.

#### Twin picture in all cases

You can display two same-sized pictures except when inputting from INPUT 4 (HDMI) and INPUT 5 (DVI-I) terminals and CARD.

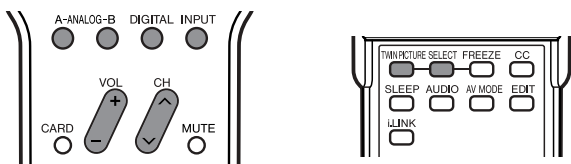

1

Press **TWIN PICTURE**.

- Twin picture displays and a selected input source image displays.



2

Press **SELECT** to set either screen to be active.

- “♪” displays on the active screen, which has sound output.

3

Press **TWIN PICTURE** to exit twin picture.

#### NOTE

- This function does not work under the following input conditions:
  - ① INPUT 4 (HDMI)
  - ② INPUT 5 (DVI-I)
  - ③ CARD
  - ④ Two pictures from the same source (e.g. INPUT 1 and INPUT 1)
  - ⑤ An image will appear on the right side only if it is a 480i signal.
    - \*An SDTV image has a 480p signal, so it will not appear either.
- When this function is not available, “No dual screen display available” will display.
- Pressing **ANALOG-A, B, DIGITAL** while viewing in Twin Picture mode (TV image and video image) with TV selected will display the TV image of the other tuner. Picture and still image

### Picture and still image

You can display two same-sized pictures – one moving and one still.

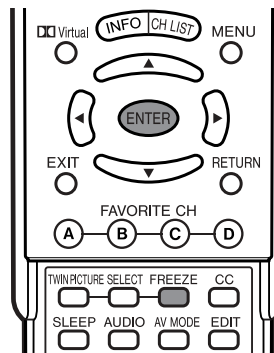

1

Press **FREEZE**.

- A moving image displays on the left screen and a still image displays on the right screen. The still image is one frame captured from a moving image at the moment you press **FREEZE**.

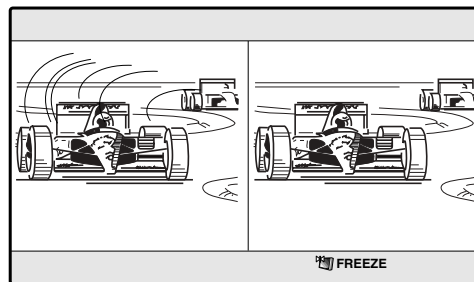

2

Update the still image by pressing **ENTER**.

- Each time you press **ENTER**, the image on the right screen updates.
- If a PC card with enough capacity is inserted in the system, a message will appear on the screen asking you whether to save the image. Press **REC** on the remote control if you want to save. (See page 44.)

3

Press **FREEZE** to exit still image.

#### NOTE

- This function does not work in INPUT 4 (HDMI), INPUT 5 (DVI-I) and CARD.
- When this function is not available, “No displaying still image” will display.
- Another image can be saved if a PC card with enough capacity is inserted in the system.
- The still image is automatically erased after 30 minutes.
- If you are using FREEZE and a broadcast activates the V-CHIP BLOCK, FREEZE will cancel and a block message will appear.

## Other viewing options

### Presetting remote control function

You can operate the connected AV products (AV Receiver, Cable Box, SAT tuner, DTV, VCR, DVD, LD) using the presetting manufacturer function for your remote control unit.

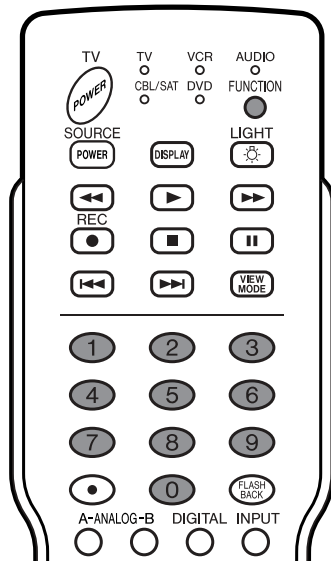

### Presetting manufacturer codes

1

Press **FUNCTION** until the LED for your device lights up.

2

After the LED for your device lights up, if you press **FUNCTION** for three seconds and enter the code registration mode, the LED will blink.

3

Press **0 – 9** to enter the manufacturer code. (See page 88.)

- Preset mode is finished once the LED no longer lights up.

4

After registering the code, the LED will stop blinking then turn off after one second. (If you perform an incorrect operation, the LED will blink quickly then turn off.)



## Other viewing options

### Manufacturer codes

VCR BRAND	REMOTE CONTROL CODE NUMBER
Akai	25, 26, 37
Audio	15, 22, 30
Broksonic	32
Canon	04
Capehart	34
Craig	10, 31
Curtis Mathis	04
Daewoo	34
DBX	15, 22, 30
Dynatech	29
Emerson	21, 32, 35
Fisher	09, 10, 11
Funai	28, 29
G.E.	04
Goldstar	24
Hitachi	06, 47
Instant Replay	04
JC Penney	04, 06, 24, 30
JVC	15, 41, 42, 53
Kenwood	14, 15
Lloyds	29
Magnavox	04, 05, 08
Magnin	31
Marantz	30
Memorex	04, 10, 24, 29
Minolta	06
Mitsubishi	17, 18, 39, 40
Montgomery Ward	02, 43
Multitech	29
NEC	15, 22, 30
Panasonic	44, 45
Pentax	05, 06
Philco	05
Philips	05, 08
RCA	06, 07, 33, 51
Realistic	01, 02, 10, 24
Samsung	23, 31
Sanyo	10, 14, 52
Scott	20
Sears	06, 11, 24
Sharp	01, 02, 03
Shintom	36
Sony	12, 13, 38
Sound Design	29
Sylvania	05, 08
Symphonic	29
Tatung	15
Teac	15, 29
Teknika	27, 29
Thomas	29
TMK	21
Toshiba	19, 20
Video Concepts	30
Yamaha	15, 29, 30
Zenith	16

DVD/LD BRAND	REMOTE CONTROL CODE NUMBER
Denon	02
JVC	09, 13
Kenwood	21
Magnavox	04
Marantz	04
Mitsubishi	06
Panasonic	02, 22
Philips	04, 23
Pioneer	08, 11, 20
Proscan	03
RCA	03, 24
Samsung	07, 12
Sharp	01, 10
Sony	05, 25
Toshiba	04
Yamaha	02
Zenith	04

CATV CONVERTER BRAND	REMOTE CONTROL CODE NUMBER
Anvision	04, 05
Cable Star	04, 05
Eagle	05
General Instrument	02, 03, 07, 12, 13, 14, 19, 22
Jerrold	02, 03, 07, 12, 13, 14, 19, 22, 31, 32, 33, 34, 35, 36, 37, 38, 39, 40
Magnavox	04, 05, 09, 14, 17, 18, 20, 21, 24, 25
Oak Sigma	8
Panasonic	16, 23
Philips	04, 05, 09, 15, 17, 18, 20, 21, 24, 25
Pioneer	08, 10, 29, 30, 46
Randtek	04, 05
RCA	16, 27, 44, 45
Scientific Atlanta	01, 26
Sony	28
Viewstar	04, 05, 09, 15, 17, 18, 20, 21, 24, 25
Zenith	06, 14

AUDIO BRAND	REMOTE CONTROL CODE NUMBER
Sharp	01

## Other viewing options

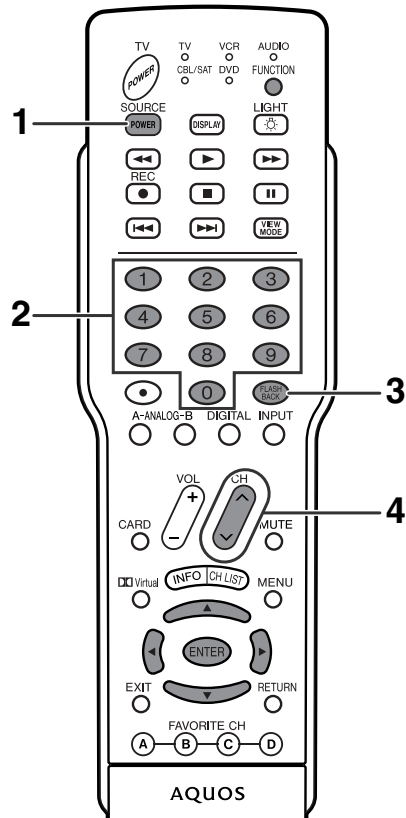

### Cable control buttons

When the **FUNCTION** is set to CBL/SAT the cable converter connected to the Display can operate using **1** to **4**.

- 1 SOURCE POWER**  
Turns the cable converter power on and off.
- 2 0 – 9**  
Press a button (or buttons) that corresponds to the channel that you wish to watch.
- 3 FLASHBACK \***  
Press to switch between the current channel and the channel you were watching immediately before.
- 4 CH ▲/▼**  
Press **CH ▲** or **CH ▼** to tune in a higher or lower channel.

\* Some manufacturers do not preset **FLASHBACK**.

#### NOTE

- CABLE and SAT cannot be selected at the same time.

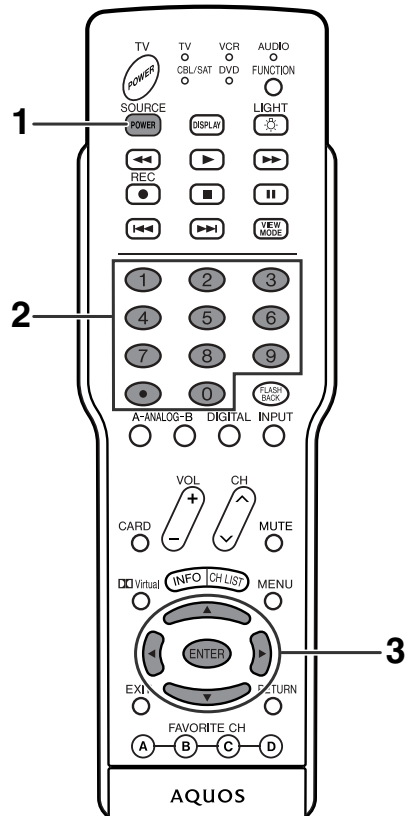

### SAT control buttons

- 1 SOURCE POWER**  
Turns the Satellite broadcast tuner power on and off.
- 2 0 – 9, • (DOT)**  
Press a button (or buttons) that corresponds to the channel that you wish to watch.
- 3 ENTER, ▲/▼/◀/▶**  
ENTER: Press to activate the selected function.  
▲/▼/◀/▶: Press the button to select items on the SAT GUIDE screen or SAT MENU screen.

#### NOTE

- CABLE and SAT cannot be selected at the same time.

## Other viewing options

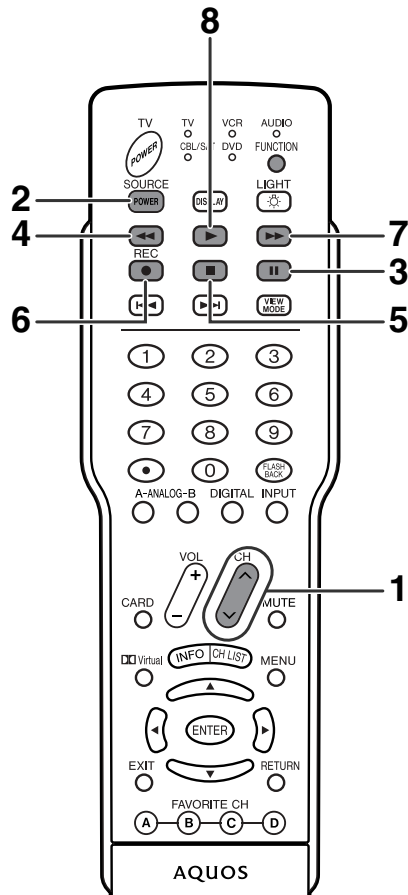

### VCR control buttons

The remote control unit button will function as follows when the **FUNCTION** of the remote control unit is set to VCR.

- When the input selector button having the same number as the input terminal connecting the VCR is pressed, the VCR can operate using **1** to **8**.

- CH ▲/▼**  
Press to select the channel of the TV tuner on the VCR.
- SOURCE POWER**  
Turns the power of the VCR on and off.
- II**  
Sets pauses and still pictures.
- ◀◀**  
Rewinds the tape and allows picture search.
- Stops the tape transport.
- REC**  
Starts recording.
- ▶▶**  
Rapidly advances the tape and allows picture search.
- ▶**  
Starts playback.

## Other viewing options

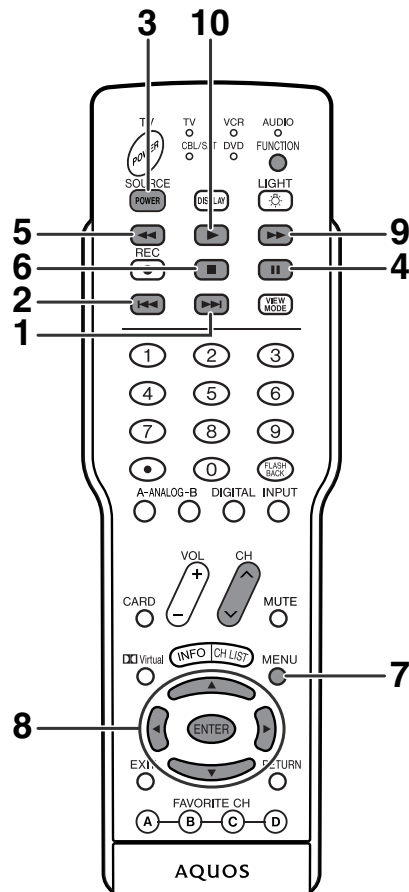

## DVD control buttons

The remote control unit button will function as follows when the **FUNCTION** of the remote control unit is set to DVD.

- When the input selector button having the same number as the input terminal connecting a DVD player is pressed, these players can operate using **1 to 10**.

- ▶▶**  
Pressing quickly once takes you to the start of the next chapter. Each time you press it, you move ahead to the start of the next chapter.
- ◀◀**  
Pressing quickly once takes you to the start of the chapter currently playing. Each time you press it, you move back to the start of the previous chapter.
- SOURCE POWER**  
Turns the power of the DVD player on and off.
- ||**  
Sets pauses and still pictures.
- ◀◀**  
Continue pressing to go backward.
- Playback stops when pressing once. With some DVD players, pressing the button twice may open the disc tray.
- MENU**  
When this button is pressed, the DVD menu will display.
- ENTER, ▲/▼/◀▶**  
ENTER: Press to activate the selected function.  
▲/▼/◀▶: Press the button to select items on the DVD MENU screen.
- ▶▶**  
Continue pressing for fast forward.
- ▶**  
Starts playback.

# Appendix

## Troubleshooting

Problem	Possible Solution
<ul style="list-style-type: none"> <li>No power</li> </ul>	<ul style="list-style-type: none"> <li>Check if you pressed <b>TV POWER</b> on the remote control unit. (See page 20.) If the indicator on the Display lights up red, press <b>TV POWER</b> on the remote control unit.</li> <li>Is the AC cord disconnected? (See page 10.)</li> <li>Has the main power been turned on? (See page 20.)</li> </ul>
<ul style="list-style-type: none"> <li>Unit cannot be operated.</li> </ul>	<ul style="list-style-type: none"> <li>External influences such as lightning, static electricity, may cause improper operation. In this case, operate the unit after first turning on the power of the Display or unplugging the AC cord and replugging it in after 1 or 2 minutes.</li> </ul>
<ul style="list-style-type: none"> <li>Remote control unit does not operate.</li> </ul>	<ul style="list-style-type: none"> <li>Is the <b>FUNCTION</b> set correctly? Set it to the TV setting position.</li> <li>Are batteries inserted with polarity (+, -) aligned? (See page 13.)</li> <li>Are batteries worn out? (Replace with new batteries.)</li> <li>Are you using it under strong or fluorescent lighting?</li> <li>Is a fluorescent light illuminated near the remote control sensor?</li> </ul>
<ul style="list-style-type: none"> <li>Picture is cut off/with sidebar screen.</li> </ul>	<ul style="list-style-type: none"> <li>Is the image position correct? (See page 62.)</li> <li>Are screen mode adjustments such as picture size made correctly? (See pages 68 and 69)</li> </ul>
<ul style="list-style-type: none"> <li>When playing back video in card mode, a part of the image is missing or the image is out of position.</li> </ul>	<ul style="list-style-type: none"> <li>The video playback setting has been affected as a result of moving the image position when playing back a still image in card mode. It is recommended not to move the image position when playing back images from a card.</li> </ul>
<ul style="list-style-type: none"> <li>Strange color, light color, or color misalignment</li> </ul>	<ul style="list-style-type: none"> <li>Adjust the picture tone. (See pages 31 to 34.)</li> <li>Is the room too bright? The picture may look dark in a room that is too bright.</li> <li>Check the input signal setting. (See page 66.)</li> </ul>
<ul style="list-style-type: none"> <li>Power is suddenly turned off.</li> </ul>	<ul style="list-style-type: none"> <li>Is the sleep timer set? (See page 71.)</li> <li>Check the power control settings. (See page 36.)</li> <li>The unit's internal temperature has increased. Remove any objects blocking vent or clean the vent.</li> </ul>
<ul style="list-style-type: none"> <li>No picture</li> </ul>	<ul style="list-style-type: none"> <li>Is connection to other components correct? (See pages 51 to 57.)</li> <li>Is correct input signal source selected after connection? (See page 66.)</li> <li>Is the correct input selected? (See page 66.)</li> <li>Is a non-compatible signal being input? (See page 93.)</li> <li>Is picture adjustment correct? (See pages 31 to 34.)</li> <li>Is "On" selected in "Audio Only"? (See page 70.)</li> </ul>
<ul style="list-style-type: none"> <li>No sound</li> </ul>	<ul style="list-style-type: none"> <li>Is the volume too low? (See page 23.)</li> <li>Is "Variable" selected in "Output Select"? (See page 71.)</li> <li>Is "On" selected in "Center Channel Input"? (See page 84.)</li> </ul>
<ul style="list-style-type: none"> <li>The upgrade screen will continue to be displayed indefinitely. Alternatively, it may appear and disappear repeatedly.</li> </ul>	<ul style="list-style-type: none"> <li>Is the cable antenna connected? Remove the CableCARD, reconnect the Antenna correctly, and then reinsert the CableCARD. If the problem is still not resolved, contact your cable company.</li> </ul>

### Cautions regarding use in high and low temperature environments

- When the unit is used in a low temperature space (e.g. room, office), the picture may leave trails or appear slightly delayed. This is not a malfunction, and the unit will recover when the temperature returns to normal.
- Do not leave the unit in a hot or cold location. Also, do not leave the unit in a location exposed to direct sunlight or near a heater, as this may cause the cabinet to deform and the Liquid Crystal panel to malfunction.  
Storage temperature: -4°F to +140°F (-20°C to +60°C)

## Appendix

### PC compatibility chart

PC/MAC	Resolution		Horizontal Frequency	Vertical Frequency	VESA Standard
PC	VGA	640 x 400	31.5 kHz	60 Hz	
			37.9 kHz	85 Hz	O
		720 x 400	31.5 kHz	60 Hz	
			37.9 kHz	85 Hz	O
		640 x 480	31.5 kHz	60 Hz	O
			37.9 kHz	72 Hz	O
	37.5 kHz		75 Hz	O	
	43.3 kHz		85 Hz	O	
	WVGA	848 x 480	31.5 kHz	60 Hz	
	SVGA	800 x 600	35.1 kHz	56 Hz	O
			37.9 kHz	60 Hz	O
			48.1 kHz	72 Hz	O
			46.9 kHz	75 Hz	O
			53.7 kHz	85 Hz	O
	XGA	1024 x 768	48.4 kHz	60 Hz	O
			56.5 kHz	70 Hz	O
			60.0 kHz	75 Hz	O
			68.7 kHz	85 Hz	O
WXGA	1280 x 720	45.0 kHz	60 Hz		
	1280 x 768	48.1 kHz	60 Hz		
SXGA	1280 x 1024	64.0 kHz	60 Hz	O	
MAC13"	VGA	640 x 480	34.9 kHz	67 Hz	
MAC16"	SVGA	832 x 624	49.7 kHz	75 Hz	
MAC19"	XGA	1024 x 768	60.2 kHz	75 Hz	

Apple and Macintosh are registered trademarks of Apple Computer, Inc.  
 DDC is a registered trademark of Video Electronics Standards Association.  
 Power Management is a registered trademark of Sun Microsystems, Inc.  
 VGA and XGA are registered trademarks of International Business Machines Co., Inc.

## Appendix

### RS-232C port specifications

#### PC Control of the System

- When a program is set, the Display can be controlled from the PC using the RS-232C terminal.  
The input signal (PC/AV) can be selected, the volume can be adjusted and various other adjustments and settings can be made, enabling automatic programmed playing.
- Attach an RS-232C cable cross-type (commercially available) to the supplied Din/D-Sub RS-232C for the connections.

#### NOTE

- This operation system should be used by a person who is accustomed to using computers.

#### Communication conditions

Set the RS-232C communications settings on the PC to match the display's communications conditions. The Display's communications settings are as follows:

<b>Baud rate:</b>	9,600 bps
<b>Data length:</b>	8 bits
<b>Parity bit:</b>	None
<b>Stop bit:</b>	1 bit
<b>Flow control:</b>	None

#### Communication procedure

Send the control commands from the PC via the RS-232C connector. The display operates according to the received command and sends a response message to the PC. Do not send multiple commands at the same time. Wait until the PC receives the OK response before sending the next command.

#### Command format

Eight ASCII codes + CR



#### Parameter

Input the parameter values, aligning left, and fill with blank(s) for the remainder. (Be sure that 4 values are input for the parameter.)

When the input parameter is not within an adjustable range, "ERR" returns. (Refer to "Response code format".)  
Any numerical value can replace the "x" on the table.

0			
0	0	0	9
-	3	0	
1	0	0	
0	0	5	5

When "?" is input for some commands, the present setting value responds.

?			
?	?	?	?

# Appendix

## Response code format

Normal response



Return code (ODH)

Problem response (communication error or incorrect command)



Return code (ODH)

## Command table

- Commands not indicated here are not guaranteed to operate.

CONTROL ITEM	COMMAND	PARAMETER	CONTROL CONTENTS
POWER SETTING	P : O : W : R	0 - - - -	It shifts to standby.
INPUT SELECTION A	TOGGLE	T : T : G : D	(Toggle)
	TV	T : T : V : D	It input-switches to TV. (A channel remains as it is. (Last memory))
	INPUT1-5	I : A : V : D	Input terminal number (1-5)
	i.LINK	L : I : N : K	It input-switches to i.LINK.
	CARD	C : A : R : D	It shifts to CARD mode.
INPUT SELECTION B	INPUT 1	I : N : P : 1	0 - - - - AUTO
		1 - - - -	VIDEO
		2 - - - -	COMPONENT
	INPUT 2	I : N : P : 2	0 - - - - AUTO
		1 - - - -	VIDEO
		2 - - - -	COMPONENT
	INPUT 5	I : N : P : 5	5 - - - - DIGITAL PC
		6 - - - -	ANALOG PC
		7 - - - -	DIGITAL AV
		8 - - - -	ANALOG AV
AV MODE SELECTION	A : V : M : D	0 - - - -	(Toggle)
		1 - - - -	STANDARD
		2 - - - -	MOVIE
		3 - - - -	GAME
		4 - - - -	USER
		5 - - - -	DYNAMIC (Fixed)
		6 - - - -	DYNAMIC
VOLUME	V : O : L : M	* * * * -	Volume (0-60)
		H : P : O : S	AV mode. (± 10)
POSITION	H-POSITION	* * * * -	INPUT5: AV mode. (± 90)
		* * * * -	PC mode. (0-180)
		* * * * -	AV mode. (± 20)
	V-POSITION	* * * * -	INPUT5: AV mode. (± 50)
		* * * * -	PC mode. (0-100)
		* * * * -	Only PC mode. (0-180)
CLOCK	C : L : C : K	* * * * -	Only PC mode. (0-180)
PHASE	P : H : S : E	* * * * -	Only PC mode. (0-40)
VIEWMODE	W : I : D : E	0 - - - -	(Toggle) [AV]
		1 - - - -	Side Bar [AV]
		2 - - - -	S.Stretch [AV]
		3 - - - -	Zoom [AV]
		4 - - - -	Stretch [AV]
		5 - - - -	Normal [PC]
		6 - - - -	Zoom [PC]
		7 - - - -	Stretch [PC]
		8 - - - -	Dot by Dot [PC]
MUTE	M : U : T : E	0 - - - -	(Toggle)
		1 - - - -	On
		2 - - - -	Off
Dolby Virtual	A : C : D : V	0 - - - -	(Toggle)
		1 - - - -	On
		2 - - - -	Off
AUDIO SELECTION	A : C : H : A	x - - - -	(Toggle)
SLEEP TIMER	O : F : T : M	0 - - - -	OFF
		1 - - - -	OFF TIMER - 30 MIN.
		2 - - - -	OFF TIMER - 60 MIN.
		3 - - - -	OFF TIMER - 90 MIN.
		4 - - - -	OFF TIMER - 120 MIN.
CHANNEL	DIRECT CHANNEL (ANALOG)	D : C : C : H	* * * * - The channel number of TV (1-125)
		D : A : 2 : 0	* * * * - DA2P
		D : C : 2 : 0	* * * * - DA2U
		D : C : 2 : 1	* * * * - DA2L
		D : C : 1 : 0	* * * * - DIGITAL Cable (Two-Part numbers, 3-digit plus 3-digit)
		D : C : 1 : 1	* * * * - DIGITAL Cable (Two-Part numbers, 3-digit plus 3-digit)
	CH UP	C : H : U : P	x - - - - The channel number of TV + 1
CH DOWN	C : H : D : W	x - - - - The channel number of TV - 1	
ANTENA SELECT	A : N : T : S	0 - - - -	(Toggle)
		1 - - - -	ANALOG-A
		2 - - - -	ANALOG-B
		3 - - - -	DIGITAL
CC	C : L : C : P	x - - - -	(Toggle)
			Toggle operation of a closed caption.

### NOTE

- If an underbar ( \_ ) appears in the parameter column, enter a space.
- If an asterisk ( \* ) appears, enter a value in the range indicated in brackets under CONTROL CONTENTS.
- As long as that from which the parameter ( x ) in the table is a numerical value, it may write anything.



## Appendix

### Specifications

Item		Model: LC-37GD4U	Model: LC-32GD4U	Model: LC-26GD4U
LCD panel		37" Advanced Super View & BLACK TFT LCD	32" Advanced Super View & BLACK TFT LCD	26" Advanced Super View & BLACK TFT LCD
Number of dots		3,147,264 dots (1366 × 768 × 3 dots)		
TV Function	TV-standard (CCIR)	American TV Standard ATSC/NTSC System		
	Receiving Channel	VHF/UHF	VHF 2-13ch, UHF 14-69ch	
		CATV	1-125ch	
		Digital Terrestrial Broadcast (8VSB)	2-69ch	
		Digital cable (64/256 QAM)	1-135ch	
Audio multiplex	BTSC System			
Brightness		450 cd/m <sup>2</sup>		
Backlight		60,000 hours (at Backlight Standard position)		
Viewing angles		H : 170° V : 170°		
Audio amplifier		10W × 2		
Speakers		Ø 8cm 2pcs, Ø 2.5cm 2pcs		
Terminals	Rear	INPUT 1	AV in, COMPONENT in	
		INPUT 2	AV in, COMPONENT in	
		INPUT 3	S-VIDEO in, AV in	
		INPUT 4	HDMI in (Type-A) with HDCP	
		INPUT 5	Audio in, DVI-I in with HDCP	
		ANALOG ANTENNA	75 Ω Unbalance, F Type for VHF/UHF/CATV in × 2, out × 1	
		DIGITAL ANTENNA	75 Ω –for Digital Air/Cable in × 1	
		MONITOR OUTPUT	S-VIDEO out, AV out	
		EXTERNAL SPEAKER	4 Ω 10W (L/R)	
		CENTER CHANNEL INPUT	RCA pin	
		DIGITAL AUDIO OUTPUT	Optical Digital audio output × 1 (PCM/Dolby Digital)	
		i.LINK	IEEE1394 × 2 with DTCP	
		PC CARD slot	68 pin PCMCIA × 1	
		Cable CARD slot	68 pin PCMCIA × 1	
		DC OUTPUT	DC 9 V 7 W MAX	
	Front	Headphones	Ø 3.5mm jack	
OSD language		English/French/Spanish		
Power Requirement		AC 120 V, 60 Hz		
Power Consumption		224 W (0.2 W Standby with AC 120 V)	182 W (0.2 W Standby with AC 120 V)	150 W (0.2 W Standby with AC 120 V)
Weight	LC-37GD4U	40.8 lbs./18.5 kg (Display only), 51.6 lbs./23.4 kg (with Display and speaker), 60.8 lbs./27.6 kg (with Display, speaker and standby)		
	LC-32GD4U	36.4 lbs./16.5 kg (Display only), 46.1 lbs./20.9 kg (with Display and speaker), 55.3 lbs./25.1 kg (with Display, speaker and standby)		
	LC-26GD4U	XX.X lbs./XX.X kg (Display only), XX.X lbs./XX.X kg (with Display and speaker), XX.X lbs./XX.X kg (with Display, speaker and standby)		
Accessories		Operation manual (× 1), Remote control unit (× 1), AC cord (× 1), "AAA" size battery (× 2), Cable clamp (× 1), RF cable (× 1), Speaker unit (× 1), Bracket unit (× 1) (only for LC-37GD4U/LC-32GD4U)		

- As part of policy of continuous improvement, SHARP reserves the right to make design and specification changes for product improvement without prior notice. The performance specification figures indicated are nominal values of production units. There may be some deviations from these values in individual units.

### Optional accessory for LC-37GD4U/LC-32GD4U

The listed optional accessory is available for the Liquid Crystal Television. Please purchase it at your nearest shop.

- Additional optional accessories may be available in the near future. When purchasing, please read the newest catalogue for compatibility and check the availability.

No.	Part name	Part number
1	Wall mount bracket	AN-37AG2

# Dimensional drawings

Display LC-37GD4U

Unit: inch/(mm)

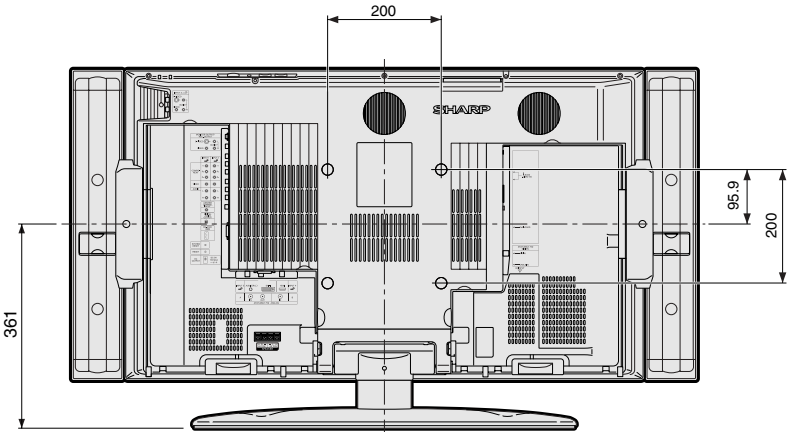
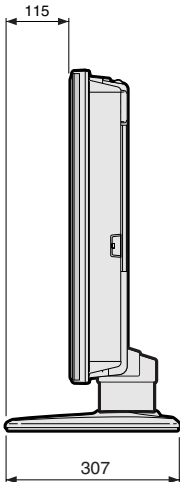
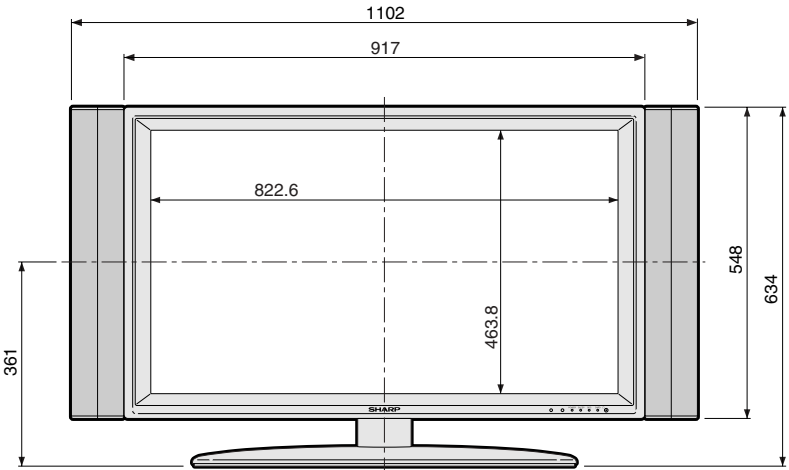
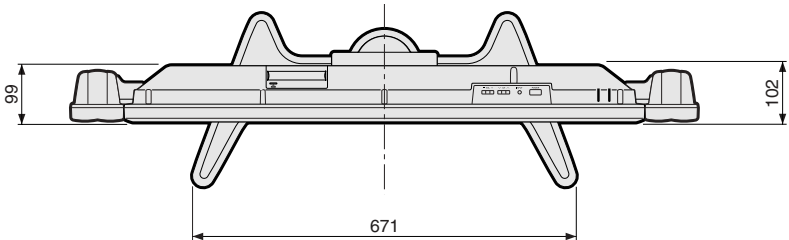

# Dimensional drawings

**Display** LC-32GD4U

Unit: inch/(mm)

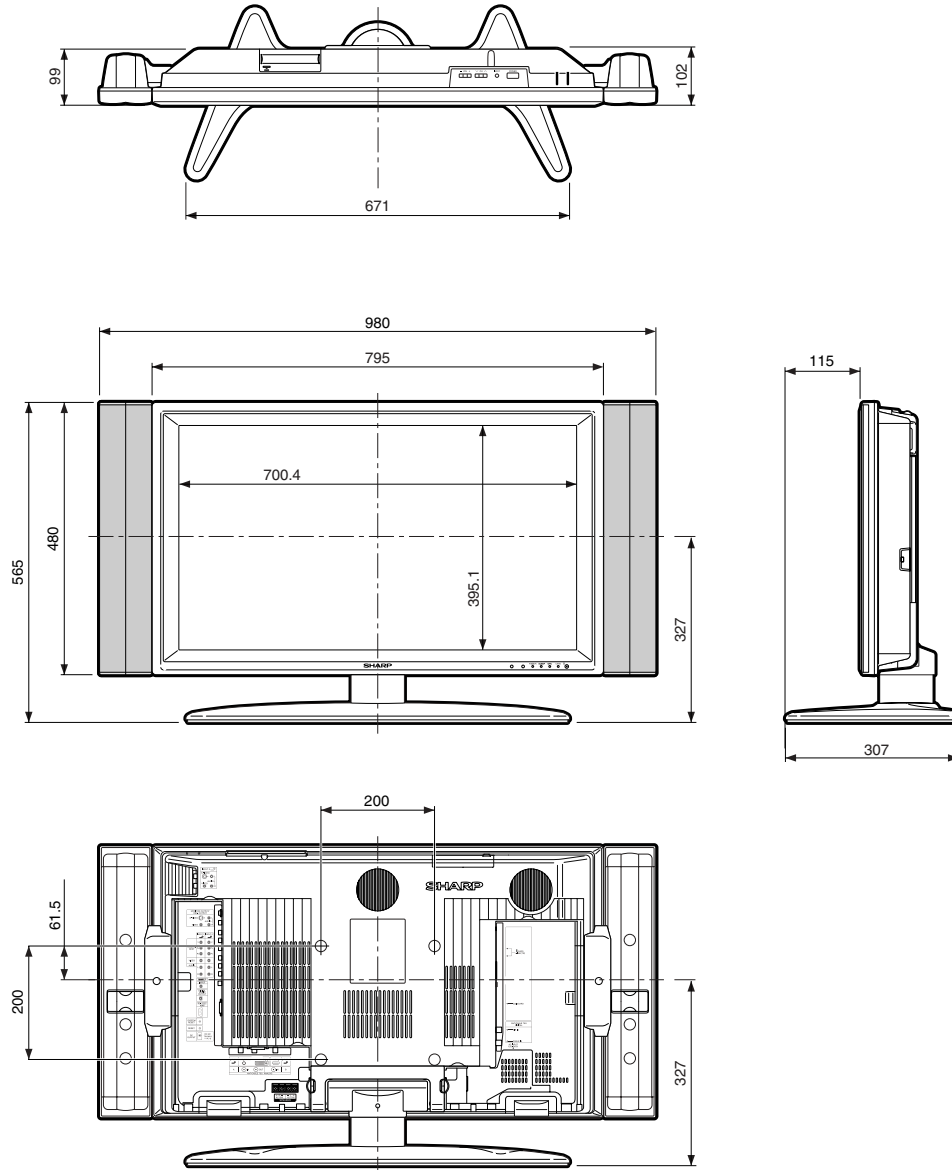

# Dimensional drawings

**Display** LC-26GD4U

Unit: inch/(mm)

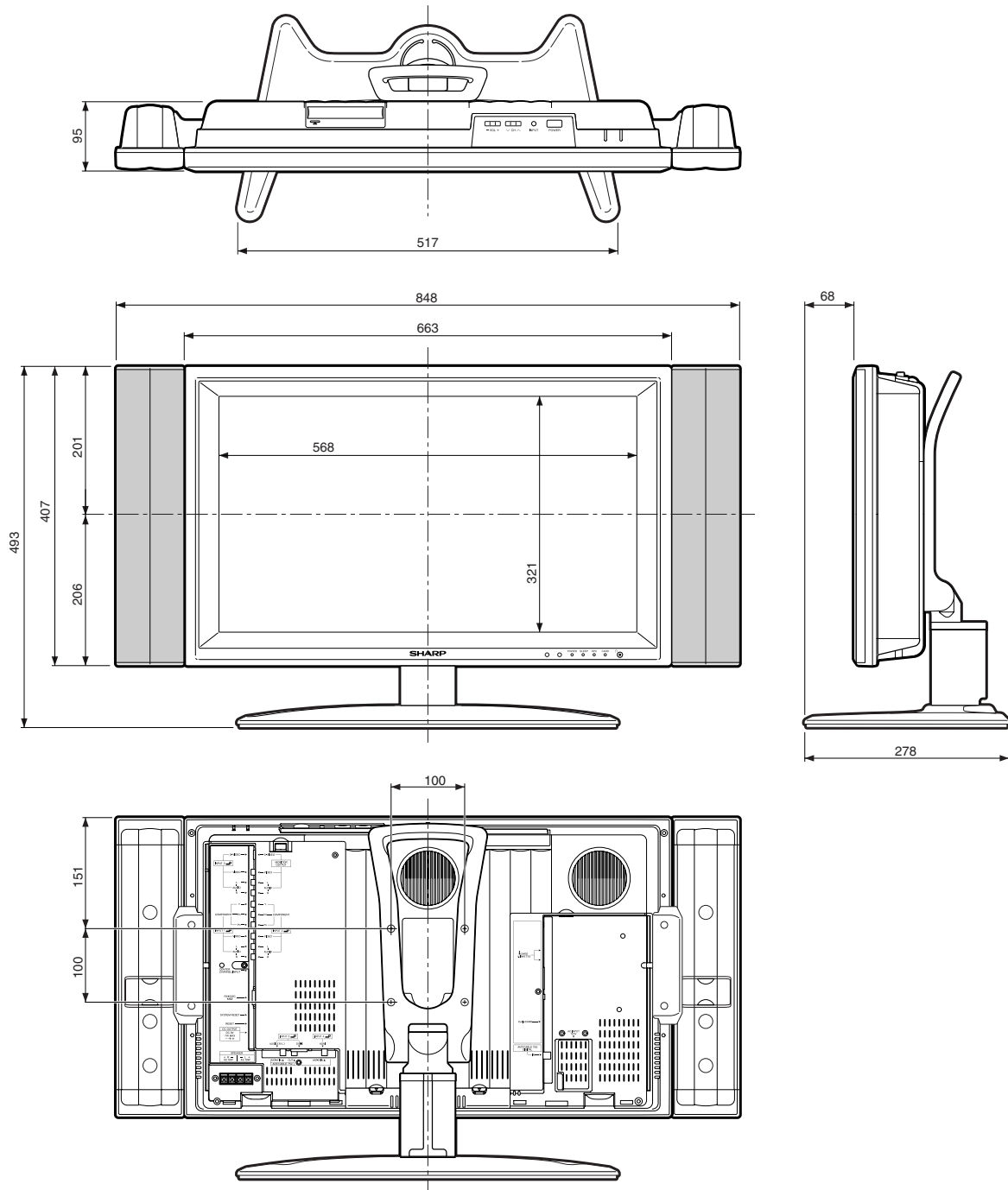

## HOW TO SET THE FACTORY PRESETS

Turn off the Display by pressing **POWER**.

Press and hold down **RESET** and press **POWER** on the Display to turn on the TV.

All setting items (except TV channel) return to the factory presetting.

### NOTE

- Running the factory presetting operation also clears the secret number.

You can run the EZ Setup again by using the following steps.

- 1** Turn on the power of the Display.
- 2** Press **MENU**. (Make sure the menu screen displays.)
- 3** Press ◀▶ to select "Setup".
- 4** Press ▲/▼ to select "EZ Setup".
- 5** Press **ENTER**.

### NOTE

- If the secret number setting screen displays, you need to enter your secret number.
- If you forget your secret number, refer to HOW TO SET THE FACTORY PRESETS above.

The secret number is

--	--	--	--

.

### NOTE

- As a precautionary measure, make a note of your secret number above, scissor it from this manual, and keep it in a familiar place.



# Calling for Service

For location of the nearest Sharp Authorized Service, or to obtain product literature, accessories, supplies, or customer assistance, please call 1-800-BE-SHARP.

## LIMITED WARRANTY

### CONSUMER LIMITED WARRANTY

SHARP ELECTRONICS CORPORATION warrants to the first consumer purchaser that this Sharp brand product (the "Product"), when shipped in its original container, will be free from defective workmanship and materials, and agrees that it will, at its option, either repair the defect or replace the defective Product or part thereof with a new or remanufactured equivalent at no charge to the purchaser for parts or labor for the period(s) set forth below.

This warranty does not apply to any appearance items of the Product nor to the additional excluded item(s) set forth below nor to any Product the exterior of which has been damaged or defaced, which has been subjected to improper voltage or other misuse, abnormal service or handling, or which has been altered or modified in design or construction.

In order to enforce the rights under this limited warranty, the purchaser should follow the steps set forth below and provide proof of purchase to the servicer.

The limited warranty described herein is in addition to whatever implied warranties may be granted to purchasers by law. ALL IMPLIED WARRANTIES INCLUDING THE WARRANTIES OF MERCHANTABILITY AND FITNESS FOR USE ARE LIMITED TO THE PERIOD(S) FROM THE DATE OF PURCHASE SET FORTH BELOW. Some states do not allow limitations on how long an implied warranty lasts, so the above limitation may not apply to you.

Neither the sales personnel of the seller nor any other person is authorized to make any warranties other than those described herein, or to extend the duration of any warranties beyond the time period described herein on behalf of Sharp.

The warranties described herein shall be the sole and exclusive warranties granted by Sharp and shall be the sole and exclusive remedy available to the purchaser. Correction of defects, in the manner and for the period of time described herein, shall constitute complete fulfillment of all liabilities and responsibilities of Sharp to the purchaser with respect to the Product, and shall constitute full satisfaction of all claims, whether based on contract, negligence, strict liability or otherwise. In no event shall Sharp be liable, or in any way responsible, for any damages or defects in the Product which were caused by repairs or attempted repairs performed by anyone other than an authorized servicer. Nor shall Sharp be liable or in any way responsible for any incidental or consequential economic or property damage. Some states do not allow the exclusion of incidental or consequential damages, so the above exclusion may not apply to you.

THIS WARRANTY GIVES YOU SPECIFIC LEGAL RIGHTS. YOU MAY ALSO HAVE OTHER RIGHTS WHICH VARY FROM STATE TO STATE.

### Model Specific Section

<b>Your Product Model Number &amp; Description:</b>	LC-37GD4U • LC-32GD4U • LC-26GD4U LCD Color Television (Be sure to have this information available when you need service for your Product.)
<b>Warranty Period for this Product:</b>	One (1) year parts and labor from the date of purchase.
<b>Additional Item(s) Excluded from Warranty Coverage (if any):</b>	Non-rechargeable batteries.
<b>Where to Obtain Service:</b>	From a Sharp Authorized Servicer located in the United States. To find the location of the nearest Sharp Authorized Servicer, call Sharp toll free at 1-800-BE-SHARP.
<b>What to do to Obtain Service: LC37GD4U/LC-32GD4U</b>	Contact your Sharp Authorized Servicer to obtain in-home service for this Product. The Servicer will come to your home and if it is necessary to remove the Product, the Servicer will reinstall it. Be sure to have <b>Proof of Purchase</b> available.
<b>LC-26GD4U</b>	Ship prepaid or carry in your Product to a Sharp Authorized Servicer. Be sure to have <b>Proof of Purchase</b> available. If you ship the Product, be sure it is insured and packaged securely.

TO OBTAIN PRODUCT INFORMATION, CALL 1-800-BE-SHARP OR VISIT [www.sharpusa.com](http://www.sharpusa.com)

# SHARP®

## SHARP ELECTRONICS CORPORATION

Sharp Plaza, Mahwah, New Jersey 07430-2135

### SHARP CORPORATION

# SHARP®

## LIMITED WARRANTY

### *Consumer Electronics Products*

## **Congratulations on your purchase!**

Sharp Electronics of Canada Ltd. (hereinafter called "Sharp") gives the following express warranty to the first consumer purchaser for this Sharp brand product, when shipped in its original container and sold or distributed in Canada by Sharp or by an Authorized Sharp Dealer:

Sharp warrants that this product is free, under normal use and maintenance, from any defects in material and workmanship. If any such defects should be found in this product within the applicable warranty period, Sharp shall, at its option, repair or replace the product as specified herein.

This warranty shall not apply to:

- (a) Any defects caused or repairs required as a result of abusive operation, negligence, accident, improper installation or inappropriate use as outlined in the owner's manual.
- (b) Any Sharp product tampered with, modified, adjusted or repaired by any party other than Sharp, Sharp's Authorized Service Centres or Sharp's Authorized Servicing Dealers.
- (c) Damage caused or repairs required as a result of the use with items not specified or approved by Sharp, including but not limited to head cleaning tapes and chemical cleaning agents.
- (d) Any replacement of accessories, glassware, consumable or peripheral items required through normal use of the product including but not limited to earphones, remote controls, AC adapters, batteries, temperature probe, stylus, trays, filters, belts, ribbons, cables and paper.
- (e) Any cosmetic damage to the surface or exterior that has been defaced or caused by normal wear and tear.
- (f) Any damage caused by external or environmental conditions, including but not limited to transmission line/power line voltage or liquid spillage.
- (g) Any product received without appropriate model, serial number and CSA/cUL markings.
- (h) Any products used for rental or commercial purposes.
- (i) Any installation, setup and/or programming charges.

Should this Sharp product fail to operate during the warranty period, warranty service may be obtained upon delivery of the Sharp product together with proof of purchase and a copy of this LIMITED WARRANTY statement to an Authorized Sharp Service Centre or an Authorized Sharp Servicing Dealer. In home warranty service may be provided at Sharp's discretion on any Sharp television with the screen size of 27" or larger and on any Sharp Over-the-Range Microwave Oven.

This warranty constitutes the entire express warranty granted by Sharp and no other dealer, service centre or their agent or employee is authorized to extend, enlarge or transfer this warranty on behalf of Sharp. To the extent the law permits, Sharp disclaims any and all liability for direct or indirect damages or losses or for any incidental, special or consequential damages or loss of profits resulting from a defect in material or workmanship relating to the product, including damages for the loss of time or use of this Sharp product or the loss of information. The purchaser will be responsible for any removal, reinstallation, transportation and insurance costs incurred. Correction of defects, in the manner and period of time described herein, constitute complete fulfillment of all obligations and responsibilities of Sharp to the purchaser with respect to the product and shall constitute full satisfaction of all claims, whether based on contract, negligence, strict liability or otherwise.

**WARRANTY PERIODS:**

	Parts & Labour (exceptions noted)
Audio Products	1 year
Camcorder	1 year
DVD Products	1 year
Projector	1 year (lamp 90 days)
LCD & Plasma Display TV	1 year
Microwave Oven	1 year (magnetron component-4 additional years)
Television Products	1 year (picture tube component-1 additional year)
VCR Products	1 year
Vacuum Cleaner	1 year

To obtain the name and address of the nearest Authorized Sharp Service Centre or Dealer, please contact:  
SHARP ELECTRONICS OF CANADA LTD. 335 Britannia Road East, Mississauga, Ontario L4Z 1W9

For more information on this Warranty, Sharp Extended Warranty Offers, Sharp Canada Products, Accessory Sales, Dealer or Service Locations, please call (905) 568-7140  
Visit our Web site: [www.sharp.ca](http://www.sharp.ca)

